

# TEST REPORT

**Report Number: 102576886MPK-002**

**Project Number: G102576886**

**May 27, 2016**

**Testing performed on the  
PCBA, VMC GPS+Iridium Module  
Model Number: IGM9603N**

**FCC ID: 2AHZH-IGM9603N**

**To**

**FCC Part 25  
RSS-170 Issue 3, July 2015**

**for**

**Liquid Robotics Inc.**

**Test Performed by:**

Intertek  
1365 Adams Court  
Menlo Park, CA 94025

**Test Authorized by:**

Liquid Robotics Inc.  
1329 Moffett Park Drive  
Sunnyvale, CA 94089, USA

**Prepared by:**



Anderson Soungpanya

**Date:**

May 27, 2016

**Reviewed by:**



Krishna K Vemuri

**Date:**

May 27, 2016

*This report is for the exclusive use of Intertek's Client and is provided pursuant to the agreement between Intertek and its Client. Intertek's responsibility and liability are limited to the terms and conditions of the agreement. Intertek assumes no liability to any party, other than to the Client in accordance with the agreement, for any loss, expense or damage occasioned by the use of this report. Only the Client is authorized to copy or distribute this report and then only in its entirety. Any use of the Intertek name or one of its marks for the sale or advertisement of the tested material, product or service must first be approved in writing by Intertek. The observations and test results in this report are relevant only to the sample tested. This report by itself does not imply that the material, product, or service is or has ever been under an Intertek certification program. This report must not be used to claim product endorsement by A2LA, NIST nor any other agency of the U.S. Government.*



## Report No. 102576886MPK-002

**Equipment Under Test:** PCBA, VMC GPS+Iridium Module  
**Model No.:** IGM9603N  
**FCC ID:** 2AHZH- IGM9603N  
**Serial No.:** M01MYB

**Applicant:** Liquid Robotics Inc.  
**Contact:** Somphone Sayavong  
**Address:** 484 Oakmead Parkway  
Sunnyvale, CA 94089  
**Country:** USA

**Tel. Number:** (650) 218-6210  
**Email:** somphone.sayavong@liquidr.com

**Applicable Regulation:** FCC Part 25  
RSS-170 Issue 3, July 2015

**Test Site Location:** Intertek  
1365 Adams Drive  
Menlo Park, CA 94025

**Date of Test:** May 4 –27, 2016

*We attest to the accuracy of this report:*

---

Anderson Soungpanya  
EMC Project Engineer

---

Krishna K Vemuri  
Engineering Team Lead



## TABLE OF CONTENTS

<b>1.0</b>	<b>Introduction .....</b>	<b>5</b>
1.1	Product Description.....	5
1.2	Summary of Test Results .....	6
1.3	Test Configuration .....	7
1.3.1	Support Equipment .....	7
1.3.2	Block Diagram of Test Setup.....	7
1.4	Related Submittal(s) Grants .....	7
<b>2.0</b>	<b>RF Power Output.....</b>	<b>8</b>
2.1	Requirement.....	8
2.2	Test Procedure.....	8
2.3	Test Results .....	9
<b>3.0</b>	<b>Modulation Characteristics.....</b>	<b>13</b>
3.1	Requirement .....	13
3.2	Test Procedure.....	13
3.3	Test Results .....	13
<b>4.0</b>	<b>Occupied Bandwidth .....</b>	<b>14</b>
4.1	Test Procedure.....	14
4.2	Test Results .....	14
<b>5.0</b>	<b>Emission Mask .....</b>	<b>18</b>
5.1	Requirement.....	18
5.2	Test Procedure.....	18
5.3	Test Results .....	18
<b>6.0</b>	<b>Spurious Emissions .....</b>	<b>22</b>
6.1	Emissions at Antenna Terminal .....	22
6.1.2	Requirement .....	22
6.1.2	Test Procedure .....	22
6.1.3	Test Results.....	22
6.2	Spurious Radiation .....	25
6.2.1	Test Procedure .....	25
6.2.2	Test Results .....	26
6.2.3	Test Setup Photographs.....	29
<b>7.0</b>	<b>Limits on Emissions from Mobile Earth Stations for Protection of Aeronautical Radio navigation-Satellite Service.....</b>	<b>31</b>
7.1	Requirement.....	31
7.2	Test Procedure.....	31
7.3	Test Results .....	32
<b>8.0</b>	<b>Frequency Stability vs Temperature and Voltage .....</b>	<b>36</b>



8.1	Requirement .....	36
8.2	Test Procedure.....	36
8.3	Test Results .....	37
<b>9.0</b>	<b>List of Test Equipment .....</b>	<b>40</b>
<b>10.0</b>	<b>Document History .....</b>	<b>41</b>



## 1.0 Introduction

### 1.1 Product Description

IGM stands for IRIDIUM, GPS MODULE. This device provides Iridium and GPS services to SV3 Command and Control Unit (CCU).

<b>Radio Specifications</b>	
<b>Applicant</b>	Liquid Robotics Inc.
<b>Model No.</b>	IGM9603N
<b>Use of Product</b>	SV3 command and control unit (CCU)
<b>Rated RF Output Power</b>	4.51W (EIRP)
<b>Frequency Ranges</b>	1616 – 1626 MHz
<b>Type of Modulation</b>	DE-QPSK/DE-BPSK
<b>Channel Bandwidth and Maximum Data Rate</b>	41.667kHz, 24kBp/s
<b>Antenna &amp; Gain</b>	DUAL ANTENNA, GPS AND IRIDIUM, SMA:, P/N: S5GIR1516RR-AP-XSS-1, Gain = +5.0 dBi, 50 Ohms, RHCP
<b>Detachable Antenna</b>	Internal Antenna, Non-Detachable
<b>Manufacture Name &amp; Address</b>	Liquid Robotics Inc. 1329 Moffett Park Drive Sunnyvale, CA 94089

**EUT receive date:** April 29, 2016

**EUT receive condition:** The prototype version of the EUT was received in good condition with no apparent damage. As declared by the Applicant it is identical to the production units.

**Test start date:** May 4, 2016

**Test completion date:** May 27, 2016



## 1.2 Summary of Test Results

<b>FCC Rule</b>	<b>RSS Rule</b>	<b>Description of Test</b>	<b>Result</b>
25.204	RSS 170, 5.3	RF Power Output	Complies
2.1047(d)	-	Modulation Characteristics	Complies
2.1049	RSS Gen, 6.6	Occupied Bandwidth	Complies
2.1053, 25.202(f)	RSS 170; 5.4	Emission Masks	Complies
2.1053, 25.216, 25.202 (f)	RSS 170; 5.4	Out of Band Emissions at Antenna Terminals	Complies
2.1053, 25.216, 25.202 (f)	RSS 170; 5.4	Spurious Radiation	Complies
25.216 (a-j)	RSS 170; 5.4.3, 5.4.4	Limits on Emissions from Mobile Earth Stations for Protection of Aeronautical Radio navigation-Satellite Service	Complies
2.1055, 25.202(d)	RSS 170; 5.2	Frequency Stability vs. Temperature and Voltage	Complies

### 1.3 Test Configuration

#### 1.3.1 Support Equipment

Item #	Description	Manufacturer	Model No.
1	Laptop	Dell	Latitude E6500
2	Power Source	Liquid Robotics	Surfer SV3

#### 1.3.2 Block Diagram of Test Setup

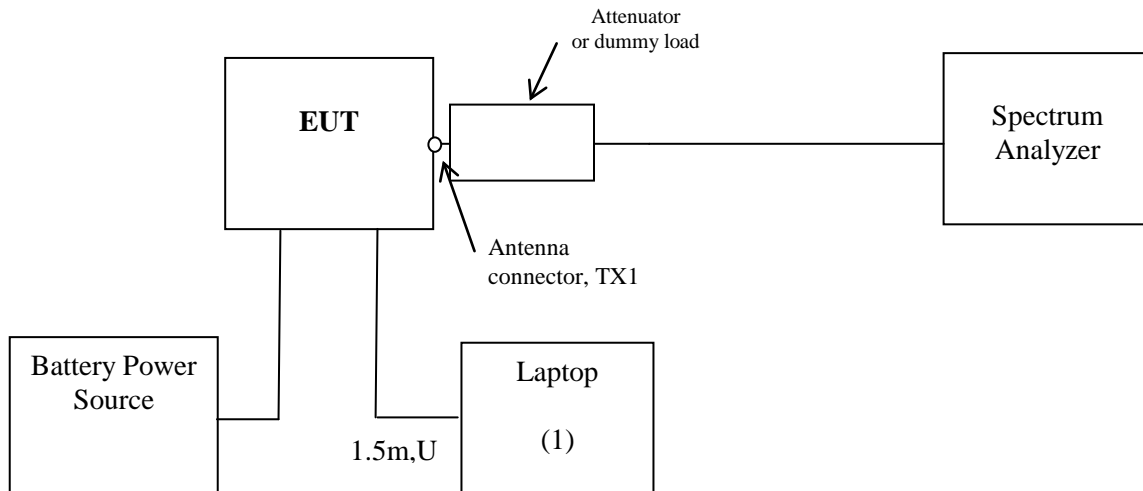

<b>S</b> = Shielded	<b>F</b> = With Ferrite
<b>U</b> = Unshielded	<b>m</b> = Length in Meters

During testing, the EUT was connected to a Laptop through a USB cable. Test software loaded on the computer was adjusted to exercise the EUT.

#### 1.4 Related Submittal(s) Grants

None



## 2.0 RF Power Output

FCC CFR 47 Part 25, Clause 25.204  
Industry Canada RSS-170, Clause 5.3

### 2.1 Requirement

#### Limit Clause FCC CFR 47, 25.204

+40 dBW in any 4 kHz band for  $\theta \leq 0^\circ$   
+40 + 30 dBW in any 4 kHz band for  $0^\circ < \theta \leq 5^\circ$

#### Limit Clause RSS-170, 5.3

The application for MES certification shall state the MES e.i.r.p. that is necessary for satisfactory communication. The maximum permissible e.i.r.p. will be the stated necessary e.i.r.p. plus a 2 dB margin. If a detachable antenna is used, the certification application shall state the recommended antenna type and manufacturer, the antenna gain and the maximum transmitter output power at the antenna terminal.

### 2.2 Test Procedure

The EUT was connected to a spectrum analyzer with a RF cable and 30dB attenuator. The path loss was entered as a reference level offset into the spectrum analyzer.

The test procedure spelled out in 971168 D01 Power Meas License Digital Systems v02r02 was utilized to measure the peak output power.

The EIRP was calculated by adding the antenna gain to the output power in dBm.

$$\text{EIRP} = P_{\text{max}} + G_{\text{dBi}}$$





## 2.3 Test Results

### Conducted Power

<b>Mode</b>	<b>Frequency (MHz)</b>	<b>Measured Output Power (dBm)</b>	<b>Measured Output Power (Watt)</b>	<b>Graph</b>
Low Channel	1616.020833	31.50	1.41	2.1
Mid Channel	1621.020833	31.54	1.43	2.2
High Channel	1625.979167	31.35	1.36	2.3

Refer to the attached graphs.

### EIRP

According to the antenna provided, the antenna gain used with the EUT is 5dBi; therefore, the maximum calculated peak radiated power is:

<b>Mode</b>	<b>Frequency (MHz)</b>	<b>EIRP Output Power (dBm)</b>	<b>EIRP Output Power (Watt)</b>
Low Channel	1616.020833	36.50	4.47
Mid Channel	1621.020833	36.54	4.51
High Channel	1625.979167	36.35	4.32

Graph 2. 1

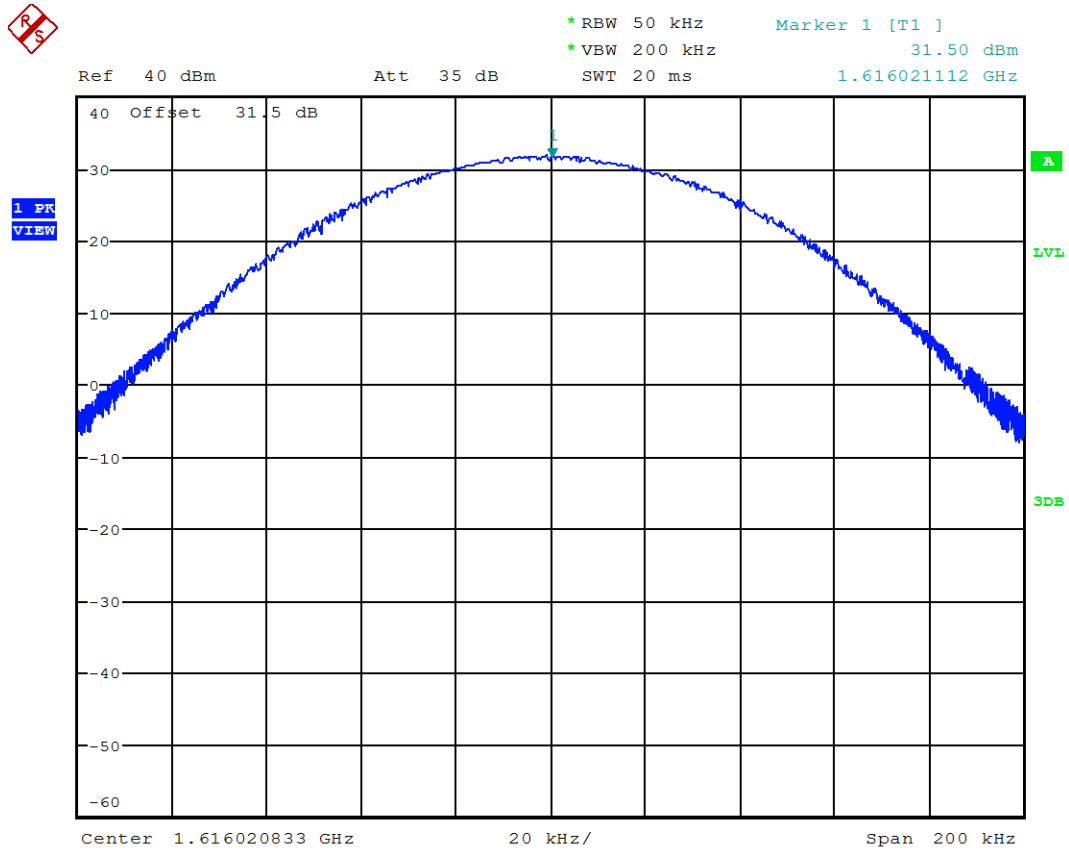

Date: 27.MAY.2016 08:47:19

Graph 2. 2

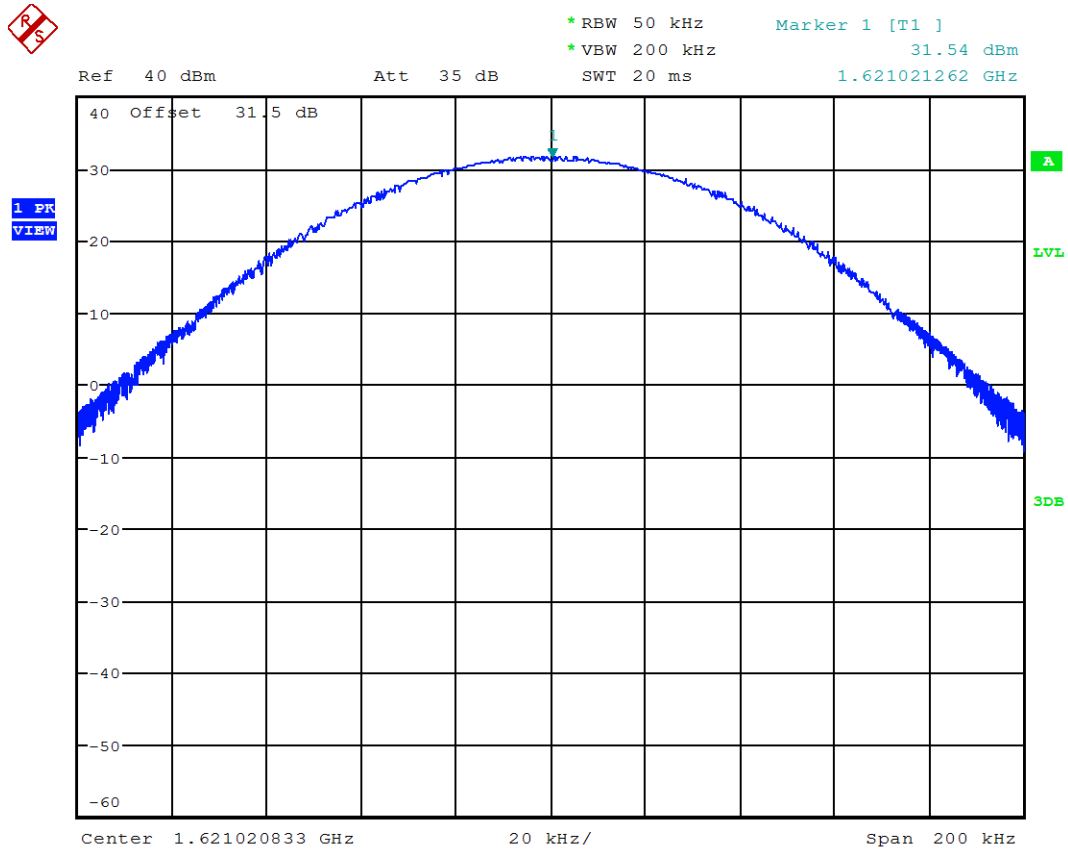

Date: 27.MAY.2016 08:44:58

Graph 2.3

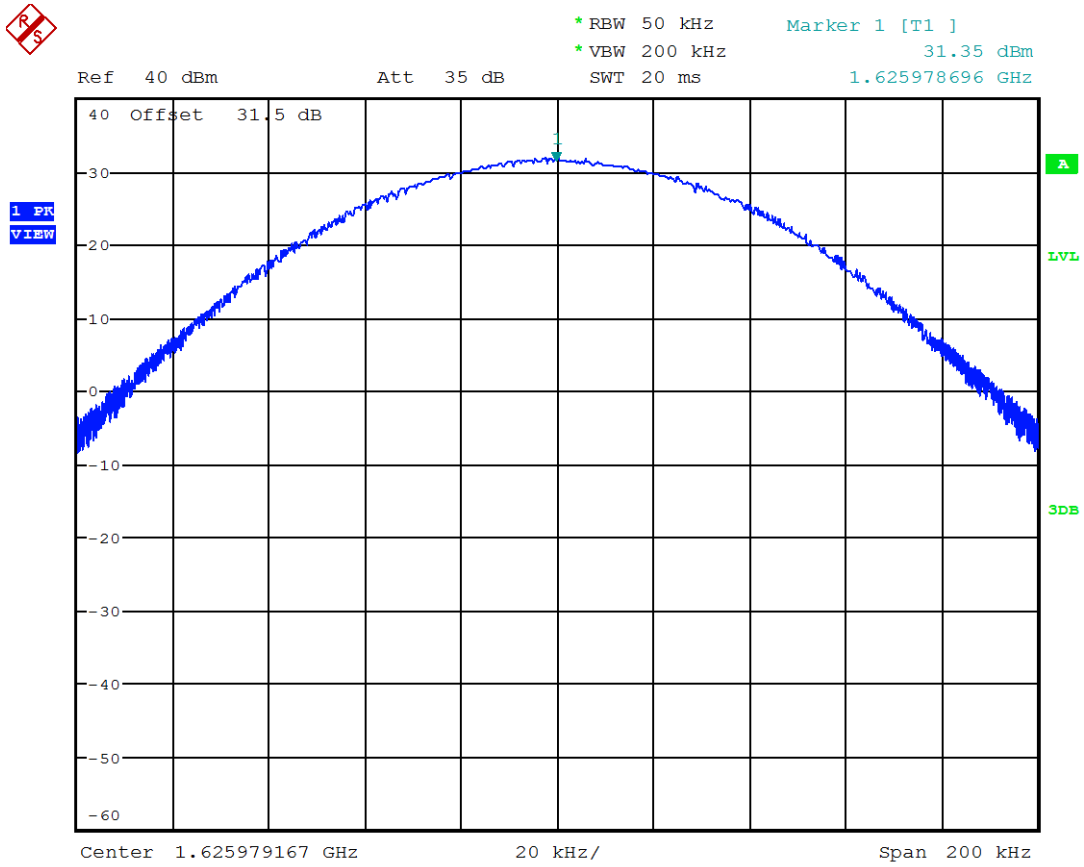

Date: 27.MAY.2016 08:46:16



### **3.0 Modulation Characteristics**

FCC CFR 47 Part 2, Clause 2.1047(d)

#### **3.1 Requirement**

Other types of equipment. A curve or equivalent data which shows that the equipment will meet the modulation requirements of the rules under which the equipment is to be licensed.

#### **3.2 Test Procedure**

The EUT RF output was connected as shown on the diagram in report section 1.3.2. The EUT was setup to transmit the maximum power.

#### **3.3 Test Results**

See plots in Section 4.0.



#### 4.0 Occupied Bandwidth

FCC 2.1049  
RSS Gen – 6.6

##### 4.1 Test Procedure

The EUT RF output was connected as shown on the diagram in report section 1.3.2. The EUT was setup to transmit the maximum power.

The spectrum analyzer was setup to measure the Occupied Bandwidth (defined as the 99% Power Bandwidth). The Occupied Bandwidth was measured for all modes and authorized bandwidths.

##### 4.2 Test Results

Mode	Frequency (MHz)	99% Bandwidth (kHz)	-26dB Bandwidth (kHz)	Graph
Low Channel	1616.020833	32.452	40.384	4.1
Mid Channel	1621.020833	32.452	40.385	4.2
High Channel	1625.979167	32.216	40.385	4.3

Refer to the following Graphs

<b>Result</b>	<b>Complies</b>
---------------	-----------------

Graph 4. 1

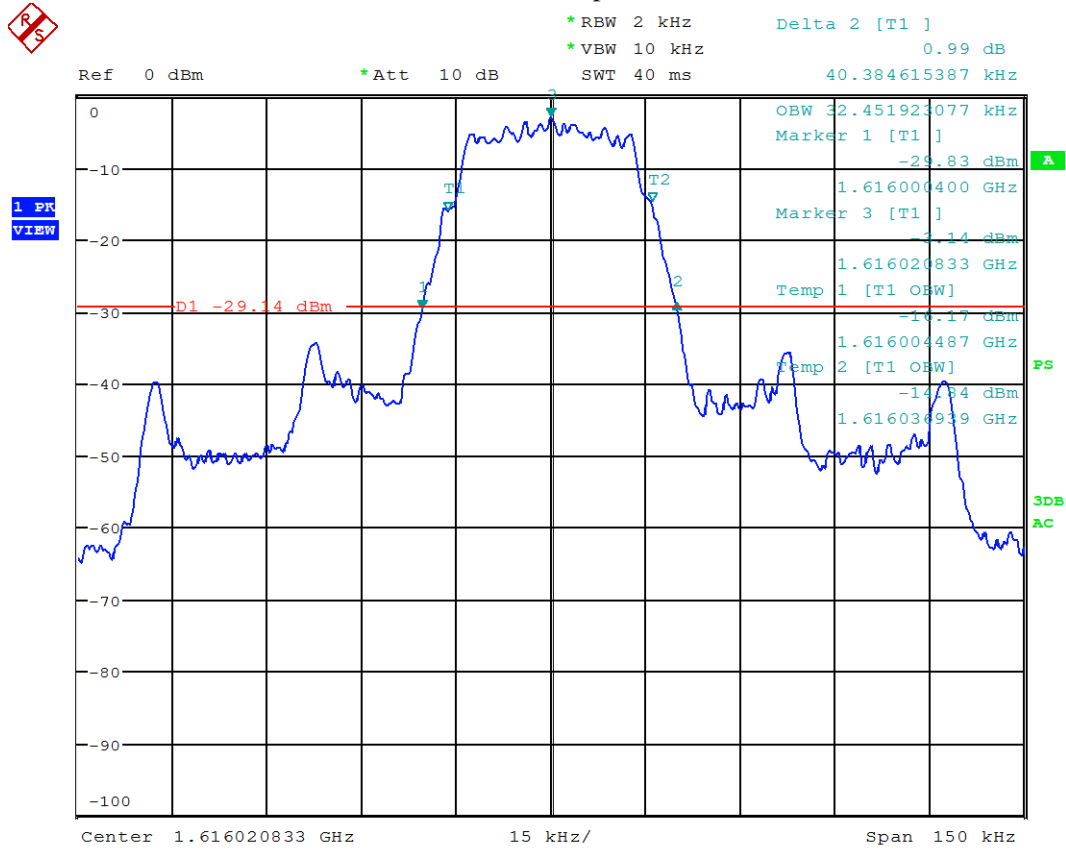

Date: 5.MAY.2016 07:46:16

Graph 4.2



1 PR  
VIEW

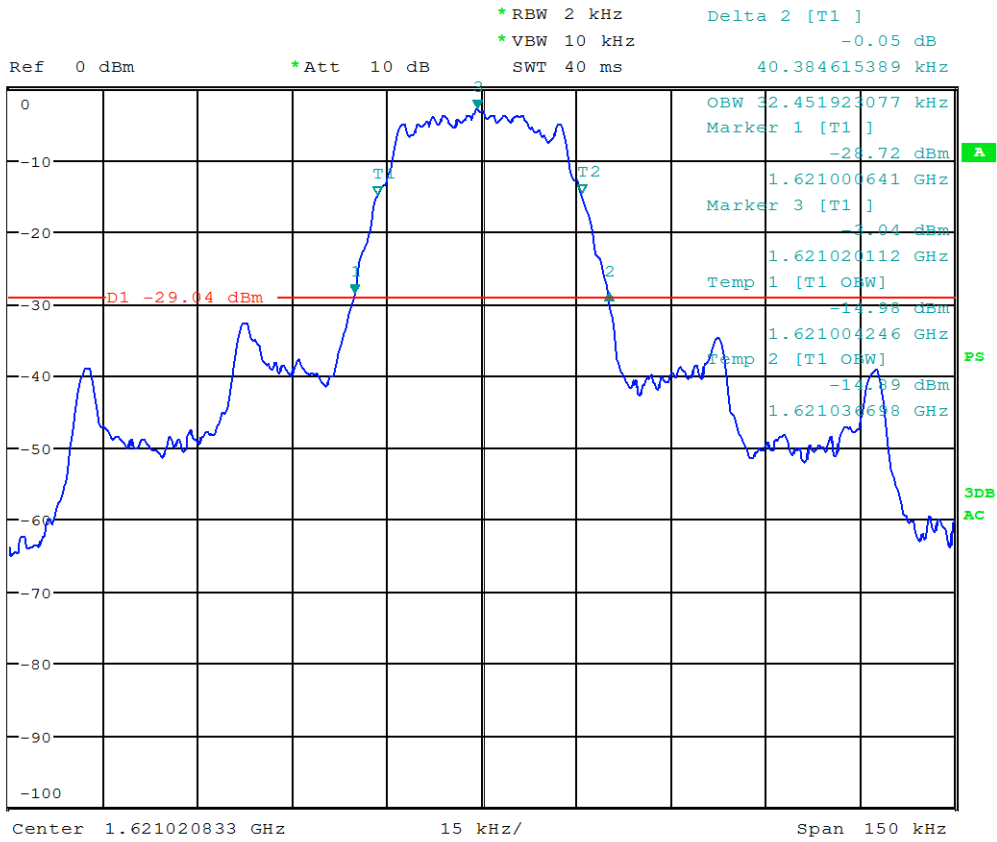

Date: 5.MAY.2016 08:07:52



*Graph 4.3*



1 PR  
VIEW

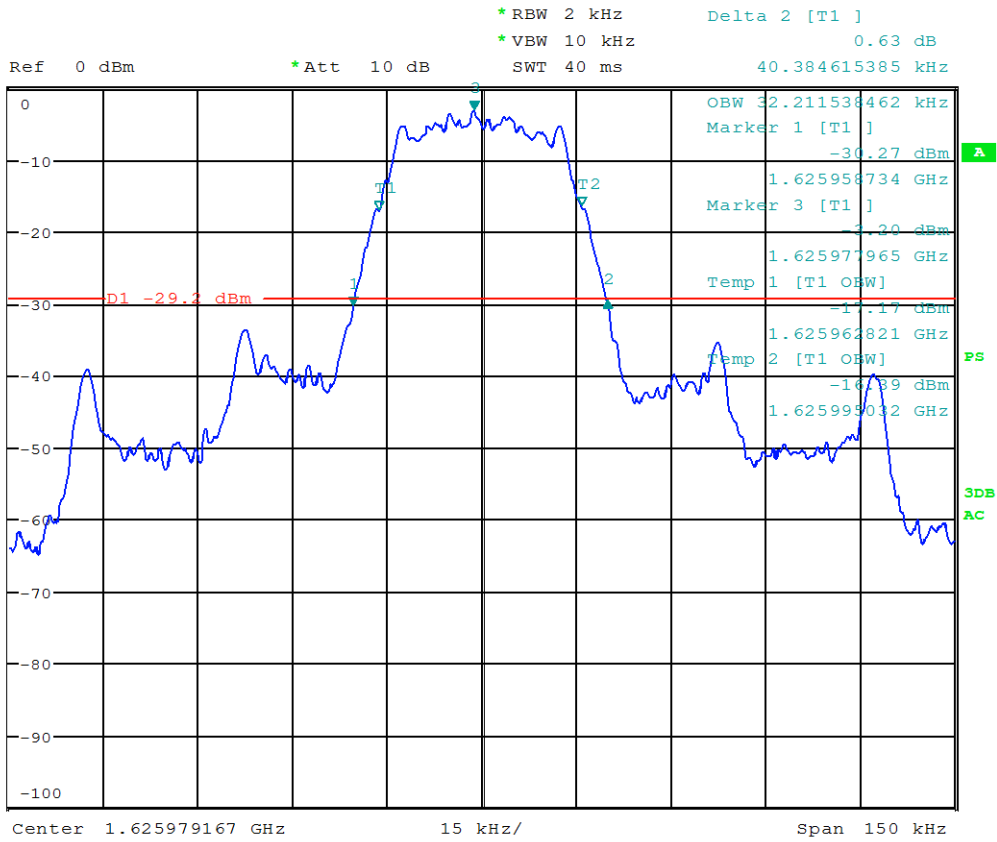

Date: 5.MAY.2016 08:11:30



**5.0 Emission Mask**

FCC CFR 47 Part 2, Clause 2.1053  
FCC CFR 47 Part 25, Clause 25.202(f)  
Industry Canada RSS-170, Clause 5.4

**5.1 Requirement**

Emission limitations. Except for SDARS terrestrial repeaters and as provided for in paragraph (i), the mean power of emissions shall be attenuated below the mean output power of the transmitter in accordance with the schedule set forth in paragraphs (f)(1) through (f)(4) of this section. The out-of-band emissions of SDARS terrestrial repeaters shall be attenuated in accordance with the schedule set forth in paragraph (h) of this section.

- (1) In any 4 kHz band, the center frequency of which is removed from the assigned frequency by more than 50 percent up to and including 100 percent of the authorized bandwidth: 25 dB;
- (2) In any 4 kHz band, the center frequency of which is removed from the assigned frequency by more than 100 percent up to and including 250 percent of the authorized bandwidth: 35 dB;
- (3) In any 4 kHz band, the center frequency of which is removed from the assigned frequency by more than 250 percent of the authorized bandwidth: An amount equal to 43 dB plus 10 times the logarithm (to the base 10) of the transmitter power in watts;
- (4) In any event, when an emission outside of the authorized bandwidth causes harmful interference, the Commission may, at its discretion, require greater attenuation than specified in paragraphs (f) (1), (2) and (3) of this section.

**5.2 Test Procedure**

The EUT was connected to a spectrum analyzer with a RF cable and 30dB attenuator. The path loss was entered as a reference level offset into the spectrum analyzer. The spectrum analyzer was configured with an RBW of 3 kHz and VBW of 10 kHz.  $10\text{Log}(4/3) = 1.25$  dB was added to the reference level offset to make the result relative to any 4 kHz band as per the requirement in 25.204(a). The transmit power was measured over the active part of the burst by utilizing the spectrum analyzers gating option and burst trigger. The detector used was a RMS detector with trace averaging of at least 100.

**5.3 Test Results**

<b>Complies</b>	Refer to the following Graphs
-----------------	-------------------------------

Graph 5. 1

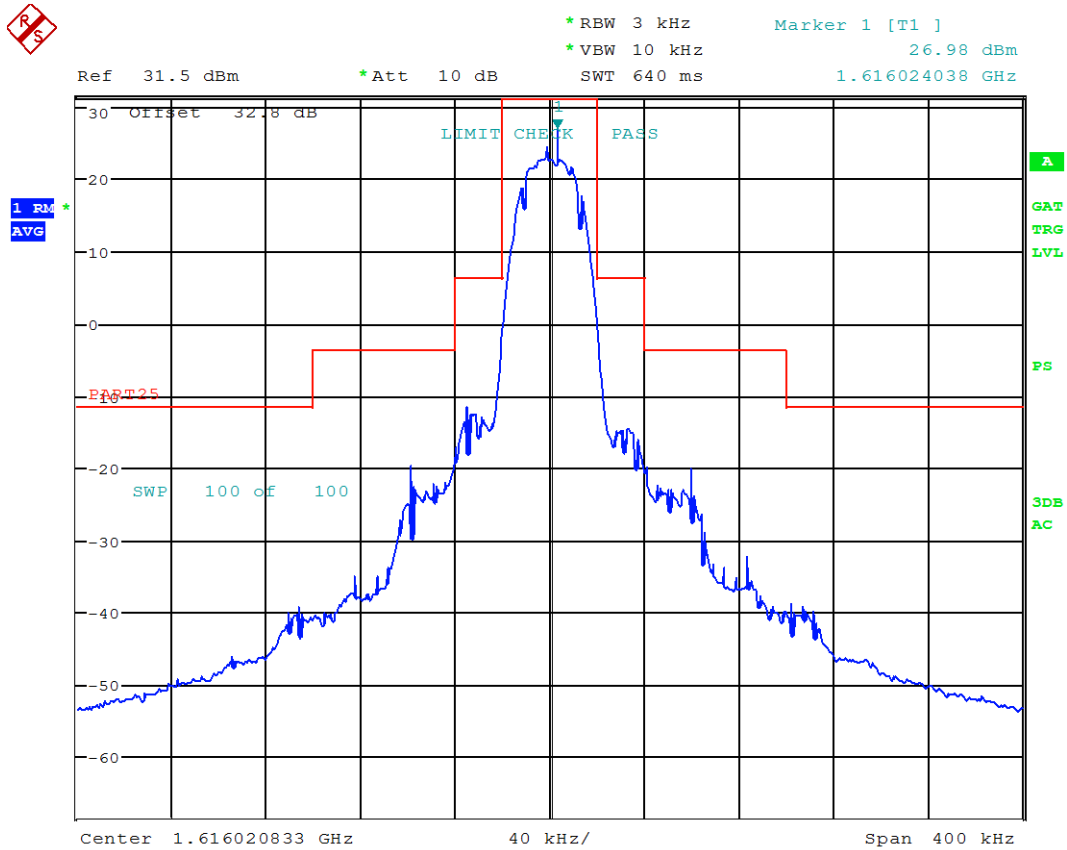

Date: 5.MAY.2016 09:25:59

Graph 5.2

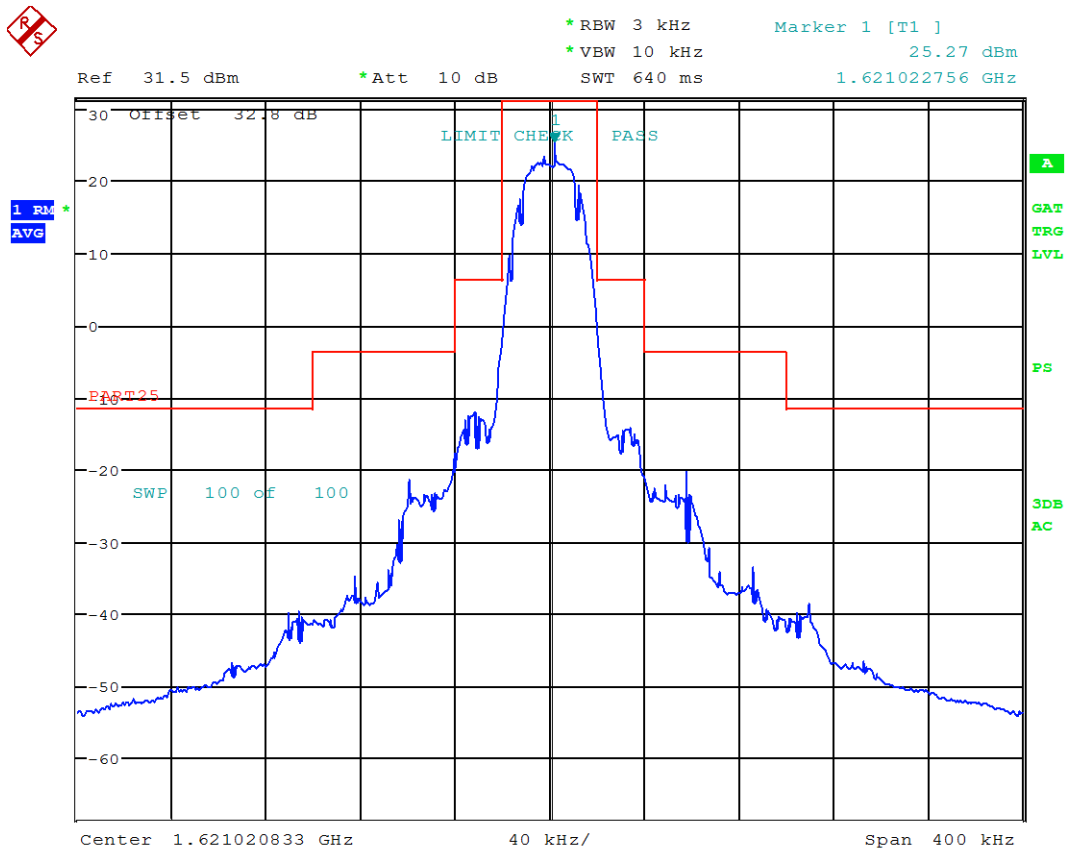

Date: 5.MAY.2016 09:08:32

Graph 5.3

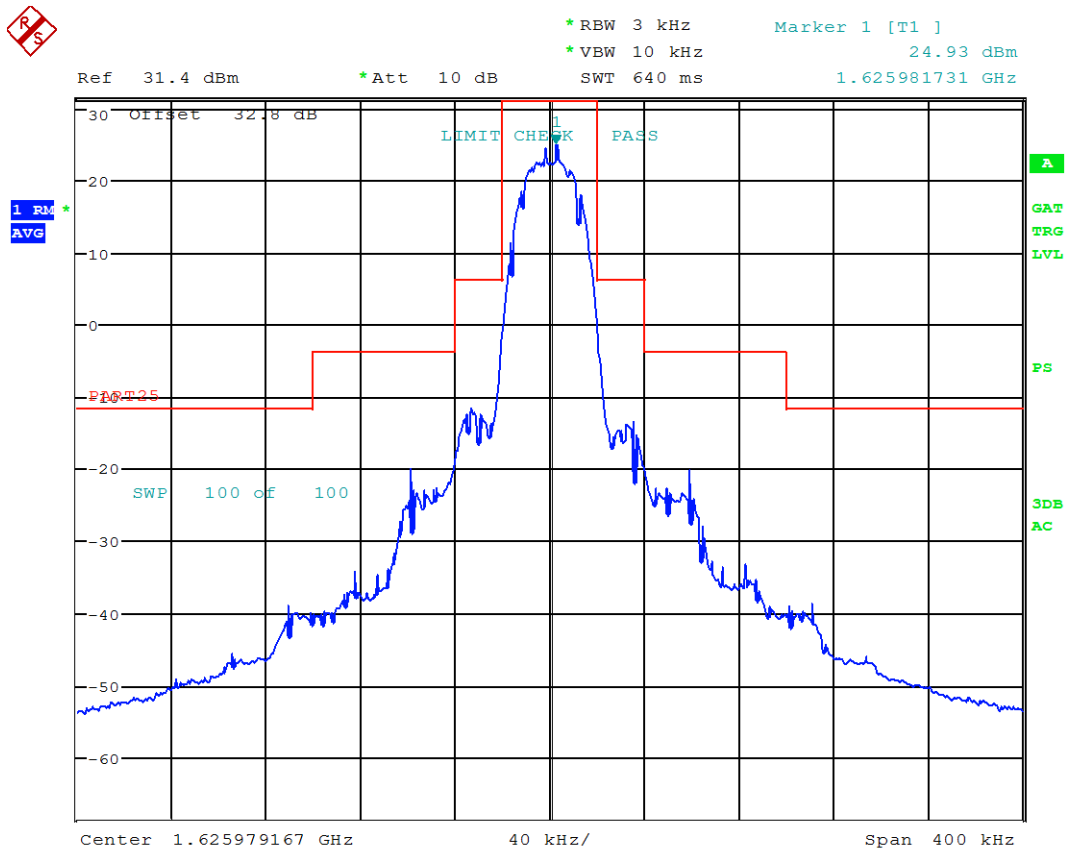

Date: 5.MAY.2016 08:44:53



## 6.0 Spurious Emissions

- 6.1 Emissions at Antenna Terminal
  - FCC CFR 47 Part 2, Clause 2.1053
  - FCC CFR 47 Part 25, Clause 25.202(f)
  - Industry Canada RSS-170, Clause 5.4

### 6.1.2 Requirement

Emission limitations. Except for SDARS terrestrial repeaters and as provided for in paragraph (i), the mean power of emissions shall be attenuated below the mean output power of the transmitter in accordance with the schedule set forth in paragraphs (f)(1) through (f)(4) of this section. The out-of-band emissions of SDARS terrestrial repeaters shall be attenuated in accordance with the schedule set forth in paragraph (h) of this section.

(1) In any 4 kHz band, the center frequency of which is removed from the assigned frequency by more than 50 percent up to and including 100 percent of the authorized bandwidth: 25 dB;

(2) In any 4 kHz band, the center frequency of which is removed from the assigned frequency by more than 100 percent up to and including 250 percent of the authorized bandwidth: 35 dB;

(3) In any 4 kHz band, the center frequency of which is removed from the assigned frequency by more than 250 percent of the authorized bandwidth: An amount equal to 43 dB plus 10 times the logarithm (to the base 10) of the transmitter power in watts;

(4) In any event, when an emission outside of the authorized bandwidth causes harmful interference, the Commission may, at its discretion, require greater attenuation than specified in paragraphs (f) (1), (2) and (3) of this section.

### 6.1.2 Test Procedure

The EUT RF output was connected as shown on the diagram in report section 1.3.2. The EUT was setup to transmit the maximum power.

Sufficient scans were taken to show the spurious emissions up to 10th harmonic.

### 6.1.3 Test Results

<b>Complies</b>	Refer to the following Graphs
-----------------	-------------------------------

Graph 6. 1

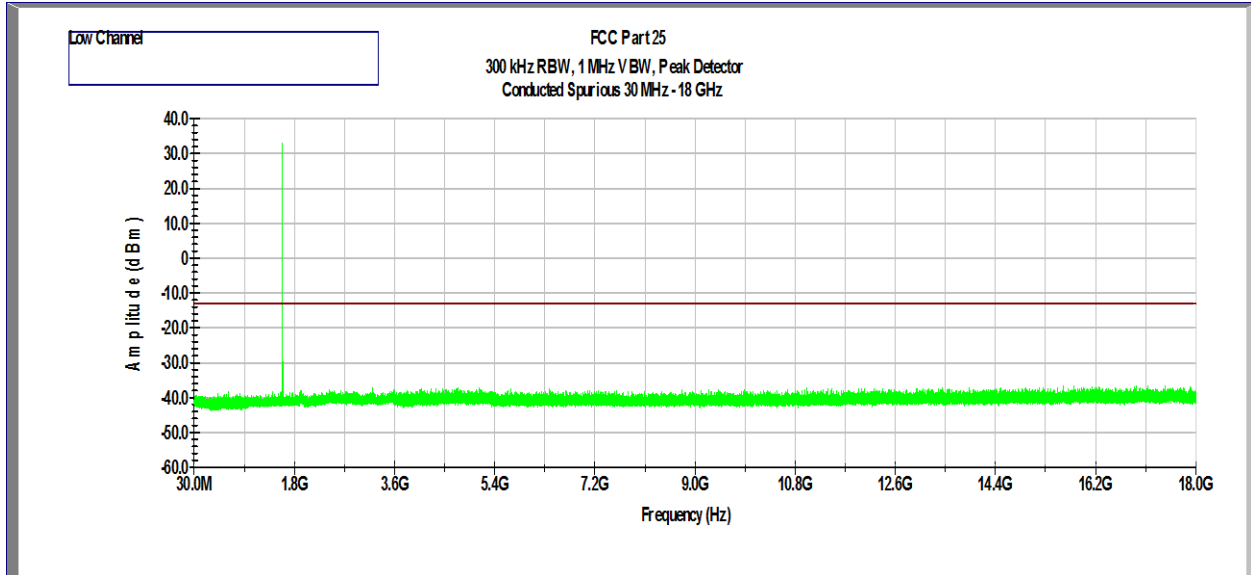

Graph 6. 2

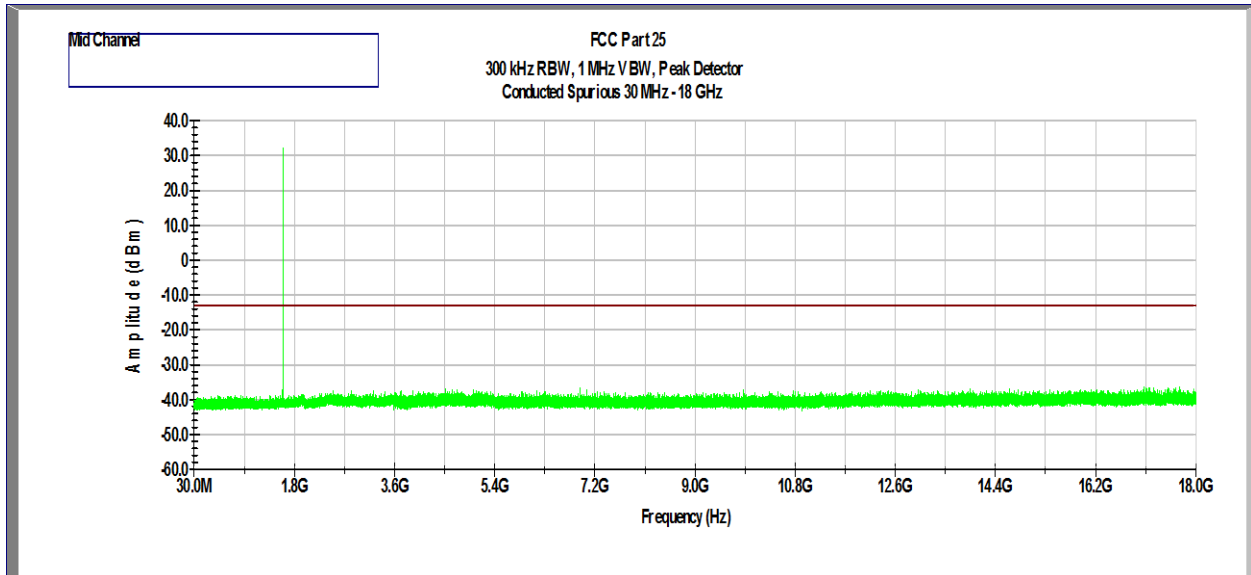

Graph 6.3

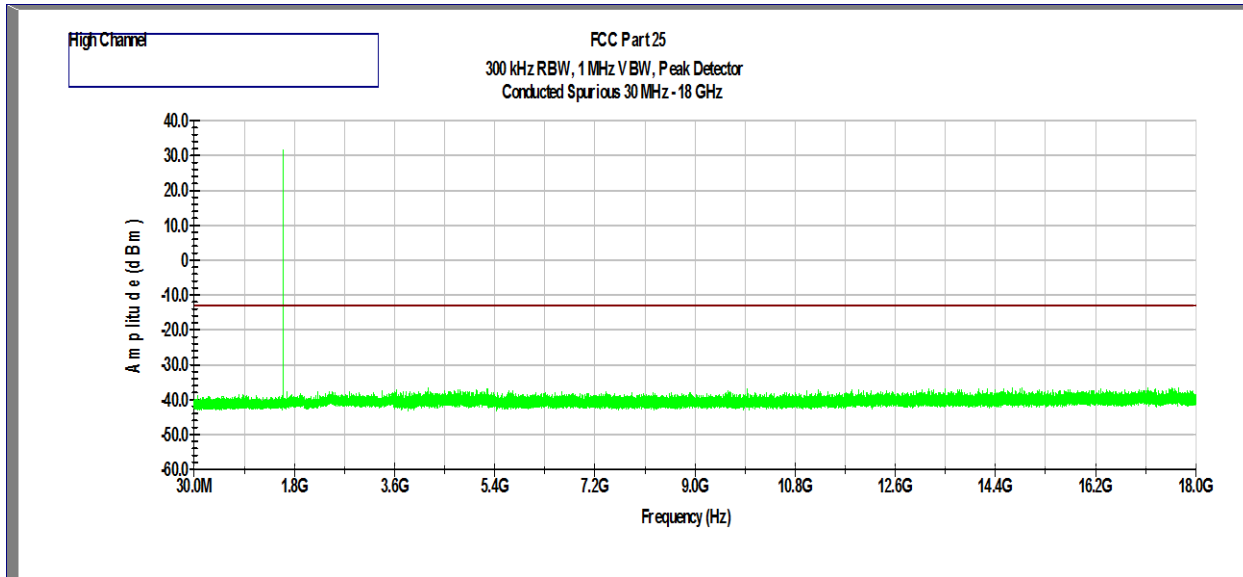

Result	Complies
--------	----------





## 6.2 Spurious Radiation

### 6.2.1 Test Procedure

The measurement antenna was placed at a distance of 10 meters for 30MHz – 1GHz and 3 meters for 1-17GHz from the EUT. During the tests, the antenna height and polarization as well as EUT azimuth were varied in order to identify the maximum level of emissions from the EUT.

The frequency range up to 10th harmonic was investigated. The worst case of emissions was reported.

Spectrum Analyzer Resolution Bandwidth was set to 1 MHz, and Video Bandwidth was set to 3 MHz.

The EUT is placed on a plastic turntable that is 80 cm in height for below 1000MHz and 1.5m in height for above 1GHz. If the EUT attaches to peripherals, they are connected and operational (as typical as possible). During testing, all cables were manipulated to produce worst-case emissions. The signal is maximized through rotation. The antenna height and polarization are varied during the search for maximum signal level. The antenna height is varied from 1 to 4 meters.

Radiated emissions are taken at 3 meters for frequencies above 1 GHz and at 10 meters for frequencies below 1 GHz.

Measurements made from 30 MHz to 17 GHz were measured with 50 ohm terminator on the output of the EUT RF port. A preamp was used from 30MHz to 17GHz.

Data is included of the worst-case configuration (the configuration which resulted in the highest emission levels).

All measurements were made with a Peak Detector and compared to the EIRP limits. All measurements are corrected for cable, antenna, preamp and distance then compared to a 3m limit of 82.23 dBuV/m

The limit of -13dBm EIRP was converted to a Field Strength of 82.23dBuV/m at 3m using the calculation below.

#### Limit Line Calculation at 3m

$$E_o = \text{EIRP} - 20\log D + 104.8$$

where:

$E_o$  = electric field strength limit in dB $\mu$ V/m, 3m

EIRP = equivalent isotropic radiated power in dBm

D = specified measurement distance in meters, 3m

**Spurious Radiated Emissions  
Low Channel**

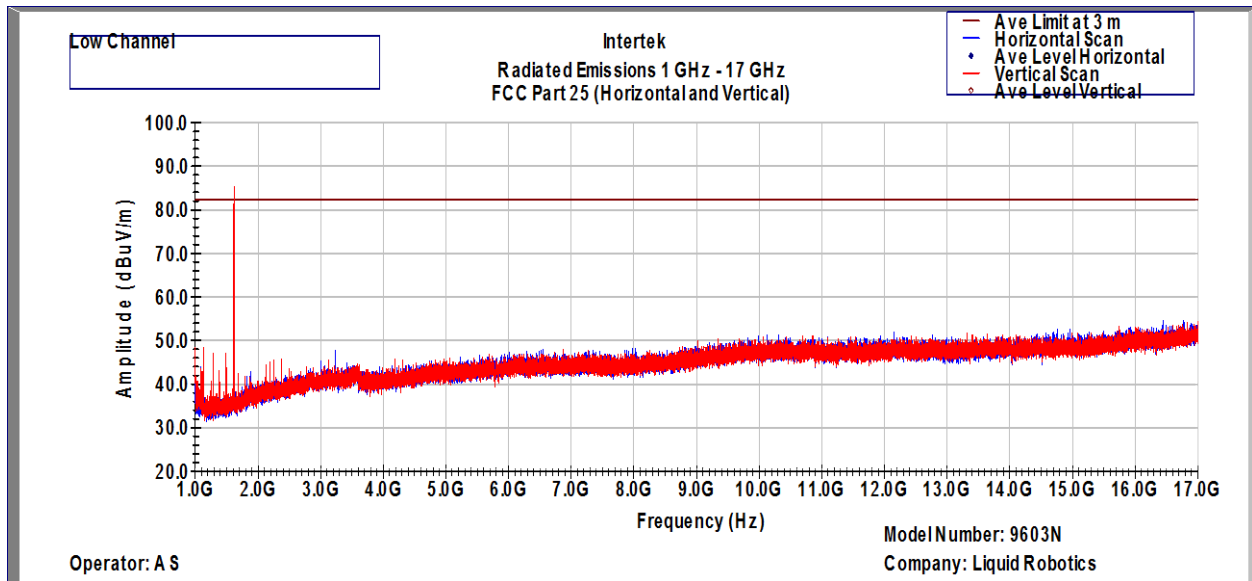
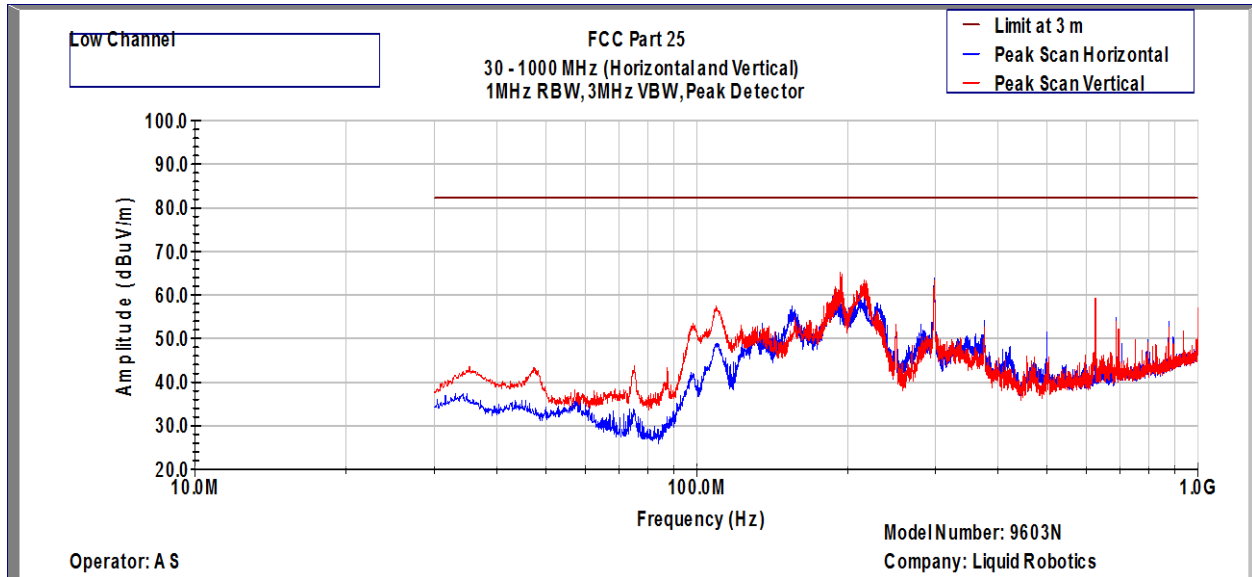

Result	Complies
--------	----------

### Spurious Radiated Emissions Mid Channel

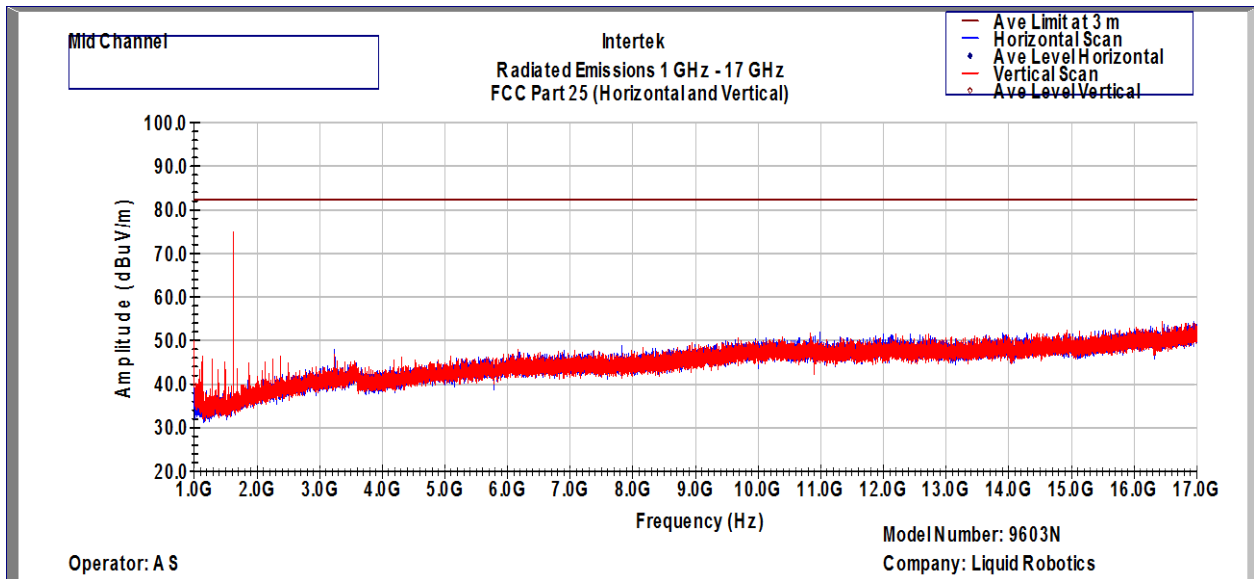
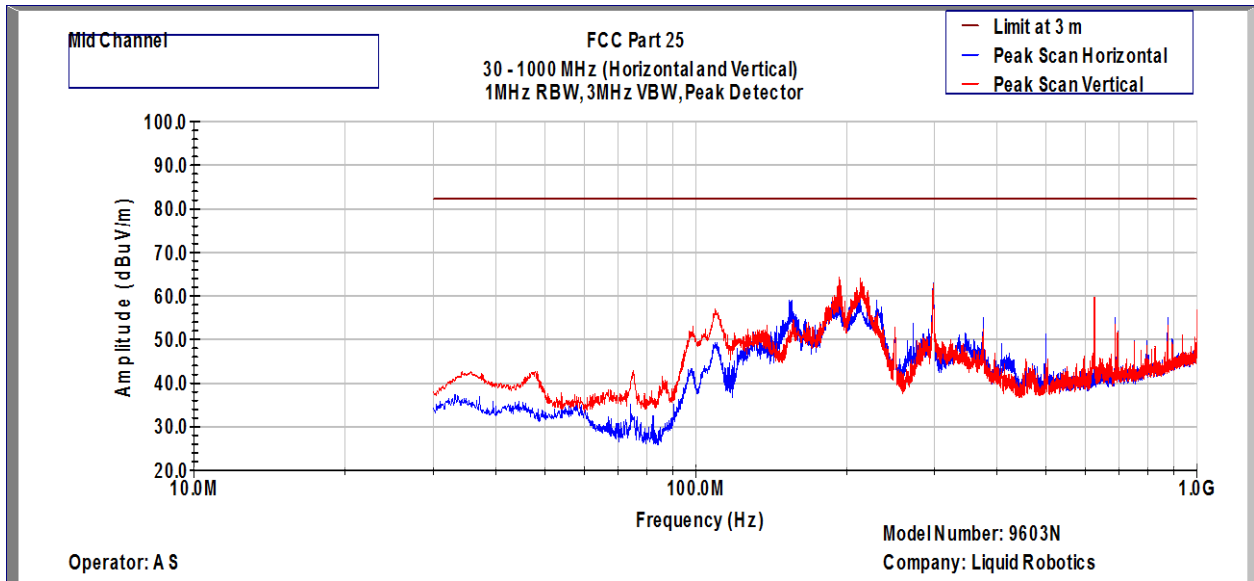

Result	Complies
--------	----------

**Spurious Radiated Emissions  
High Channel**

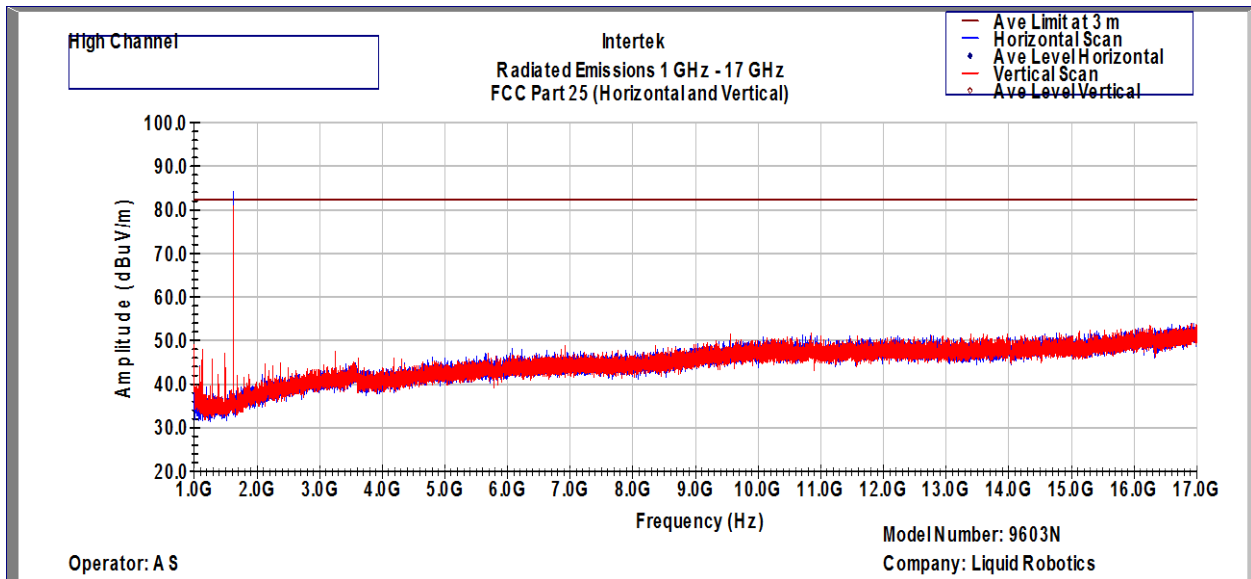
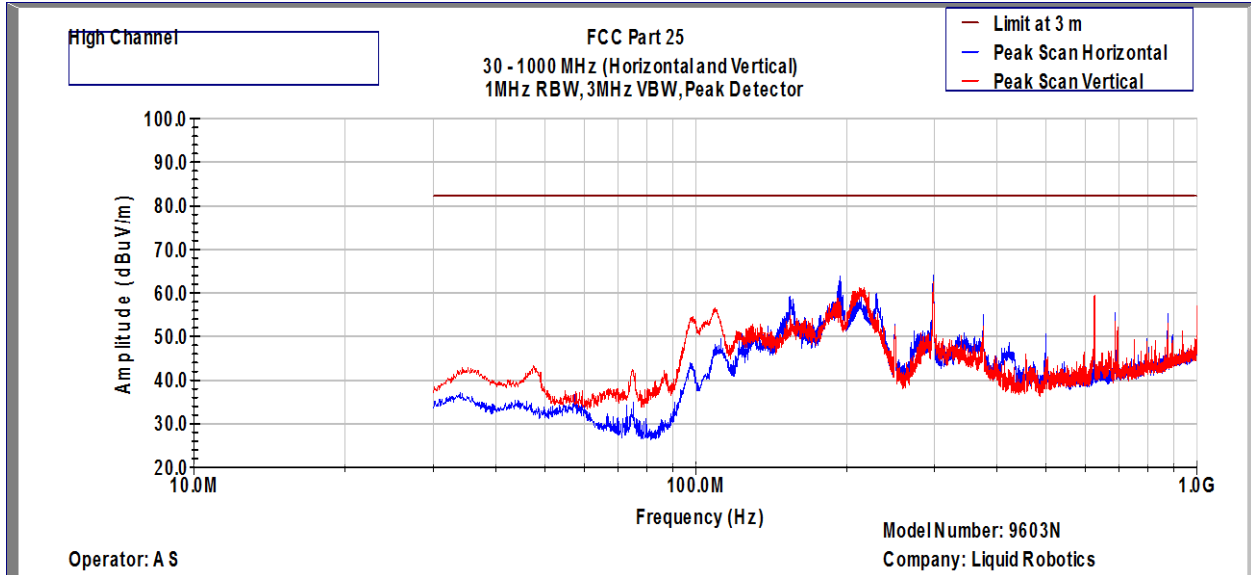

Result	Complies
--------	----------

**Radiated Emission Test Setup**

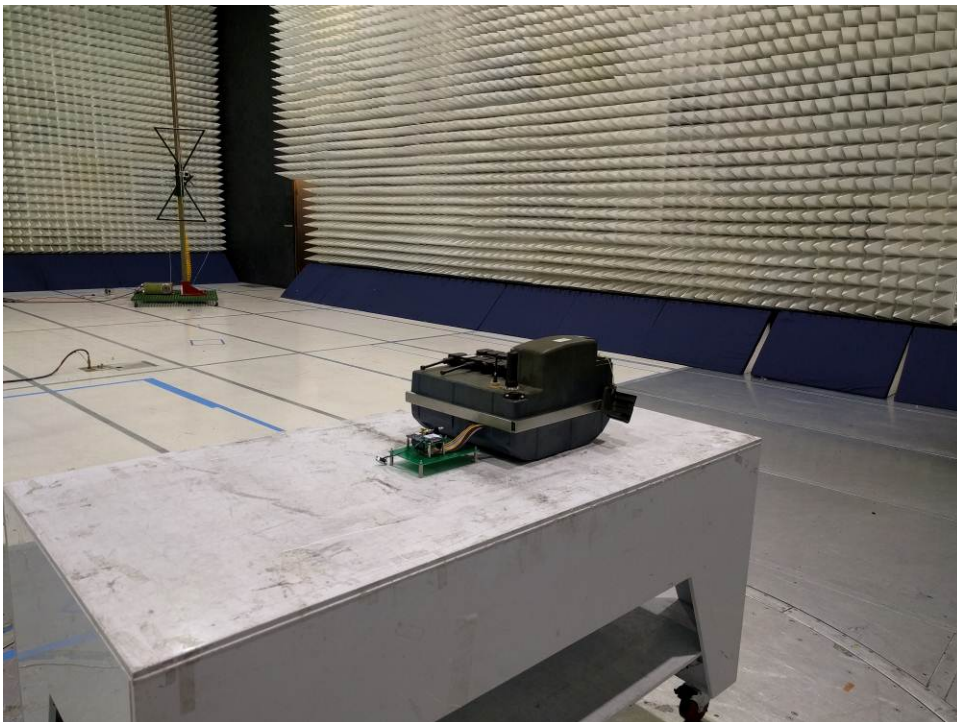

Test setup photographs

### Radiated Emission Test Setup

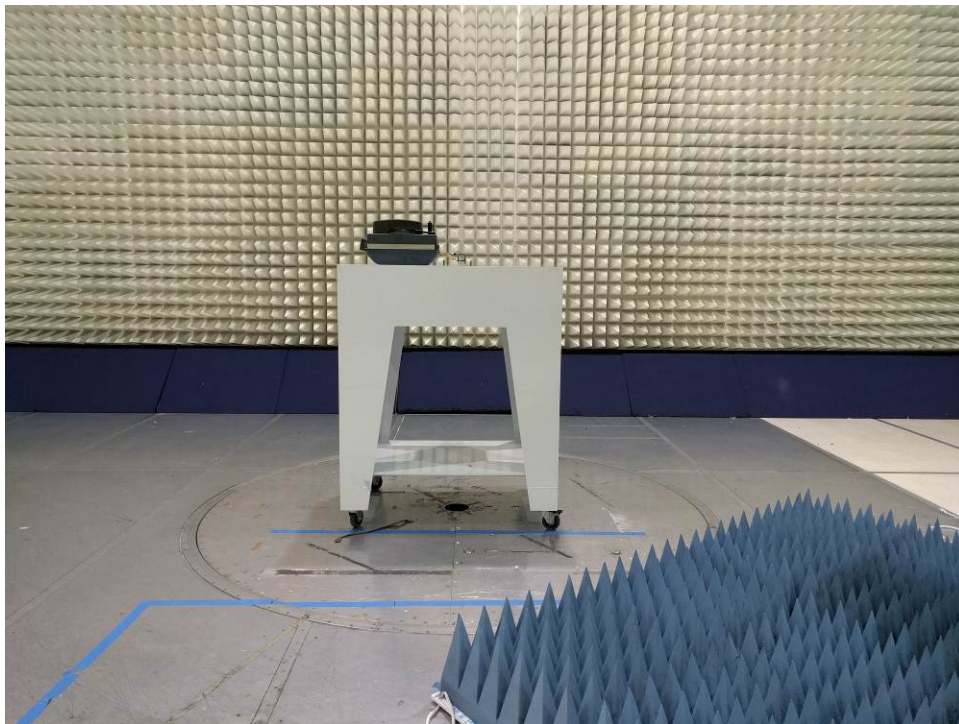



## 7.0 Limits on Emissions from Mobile Earth Stations for Protection of Aeronautical Radio navigation-Satellite Service

FCC CFR 47 Part 25, Clause 25.216 (a-j)  
Industry Canada RSS-170, Clause 5.4.3, 5.4.4

### 7.1 Requirement

The e.i.r.p. density of emissions from mobile earth stations placed in service after July 21, 2002 with assigned uplink frequencies between 1610 MHz and 1660.5 MHz shall not exceed  $-70$  dBW/MHz, averaged over any 2 millisecond active transmission interval, in the band 1559-1605 MHz. The e.i.r.p. of discrete emissions of less than 700 Hz bandwidth from such stations shall not exceed  $-80$  dBW, averaged over any 2 millisecond active transmission interval, in the 1559-1605 MHz band.

Mobile earth stations placed in service after July 21, 2002 with assigned uplink frequencies in the 1610-1660.5 MHz band shall suppress the power density of emissions in the 1605-1610 MHz band to an extent determined by linear interpolation from  $-70$  dBW/MHz at 1605 MHz to  $-10$  dBW/MHz at 1610 MHz.

The e.i.r.p density of carrier-off state emissions from mobile earth stations manufactured more than six months after Federal Register publication of the rule changes adopted in FCC 03-283 with assigned uplink frequencies between 1 and 3 GHz shall not exceed  $-80$  dBW/MHz in the 1559-1610 MHz band averaged over any two millisecond interval.

Mobile equipment with transmitting frequencies between 1 GHz and 3 GHz shall have the e.i.r.p. density of carrier-off state emissions in the band 1559-1610 MHz not exceed  $-80$  dBW/MHz.

A Root-Mean-Square detector shall be used for all power density measurements.

### 7.2 Test Procedure

The EUT RF output was connected as shown on the diagram in report section 1.3.2. The EUT was setup to transmit the maximum power.

### Low Channel

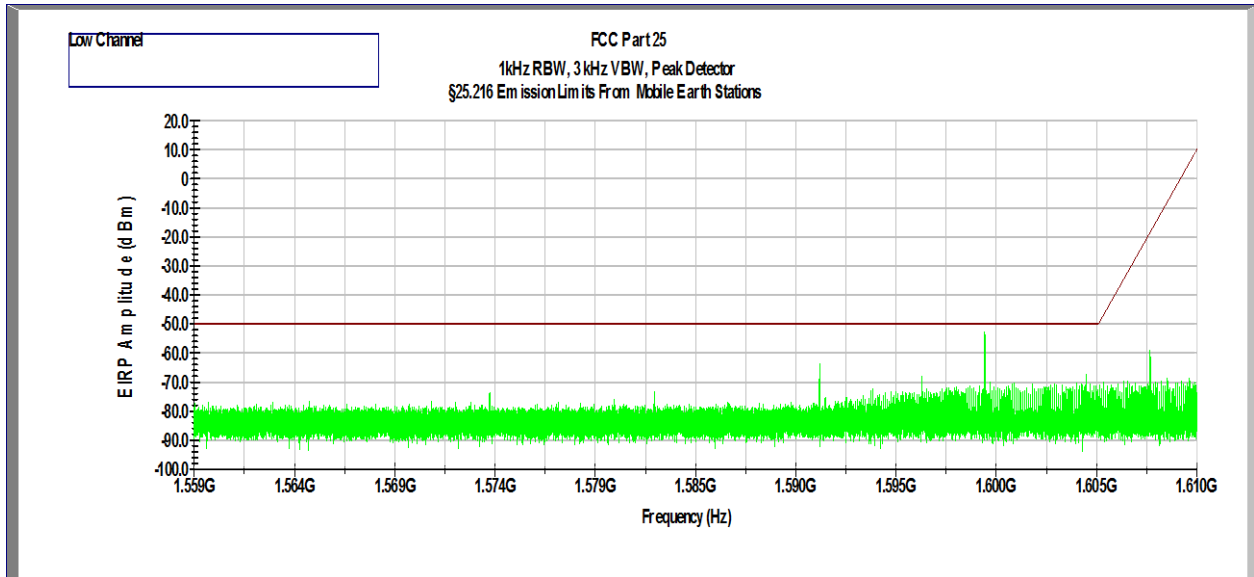
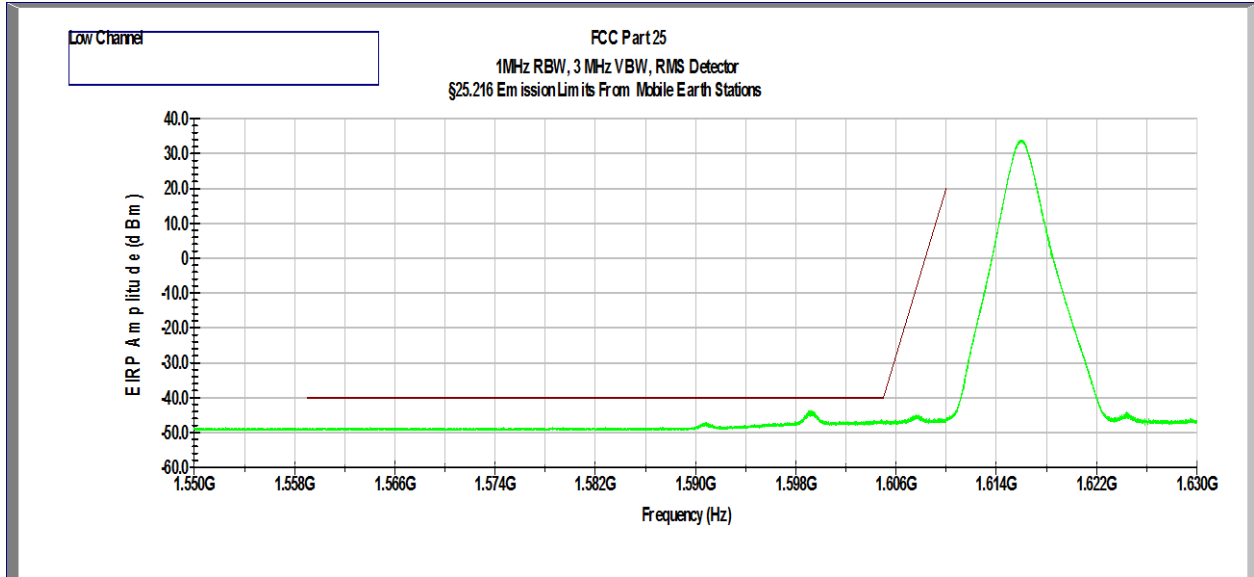



Mid Channel

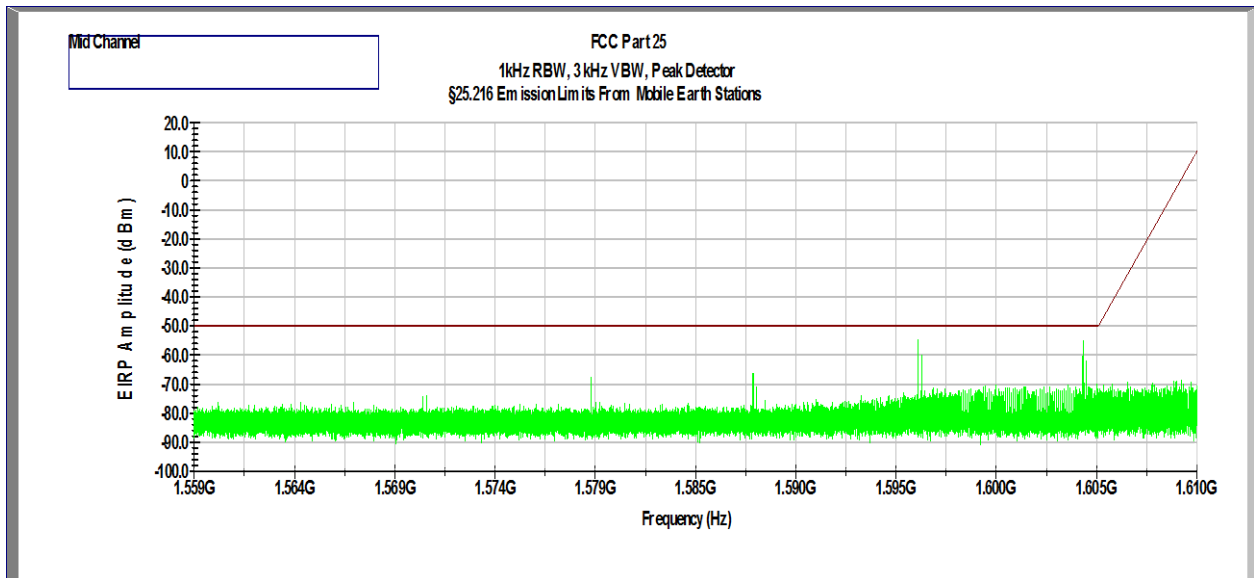
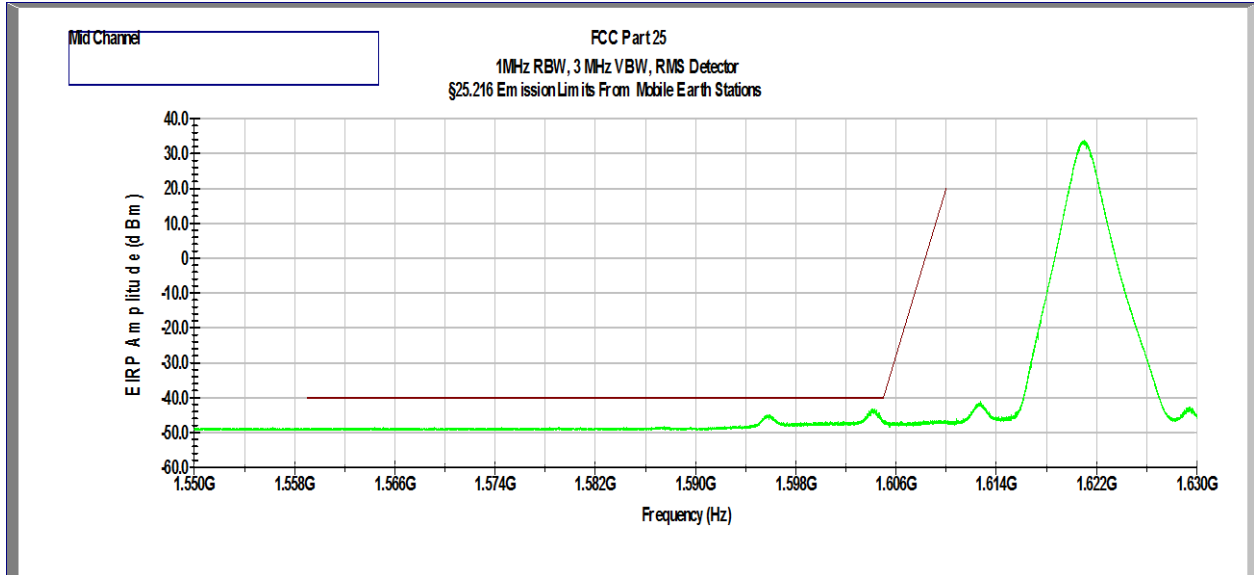

### High Channel

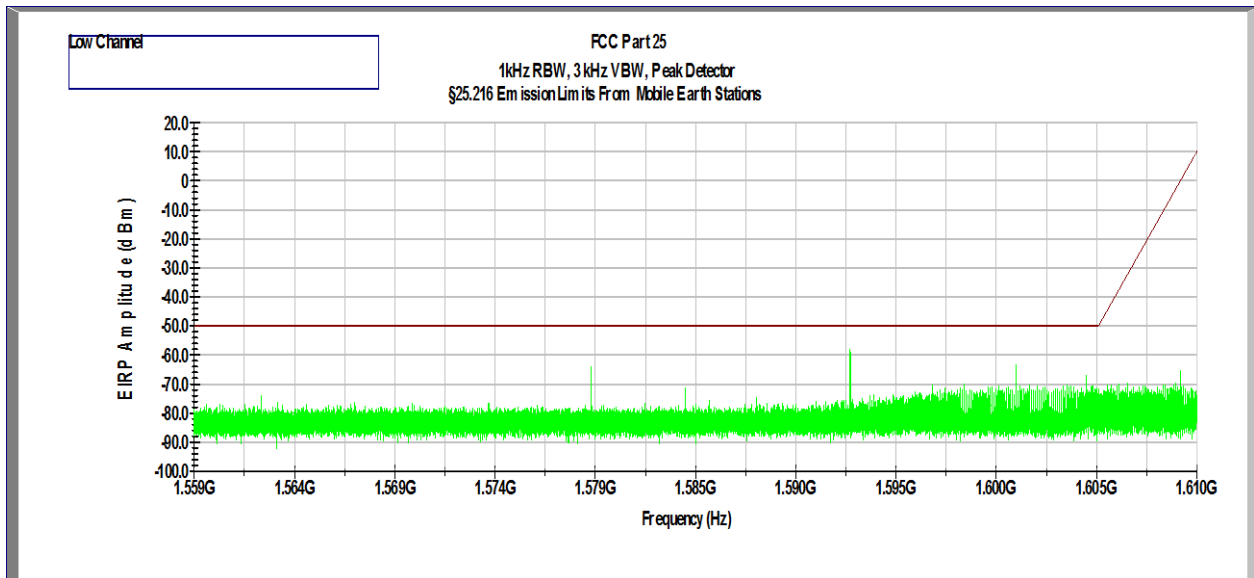
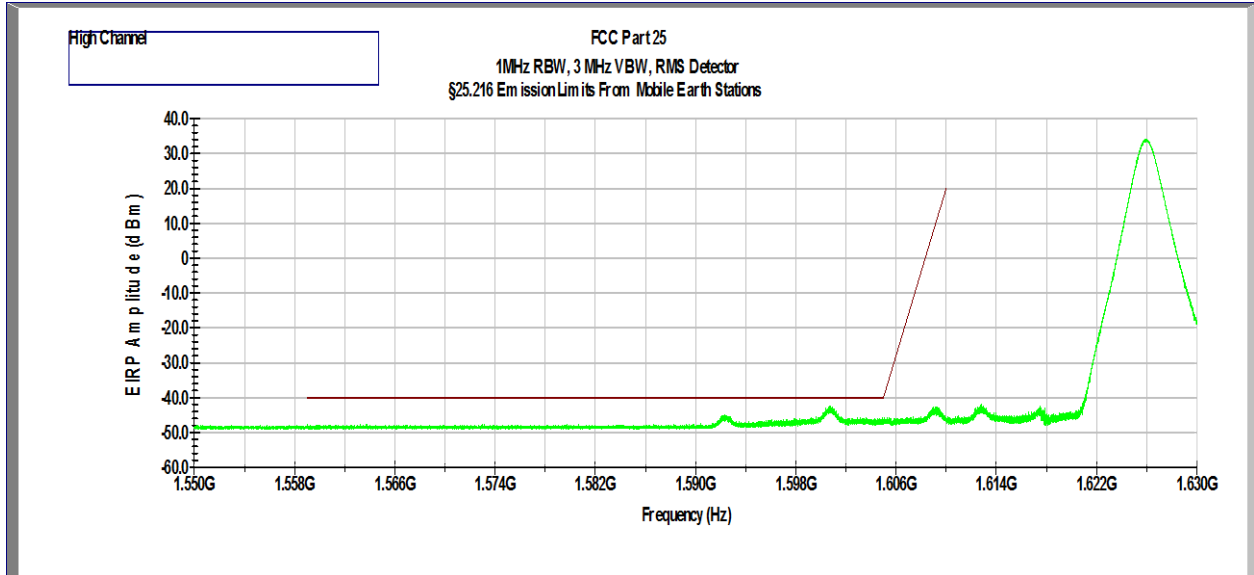

### Carrier off state

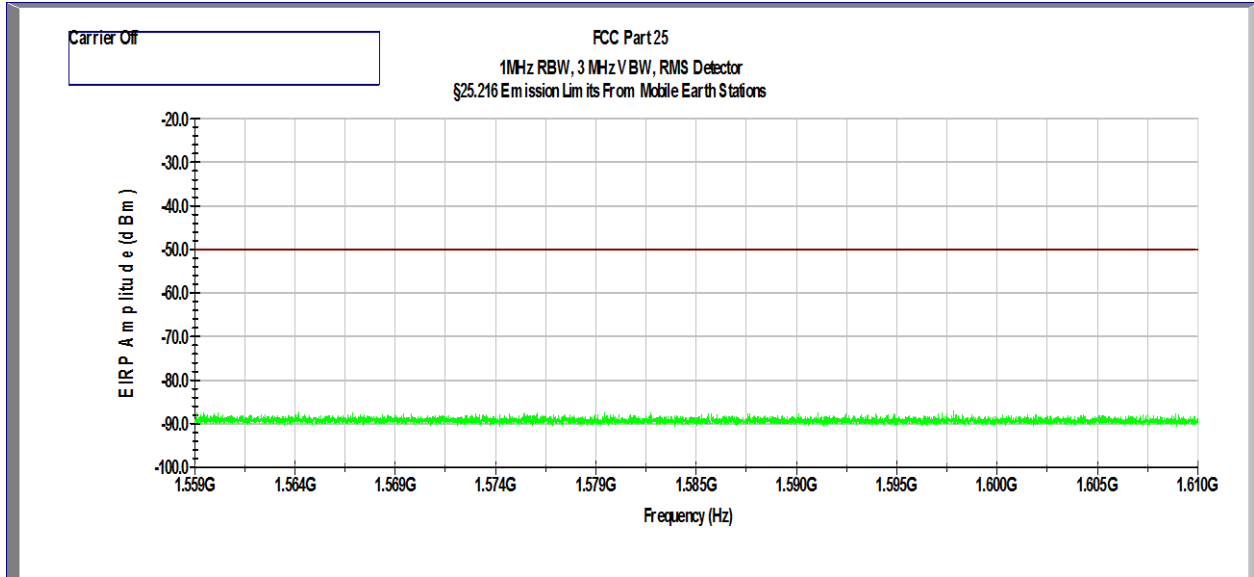

Results:	Complies
----------	----------



## 8.0 Frequency Stability vs Temperature and Voltage

FCC 2.1055, 25.202(d)

RSS-170, 5.2

### 8.1 Requirement

Limit Clause FCC CFR 47, 25.202(d)

Frequency tolerance, Earth stations. The carrier frequency of each earth station transmitter authorized in these services shall be maintained within 0.001 percent of the reference frequency.

Limit Clause RSS-170, 5.2

For mobile earth station equipment, the carrier frequency shall not depart from the reference frequency by more than  $\pm 10$  ppm.

### 8.2 Test Procedure

The EUT was placed inside the temperature chamber. The RF power output was connected to frequency counter. The EUT was setup to transmit the maximum power. The EUT was set to transmit.

After the temperature stabilized for approximately 20 minutes, the transmitting frequency was measured by the frequency counter and recorded.

At the room temperature, the frequency was measured when the EUT was powered with 16VDC for temperature testing. As declared by the manufacturer, the voltage range of the EUT is 14VDC to 25VDC.



8.3 Test Results

<b>Temperature (°C)</b>	<b>Frequency at nominal voltage (MHz)</b>	<b>Maximum deviation from frequency at 20°C, ppm</b>	<b>Maximum deviation from frequency at 20°C, %</b>
Nominal Frequency: 1616.020833 MHz			
85	1616.026472	3.447	-0.000345
80	1616.026382	3.392	-0.000339
70	1616.025412	2.791	-0.000279
60	1616.025175	2.645	-0.000264
50	1616.025129	2.616	-0.000262
40	1616.021418	0.320	-0.000032
30	1616.020134	0.475	0.000047
20	1616.020901	0.000	0.000000
10	1616.020849	0.032	0.000003
0	1616.020841	0.037	0.000004
-10	1616.018131	1.714	0.000171
-20	1616.015038	3.628	0.000363
-30	1616.013942	4.306	0.000431
-40	1616.012641	5.111	0.000511
<b>Voltage (DC)</b>	<b>Frequency at nominal Temperature (MHz)</b>	<b>Maximum deviation from frequency at 20°C, ppm</b>	<b>Maximum deviation from frequency at 20°C, %</b>
14.0	1616.020950	0.030	-0.000003%
25.0	1616.020821	0.050	0.000005%



<b>Temperature (°C)</b>	<b>Frequency at nominal voltage (MHz)</b>	<b>Maximum deviation from frequency at 20°C, ppm</b>	<b>Maximum deviation from frequency at 20°C, %</b>
Nominal Frequency: 1621.020833 MHz			
85	1621.027477	4.006	-0.000401
80	1621.027391	3.952	-0.000395
70	1621.026235	3.239	-0.000324
60	1621.025841	2.996	-0.000300
50	1621.025471	2.768	-0.000277
40	1621.021851	0.535	-0.000053
30	1621.021841	0.529	-0.000053
20	1621.020984	0.000	0.000000
10	1621.020784	0.123	0.000012
0	1621.020041	0.582	0.000058
-10	1621.019215	1.091	0.000109
-20	1621.017410	2.205	0.000220
-30	1621.015230	3.550	0.000355
-40	1621.014557	3.965	0.000396
<b>Voltage (DC)</b>	<b>Frequency at nominal Temperature (MHz)</b>	<b>Maximum deviation from frequency at 20°C, ppm</b>	<b>Maximum deviation from frequency at 20°C, %</b>
14.0	1621.020242	0.458	0.000046
25.0	1621.020381	0.372	0.000037



<b>Temperature (°C)</b>	<b>Frequency at nominal voltage (MHz)</b>	<b>Maximum deviation from frequency at 20°C, ppm</b>	<b>Maximum deviation from frequency at 20°C, %</b>
Nominal Frequency: 1625.979167 MHz			
85	1625.987293	4.994	-0.000499
80	1625.987117	4.886	-0.000489
70	1625.986314	4.392	-0.000439
60	1625.984831	3.480	-0.000348
50	1625.983417	2.610	-0.000261
40	1625.980145	0.598	-0.000060
30	1625.979031	0.087	0.000009
20	1625.979173	0.000	0.000000
10	1625.979014	0.098	0.000010
0	1625.979001	0.106	0.000011
-10	1625.977623	0.953	0.000095
-20	1625.975415	2.311	0.000231
-30	1625.974931	2.609	0.000261
-40	1625.973510	3.483	0.000348
<b>Voltage (DC)</b>	<b>Frequency at nominal Temperature (MHz)</b>	<b>Maximum deviation from frequency at 20°C, ppm</b>	<b>Maximum deviation from frequency at 20°C, %</b>
14.0	1625.979272	0.061	-0.000006
25.0	1625.979293	0.074	-0.000007



## 9.0 List of Test Equipment

Measurement equipment used for compliance testing utilized the equipment on the following list:

<b>Equipment</b>	<b>Manufacturer</b>	<b>Model/Type</b>	<b>Asset #</b>	<b>Cal Int</b>	<b>Cal Due</b>
EMI Receiver	Rohde and Schwarz	ESU	ITS 00961	12	06/02/16
Spectrum Analyzer	Rohde and Schwarz	FSU	ITS 00913	12	01/05/17
BI-Log Antenna	Antenna Research	LPB-2513	ITS 00355	12	08/11/16
Pre-Amplifier	Sonoma Instrument	310	ITS 00942	12	01/07/17
Horn Antenna/Preamp	EMCO	3117PA	ITS 01325	12	11/23/16
Environmental Chamber	Thermotron	F-158-CHM-15-15	ITS 01027	12	05/19/16





## 10.0 Document History

<b>Revision/ Job Number</b>	<b>Writer Initials</b>	<b>Reviewer</b>	<b>Date</b>	<b>Change</b>
1.0 / G102576886	AS	KV	May 27, 2016	Original document