

# Test report

**303263-1R1TRFWL**

Date of issue: October 7, 2016

Applicant:

**Intracom S.A. Telecom Solutions**

Product:

**60 GHz PtP Small cell radio**

Model:

**StreetNode 6250 PtP**

Part number:

**SN6250-F-2-L-G-AC**

Part number variant:

**SN6250-F-2-H-G-DC**

FCC ID:

**2AHZC-SN6250BF02TA**

Specification:


**FCC 47 CFR Part 15 Subpart C, §15.255**

Operation within the band 57–64 GHz.

Test location

---

Company name	Nemko Canada Inc.
Address	303 River Road
City	Ottawa
Province	Ontario
Postal code	K1V 1H2
Country	Canada
Telephone	+1 613 737 9680
Facsimile	+1 613 737 9691
Toll free	+1 800 563 6336
Website	www.nemko.com
Site number	FCC: 176392 (3 m semi anechoic chamber)

Tested by	Andrey Adelberg, Senior Wireless/EMC Specialist
Reviewed by	Kevin Rose, Wireless/EMC Specialist
Date	October 7, 2016
Signature of reviewer	

Limits of responsibility

---

Note that the results contained in this report relate only to the items tested and were obtained in the period between the date of initial receipt of samples and the date of issue of the report.

This test report has been completed in accordance with the requirements of ISO/IEC 17025. All results contain in this report are within Nemko Canada's ISO/IEC 17025 accreditation.

Copyright notification

---

Nemko Canada Inc. authorizes the applicant to reproduce this report provided it is reproduced in its entirety and for use by the company's employees only. Any use which a third party makes of this report, or any reliance on or decisions to be made based on it, are the responsibility of such third parties.

Nemko Canada Inc. accepts no responsibility for damages, if any, suffered by any third party as a result of decisions made or actions based on this report.

© Nemko Canada Inc.

## Table of contents

<b>Table of contents</b> .....	<b>3</b>
<b>Section 1. Report summary</b> .....	<b>4</b>
1.1 Applicant and manufacturer .....	4
1.2 Test specifications .....	4
1.3 Test methods.....	4
1.4 Statement of compliance .....	4
1.5 Exclusions.....	4
1.6 Test report revision history .....	4
<b>Section 2. Summary of test results</b> .....	<b>5</b>
2.1 FCC Part 15 Subpart C test results .....	5
<b>Section 3. Equipment under test (EUT) details</b> .....	<b>6</b>
3.1 Sample information.....	6
3.2 EUT information .....	6
3.3 Technical information .....	6
3.4 Product description and theory of operation .....	6
3.5 EUT exercise details.....	6
3.6 EUT setup diagram .....	7
<b>Section 4. Engineering considerations</b> .....	<b>8</b>
4.1 Modifications incorporated in the EUT.....	8
4.2 Technical judgment .....	8
4.3 Deviations from laboratory tests procedures .....	8
<b>Section 5. Test conditions</b> .....	<b>9</b>
5.1 Atmospheric conditions .....	9
5.2 Power supply range.....	9
<b>Section 6. Measurement uncertainty</b> .....	<b>10</b>
6.1 Uncertainty of measurement .....	10
<b>Section 7. Test equipment</b> .....	<b>11</b>
7.1 Test equipment list.....	11
<b>Section 8. Testing data</b> .....	<b>12</b>
8.1 FCC 15.207(a) AC power line conducted emissions limits .....	12
8.2 FCC 15.255(b) and (e) Conducted output power and EIRP requirements .....	15
8.3 FCC 15.255(c) Limits on spurious emissions .....	18
8.4 FCC 15.255(e)(1) 6 dB bandwidth.....	24
8.5 FCC 15.255(f) Frequency stability.....	26
<b>Section 9. Block diagrams of test set-ups</b> .....	<b>28</b>
9.1 Radiated emissions set-up for frequencies below 1 GHz.....	28
9.2 Radiated emissions set-up for frequencies above 1 GHz.....	29
9.3 Conducted emissions set-up .....	29

## Section 1. Report summary

---

### 1.1 Applicant and manufacturer

---

Company name	Intracom S.A. Telecom Solutions
Address	19.7 km Markopoulou Ave.
City	Peania
Province/State	Athens
Postal/Zip code	GR-19002
Country	Greece

### 1.2 Test specifications

---

FCC 47 CFR Part 15, Subpart C, Clause 15.255	Operation within the band 57–64 GHz
--	-------------------------------------

### 1.3 Test methods

---

ANSI C63.10 v 2013	American National Standard for Procedures for Compliance Testing of Unsilenced Wireless Devices
--------------------	---

### 1.4 Statement of compliance

---

In the configuration tested, the EUT was found compliant.

Testing was completed against all relevant requirements of the test standard. Results obtained indicate that the product under test complies in full with the requirements tested. The test results relate only to the items tested.

See “Summary of test results” for full details.

### 1.5 Exclusions

---

None

### 1.6 Test report revision history

---

Revision #	Details of changes made to test report
TRF	Original report issued
R1TRF	Updated test report with proper sample test results

## Section 2. Summary of test results

---

### 2.1 FCC Part 15 Subpart C test results

---

Part	Test description	Verdict
§15.207(a)	Conducted limits	Pass
§15.203	Antenna requirement	Pass <sup>1</sup>
§15.255(b) and (e)	Conducted output power and EIRP requirements	Pass
§15.255(c)	Limits on spurious emissions	Pass
§15.255(e)(1)	6 dB BW	Pass
§15.255(f)	Frequency stability	Pass

Notes: <sup>1</sup> The EUT is a professionally installed device and the installer is responsible for ensuring that the proper antenna is employed.

## Section 3. Equipment under test (EUT) details

---

### 3.1 Sample information

---

Receipt date	March 29, 2016
Nemko sample ID number	1, 2

### 3.2 EUT information

---

Product name	60 GHz PtP Small cell radio
Model	StreetNode 6250 PtP
Part number	SN6250-F-2-L-G-AC
Part number variant*	SN6250-F-2-H-G-DC
Serial number	311602000130 (Low radio) and 311602000133 (High radio)

\* - Part number variants: **SN6250-F-2**-u-z-vv: u: **L** (Low radio), **H** (High radio); z: **G** (Grey), **C** (Charcoal Gray); vv: (Supply voltage) **AC** or **DC**

### 3.3 Technical information

---

Frequency band	57–64 GHz
Frequency Min	58.275 GHz (Low radio), 61.775 GHz (High radio)
Frequency Max	59.275 GHz (Low radio), 62.775 GHz (High radio)
Channel BW	250 MHz
Type of modulation	4-QAM, 16-QAM, 32-QAM, 64-QAM and 128-QAM
Emission classification (F1D, G1D, D1D)	W7D
Power requirements	AC: 90–240 V <sub>AC</sub> 50/60 Hz or DC: –40.5 to –60 V <sub>DC</sub>
Antenna information	Internal proprietary antenna with 34 dBi gain The EUT is professionally installed.

### 3.4 Product description and theory of operation

---

StreetNode 6250 PTP is an innovative compact all-outdoor native packet radio operating in the 57–64 GHz band (V-Band). It can be used to implement highly-flexible Point-to-Point Microwave (PtP MW) backhaul topologies, reaching challenging small-cell locations and delivering best-in-class connectivity at street level. StreetNode™ 6250 PTP satisfies every critical aspect of 3G and 4G/LTE/LTE-A small-cell backhaul, providing high capacity, low latency, automated provisioning and high availability, while optimizing the small-cell business case economics.

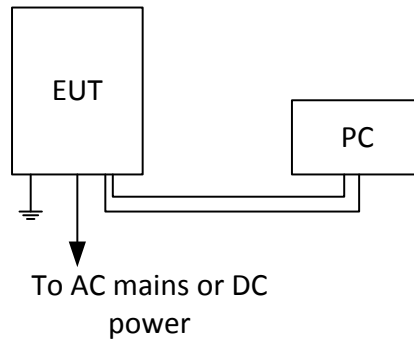
### 3.5 EUT exercise details

---

EUT was controlled from PC using Windows Terminal to set the transmission on desired channel and modulation type.

### 3.6 EUT setup diagram

---



*Figure 3.6-1: Setup diagram*

## Section 4. Engineering considerations

---

### 4.1 Modifications incorporated in the EUT

---

There were no modifications performed to the EUT during this assessment.

### 4.2 Technical judgment

---

None

### 4.3 Deviations from laboratory tests procedures

---

No deviations were made from laboratory procedures.



## Section 5. Test conditions

---

### 5.1 Atmospheric conditions

---

Temperature	15–30 °C
Relative humidity	20–75 %
Air pressure	860–1060 mbar

---

When it is impracticable to carry out tests under these conditions, a note to this effect stating the ambient temperature and relative humidity during the tests shall be recorded and stated.

### 5.2 Power supply range

---

The normal test voltage for equipment to be connected to the mains shall be the nominal mains voltage. For the purpose of the present document, the nominal voltage shall be the declared voltage, or any of the declared voltages  $\pm 5\%$ , for which the equipment was designed.

## Section 6. Measurement uncertainty

---

### 6.1 Uncertainty of measurement

---

Measurement uncertainty budgets for the tests are detailed below. Measurement uncertainty calculations assume a coverage factor of  $K = 2$  with 95% certainty.

Test name	Measurement uncertainty, dB
All antenna port measurements	0.55
Conducted spurious emissions	1.13
Radiated spurious emissions	3.78
AC power line conducted emissions	3.55

## Section 7. Test equipment

### 7.1 Test equipment list

*Table 7.1-1: Equipment list*

Equipment	Manufacturer	Model no.	Asset no.	Cal cycle	Next cal.
3 m EMI test chamber	TDK	SAC-3	FA002047	1 year	Dec. 01/16
Flush mount turntable	Sunol	FM2022	FA002082	—	NCR
Controller	Sunol	SC104V	FA002060	—	NCR
Antenna mast	Sunol	TLT2	FA002061	—	NCR
Power source	California Instruments	3001i	FA001021	1 year	Aug. 27/16
LISN	Rohde & Schwarz	ENV216	FA002023	1 year	Mar. 08/17
Receiver/spectrum analyzer	Rohde & Schwarz	ESU 26	FA002043	1 year	Jan. 07/17
Bilog antenna (20–3000 MHz)	Sunol	JB3	FA002108	1 year	Apr. 12/16
Horn antenna (1–18 GHz)	EMCO	3115	FA000825	1 year	Apr. 01/16
Pre-amplifier (1–18 GHz)	JCA	JCA118-503	FA002091	1 year	May 05/16
Pre-amplifier (18–26 GHz)	Narda	BBS-1826N612	FA001550	—	VOU
Pre-amplifier (26–40 GHz)	Narda	DBL-2640N610	FA001556	—	VOU
Horn antenna (18–26.5 GHz)	Electro-metrics	SH-50/60-1	FA000479	—	VOU
Horn antenna (26.5–40 GHz)	Electro-metrics	SH-50/60-2	FA000485	—	VOU
40–60 GHz Harmonic mixer	OML	WR19 M19HWD	FA002322	—	VOU
40–60 GHz Standard gain horn	Millitech	U SGH-19	FA002322	—	VOU
60–90 GHz Harmonic mixer	OML	WR12 M12HWD	FA001524	—	VOU
60–90 GHz Standard gain horn	Millitech	U SGH-12	FA001524	—	VOU
90–140 GHz Harmonic mixer	OML	WR08 M08HWD	FA001525	—	VOU
90–140 GHz Standard gain horn	Millitech	U SGH-08	FA001525	—	VOU
140–220 GHz Harmonic mixer	OML	WR05 M05HWD	FA001526	—	VOU
140–220 GHz Standard gain horn	Millitech	U SGH-05	FA001526	—	VOU
Temperature chamber	Thermotron	SM-16C	FA001030	—	NCR
Oscilloscope	Tektronix	TDS3032	FA002543	1 year	Dec. 04/16
Broadband diode detector	QStar	QEA-FBFBVP	1416007	—	NCR
Power meter	Agilent	N1911A	FA001946	1 year	Apr. 07/17
Waveguide power sensor 50–75 GHz	Keysight	ATV8486A	MY54470006	1 year	Mar 28/17

Note: NCR - no calibration required, VOU - verify on use

## Section 8. Testing data

### 8.1 FCC 15.207(a) AC power line conducted emissions limits

#### 8.1.1 Definitions and limits

Except as shown in paragraphs (b) and (c) of this section, for an intentional radiator that is designed to be connected to the public utility (AC) power line, the radio frequency voltage that is conducted back onto the AC power line on any frequency or frequencies, within the band 150 kHz to 30 MHz, shall not exceed the limits in the following table, as measured using a 50  $\mu$ H/50  $\Omega$  line impedance stabilization network (LISN). Compliance with the provisions of this paragraph shall be based on the measurement of the radio frequency voltage between each power line and ground at the power terminal. The lower limit applies at the boundary between the frequency ranges.

**Table 8.1-1: Conducted emissions limit**

Frequency of emission, MHz	Conducted limit, dB $\mu$ V	
	Quasi-peak	Average**
0.15–0.5	66 to 56*	56 to 46*
0.5–5	56	46
5–30	60	50

Note: \* - The level decreases linearly with the logarithm of the frequency.

\*\* - A linear average detector is required.

#### 8.1.2 Test summary

Test date	April 5, 2016	Temperature	22 °C
Test engineer	Andrey Adelberg	Air pressure	1010 mbar
Verdict	Pass	Relative humidity	32 %

### 8.1.3 Observations, settings and special notes

---

The EUT was set up as tabletop configuration.

The spectral scan has been corrected with transducer factors (i.e. cable loss, LISN factors, and attenuators) for determination of compliance.

A preview measurement was generated with the receiver in continuous scan mode. Emissions detected within 6 dB or above limit were re-measured with the appropriate detector against the correlating limit and recorded as the final measurement.

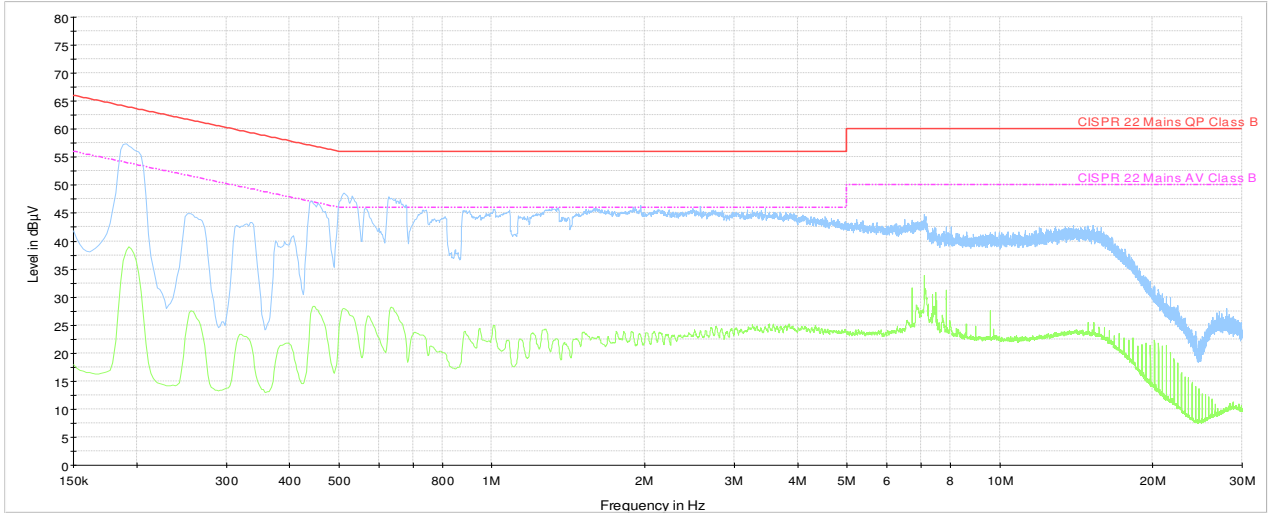
Receiver settings for preview measurements:

Resolution bandwidth	9 kHz
Video bandwidth	30 kHz
Detector mode	Peak and Average
Trace mode	Max Hold
Measurement time	1000 ms

Receiver settings for final measurements:

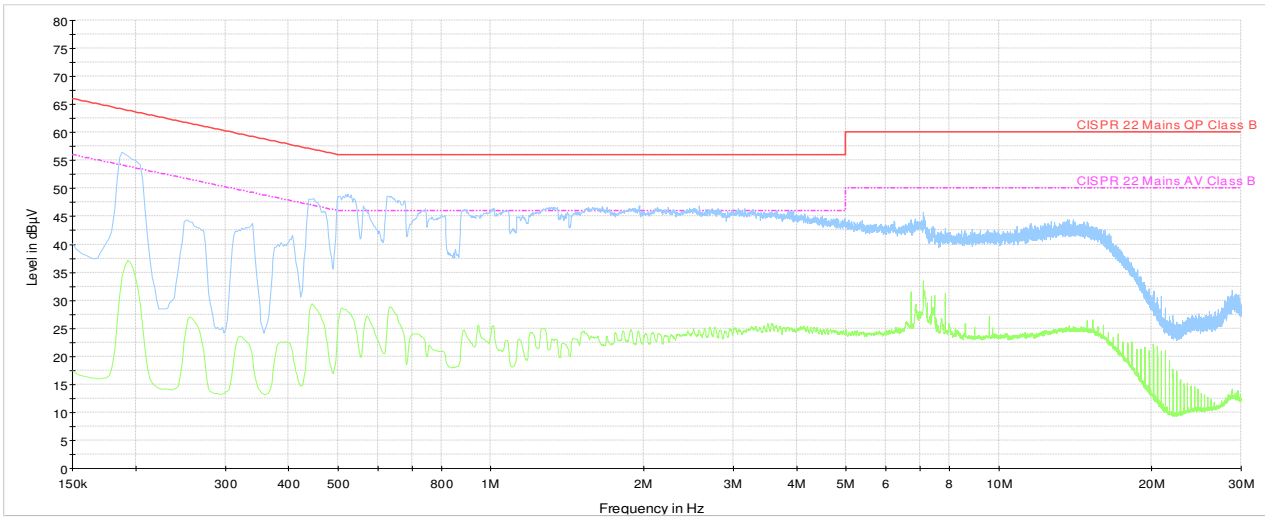
Resolution bandwidth	9 kHz
Video bandwidth	30 kHz
Detector mode	Quasi-Peak and Average
Trace mode	Max Hold
Measurement time	1000 ms

8.1.4 Test data



STN6250 CE Phase 120 Vac 60 Hz FCC Class A SN 130  
 — CISPR 22 Mains OP Class B  
 - - - CISPR 22 Mains AV Class B  
 — Preview Result 1-PK+  
 — Preview Result 2-AVG

**Plot 8.1-1:** Conducted emissions on phase line



STN6250 CE Neutral 120 Vac 60 Hz FCC Class A SN 130  
 — CISPR 22 Mains OP Class B  
 - - - CISPR 22 Mains AV Class B  
 — Preview Result 1-PK+  
 — Preview Result 2-AVG

**Plot 8.1-2:** Conducted emissions on neutral line

## 8.2 FCC 15.255(b) and (e) Conducted output power and EIRP requirements

---

### 8.2.1 Definitions and limits

---

(b) Within the 57–64 GHz band, emission levels shall not exceed the following equivalent isotropically radiated power (EIRP):

(1) Products other than fixed field disturbance sensors shall comply with one of the following emission limits, as measured during the transmit interval:

(i) Except as indicated in paragraph (b)(1)(ii) of this section, the average power of any emission shall not exceed 40 dBm and the peak power of any emission shall not exceed 43 dBm.

(ii) For transmitters located outdoors, the average power of any emission shall not exceed 82 dBm minus 2 dB for every dB that the antenna gain is less than 51 dBi. The peak power of any emission shall not exceed 85 dBm minus 2 dB for every dB that the antenna gain is less than 51 dBi. The provisions of §15.204(c)(2) and (c)(4) of this part that permit the use of different antennas of the same type and of equal or less directional gain do not apply to intentional radiator systems operating under this provision. In lieu thereof, intentional radiator systems shall be certified using the specific antenna(s) with which the system will be marketed and operated. Compliance testing shall be performed using the highest gain and the lowest gain antennas for which certification is sought and with the intentional radiator operated at its maximum available output power level. The responsible party, as defined in §2.909 of this chapter, shall supply a list of acceptable antennas with the application for certification.

(4) The peak power shall be measured with an RF detector that has a detection bandwidth that encompasses the 57–64 GHz band and has a video bandwidth of at least 10 MHz. The average emission levels shall be calculated based on the measured peak levels, over the actual time period during which transmission occurs. Measurement procedures that have been found to be acceptable to the Commission in accordance with §2.947 of this chapter may be used to demonstrate compliance.

(e) Except as specified paragraph (e)(1) of this section, the peak transmitter conducted output power shall not exceed 500 mW. Depending on the gain of the antenna, it may be necessary to operate the intentional radiator using a lower peak transmitter output power in order to comply with the EIRP limits specified in paragraph (b) of this section.

(1) Transmitters with an emission bandwidth of less than 100 MHz must limit their peak transmitter conducted output power to the product of 500 mW times their emission bandwidth divided by 100 MHz. For the purposes of this paragraph, emission bandwidth is defined as the instantaneous frequency range occupied by a steady state radiated signal with modulation, outside which the radiated power spectral density never exceeds 6 dB below the maximum radiated power spectral density in the band, as measured with a 100 kHz resolution bandwidth spectrum analyzer. The center frequency must be stationary during the measurement interval, even if not stationary during normal operation (e.g., for frequency hopping devices).

(2) Peak transmitter conducted output power shall be measured with an RF detector that has a detection bandwidth that encompasses the 57–64 GHz band and that has a video bandwidth of at least 10 MHz. Measurement procedures that have been found to be acceptable to the Commission in accordance with §2.947 of this chapter may be used to demonstrate compliance.

(3) For purposes of demonstrating compliance with this paragraph, corrections to the transmitter conducted output power may be made due to the antenna and circuit loss.

### 8.2.2 Test summary

---

Test date	March 31, 2016	Temperature	22 °C
Test engineer	Andrey Adelberg	Air pressure	1005 mbar
Verdict	Pass	Relative humidity	32 %

### 8.2.3 Observations, settings and special notes

---

EUT is an outdoor device with an emission bandwidth of more than 100 MHz. Average EIRP limit was calculated as follows:  $82 \text{ dBm} - 2 \times (51 \text{ dBi} - 34 \text{ dBi}) = 48 \text{ dBm}$ .

8.2.4 Test data

**Table 8.2-1:** Conducted average output power and EIRP results for SN6250-F-2-L-G-AC with 4-QAM modulation

Frequency, GHz	Average output power, dBm	Antenna gain, dBi	EIRP, dBm	Average EIRP limit, dBm	Margin, dB
58.275	12.90	34.00	46.90	48.00	1.10
58.775	12.96	34.00	46.96	48.00	1.04
59.275	12.58	34.00	46.58	48.00	1.42

**Table 8.2-2:** Conducted peak output power results for SN6250-F-2-L-G-AC with 4-QAM modulation

Frequency, GHz	Peak output power, dBm	Peak output power limit, dBm	Margin, dB
58.275	13.65	27.00	13.35
58.775	13.71	27.00	13.29
59.275	13.33	27.00	13.67

**Table 8.2-3:** Conducted average output power and EIRP results for SN6250-F-2-L-G-AC with 128-QAM modulation

Frequency, GHz	Average output power, dBm	Antenna gain, dBi	EIRP, dBm	Average EIRP limit, dBm	Margin, dB
58.275	10.35	34.00	44.35	48.00	3.65
58.775	10.22	34.00	44.22	48.00	3.78
59.275	9.97	34.00	43.97	48.00	4.03

**Table 8.2-4:** Conducted peak output power results for SN6250-F-2-L-G-AC with 128-QAM modulation

Frequency, GHz	Peak output power, dBm	Peak output power limit, dBm	Margin, dB
58.275	11.10	27.00	15.90
58.775	10.97	27.00	16.03
59.275	10.72	27.00	16.28

**Table 8.2-5:** Peak to average ratio measurement for low radio, example

Measured average output power, dBm	Average power, mW	Average voltage, mV	Peak voltage, mV	Peak power, mW	Peak power, dBm	Peak to average ratio, dB
12.96	19.77	227.25	270.06	23.49	13.71	0.75



**Table 8.2-6:** Conducted average output power and EIRP results for SN6250-F-2-H-G-DC with 4-QAM modulation

Frequency, GHz	Average output power, dBm	Antenna gain, dBi	EIRP, dBm	Average EIRP limit, dBm	Margin, dB
61.775	10.18	34.00	44.18	48.00	3.82
62.275	9.95	34.00	43.95	48.00	4.05
62.775	9.52	34.00	43.52	48.00	4.48

**Table 8.2-7:** Conducted peak output power results for SN6250-F-2-H-G-DC with 4-QAM modulation

Frequency, GHz	Peak output power, dBm	Peak output power limit, dBm	Margin, dB
61.775	10.68	27.00	16.32
62.275	10.45	27.00	16.55
62.775	10.02	27.00	16.98

**Table 8.2-8:** Conducted average output power and EIRP results for SN6250-F-2-H-G-DC with 128-QAM modulation

Frequency, GHz	Average output power, dBm	Antenna gain, dBi	EIRP, dBm	Average EIRP limit, dBm	Margin, dB
61.775	6.88	34.00	40.88	48.00	7.12
62.275	6.60	34.00	40.60	48.00	7.40
62.775	6.37	34.00	40.37	48.00	7.63

**Table 8.2-9:** Conducted peak output power results for SN6250-F-2-H-G-DC with 128-QAM modulation

Frequency, GHz	Peak output power, dBm	Peak output power limit, dBm	Margin, dB
61.775	7.38	27.00	19.62
62.275	7.10	27.00	19.90
62.775	6.87	27.00	20.13

**Table 8.2-10:** Peak to average ratio measurement for high radio, example

Measured average output power, dBm	Average power, mW	Average voltage, mV	Peak voltage, mV	Peak power, mW	Peak power, dBm	Peak to average ratio, dB
10.18	10.42	176.85	198.29	11.69	10.68	0.50

## 8.3 FCC 15.255(c) Limits on spurious emissions

### 8.3.1 Definitions and limits

- (1) The power density of any emissions outside the 57–64 GHz band shall consist solely of spurious emissions.
- (2) Radiated emissions below 40 GHz shall not exceed the general limits in §15.209.
- (3) Between 40 GHz and 200 GHz, the level of these emissions shall not exceed 90 pW/cm<sup>2</sup> (85.3 dBμV/m) at a distance of 3 meters.
- (4) The levels of the spurious emissions shall not exceed the level of the fundamental emission.
- (d) Only spurious emissions and transmissions related to a publicly-accessible coordination channel, whose purpose is to coordinate operation between diverse transmitters with a view towards reducing the probability of interference throughout the 57–64 GHz band, are permitted in the 57–57.05 GHz band.

**Table 8.3-1: FCC §15.209 – Radiated emission limits**

Frequency, MHz	Field strength of emissions		Measurement distance, m
	μV/m	dBμV/m	
30–88	100	40.0	3
88–216	150	43.5	3
216–960	200	46.0	3
above 960	500	54.0	3

Notes: In the emission table above, the tighter limit applies at the band edges.

For frequencies above 1 GHz the limit on peak RF emissions is 20 dB above the maximum permitted average emission limit applicable to the equipment under test

**Table 8.3-2: FCC restricted frequency bands**

MHz	MHz	MHz	GHz
0.090–0.110	16.42–16.423	399.9–410	4.5–5.15
0.495–0.505	16.69475–16.69525	608–614	5.35–5.46
2.1735–2.1905	16.80425–16.80475	960–1240	7.25–7.75
4.125–4.128	25.5–25.67	1300–1427	8.025–8.5
4.17725–4.17775	37.5–38.25	1435–1626.5	9.0–9.2
4.20725–4.20775	73–74.6	1645.5–1646.5	9.3–9.5
6.215–6.218	74.8–75.2	1660–1710	10.6–12.7
6.26775–6.26825	108–121.94	1718.8–1722.2	13.25–13.4
6.31175–6.31225	123–138	2200–2300	14.47–14.5
8.291–8.294	149.9–150.05	2310–2390	15.35–16.2
8.362–8.366	156.52475–156.52525	2483.5–2500	17.7–21.4
8.37625–8.38675	156.7–156.9	2690–2900	22.01–23.12
8.41425–8.41475	162.0125–167.17	3260–3267	23.6–24.0
12.29–12.293	167.72–173.2	3332–3339	31.2–31.8
12.51975–12.52025	240–285	3345.8–3358	36.43–36.5
12.57675–12.57725	322–335.4	3600–4400	Above 38.6
13.36–13.41			

### 8.3.2 Test summary

Test date	March 29, 2016	Temperature	21 °C
Test engineer	Andrey Adelberg	Air pressure	1008 mbar
Verdict	Pass	Relative humidity	32 %

### 8.3.3 Observations, settings and special notes

The spectrum was searched from 30 MHz to the 220 GHz.  
 Radiated measurements were performed at a distance of 3 m for frequencies below 40 GHz and 30 cm for frequencies above 40 GHz.  
 Limit line calculation for frequencies above 40 GHz:  $85.3 \text{ dB}\mu\text{V/m} + 20 \times \text{Log}(3/0.3) = 85.3 + 20 \text{ dB} = 105.3 \text{ dB}\mu\text{V/m}$

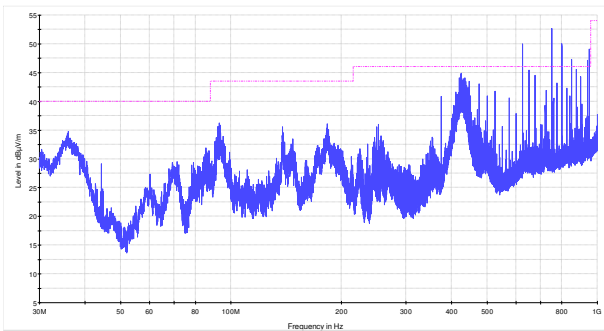
Spectrum analyser settings for radiated measurements within restricted bands below 1 GHz:

Resolution bandwidth	100 kHz
Video bandwidth	300 kHz
Detector mode	Peak
Trace mode	Max Hold

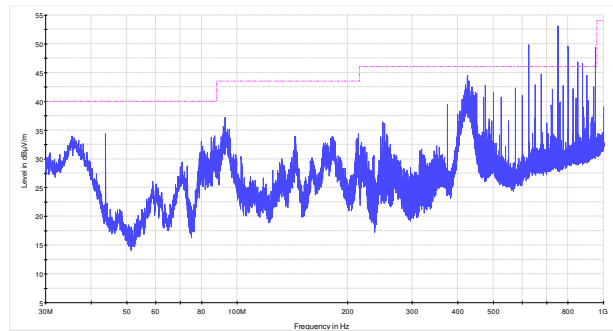
Spectrum analyser settings for peak radiated measurements within restricted bands above 1 GHz:

Resolution bandwidth	1 MHz
Video bandwidth	3 MHz
Detector mode	Peak
Trace mode	Max Hold

### 8.3.4 Test data

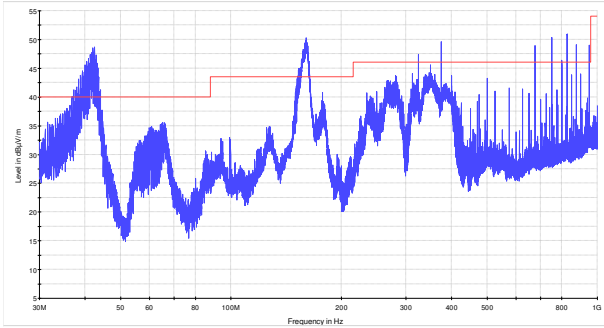


**Figure 8.3-1:** Spurious emissions below 1 GHz for SN6250-F-2-L-G-AC, transmitter turned on

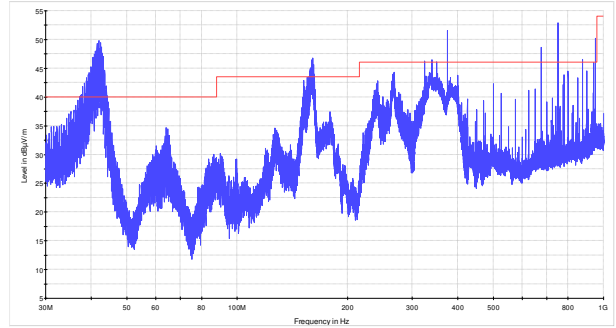


**Figure 8.3-2:** Spurious emissions below 1 GHz for SN6250-F-2-L-G-AC, transmitter turned off

Note: EUT is a Class A equipment for unintentional radiation. All radiated peaks measured and shown on the plots above are digital emissions and therefore exempt from the requirements of RF spurious emissions.

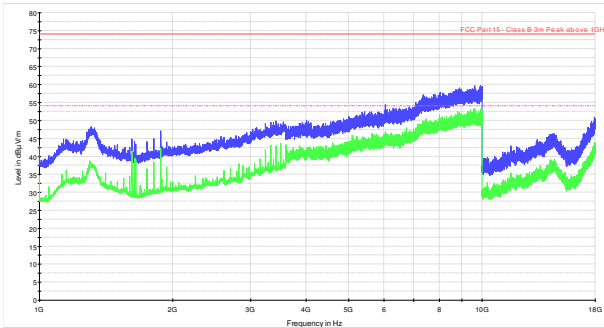


**Figure 8.3-3:** Spurious emissions below 1 GHz for SN6250-F-2-H-G-DC, transmitter turned on

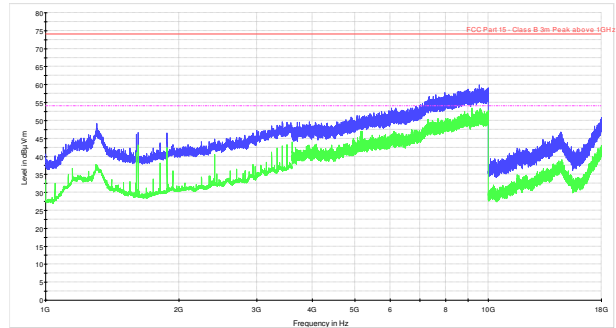


**Figure 8.3-4:** Spurious emissions below 1 GHz for SN6250-F-2-H-G-DC, transmitter turned off

Note: EUT is a Class A equipment for unintentional radiation. All radiated peaks measured and shown on the plots above are digital emissions and therefore exempt from the requirements of RF spurious emissions.

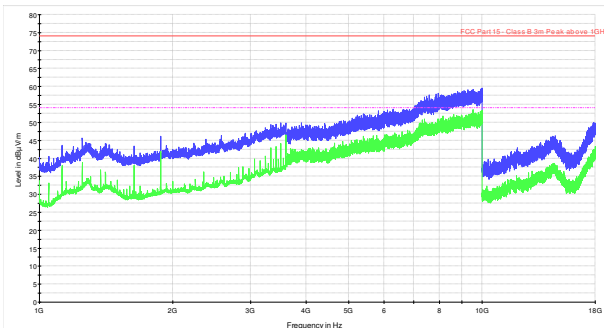


**Figure 8.3-5:** Spurious emissions within 1–18 GHz for SN6250-F-2-L-G-AC, transmitter turned on

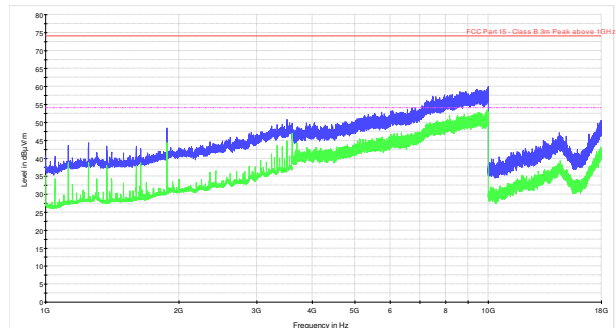


**Figure 8.3-6:** Spurious emissions within 1–18 GHz for SN6250-F-2-L-G-AC, transmitter turned off

Note: EUT is a Class A equipment for unintentional radiation. All radiated peaks measured and shown on the plots above are digital emissions and therefore exempt from the requirements of RF spurious emissions.

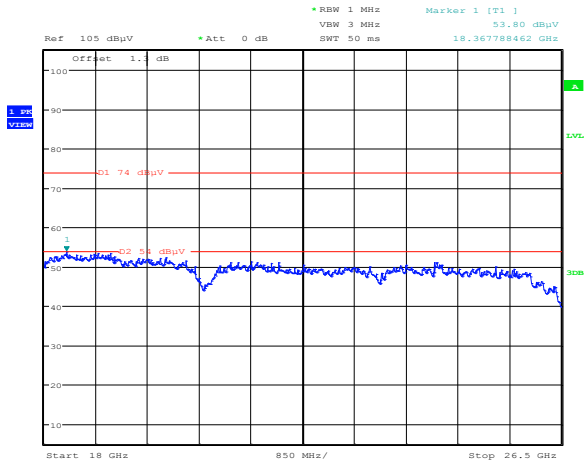


**Figure 8.3-7:** Spurious emissions within 1–18 GHz for SN6250-F-2-H-G-DC, transmitter turned on



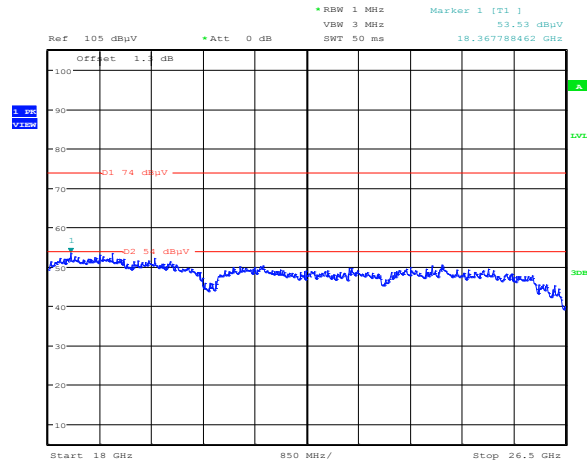
**Figure 8.3-8:** Spurious emissions within 1–18 GHz for SN6250-F-2-H-G-DC, transmitter turned off

Note: EUT is a Class A equipment for unintentional radiation. All radiated peaks measured and shown on the plots above are digital emissions and therefore exempt from the requirements of RF spurious emissions.



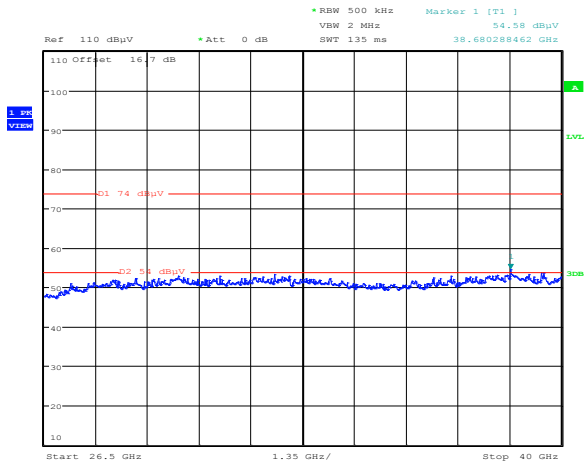
Date: 29.MAR.2016 15:34:04

Figure 8.3-9: Spurious emissions within 18–26.5 GHz for SN6250-F-2-L-G-AC



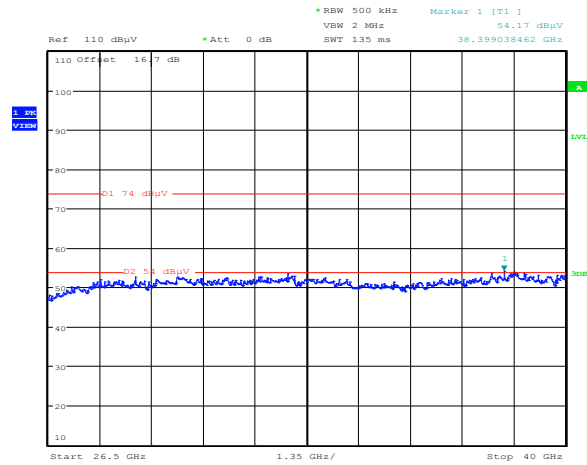
Date: 29.MAR.2016 15:41:33

Figure 8.3-10: Spurious emissions within 18–26.5 GHz for SN6250-F-2-H-G-DC



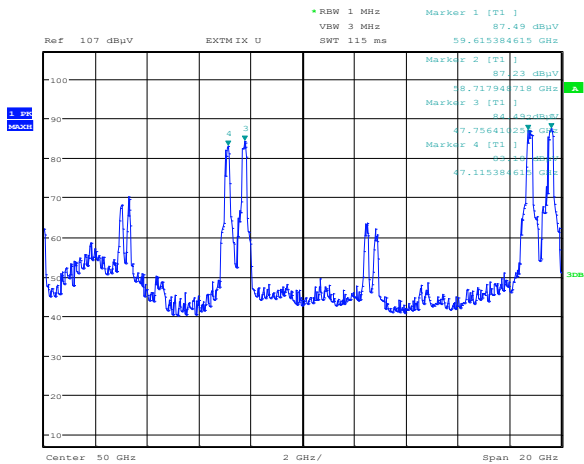
Date: 29.MAR.2016 16:24:32

Figure 8.3-11: Spurious emissions within 26.5–40 GHz for SN6250-F-2-L-G-AC



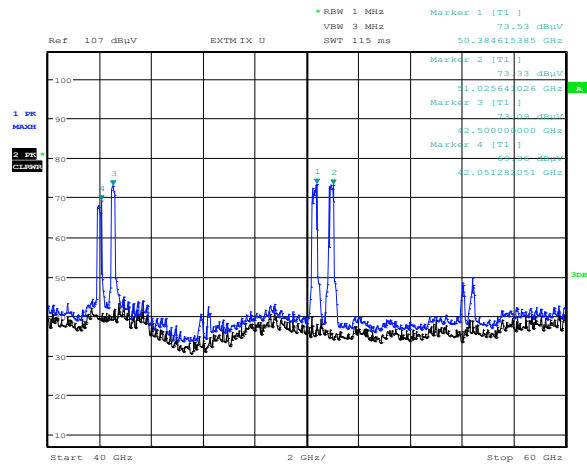
Date: 29.MAR.2016 16:12:45

Figure 8.3-12: Spurious emissions within 26.5–40 GHz for SN6250-F-2-H-G-DC



Date: 31.MAR.2016 18:47:51

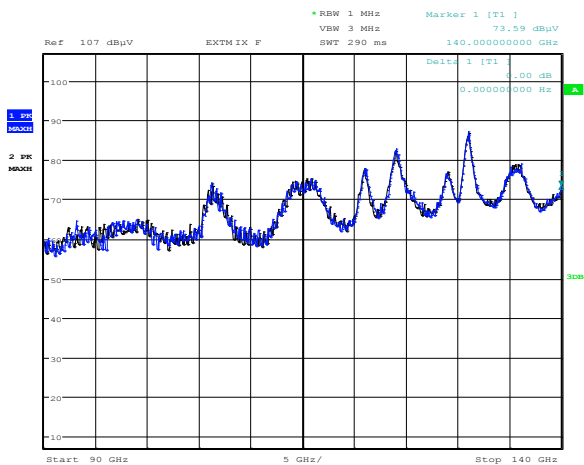
Figure 8.3-13: Spurious emissions within 40–60 GHz for SN6250-F-2-L-G-AC



Date: 31.MAR.2016 19:59:39

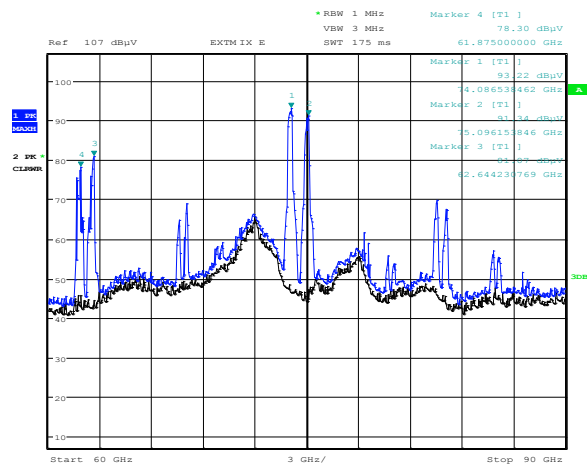
Figure 8.3-14: Spurious emissions within 40–60 GHz for SN6250-F-2-H-G-DC

Note: The pairs of spurs in the plots are the image of the intermodulation products of the external mixer (except for fundamental peak). These are not actual emissions of the EUT. It was verified that there were no detectable spurious emissions between 40 GHz to 220 GHz (out-band).



Date: 31.MAR.2016 18:33:45

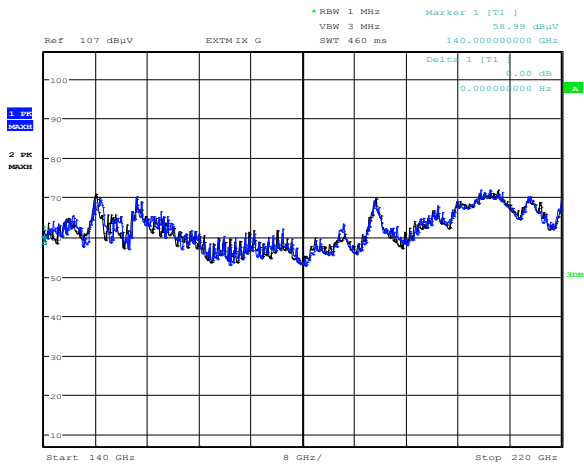
Figure 8.3-15: Spurious emissions within 90–140 GHz for SN6250-F-2-L-G-AC



Date: 31.MAR.2016 20:13:02

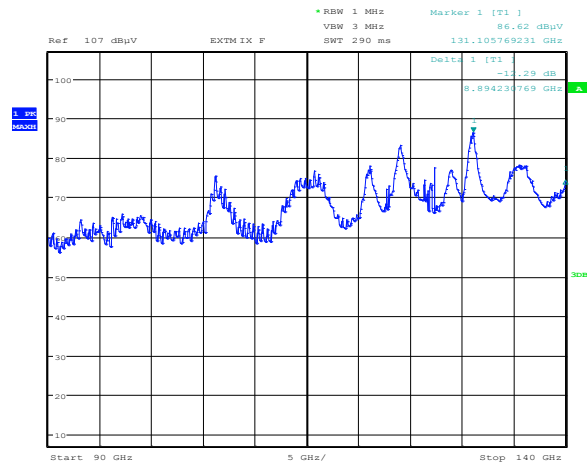
Figure 8.3-16: Spurious emissions within 60–90 GHz for SN6250-F-2-H-G-DC

Note: It was verified that there were no detectable spurious emissions between 40 GHz to 220 GHz (out-band).



Date: 31.MAR.2016 18:38:20

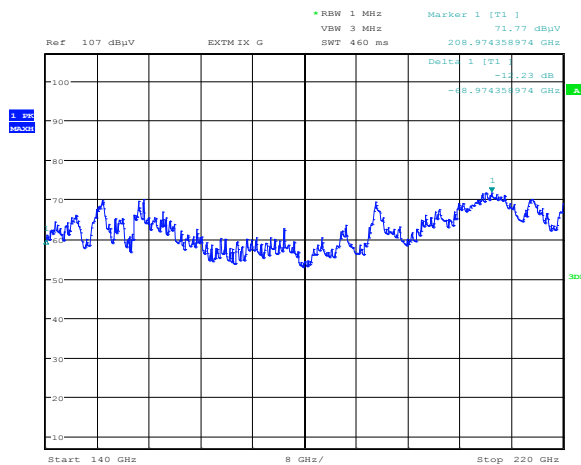
Figure 8.3-17: Spurious emissions within 140–220 GHz for STN6250 F-2-L-C-AC



Date: 31.MAR.2016 19:53:37

Figure 8.3-18: Spurious emissions within 90–140 GHz for SN6250-F-2-H-G-DC

Note: It was verified that there were no detectable spurious emissions between 40 GHz to 220 GHz (out-band).



Date: 31.MAR.2016 19:49:09

Figure 8.3-19: Spurious emissions within 140–220 GHz for SN6250-F-2-H-G-DC

Note: It was verified that there were no detectable spurious emissions between 40 GHz to 220 GHz (out-band).

## 8.4 FCC 15.255(e)(1) 6 dB bandwidth

### 8.4.1 Definitions and limits

(e)(1) Transmitters with an emission bandwidth of less than 100 MHz must limit their peak transmitter conducted output power to the product of 500 mW times their emission bandwidth divided by 100 MHz. For the purposes of this paragraph, emission bandwidth is defined as the instantaneous frequency range occupied by a steady state radiated signal with modulation, outside which the radiated power spectral density never exceeds 6 dB below the maximum radiated power spectral density in the band, as measured with a 100 kHz resolution bandwidth spectrum analyzer. The center frequency must be stationary during the measurement interval, even if not stationary during normal operation (e.g., for frequency hopping devices).

### 8.4.2 Test summary

Test date:	April 1, 2016	Temperature:	22 °C
Test engineer:	Andrey Adelberg	Air pressure:	1008 mbar
Verdict:	Pass	Relative humidity:	32 %

### 8.4.3 Observations, settings and special notes

Spectrum analyser settings:

Resolution bandwidth	100 kHz
Video bandwidth	$\geq 3 \times \text{RBW}$
Frequency span	Wider than emission bandwidth
Detector mode	Peak

### 8.4.4 Test data

**Table 8.4-1:** 6 dB bandwidth measurement results for SN6250-F-2-L-G-AC with 4-QAM modulation

Frequency, GHz	6 dB bandwidth, MHz	High power minimum limit, MHz	Margin, MHz
58.275	233.974	100.000	133.974
58.775	232.372	100.000	132.372
59.275	203.525	100.000	103.525

**Table 8.4-2:** 6 dB bandwidth measurement results for SN6250-F-2-L-G-AC with 128-QAM modulation

Frequency, GHz	6 dB bandwidth, MHz	High power minimum limit, MHz	Margin, MHz
58.275	228.365	100.000	128.365
58.775	235.577	100.000	135.577
59.275	185.897	100.000	85.897

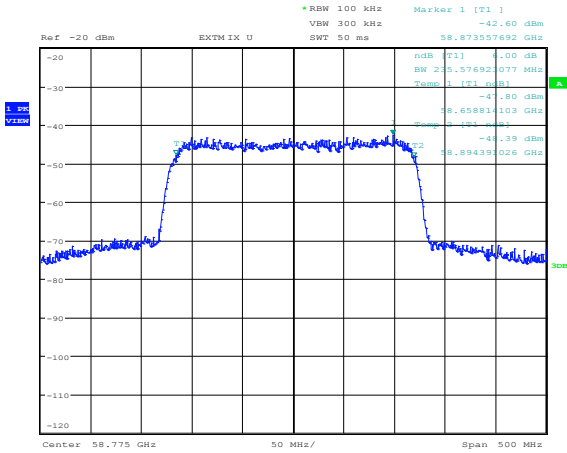
**Table 8.4-3:** 6 dB bandwidth measurement results for SN6250-F-2-H-G-DC with 4-QAM modulation

Frequency, GHz	6 dB bandwidth, MHz	High power minimum limit, MHz	Margin, MHz
61.775	113.782	100.000	13.782
62.275	230.769	100.000	130.769
62.775	237.179	100.000	137.179



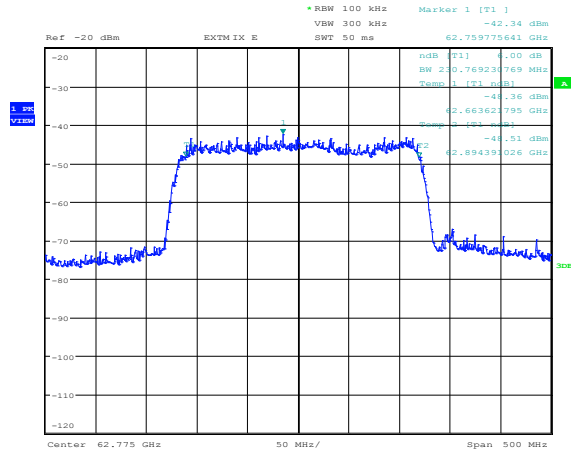
**Table 8.4-4:** 6 dB bandwidth measurement results for SN6250-F-2-H-G-DC with 128-QAM modulation

Frequency, GHz	6 dB bandwidth, MHz	High power minimum limit, MHz	Margin, MHz
61.775	137.821	100.000	37.821
62.275	226.763	100.000	126.763
62.775	230.769	100.000	130.769



Date: 1.APR.2016 11:08:09

**Figure 8.4-1:** 6 dB occupied bandwidth on SN6250-F-2-L-G-AC



Date: 1.APR.2016 11:19:10

**Figure 8.4-2:** 6 dB occupied bandwidth on SN6250-F-2-H-G-DC

## 8.5 FCC 15.255(f) Frequency stability

### 8.5.1 Definitions and limits

Fundamental emissions must be contained within the frequency bands specified in this section during all conditions of operation. Equipment is presumed to operate over the temperature range -20 to + 50 degrees Celsius with an input voltage variation of 85% to 115% of rated input voltage, unless justification is presented to demonstrate otherwise.

### 8.5.2 Test summary

Test date	March 31, 2016	Temperature	22 °C
Test engineer	Andrey Adelberg	Air pressure	1008 mbar
Verdict	Pass	Relative humidity	31 %

### 8.5.3 Observations, settings and special notes

**Low radio:**

Lower channel band edge was calculated as follows: 58.275 GHz – half of declared (250 MHz) channel bandwidth.  
 Upper channel band edge was calculated as follows: 59.275 GHz + half of declared (250 MHz) channel bandwidth.

**High radio:**

Lower channel band edge was calculated as follows: 61.775 GHz – half of declared (250 MHz) channel bandwidth.  
 Upper channel band edge was calculated as follows: 62.775 GHz + half of declared (250 MHz) channel bandwidth.

### 8.5.4 Test data

**Table 8.5-1: Frequency drift measurement for Low radio**

Test conditions	Frequency, GHz	Drift, kHz
+50 °C, 120 V <sub>AC</sub>	58.275028205	28.205
+40 °C, 120 V <sub>AC</sub>	58.274909615	-90.385
+30 °C, 120 V <sub>AC</sub>	58.274886859	-113.141
+20 °C, +15 % (132 V <sub>AC</sub> )	58.274904167	-95.833
+20 °C, 120 V <sub>AC</sub>	58.274901282	-98.718
+20 °C, -15 % (108 V <sub>AC</sub> )	58.274905128	-94.872
+10 °C, 120 V <sub>AC</sub>	58.274936218	-63.782
0 °C, 120 V <sub>AC</sub>	58.275130449	130.449
-10 °C, 120 V <sub>AC</sub>	58.274945353	-54.647
-20 °C, 120 V <sub>AC</sub>	58.274794872	-205.128

Note: the drift was calculated as follows: Measured frequency – Declared frequency (58.275 GHz)

**Table 8.5-2: Lower band edge drift calculation for Low radio**

Lower channel band edge, GHz	Max negative drift, kHz	Drifted lower channel band edge, GHz	Lower band edge limit, GHz	Margin, GHz
58.150	205.128	58.1497949	57.000	1.150

Notes: Drifted lower channel band edge = Lower channel band edge – max negative drift.

**Table 8.5-3: Upper band edge drift calculation for Low radio**

Upper channel band edge, GHz	Max positive drift, kHz	Drifted upper channel band edge, GHz	Upper band edge limit, GHz	Margin, GHz
59.400	130.449	59.4001304	64.000	4.600

Notes: Drifted upper channel band edge = Upper channel band edge + max positive drift.

**Table 8.5-4: Frequency drift measurement for High radio**

Test conditions	Frequency, GHz	Drift, kHz
+50 °C, 48 V <sub>DC</sub>	62.774833974	-166.026
+40 °C, 48 V <sub>DC</sub>	62.774777885	-222.115
+30 °C, 48 V <sub>DC</sub>	62.774787821	-212.179
+20 °C, +15 % (55.2 V <sub>AC</sub> )	62.774810256	-189.744
+20 °C, 48 V <sub>DC</sub>	62.774814103	-185.897
+20 °C, -15 % (40.8 V <sub>AC</sub> )	62.774811218	-188.782
+10 °C, 48 V <sub>DC</sub>	62.774952083	-47.917
0 °C, 48 V <sub>DC</sub>	62.775040865	40.865
-10 °C, 48 V <sub>DC</sub>	62.774996795	-3.205
-20 °C, 48 V <sub>DC</sub>	62.774871795	-128.205

Note: the drift was calculated as follows: Measured frequency – Declared frequency (62.775 GHz)

**Table 8.5-5: Lower band edge drift calculation for High radio**

Lower channel band edge, GHz	Max negative drift, kHz	Drifted lower channel band edge, GHz	Lower band edge limit, GHz	Margin, GHz
61.650	222.115	61.6497779	57.000	4.650

Notes: Drifted lower channel band edge = Lower channel band edge – max negative drift.

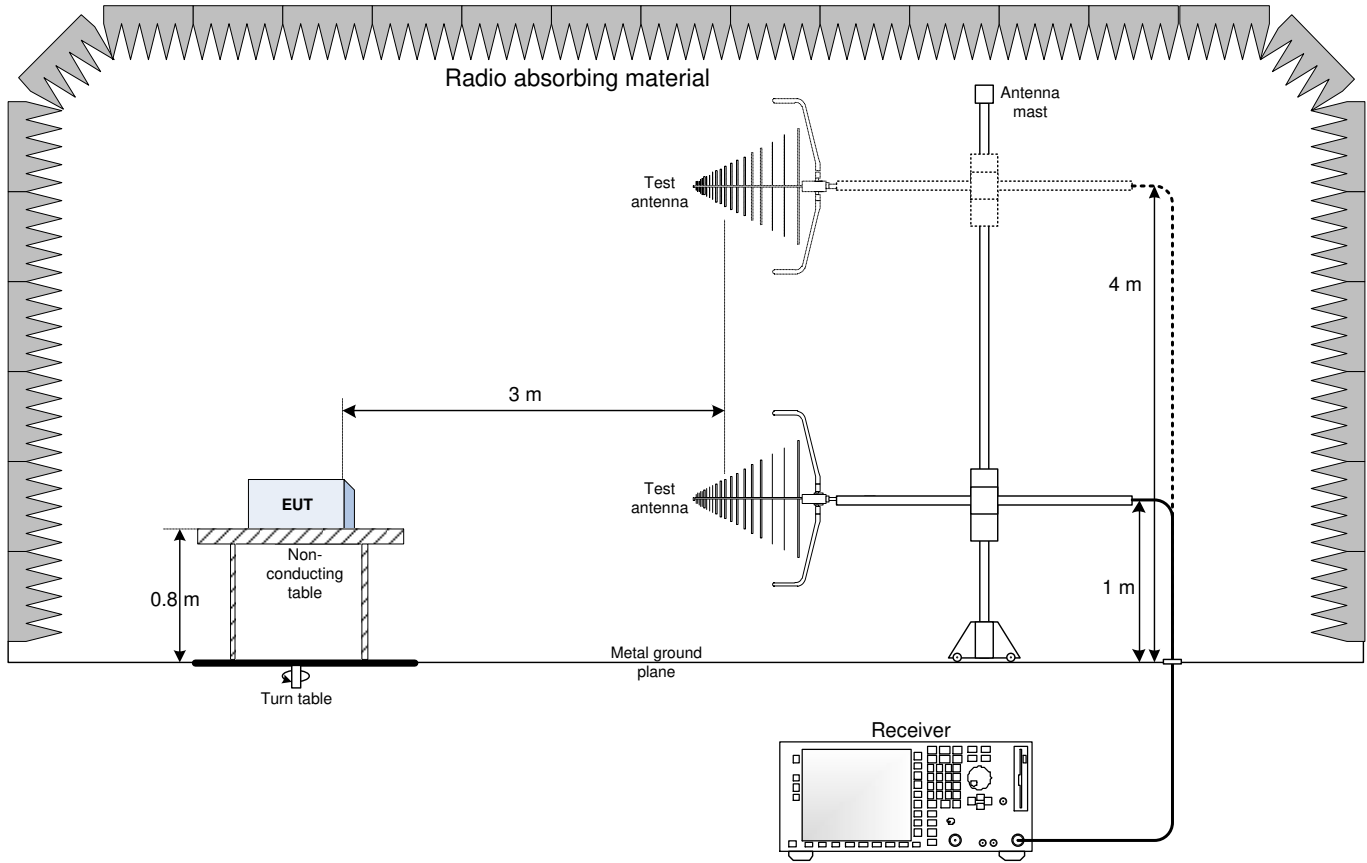
**Table 8.5-6: Upper band edge drift calculation for High radio**

Upper channel band edge, GHz	Max positive drift, kHz	Drifted upper channel band edge, GHz	Upper band edge limit, GHz	Margin, GHz
62.900	40.865	62.9000409	64.000	1.100

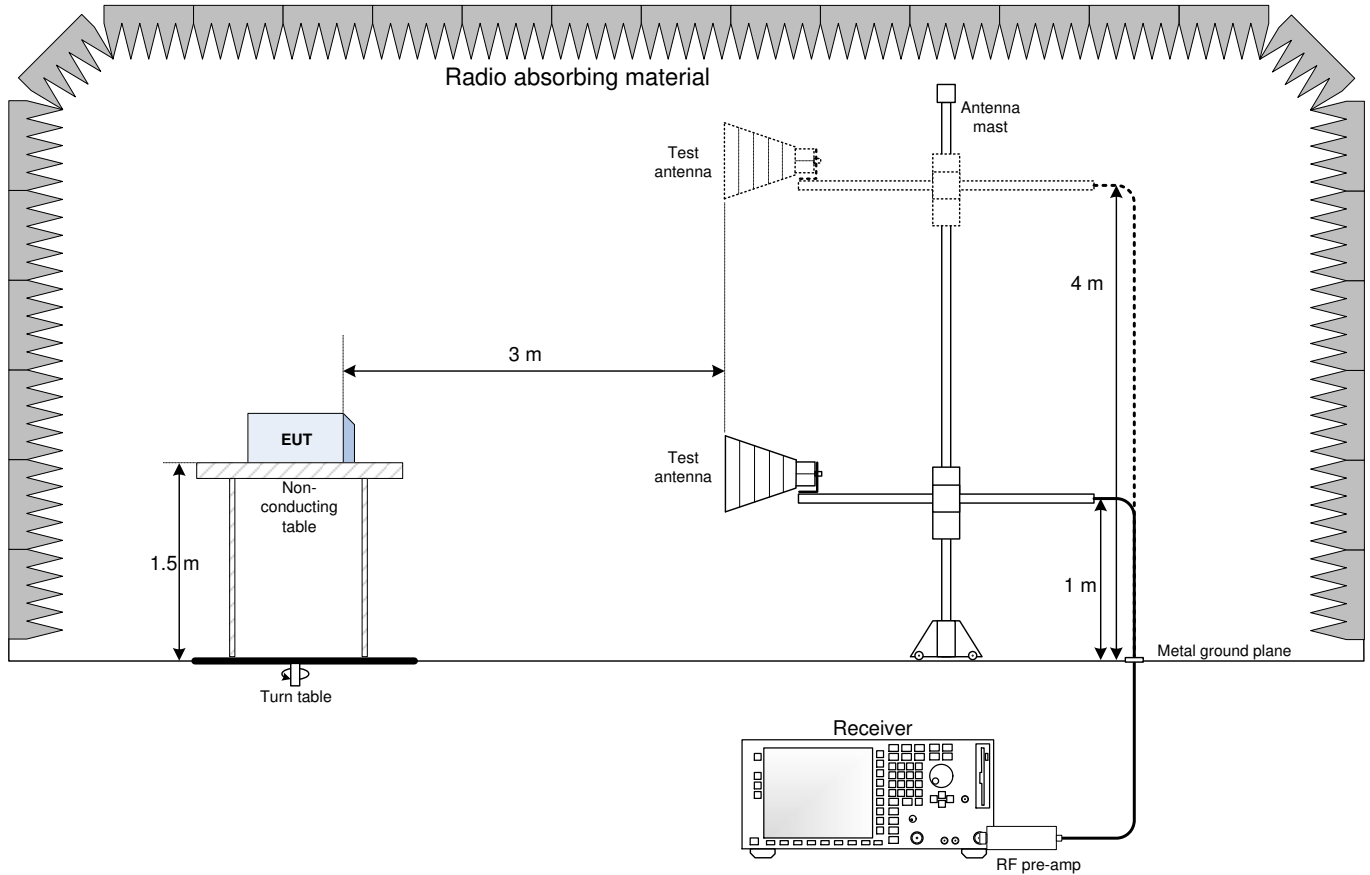
Notes: Drifted upper channel band edge = Upper channel band edge + max positive drift.

## Section 9. Block diagrams of test set-ups

### 9.1 Radiated emissions set-up for frequencies below 1 GHz



9.2 Radiated emissions set-up for frequencies above 1 GHz



9.3 Conducted emissions set-up

