

WiBAS
OSDR

WiBAS
connect



Start Up & Commissioning Manual

The information contained in this document is subject to change without prior notice.

© INTRACOM S.A. TELECOM SOLUTIONS, 2019. All rights reserved.

All copyright, intellectual and industrial rights in this document and in the technical knowledge it contains are owned by INTRACOM S.A. TELECOM SOLUTIONS and/or their respective owners.

This document is made available to the end users only for their internal use.

No part of this document nor any data herein may be published, disclosed, copied, reproduced, redistributed by any form or means, electronically or mechanically, or used for any other purpose whatsoever without the prior written approval of INTRACOM S.A. TELECOM SOLUTIONS.

Information as well as drawings and specifications contained in this document are subject to change without prior notice.

All trademarks and copyrights mentioned herein are the property of INTRACOM S.A. TELECOM SOLUTIONS and/or their respective owners.

Any rights not expressly granted herein are reserved.

Printed in Greece.

INTRACOM TELECOM

19.7 km Markopoulou Ave., Peania, Athens, GR 19002
T +30 210 667 1000, F +30 210 667 1001

<http://www.intracom-telecom.com>

[email \(product support\): wireless-support@intracom-telecom.com](mailto:wireless-support@intracom-telecom.com)

Document Revision History

Previous Edition:	5.0
Current Edition:	5.1

Reasons of Change

M = Modified, A = Added, R = Removed	Details
Configuring Operational Parameters on page 32 (M)	<ul style="list-style-type: none">• WiBAS-Connect TS (Auto-Polarization Edition) on page 38 added.
Appendix C – Quality Indicator Thresholds on page 93 (M)	Table modified.

(Page intentionally left blank)

Equipment Disposal

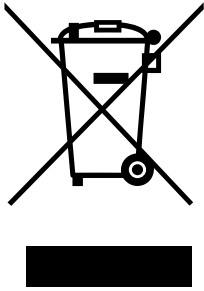

Disposal of old electrical and electronic equipment (applicable through the European Union and other European countries with separate waste collection systems).

This symbol, found on this product and any of its parts or on its operating instructions or on its packaging, indicates that electrical and electronic equipment may not be disposed of as unsorted municipal waste. Instead, this product should be handed over to applicable collection points for the recycling of electrical and electronic equipment.

By ensuring the correct disposal of this product, you will help prevent potential negative consequences to the environment and human health, which could otherwise be caused by inappropriate disposal of this product.

By recycling, reusing and other forms of recovery of old electrical and electronic equipment you are making an important contribution to the conservation of natural resources and to the protection of the environment.

For more information about the recycling of this product, please contact your local municipal authorities, municipal waste disposal service or the store where you purchased this product.

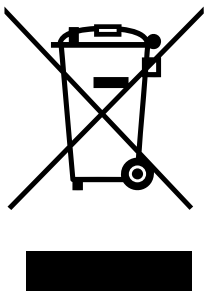

Απόρριψη παλαιών ηλεκτρικών και ηλεκτρονικών συσκευών (ισχύει στην Ευρωπαϊκή Ένωση και άλλες Ευρωπαϊκές χώρες με συστήματα χωριστής συλλογής απορριμμάτων).

Το σύμβολο αυτό, που απεικονίζεται πάνω στο προϊόν και σε τυχόν εξαρτήματα του ή στο εγχειρίδιο οδηγιών του ή στη συσκευασία του, δείχνει ότι οι ηλεκτρικές και ηλεκτρονικές συσκευές, μετά το πέρας της λειτουργίας τους, δεν θα πρέπει να απορρίπτονται μαζί με τα αστικά απόβλητα. Αντίθετα θα πρέπει να παραδίδονται σε κατάλληλα σημεία συλλογής για την ανακύκλωση των ηλεκτρικών και ηλεκτρονικών συσκευών.

Διασφαλίζοντας τη σωστή απόρριψη αυτού του προϊόντος, συνεισφέρετε στην πρόληψη πιθανών αρνητικών συνεπειών στο περιβάλλον και την ανθρώπινη υγεία, οι οποίες θα μπορούσαν να προκληθούν από την μη ενδεδειγμένη απόρριψη του προϊόντος.

Η ανακύκλωση, επαναχρησιμοποίηση και άλλες μορφές αξιοποίησης των παλαιών ηλεκτρικών και ηλεκτρονικών συσκευών βοηθούν στη διαφύλαξη των φυσικών πόρων και στην προστασία του περιβάλλοντος.

Για περισσότερες πληροφορίες σχετικά την ανακύκλωση αυτού του προϊόντος, παρακαλούμε επικοινωνήστε με τις τοπικές δημοτικές αρχές, την υπηρεσία αποκομιδής αστικών αποβλήτων ή το κατάστημα από το οποίο αγοράσατε το συγκεκριμένο προϊόν.

Για περισσότερες πληροφορίες, μπορείτε να επικοινωνείτε με το Συλλογικό Σύστημα Εναλλακτικής Διαχείρισης Αποβλήτων Ηλεκτρικού και Ηλεκτρονικού Εξοπλισμού "Ανακύκλωση Συσκευών Α.Ε." (www.electrocycle.gr).

Declaration of Conformity

English

Hereby, Intracom S.A. Telecom Solutions declares that the product **WiBAS™** is CE marked in compliance with the essential requirements and other relevant provisions of the Radio Equipment Directive 2014/53/EU, Eco Design Directives 2009/125/EC, 2010/30/EU and with the requirements of the RoHS directive 2011/65/EU.

The full text of the EU declaration of conformity is available at the following URL: <http://emc.intracom-telecom.com/en/start.htm>

Δήλωση Συμμόρφωσης

Greek

Με την παρούσα, η Intracom A.E. Τηλεπικοινωνιακών Λύσεων δηλώνει ότι το προϊόν **WiBAS™** φέρει την σήμανση CE συμμορφούμενο προς τις απαιτήσεις και τις λοιπές διατάξεις των οδηγιών Radio Equipment Directive 2014/53/EU, Eco Design Directives 2009/125/EC, 2010/30/EU καθώς και με τις απαιτήσεις της οδηγίας RoHS 2011/65/EU.

Το πλήρες κείμενο της δήλωσης συμμόρφωσης (EU) είναι διαθέσιμο στην ακόλουθη διεύθυνση URL: <http://emc.intracom-telecom.com/en/start.htm>

Table of Contents

1. Introduction	9
About this Document	9
Safety Precautions	11
About WiBAS-OSDR Hub / TS and WiBAS-Connect	12
2. Before Starting the Commissioning	13
Prerequisites	14
Hardware & Software Requirements	16
Required Tools	17
3. Powering Up	18
Powering through DC Power Injector	19
Powering through AC Power Injector	21
4. Physical Management Connection	23
4.1. WiBAS-OSDR Hub & TS	24
INBAND Management Connection (through GbE2 port)	24
INBAND Management Connection (through GbE1 port)	25
OUTBAND Management Connection	26
4.2. WiBAS-Connect TS	27
INBAND Management Connection	27
5. Accessing a Radio Unit via Node Manager	28
Default IP Address	28
Accessing a Radio Unit	29
6. Equipment Commissioning	30
6.1. Performing Preliminary Actions	31
6.2. Configuring Operational Parameters	32
WiBAS-OSDR Hub	32
WiBAS-OSDR TS	34
WiBAS-Connect TS	36
WiBAS-Connect TS (Auto-Polarization Edition)	38
6.3. Antenna Alignment	40
Connect RSSI Cable	42
WiBAS-OSDR Hub	44
WiBAS-OSDR TS	45
WiBAS-Connect TS	53
WiBAS-Connect TS (Auto-Polarization Edition)	68
6.4. Checking Operation	81
6.5. Service Provisioning	83
Appendix A – LED Indications	85

Appendix B – Inband Management Connection Troubleshooting..... 89
Appendix C – Quality Indicator Thresholds 93

1. Introduction

About this Document

Scope of Document

The scope of this document is to provide detailed instructions on the startup and commissioning of the following **PtMP** products:

- **WiBAS™ - OSDR Hub & Terminal Station**
- **WiBAS™ - Connect Terminal Station**

The commissioning is performed via **Node Manager**⁽¹⁾.

Target audience

The procedures described in current document can be carried out **ONLY** by wireless certified technician with the following skills:

- Wireless installation inspection (pole installation, cabling, grounding, powering e.t.c)
 - Coarse and Fine antenna alignment (for Hub and Terminal Station)
 - System commissioning using laptop and telecom software.
 - System services provisioning.
-

Software version

This document applies in a specific software release.

The Release version as well as the Release Notes of product are available and provided by the **product support** (wireless_support@intracom-telecom.com) of Intracom S.A. Telecom Solutions.

Reference manuals

The reference manuals are listed below:

Item	Description
1	OSDR Installation Manual.
2	WiBAS-Connect Installation Manual.
3	WiBAS OSDR Node Manager Manual.
4	OSDR_WiBAS-Connect Product Catalog.

Continued on next page

⁽¹⁾ Embedded application.

About this Document, Continued

Conventions

This document applies to the following conventions:

- **Arial Bold blue** fonts are used for order codes.
- Arial Blue underline fonts are used for document references.
- **Arial Bold black** fonts are used for indicating important information or paragraph header.



This symbol means **DANGER**. The purpose of this symbol is to warn you that any wrong action can cause bodily injury or even death.



This symbol means **CAUTION**. The purpose of this symbol is to prevent you from performing an action that might result in damage of the equipment.



The purpose of this symbol is to protect you from unauthorized entry to the site and damage your equipment.



A note calls your attention to important supplementary information.



A hint denotes helpful piece of advice or practical suggestion.

Safety Precautions

Reference

Before starting any commissioning works please follow the safety precautions as described to the following reference manuals:

Product	Reference Manuals		
	Description	Chapter No.	Paragraph
WiBAS OSDR Hub	OSDR Installation Manual	1	Safety precautions
WiBAS OSDR Terminal Station			
WiBAS-Connect Terminal Station	WiBAS- Connect Installation Manual		

About WiBAS-OSDR Hub / TS and WiBAS-Connect

Overview

This document describes the startup & commissioning of the products shown below.



The dimension of parabolic integrated antennas is indicative. For more information regarding antennas dimension please refer on page 9, item 4 of [Reference manuals](#).

2. Before Starting the Commissioning

Prior to starting the commissioning of a WiBAS OSDR-Hub or Terminal station and WiBAS-Connect , verify that the prerequisites mentioned below are fulfilled and all required HW / SW and mechanical tools are available.

Topic	Page
Prerequisites	14
Hardware & Software Requirements	16
Required Tools	17

Prerequisites

Required commissioning data

Commissioning data at site should be entered according to Radio and Network planning.

The following commissioning data should be available before starting commissioning works on site:

- RF planning values: expected RSSI, SNR, Modulation and Tx Power.
- Modem and Radio configuration data: Bandwidth, Tx Frequency and ACM & ATPC Profiles.
- Management settings: IP Address, Subnet Mask, Gateway Address and Management VLAN.

On-site works

Before starting any commissioning actions, ensure that all the following works have been carried out on site according the below table:

Check about	Reference Manuals		
	Description	Chapter No.	Paragraph
Radio unit grounding.	OSDR Installation Manual	4	4.2
	WiBAS-Connect Installation Manual	4	4.4
Radio unit cabling.	OSDR Installation Manual	3	3.2
	WiBAS-Connect Installation Manual	3	Radio unit cabling.
Power injector installation	OSDR Installation Manual	Appendix C	All
	WiBAS-Connect Installation Manual	Appendix D	All

Continued on next page

Prerequisites, Continued

Antenna orientation

- The antenna orientation of **WiBAS™-OSDR Hub** should be carried out toward the planned service area, as specified in the radio planning document.
 - The antenna orientation of **terminal stations** should be carried out toward to the corresponding **WiBAS™-OSDR Hub** sector, as specified in the radio planning document.
-

Number of commissioners required

For the commissioning of the base station one commissioner is required.

For the link commissioning between a terminal station and a base station, one commissioner is required (terminal side).

Hardware & Software Requirements

Scope This paragraph provides the hardware and software resources required to perform commissioning procedures on WiBAS-OSDR Hub / TS & WiBAS-Connect.

Laptop Laptop with the following minimum requirements:

- CPU x86, 9th generation (Intel Core 2 or AMD ATHLON II Neo)
- 250 MB HDD
- 2 GB RAM
- Ethernet (RJ-45) port
- Windows 7 or later version
- Web Browser⁽¹⁾

Software

- Appropriate License.
- Latest WiBAS firmware upgrade pack.

CAT5 Ethernet cable CAT-5 or higher Gigabit Ethernet straight cable (for outband management).



RSSI cable RSSI cable for antennas alignment (available by Intracom S.A Telecom Solutions).

WiBAS-OSDR Hub / TS





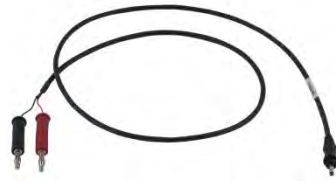





WiBAS™-Connect



⁽¹⁾ For details on the compatible Web Browsers, please refer to *Node Manager for WiBAS OSDR Reference Manual* (Chapter 2, par. *Log in*).

Required Tools

Tools	Description											
	<p>Digital Voltmeter.</p> <p>For measuring:</p> <ul style="list-style-type: none"> • Power injector input power. • The RSSI of radio unit during antennas alignment. 											
	<p>Adjustable torque U-wrench (up to 19 mm opening and supporting max tightening torque 45 Nm) for applying final tightening torque to all antennas mounting kit.</p>											
	<p>A set of spanners (ring and open jaw) for pre-tightening the mounting kit during alignment process:</p> <table border="1" data-bbox="826 913 1406 1252"> <thead> <tr> <th>Description</th> <th>Size / Dimension</th> <th>Qty</th> </tr> </thead> <tbody> <tr> <td rowspan="2">Parabolic and sectoral integrated antennas</td> <td>M10 (17 mm A/F)</td> <td>2</td> </tr> <tr> <td>M12 (19 mm A/F)</td> <td>2</td> </tr> <tr> <td>WiBAS-Connect parabolic low profile and panel antennas</td> <td>M8 (13 mm A/F)</td> <td>2</td> </tr> </tbody> </table>	Description	Size / Dimension	Qty	Parabolic and sectoral integrated antennas	M10 (17 mm A/F)	2	M12 (19 mm A/F)	2	WiBAS-Connect parabolic low profile and panel antennas	M8 (13 mm A/F)	2
Description	Size / Dimension	Qty										
Parabolic and sectoral integrated antennas	M10 (17 mm A/F)	2										
	M12 (19 mm A/F)	2										
WiBAS-Connect parabolic low profile and panel antennas	M8 (13 mm A/F)	2										
	<p>Adjustable torque wrench tool (supporting max tightening torque 25 Nm).</p>											
	<p>Hexagon male bit for adjustable torque wrench tool (for tightening WiBAS-OSDR TS mounting kit with panel antenna).</p>											
	<p>T10 TORX bit for adjustable torque wrench tool (for tightening outdoor DC PonE cover).</p>											
	<p>Flat slotted screw driver (min 10 mm).</p>											
	<p>Compass and Binocular for antenna alignment.</p>											

3. Powering Up

Scope

This chapter provides information on powering up a radio unit through a power injector.

Intracom Telecom provides the following power injectors⁽¹⁾:

Radio Unit	Order Code	Use	Input Power	Hardened Construction	Output Power
Connect	POE-ID-AC35	Indoor	AC		35 W
Hub	POE-AC56-IDH	Indoor		✓	56 W
Hub-TS	PONE-OD-DC	Outdoor	DC	✓	60 W
Hub-TS	PONE-OD67-AC	Outdoor	AC	✓	67.2 W
Hub ⁽²⁾	POE-AC75-ID	Indoor	AC		75 W

Prerequisite



Prior to powering up a radio unit, ensure that all [On-site works](#) (mentioned on page [14](#)) have been carried out as instructed in the OS DR Installation & Cabling Manual.

⁽¹⁾ After interoperability confirmation by Intracom Telecom, other types of power injectors can also be used.

⁽²⁾ 72 W POE also is applicable ([POE-AC72-ID](#)).

Powering through DC Power Injector

Introduction

DC power cable coming from the DC power injector⁽¹⁾ must be connected to a DC Distribution Board.
 A circuit breaker⁽²⁾ must be employed between the blue wire of DC power cable and the negative pole (-) V pole of the Local DC Power Source.
 The positive pole (+) V of the Local DC Power Source, which the brown wire of DC power cable is terminated on, is grounded.



Circuit breaker must remain to the OFF position until the power at the input of radio (V_{in}) to be checked.

V_{in} must be measured in the range of -60 V to -40 V.

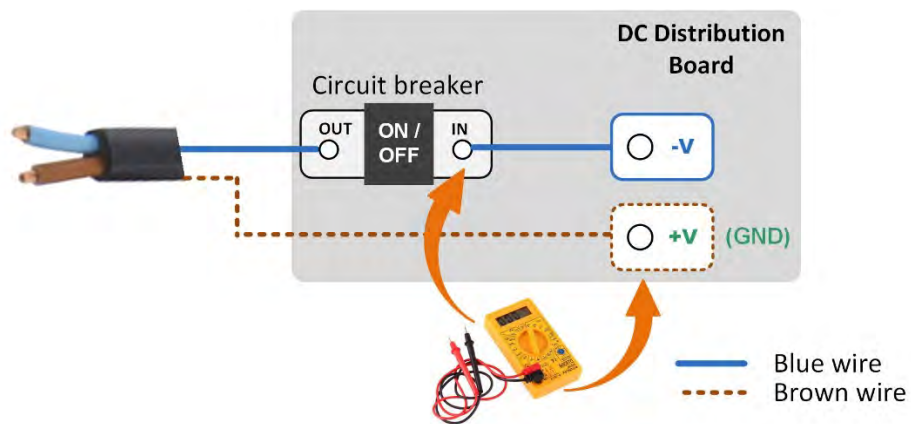

Procedure

To power up radio unit using the DC power injector, please follow the steps below:

Step	Action
1	Ensure that circuit breaker is in OFF position and connect a voltmeter to DC Distribution Board to measure the voltages at the input (IN) of circuit breaker (see schematic above). The measurement value must be in the range of: $-60 \leq V_{in} \leq -40$.
2	If measurement value is ok, disconnect the voltmeter and switch ON the circuit breaker.
3	Wait (approx. 120 sec) for the radio unit to power up.

Continued on next page

⁽¹⁾ DC power injector code: **PONE-OD-DC**

⁽²⁾ Single-pole MCB 6A, 72 V_{dc}, C-curve for Telecom Applications.

Powering through DC Power Injector, Continued

Procedure,
continued

Step	Action
4	<p>This step shows the proper LED indication status when the DC power source is operating properly⁽¹⁾:</p> 

End of procedure.

⁽¹⁾ In case of any error, see [Appendix A – LED Indications](#) on page [19](#).

Powering through AC Power Injector

Powering up via AC power injector

To power up a radio unit using an AC power injector, plug the AC power supply cable coming from the AC power injector to the AC power source. Depending on the type of AC power injector used, the LEDs status should be as described to the following paragraphs.



In case of any error, see [Appendix A – LED Indications](#) on page 85.

AC power injectors for WiBAS-Connect

AC power injector 35 W:

Find below the LED status indication of the outdoor AC power injectors when AC input is ok:



Continued on next page

Powering through AC Power Injector, Continued

AC power injectors for WiBAS-OSDR Hub & TS

AC power injector 75 W:

In power-up, all three LEDs light for 2 sec, as part of the self-test process. Upon successful completion, the ON and CONNECT LEDs should be steady green. (ON LED indicates that DC output voltage is now available for powering OSDR system. CONNECT LED indicates that OSDR system is properly connected to AC power injector).

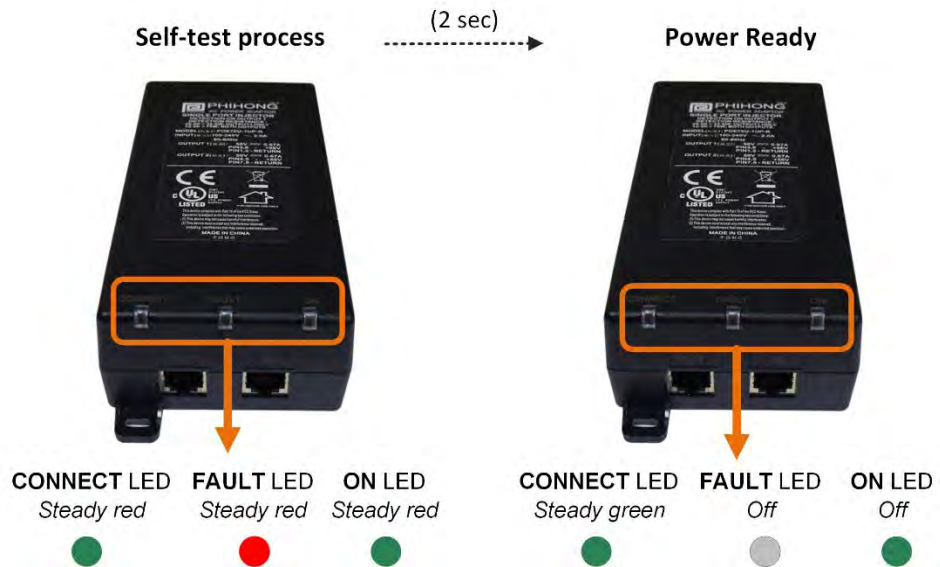

AC power injector 67.2 W & 56 W:

Find below the LED status indication of the outdoor AC power injectors when AC input is ok:

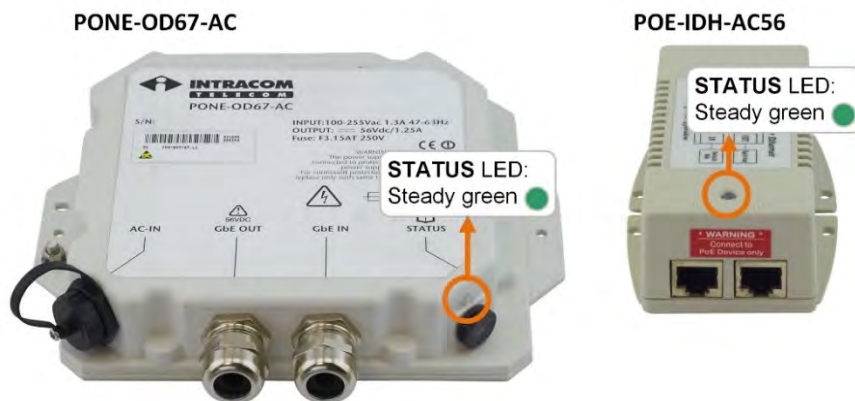

4. Physical Management Connection

Introduction

This chapter describes all the available physical connections between radio unit and the laptop for management and commissioning purpose.

The physical connection can be either outband or inband according the following table:

RADIO Unit	OUTBAND Connection	INBAND Connection
WiBAS™-OSDR Hub	FE port	GbE2 or GbE1 ports
WiBAS™-OSDR TS		
WiBAS™-Connect	Not applicable	GbE1 port

4.1. WiBAS-OSDR Hub & TS

INBAND Management Connection (through GbE2 port)

Connection diagram

The diagram below depicts the physical connection of the electrical GbE port (GbE 2) of Hub or TS for inband management purpose **when a power injector is used.**

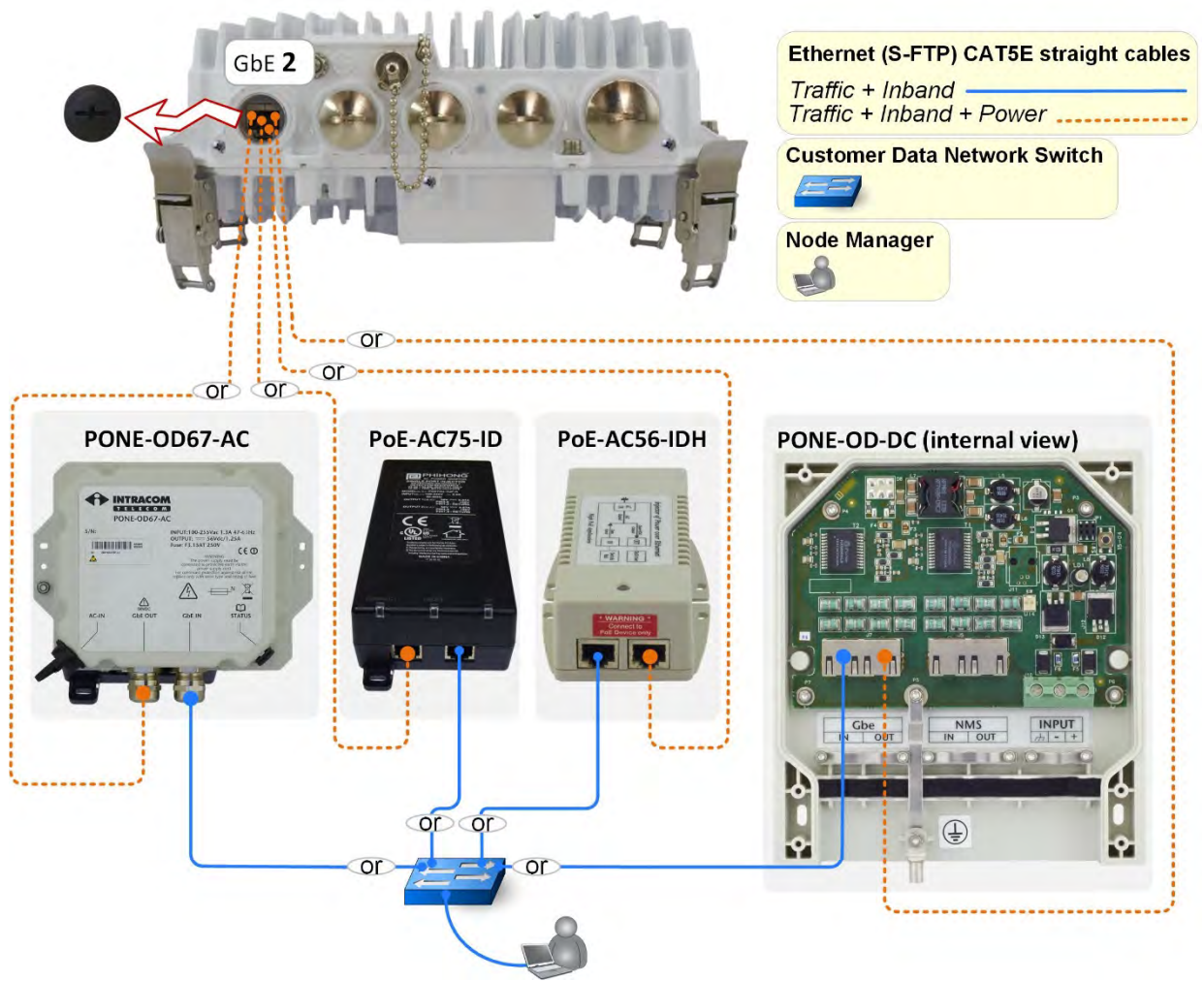

INBAND Management Connection (through GbE1 port)

Connection diagram

The diagram below depicts the physical connection of the electrical GbE port (GbE 1) of Hub or TS for inband management purpose when a power injector is used.

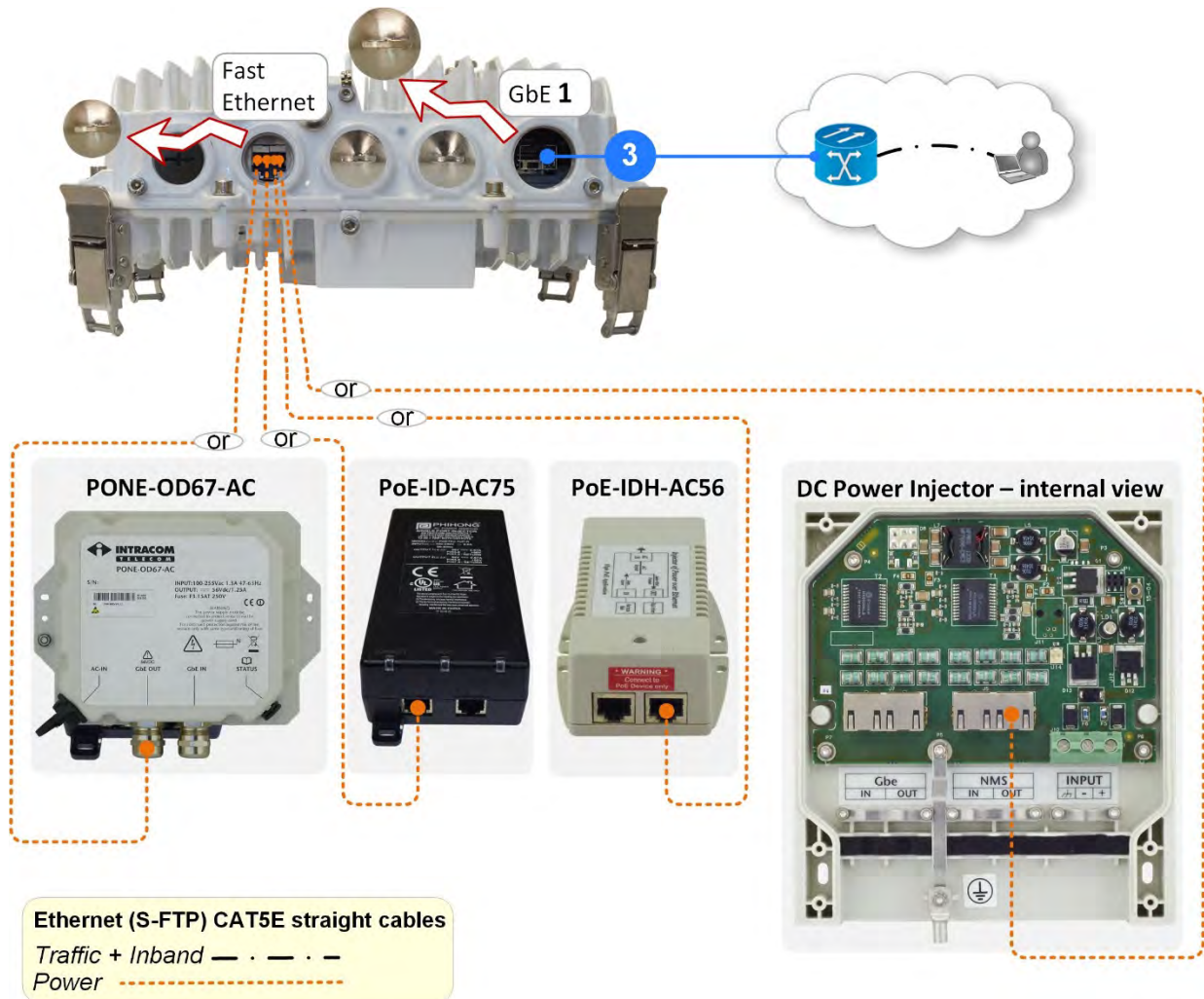

OUTBAND Management Connection

Connection diagram

The diagram below depicts the physical connection of the electrical GbE port (GbE 2) of Hub or TS for inband management purpose **when a power injector is used.**

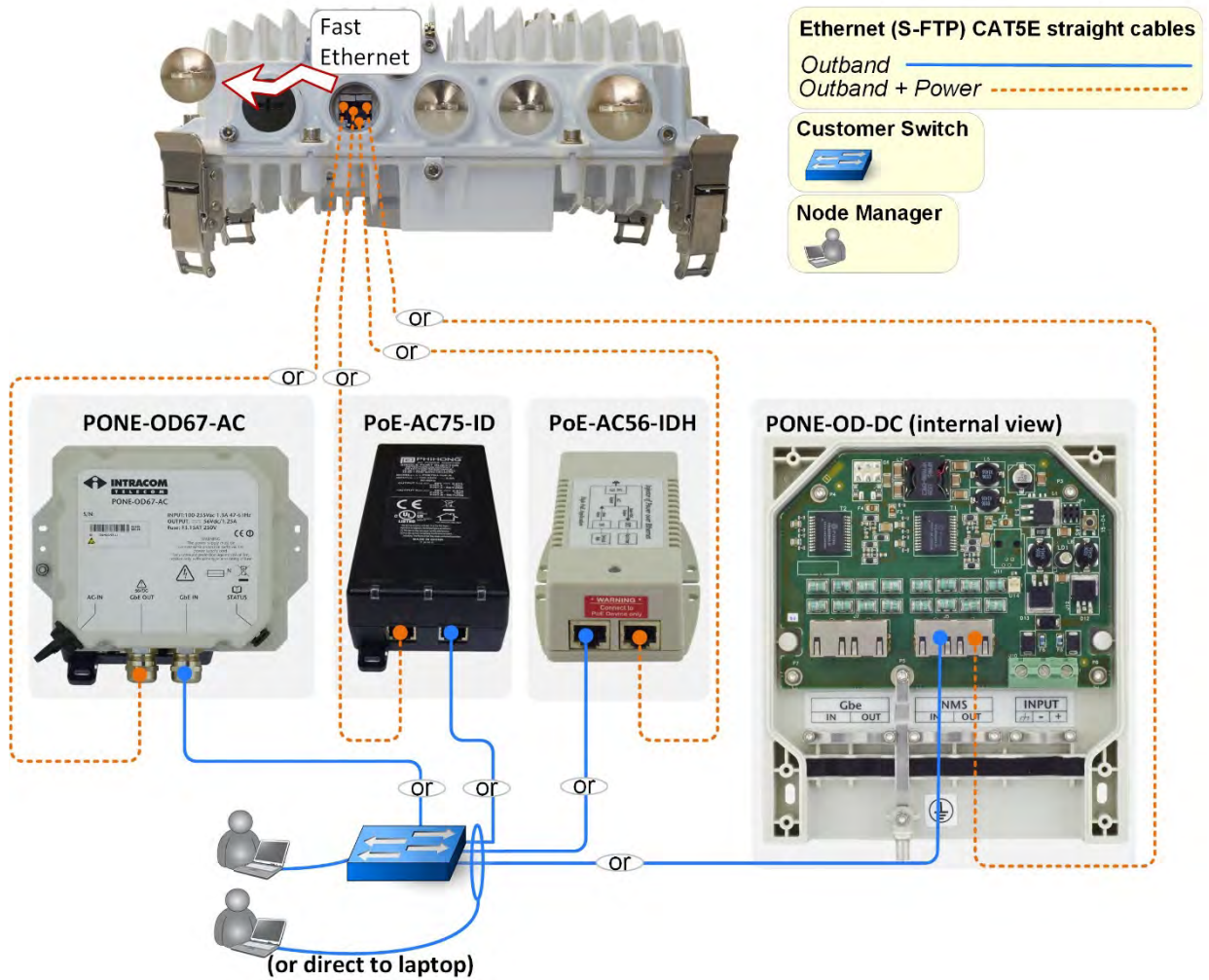

4.2. WiBAS-Connect TS

INBAND Management Connection

Connection diagram

The diagram below depicts the physical connection of the electrical GbE1 port for inband management purpose **when a power injector is used.**

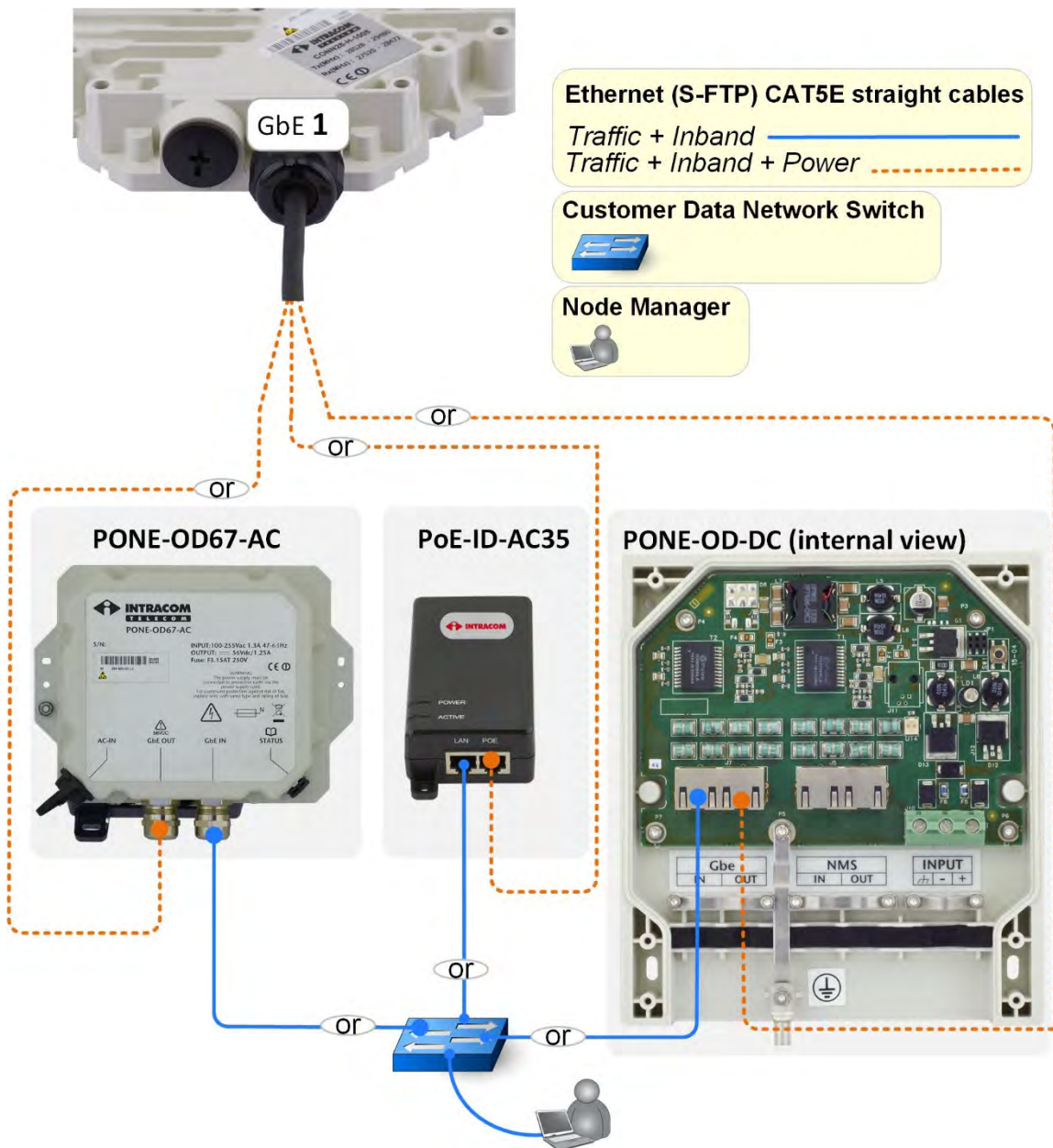

5. Accessing a Radio Unit via Node Manager

Scope This chapter provides the necessary instructions to **log in** to WiBAS radio unit.

Default IP Address

Factory default IP Addresses The first time you access a radio unit , the default factory IP address (inband or outband) is required:

- Default **Inband** IP Address: **10.10.10.100/24**
- Default **Outband** IP Address: **192.168.1.100/24**



Ethernet interfaces of laptop and inband management interface of radio unit must belong to the same subnetwork.

To allow this, change temporarily the IP address of the laptop to the same subnetwork that the inband management interface of radio unit belongs to (for example, change laptop's IP address to 10.10.10.110).

Fail -safe IP addresses



In case the communication with a radio unit cannot be established via an **outband connection**, the use of the following fail-safe IP Address may be required: **192.168.255.254**.



In case the communication with a radio unit cannot be established via an **inband connection**, the use of the following fail-safe IP Address may be required: **10.255.255.254**.

See details on [Appendix B – Inband Management Connection Troubleshooting](#) on page [89](#).

Accessing a Radio Unit

Scope This paragraph described how to access a radio unit when management connection has been implemented through a power injector.

Procedure To log in to radio unit, please follow the steps below:

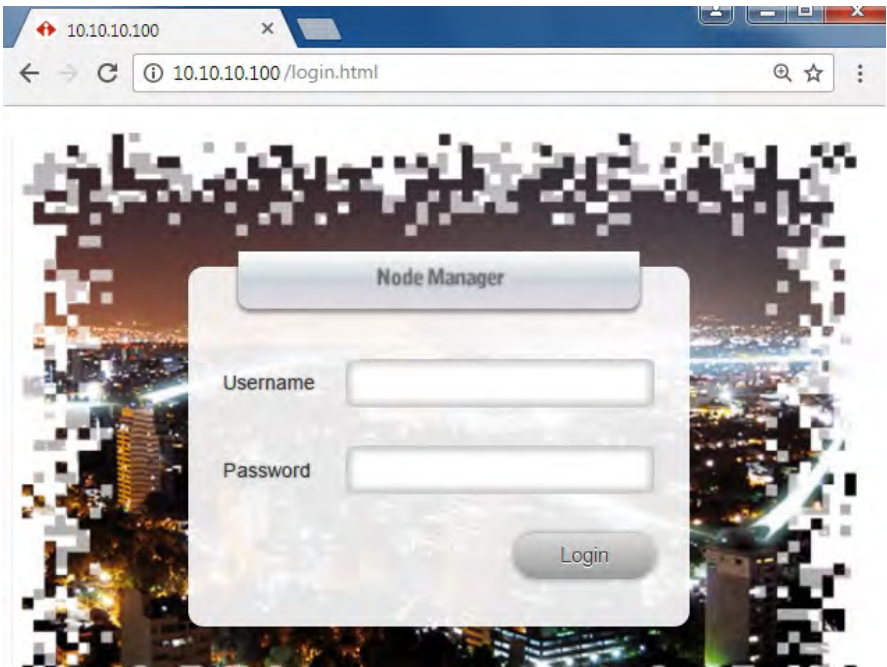
Step	Action
1	Open a compatible Web browser and in the address bar enter the IP address of node. Click ENTER.
2	In the welcome screen, type the username and password and click Login . 
3	After successful loading, the <i>Node Manager</i> application opens.

End of procedure.

6. Equipment Commissioning

Overview

For WiBAS radio unit commissioning perform the procedures in the following order:

Step	Procedure / Topic	See Page
1	Performing Preliminary Actions	31
2	Configuring Operational Parameters	32
3	Antenna Alignment	40
4	Checking Operation	81
5	Service Provisioning	83

Upon successful completion of the above procedures, the network operator will be able to take control and proceed to Ethernet QoS configuration and Ethernet provisioning.

6.1. Performing Preliminary Actions

After successful connection with radio unit, the following actions should be performed on unit prior to starting any configuration:

Step	Action	Reference Manual	Chapter	Section
1	Perform a Restore Default Configuration action to clear any previous configuration on unit.	WiBAS OSDR Node Manager.	Testing and Maintenance Procedures.	Restoring Default Configuration.
2	Check current version of unit. Update the version of unit, if required.			Upgrading Firmware ⁽¹⁾ .
3	Check the license status. Apply the new license, if required.		License.	<ul style="list-style-type: none"> • Monitoring License Information. • Applying a new License Key⁽¹⁾.

⁽¹⁾ If required.

6.2. Configuring Operational Parameters

WiBAS-OSDR Hub

Procedure To configure the operational parameters of the **WiBAS™ OSDR-HUB**, please follow the steps below:

Step	Task	See Reference Manuals item 3...
1	Management Interfaces⁽¹⁾	How to change outband / inband IP address refer to Chapter 5 / Paragraph " Configuring the Management Interfaces ".
2	Default Gateway IP Address	How to configure the default gateway IP address refer to Chapter 5 / Paragraph " Configuring the Default Gateway IP Address ".
3	Switching to TDMA-60 Operation Mode⁽²⁾	How to configure the operation mode refer to Chapter 9 / Paragraph " Switching to TDMA-60 Operation Mode ".
4	Modem (Channel Bandwidth, Modem profile)	How to configure the modem parameters refer to Chapter 5 / Paragraph " Configuring the Modem ".
5	Radio (Tx Frequency, Tx Power, Mute)	How to configure the radio parameters refer to Chapter 5 / Paragraph " Configuring the Radio ".
6	GbE Ports (Speed, duplex & negotiation mode).	How to configure the ports refer to Chapter 5 / Paragraph " Configuring the Ethernet Ports ".
7	OSDR-HUB Protection⁽³⁾	How to configure 1+1 hot standby protection refer to Chapter 5 / Paragraph " Configuring 1+1 WiBAS™-OSDR Hub Protection ".
8	Date / Time	How to configure the date and time refer to Chapter 5 / Paragraph " Configuring the Date / Time ".
9	Thresholds (Temperature)	How to configure the temperature thresholds refer to Chapter 5 / Paragraph " Configuring Temperature Thresholds ".

Continued on next page

⁽¹⁾ Also includes configuring of management VLAN.

⁽²⁾ This step applies only when WiBAS™-Connect terminal stations must be connected to the sector.

⁽³⁾ Ignore this step if the sector operates in 1+0 link configuration.

WiBAS-OSDR Hub, Continued

Procedure,
 continued

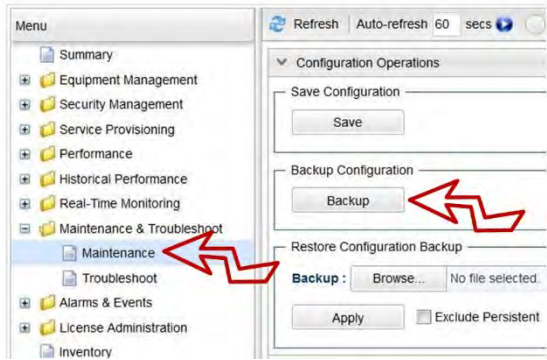
Step	Task	See Reference Manuals item 3...
10	Site information	How to add the site information refer to Chapter 5 / Paragraph " <u>Adding Site Information</u> ".
11	Trap Destinations	How to configure trap destinations refer to Chapter 4 / Paragraph " <u>Configuring Trap Destinations</u> ".
12	Saving configuration⁽¹⁾	How to save the configuration refer to Chapter 5 / Paragraph " <u>Saving Configuration</u> ".
13	Backup configuration	<p>Log in to WiBAS™-OSDR Hub and go to Maintenance & Troubleshoot > Maintenance.</p> <p>Click on the backup tab, as shown below</p>  <p>and save the file with tar extension.</p>

End of procedure.

⁽¹⁾ When the configuration is completed then is mandatory to save it.

WiBAS-OSDR TS

Procedure

To configure the operational parameters of the **WiBAS™ OSDR TS**, please follow the steps below:

Step	Task	See Reference Manuals item 3...
1	Management Interfaces⁽¹⁾	How to change the outband / inband IP address refer to Chapter 5 / Paragraph " Configuring the Management Interfaces ".
2	Default Gateway IP Address	How to configure the default gateway IP address refer to Chapter 5 / Paragraph " Configuring the Default Gateway IP Address ".
3	Switching to TDMA-60 Operation Mode⁽²⁾	How to configure the operation mode refer to Chapter 9 / Paragraph " Switching to TDMA-60 Operation Mode ".
4	Modem (Channel Bandwidth, Modem profile)	How to configure the modem parameters refer to Chapter 5 / Paragraph " Configuring the Modem ".
5	Radio (Tx Frequency, Tx Power, Mute)	How to configure the radio parameters refer to Chapter 5 / Paragraph " Configuring the Radio ".
6	GbE Ports (Speed, duplex & negotiation mode).	How to configure the ports refer to Chapter 5 / Paragraph " Configuring the Ethernet Ports ".
7	Date / Time	How to configure the date and time refer to Chapter 5 / Paragraph " Configuring the Date / Time ".
8	Thresholds (Temperature)	How to configure the temperature thresholds refer to Chapter 5 / Paragraph " Configuring Temperature Thresholds ".

Continued on next page

⁽¹⁾ Also includes configuring of management VLAN.

⁽²⁾ This step applies only when WiBAS™-Connect terminal stations must be connected to the sector.

WiBAS-OSDR TS, Continued

Procedure,
 continued

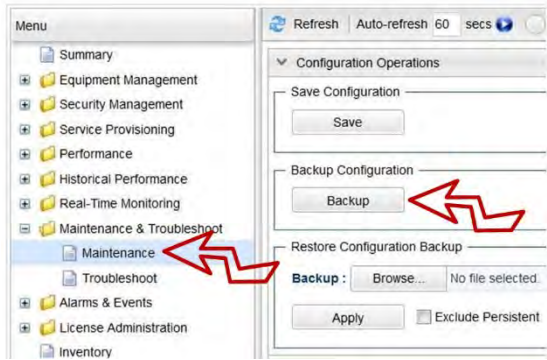
Step	Task	See Reference Manuals item 3...
9	Site information	How to add the site information refer to Chapter 5 / Paragraph " <u>Adding Site Information</u> ".
10	Trap Destinations	How to configure trap destinations refer to Chapter 4 / Paragraph " <u>Configuring Trap Destinations</u> ".
11	Saving configuration ⁽¹⁾	How to save the configuration refer to Chapter 5 / Paragraph " <u>Saving Configuration</u> ".
12	Backup configuration	<p>Log in to WiBAS™-OSDR TS and go to Maintenance & Troubleshoot > Maintenance.</p> <p>Click on the backup tab, as shown below</p>  <p>and save the file with tar extension.</p>

End of procedure.

⁽¹⁾ When the configuration is completed then is mandatory to save it.

WiBAS-Connect TS

Procedure

To configure the operational parameters of the **WiBAS™,-Connect** please follow the steps below:

Step	Task	See Reference Manuals item 3...
1	Management Interfaces ⁽¹⁾	How to change the outband / inband IP address refer to Chapter 5 / Paragraph " Configuring the Management Interfaces ".
2	Default Gateway IP Address	How to configure the default gateway IP address refer to Chapter 5 / Paragraph " Configuring the Default Gateway IP Address ".
3	Modem (Channel Bandwidth, Modem profile)	How to configure the modem parameters refer to Chapter 5 / Paragraph " Configuring the Modem ".
4	Radio (Tx Frequency, Tx Power, Mute)	How to configure the radio parameters refer to Chapter 5 / Paragraph " Configuring the Radio ".
5	GbE Ports (Speed, duplex & negotiation mode).	How to configure the ports refer to Chapter 5 / Paragraph " Configuring the Ethernet Ports ".
6	Date / Time	How to configure the date and time refer to Chapter 5 / Paragraph " Configuring the Date / Time ".
7	Thresholds (Temperature)	How to configure the temperature thresholds refer to Chapter 5 / Paragraph " Configuring Temperature Thresholds ".

Continued on next page

⁽¹⁾ Also includes configuring of management VLAN.

WiBAS-Connect TS, Continued

Procedure,
continued

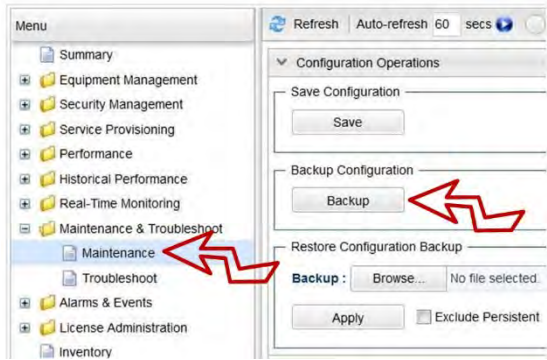
Step	Task	See Reference Manuals item 3...
8	Site information	How to add the site information refer to Chapter 5 / Paragraph " <u>Adding Site Information</u> ".
9	Trap Destinations	How to configure trap destinations refer to Chapter 4 / Paragraph " <u>Configuring Trap Destinations</u> ".
10	Saving configuration ⁽¹⁾	How to save the configuration refer to Chapter 5 / Paragraph " <u>Saving Configuration</u> ".
11	Backup configuration	<p>Log in to WiBAS™-Connect and go to Maintenance & Troubleshoot > Maintenance.</p> <p>Click on the backup tab, as shown below</p>  <p>and save the file with tar extension.</p>

End of procedure.

⁽¹⁾ When the configuration is completed then is mandatory to save it.

WiBAS-Connect TS (Auto-Polarization Edition)

Procedure

To configure the operational parameters of the **WiBAS™,-Connect (auto-polarization edition)** please follow the steps below:

Step	Task	See Reference Manuals item 3...
1	Management Interfaces⁽¹⁾	How to change the outband / inband IP address refer to Chapter 5 / Paragraph " Configuring the Management Interfaces ".
2	Default Gateway IP Address	How to configure the default gateway IP address refer to Chapter 5 / Paragraph " Configuring the Default Gateway IP Address ".
3	Wireless MAC • UTR Admin Status = Enable	How to configure the UTR admin status refer to Chapter 5 / Paragraph " Configuring the Wireless MAC ".
4	Modem (Channel Bandwidth, Modem profile)	How to configure the modem parameters refer to Chapter 5 / Paragraph " Configuring the Modem ".
5	Radio • (Tx Frequency, Tx Power, Mute) • Polarization = auto	How to configure the radio parameters refer to Chapter 5 / Paragraph " Configuring the Radio ".
6	GbE Ports (Speed, duplex & negotiation mode).	How to configure the ports refer to Chapter 5 / Paragraph " Configuring the Ethernet Ports ".
7	Date / Time	How to configure the date and time refer to Chapter 5 / Paragraph " Configuring the Date / Time ".
8	Thresholds (Temperature)	How to configure the temperature thresholds refer to Chapter 5 / Paragraph " Configuring Temperature Thresholds ".

Continued on next page

⁽¹⁾ Also includes configuring of management VLAN.

WiBAS-Connect TS (Auto-Polarization Edition), Continued

Procedure,
 continued

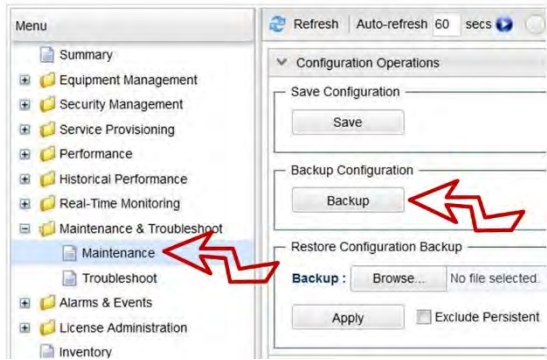
Step	Task	See Reference Manuals item 3...
9	Site information	How to add the site information refer to Chapter 5 / Paragraph " Adding Site Information ".
10	Trap Destinations	How to configure trap destinations refer to Chapter 4 / Paragraph " Configuring Trap Destinations ".
11	Saving configuration ⁽¹⁾	How to save the configuration refer to Chapter 5 / Paragraph " Saving Configuration ".
12	Backup configuration	<p>Log in to WiBAS™-Connect and go to Maintenance & Troubleshoot > Maintenance.</p> <p>Click on the backup tab, as shown below</p>  <p>and save the file with tar extension.</p>

End of procedure.

⁽¹⁾ When the configuration is completed then is mandatory to save it.

6.3. Antenna Alignment

Introduction The section includes the following topics:

Topic	See Page
WiBAS-OSDR Hub	44
WiBAS-OSDR TS	45
WiBAS-Connect TS	53
WiBAS-Connect TS (Auto-Polarization Edition)	68

Precautions



WORKING ON THE BUILDING'S ROOF

During stormy weather, do not perform any mechanical assembling or antenna installation/beaming works on the building's roof.

The metal structure of towers / masts is prone to lightning.

Prerequisites

Prior to the alignment of the antennas:

- Ensure that the Terminal station is pointing directly toward to the WiBAS™ -OSDR Hub antenna.
 - Ensure that the base station and terminal station, at both sides of the link, have been powered up.
 - To carry out the alignment of the terminal station antenna, first ensure that the assigned WiBAS™ -OSDR Hub sector is transmitting and the commissioning has been performed successfully.
-

Continued on next page

Antenna Alignment, Continued

RSSI best value definition

The RSSI (voltmeter reading) **best** value is defined as below:

NEGATIVE sign RSSI:

Example: The **best value** between -0.456 Vdc and -0.789 Vdc is: **-0.456 Vdc.**

POSITIVE sign RSSI:

Example: The **best value** between 0.456 Vdc and 0.789 Vdc is: **0.456 Vdc.**

WiBAS-OSDR terminal station RSSI measurement calculation formula

The RSSI measurement based on the following calculation:
voltmeter receive value (in volts) x 100 = - dBm

For example:

If during alignment the voltmeter receives 0.513 volts then the calculation is the following: **$0.513 \times 100 = -51.3$ dBm.**

So the receive signal level is equal to -51.3 dBm

Beyond the above calculation you must check the SNR value to verify that the receive level is correct.



If the receive signal level is -51.3 dBm the SNR should be a valid value i.e 30 dBm.



If the SNR value is a negative number means that the receive signal level is incorrect and the alignment must be continued.

WiBAS-Connect terminal station RSSI measurement calculation formula

WiBAS-Connect device is capable to measure QI (quality indicator) value.

The QI value is based on the combination of RSSI and SNR measurement values using below formula:

$$QI = \text{RSSI} * 0.25 + \text{calculatedRSSI_fromSNR} * 0.75$$

For cases without interference, QI is expected to be equal to RSSI.

For cases with interference, QI measurement value is showing lower values than RSSI.





Available QI thresholds to [QI table](#) on page [93](#).

Connect RSSI Cable

RSSI cable connection procedure

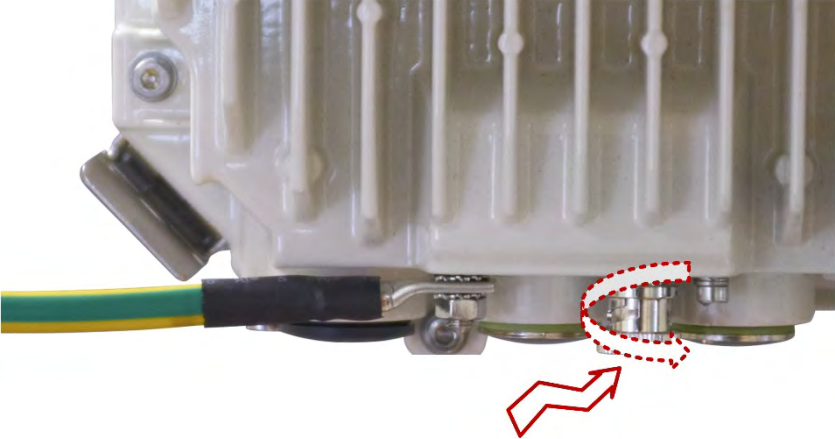

To connect the RSSI cable into the radio unit receptacle, please follow the steps below:

Step	Action
1	<p>WiBAS™-OSDR Hub or Terminal Station: Locate the RSSI receptacle at WiBAS™-OSDR Hub & TS connection panel. Turn its protective cap 90° counter-clockwise to remove, as shown below.</p>  <p>WiBAS™-Connect: Locate the RSSI receptacle at WiBAS™-Connect connection panel. Use the flat slotted screwdriver to remove the protective cup, as shown below.</p> 

Continued on next page

Connect RSSI Cable, Continued

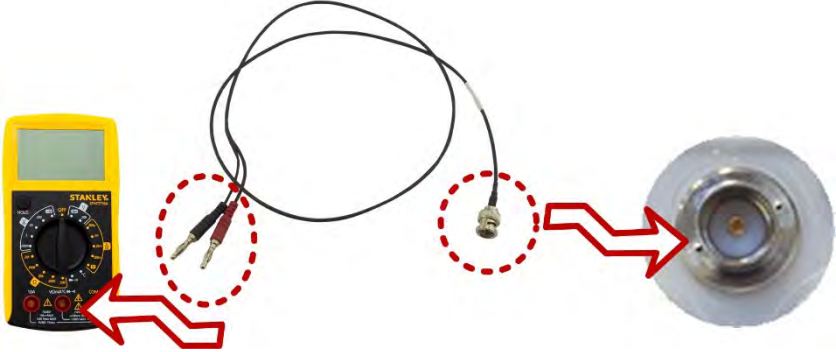
RSSI cable connection procedure, continued

Step	Action
2	<p>Connect the RSSI cable, as shown below.</p> <p>WiBAS™-OSDR Hub and TS:</p>  <p>WiBAS™-Connect:</p> 
3	Power on the digital voltmeter and adjust for DC voltage measurement (1 V range).

End of procedure.

WiBAS-OSDR Hub

Introduction This paragraph describes the antenna alignment for the following cases:



Precaution



Never leave unoccupied receptacles without cover. Covering receptacles is necessary to protect against humidity penetration.

Prerequisite

Please refer to **item 1** of [Reference manuals](#) on page **9** (Chapter 4 / Section 4.1 / Sectoral and Parabolic Antenna Procedure).

Mounting kit overview

For antennas mounting kit details please refer to **item 1** of [Reference manuals](#) on page **9** (Chapter 4 / Section 4.1 / Sectoral and Parabolic Antenna Procedure).

Procedure

For antennas final adjustment details please refer to **item 1** of [Reference manuals](#) on page **9** (Chapter 4 / Section 4.1 / Sectoral and Parabolic Antenna Procedure).

End of procedure.

WiBAS-OSDR TS

Introduction

This paragraph describes the antenna alignment for the following products:

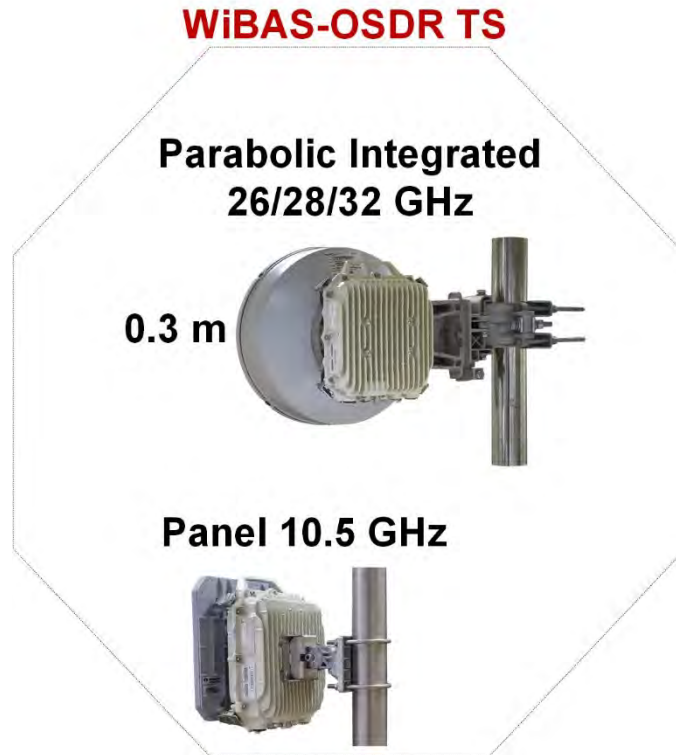

The relevant procedures can be found as follows:

Procedure Name	Page
Procedure for WiBAS-OSDR TS with Parabolic Integrated Antenna	47
Procedure for WiBAS-OSDR TS with Panel Antenna	50

Precaution



Never leave unoccupied receptacles without cover. Covering receptacles is necessary to protect against humidity penetration.

Prerequisite

During commissioning the azimuth and elevation values should be available by RF planning study.

Continued on next page

WiBAS-OSDR TS, Continued

Mounting kit overview

During commissioning the RF planning study azimuth and elevation degrees will be used as reference for antenna coarse alignment.

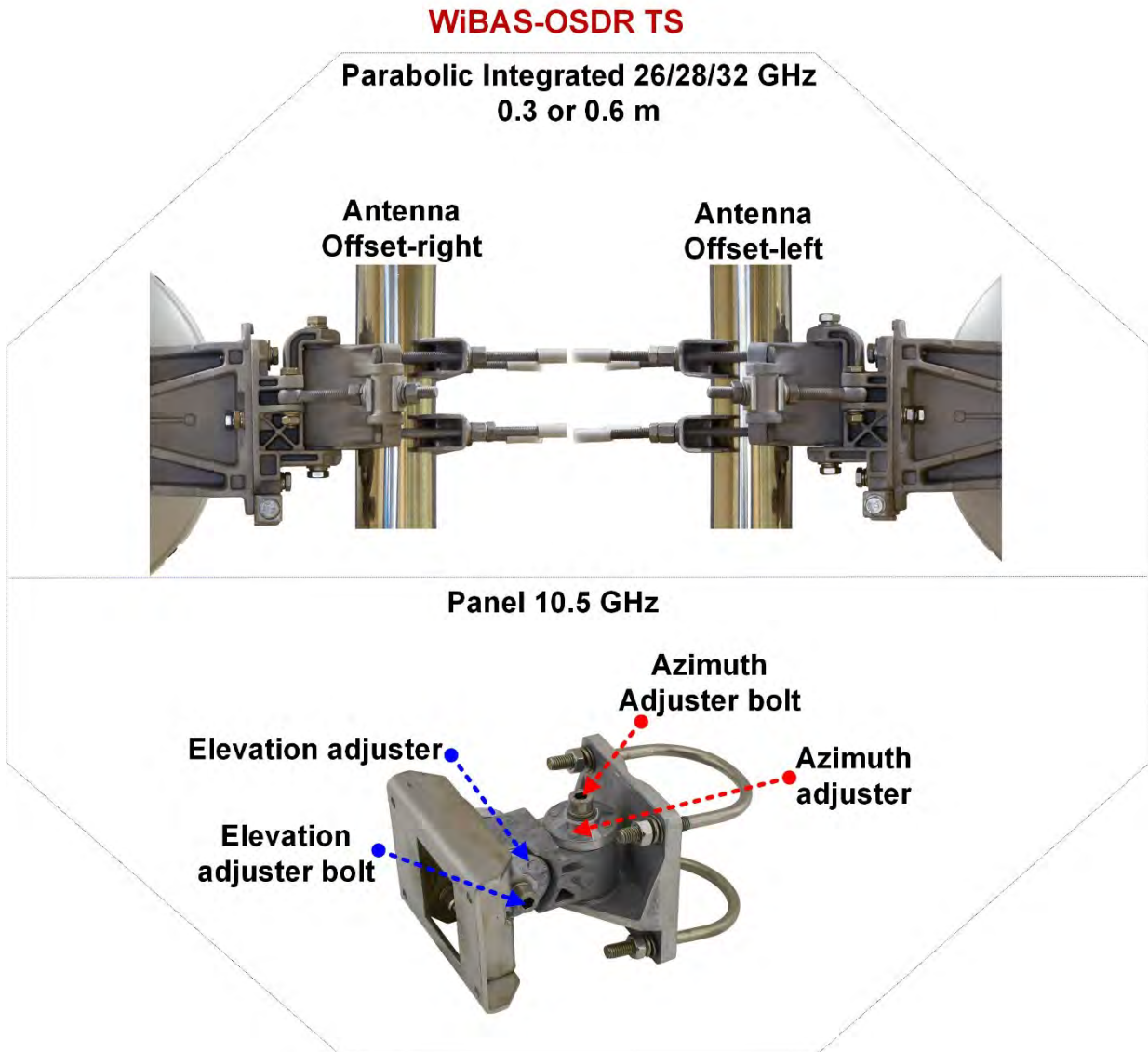

Continued on next page

WiBAS-OSDR TS, Continued

Procedure for WiBAS-OSDR TS with Parabolic Integrated Antenna

To perform WiBAS-OSDR TS parabolic integrated antenna alignment, please follow the steps below

Step	Action
1	<p>Perform coarse alignment, as follows:</p> <p>Use the respective spanner key to rotate the assembly on the pole so that the antenna is “visually” aligned with the target base station sector.</p> <div data-bbox="518 750 1197 1209" style="text-align: center;"> </div> <div data-bbox="316 1254 406 1310"> </div> <ul style="list-style-type: none"> • Use compass and binoculars for alignment. • Use the RF planning values for aligning the assembly to the target base station sector. <div data-bbox="316 1366 391 1433"> </div> <p>Use the adjustable U-Wrench to apply the final tightening torque according to the ANTENNA INSTALLATION LEAFLET values.</p>
2	<p>Power on the terminal station.</p> <p>Connect the RSSI cable as described to RSSI cable connection procedure on page 42.</p>

Continued on next page

WiBAS-OSDR TS, Continued

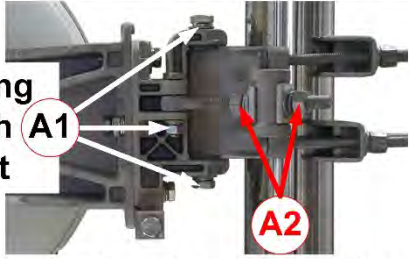
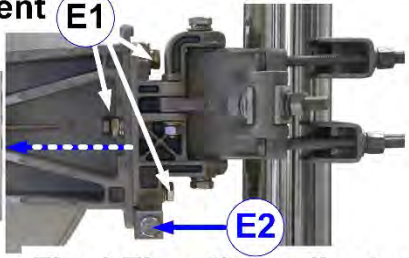

Procedure for WiBAS-OSDR TS with Parabolic Integrated Antenna, continued

Step	Action
3	<p>Perform fine alignment, as follows:</p> <ul style="list-style-type: none"> Use the spanner key to loosen the azimuth adjustment bolts (A1). Perform azimuth adjustment by rotating the bolts (A2) of the antenna mounting kit until the voltage readout reaches a desired level. <div data-bbox="507 591 1241 943" style="border: 1px solid black; padding: 5px; margin: 10px 0;">  <p>Loosen during the Azimuth Adjustment A1</p> <p>Final Azimuth Adjustment (rotate bolts to adjust) A2</p> </div> <ul style="list-style-type: none"> Use the spanner key to loosen the elevation adjustment bolts (E1). Perform elevation adjustment by rotating the bolt (E2) of the antenna mounting kit until the voltage readout reaches a desired level. <div data-bbox="491 1055 1201 1491" style="border: 1px solid black; padding: 5px; margin: 10px 0;">  <p>Loosen during the Elevation Adjustment E1</p> <p>Final Elevation adjustment (rotate bolt to adjust) E2</p> <p>Note: The desirable elevation degrees should be matched with kit elevation degrees indicator</p> </div> <p>Note The RSSI voltage (actually the voltmeter value) provides a direct relationship with RSL.</p> <p>For Wibas-OSDR see WiBAS-OSDR terminal station RSSI measurement calculation formula on page 41, For WiBAS-Connect see WiBAS-Connect terminal station RSSI measurement calculation formula on page 41).</p> <p>Warning: Pre-tightened.</p> <p>The final tightening torque will be applied after alignment process completion.</p>

Continued on next page

WiBAS-OSDR TS, Continued

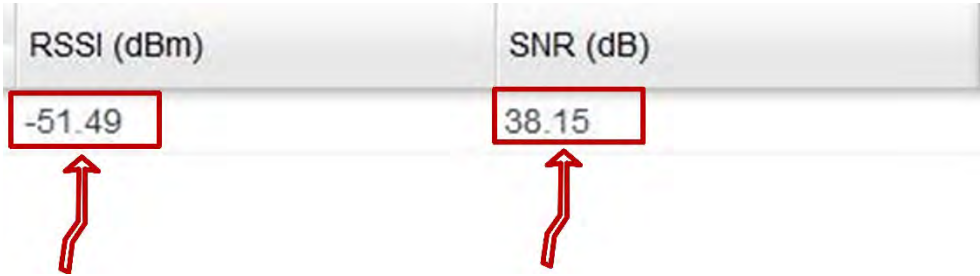
Procedure for WiBAS-OSDR TS with Parabolic Integrated Antenna, continued

Step	Action				
4	<p>Log in to the aligned terminal station as described to Accessing a Radio Unit on page 29.</p> <p>Go to Summary and check the RSSI & SNR value, as shown below:</p> <div data-bbox="363 629 1347 904" style="border: 1px solid #ccc; padding: 5px; text-align: center;"> <table style="width: 100%; border-collapse: collapse;"> <tr> <td style="border: 1px solid #ccc; padding: 5px;">RSSI (dBm)</td> <td style="border: 1px solid #ccc; padding: 5px;">SNR (dB)</td> </tr> <tr> <td style="border: 1px solid #ccc; padding: 5px;">-51.49</td> <td style="border: 1px solid #ccc; padding: 5px;">38.15</td> </tr> </table>  </div> <p>Press the refresh button to get the latest value.</p>	RSSI (dBm)	SNR (dB)	-51.49	38.15
RSSI (dBm)	SNR (dB)				
-51.49	38.15				
5	<p>If the values are the expected ones, then secure the antenna to the final position.</p> <p>Use the adjustable U-wrench to apply the final tightening torque to the bolts (<i>follow the tightening torque values provided by the Installation Instructions of the corresponding antenna</i>).</p> <p> Do not over tighten.</p> <p>Be very careful when tightening the adjustment bolts not to move the antenna.</p> <p> After alignment completion DO NOT leave radio unit RSSI receptacle without cover. Covering receptacles protect against humidity penetration.</p>				



End of procedure.

Continued on next page

WiBAS-OSDR TS, Continued

**Procedure for
WiBAS-OSDR
TS with Panel
Antenna**

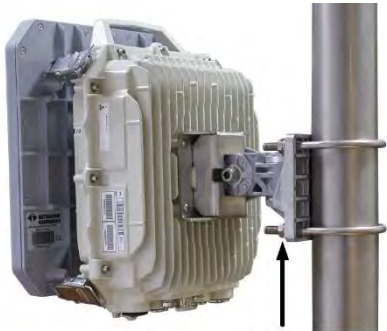
To perform WiBAS-OSDR TS panel antenna alignment, please follow the steps below:

Step	Action
<p>1</p>	<p>Perform coarse alignment, as follows:</p> <p>Use the respective spanner key to rotate the assembly on the pole so that the antenna is “visually” aligned with the target base station sector.</p> <div data-bbox="655 719 1043 1193" style="text-align: center;">  <p>Loosen during coarse alignment</p> </div> <div data-bbox="316 1256 408 1308" style="display: inline-block; border: 1px solid blue; padding: 2px; margin-bottom: 10px;">  Note </div> <ul style="list-style-type: none"> • Use compass and binoculars for alignment. • Use the RF planning values for aligning the assembly to the target base station sector. <div data-bbox="316 1368 392 1435" style="display: inline-block; margin-bottom: 10px;">  </div> <p>Use the adjustable U-Wrench to apply the final tightening torque (M8 u-bolts nuts max tightening torque 15 Nm).</p>
<p>2</p>	<p>Power on the terminal station.</p> <p>Connect the RSSI cable as described to RSSI cable connection procedure on page 42.</p>

Continued on next page

WiBAS-OSDR TS, Continued



Procedure for WiBAS-OSDR TS with Panel Antenna, continued

Step	Action
3	<p>Perform fine alignment, as follows:</p> <ul style="list-style-type: none"> • Use the allen key to loosen the azimuth adjustment bolt (A). Perform azimuth adjustment by moving very slowly the whole system (within the $\pm 10^\circ$ range around the azimuth axis) until the voltage readout reaches a desired level. • Use the allen key to loosen the elevation adjustment bolt (E). Perform elevation adjustment by moving very slowly the whole system (within the $\pm 10^\circ$ range around the elevation axis) until the voltage readout reaches a desired value. <div data-bbox="526 772 1189 1467" data-label="Image"> </div> <p>Note The RSSI voltage (actually the voltmeter value) provides a direct relationship with RSL.</p> <p>For WiBAS-OSDR see WiBAS-OSDR terminal station RSSI measurement calculation formula on page 41,</p> <p>For WiBAS-Connect see WiBAS-Connect terminal station RSSI measurement calculation formula on page 41).</p>
4	<p>Use the adjustable torque wrench for pre-tightening. The final tightening torque will be applied after alignment process completion.</p>

Continued on next page

WiBAS-OSDR TS, Continued

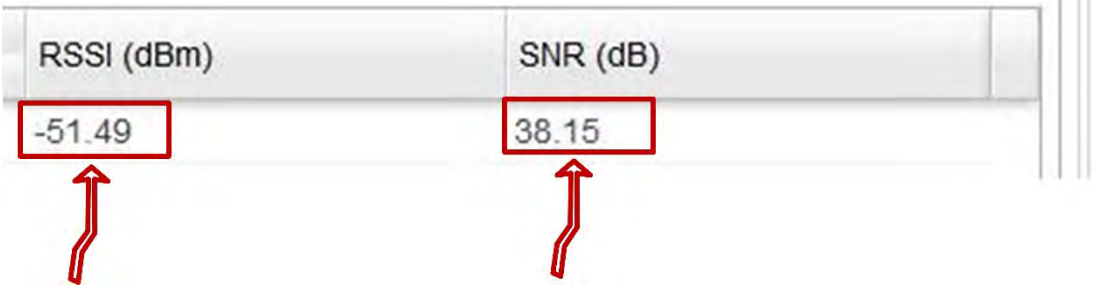
Procedure for WiBAS-OSDR TS with Panel Antenna, continued

Step	Action
5	<p>Log in to the aligned terminal station as described to Accessing a Radio Unit on page 29.</p> <p>Go to Summary and check the RSSI & SNR value, as shown below:</p>  <p>Press the refresh button to get the latest value.</p>
6	<p>If the values are the expected ones, then secure the antenna to the final position.</p> <p>Use the adjustable U-wrench to apply the final tightening torque to the bolts, as follows:</p> <ul style="list-style-type: none"> • M8 adjuster’s bolts max tightening torque 20 Nm. • M8 u-bolts nuts max tightening torque 15 Nm. <p> Do not over tighten. Be very careful when tightening the adjustment bolts not to move the antenna.</p> <p> After alignment completion DO NOT leave radio unit RSSI receptacle without cover. Covering receptacles protect against humidity penetration.</p>

End of procedure.

WiBAS-Connect TS

Introduction This paragraph describes the antenna alignment for the following products:

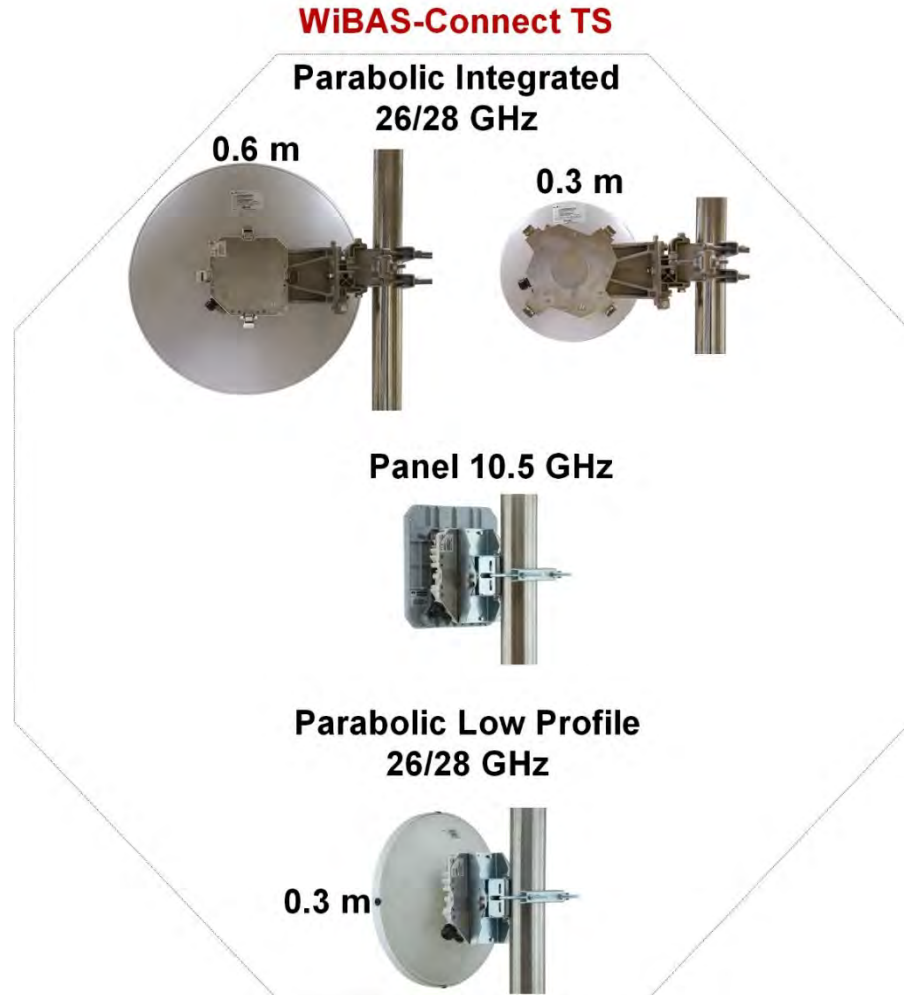

The relevant procedures can be found as follows:

Procedure Name	Page
Procedure for WiBAS-Connect TS with Parabolic Integrated Antenna	56
Procedure for WiBAS-Connect TS with Panel Antenna	59
Procedure for WiBAS-Connect TS with Parabolic Low Profile Antenna	62

Continued on next page

WiBAS-Connect TS, Continued

Precautions



DO NOT USE YOUR HANDS TO ALIGN THE ANTENNA!

Antenna will be damaged!

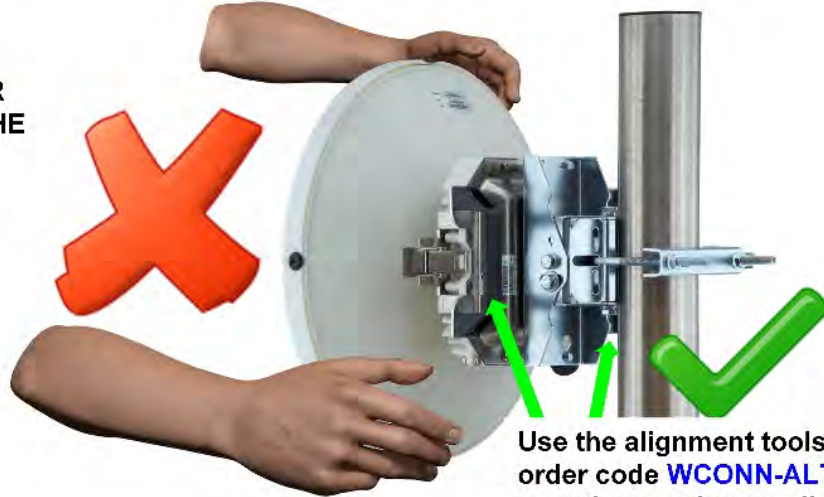

Use the alignment tools (with order code [WCONN-ALT-KIT](#)) at these points to align the antenna, as instructed in the commissioning manual!



Never leave unoccupied receptacles without cover. Covering receptacles is necessary to protect against humidity penetration.

Prerequisite

During commissioning the azimuth and elevation values should be available by RF planning study.

Continued on next page

WiBAS-Connect TS, Continued

Mounting kit overview

During commissioning the RF planning study azimuth and elevation degrees will be used as reference for antenna coarse alignment.

WiBAS-Connect TS

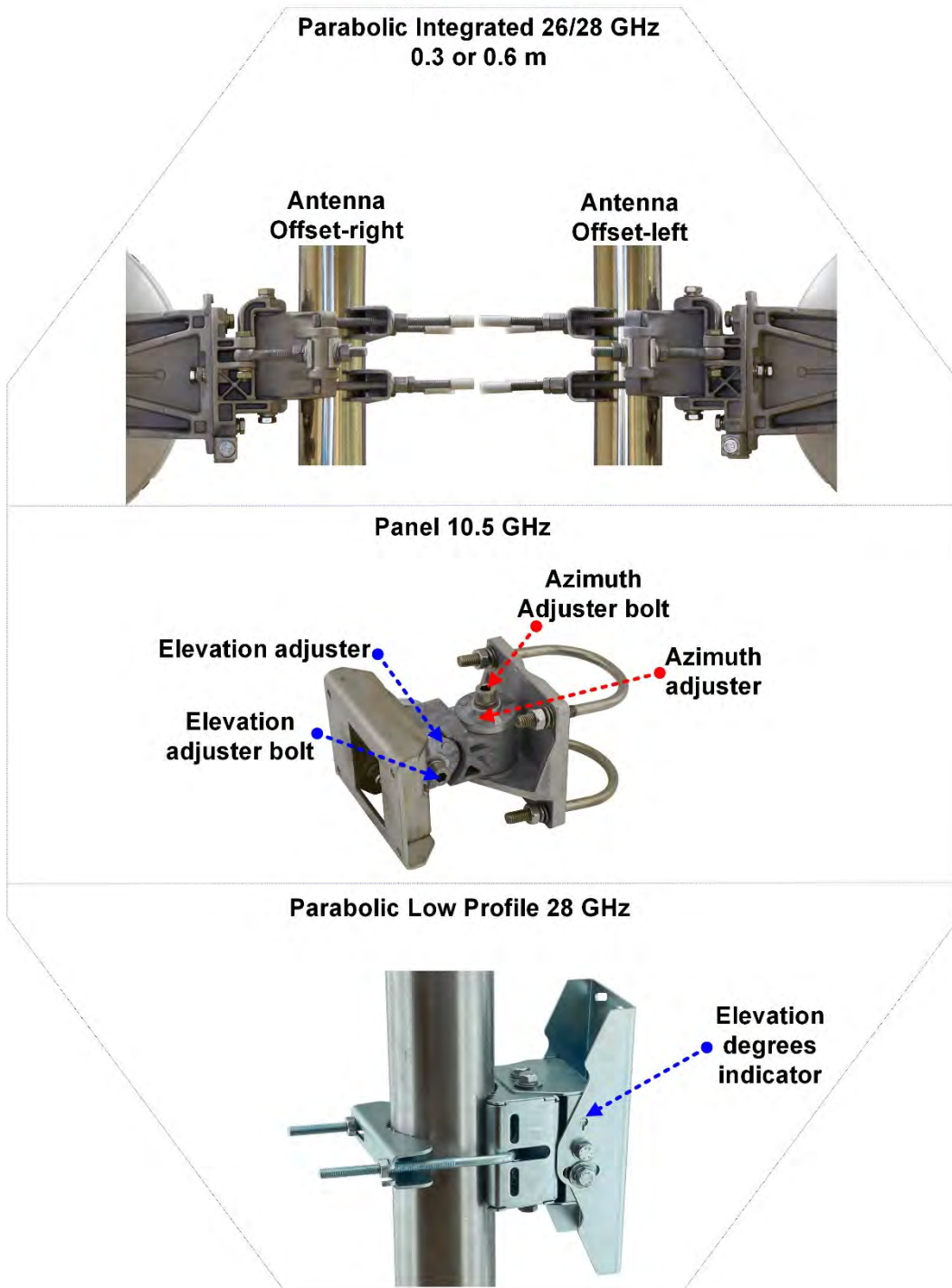



Continued on next page

WiBAS-Connect TS, Continued

Procedure for WiBAS-Connect TS with Parabolic Integrated Antenna

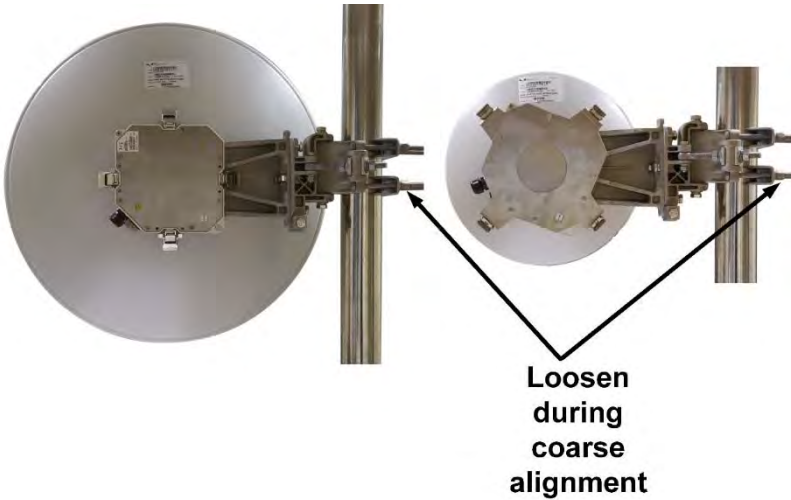
To perform WiBAS-Connect TS parabolic integrated antenna alignment, please follow the steps below:

Step	Action
1	<p>Perform coarse alignment, as follows:</p> <p>Use the respective spanner key to rotate the assembly on the pole so that the antenna is “visually” aligned with the target base station sector.</p> <div data-bbox="464 741 1259 1238" style="text-align: center;">  <p>Loosen during coarse alignment</p> </div> <div data-bbox="316 1301 408 1352">  </div> <ul style="list-style-type: none"> • Use compass and binoculars for alignment. • Use the RF planning values for aligning the assembly to the target base station sector. <div data-bbox="316 1413 392 1473">  </div> <p>Use the adjustable U-Wrench to apply the final tightening torque according to the ANTENNA INSTALLATION LEAFLET values.</p>
2	<p>Power on the terminal station.</p> <p>Connect the RSSI cable as described to RSSI cable connection procedure on page 42.</p>

Continued on next page

WiBAS-Connect TS, Continued



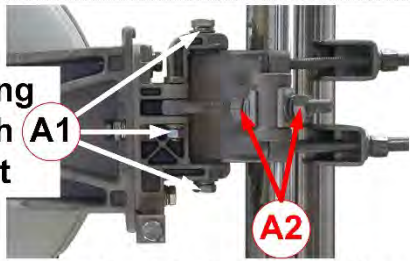
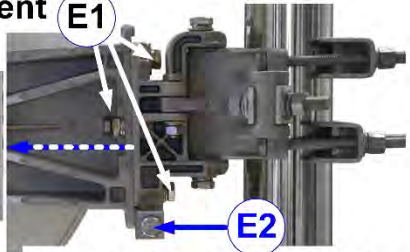

Procedure for WiBAS-Connect TS with Parabolic Integrated Antenna, continued

Step	Action
3	<p>Perform fine alignment, as follows:</p> <ul style="list-style-type: none"> Use the spanner key to loosen the azimuth adjustment bolts (A1). Perform azimuth adjustment by rotating the bolts (A2) of the antenna mounting kit until the voltage readout reaches a desired level. <div data-bbox="507 591 1241 943" style="border: 1px solid black; padding: 5px; margin: 10px 0;">  <p>Loosen during the Azimuth Adjustment A1</p> <p>Final Azimuth Adjustment (rotate bolts to adjust) A2</p> </div> <ul style="list-style-type: none"> Use the spanner key to loosen the elevation adjustment bolts (E1). Perform elevation adjustment by rotating the bolt (E2) of the antenna mounting kit until the voltage readout reaches a desired level. <div data-bbox="491 1055 1201 1491" style="border: 1px solid black; padding: 5px; margin: 10px 0;">  <p>Loosen during the Elevation Adjustment E1</p> <p>Final Elevation adjustment (rotate bolt to adjust) E2</p> <p>Note: The desirable elevation degrees should be matched with kit elevation degrees indicator</p> </div> <p>Note The RSSI voltage (actually the voltmeter value) provides a direct relationship with RSL.</p> <p>For Wibas-OSDR see WiBAS-OSDR terminal station RSSI measurement calculation formula on page 41, For WiBAS-Connect see WiBAS-Connect terminal station RSSI measurement calculation formula on page 41).</p> <p>Warning: Pre-tightened.</p> <p>The final tightening torque will be applied after alignment process completion.</p>

Continued on next page

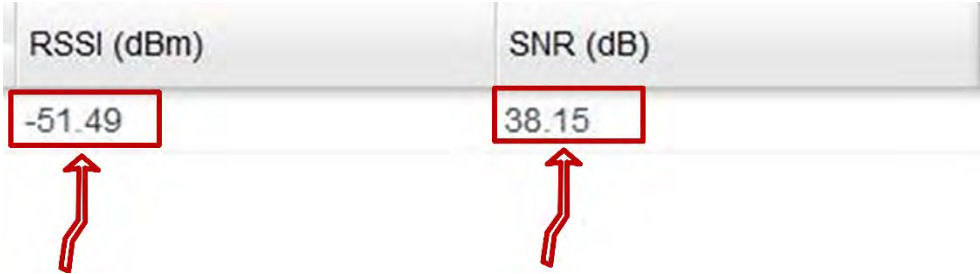
WiBAS-Connect TS, Continued

Procedure for WiBAS-Connect TS with Parabolic Integrated Antenna, continued

Step	Action				
4	<p>Log in to the aligned terminal station as described to Accessing a Radio Unit on page 29.</p> <p>Go to Summary and check the RSSI & SNR value, as shown below:</p> <div data-bbox="363 658 1347 931" style="border: 1px solid #ccc; padding: 10px; text-align: center;"> <table style="width: 100%; border-collapse: collapse;"> <tr> <td style="width: 50%; border-bottom: 1px solid #ccc; padding: 5px;">RSSI (dBm)</td> <td style="width: 50%; border-bottom: 1px solid #ccc; padding: 5px;">SNR (dB)</td> </tr> <tr> <td style="border: 2px solid red; padding: 5px;">-51.49</td> <td style="border: 2px solid red; padding: 5px;">38.15</td> </tr> </table>  </div> <p>Press the refresh button to get the latest value.</p>	RSSI (dBm)	SNR (dB)	-51.49	38.15
RSSI (dBm)	SNR (dB)				
-51.49	38.15				
5	<p>If the values are the expected ones, then secure the antenna to the final position.</p> <p>Use the adjustable U-wrench to apply the final tightening torque to the bolts (<i>follow the tightening torque values provided by the Installation Instructions of the corresponding antenna</i>).</p> <div style="margin-top: 20px;">  Do not over tighten. </div> <div style="margin-top: 10px;">  Be very careful when tightening the adjustment bolts not to move the antenna. </div> <div style="margin-top: 10px;">  After alignment completion DO NOT leave radio unit RSSI receptacle without cover. Covering receptacles protect against humidity penetration. </div>				



End of procedure.

Continued on next page

WiBAS-Connect TS, Continued

Procedure for WiBAS- Connect TS with Panel Antenna

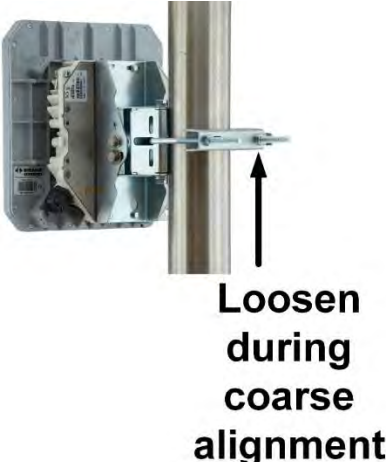
To perform WiBAS-Connect TS panel antenna alignment, please follow the steps below:

Step	Action
1	<p>Perform coarse alignment, as follows:</p> <p>Use the respective spanner key to rotate the assembly on the pole so that the antenna is “visually” aligned with the target base station sector.</p> <div data-bbox="651 752 1038 1211" style="text-align: center;">  <p>Loosen during coarse alignment</p> </div> <div data-bbox="316 1285 408 1339">  <p>Note</p> </div> <ul style="list-style-type: none"> • Use compass and binoculars for alignment. • Use the RF planning values for aligning the assembly to the target base station sector. <div data-bbox="316 1397 392 1464">  </div> <ul style="list-style-type: none"> • Use the adjustable U-Wrench to apply the final tightening torque (M8 u-bolts nuts max tightening torque 15 Nm). • U-Bolt fully tightening. Do not over tighten. Overtightening will cause deformation of the support clamp.
2	<p>Power on the terminal station.</p> <p>Connect the RSSI cable as described to RSSI cable connection procedure on page 42.</p>

Continued on next page

WiBAS-Connect TS, Continued

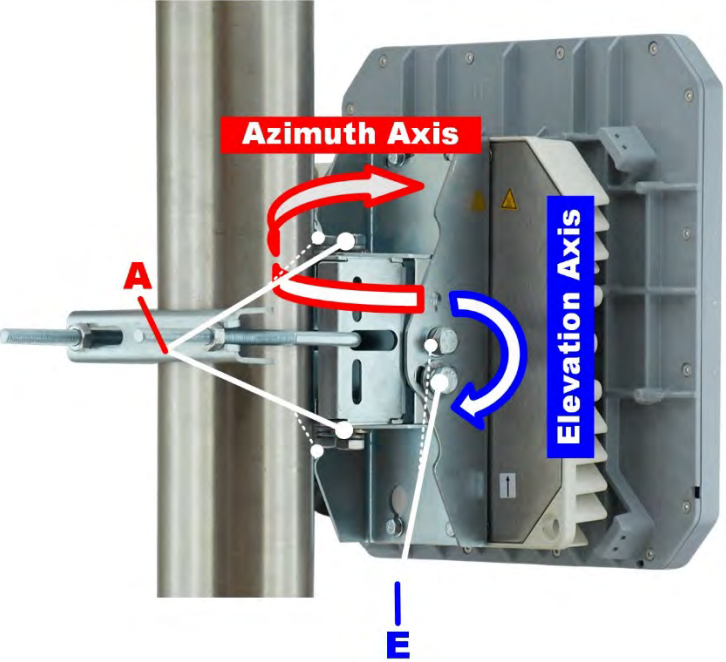

Procedure for WiBAS-Connect TS with Panel Antenna, continued

Step	Action
3	<p>Perform fine alignment, as follows:</p> <ul style="list-style-type: none"> • Use the spanner key to loosen the azimuth adjustment bolts (A). Perform azimuth adjustment by moving very slowly the whole system (within the $\pm 10^\circ$ range around the azimuth axis) until the voltage readout reaches a desired level. • Use the spanner key to loosen the elevation adjustment bolts (E). Perform elevation adjustment by moving very slowly the whole system (within the $\pm 10^\circ$ range around the elevation axis) until the voltage readout reaches a desired value. <p>Note</p> <ul style="list-style-type: none"> • (A) = Azimuth bolts x 2 (up and down) • (E) = Elevation bolts x 2 (left and right).  <p>Note The RSSI voltage (actually the voltmeter value) provides a direct relationship with RSL.</p> <p>For WiBAS-OSDR see WiBAS-OSDR terminal station RSSI measurement calculation formula on page 41,</p> <p>For WiBAS-Connect see WiBAS-Connect terminal station RSSI measurement calculation formula on page 41).</p>
4	<p>Use the adjustable torque wrench for pre-tightening. The final tightening torque will be applied after alignment process completion.</p>

Continued on next page

WiBAS-Connect TS, Continued

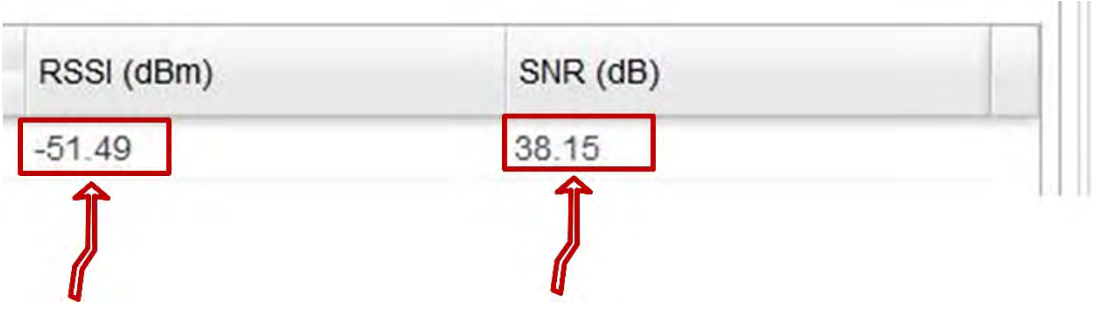
Procedure for WiBAS-Connect TS with Panel Antenna, continued

Step	Action
5	<p>Log in to the aligned terminal station as described to Accessing a Radio Unit on page 29.</p> <p>Go to Summary and check the RSSI & SNR value, as shown below:</p>  <p>Press the refresh button to get the latest value.</p>
6	<p>If the values are the expected ones, then secure the antenna to the final position.</p> <p>Use the adjustable U-wrench to apply the final tightening torque to the bolts, as follows:</p> <ul style="list-style-type: none"> • M5 bolts max tightening torque 5.5 Nm. • M8 bolts max tightening torque 15 Nm. • U-Bolt fully tightening. Do not over tighten. Overtightening will cause deformation of the support clamp. <p> Do not over tighten. Be very careful when tightening the adjustment bolts not to move the antenna.</p> <p> After alignment completion DO NOT leave radio unit RSSI receptacle without cover. Covering receptacles protect against humidity penetration.</p>

End of procedure.

Continued on next page

WiBAS-Connect TS, Continued

**Procedure for
WiBAS-
Connect TS
with Parabolic
Low Profile
Antenna**



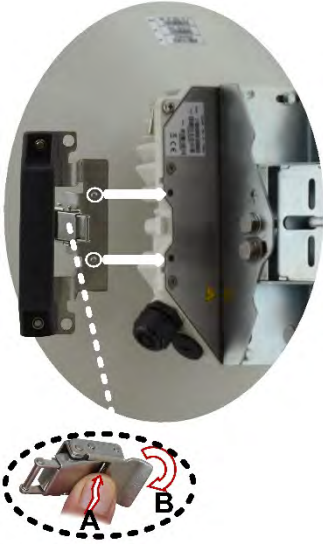
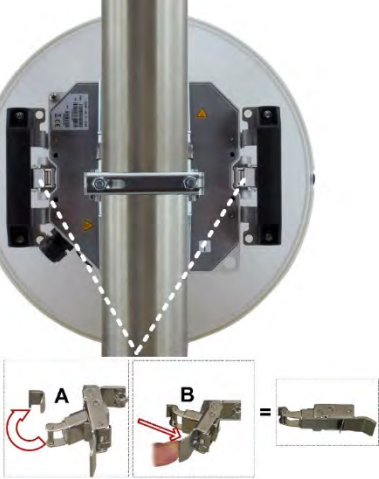

To perform WiBAS-Connect TS parabolic low profile antenna alignment, please follow the steps below:

Step	Action
1	<p>Open the tool clamps (A & B) and mount the tool onto the radio unit respective holes, as shown below.</p> 
2	<p>Lock and secure the clamps, as shown below.</p> 

Continued on next page

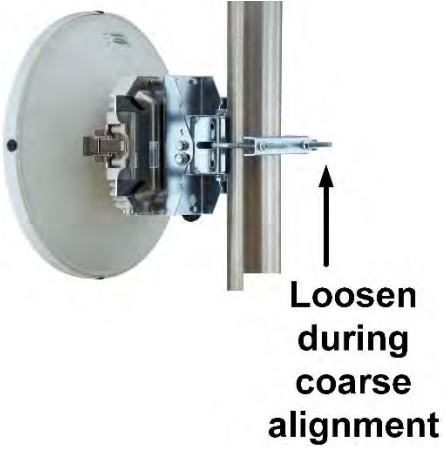
WiBAS-Connect TS, Continued

Procedure for WiBAS-Connect TS with Parabolic Low Profile Antenna, continued

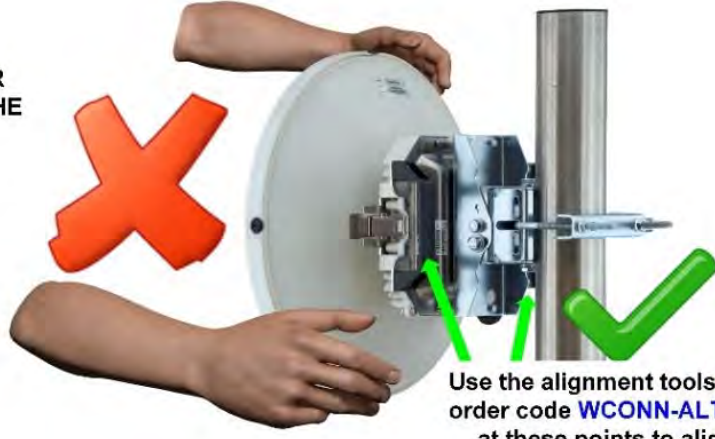
Step	Action
3	<p>Perform coarse alignment, as follows: Use the respective spanner key to rotate the assembly on the pole so that the antenna is “visually” aligned with the target base station sector.</p> <div data-bbox="630 593 1077 1041" style="text-align: center;">  <p>Loosen during coarse alignment</p> </div> <div data-bbox="316 1064 406 1120">  <p>Note</p> </div> <ul style="list-style-type: none"> • Use compass and binoculars for alignment. • Use the RF planning values for aligning the assembly to the target base station sector. <div data-bbox="316 1176 391 1243">  </div> <ul style="list-style-type: none"> • Use the adjustable U-Wrench to apply the final tightening torque (M8 u-bolts nuts max tightening torque 15 Nm). • U-Bolt fully tightening. Do not over tighten. Overtightening will cause deformation of the support clamp. <div data-bbox="406 1355 534 1467">  </div> <p>DO NOT USE YOUR HANDS TO ALIGN THE ANTENNA!</p> <p>Antenna will be damaged!</p> <div data-bbox="582 1411 1300 1848" style="text-align: center;">  </div> <p>Use the alignment tools (with order code WCONN-ALT-KIT) at these points to align the antenna, as instructed in the commissioning manual!</p>

Continued on next page

WiBAS-Connect TS, Continued

Procedure for WiBAS-Connect TS with Parabolic Low Profile Antenna, continued

Step	Action
4	Power on the terminal station. Connect the RSSI cable as described to RSSI cable connection procedure on page 42 .

Continued on next page

WiBAS-Connect TS, Continued

Procedure for WiBAS-Connect TS with Parabolic Low Profile Antenna, continued

Step	Action
5a	<p>Perform fine alignment, as follows:</p> <ul style="list-style-type: none"> Use the spanner key to loosen the azimuth adjustment bolts (A). Perform azimuth adjustment by holding tool's handles firmly and slightly move the antenna/radio combo (within the $\pm 10^\circ$ range around the azimuth axis) until the voltage readout reaches a desired level. <div data-bbox="518 683 1173 952" style="text-align: center;"> </div> <p>Note (A) = Azimuth bolts x 2 (up and down)</p> <p>Note The RSSI voltage (actually the voltmeter value) provides a direct relationship with RSL.</p> <p>For WiBAS-OSDR see WiBAS-OSDR terminal station RSSI measurement calculation formula on page 41,</p> <p>For WiBAS-Connect see WiBAS-Connect terminal station RSSI measurement calculation formula on page 41).</p>
6a	<p>Use the adjustable torque wrench for pre-tightening. The final tightening torque will be applied after alignment process completion.</p>

Continued on next page

WiBAS-Connect TS, Continued



Procedure for WiBAS-Connect TS with Parabolic Low Profile Antenna, continued

Step	Action
5b	<p>Perform fine alignment, as follows:</p> <ul style="list-style-type: none"> Use the spanner key to loosen the elevation adjustment bolts (E). Perform elevation adjustment by holding tool's handles firmly and slightly move the antenna/radio combo (within the $\pm 10^\circ$ range around the elevation axis) until the voltage readout reaches a desired level. <div data-bbox="593 667 1114 1115" style="text-align: center;"> </div> <p>Note (E) = Elevation bolts x 2 (left and right).</p> <p>Note The RSSI voltage (actually the voltmeter value) provides a direct relationship with RSL.</p> <p>For WiBAS-OSDR see WiBAS-OSDR terminal station RSSI measurement calculation formula on page 41,</p> <p>For WiBAS-Connect see WiBAS-Connect terminal station RSSI measurement calculation formula on page 41).</p>
6b	<p>Use the adjustable torque wrench for pre-tightening. The final tightening torque will be applied after alignment process completion.</p>

Continued on next page

WiBAS-Connect TS, Continued

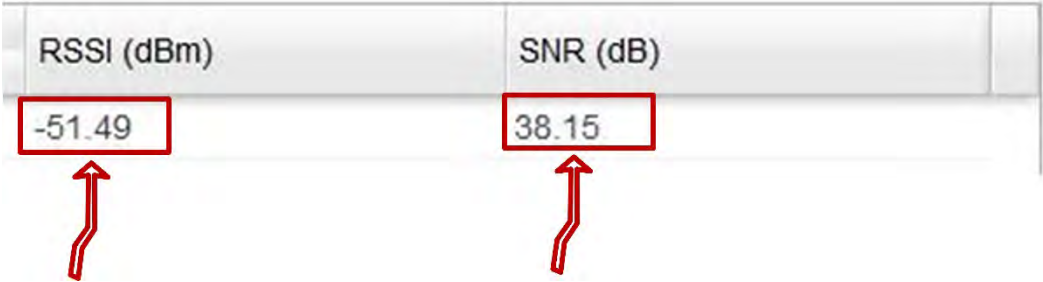
Procedure for WiBAS-Connect TS with Parabolic Low Profile Antenna,
 continued

Step	Action
7	<p>Log in to the aligned terminal station as described to Accessing a Radio Unit on page 29.</p> <p>Go to Summary and check the RSSI & SNR value, as shown below:</p>  <p>Press the refresh button to get the latest value.</p>
8	<p>If the values are the expected ones, then secure the antenna to the final position.</p> <p>Use the adjustable U-wrench to apply the final tightening torque to the bolts, as follows:</p> <ul style="list-style-type: none"> • M5 bolts max tightening torque 5.5 Nm. • M8 bolts max tightening torque 15 Nm. • U-Bolt fully tightening. Do not over tighten. Overtightening will cause deformation of the support clamp. <p> Do not over tighten. Be very careful when tightening the adjustment bolts not to move the antenna.</p> <p> After alignment completion DO NOT leave radio unit RSSI receptacle without cover. Covering receptacles protect against humidity penetration.</p>

End of procedure.

WiBAS-Connect TS (Auto-Polarization Edition)

Introduction

This paragraph describes the antenna alignment for the following product:

**WiBAS-Connect TS
(Auto-Polarization Edition)**

Parabolic Low Profile 28 GHz



The relevant procedure is provided on page [71](#)

Continued on next page

WiBAS-Connect TS (Auto-Polarization Edition), Continued

Precautions



DO NOT USE YOUR HANDS TO ALIGN THE ANTENNA!

Antenna will be damaged!

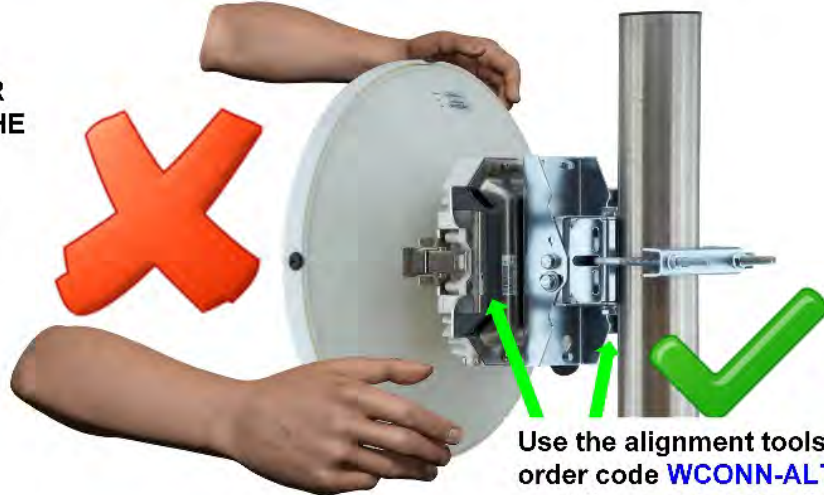

Use the alignment tools (with order code [WCONN-ALT-KIT](#)) at these points to align the antenna, as instructed in the commissioning manual!



Never leave unoccupied receptacles without cover. Covering receptacles is necessary to protect against humidity penetration.

Prerequisites

- Before starting the alignment of WiBAS-Connect TS the azimuth and elevation values should be available.
- The following operational parameters should be applied (see [WiBAS-Connect TS \(Auto-Polarization Edition\)](#) on page [38](#))
 - **Wireless MAC:** UTR Admin Status = enable
 - **Radio Configuration:** Polarization = auto

Continued on next page

WiBAS-Connect TS (Auto-Polarization Edition), Continued

Mounting kit overview

During commissioning the RF planning study azimuth and elevation degrees will be used as reference for antenna coarse alignment.

WiBAS-Connect TS (Auto-Polarization Edition)

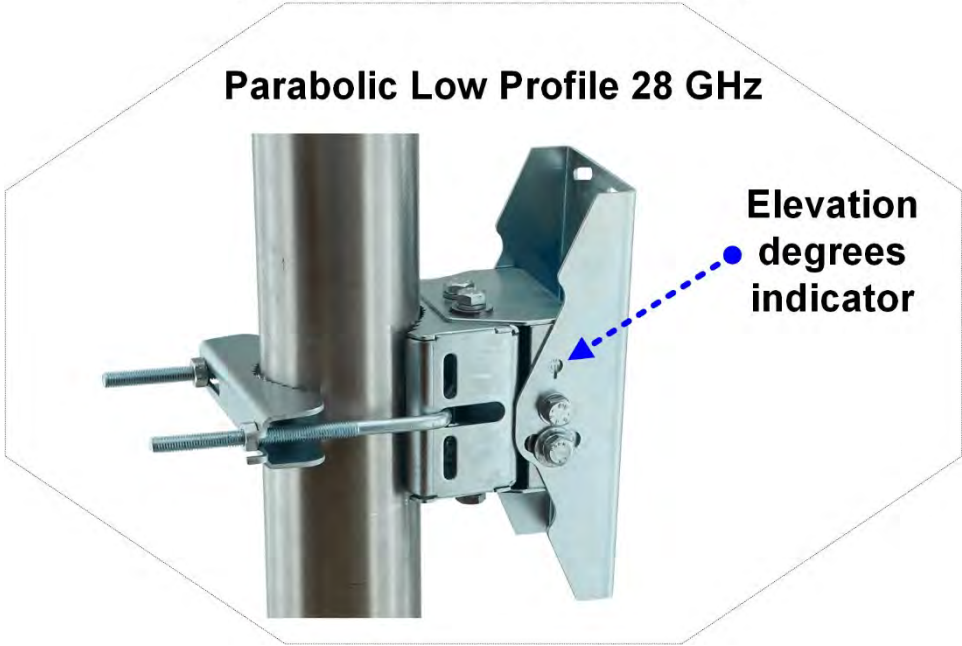

Continued on next page

WiBAS-Connect TS (Auto-Polarization Edition), Continued

Procedure for WiBAS- Connect Auto- Polarization TS with Parabolic Low Profile Antenna

To perform WiBAS™-Connect **auto-polarization** radio unit TS parabolic low profile antenna alignment, please follow the steps below:



This procedure is performed for Auto-Polarization Edition radio unit.



The factory default polarization for dual polarization terminals is V.



It is assumed that WiBAS-Connect TS has dual frequencies configured.



The TS polarity is identified via voltmeter value, as follows:

- In **vertical polarity** the voltmeter shows **0.X**, where X is the QI value.
- In **horizontal polarity** the voltmeter shows **1.X**, where X is the QI value.
- During **polarity change** the voltmeter shows **~2.5 V** and no action should be performed.

For QI values please refer to [QI table](#) on page [93](#).

Continued on next page

WiBAS-Connect TS (Auto-Polarization Edition), Continued

Procedure for WiBAS-Connect Auto-Polarization TS with Parabolic Low Profile Antenna, continued



The following flowchart provides an overall work flow based on the steps described to the current procedure:

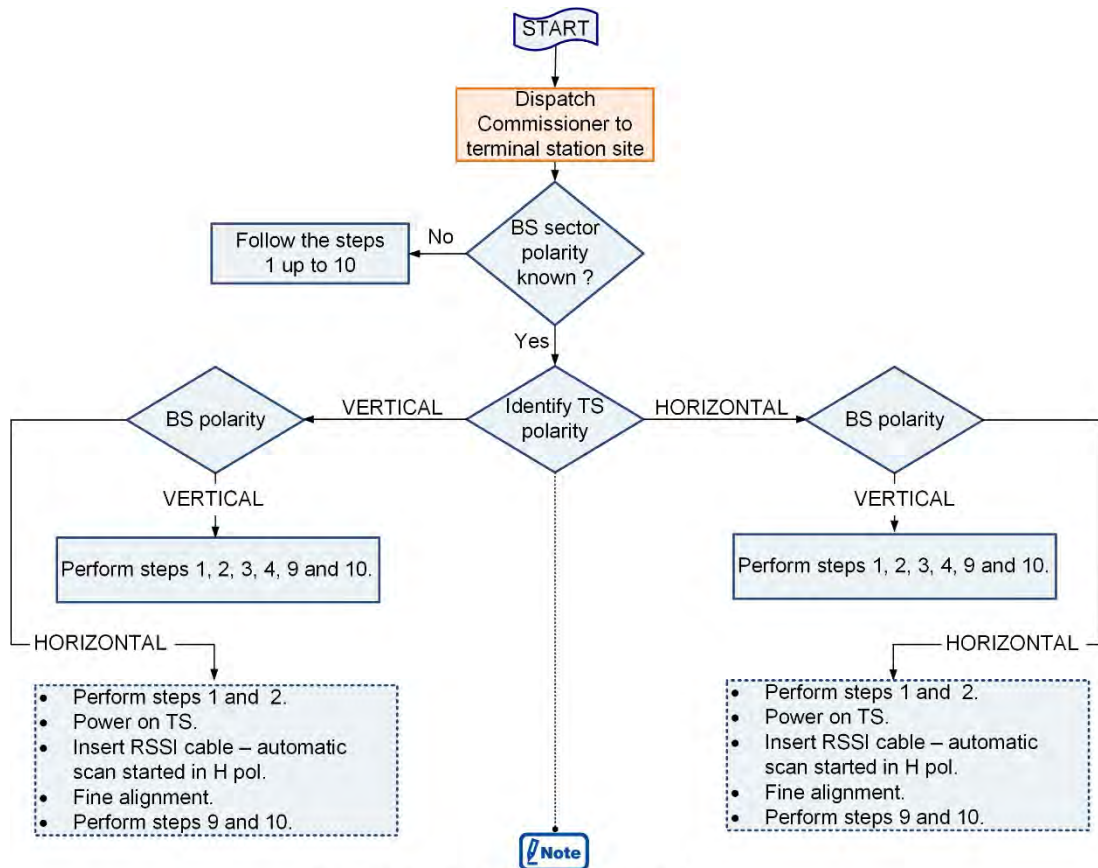

TS polarity affects the voltmeter value, as follows:

Vertical polarity = the voltmeter shows 0.X, where X is the QI value.

Horizontal polarity = the voltmeter shows 1.X, where X is the QI value.

Continued on next page

WiBAS-Connect TS (Auto-Polarization Edition), Continued

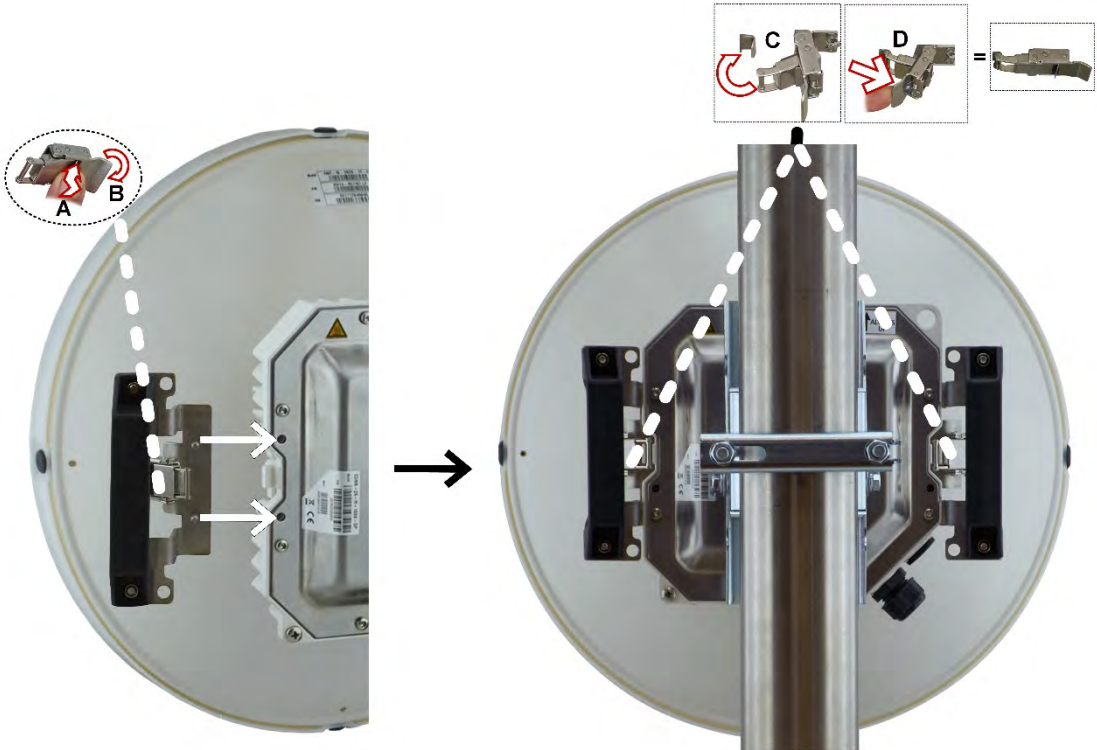

Procedure for WiBAS-Connect Auto-Polarization TS with Parabolic Low Profile Antenna, continued

Step	Action
1	<p data-bbox="300 472 727 506">Perform the following actions:</p> <ul data-bbox="300 512 1353 622" style="list-style-type: none"><li data-bbox="300 512 1353 577">• Open the tool clamps (A & B) and mount the tool onto the radio unit respective holes.<li data-bbox="300 584 807 622">• Lock and secure the clamps (C & D). 

Continued on next page

WiBAS-Connect TS (Auto-Polarization Edition), Continued

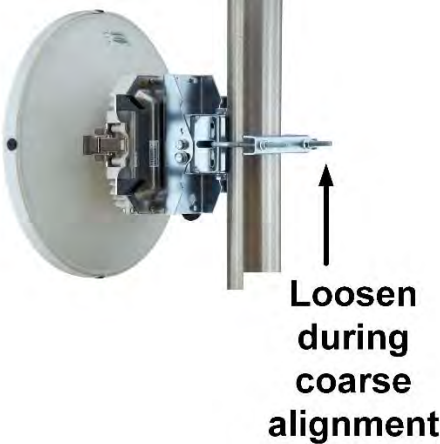

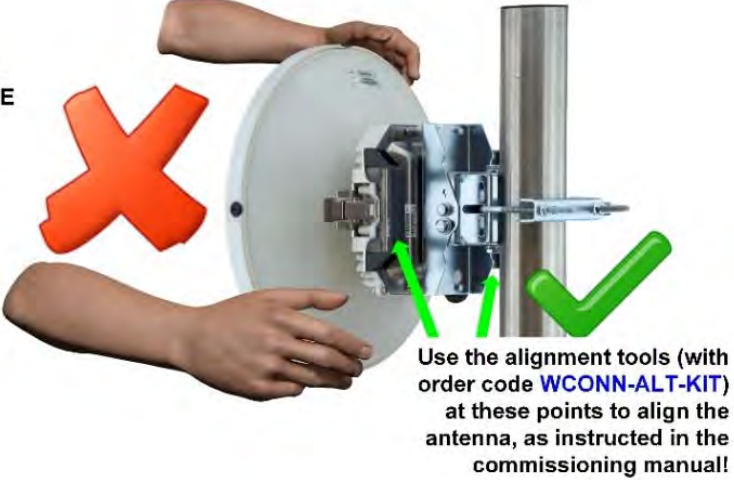
Procedure for WiBAS-Connect Auto-Polarization TS with Parabolic Low Profile Antenna, continued

Step	Action
2	<p>Perform coarse alignment, as follows: Use the respective spanner key to rotate the assembly on the pole so that the antenna is “visually” aligned with the target base station sector.</p> <div style="text-align: center;">  <p>Loosen during coarse alignment</p> </div> <p>Note</p> <ul style="list-style-type: none"> • Use compass and binoculars for alignment. • Use the RF planning values for aligning the assembly to the target base station sector. <p>Warning</p> <ul style="list-style-type: none"> • Use the adjustable U-Wrench to apply the final tightening torque (M8 u-bolts nuts max tightening torque 15 Nm). • U-Bolt fully tightening. Do not over tighten. Overtightening will cause deformation of the support clamp. <div style="display: flex; align-items: center;"> <div style="margin-right: 20px;">  <p>DO NOT USE YOUR HANDS TO ALIGN THE ANTENNA!</p> <p>Antenna will be damaged!</p> </div> <div style="text-align: center;">  <p>Use the alignment tools (with order code WCONN-ALT-KIT) at these points to align the antenna, as instructed in the commissioning manual!</p> </div> </div>

Continued on next page

WiBAS-Connect TS (Auto-Polarization Edition), Continued

Procedure for WiBAS-Connect Auto-Polarization TS with Parabolic Low Profile Antenna,
continued

Step	Action
3	<p data-bbox="300 472 727 506">Perform the following actions:</p> <ul data-bbox="300 524 1390 595" style="list-style-type: none"><li data-bbox="300 524 1390 595">• Connect the RSSI cable to TS (as described to RSSI cable connection procedure on page 42). <div data-bbox="316 618 1374 685" style="margin-left: 20px;"> If the commissioner power-on the unit and afterwards inserts the RSSI cable to TS receptacle then the S/W will go to step 5.</div> <ul data-bbox="300 719 1401 786" style="list-style-type: none"><li data-bbox="300 719 1401 786">• Power on the terminal station and wait 3 minutes till the boot process is completed - the led status of the terminal should be red. <div data-bbox="316 813 1350 880" style="margin-left: 20px;"> Please do not perform any action till the boot process of the TS is completed.</div> <ul data-bbox="300 913 1362 1099" style="list-style-type: none"><li data-bbox="300 913 1362 947">• After boot process the TS starts automatic process scan (vertical), and:<ul data-bbox="323 954 1362 1099" style="list-style-type: none"><li data-bbox="323 954 1362 1021">– S/W selects F1 frequency (in vertical polarization) and requires 10 seconds to provide the QI value on the voltmeter.<li data-bbox="323 1028 1362 1099">– S/W selects F2 frequency (in vertical polarization) and requires 10 seconds to provide the QI value on the voltmeter. <div data-bbox="316 1126 1023 1167" style="margin-left: 20px;"> For QI values please refer to QI table on page 93.</div>

Continued on next page

WiBAS-Connect TS (Auto-Polarization Edition), Continued

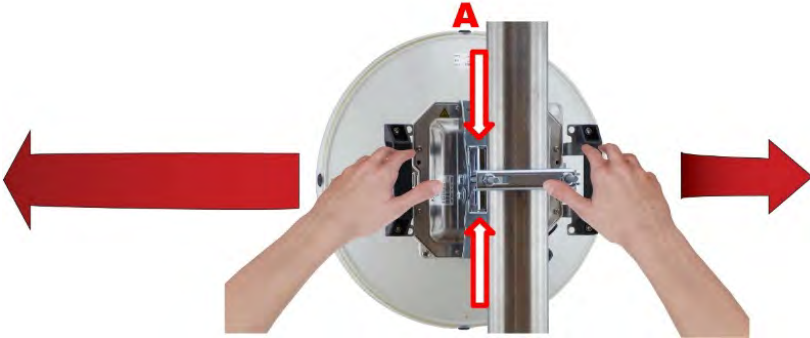
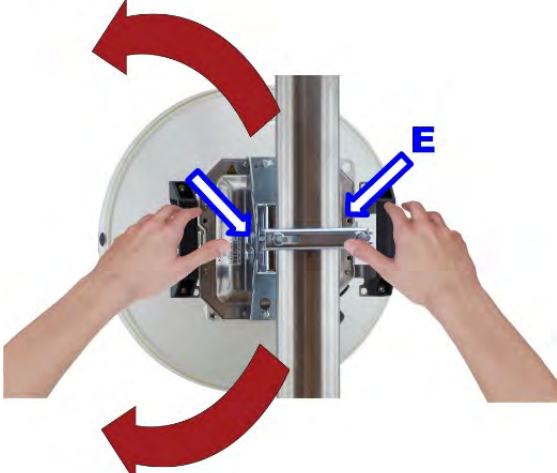

Procedure for WiBAS-Connect Auto-Polarization TS with Parabolic Low Profile Antenna, continued

Step	Action
4	<p>Perform fine alignment, as follows:</p> <ul style="list-style-type: none"> Use the spanner key to loosen the azimuth adjustment bolts (A). Perform azimuth adjustment by holding tool's handles firmly and slightly move the antenna/radio combo (within the $\pm 10^\circ$ range around the azimuth axis) until the voltage readout reaches a desired level.  <p>Note (A) = Azimuth bolts x 2 (up and down)</p> <ul style="list-style-type: none"> Use the spanner key to loosen the elevation adjustment bolts (E). Perform elevation adjustment by holding tool's handles firmly and slightly move the antenna/radio combo (within the $\pm 10^\circ$ range around the elevation axis) until the voltage readout reaches a desired level.  <p>Note (E) = Elevation bolts x 2 (left and right).</p> <p>The captured QI value is related to V (vertical) polarization and should be recorded.</p> <p>Note The RSSI voltage (actually the voltmeter value) provides a direct relationship with RSL. For WiBAS-Connect see WiBAS-Connect terminal station RSSI measurement calculation formula on page 41).</p>

Continued on next page

WiBAS-Connect TS (Auto-Polarization Edition), Continued

Procedure for WiBAS-Connect Auto-Polarization TS with Parabolic Low Profile Antenna,
continued

Step	Action
5	<p data-bbox="300 472 727 506">Perform the following actions:</p> <ul data-bbox="300 524 1294 651" style="list-style-type: none"><li data-bbox="300 524 1294 591">• Remove the RSSI cable from TS and after 2-3 seconds inserted again (as described to RSSI cable connection procedure on page 42).<li data-bbox="300 618 1198 651">• Wait 30 seconds. During boot process the voltmeter shows ~2.5 V. <p data-bbox="316 680 1366 748"> Please do not perform any action till the boot process of the TS is completed.</p> <ul data-bbox="300 779 1398 965" style="list-style-type: none"><li data-bbox="300 779 1398 813">• After boot process the TS starts automatic process scan (horizontal), and:<ul data-bbox="320 824 1398 965" style="list-style-type: none"><li data-bbox="320 824 1398 891">– S/W selects F1 frequency (in horizontal polarization) and requires 10 seconds to provide the QI value on the voltmeter.<li data-bbox="320 898 1398 965">– S/W selects F2 frequency (in horizontal polarization) and requires 10 seconds to provide the QI value on the voltmeter. <p data-bbox="316 994 1038 1039"> For QI values please refer to QI table on page 93.</p>

Continued on next page

WiBAS-Connect TS (Auto-Polarization Edition), Continued

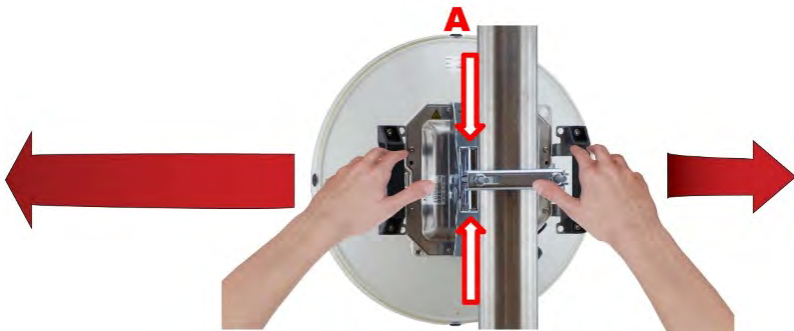
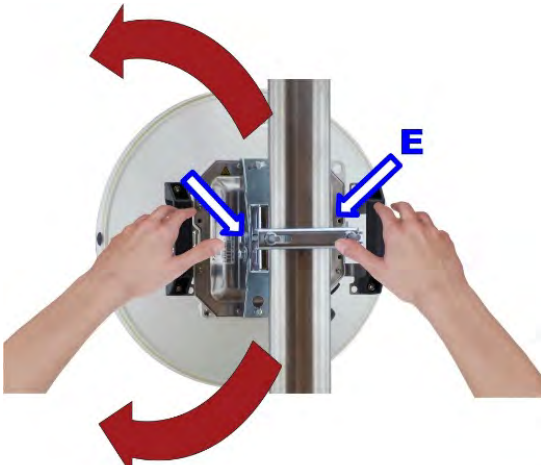

Procedure for WiBAS-Connect Auto-Polarization TS with Parabolic Low Profile Antenna, continued

Step	Action
6	<p>Perform fine alignment, as follows:</p> <ul style="list-style-type: none"> Use the spanner key to loosen the azimuth adjustment bolts (A). Perform azimuth adjustment by holding tool's handles firmly and slightly move the antenna/radio combo (within the $\pm 10^\circ$ range around the azimuth axis) until the voltage readout reaches a desired level.  <p>Note (A) = Azimuth bolts x 2 (up and down)</p> <ul style="list-style-type: none"> Use the spanner key to loosen the elevation adjustment bolts (E). Perform elevation adjustment by holding tool's handles firmly and slightly move the antenna/radio combo (within the $\pm 10^\circ$ range around the elevation axis) until the voltage readout reaches a desired level.  <p>Note (E) = Elevation bolts x 2 (left and right).</p> <p>The captured QI value is related to H (horizontal) polarization and should be recorded.</p> <p>Note The RSSI voltage (actually the voltmeter value) provides a direct relationship with RSL. For WiBAS-Connect see WiBAS-Connect terminal station RSSI measurement calculation formula on page 41).</p>

Continued on next page

WiBAS-Connect TS (Auto-Polarization Edition), Continued



Procedure for WiBAS-Connect Auto-Polarization TS with Parabolic Low Profile Antenna, continued

Step	Action
7	The commissioner should compare the captured values from steps 4 and 6. <ul style="list-style-type: none"> • If the horizontal value is better than vertical then perform the steps 9 and 10. • If the vertical value (captured on step 4) is better than horizontal then proceed to the next step.
8	<p>Perform the following actions:</p> <ul style="list-style-type: none"> • Remove the RSSI cable from TS and after 2-3 seconds inserted again (as described to RSSI cable connection procedure on page 42). • Wait 30 seconds. During boot process the voltmeter shows ~2.5 V. <p> Please do not perform any action till the boot process of the TS is completed.</p> <ul style="list-style-type: none"> • After boot process the TS starts automatic process scan (vertical), and: <ul style="list-style-type: none"> – S/W selects F1 frequency (in horizontal polarization) and requires 10 seconds to provide the QI value on the voltmeter. – S/W selects F2 frequency (in horizontal polarization) and requires 10 seconds to provide the QI value on the voltmeter. <p> For QI values please refer to QI table on page 93.</p> <ul style="list-style-type: none"> • Verify on the voltmeter the QI value is maintained as previous captured on step 4.
9	Permanently remove the RSSI cable and install the protection cover.

Continued on next page

WiBAS-Connect TS (Auto-Polarization Edition), Continued

Procedure for WiBAS-Connect Auto-Polarization TS with Parabolic Low Profile Antenna,
continued

Step	Action
10	<p>If the values are the expected ones, then secure the antenna to the final position.</p> <p>Use the adjustable U-wrench to apply the final tightening torque to the bolts, as follows:</p> <ul style="list-style-type: none"> • M5 bolts max tightening torque 5.5 Nm. • M8 bolts max tightening torque 15 Nm. • U-Bolt fully tightening. Do not over tighten. Overtightening will cause deformation of the support clamp. <p> Do not over tighten. Be very careful when tightening the adjustment bolts not to move the antenna.</p> <p> After alignment completion DO NOT leave radio unit RSSI receptacle without cover. Covering receptacles protect against humidity penetration.</p>

End of procedure

6.4. Checking Operation

Hub procedure This paragraph describes how to check the WiBAS™-OSDR Hub operation (taking in consideration that all commissioning works have been completed successfully):

Step	Action
1	Communicate with WiBAS™ OSDR-Hub through inband.
2	<p>Go to Equipment Management > Radio and check the status as shown below:</p>  <p>Go to Equipment Management > Modem and check the status.</p>
3	<p>Go to Summary > Terminals and check the values of the following:</p> <ul style="list-style-type: none"> • Connectivity: connected • Physical Mode (UL & DL): “based on the radio planning data” • RSSI: “based on the radio planning data” • SNR: “based on the system expected data”
4	Go to Alarm List and check if active alarms exist (without preventing system operation).
5	<p>Go to Service Provisioning and check if the values of the following are the expected ones:</p> <ul style="list-style-type: none"> • Bridge • Ethernet CoS Flow • Synchronization⁽¹⁾

End of procedure.

Continued on next page

⁽¹⁾ Synchronization is related to WiBAS-OSDR Hub only.

Checking Operation, Continued

Terminal station procedure

This paragraph describes how to check the WiBAS™-OSDR TS or WiBAS™-Connect operation (taking in consideration that all commissioning works have been completed successfully):

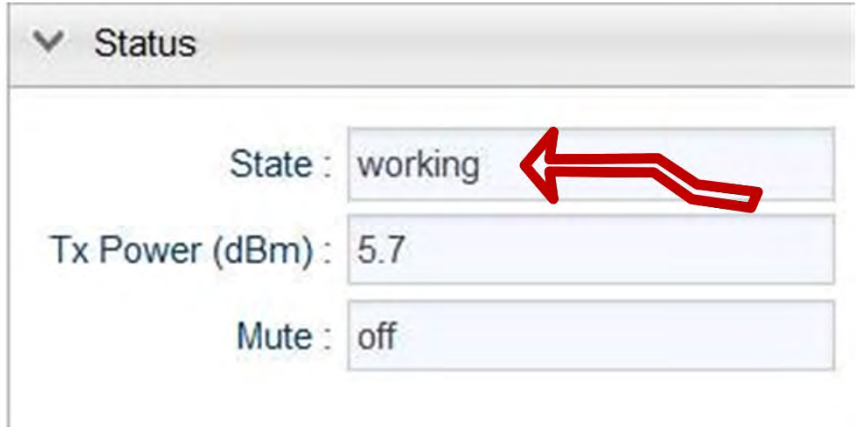
Step	Action
1	Communicate with terminal station through inband.
2	<p>Go to Equipment Management > Radio and check the status as shown below:</p>  <p>Go to Equipment Management > Modem and check the status.</p>
3	<p>Go to Summary > Terminals and check the values of the following:</p> <ul style="list-style-type: none"> • Connectivity: connected • Physical Mode (UL & DL): “based on the radio planning data” • RSSI: “based on the radio planning data” • SNR: “based on the system expected data”
4	Go to Alarm List and check if active alarms exist (without preventing system operation).
5	<p>Go to Service Provisioning and check if the values of the following are the expected ones:</p> <ul style="list-style-type: none"> • Bridge • Ethernet CoS Flow • Synchronization⁽¹⁾

End of procedure.

⁽¹⁾ Synchronization is related to WiBAS-OSDR TS only.

6.5. Service Provisioning

Overview Service provisioning is performed upon commissioning completion of the base station and terminal station as well.

Procedure To perform service provisioning, please follow the steps below:

Step	Task	WiBAS-OSDR Node Manager Manual	Concerns to WiBAS™ ...		
			Hub	TS	Connect
1	Terminal Station	How to add a terminal station refer to chapter 6/6.1, paragraph " <u>Adding a Terminal Station</u> ".	√	-	-
2	Classifier Rule Profile	How to add a classifier rule profile refer to chapter 6/6.1, paragraph " <u>Adding a Classifier Rule Profile</u> ".	√	-	-
3	Service Class Profile	How to add a service class profile refer to chapter 6/6.1, paragraph " <u>Adding a Service Class Profile</u> ".	√	-	-
4	Service Flow Profile	How to add a service flow profile refer to chapter 6/6.1, paragraph " <u>Adding a Service Flow Profile</u> ".	√	-	-
5	Service Bundle	How to add a service bundle refer to chapter 6/6.1, paragraph " <u>Adding a Service Bundle</u> ".	√	-	-
6	Service Bundle to a Terminal Station	How to add a service bundle to a terminal station refer to chapter 6/6.1, paragraph " <u>Adding a Service Bundle to a Terminal Station</u> ".	√	-	-

Continued on next page

Service Provisioning, Continued

Procedure, continued

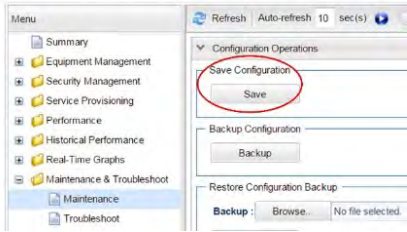
Step	Task	WiBAS-OSDR Node Manager Manual	Concerns to WiBAS™ ...		
			Hub	TS	Connect
7	Bridge	How to configure the bridge refer to chapter 6/6.2, paragraph “Configuring the Bridge”.	√	√	√
8	L2 Ports	How to configure the L2 ports refer to Chapter 6/6.2, paragraph “Configuring the L2 Ports”.	√	√	√
9	VLANs / VLAN Ports	How to add VLANs / VLAN ports refer to Chapter 6/6.2, paragraph “Adding VLANs / VLAN Ports”.	√	√	√
10	L2CP	How to configure L2CP refer to Chapter 6/6.2, paragraph “Configuring L2CP”.	√	√	√
11	Bandwidth Profile	How to add a bandwidth profile refer to Chapter 6/6.3, paragraph “Adding a Bandwidth Profile”.	√	√	√
12	Ethernet CoS Flow	How to add an Ethernet CoS flow profile refer to Chapter 6/6.3, paragraph “Adding an Ethernet CoS Flow”.	√	√	√
13	Synchronization (QL Mode e.t.c).	How to configure the synchronization refer to Chapter 6/6.4, paragraph “Configuring SyncE”.	√	√	-
14	Backup configuration	<p>Log in to base station and terminal station and go to Maintenance & Troubleshoot > Maintenance.</p> <p>Click on the backup tab, as shown below</p>  <p>and save the file with tar extension.</p>	√	√	√







End of procedure.

Appendix A – LED Indications







Radio unit LED status

The LED at the bottom of radio unit provides visual indications of the system status:

WiBAS™-OSDR Hub:

Status of STAT LED	System Condition
 OFF	Input power supply is absent.
 Stable ON, green	<ul style="list-style-type: none"> Firmware upgrade Power up
 Blinking green	firmware download Link in operation
 Stable ON, orange	Base station mute on
 Blinking orange	TS in ranging invitation
 Stable ON, red	<ul style="list-style-type: none"> on power cord insertion (hot) remove power cord

WiBAS™-OSDR Terminal Station:







Status of STAT LED	System Condition
 OFF	Input power supply is absent.
 Stable ON, green	<ul style="list-style-type: none"> Firmware upgrade Power up
 Blinking green	<ul style="list-style-type: none"> Firmware download Link in operation
 Stable ON, orange	Admin down TS with rf link lock
 Stable ON, red	<ul style="list-style-type: none"> on power cord insertion (hot) remove power cord
 Blinking red	<ul style="list-style-type: none"> BS mute on TS with no DL lock

Continued on next page

Appendix A – LED Indications, Continued

Radio unit LED status, continued

WiBAS™-Connect







Status of STAT LED	System Condition
 OFF	Input power supply is absent.
 Stable ON, green	<ul style="list-style-type: none"> Firmware upgrade Power up
 Blinking green	<ul style="list-style-type: none"> Terminal is registered RF Link in operation Firmware download
 Stable ON, orange	Admin down TS with rf link lock
 Stable ON, red	Power cord insertion (hot)
 Blinking red	<ul style="list-style-type: none"> BS mute on TS with no DL lock During automatic scan process (not registered)

Continued on next page

Appendix A – LED Indications, Continued

POE-ID-AC35







LED Indication	Description	
POWER LED		
	Off	Input power supply is absent.
	On	AC power OK.
	Blinking	Overload (current limit).
ACTIVE LED		
	Off	No load.
	On	Normal Load.
	Blinking	Overload (current limit).

Continued on next page

Appendix A – LED Indications, Continued

PONE-OD-DC



LED Indication	Description
 Steady blue	Normal operation.
 Blinking slow (every 1 sec)	Input DC voltage is ok but radio unit is not present (at the injector's output).
 Blinking fast (every 100 msec)	Power supply failure - overload, short circuit, under-voltage (below 37 V) or over-voltage (above 71 V).
 Off	Input power supply is absent.

Appendix B – Inband Management Connection Troubleshooting

Scope

Appendix B provides the following fail-safe procedures:

Fail-safe procedure	When used	Physical mngt connection	Fail-safe IP Address
Fail-safe procedure 1 (arp-s commands)	Communication with WiBAS cannot be established.	Inband	10.255.255.254
Fail-safe procedure 2 (netsh commands for Windows 10 users)	Communication with WiBAS cannot be established and, the execution of <i>fail-safe procedure 1</i> (arp-s commands) also fails. Concerns only Windows 10 users.		
Fail-safe procedure 3 (outband)	None of the above fail-safe procedures solve the communication problem.	Outband	192.168.255.254

Prerequisites

Prior to performing a fail-safe procedure, ensure that:

- The laptop user has *admin* rights.
- The laptop firewall hasn't blocked Ping and ICMP Echo Replies.

Fail-safe procedure 1 (arp-s commands)

To apply fail-safe inband IP address, please follow the steps below:



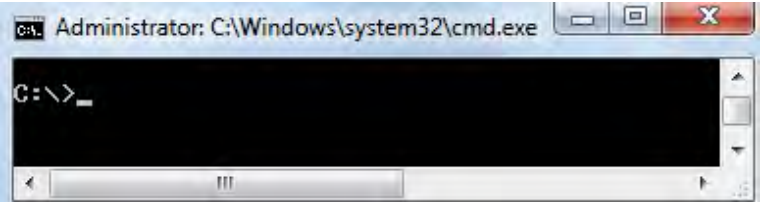

Prior to starting *fail-safe procedure 1*, ensure that an inband physical management connection has been implemented on node.

Step	Action
1	Setup to laptop the Ethernet IP address 10.255.255.253 with subnet mask 255.255.255.252 .
2	Open Windows Command Prompt . 

Continued on next page

Appendix B – Inband Management Connection Troubleshooting, Continued

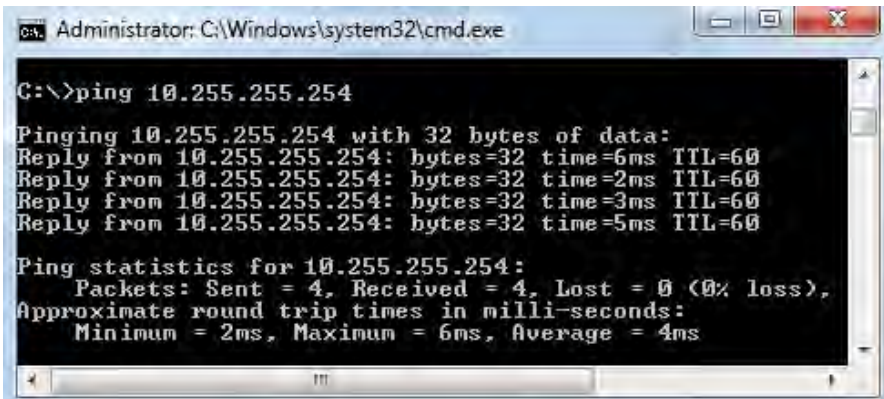
Fail-safe procedure 1 (arp-s commands), continued

Step	Action
3	<p>Enter the following static ARP cache entry and press ENTER:</p> <div style="border: 1px solid blue; padding: 2px; display: inline-block; margin-bottom: 5px;">  Note </div> Static ARP entry is not required when management VLAN is assigned as default VLAN on the connection port. <pre style="margin-top: 10px;">arp-s 10.255.255.254 00-05-59-64-06-33</pre>
4	<p>Verify that you can ping the node, by entering the fail-safe IP address and press ENTER:</p> <pre style="text-align: center;">ping 10.255.255.254</pre> <p>Echo replies should appear:</p>  <div style="border: 1px solid blue; padding: 2px; display: inline-block; margin-top: 10px;">  Note </div> Node replies to ARP requests of fail-safe IP address when the Ethernet link is up.
5	Access WiBAS via <i>Node Manager</i> by entering the fail-safe IP address (10.255.255.254).
6	<p>Perform a Restore Factory Default Configuration action to clear any previous configuration on node:</p> <ol style="list-style-type: none"> i. From the Menu, select Maintenance & Troubleshoot > Maintenance. ii. In the Configuration Operations > Restore Default Configuration group box, select <i>Factory</i> and click Restore. iii. In the confirmation message that appears, click Yes. The WiBAS returns to factory default configuration and then reboots.
7	Login again to WiBAS , by entering the default inband IP address (10.10.10.100/24).

End of procedure.

Continued on next page



Appendix B – Inband Management Connection Troubleshooting, Continued

Fail-safe procedure 2 (netsh commands for Windows 10 users)

The following procedure should be executed by a **Windows 10 user**, when the *fail-safe procedure 1* (arp-s commands) has failed to establish communication with the node:

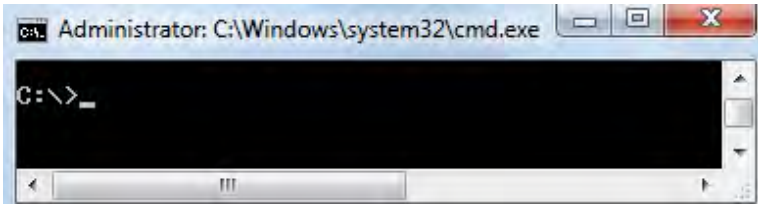

Prior to starting *fail-safe procedure 2*, ensure that an inband physical management connection has been implemented with WiBAS.

Step	Action
1	Setup to laptop the Ethernet IP address 10.255.255.253 with subnet mask 255.255.255.252 .
2	Open Windows Command Prompt . 
3	Run the following command and press ENTER: <pre>netsh interface ipv4 show neighbors</pre>
4	From the list of available interfaces, identify the number of the Ethernet interface connected to the WiBAS . <i>Example:</i> Interface 2 : Ethernet
5	Run the following command and press ENTER: <pre>netsh interface ipv4 add neighbors <Ethernet - number> 10.255.255.254 00-05-59-64-06-33 , where</pre> <p><Ethernet - number> : the number of the Ethernet interface found in previous step 4. For example, the above command is as follows: <pre>netsh interface ipv4 add neighbors 2 10.255.255.254 00-05-59-64-06-33</pre></p> <p> This command is permanent. So, if the laptop user needs to re-use the fail-safe IP address, the <i>fail-safe procedure 2</i> will not need to be executed again.</p> <p> If you want to remove the MAC binding, run the command below and press ENTER: <pre>netsh interface ipv4 del neighbors <Ethernet - number> 10.255.255.254 00-05-59-64-06-33</pre></p>
6	Follow steps 4 to 7 provided in Fail-safe procedure 1 (arp-s commands) on page 89 .

End of procedure.

Continued on next page

Appendix B – Inband Management Connection Troubleshooting, Continued

Fail-safe procedure 3 (outband)

To apply fail-safe outband IP address, please follow the steps below:

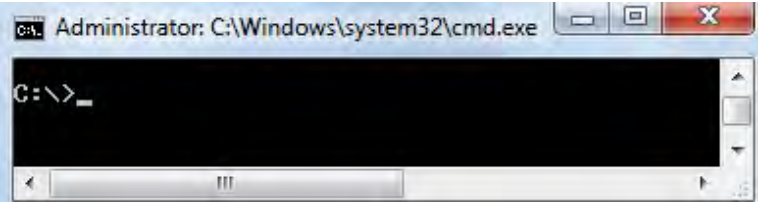

Prior to starting *fail-safe procedure 3*, ensure that an outband physical management connection has been implemented with WiBAS .

Step	Action
1	Setup to laptop the Ethernet IP address 192.168.255.253 with subnet mask 255.255.255.0 .
2	Open Windows Command Prompt . 
3	Verify that you can ping the node, by entering the fail-safe outband IP address and press ENTER: <pre>ping 192.168.255.254</pre> Echo replies should appear. Node replies to ARP requests of fail-safe IP address when the Ethernet link is up.
4	Access WiBAS via <i>Node Manager</i> by entering the fail-safe outband IP Address (192.168.255.254).
5	Perform a Restore Factory Default Configuration action to clear any previous configuration on node: <ol style="list-style-type: none"> i. From the Menu, select Maintenance & Troubleshoot > Maintenance. ii. In the Configuration Operations > Restore Default Configuration group box, select <i>Factory</i> and click Restore. iii. In the confirmation message that appears, click Yes. The WiBAS returns to factory default configuration and then reboots.
6	Login again to WiBAS by entering the default outband IP address (192.168.1.100/24). Alternatively, you can change laptop's connection from outband to inband and login by entering the default inband IP address (10.10.10.100/24).

End of procedure.

Appendix C – Quality Indicator Thresholds

QI table

The following table shows the quality indicator thresholds:

Mode	QI THRESHOLD (dBm)	QI THRESHOLD (Voltmeter reading)	
		HORIZONTAL	VERTICAL
qam4-1/2	-83	1.83	0.83
qam4-3/4	-77	1.77	0.77
qam4-5/6	-75	1.75	0.75
qam16-3/4	-72	1.72	0.72
qam16-5/6	-69	1.69	0.69
qam64-19/24	-65	1.65	0.65
qam128-19/24	-62	1.62	0.62
qam256-19/24	-58	1.58	0.58
qam512-19/24	-55	1.55	0.55
qam1024-19/24	-52	1.52	0.52
qam1024-5/6	-50	1.5	0.5

Intracom Telecom Regional Contacts

Europe

19.7 km. Markopoulou Ave.
19002 Peania, Athens
Greece
t: +30 2106671000
sales@intracom-telecom.com

Iberia & LATAM

Avenida Manoteras 8, Gate 4,
Office 1K, 28050 Madrid
Spain
t: +34 910 616661
sales@intracom-telecom.com

Russia & CIS

23 Novoslobodskaya Str., BC "Meyerhold"
Office 364, Moscow, 127055
Russia
t: +7 495 7800492
sales@intracom-telecom.com

North America

3885 Crestwood Parkway
Suite 100, Duluth,
Georgia 30096
USA
t: +1 770 2952500
sales@intracom-telecom.com

Middle East & APAC

Building No. 3, Office No. 204
P.O. Box 500517, Dubai
Internet City, Dubai
United Arab Emirates
t: +971 4 3625666
sales@intracom-telecom.com

Africa

Unit 29, Cambridge Office Park
5 Bauhinia Street, Highveld Technopark
Centurion, Gauteng
South Africa
t: +27 12 8800260
sales@intracom-telecom.com

