



# SAR TEST REPORT

For

Shenzhen Huafurui Technology Co., Ltd.

Smartphone

Test Model:NOTE 50

Additional Model No: /

Prepared for : Shenzhen Huafurui Technology Co., Ltd.  
Address : Unit 1401 & 1402, 14/F, Jinqi Zhigu Mansion (No. 4 Building of Chongwen Garden), Crossing of the Liuxian Street and Tangling Road, Taoyuan Street, Nanshan District, Shenzhen, 518055, P.R. China

Prepared by : Shenzhen LCS Compliance Testing Laboratory Ltd.  
Address : 101, 201 Bldg A & 301 Bldg C, Juji Industrial Park Yabianxueziwei, Shajing Street, Baoan District, Shenzhen, 518000, China  
Tel : (86)755-82591330  
Fax : (86)755-82591332  
Web : www.LCS-cert.com  
Mail : webmaster@LCS-cert.com

Date of receipt of test sample : May 15, 2023  
Number of tested samples : 1  
Sample No. : A051523059-1  
Serial number : Prototype  
Date of Test : May 15, 2023~June 05, 2023  
Date of Report : June 14, 2023





### SAR TEST REPORT

Report Reference No.....: **LCSA051523059EB**

Date Of Issue.....: June 14, 2023

Testing Laboratory Name.....: **Shenzhen LCS Compliance Testing Laboratory Ltd.**

Address.....: 101, 201 Bldg A & 301 Bldg C, Juji Industrial Park Yabianxueziwei, Shajing Street, Baoan District, Shenzhen, 518000, China

Testing Location/ Procedure.....: Full application of Harmonised standards   
Partial application of Harmonised standards   
Other standard testing method

Applicant's Name.....: **Shenzhen Huafurui Technology Co., Ltd.**

Address.....: Unit 1401 & 1402, 14/F, Jinqi Zhigu Mansion (No. 4 Building of Chongwen Garden), Crossing of the Liuxian Street and Tangling Road, Taoyuan Street, Nanshan District, Shenzhen, 518055, P.R. China

**Test Specification:**

Standard.....: IEEE Std C95.1, 2019/IEC-IEEE 62209-1528-2020/FCC Part 2.1093

Test Report Form No.....: LCSEMC-1.0

TRF Originator.....: Shenzhen LCS Compliance Testing Laboratory Ltd.

Master TRF.....: Dated 2011-03

**Shenzhen LCS Compliance Testing Laboratory Ltd. All rights reserved.**

This publication may be reproduced in whole or in part for non-commercial purposes as long as the Shenzhen LCS Compliance Testing Laboratory Ltd. is acknowledged as copyright owner and source of the material. Shenzhen LCS Compliance Testing Laboratory Ltd. takes no responsibility for and will not assume liability for damages resulting from the reader's interpretation of the reproduced material due to its placement and context.

Test Item Description.....: **Smartphone**

Trade Mark.....: CUBOT

Model/Type Reference.....: NOTE 50

Operation Frequency.....: LTE2,4,5,7,12,17,66;

GSM 850,1900;WCDMA II/IV/V;

WLAN2.4G,WLAN5.2G,WLAN5.8Gand Bluetooth5.0.

Ratings.....: Input: 5.0V==2.0A

For AC Adapter Input: 100-240V~, 50/60Hz, 0.3A

Adapter Output: 5.0V==2.0A, 10.0W

DC 3.87V by Rechargeable Li-ion Battery, 5200mAh

Result .....: **Positive**

Compiled by:

Jay Zhan/ File administrators

Supervised by:

Cary Luo / Technique principal

Approved by:

Gavin Liang/ Manager





### SAR -- TEST REPORT

<b>Test Report No. :</b>	<b>LCSA051523059EB</b>	<u>June 14, 2023</u> Date of issue
--------------------------	------------------------	---------------------------------------

Type / Model.....	: NOTE 50
EUT.....	: Smartphone
<b>Applicant.....</b>	<b>: Shenzhen Huafului Technology Co., Ltd.</b>
Address.....	: Unit 1401 & 1402, 14/F, Jinqi Zhigu Mansion (No. 4 Building of Chongwen Garden), Crossing of the Liuxian Street and Tangling Road, Taoyuan Street, Nanshan District, Shenzhen, 518055, P.R. China
Telephone.....	: /
Fax.....	: /
<b>Manufacturer.....</b>	<b>: Shenzhen Huafului Technology Co., Ltd.</b>
Address.....	: Unit 1401 & 1402, 14/F, Jinqi Zhigu Mansion (No. 4 Building of Chongwen Garden), Crossing of the Liuxian Street and Tangling Road, Taoyuan Street, Nanshan District, Shenzhen, 518055, P.R. China
Telephone.....	: /
Fax.....	: /
<b>Factory.....</b>	<b>: Shenzhen Huafului Technology Co., Ltd.</b>
Address.....	: Unit 1401 & 1402, 14/F, Jinqi Zhigu Mansion (No. 4 Building of Chongwen Garden), Crossing of the Liuxian Street and Tangling Road, Taoyuan Street, Nanshan District, Shenzhen, 518055, P.R. China
Telephone.....	: /
Fax.....	: /
<b>Test Result</b>	
<b>Positive</b>	

The test report merely corresponds to the test sample.  
 It is not permitted to copy extracts of these test result without the written permission of the test laboratory.





### Revision History

Revision	Issue Date	Revision Content	Revised By
000	June 14, 2023	Initial Issue	---





# TABLE OF CONTENTS

- 1. TEST STANDARDS AND TEST DESCRIPTION ..... 6**
  - 1.1. TEST STANDARDS .....6
  - 1.2. TEST DESCRIPTION ..... 6
  - 1.3. GENERAL REMARKS .....6
  - 1.4. PRODUCT DESCRIPTION .....6
  - 1.5. STATEMENT OF COMPLIANCE .....9
- 2. TEST ENVIRONMENT ..... 10**
  - 2.1. TEST FACILITY ..... 10
  - 2.2. ENVIRONMENTAL CONDITIONS .....10
  - 2.3. SAR LIMITS .....10
  - 2.4. EQUIPMENTS USED DURING THE TEST ..... 11
- 3. SAR MEASUREMENTS SYSTEM CONFIGURATION ..... 12**
  - 3.1. SARMEASUREMENT SET-UP ..... 12
  - 3.2. OPENSAR E-FIELD PROBE SYSTEM ..... 13
  - 3.3. PHANTOMS ..... 14
  - 3.4. DEVICE HOLDER .....14
  - 3.5. SCANNING PROCEDURE ..... 15
  - 3.6. DATA STORAGE AND EVALUATION .....17
  - 3.7. TISSUE DIELECTRIC PARAMETERS FOR HEAD AND BODY PHANTOMS ..... 19
  - 3.8. TISSUE EQUIVALENT LIQUID PROPERTIES ..... 19
  - 3.9. SYSTEM CHECK ..... 20
  - 3.10. SAR MEASUREMENT PROCEDURE ..... 22
  - 3.11. POWER REDUCTION ..... 27
  - 3.12. POWER DRIFT ..... 27
- 4. TEST CONDITIONS AND RESULTS ..... 28**
  - 4.1. CONDUCTED POWER RESULTS ..... 28
  - 4.2. TRANSMIT ANTENNAS AND SAR MEASUREMENT POSITION ..... 49
  - 4.3. SAR MEASUREMENT RESULTS ..... 50
  - 4.4. SIMULTANEOUS TX SAR CONSIDERATIONS ..... 58
  - 4.5. SAR MEASUREMENT VARIABILITY ..... 64
  - 4.6. GENERAL DESCRIPTION OF TEST PROCEDURES ..... 65
  - 4.7. MEASUREMENT UNCERTAINTY (450MHZ-6GHZ) ..... 65
  - 4.8. SYSTEM CHECK RESULTS ..... 66
  - 4.9. SAR TEST GRAPH RESULTS ..... 74
- 5. CALIBRATION CERTIFICATES ..... 104**
  - 5.1 PROBE-EPGO376 CALIBRATION CERTIFICATE ..... 104
  - 5.2 SID750DIPOLE CALIBRATION CERITICATE ..... 115
  - 5.3 SID835DIPOLE CALIBRATION CERITICATE ..... 126
  - 5.4 SID1800 DIPOLE CALIBRATION CERTIFICATE ..... 137
  - 5.5 SID1900 DIPOLE CALIBRATION CERTIFICATE ..... 148
  - 5.6 SID2450 DIPOLE CALIBRATION CERITICATE ..... 159
  - 5.7 SID2600 DIPOLE CALIBRATION CERITICATE ..... 170
  - 5.8 SID5G-6G DIPOLE CALIBRATION CERITICATE ..... 181
- 6. PHOTOGRAPHS OF THE LIQUID ..... 194**
- 7. PHOTOGRAPHS OF THE TEST ..... 198**
- 8. EUT PHOTOGRAPHS ..... 199**





# 1. TEST STANDARDS AND TEST DESCRIPTION

## 1.1. Test Standards

[IEEE Std C95.1, 2019](#): IEEE Standard for Safety Levels with Respect to Human Exposure to Electric, Magnetic, and Electromagnetic Fields, 0 Hz to 300 GHz. It specifies the maximum exposure limit of 1.6 W/kg as averaged over any 1 gram of tissue for portable devices being used within 20 cm of the user in the uncontrolled environment.

[IEC-IEEE 62209-1528-2020: Measurement procedure for the assessment of specific absorption rate of human exposure to radio frequency fields from hand-held and body-mounted wireless communication devices –Part 1528: Human models, instrumentation, and procedures\(Frequency range of 4 MHz to 10 GHz\)](#)

[FCC Part 2.1093: Radiofrequency Radiation Exposure Evaluation: Portable Devices](#)

[KDB447498 D01 General RF Exposure Guidance](#) : Mobile and Portable Device RF Exposure Procedures and Equipment Authorization Policies

[KDB648474 D04: Handset SAR v01r03: SAR Evaluation Considerations for Wireless Handsets](#)

[KDB865664 D01 SAR Measurement 100 MHz to 6 GHz](#) : SAR Measurement Requirements for 100 MHz to 6 GHz

[KDB865664 D02 RF Exposure Reporting](#): RF Exposure Compliance Reporting and Documentation Considerations

[KDB248227 D01 802.11 Wi-Fi SAR](#): SAR Guidance For IEEE 802.11 (Wi-Fi) Transmitters

[KDB941225 D01 3G SAR Procedures](#): 3G SAR Measurement Procedures

[KDB 941225 D06 Hotspot Mode](#): SAR Evaluation Procedures For Portable Devices With Wireless Router Capabilities

[KDB 941225 D05 SAR for LTE Devices](#): SAR Evaluation Considerations For LTE Devices

## 1.2. Test Description

The EUT battery must be fully charged and checked periodically during the test to ascertain uniform power. And Test device is identical prototype.

## 1.3. General Remarks

Date of receipt of test sample	:	May 15, 2023
Testing commenced on	:	May 15, 2023
Testing concluded on	:	June 05, 2023

## 1.4. Product Description

The Shenzhen Huafurui Technology Co., Ltd.'s Model: NOTE 50 or the "EUT" as referred to in this report; more general information as follows, for more details, refer to the user's manual of the EUT.

General Description	
EUT :	Smartphone
Model/Type reference:	NOTE 50
Additional Model No.	/
Model Declaration:	/
Hardware Version	G2233G-UF-V1.1
Software Version:	CUBOT_NOTE_50_D041C_V1.0
Power supply:	Input: 5.0V $\Rightarrow$ 2.0A For AC Adapter Input: 100-240V~, 50/60Hz, 0.3A Adapter Output: 5.0V $\Rightarrow$ 2.0A, 10.0W DC 3.87V by Rechargeable Li-ion Battery, 5200mAh
<i>The EUT is Smartphone. the Smartphone is intended for WLAN transmission. It is equipped with</i>	





Bluetooth ,WiFi2.4G,5.2G,5.8G;GSM 850,1900; WCDMA Band II, Band IV,Band V; LTE 2,4,5,7,12,17, 66. For more information see the following datasheet

Technical Characteristics	
LTE	
Support Band:	<input checked="" type="checkbox"/> E-UTRA Band 2(U.S.-Band) <input checked="" type="checkbox"/> E-UTRA Band 4(U.S.-Band) <input checked="" type="checkbox"/> E-UTRA Band 5(U.S.-Band) <input checked="" type="checkbox"/> E-UTRA Band 7(U.S.-Band) <input checked="" type="checkbox"/> E-UTRA Band 12(U.S.-Band) <input checked="" type="checkbox"/> E-UTRA Band 17(U.S.-Band) <input checked="" type="checkbox"/> E-UTRA Band 66(U.S.-Band)
Modulation Type:	QPSK/16QAM
Release Version:	R9
Power Class:	Class 3
Antenna Description:	PIFA Antenna -0.49dBi (max.) For E-UTRA Band 2 -1.05dBi (max.) For E-UTRA Band 4 -1.60dBi (max.) For E-UTRA Band 5 -0.80dBi (max.) For E-UTRA Band 7 -0.80dBi (max.) For E-UTRA Band 12 -0.80dBi (max.) For E-UTRA Band 17 -1.05dBi (max.) For E-UTRA Band 66
Bluetooth	
Frequency Range:	2402MHz ~ 2480MHz
Chanel Number:	79 channels for Bluetooth V5.0 (DSS) 40 channels for Bluetooth V5.0 (DTS)
Chanel Spacing:	1MHz for Bluetooth V5.0 (DSS) 2MHz for Bluetooth V5.0 (DTS)
Modulation Type;	GFSK, $\pi/4$ -DQPSK, 8-DPSK for Bluetooth V5.0 (DSS) GFSK for Bluetooth V5.0 (DTS)
Bluetooth Version:	V5.0
Antenna Description:	PIFA Antenna, 2.63dBi (max.)
WIFI 2.4G	
Frequency Range:	2412MHz-2462MHz
Type of Modulation:	IEEE 802.11b: DSSS (CCK, DQPSK, DBPSK) IEEE 802.11g: OFDM (64QAM, 16QAM, QPSK, BPSK) IEEE 802.11n: OFDM (64QAM, 16QAM, QPSK, BPSK)
Channel number:	11 Channels for 20MHz bandwidth (2412~2462MHz)
Channel separation:	5MHz
Antenna Description:	PIFA Antenna, 2.63dBi (max.)
5.2G WLAN	
Frequency Range	5180MHz~5240MHz
Channel Number	4 Channels for 20MHz bandwidth(5180MHz~5240MHz) 2 channels for 40MHz bandwidth(5190MHz~5230MHz) 1 channels for 80MHz bandwidth(5210MHz)
Modulation Type	IEEE 802.11a: OFDM (64QAM, 16QAM, QPSK, BPSK) IEEE 802.11n: OFDM (64QAM, 16QAM, QPSK, BPSK) IEEE 802.11ac: OFDM (256QAM, 64QAM, 16QAM, QPSK, BPSK)
Antenna Description	PIFA Antenna, 1.74dBi (max.)
5.8G WLAN	
Frequency Range	5745MHz-5825MHz
Channel Number	5 channels for 20MHz bandwidth(5745MHz~5825MHz) 2 channels for 40MHz bandwidth(5755MHz~5795MHz) 1 channels for 80MHz bandwidth(5775MHz)



Shenzhen LCS Compliance Testing Laboratory Ltd.

Add: 101, 201 Bldg A & 301 Bldg C, Juji Industrial Park Yabianxueziwei, Shajing Street, Baoan District, Shenzhen, 518000, China

Tel: +(86) 0755-82591330 | E-mail: webmaster@lcs-cert.com | Web: www.lcs-cert.com

Scan code to check authenticity



Modulation Type	IEEE 802.11a: OFDM (64QAM, 16QAM, QPSK, BPSK) IEEE 802.11n: OFDM (64QAM, 16QAM, QPSK, BPSK) IEEE 802.11ac: OFDM (256QAM, 64QAM, 16QAM, QPSK, BPSK)
Antenna Description	PIFA Antenna, 1.74dBi (max.)
<b>UMTS</b>	
Support Band:	<input checked="" type="checkbox"/> WCDMA Band II (U.S.-Band) <input checked="" type="checkbox"/> WCDMA Band V (U.S.-Band) <input checked="" type="checkbox"/> WCDMA Band IV (U.S.-Band)
Modulation Type:	QPSK,16QAM
WCDMA Release Version:	R8
Antenna Description:	PIFA Antenna -0.49dBi (max.) For WCDMA Band II -1.05dBi (max.) For WCDMA Band IV -1.60dBi (max.) For WCDMA Band V
<b>GSM</b>	
Support Band:	<input checked="" type="checkbox"/> GSM 850 (U.S.-Band) <input checked="" type="checkbox"/> PCS 1900 (U.S.-Band)
Release Version:	R99
GPRS Class	Class 12
EGPRS Class	Class 12
Modulation Type:	GMSK for GSM/GPRS; GMSK/8PSK for EGPRS
Antenna Description:	PIFA Antenna -1.60dBi (max.) For GSM 850 -0.49dBi (max.) For PCS 1900
<b>NFC</b>	
Operating Frequency	13.56MHz
Modulation Type	ASK
Antenna Description	PIFA Antenna, 0dBi (max.)
GPS function	Support and only RX
FM function	Support and only RX







### 1.5. Statement of Compliance

The maximum of results of SAR found during testing for NOTE 50 are follows:

<Highest Reported standalone SAR Summary>

Classment Class	Frequency Band	Head (Report SAR <sub>1-g</sub> (W/kg))	Hotspot (Report SAR <sub>1-g</sub> (W/kg))	Body-worn (Report SAR <sub>1-g</sub> (W/kg))
			(Separation Distance 10mm)	
PCE	GSM 850	0.078	0.368	0.368
	GSM1900	0.064	0.259	0.259
	WCDMA Band V	0.083	0.313	0.313
	WCDMA Band IV	0.127	0.310	0.310
	WCDMA Band II	0.117	0.424	0.424
	LTE band 2	0.098	0.383	0.383
	LTE band 4	0.060	0.219	0.219
	LTE band 5	0.060	0.260	0.260
	LTE band 7	0.050	0.719	0.719
	LTE band 12	0.057	0.171	0.171
	LTE band 17	0.064	0.202	0.202
DTS	WIFI2.4G	0.011	0.147	0.147
NII	WIFI5.2G	0.048	0.055	0.055
	WIFI5.8G	0.016	0.014	0.014

This device is in compliance with Specific Absorption Rate (SAR) for general population/uncontrolled exposure limits (1.6 W/kg) specified in FCC 47 CFR part 2 (2.1093) and ANSI/IEEE C95.1-2019, and had been tested in accordance with the measurement methods and procedures specified in IEC-IEEE 62209-1528-2020.

<Highest Reported simultaneous SAR Summary>

Exposure Position	Classment Class	Highest Reported Simultaneous Transmission SAR <sub>1-g</sub> (W/kg)
Body (hotspot open)	PCE	<b>0.923</b>
	DTS	





## 2. TEST ENVIRONMENT

### 2.1. Test Facility

The test facility is recognized, certified, or accredited by the following organizations:

Site Description

Sar Lab.

: NVLAP Accreditation Code is 600167-0.

FCC Designation Number is CN5024.

CAB identifier is CN0071.

CNAS Registration Number is L4595.

Test Firm Registration Number: 254912

### 2.2. Environmental conditions

During the measurement the environmental conditions were within the listed ranges:

Temperature:	18-25 ° C
Humidity:	40-65 %
Atmospheric pressure:	950-1050mbar

### 2.3. SAR Limits

FCC Limit (1g Tissue)

EXPOSURE LIMITS	SAR (W/kg)	
	(General Population / Uncontrolled Exposure Environment)	(Occupational / Controlled Exposure Environment)
Spatial Average(averaged over the whole body)	0.08	0.4
Spatial Peak(averaged over any 1 g of tissue)	1.6	8.0
Spatial Peak(hands/wrists/ feet/anklesaveraged over 10 g)	4.0	20.0

Population/Uncontrolled Environments are defined as locations where there is the exposure of individual who have no knowledge or control of their exposure.

Occupational/Controlled Environments are defined as locations where there is exposure that may be incurred by people who are aware of the potential for exposure (i.e. as a result of employment or occupation).



Shenzhen LCS Compliance Testing Laboratory Ltd.

Add: 101, 201 Bldg A & 301 Bldg C, Juji Industrial Park Yabianxueziwei, Shajing Street, Baoan District, Shenzhen, 518000, China

Tel: +(86) 0755-82591330 | E-mail: webmaster@lcs-cert.com | Web: www.lcs-cert.com

Scan code to check authenticity



## 2.4. Equipments Used during the Test

Item	Equipment	Manufacturer	Model No.	Serial No.	Cal Date	Due Date
1	PC	Lenovo	G5005	MY42081102	N/A	N/A
2	SAR Measurement system	SATIMO	4014_01	SAR_4014_01	N/A	N/A
3	Signal Generator	Agilent	E4438C	MY49072627	2022-06-16	2023-06-15
4	S-parameter Network Analyzer	Agilent	8753ES	US38432944	2022-06-16	2023-06-15
5	Wideband Radio Communication Tester	R&S	CMW500	103818-1	2022-06-16	2023-06-15
6	E-Field PROBE	MVG	SSE2	SN 25/22 EPGO376	2022-06-29	2023-06-28
7	DIPOLE 750	SATIMO	SID 750	SN 07/14 DIP 0G750-302	2021-09-29	2024-09-28
8	DIPOLE 835	SATIMO	SID 835	SN 07/14 DIP 0G835-303	2021-09-29	2024-09-28
9	DIPOLE 1800	SATIMO	SID 1800	SN 07/14 DIP 1G800-301	2021-09-29	2024-09-28
10	DIPOLE 1900	SATIMO	SID 1900	SN 38/18 DIP 1G900-466	2021-09-22	2024-09-21
11	DIPOLE 2450	SATIMO	SID 2450	SN 07/14 DIP 2G450-306	2021-09-29	2024-09-28
12	DIPOLE 2600	SATIMO	SID 2600	SN 38/18 DIP 2G600-468	2021-09-22	2024-09-21
13	DIPOLE 5000-6000	MVG	SWG5500	SN 49/16 WGA 43	2021-09-22	2024-09-21
14	COMOSAR OPENCoaxial Probe	SATIMO	OCPG 68	SN 40/14 OCPG68	2022-10-29	2023-10-28
15	SAR Locator	SATIMO	VPS51	SN 40/14 VPS51	2022-10-29	2023-10-28
16	Communication Antenna	SATIMO	ANTA57	SN 39/14 ANTA57	2022-10-29	2023-10-28
17	FEATURE PHONEPOSITIONING DEVICE	SATIMO	MSH98	SN 40/14 MSH98	N/A	N/A
18	DUMMY PROBE	SATIMO	DP60	SN 03/14 DP60	N/A	N/A
19	SAM PHANTOM	SATIMO	SAM117	SN 40/14 SAM117	N/A	N/A
20	Liquid measurement Kit	HP	85033D	3423A03482	N/A	N/A
21	Power meter	Agilent	E4419B	MY45104493	2022-10-29	2023-10-28
22	Power meter	Agilent	E4419B	MY45100308	2022-10-29	2023-10-28
23	Power sensor	Agilent	E9301H	MY41495616	2022-10-29	2023-10-28
24	Power sensor	Agilent	E9301H	MY41495234	2022-10-29	2023-10-28
25	Directional Coupler	MCLI/USA	4426-20	03746	2022-06-16	2023-06-15

### Note:

- 1) Per KDB865664D01 requirements for dipole calibration, the test laboratory has adopted three year extended calibration interval. Each measured dipole is expected to evaluate with following criteria at least on annual interval.
  - a) There is no physical damage on the dipole;
  - b) System check with specific dipole is within 10% of calibrated values;
  - c) The most recent return-loss results, measured at least annually, deviates by no more than 20% from the previous measurement;
  - d) The most recent measurement of the real or imaginary parts of the impedance, measured at least annually is within 5Ω from the previous measurement.
- 2) Network analyzer probe calibration against air, distilled water and a shorting block performed before measuring liquid parameters.



Shenzhen LCS Compliance Testing Laboratory Ltd.

Add: 101, 201 Bldg A & 301 Bldg C, Juji Industrial Park Yabianxueziwei, Shajing Street, Baoan District, Shenzhen, 518000, China

Tel: +(86) 0755-82591330 | E-mail: webmaster@lcs-cert.com | Web: www.lcs-cert.com

Scan code to check authenticity

### 3. SAR MEASUREMENTS SYSTEM CONFIGURATION

#### 3.1. SAR Measurement Set-up

The OPENSAR system for performing compliance tests consist of the following items:

A standard high precision 6-axis robot (KUKA) with controller and software.

KUKA Control Panel (KCP)

A dosimetric probe, i.e., an isotropic E-field probe optimized and calibrated for usage in tissue simulating liquid. The probe is equipped with a Video Positioning System(VPS).

The stress sensor is composed with mechanical and electronic when the electronic part detects a change on the electro-mechanical switch,It sends an "Emergency signal" to the robot controller that to stop robot's moves

A computer operating Windows XP.

OPENSAR software

Remote control with teaches pendant and additional circuitry for robot safety such as warning lamps, etc.

The SAM phantom enabling testing left-hand right-hand and body usage.

The Position device for handheld EUT

Tissue simulating liquid mixed according to the given recipes .

System validation dipoles to validate the proper functioning of the system.

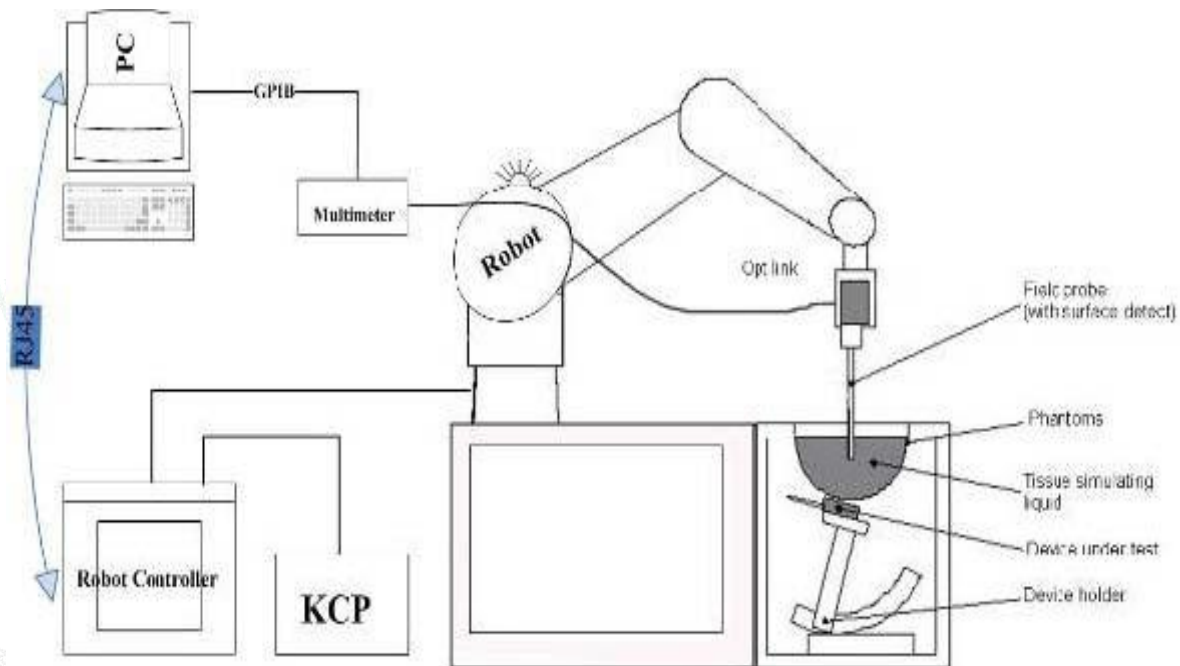



### 3.2. OPENSAR E-field Probe System

The SAR measurements were conducted with the dosimetric probe EPG0376 (manufactured by MVG), designed in the classical triangular configuration and optimized for dosimetric evaluation.

#### Probe Specification

Construction Symmetrical design with triangular core

Interleaved sensors

Built-in shielding against static charges

PEEK enclosure material (resistant to organic solvents, e.g., DGBE)

Calibration ISO/IEC 17025 calibration service available.

Frequency	450 MHz to 6 GHz; Linearity: 0.25dB(450 MHz to 6 GHz)
Directivity	0.25 dB in HSL (rotation around probe axis) 0.5 dB in tissue material (rotation normal to probe axis)
Dynamic Range	0.01W/kg to > 100 W/kg; Linearity: 0.25 dB
Dimensions	Overall length: 330 mm (Tip: 16mm) Tip diameter: 5 mm (Body: 8 mm) Distance from probe tip to sensor centers: 2.5 mm
Application	General dosimetry up to 6 GHz Dosimetry in strong gradient fields Compliance tests of Mobile Phones

#### Isotropic E-Field Probe

The isotropic E-Field probe has been fully calibrated and assessed for isotropicity, and boundary effect within a controlled environment. Depending on the frequency for which the probe is calibrated the method utilized for calibration will change.

The E-Field probe utilizes a triangular sensor arrangement as detailed in the diagram below:



Shenzhen LCS Compliance Testing Laboratory Ltd.

Add: 101, 201 Bldg A & 301 Bldg C, Juji Industrial Park Yabianxueziwei, Shajing Street, Baoan District, Shenzhen, 518000, China

Tel: +(86) 0755-82591330 | E-mail: webmaster@lcs-cert.com | Web: www.lcs-cert.com

Scan code to check authenticity

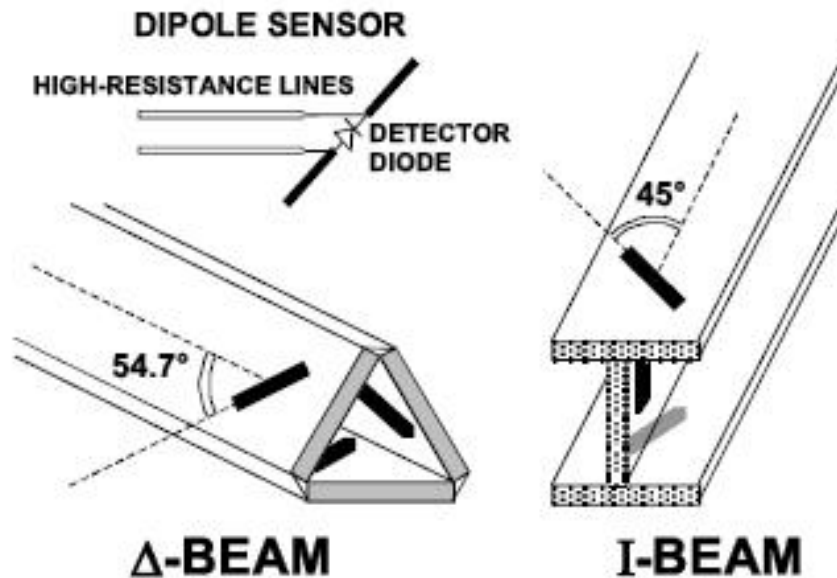

### 3.3. Phantoms

The SAM Phantom SAM117 is constructed of a fiberglass shell integrated in a wooden table. The shape of the shell is in compliance with the specification set in IEEE 1528 and EN62209-1, EN62209-2. The phantom enables the dosimetric evaluation of left and right hand phone usage as well as body mounted usage at the flat phantom region. A cover prevents the evaporation of the liquid. Reference markings on the Phantom allow the complete setup of all predefined phantom positions and measurement grids by manually teaching three points in the robot.

System checking was performed using the flat section, whilst Head SAR tests used the left and right head profile sections. Body SAR testing also used the flat section between the head profiles.

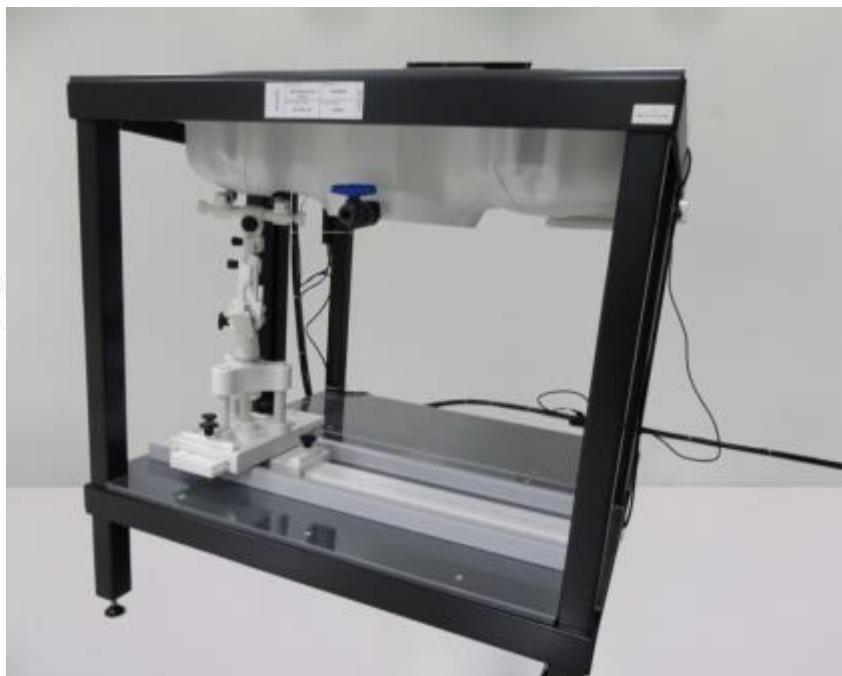

SAM Twin Phantom

### 3.4. Device Holder

In combination with the Generic Twin Phantom SAM117, the Mounting Device enables the rotation of the



mounted transmitter in spherical coordinates whereby the rotation points is the ear opening. The devices can be easily, accurately, and repeatedly positioned according to the FCC specifications. The device holder can be locked at different phantom locations (left head, right head, flat phantom).



Device holder supplied by SATIMO

### 3.5. Scanning Procedure

The procedure for assessing the peak spatial-average SAR value consists of the following steps

#### Power Reference Measurement

The reference and drift jobs are useful jobs for monitoring the power drift of the device under test in the batch process. Both jobs measure the field at a specified reference position, at a selectable distance from the phantom surface. The reference position can be either the selected section's grid reference point or a user point in this section. The reference job projects the selected point onto the phantom surface, orients the probe perpendicularly to the surface, and approaches the surface using the selected detection method.

#### Area Scan

The Area Scan is used as a fast scan in two dimensions to find the area of high field values before running a detailed measurement around the hot spot. Before starting the area scan a grid spacing of 15 mm x 15 mm is set. During the scan the distance of the probe to the phantom remains unchanged. After finishing area scan, the field maxima within a range of 2 dB will be ascertained.

	≤ 3 GHz	> 3 GHz
Maximum distance from closest measurement point (geometric center of probe sensors) to phantom surface	5 mm ± 1 mm	$\frac{1}{2} \cdot \delta \cdot \ln(2)$ mm ± 0.5 mm
Maximum probe angle from probe axis to phantom surface normal at the measurement location	30° ± 1°	20° ± 1°
Maximum area scan spatial resolution: $\Delta x_{Area}$ , $\Delta y_{Area}$	≤ 2 GHz: ≤ 15 mm 2 – 3 GHz: ≤ 12 mm	3 – 4 GHz: ≤ 12 mm 4 – 6 GHz: ≤ 10 mm
	When the x or y dimension of the test device, in the measurement plane orientation, is smaller than the above, the measurement resolution must be ≤ the corresponding x or y dimension of the test device with at least one measurement point on the test device.	

#### Zoom Scan

Zoom Scans are used to estimate the peak spatial SAR values within a cubic averaging volume containing 1 g and 10 g of simulated tissue. The default Zoom Scan is done by 7x7x7 points within a cube whose base is centered around the maxima found in the preceding area scan.





Maximum zoom scan spatial resolution: $\Delta x_{Zoom}$ , $\Delta y_{Zoom}$		$\leq 2$ GHz: $\leq 8$ mm 2 – 3 GHz: $\leq 5$ mm*	3 – 4 GHz: $\leq 5$ mm* 4 – 6 GHz: $\leq 4$ mm*
Maximum zoom scan spatial resolution, normal to phantom surface	uniform grid: $\Delta z_{Zoom}(n)$	$\leq 5$ mm	3 – 4 GHz: $\leq 4$ mm 4 – 5 GHz: $\leq 3$ mm 5 – 6 GHz: $\leq 2$ mm
	graded grid	$\Delta z_{Zoom}(1)$ : between 1 <sup>st</sup> two points closest to phantom surface	$\leq 4$ mm
		$\Delta z_{Zoom}(n>1)$ : between subsequent points	$\leq 1.5 \cdot \Delta z_{Zoom}(n-1)$ mm
Minimum zoom scan volume	x, y, z	$\geq 30$ mm	3 – 4 GHz: $\geq 28$ mm 4 – 5 GHz: $\geq 25$ mm 5 – 6 GHz: $\geq 22$ mm
<p>Note: <math>\delta</math> is the penetration depth of a plane-wave at normal incidence to the tissue medium; see IEEE Std 1528-2013 for details.</p> <p>* When zoom scan is required and the <i>reported</i> SAR from the <i>area scan based 1-g SAR estimation</i> procedures of KDB Publication 447498 is <math>\leq 1.4</math> W/kg, <math>\leq 8</math> mm, <math>\leq 7</math> mm and <math>\leq 5</math> mm zoom scan resolution may be applied, respectively, for 2 GHz to 3 GHz, 3 GHz to 4 GHz and 4 GHz to 6 GHz.</p>			







Power Drift measurement

The drift job measures the field at the same location as the most recent reference job within the same procedure, and with the same settings. The drift measurement gives the field difference in dB from the reading conducted within the last reference measurement. Several drift measurements are possible for one reference measurement. This allows a user to monitor the power drift of the device under test within a batch process. In the properties of the Drift job, the user can specify a limit for the drift and have OPENSAR software stop the measurements if this limit is exceeded.

3.6. Data Storage and Evaluation

Data Storage

The OPENSAR software stores the acquired data from the data acquisition electronics as raw data (in microvolt readings from the probe sensors), together with all necessary software parameters for the data evaluation (probe calibration data, liquid parameters and device frequency and modulation data) in measurement files . The software evaluates the desired unit and format for output each time the data is visualized or exported. This allows verification of the complete software setup even after the measurement and allows correction of incorrect parameter settings. For example, if a measurement has been performed with a wrong crest factor parameter in the device setup, the parameter can be corrected afterwards and the data can be re-evaluated.

The measured data can be visualized or exported in different units or formats, depending on the selected probe type ([V/m], [A/m], [°C], [mW/g], [mW/cm²], [dBrel], etc.). Some of these units are not available in certain situations or show meaningless results, e.g., a SAR output in a lossless media will always be zero. Raw data can also be exported to perform the evaluation with other software packages.

Data Evaluation

The OPENSAR software automatically executes the following procedures to calculate the field units from the microvolt readings at the probe connector. The parameters used in the evaluation are stored in the configuration modules of the software:

- Probe parameters: - Sensitivity Normi, ai0, ai1, ai2
- Conversion factor ConvFi
- Diode compression point Dcpi
- Device parameters: - Frequency f
- Crest factor cf
- Media parameters: - Conductivity σ
- Density ρ

These parameters must be set correctly in the software. They can be found in the component documents or they can be imported into the software from the configuration files issued for the OPENSAR components. In the direct measuring mode of the multimeter option, the parameters of the actual system setup are used. In the scan visualization and export modes, the parameters stored in the corresponding document files are used.

The first step of the evaluation is a linearization of the filtered input signal to account for the compression characteristics of the detector diode. The compensation depends on the input signal, the diode type and the DC-transmission factor from the diode to the evaluation electronics. If the exciting field is pulsed, the crest factor of the signal must be known to correctly compensate for peak power. The formula for each channel can be given as:

$$V_i = U_i + U_i^2 \cdot \frac{cf}{dcp_i}$$

- With Vi = compensated signal of channel i (i = x, y, z)
- Ui = input signal of channel i (i = x, y, z)
- cf = crest factor of exciting field
- dcp\_i = diode compression point

From the compensated input signals the primary field data for each channel can be evaluated:





E – fieldprobes : 
$$E_i = \sqrt{\frac{V_i}{Norm_i \cdot ConvF}}$$

H – fieldprobes : 
$$H_i = \sqrt{V_i \cdot \frac{a_{i0} + a_{i1}f + a_{i2}f^2}{f}}$$

- With
- $V_i$  = compensated signal of channel i (i = x, y, z)
  - $Norm_i$  = sensor sensitivity of channel i (i = x, y, z)  
[mV/(V/m)<sup>2</sup>] for E-field Probes
  - $ConvF$  = sensitivity enhancement in solution
  - $a_{ij}$  = sensor sensitivity factors for H-field probes
  - $f$  = carrier frequency [GHz]
  - $E_i$  = electric field strength of channel i in V/m
  - $H_i$  = magnetic field strength of channel i in A/m

The RSS value of the field components gives the total field strength (Hermitian magnitude):

$$E_{tot} = \sqrt{E_x^2 + E_y^2 + E_z^2}$$

The primary field data are used to calculate the derived field units.

$$SAR = E_{tot}^2 \cdot \frac{\sigma}{\rho \cdot 1'000}$$

- with
- $SAR$  = local specific absorption rate in mW/g
  - $E_{tot}$  = total field strength in V/m
  - $\sigma$  = conductivity in [mho/m] or [Siemens/m]
  - $\rho$  = equivalent tissue density in g/cm<sup>3</sup>

Note that the density is normally set to 1 (or 1.06), to account for actual brain density rather than the density of the simulation liquid.





### 3.7. Tissue Dielectric Parameters for Head and Body Phantoms

The liquid is consisted of water,salt,Glycol,Sugar,Preventol and Cellulose.The liquid has previously been proven to be suited for worst-case.It's satisfying the latest tissue dielectric parameters requirements proposed by the KDB865664.

The composition of the tissue simulating liquid

Frequency (MHz)	Bactericide	DGBE	HEC	NaCl	Sucrose	1,2-Propanediol	X100	Water	Conductivity	Permittivity
	%	%	%	%	%	%	%	%	$\sigma$	$\epsilon_r$
750	/	/	/	0.79	/	64.81	/	34.40	0.97	41.8
835	/	/	/	0.79	/	64.81	/	34.40	0.97	41.8
900	/	/	/	0.79	/	64.81	/	34.40	0.97	41.8
1800	/	13.84	/	0.35	/	/	30.45	55.36	1.38	41.0
1900	/	13.84	/	0.35	/	/	30.45	55.36	1.38	41.0
2000	/	7.99	/	0.16	/	/	19.97	71.88	1.55	41.1
2450	/	7.99	/	0.16	/	/	19.97	71.88	1.88	40.3
2600	/	7.99	/	0.16	/	/	19.97	71.88	1.88	40.3

Target Frequency (MHz)	Head	
	$\epsilon_r$	$\sigma$ (S/m)
750	41.9	0.89
835	41.5	0.90
900	41.5	0.97
1450	40.5	1.20
1640	40.2	1.31
1800	40.0	1.40
1900	40.0	1.40
2000	40.0	1.40
2450	39.2	1.80
2600	39.0	1.96
3000	38.5	2.40
5200	36.0	4.66
5800	35.3	5.27

### 3.8. Tissue equivalent liquid properties

Dielectric Performance of Head Tissue Simulating Liquid

Test Engineer: bob.yang									
Tissue Type	Measured Frequency (MHz)	Target Tissue		Measured Tissue				Liquid Temp.	Test Data
		$\sigma$	$\epsilon_r$	$\sigma$	Dev.	$\epsilon_r$	Dev.		
750H	750	0.89	41.90	0.86	-3.37%	43.23	3.17%	21.4	05/15/2023
835H	835	0.90	41.50	0.88	-2.22%	42.60	2.65%	20.7	05/17/2023
1800H	1800	1.40	40.00	1.38	-1.43%	41.43	3.58%	22.2	05/22/2023
1900H	1900	1.40	40.00	1.36	-2.86%	41.03	2.58%	21.6	05/24/2023
2450H	2450	1.80	39.20	1.77	-1.67%	40.30	2.81%	22.7	05/26/2023
2600H	2600	1.96	39.00	1.94	-1.02%	40.12	2.87%	22.2	05/31/2023
5200H	5200	4.66	36.00	4.69	0.64%	35.65	-0.97%	23.2	06/02/2023
5800H	5800	5.27	35.30	5.25	-0.38%	36.47	3.31%	22.2	06/05/2023



### 3.9. System Check

The purpose of the system check is to verify that the system operates within its specifications at the device test frequency. The system check is simple check of repeatability to make sure that the system works correctly at the time of the compliance test;

System check results have to be equal or near the values determined during dipole calibration with the relevant liquids and test system ( $\pm 10\%$ ).

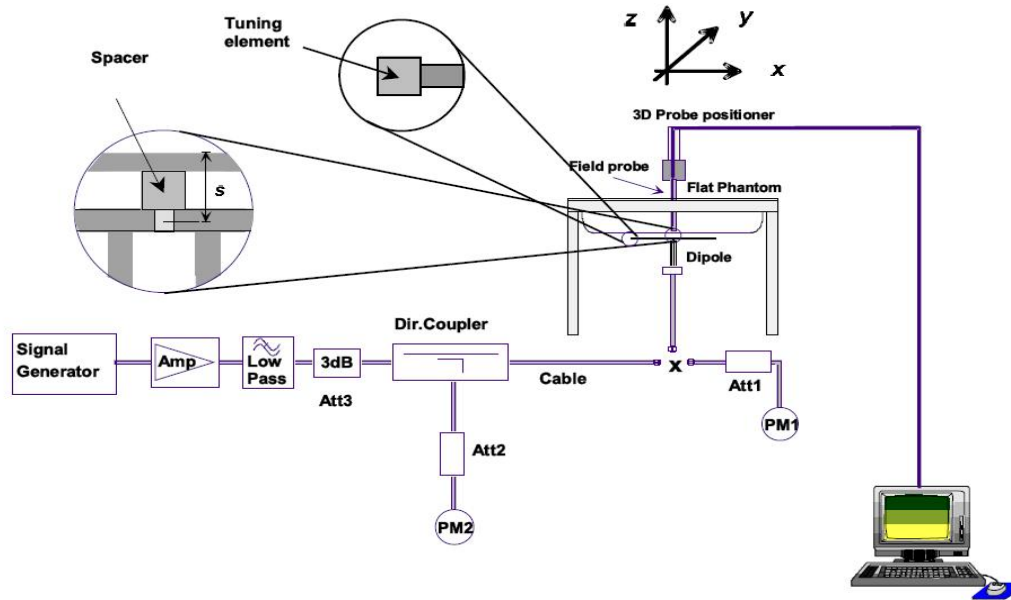

The output power on dipole port must be calibrated to 20 dBm (100mW) before dipole is connected.



Photo of Dipole Setup



**Justification for Extended SAR Dipole Calibrations**

Referring to KDB 865664D01V01r04, if dipoles are verified in return loss (<-20dB, within 20% of prior calibration), and in impedance (within 5 ohm of prior calibration), the annual calibration is not necessary and the calibration interval can be extended. While calibration intervals not exceed 3 years.

SID750 SN 07/14 DIP 0G750-302 Extend Dipole Calibrations

Date of Measurement	Return-Loss (dB)	Delta (%)	Real Impedance (ohm)	Delta (ohm)	Imaginary Impedance (ohm)	Delta (ohm)
2021-09-29	-34.80		50.7		1.6	
2022-09-29	-34.35	-1.29	51.2	0.5	1.5	-0.1

SID835 SN 07/14 DIP 0G835-303 Extend Dipole Calibrations

Date of Measurement	Return-Loss (dB)	Delta (%)	Real Impedance (ohm)	Delta (ohm)	Imaginary Impedance (ohm)	Delta (ohm)
2021-09-29	-24.49		54.9		2.8	
2022-09-29	-24.17	-1.31	54.5	-0.4	2.6	-0.2

SID1800 SN 30/14 DIP 1G800-301 Extend Dipole Calibrations

Date of Measurement	Return-Loss (dB)	Delta (%)	Real Impedance (ohm)	Delta (ohm)	Imaginary Impedance (ohm)	Delta (ohm)
2021-09-29	-20.26		43.1		6.9	
2022-09-29	-20.13	-0.64	42.9	-0.2	6.7	-0.2

SID1900 SN 38/18 DIP 1G900-466 Extend Dipole Calibrations

Date of Measurement	Return-Loss (dB)	Delta (%)	Real Impedance (ohm)	Delta (ohm)	Imaginary Impedance (ohm)	Delta (ohm)
2021-09-22	-26.43		50.5		4.7	
2022-09-22	-26.33	-0.38	50.2	-0.3	4.5	-0.2

SID2450 SN 07/14 DIP 2G450-306 Extend Dipole Calibrations

Date of Measurement	Return-Loss (dB)	Delta (%)	Real Impedance (ohm)	Delta (ohm)	Imaginary Impedance (ohm)	Delta (ohm)
2021-09-29	-25.59		44.7		-1.1	
2022-09-29	-25.68	0.35	44.8	0.1	-1.0	0.1

SID2600 SN 38/18 DIP 2G600-468 Extend Dipole Calibrations

Date of Measurement	Return-Loss (dB)	Delta (%)	Real Impedance (ohm)	Delta (ohm)	Imaginary Impedance (ohm)	Delta (ohm)
2021-09-22	-29.14		49.2		3.4	
2022-09-22	-29.12	-0.07	49.1	-0.1	3.2	-0.1

SID5200 SN 49/16 DIP WGA43 Extend Dipole Calibrations

Date of Measurement	Return-Loss (dB)	Delta (%)	Real Impedance (ohm)	Delta (ohm)	Imaginary Impedance (ohm)	Delta (ohm)
2021-09-29	-8.59		19.38		13.50	
2022-09-29	-8.62	0.35	19.25	-0.13	13.47	-0.03

SID5800 SN 49/16 DIP WGA43 Extend Dipole Calibrations

Date of Measurement	Return-Loss (dB)	Delta (%)	Real Impedance (ohm)	Delta (ohm)	Imaginary Impedance (ohm)	Delta (ohm)
2021-09-29	-11.37		54.79		25.47	
2022-09-29	-11.42	0.44	54.68	-0.11	25.26	-0.21



Shenzhen LCS Compliance Testing Laboratory Ltd.

Add: 101, 201 Bldg A &amp; 301 Bldg C, Juji Industrial Park Yabianxueziwei, Shajing Street, Baoan District, Shenzhen, 518000, China

Tel: +(86) 0755-82591330 | E-mail: webmaster@lcs-cert.com | Web: www.lcs-cert.com

Scan code to check authenticity



Mixture Type	Frequency (MHz)	Power	SAR <sub>1g</sub> (W/Kg)	SAR <sub>10g</sub> (W/Kg)	Drift (%)	1W Target		Difference percentage		Liquid Temp	Date
						SAR <sub>1g</sub> (W/Kg)	SAR <sub>10g</sub> (W/Kg)	1g	10g		
Head	750	100 mW	0.820	0.573	-0.32	8.38	5.53	-2.15%	3.62%	21.4	05/15/2023
		Normalize to 1 Watt	8.20	5.73							
Head	835	100 mW	0.981	0.643	-0.63	9.60	6.20	2.19%	3.71%	20.7	05/17/2023
		Normalize to 1 Watt	9.81	6.43							
Head	1800	100 mW	3.832	2.001	3.58	38.13	20.20	0.50%	-0.94%	22.2	05/22/2023
		Normalize to 1 Watt	38.32	20.01							
Head	1900	100 mW	3.954	2.079	-1.11	40.03	20.55	-1.22%	1.17%	21.6	05/24/2023
		Normalize to 1 Watt	39.54	20.79							
Head	2450	100 mW	5.206	2.357	0.96	53.89	24.15	-3.40%	-2.40%	22.7	05/26/2023
		Normalize to 1 Watt	52.06	23.57							
Head	2600	100 mW	5.547	2.444	-2.05	54.14	24.13	2.46%	1.28%	22.2	05/31/2023
		Normalize to 1 Watt	55.47	24.44							
Head	5200	100 mW	15.465	5.82	-0.24	159.00	56.90	-2.74%	2.28%	23.2	06/02/2023
		Normalize to 1 Watt	154.65	58.20							
Head	5800	100 mW	17.588	5.798	3.12	181.20	61.50	-2.94%	-5.72%	22.2	06/05/2023
		Normalize to 1 Watt	175.88	57.98							

### 3.10. SAR measurement procedure

The measurement procedures are as follows:

#### 3.10.1 Conducted power measurement

- For WWAN power measurement, use base station simulator connection with RF cable, at maximum power in each supported wireless interface and frequency band.
- Read the WWAN RF power level from the base station simulator.
- For WLAN/BT power measurement, use engineering software to configure EUT WLAN/BT continuously Transmission, at maximum RF power in each supported wireless interface and frequency band.
- Connect EUT RF port through RF cable to the power meter, and measure WLAN/BT output power.

#### 3.10.2 GSM Test Configuration

SAR tests for GSM 850 and GSM 1900, a communication link is set up with a System Simulator (SS) by air link. Using CMU200 the power level is set to "5" for GSM 850, set to "0" for GSM 1900. Since the GPRS class is 12 for this EUT, it has at most 4 timeslots in uplink and at most 4 timeslots in downlink, the maximum total timeslots is 5. the EGPRS class is 12 for this EUT, it has at most 4 timeslots in uplink and at most 4 timeslots in downlink, the maximum total timeslots is 5.

SAR test reduction for GPRS and EDGE modes is determined by the source-based time-averaged output power specified for production units, including tune-up tolerance. The data mode with highest specified time-averaged output power should be tested for SAR compliance in the applicable exposure conditions. For modes with the same specified maximum output power and tolerance, the higher number time-slot configuration should be tested. GSM voice and GPRS data use GMSK, which is a constant amplitude modulation with minimal peak to average power difference within the time-slot burst. For EDGE, GMSK is used for MCS 1 – MCS 4 and 8-PSK is used for MCS 5 – MCS 9; where 8-PSK has an inherently higher peak-to-average power ratio. The GMSK and 8-PSK EDGE configurations are considered separately for SAR compliance. The GMSK EDGE configurations are grouped with GPRS and considered with respect to time-averaged maximum output power to determine compliance. The 3G SAR test reduction procedure is applied to 8-PSK EDGE with GMSK GPRS/EDGE as the primary mode.

#### 3.10.3 UMTS Test Configuration

##### 3G SAR Test Reduction Procedure

In the following procedures, the mode tested for SAR is referred to as the primary mode. The equivalent modes considered for SAR test reduction are denoted as secondary modes. Both primary and secondary modes must be in the same frequency band. When the maximum output power and tune-up tolerance specified for production



Shenzhen LCS Compliance Testing Laboratory Ltd.

Add: 101, 201 Bldg A & 301 Bldg C, Juji Industrial Park Yabianxueziwei, Shajing Street, Baoan District, Shenzhen, 518000, China

Tel: +(86) 0755-82591330 | E-mail: webmaster@lcs-cert.com | Web: www.lcs-cert.com

Scan code to check authenticity



units in a secondary mode is  $\leq \frac{1}{4}$  dB higher than the primary mode or when the highest reported SAR of the primary mode is scaled by the ratio of specified maximum output power and tune-up tolerance of secondary to primary mode and the adjusted SAR is  $\leq 1.2$  W/kg, SAR measurement is not required for the secondary mode.<sup>3</sup> This is referred to as the 3G SAR test reduction procedure in the following SAR test guidance, where the primary mode is identified in the applicable wireless mode test procedures and the secondary mode is wireless mode being considered for SAR test reduction by that procedure. When the 3G SAR test reduction procedure is not satisfied, it is identified as “otherwise” in the applicable procedures; SAR measurement is required for the secondary mode.

### Output power Verification

Maximum output power is verified on the high, middle and low channels according to procedures described in section 5.2 of 3GPP TS 34.121, using the appropriate RMC or AMR with TPC (transmit power control) set to all “1’s” for WCDMA/HSDPA or by applying the required inner loop power control procedures to maintain maximum output power while HSUPA is active. Results for all applicable physical channel configurations (DPCCH, DPDCHn and spreading codes, HSDPA, HSPA) are required in the SAR report. All configurations that are not supported by the handset or cannot be measured due to technical or equipment limitations must be clearly identified.

### Head SAR

SAR for next to the ear head exposure is measured using a 12.2 kbps RMC with TPC bits configured to all “1’s”. The 3G SAR test reduction procedure is applied to AMR configurations with 12.2 kbps RMC as the primary mode. Otherwise, SAR is measured for 12.2 kbps AMR in 3.4 kbps SRB (signaling radio bearer) using the highest reported SAR configuration in 12.2 kbps RMC for head exposure.

#### 1) Body-Worn Accessory SAR

SAR for body-worn accessory configurations is measured using a 12.2 kbps RMC with TPC bits configured to all “1’s”. The 3G SAR test reduction procedure is applied to other spreading codes and multiple DPDCHn configurations supported by the handset with 12.2 kbps RMC as the primary mode. Otherwise, SAR is measured using an applicable RMC configuration with the corresponding spreading code or DPDCHn, for the highest reported body-worn accessory exposure SAR configuration in 12.2 kbps RMC. When more than 2 DPDCHn are supported by the handset, it may be necessary to configure additional DPDCHn using FTM (Factory Test Mode) or other chipset based test approaches with parameters similar to those used in 384 kbps and 768 kbps RMC.

#### 2) Handsets with Release 5 HSDPA

The 3G SAR test reduction procedure is applied to HSDPA body-worn accessory configurations with 12.2 kbps RMC as the primary mode. Otherwise, SAR is measured for HSDPA using the HSDPA body SAR procedures in the “Release 5 HSDPA Data Devices” section of this document, for the highest reported SAR body-worn accessory exposure configuration in 12.2 kbps RMC. Handsets with both HSDPA and HSUPA are tested according to Release 6 HSPA test procedures.

HSDPA should be configured according to the UE category of a test device. The number of HSDSCH/ HS-PDSCHs, HARQ processes, minimum inter-TTI interval, transport block sizes and RV coding sequence are defined by the H-set. To maintain a consistent test configuration and stable transmission conditions, QPSK is used in the H-set for SAR testing. HS-DPCCH should be configured with a CQI feedback cycle of 4 ms with a CQI repetition factor of 2 to maintain a constant rate of active CQI slots. DPCCH and DPDCH gain factors ( $\beta_c$ ,  $\beta_d$ ), and HS-DPCCH power offset parameters ( $\Delta_{ACK}$ ,  $\Delta_{NACK}$ ,  $\Delta_{CQI}$ ) should be set according to values indicated in the Table below. The CQI value is determined by the UE category, transport block size, number of HS-PDSCHs and modulation used in the H-set

**Table 2: Subtests for UMTS Release 5 HSDPA**

Sub-set	$\beta_c$	$\beta_d$	$\beta_d$ (SF)	$\beta_c/\beta_d$	$\beta_{hs}$ (note 1, note 2)	CM(dB) (note 3)	MPR(dB)
1	2/15	15/15	64	2/15	4/15	0.0	0.0
2	12/15 (note 4)	15/15 (note 4)	64	12/15 (note 4)	24/15	1.0	0.0
3	15/15	8/15	64	15/8	30/15	1.5	0.5
4	15/15	4/15	64	15/4	30/15	1.5	0.5



Shenzhen LCS Compliance Testing Laboratory Ltd.

Add: 101, 201 Bldg A & 301 Bldg C, Juji Industrial Park Yabianxueziwei, Shajing Street, Baoan District, Shenzhen, 518000, China

Tel: +(86) 0755-82591330 | E-mail: webmaster@lcs-cert.com | Web: www.lcs-cert.com

Scan code to check authenticity



Note1:  $\Delta_{ACK}$ ,  $\Delta_{NACK}$  and  $\Delta_{CQI} = 8 \Leftrightarrow A_{hs} = \beta_{hs}/\beta_c = 30/15 \Leftrightarrow \beta_{hs} = 30/15 * \beta_c$

Note2: CM=1 for  $\beta_c/\beta_d = 12/15$ ,  $\beta_{hs}/\beta_c = 24/15$ .

Note3: For subtest 2 the  $\beta_c/\beta_d$  ratio of 12/15 for the TFC during the measurement period (TF1, TF0) is achieved by setting the signaled gain factors for the reference TFC (TFC1, TF1) to  $\beta_c = 11/15$  and  $\beta_d = 15/15$ .

### HSUPA Test Configuration

The 3G SAR test reduction procedure is applied to HSPA (HSUPA/HSDPA with RMC) body-worn accessory configurations with 12.2 kbps RMC as the primary mode. Otherwise, SAR is measured for HSPA using the HSPA body SAR procedures in the "Release 6 HSPA Data Devices" section of this document, for the highest reported body-worn accessory exposure SAR configuration in 12.2 kbps RMC. When VOIP is applicable for next to the ear head exposure in HSPA, the 3G SAR test reduction procedure is applied to HSPA with 12.2 kbps RMC as the primary mode; otherwise, the same HSPA configuration used for body-worn accessory measurements is tested for next to the ear head exposure.

Due to inner loop power control requirements in HSPA, a communication test set is required for output power and SAR tests. The 12.2 kbps RMC, FRC H-set 1 and E-DCH configurations for HSPA are configured according to the  $\beta$  values indicated in Table 2 and other applicable procedures described in the 'WCDMA Handset' and 'Release 5 HSDPA Data Devices' sections of this document

**Table 3: Sub-Test 5 Setup for Release 6 HSUPA**

Sub-set	$\beta_c$	$\beta_d$	$\beta_d$ (SF)	$\beta_c/\beta_d$	$\beta_{hs}^{(1)}$	$\beta_{ec}$	$\beta_{ed}$	$\beta_{ed}$ (SF)	$\beta_{ed}$ (codes)	CM <sup>(2)</sup> (dB)	MPR (dB)	AG <sup>(4)</sup> Index	E-TFCI
1	11/15 <sup>(3)</sup>	15/15 <sup>(3)</sup>	64	11/15 <sup>(3)</sup>	22/15	209/225	1039/225	4	1	1.0	0.0	20	75
2	6/15	15/15	64	6/15	12/15	12/15	94/75	4	1	3.0	2.0	12	67
3	15/15	9/15	64	15/9	30/15	30/15	$\beta_{ed1} 47/15$ $\beta_{ed2} 47/15$	4	2	2.0	1.0	15	92
4	2/15	15/15	64	2/15	4/15	2/15	56/75	4	1	3.0	2.0	17	71
5	15/15 <sup>(4)</sup>	15/15 <sup>(4)</sup>	64	15/15 <sup>(4)</sup>	30/15	24/15	134/15	4	1	1.0	0.0	21	81

Note 1:  $\Delta_{ACK}$ ,  $\Delta_{NACK}$  and  $\Delta_{CQI} = 8 \Leftrightarrow A_{hs} = \beta_{hs}/\beta_c = 30/15 \Leftrightarrow \beta_{hs} = 30/15 * \beta_c$ .

Note 2: CM = 1 for  $\beta_c/\beta_d = 12/15$ ,  $\beta_{hs}/\beta_c = 24/15$ . For all other combinations of DPDCH, DPCCH, HS-DPCCH, E-DPDCH and E-DPCCH the MPR is based on the relative CM difference.

Note 3: For subtest 1 the  $\beta_c/\beta_d$  ratio of 11/15 for the TFC during the measurement period (TF1, TF0) is achieved by setting the signaled gain factors for the reference TFC (TF1, TF1) to  $\beta_c = 10/15$  and  $\beta_d = 15/15$ .

Note 4: For subtest 5 the  $\beta_c/\beta_d$  ratio of 15/15 for the TFC during the measurement period (TF1, TF0) is achieved by setting the signaled gain factors for the reference TFC (TF1, TF1) to  $\beta_c = 14/15$  and  $\beta_d = 15/15$ .

Note 5: Testing UE using E-DPDCH Physical Layer category 1 Sub-test 3 is not required according to TS 25.306 Figure 5.1g.

Note 6:  $\beta_{ed}$  can not be set directly; it is set by Absolute Grant Value.

### 3.10.4 WIFI Test Configuration

The SAR measurement and test reduction procedures are structured according to either the DSSS or OFDM transmission mode configurations used in each standalone frequency band and aggregated band. For devices that operate in exposure configurations that require multiple test positions, additional SAR test reduction may be applied. The maximum output power specified for production units, including tune-up tolerance, are used to determine initial SAR test requirements for the 802.11 transmission modes in a frequency band. SAR is measured using the highest measured maximum output power channel for the initial test configuration. SAR measurement and test reduction for the remaining 802.11 modes and test channels are determined according to measured or specified maximum output power and reported SAR of the initial measurements. The general test reduction and SAR measurement approaches are summarized in the following:

1. The maximum output power specified for production units are determined for all applicable 802.11 transmission modes in each standalone and aggregated frequency band. Maximum output power is measured for the highest maximum output power configuration(s) in each frequency band according to the default power measurement procedures.
2. For OFDM transmission configurations in the 2.4 GHz and 5 GHz bands, an "initial test configuration" is first determined for each standalone and aggregated frequency band according to the maximum output power and tune-up tolerance specified for production units.







- a. When the same maximum power is specified for multiple transmission modes in a frequency band, the largest channel bandwidth, lowest order modulation, lowest data rate and lowest order 802.11a/g/n/ac mode is used for SAR measurement, on the highest measured output power channel in the initial test configuration, for each frequency band.
  - b. SAR is measured for OFDM configurations using the initial test configuration procedures. Additional frequency band specific SAR test reduction may be considered for individual frequency bands
  - c. Depending on the reported SAR of the highest maximum output power channel tested in the initial test configuration, SAR test reduction may apply to subsequent highest output channels in the initial test configuration to reduce the number of SAR measurements.
3. The Initial test configuration does not apply to DSSS. The 2.4 GHz band SAR test requirements and 802.11b DSSS procedures are used to establish the transmission configurations required for SAR measurement.
4. An "initial test position" is applied to further reduce the number of SAR tests for devices operating in next to the ear, UMPC mini-tablet or hotspot mode exposure configurations that require multiple test positions .
- a. SAR is measured for 802.11b according to the 2.4 GHz DSSS procedure using the exposure condition established by the initial test position.
  - b. SAR is measured for 2.4 GHz and 5 GHz OFDM configurations using the initial test configuration. 802.11b/g/n operating modes are tested independently according to the service requirements in each frequency band. 802.11b/g/n modes are tested on the maximum average output channel.
5. The Initial test position does not apply to devices that require a fixed exposure test position. SAR is measured in a fixed exposure test position for these devices in 802.11b according to the 2.4 GHz DSSS procedure or in 2.4 GHz and 5 GHz OFDM configurations using the initial test configuration procedures .
6. The "subsequent test configuration" procedures are applied to determine if additional SAR measurements are required for the remaining OFDM transmission modes that have not been tested in the initial test configuration. SAR test exclusion is determined according to reported SAR in the initial test configuration and maximum output power specified or measured for these other OFDM configurations.

#### 2.4 GHz and 5GHz SAR Procedures

Separate SAR procedures are applied to DSSS and OFDM configurations in the 2.4 GHz band to simplify DSSS test requirements. For 802.11b DSSS SAR measurements, DSSS SAR procedure applies to fixed exposure test position and initial test position procedure applies to multiple exposure test positions. When SAR measurement is required for an OFDM configuration, the initial test configuration, subsequent test configuration and initial test position procedures are applied. The SAR test exclusion requirements for 802.11g/n OFDM configurations are described in section 5.2.2.

##### 1. 802.11b DSSS SAR Test Requirements

SAR is measured for 2.4 GHz 802.11b DSSS using either a fixed test position or, when applicable, the initial test position procedure. SAR test reduction is determined according to the following:

- a. When the reported SAR of the highest measured maximum output power channel (section 3.1) for the exposure configuration is  $\leq 0.8$  W/kg, no further SAR testing is required for 802.11b DSSS in that exposure configuration.
- b. When the reported SAR is  $> 0.8$  W/kg, SAR is required for that exposure configuration using the next highest measured output power channel. When any reported SAR is  $> 1.2$  W/kg, SAR is required for the third channel; i.e., all channels require testing.

##### 1. 2.4 GHz 802.11g/n OFDM SAR Test Exclusion Requirements

When SAR measurement is required for 2.4 GHz 802.11g/n OFDM configurations, the measurement and test reduction procedures for OFDM are applied (section 5.3). SAR is not required for the following 2.4 GHz OFDM conditions.

- a. When KDB Publication 447498 SAR test exclusion applies to the OFDM configuration
- b. When the highest reported SAR for DSSS is adjusted by the ratio of OFDM to DSSS specified maximum output power and the adjusted SAR is  $\leq 1.2$  W/kg.

##### 2. SAR Test Requirements for OFDM Configurations

When SAR measurement is required for 802.11 a/g/n/ac OFDM configurations, each standalone and frequency aggregated band is considered separately for SAR test reduction. When the same transmitter and antenna(s) are used for U-NII-1 and U-NII-2A bands, additional SAR test reduction applies. When band gap channels between U-NII-2C band and 5.8 GHz U-NII-3 or §15.247 band are supported, the highest maximum output power transmission mode configuration and maximum output power channel across the bands must be used to determine SAR test reduction, according to the initial test configuration and subsequent test configuration requirements.20 In applying the initial test configuration and subsequent test





configuration procedures, the 802.11 transmission configuration with the highest specified maximum output power and the channel within a test configuration with the highest measured maximum output power should be clearly distinguished to apply the procedures.

### 3. OFDM Transmission Mode SAR Test Configuration and Channel Selection Requirements

The initial test configuration for 2.4 GHz and 5 GHz OFDM transmission modes is determined by the 802.11 configuration with the highest maximum output power specified for production units, including tune-up tolerance, in each standalone and aggregated frequency band. SAR for the initial test configuration is measured using the highest maximum output power channel determined by the default power measurement procedures (section 4). When multiple configurations in a frequency band have the same specified maximum output power, the initial test configuration is determined according to the following steps applied sequentially.

- a. The largest channel bandwidth configuration is selected among the multiple configurations with the same specified maximum output power.
- b. If multiple configurations have the same specified maximum output power and largest channel bandwidth, the lowest order modulation among the largest channel bandwidth configurations is selected.
- c. If multiple configurations have the same specified maximum output power, largest channel bandwidth and lowest order modulation, the lowest data rate configuration among these configurations is selected.
- d. When multiple transmission modes (802.11a/g/n/ac) have the same specified maximum output power, largest channel bandwidth, lowest order modulation and lowest data rate, the lowest order 802.11 mode is selected; i.e., 802.11a is chosen over 802.11n then 802.11ac or 802.11g is chosen over 802.11n.

After an initial test configuration is determined, if multiple test channels have the same measured maximum output power, the channel chosen for SAR measurement is determined according to the following. These channel selection procedures apply to both the initial test configuration and subsequent test configuration(s), with respect to the default power measurement procedures or additional power measurements required for further SAR test reduction. The same procedures also apply to subsequent highest output power channel(s) selection.

- a. Channels with measured maximum output power within  $\frac{1}{4}$  dB of each other are considered to have the same maximum output.
- b. When there are multiple test channels with the same measured maximum output power, the channel closest to mid-band frequency is selected for SAR measurement.
- c. When there are multiple test channels with the same measured maximum output power and equal separation from mid-band frequency; for example, high and low channels or two mid-band channels, the higher frequency (number) channel is selected for SAR measurement.

#### Initial Test Configuration Procedures

An initial test configuration is determined for OFDM transmission modes according to the channel bandwidth, modulation and data rate combination(s) with the highest maximum output power specified for production units in each standalone and aggregated frequency band. SAR is measured using the highest measured maximum output power channel. For configurations with the same specified or measured maximum output power, additional transmission mode and test channel selection procedures are required (see section 5.3.2). SAR test reduction of subsequent highest output test channels is based on the reported SAR of the initial test configuration.

For next to the ear, hotspot mode and UMC mini-tablet exposure configurations where multiple test positions are required, the initial test position procedure is applied to minimize the number of test positions required for SAR measurement using the initial test configuration transmission mode.<sup>23</sup> For fixed exposure conditions that do not have multiple SAR test positions, SAR is measured in the transmission mode determined by the initial test configuration. When the reported SAR of the initial test configuration is  $> 0.8$  W/kg, SAR measurement is required for the subsequent next highest measured output power channel(s) in the initial test configuration until the reported SAR is  $\leq 1.2$  W/kg or all required channels are tested.

#### 4. Subsequent Test Configuration Procedures

SAR measurement requirements for the remaining 802.11 transmission mode configurations that have not been tested in the initial test configuration are determined separately for each standalone and aggregated frequency band, in each exposure condition, according to the maximum output power specified for production units. The initial test position procedure is applied to next to the ear, UMPC mini-tablet and hotspot mode configurations. When the same maximum output power is specified for multiple transmission modes, the procedures in section 5.3.2 are applied to determine the test configuration. Additional power measurements may be required to determine if SAR measurements are required for subsequent highest output power channels in a subsequent test configuration. The subsequent test configuration and SAR measurement procedures are described in the following.





- a. When SAR test exclusion provisions of KDB Publication 447498 are applicable and SAR measurement is not required for the initial test configuration, SAR is also not required for the next highest maximum output power transmission mode subsequent test configuration(s) in that frequency band or aggregated band and exposure configuration.
- b. When the highest reported SAR for the initial test configuration (when applicable, include subsequent highest output channels), according to the initial test position or fixed exposure position requirements, is adjusted by the ratio of the subsequent test configuration to initial test configuration specified maximum output power and the adjusted SAR is  $\leq 1.2$  W/kg, SAR is not required for that subsequent test configuration.
- c. The number of channels in the initial test configuration and subsequent test configuration can be different due to differences in channel bandwidth. When SAR measurement is required for a subsequent test configuration and the channel bandwidth is smaller than that in the initial test configuration, all channels in the subsequent test configuration that overlap with the larger bandwidth channel tested in the initial test configuration should be used to determine the highest maximum output power channel. This step requires additional power measurement to identify the highest maximum output power channel in the subsequent test configuration to determine SAR test reduction.
  - 1). SAR should first be measured for the channel with highest measured output power in the subsequent test configuration.
  - 2). SAR for subsequent highest measured maximum output power channels in the subsequent test configuration is required only when the reported SAR of the preceding higher maximum output power channel(s) in the subsequent test configuration is  $> 1.2$  W/kg or until all required channels are tested.
    - a) For channels with the same measured maximum output power, SAR should be measured using the channel closest to the center frequency of the larger channel bandwidth channel in the initial test configuration.
- d. SAR measurements for the remaining highest specified maximum output power OFDM transmission mode configurations that have not been tested in the initial test configuration (highest maximum output) or subsequent test configuration(s) (subsequent next highest maximum output power) is determined by applying the subsequent test configuration procedures in this section to the remaining configurations according to the following:
  - 1) replace "subsequent test configuration" with "next subsequent test configuration" (i.e., subsequent next highest specified maximum output power configuration)
  - 2) replace "initial test configuration" with "all tested higher output power configurations."

### 3.11. Power Reduction

The product without any power reduction.

### 3.12. Power Drift

To control the output power stability during the SAR test, SAR system calculates the power drift by measuring the E-field at the same location at the beginning and at the end of the measurement for each test position. This ensures that the power drift during one measurement is within 5%.





## 4. TEST CONDITIONS AND RESULTS

### 4.1. Conducted Power Results

According KDB 447498D01 General RF Exposure Guidance v06 Section 4.1 2) states that “Unless it is specified differently in the published RF exposure KDB procedures, these requirements also apply to test reduction and test exclusion considerations. Time-averaged maximum conducted output power applies to SAR and, as required by § 2.1091(c), time-averaged ERP applies to MPE. When an antenna port is not available on the device to support conducted power measurement, such as FRS and certain Part 15 transmitters with built-in integral antennas, the maximum output power allowed for production units should be used to determine RF exposure test exclusion and compliance.”

#### <GSM Conducted Power>

General Note:

1. Per KDB 447498 D01v06, the maximum output power channel is used for SAR testing and for further SAR test reduction.
2. According to October 2013TCB Workshop, for GSM / GPRS / EGPRS, the number of time slots to test for SAR should correspond to the highest frame-average maximum output power configuration, considering the possibility of e.g. 3rd party VoIP operation for head and body-worn SAR testing, the EUT was set in GPRS (4Tx slot) for GSM850/GSM1900 band due to their highest frame-average power.
3. For hotspot mode SAR testing, GPRS should be evaluated, therefore the EUT was set in GPRS (4 Tx slots) for GSM850/GSM1900 band due to its highest frame-average power.

**Conducted power measurement results for GSM850/PCS1900**

GSM 850		Tune-up	Burst Conducted power (dBm)			Division Factors	Tune-up	Average power (dBm)		
			Channel/Frequency(MHz)					Channel/Frequency(MHz)		
		Max	128/824.2	190/836.6	251/848.8		Max	128/824.2	190/836.6	251/848.8
GSM		33.00	32.70	32.72	32.69	-9.03dB	23.97	23.67	23.69	23.66
GPRS (GMSK)	1TX slot	33.00	32.53	32.53	32.49	-9.03dB	23.97	23.50	23.50	23.46
	<b>2TX slot</b>	<b>31.50</b>	<b>30.96</b>	<b>31.01</b>	<b>30.94</b>	<b>-6.02dB</b>	<b>25.48</b>	<b>24.94</b>	<b>24.99</b>	<b>24.92</b>
	3TX slot	29.50	29.48	29.50	29.49	-4.26dB	25.24	25.22	25.24	25.23
	4TX slot	28.00	27.99	28.00	27.98	-3.01dB	24.99	24.98	24.99	24.97
EGPRS (8PSK)	1TX slot	26.50	25.96	26.02	25.96	-9.03dB	17.47	16.93	16.99	16.93
	2TX slot	25.00	24.48	24.52	24.45	-6.02dB	18.98	18.46	18.50	18.43
	3TX slot	23.00	22.95	22.98	22.98	-4.26dB	18.74	18.69	18.72	18.72
	4TX slot	21.50	21.46	21.47	21.48	-3.01dB	18.49	18.45	18.46	18.47
GSM 1900		Tune-up	Burst Conducted power (dBm)			Division Factors	Tune-up	Average power (dBm)		
			Channel/Frequency(MHz)					Channel/Frequency(MHz)		
		Max	512/1850.2	661/1880	810/1909.8		Max.	512/1850.2	661/1880	810/1909.8
GSM		30.00	29.65	29.68	29.67	-9.03dB	20.97	20.62	20.65	20.64
GPRS (GMSK)	1TX slot	30.00	29.49	29.56	29.49	-9.03dB	20.97	20.46	20.53	20.46
	2TX slot	28.00	28.00	27.99	27.98	-6.02dB	21.98	21.98	21.97	21.96
	<b>3TX slot</b>	<b>27.00</b>	<b>26.46</b>	<b>26.53</b>	<b>26.45</b>	<b>-4.26dB</b>	<b>22.74</b>	<b>22.20</b>	<b>22.27</b>	<b>22.19</b>
	4TX slot	25.50	24.99	25.00	24.94	-3.01dB	22.49	21.98	21.99	21.93
EGPRS (8PSK)	1TX slot	26.00	25.48	25.51	25.46	-9.03dB	16.97	16.45	16.48	16.43
	2TX slot	24.50	23.98	24.03	23.97	-6.02dB	18.48	17.96	18.01	17.95
	3TX slot	23.00	22.50	22.52	22.44	-4.26dB	18.74	18.24	18.26	18.18
	4TX slot	21.00	20.94	20.97	20.96	-3.01dB	17.99	17.93	17.96	17.95

#### Notes:

##### 1. Division Factors

To average the power, the division factor is as follows:

1TX-slot = 1 transmit time slot out of 8 time slots=> conducted power divided by (8/1) => -9.00dB

2TX-slots = 2 transmit time slots out of 8 time slots=> conducted power divided by (8/2) => -6.00dB

3TX-slots = 3 transmit time slots out of 8 time slots=> conducted power divided by (8/3) => -4.26dB

4TX-slots = 4 transmit time slots out of 8 time slots=> conducted power divided by (8/4) => -3.00dB



Shenzhen LCS Compliance Testing Laboratory Ltd.

Add: 101, 201 Bldg A & 301 Bldg C, Juji Industrial Park Yabianxueziwei, Shajing Street, Baoan District, Shenzhen, 518000, China

Tel: +(86) 0755-82591330 | E-mail: webmaster@lcs-cert.com | Web: www.lcs-cert.com

Scan code to check authenticity



2. According to the conducted power as above, the GPRS measurements are performed with 2Txslot for GPRS850 and 3Txslot GPRS1900.

#### <UMTS Conducted Power>

The following tests were conducted according to the test requirements outlines in 3GPP TS 34.121 specification. A summary of these settings are illustrated below:

#### HSDPA Setup Configuration:

- a. The EUT was connected to Base Station E5515C referred to the Setup Configuration.
- b. The RF path losses were compensated into the measurements.
- c. A call was established between EUT and Base Station with following setting:
  - i. Set Gain Factors ( $\beta_c$  and  $\beta_d$ ) and parameters were set according to each
  - ii. Specific sub-test in the following table, C10.1.4, quoted from the TS 34.121
  - iii. Set RMC 12.2Kbps + HSDPA mode.
  - iv. Set Cell Power = -86 dBm
  - v. Set HS-DSCH Configuration Type to FRC (H-set 1, QPSK)
  - vi. Select HSDPA Uplink Parameters
  - vii. Set Delta ACK, Delta NACK and Delta CQI = 8
  - viii. Set Ack-Nack Repetition Factor to 3
  - ix. Set CQI Feedback Cycle (k) to 4 ms
  - x. Set CQI Repetition Factor to 2
  - xi. Power Ctrl Mode = All Up bits
- d. The transmitted maximum output power was recorded.

**Table C.10.1.4:  $\beta$  values for transmitter characteristics tests with HS-DPCCH**

Sub-test	$\beta_c$	$\beta_d$	$\beta_d$ (SF)	$\beta_c/\beta_d$	$\beta_{HS}$ (Note 1, Note 2)	CM (dB) (Note 3)	MPR (dB) (Note 3)
1	2/15	15/15	64	2/15	4/15	0.0	0.0
2	12/15 (Note 4)	15/15 (Note 4)	64	12/15 (Note 4)	24/15	1.0	0.0
3	15/15	8/15	64	15/8	30/15	1.5	0.5
4	15/15	4/15	64	15/4	30/15	1.5	0.5

Note 1:  $\Delta_{ACK}$ ,  $\Delta_{NACK}$  and  $\Delta_{CQI} = 30/15$  with  $\beta_{HS} = 30/15 * \beta_c$ .

Note 2: For the HS-DPCCH power mask requirement test in clause 5.2C, 5.7A, and the Error Vector Magnitude (EVM) with HS-DPCCH test in clause 5.13.1A, and HSDPA EVM with phase discontinuity in clause 5.13.1AA,  $\Delta_{ACK}$  and  $\Delta_{NACK} = 30/15$  with  $\beta_{HS} = 30/15 * \beta_c$ , and  $\Delta_{CQI} = 24/15$  with  $\beta_{HS} = 24/15 * \beta_c$ .

Note 3: CM = 1 for  $\beta_c/\beta_d = 12/15$ ,  $\beta_{HS}/\beta_c = 24/15$ . For all other combinations of DPDCH, DPCCH and HS-DPCCH the MPR is based on the relative CM difference. This is applicable for only UEs that support HSDPA in release 6 and later releases.

Note 4: For subtest 2 the  $\beta_c/\beta_d$  ratio of 12/15 for the TFC during the measurement period (TF1, TF0) is achieved by setting the signalled gain factors for the reference TFC (TF1, TF1) to  $\beta_c = 11/15$  and  $\beta_d = 15/15$ .

#### Setup Configuration

#### HSUPA Setup Configuration:

- a. The EUT was connected to Base Station R&S CMU200 referred to the Setup Configuration.
- b. The RF path losses were compensated into the measurements.
- c. A call was established between EUT and Base Station with following setting \* :
  - i. Call Configs = 5.2B, 5.9B, 5.10B, and 5.13.2B with QPSK
  - ii. Set the Gain Factors ( $\beta_c$  and  $\beta_d$ ) and parameters (AG Index) were set according to each specific sub-test in the following table, C11.1.3, quoted from the TS 34.121
  - iii. Set Cell Power = -86 dBm
  - iv. Set Channel Type = 12.2k + HSPA
  - v. Set UE Target Power
  - vi. Power Ctrl Mode= Alternating bits
  - vii. Set and observe the E-TFCI
  - viii. Confirm that E-TFCI is equal to the target E-TFCI of 75 for sub-test 1, and other subtest's E-TFCI
- d. The transmitted maximum output power was recorded.



Shenzhen LCS Compliance Testing Laboratory Ltd.

Add: 101, 201 Bldg A & 301 Bldg C, Juji Industrial Park Yabianxueziwei, Shajing Street, Baoan District, Shenzhen, 518000, China

Tel: +(86) 0755-82591330 | E-mail: webmaster@lcs-cert.com | Web: www.lcs-cert.com

Scan code to check authenticity

Table C.11.1.3:  $\beta$  values for transmitter characteristics tests with HS-DPCCH and E-DCH

Sub-test	$\beta_c$	$\beta_d$	$\beta_d$ (SF)	$\beta_c/\beta_d$	$\beta_{HS}$ (Note 1)	$\beta_{ec}$	$\beta_{ed}$ (Note 5) (Note 6)	$\beta_{ed}$ (SF)	$\beta_{ed}$ (Codes)	CM (dB) (Note 2)	MPR (dB) (Note 2)	AG Index (Note 6)	E-TFCI
1	11/15 (Note 3)	15/15 (Note 3)	64	11/15 (Note 3)	22/15	209/25	1309/225	4	1	1.0	0.0	20	75
2	6/15	15/15	64	6/15	12/15	12/15	94/75	4	1	3.0	2.0	12	67
3	15/15	9/15	64	15/9	30/15	30/15	$\beta_{ed1}: 47/15$ $\beta_{ed2}: 47/15$	4 4	2	2.0	1.0	15	92
4	2/15	15/15	64	2/15	4/15	2/15	56/75	4	1	3.0	2.0	17	71
5	15/15 (Note 4)	15/15 (Note 4)	64	15/15 (Note 4)	30/15	24/15	134/15	4	1	1.0	0.0	21	81

Note 1:  $\Delta_{ACK}, \Delta_{NACK}$  and  $\Delta_{CQI} = 30/15$  with  $\beta_{hs} = 30/15 * \beta_c$ .

Note 2: CM = 1 for  $\beta_c/\beta_d=12/15, \beta_{hs}/\beta_c=24/15$ . For all other combinations of DPDCH, DPCCH, HS-DPCCH, E-DPDCH and E-DPCCH the MPR is based on the relative CM difference.

Note 3: For subtest 1 the  $\beta_c/\beta_d$  ratio of 11/15 for the TFC during the measurement period (TF1, TF0) is achieved by setting the signalled gain factors for the reference TFC (TF1, TF1) to  $\beta_c = 10/15$  and  $\beta_d = 15/15$ .

Note 4: For subtest 5 the  $\beta_c/\beta_d$  ratio of 15/15 for the TFC during the measurement period (TF1, TF0) is achieved by setting the signalled gain factors for the reference TFC (TF1, TF1) to  $\beta_c = 14/15$  and  $\beta_d = 15/15$ .

Note 5: In case of testing by UE using E-DPDCH Physical Layer category 1, Sub-test 3 is omitted according to TS25.306 Table 5.1g.

Note 6:  $\beta_{ed}$  can not be set directly, it is set by Absolute Grant Value.

**General Note**

1. Per KDB 941225 D01, RMC 12.2kbps setting is used to evaluate SAR. If AMR 12.2kbps power is < 0.25dB higher than RMC 12.2kbps, SAR tests with AMR 12.2kbps can be excluded.
2. By design, AMR and HSDPA/HSUPA RF power will not be larger than RMC 12.2kbps, detailed information is included in Tune-up Procure exhibit.
3. It is expected by the manufacturer that MPR for some HSDPA/HSUPA subtests may differ from the specification of 3GPP, according to the chipset implementation in this model. The implementation and expected deviation are detailed in tune-up procedure exhibit.

**Conducted Power Measurement Results(WCDMA Band II/ IV /V)**

Item	Band	FDD Band V result (dBm)			FDD Band IV result (dBm)			FDD Band II result (dBm)		
		Test Channel			Test Channel			Test Channel		
		4132/ 826.4	4183/ 836.6	4233/ 846.6	1312/ 1712.4	1413/ 1732.6	1513/ 1752.6	9262/ 1852.4	9400/ 1880	9538/ 1907.6
RMC	12.2kbps	22.83	22.98	22.61	23.04	23.34	23.16	23.43	23.44	23.09
HSDPA	Subtest 1	22.44	22.73	22.64	22.41	22.74	22.41	22.76	22.84	22.73
	Subtest 2	22.61	22.77	22.70	22.54	22.46	22.53	22.60	22.65	22.62
	Subtest 3	22.49	22.63	22.56	22.53	22.70	22.54	22.53	22.48	22.64
	Subtest 4	22.54	22.68	22.68	22.48	22.45	22.66	22.39	22.67	22.44
HSUPA	Subtest 1	22.58	22.61	22.46	22.62	22.55	22.59	22.48	22.55	22.57
	Subtest 2	22.54	22.70	22.45	22.43	22.70	22.44	22.49	22.53	22.43
	Subtest 3	22.38	22.70	22.56	22.55	22.53	22.47	22.39	22.66	22.46
	Subtest 4	21.59	21.71	21.49	22.52	22.68	22.47	22.47	22.36	22.45
	Subtest 5	21.76	21.07	21.74	21.18	21.38	21.27	21.51	21.79	21.58

**Note:**1. When the maximum output power and tune-up tolerance specified for production units in a secondary mode is  $\leq 1/2$ dB higher than the primary mode (RMC12.2kbps) or when the highest reported SAR of the primary mode is scaled by the ratio of specified maximum output power and tune-up tolerance of secondary to primary mode and the adjusted SAR is  $\leq 1.2$  W/kg, SAR measurement is not required for the secondary mode.





LTE Band2

BW (MHz)	Frequency (MHz)	RB Configuration		Average Power [dBm]	
		Size	Offset	QPSK	16QAM
1.4	1850.7	1	0	23.05	22.37
		1	2	23.05	22.33
		1	5	23.06	22.36
		3	0	23.05	21.71
		3	1	23.11	21.71
		3	3	23.10	21.70
		6	0	22.04	21.09
	1880.0	1	0	23.38	22.72
		1	2	23.35	22.64
		1	5	23.36	22.52
		3	0	23.27	21.96
		3	1	23.26	21.96
		3	3	23.28	21.97
		6	0	22.14	21.46
	1909.3	1	0	23.40	22.64
		1	2	23.27	22.63
		1	5	23.36	22.60
		3	0	23.57	22.47
		3	1	23.53	22.45
		3	3	23.49	22.46
		6	0	22.49	21.63
3	1851.5	1	0	22.92	22.13
		1	8	22.97	22.03
		1	14	22.96	22.07
		8	0	22.06	21.18
		8	4	22.08	21.19
		8	7	22.06	21.21
		15	0	21.96	21.12
	1880.0	1	0	23.05	22.05
		1	8	23.07	22.04
		1	14	23.12	22.05
		8	0	22.19	21.37
		8	4	22.21	21.42
		8	7	22.24	21.39
		15	0	22.29	21.30
	1908.5	1	0	23.39	22.40
		1	8	23.37	22.38
		1	14	23.30	22.37
		8	0	22.39	21.66
		8	4	22.38	21.68
		8	7	22.47	21.62
		15	0	22.47	21.45
5	1852.5	1	0	23.01	21.44
		1	12	23.03	21.41
		1	24	23.08	21.48
		12	0	22.03	21.06
		12	6	22.06	21.05
		12	13	22.12	21.07
		25	0	22.08	21.14
	1880.0	1	0	23.19	21.54
		1	12	23.17	21.67
		1	24	23.19	21.63
		12	0	22.23	21.22
		12	6	22.14	21.23
		12	13	22.19	21.20
		25	0	22.07	21.36





	1907.5	1	0	23.46	22.42
		1	12	23.46	22.46
		1	24	23.52	22.43
		12	0	22.46	21.44
		12	6	22.56	21.47
		12	13	22.44	21.45
		25	0	22.46	21.41
10	1855.0	1	0	22.93	21.93
		1	24	23.05	21.95
		1	49	23.09	21.98
		25	0	21.91	20.99
		25	12	22.08	21.01
		25	25	22.08	21.20
		50	0	22.13	21.15
	1880.0	1	0	23.09	22.01
		1	24	23.01	22.10
		1	49	23.14	22.10
		25	0	22.10	21.19
		25	12	22.01	21.13
		25	25	22.27	21.22
		50	0	22.20	21.26
1905.0	1	0	23.38	22.00	
	1	24	23.42	22.06	
	1	49	23.45	22.11	
	25	0	22.48	21.56	
	25	12	22.32	21.51	
	25	25	22.50	21.67	
	50	0	22.50	21.58	
15	1857.5	1	0	22.96	21.97
		1	38	23.04	21.95
		1	74	23.14	22.01
		37	0	22.20	22.20
		37	18	22.20	22.20
		37	37	22.19	22.19
	1880.0	75	0	22.19	21.19
		1	0	23.06	21.93
		1	38	23.10	22.01
		1	74	23.17	22.05
		37	0	22.08	22.10
		37	18	22.11	22.11
	1902.5	37	37	22.12	22.12
		75	0	22.12	21.29
1		0	23.18	22.44	
1		38	23.32	22.65	
1		74	23.33	22.67	
37		0	22.36	22.39	
20	1860.0	37	18	22.39	22.39
		37	37	22.40	22.40
		75	0	22.40	21.56
		1	0	23.25	21.87
		1	49	23.27	22.00
		1	99	23.36	22.01
	1880.0	50	0	22.08	21.25
		50	25	22.18	21.27
		50	50	22.23	21.37
		100	0	22.25	21.25
		1	0	23.25	21.94
		1	49	23.33	22.01
		1	99	23.55	22.12







		50	0	22.11	21.32
		50	25	22.29	21.35
		50	50	22.32	21.49
		100	0	22.15	21.37
	1900.0	1	0	23.48	22.71
		1	49	23.51	22.76
		1	99	23.63	22.90
		50	0	22.33	21.41
		50	25	22.32	21.40
		50	50	22.40	21.55
		100	0	22.30	21.45





LTE Band4

BW (MHz)	Frequency (MHz)	RB Configuration		Average Power [dBm]	
		Size	Offset	QPSK	16QAM
1.4	1710.7	1	0	23.22	22.98
		1	2	23.19	22.94
		1	5	23.15	22.97
		3	0	23.20	21.98
		3	1	23.36	21.92
		3	3	23.30	21.89
		6	0	22.23	21.54
	1732.5	1	0	23.16	23.05
		1	2	23.07	22.94
		1	5	23.03	23.03
		3	0	23.29	21.79
		3	1	23.29	21.84
		3	3	23.23	21.87
		6	0	22.11	21.47
	1754.3	1	0	23.00	22.27
		1	2	23.05	22.24
		1	5	23.06	22.41
		3	0	22.93	21.73
		3	1	22.95	21.75
		3	3	23.02	21.78
		6	0	21.89	21.12
3	1711.5	1	0	23.17	22.32
		1	8	23.20	22.33
		1	14	23.11	22.26
		8	0	22.16	21.43
		8	4	22.29	21.41
		8	7	22.17	21.39
		15	0	22.13	21.30
	1732.5	1	0	23.16	22.28
		1	8	23.11	22.22
		1	14	23.06	22.20
		8	0	22.19	21.47
		8	4	22.21	21.53
		8	7	22.12	21.32
		15	0	22.06	21.24
	1753.5	1	0	22.97	21.77
		1	8	23.01	21.69
		1	14	22.96	21.76
		8	0	21.93	21.11
		8	4	21.86	21.14
		8	7	21.80	21.21
		15	0	21.85	20.81
5	1712.0	1	0	23.30	21.59
		1	12	23.17	21.59
		1	24	23.19	21.50
		12	0	22.17	21.33
		12	6	22.17	21.32
		12	13	22.22	21.26
		25	0	22.15	21.34
	1732.5	1	0	23.27	21.63
		1	12	23.17	21.51
		1	24	22.83	21.57
		12	0	22.30	21.35
		12	6	22.31	21.34
		12	13	22.13	21.16





	1752.5	25	0	22.22	21.27	
		1	0	22.97	21.78	
		1	12	22.93	21.81	
		1	24	22.90	21.82	
		12	0	21.96	20.93	
		12	6	21.98	20.94	
		12	13	21.96	20.83	
		25	0	21.98	20.74	
10	1715.0	1	0	23.07	22.05	
		1	24	23.05	22.03	
		1	49	23.16	22.08	
		25	0	22.11	21.15	
		25	12	22.12	21.14	
		25	25	22.10	21.26	
		50	0	22.22	21.27	
	1732.5	1	0	23.21	22.09	
		1	24	23.03	22.03	
		1	49	23.00	21.91	
		25	0	22.20	21.27	
		25	12	22.24	21.28	
		25	25	22.15	21.06	
		50	0	22.17	21.22	
	1750.0	1	0	22.98	21.60	
		1	24	22.92	21.53	
		1	49	22.93	21.59	
		25	0	21.97	21.04	
		25	12	21.95	20.98	
		25	25	21.82	20.95	
		50	0	21.91	20.93	
	15	1717.5	1	0	23.15	22.11
			1	38	23.06	22.03
			1	74	23.07	22.03
37			0	22.24	22.10	
37			18	22.10	22.15	
37			37	22.19	22.21	
75			0	22.21	21.23	
1732.5		1	0	23.13	22.05	
		1	38	23.07	21.95	
		1	74	22.83	21.91	
		37	0	22.21	22.20	
		37	18	22.19	22.19	
		37	37	22.18	22.18	
		75	0	22.18	21.22	
1747.5		1	0	23.04	22.25	
		1	38	22.95	22.19	
		1	74	22.95	22.15	
		37	0	21.94	21.92	
		37	18	21.91	21.91	
		37	37	21.91	21.91	
		75	0	21.91	20.98	
20	1720.0	1	0	23.33	22.25	
		1	49	23.29	22.21	
		1	99	23.31	22.14	
		50	0	22.25	21.32	
		50	25	22.08	21.26	
		50	50	22.09	21.26	
		100	0	22.17	21.24	
	1732.5	1	0	23.49	22.10	
		1	49	23.33	22.01	





		1	99	23.21	21.83
		50	0	22.14	21.38
		50	25	22.31	21.39
		50	50	22.06	21.21
		100	0	22.18	21.26
	1745.0	1	0	23.33	22.38
		1	49	23.09	22.18
		1	99	23.07	22.12
		50	0	21.91	21.01
		50	25	22.09	21.08
		50	50	21.94	21.02
		100	0	22.02	21.04





LTE Band5

BW (MHz)	Frequency (MHz)	RB Configuration		Average Power [dBm]		
		Size	Offset	QPSK	16QAM	
1.4	824.7	1	0	24.40	24.03	
		1	2	24.33	23.95	
		1	5	24.31	23.92	
		3	0	24.44	23.22	
		3	1	24.46	23.23	
		3	3	24.47	23.27	
	836.5	1	0	24.55	23.63	
		1	2	24.47	23.64	
		1	5	24.44	23.57	
		3	0	24.71	23.62	
		3	1	24.71	23.59	
		3	3	24.69	23.57	
	848.3	6	0	23.39	22.53	
		1	0	24.24	24.10	
		1	2	24.26	24.05	
		1	5	24.20	24.00	
		3	0	24.44	23.07	
		3	1	24.41	23.16	
	3	825.5	3	3	24.44	23.10
			6	0	23.40	22.36
			1	0	24.29	23.44
1			8	24.21	23.41	
1			14	24.22	23.46	
8			0	23.41	22.52	
836.5		8	4	23.44	22.53	
		8	7	23.51	22.58	
		15	0	23.37	22.46	
		1	0	24.50	23.60	
		1	8	24.52	23.53	
		1	14	24.52	23.54	
847.5		8	0	23.48	22.74	
		8	4	23.50	22.75	
		8	7	23.65	22.72	
		15	0	23.58	22.58	
		1	0	24.24	23.88	
		1	8	24.27	23.87	
5		826.5	1	14	24.19	23.77
			8	0	23.42	22.60
			8	4	23.32	22.60
	8		7	23.28	22.54	
	15		0	23.25	22.51	
	1		0	24.37	22.86	
	836.5	1	12	24.30	22.86	
		1	24	24.38	23.02	
		12	0	23.43	22.47	
		12	6	23.46	22.49	
		12	13	23.43	22.44	
		25	0	23.31	22.56	
		1	0	24.55	23.52	
		1	12	24.56	23.53	
		1	24	24.58	23.47	
826.5	12	0	23.61	22.56		
	12	6	23.62	22.57		
	12	13	23.60	22.63		





	846.5	25	0	23.53	22.57
		1	0	24.56	23.51
		1	12	24.50	23.39
		1	24	24.47	23.32
		12	0	23.53	22.48
		12	6	23.48	22.53
		12	13	23.35	22.47
		25	0	23.40	22.50
10	829.0	1	0	24.19	23.32
		1	24	24.26	23.50
		1	49	24.38	23.59
		25	0	23.39	22.32
		25	12	23.31	22.34
		25	25	23.59	22.55
		50	0	23.41	22.51
	836.5	1	0	24.50	23.29
		1	24	24.55	23.29
		1	49	24.51	23.11
		25	0	23.60	22.68
		25	12	23.62	22.69
		25	25	23.61	22.72
		50	0	23.53	22.60
	844.0	1	0	24.48	23.49
		1	24	24.32	23.46
		1	49	24.25	23.37
		25	0	23.47	22.64
25		12	23.57	22.61	
25		25	23.45	22.57	
50		0	23.36	22.56	





LTE Band 7

BW (MHz)	Frequency (MHz)	RB Configuration		Average Power [dBm]	
		Size	Offset	QPSK	16QAM
5	2502.5	1	0	20.76	19.81
		1	12	20.99	20.00
		1	24	20.88	19.90
		12	0	19.90	18.91
		12	6	19.89	18.90
		12	13	19.99	18.97
		25	0	19.94	18.94
	2535.0	1	0	21.11	20.13
		1	12	21.19	20.20
		1	24	20.96	19.92
		12	0	20.10	19.16
		12	6	20.09	19.07
		12	13	20.13	19.15
		25	0	20.13	19.14
	2567.5	1	0	21.15	20.35
		1	12	21.28	20.47
		1	24	21.12	20.29
		12	0	20.20	19.24
		12	6	20.22	19.24
		12	13	20.25	19.25
		25	0	20.23	19.22
10	2505.0	1	0	20.83	20.07
		1	24	21.11	20.30
		1	49	21.13	20.27
		25	0	20.06	19.07
		25	12	20.03	19.03
		25	25	20.03	19.09
		50	0	20.05	19.02
	2535.0	1	0	21.21	20.37
		1	24	21.19	20.36
		1	49	20.89	20.04
		25	0	20.14	19.16
		25	12	20.15	19.15
		25	25	20.20	19.21
		50	0	20.19	19.13
	2565.0	1	0	21.18	20.32
		1	24	21.18	20.42
		1	49	21.11	20.22
		25	0	20.26	19.27
		25	12	20.23	19.30
		25	25	20.33	19.41
		50	0	20.21	19.32
15	2507.5	1	0	20.81	20.01
		1	38	21.10	20.28
		1	74	21.20	20.40
		37	0	20.22	20.18
		37	18	20.19	20.19
		37	37	20.19	20.20
		75	0	20.20	19.15
	2535.0	1	0	21.27	20.47
		1	38	21.09	20.20
		1	74	20.80	19.97
		37	0	20.20	20.22
		37	18	20.20	20.22
		37	37	20.21	20.17





	2562.5	75	0	20.15	19.13
		1	0	21.05	20.36
		1	38	21.25	20.51
		1	74	21.15	20.29
		37	0	20.32	20.37
		37	18	20.33	20.31
		37	37	20.34	20.35
		75	0	20.34	19.33
20	2510.0	1	0	20.85	19.90
		1	49	21.41	20.48
		1	99	21.27	20.34
		50	0	20.20	19.21
		50	25	20.16	19.19
		50	50	20.17	19.20
		100	0	20.22	19.19
	2535.0	1	0	21.41	20.43
		1	49	21.29	20.32
		1	99	20.81	19.84
		50	0	20.15	19.11
		50	25	20.15	19.15
		50	50	20.10	19.13
		100	0	20.07	19.13
	2560	1	0	20.96	20.14
		1	49	21.37	20.51
		1	99	21.07	20.17
		50	0	20.28	19.32
		50	25	20.29	19.31
		50	50	20.28	19.38
		100	0	20.24	19.29







LTE Band 12

BW (MHz)	Frequency (MHz)	RB Configuration		Average Power [dBm]	
		Size	Offset	QPSK	16QAM
1.4	699.7	1	0	24.06	23.79
		1	2	24.11	23.77
		1	5	24.07	23.81
		3	0	24.33	22.97
		3	1	24.32	22.97
		3	3	24.22	22.97
		6	0	23.21	22.37
	707.5	1	0	23.99	23.12
		1	2	24.17	23.01
		1	5	24.04	23.02
		3	0	24.21	23.11
		3	1	24.20	23.13
		3	3	24.26	23.15
		6	0	23.34	22.37
	715.3	1	0	23.88	23.56
		1	2	23.93	23.58
		1	5	23.95	23.58
		3	0	24.00	22.63
		3	1	23.88	22.64
		3	3	24.08	22.65
		6	0	23.02	22.05
3	700.5	1	0	24.14	23.19
		1	8	24.11	23.08
		1	14	24.21	23.29
		8	0	23.16	22.23
		8	4	23.17	22.22
		8	7	23.27	22.42
		15	0	23.14	22.09
	707.5	1	0	24.01	23.00
		1	8	24.06	22.99
		1	14	23.96	22.92
		8	0	23.21	22.47
		8	4	23.22	22.30
		8	7	23.08	22.37
		15	0	23.15	22.05
	714.3	1	0	24.02	23.57
		1	8	23.99	23.56
		1	14	23.93	23.52
		8	0	22.98	22.12
		8	4	23.02	22.11
		8	7	22.94	22.03
		15	0	22.93	22.04
5	701.5	1	0	24.24	22.56
		1	12	24.32	22.56
		1	24	24.20	22.51
		12	0	23.17	22.14
		12	6	23.24	22.14
		12	13	23.15	22.19
		25	0	23.11	22.33
	707.5	1	0	24.21	23.05
		1	12	24.23	22.99
		1	24	24.20	22.97
		12	0	23.11	22.05
		12	6	23.18	22.01
		12	13	23.21	22.14





	713.5	25	0	23.15	22.02
		1	0	24.16	23.00
		1	12	24.02	22.97
		1	24	24.07	22.82
		12	0	23.03	22.11
		12	6	23.05	22.12
		12	13	22.94	22.05
		25	0	23.04	22.07
10	704	1	0	24.17	22.94
		1	24	24.10	22.85
		1	49	24.08	22.86
		25	0	23.26	22.25
		25	12	23.37	22.26
		25	25	23.27	22.23
		50	0	23.13	22.08
	707.5	1	0	24.19	22.89
		1	24	24.14	22.85
		1	49	24.00	22.68
		25	0	23.31	22.31
		25	12	23.30	22.30
		25	25	23.04	22.23
		50	0	23.10	22.28
	711	1	0	24.35	22.95
		1	24	24.13	22.89
		1	49	23.97	22.69
		25	0	23.19	22.16
		25	12	23.05	22.19
		25	25	22.92	22.11
		50	0	22.93	22.13





LTE Band17

BW (MHz)	Frequency (MHz)	RB Configuration		Average Power [dBm]	
		Size	Offset	QPSK	16QAM
5	706.5	1	0	24.20	22.97
		1	12	24.15	22.97
		1	24	24.16	23.05
		12	0	23.10	22.17
		12	6	23.32	22.17
		12	13	23.12	22.22
		25	0	23.27	22.01
	710	1	0	24.19	23.06
		1	12	24.23	22.99
		1	24	24.13	22.91
		12	0	23.01	22.10
		12	6	23.13	22.09
		12	13	23.08	22.22
		25	0	23.13	22.20
	713.5	1	0	24.12	22.52
		1	12	24.01	22.30
		1	24	23.90	22.24
		12	0	23.07	22.11
		12	6	23.13	22.06
		12	13	23.03	21.94
		25	0	22.91	22.13
10	709	1	0	24.27	23.14
		1	24	24.16	23.08
		1	49	24.03	22.99
		25	0	23.23	22.24
		25	12	23.35	22.22
		25	25	23.21	22.27
		50	0	23.26	22.25
	710	1	0	24.15	22.85
		1	24	24.12	22.70
		1	49	23.85	22.60
		25	0	23.14	22.26
		25	12	23.22	22.28
		25	25	22.88	22.19
		50	0	23.17	22.12
	711	1	0	24.25	22.94
		1	24	24.12	22.88
		1	49	23.95	22.65
		25	0	23.11	22.16
		25	12	23.08	22.15
		25	25	22.91	22.09
		50	0	22.92	22.13





LTE Band 66

BW (MHz)	Frequency (MHz)	RB Configuration		Average Power [dBm]	
		Size	Offset	QPSK	16QAM
1.4	1710.7	1	0	23.12	22.99
		1	3	23.08	22.92
		1	5	23.09	22.94
		3	0	23.23	21.92
		3	2	23.21	21.90
		3	3	23.25	21.94
		6	0	22.04	21.42
	1755.0	1	0	23.07	22.93
		1	3	23.07	22.86
		1	5	23.08	22.83
		3	0	23.01	21.80
		3	2	23.02	21.43
		3	3	23.00	21.45
		6	0	21.88	21.04
	1779.3	1	0	22.57	21.82
		1	3	22.57	21.84
		1	5	22.54	21.80
		3	0	22.83	21.58
		3	2	22.78	21.63
		3	3	22.77	21.62
		6	0	21.66	20.83
3	1711.5	1	0	23.09	22.28
		1	7	23.15	22.25
		1	14	23.17	22.20
		8	0	22.20	21.35
		8	4	22.21	21.35
		8	7	22.21	21.42
		15	0	22.17	21.26
	1755.0	1	0	22.86	21.69
		1	7	22.81	21.63
		1	14	22.78	21.67
		8	0	21.87	21.07
		8	4	21.98	21.08
		8	7	21.97	21.12
		15	0	21.95	20.96
	1778.5	1	0	22.72	21.41
		1	7	22.62	21.27
		1	14	22.61	21.21
		8	0	21.73	20.94
		8	4	21.77	20.97
		8	7	21.58	20.89
		15	0	21.66	20.68
5	1712.5	1	0	23.15	21.46
		1	12	23.21	21.51
		1	24	23.22	21.58
		12	0	22.21	21.26
		12	6	22.21	21.25
		12	13	22.27	21.22
		25	0	22.19	21.37
	1755.0	1	0	23.03	21.44
		1	12	22.90	21.38
		1	24	22.96	21.37
		12	0	22.00	21.02
		12	6	22.00	21.07
		12	13	21.98	21.02





	1777.5	25	0	22.02	21.04	
		1	0	22.82	21.68	
		1	12	22.76	21.63	
		1	24	22.64	21.61	
		12	0	21.79	20.82	
		12	6	21.83	20.75	
		12	13	21.72	20.66	
		25	0	21.82	20.69	
10	1715.0	1	0	23.11	22.31	
		1	24	23.16	22.26	
		1	49	23.21	22.31	
		25	0	22.26	21.17	
		25	12	22.28	21.17	
		25	25	22.13	21.29	
		50	0	22.16	21.16	
	1755.0	1	0	22.95	21.92	
		1	24	22.87	21.81	
		1	49	22.84	21.89	
		25	0	22.05	20.97	
		25	12	22.04	20.96	
		25	25	21.94	21.00	
		50	0	21.83	20.99	
	1775.0	1	0	22.95	21.62	
		1	24	22.79	21.42	
		1	49	22.64	21.32	
		25	0	21.97	21.05	
		25	12	21.98	21.03	
		25	25	21.90	20.92	
		50	0	21.74	20.85	
	15	1717.5	1	0	23.02	22.07
			1	37	23.13	22.10
			1	74	23.07	22.03
37			0	22.21	22.28	
37			18	22.27	22.27	
37			38	22.27	22.26	
1755.0		75	0	22.26	21.27	
		1	0	22.98	21.99	
		1	37	22.78	21.87	
		1	74	22.81	21.85	
		37	0	21.95	21.91	
		37	18	21.90	21.90	
1772.5		37	38	21.90	21.96	
		75	0	21.94	20.92	
		1	0	22.89	22.12	
		1	37	22.86	22.14	
		1	74	22.63	21.89	
		37	0	21.94	21.94	
20	1720.0	37	18	21.95	21.95	
		37	38	21.96	21.96	
		75	0	21.96	21.03	
		1	0	23.27	22.20	
		1	49	23.31	22.24	
		1	99	23.31	22.23	
		50	0	22.12	21.27	
	1755.0	50	25	22.17	21.32	
		50	50	22.19	21.34	
		100	0	22.17	21.19	
	1755.0	1	0	23.51	21.35	
		1	49	23.36	21.25	





		1	99	23.35	21.24
		50	0	22.01	21.02
		50	25	21.96	21.01
		50	50	21.88	20.96
		100	0	21.97	20.87
	1770.0	1	0	23.11	22.31
		1	49	23.14	22.28
		1	99	22.90	21.96
		50	0	22.04	21.03
		50	25	21.99	21.06
		50	50	21.88	20.87
		100	0	21.87	20.94

<WLAN 2.4GHz Conducted Power>

Mode	Channel	Frequency (MHz)	Data rate (Mbps)	Average Output Power (dBm)
IEEE 802.11b	1	2412	1	12.22
			2	12.17
			5.5	12.14
			11	12.00
	6	2437	1	12.36
			2	12.30
			5.5	12.24
			11	12.15
	11	2462	1	12.22
			2	12.15
			5.5	12.10
			11	12.04
IEEE 802.11g	1	2412	6	12.51
			9	12.46
			12	12.40
			18	12.35
			24	12.31
			36	12.26
			48	12.21
			54	12.17
	6	2437	6	12.97
			9	12.92
			12	12.87
			18	12.83
			24	12.74
			36	12.69
			48	12.64
			54	12.55
	11	2462	6	12.97
			9	12.92
			12	12.88
			18	12.83
			24	12.77
			36	12.73
			48	12.67
			54	12.63
IEEE 802.11n HT20	1	2412	MCS0	10.46
			MCS1	10.40
			MCS2	10.36
			MCS3	10.31
			MCS4	10.25
			MCS5	10.20
			MCS6	10.14





6	2437	MCS7	10.08
		MCS0	13.06
		MCS1	13.02
		MCS2	12.97
		MCS3	12.94
		MCS4	12.89
		MCS5	12.85
		MCS6	12.81
	2462	MCS7	12.77
		MCS0	15.00
		MCS1	14.95
		MCS2	14.91
		MCS3	14.87
		MCS4	14.83
		MCS5	14.78
MCS6	14.72		
MCS7	14.69		

**Note:** SAR is not required for the following 2.4 GHz OFDM conditions as the highest reported SAR for DSSS is adjusted by the ratio of OFDM to DSSS specified maximum output power and the adjusted SAR is ≤ 1.2 W/kg.

**<WLAN 5.2G Conducted Power>**

Mode	Channel	Frequency (MHz)	Average Conducted Output Power(dBm)	Worst Case Test Rate Data
IEEE 802.11a	36	5180	13.20	MCS0
	40	5200	13.65	MCS0
	48	5240	10.89	MCS0
IEEE 802.11n HT20	36	5180	13.15	MCS0
	40	5200	13.86	MCS0
	48	5240	10.42	MCS0
IEEE 802.11n HT40	38	5190	13.85	MCS0
	46	5230	11.15	MCS0
IEEE 802.11AC20	36	5180	13.42	MCS0
	40	5200	12.89	MCS0
	48	5240	10.33	MCS0
IEEE 802.11AC40	38	5190	12.94	MCS0
	46	5230	11.01	MCS0
IEEE 802.11AC80	42	5210	12.02	MCS0

**<WLAN 5.8GHz Conducted Power>**

Mode	Channel	Frequency (MHz)	Average Conducted Output Power(dBm)	Worst Case Test Rate Data
IEEE 802.11a	149	5745	14.55	MCS0
	157	5785	12.77	MCS0
	165	5825	13.85	MCS0
IEEE 802.11n HT20	149	5745	13.95	MCS0
	157	5785	13.11	MCS0
	165	5825	12.15	MCS0
IEEE 802.11n HT40	151	5755	13.08	MCS0
	159	5795	12.52	MCS0
IEEE 802.11AC20	149	5745	14.96	MCS0





	157	5785	13.43	MCS0
	165	5825	13.14	MCS0
IEEE 802.11AC40	151	5755	14.73	MCS0
	159	5795	12.39	MCS0
IEEE 802.11AC80	155	5775	12.78	MCS0

## &lt;BT Conducted Power&gt;

Mode	channel	Frequency (MHz)	Conducted AVG output power (dBm)
BLE	0	2402	1.03
	19	2440	0.02
	39	2480	0.32
GFSK	0	2402	2.60
	39	2441	1.84
	78	2480	2.02
π/4-DQPSK	0	2402	2.67
	39	2441	1.97
	78	2480	2.63
8DPSK	0	2402	2.89
	39	2441	2.24
	78	2480	2.90

Per KDB 447498 D01v06, the 1-g and 10-g SAR test exclusion thresholds for 100 MHz to 6 GHz at test separation distances  $\leq 50$  mm are determined by:

$[(\text{max. power of channel, including tune-up tolerance, mW}) / (\text{min. test separation distance, mm})] \cdot [\sqrt{f(\text{GHz})}] \leq 3.0$   
for 1-g SAR and  $\leq 7.5$  for 10-g extremity SAR

- $f(\text{GHz})$  is the RF channel transmit frequency in GHz
- Power and distance are rounded to the nearest mW and mm before calculation
- The result is rounded to one decimal place for comparison

Bluetooth Tune up Power (dBm)	Separation Distance (mm)	Frequency (GHz)	Exclusion Thresholds
3.0	5	2.45	0.6

Per KDB 447498 D01v06, when the minimum test separation distance is  $< 5$  mm, a distance of 5 mm is applied to determine SAR test exclusion. The test exclusion threshold is  $0.6 < 3.0$ , SAR testing is not required.

Test Mode	Channel Frequency (MHz)	Field Strength (dBuV/m@3m)	Max Output Power(mW)	Calculate on Value(Note)	Threshold Value (mW)
NFC	13.56	66.87	0.0014	0.0014	443

Note:

1. Calculate the SAR test to eliminate thresholds from chapter 2 conditions "3" formula
2. Field Strength (dBuV/m@3m) = Field Strength (dBuV/m@30m) +  $40 \cdot \log(30/3)$
3. Max Power (dBm) = Field Strength of Fundamental (dBuV/m@3m) - 95.23
4. Max Power (mW) =  $10^{(\text{Max power (dBm)})/10}$

Since Source-base time average power is below SAR test exclusion power thresholds, the SAR evaluation is not required.





### 4.2. Transmit Antennas and SAR Measurement Position

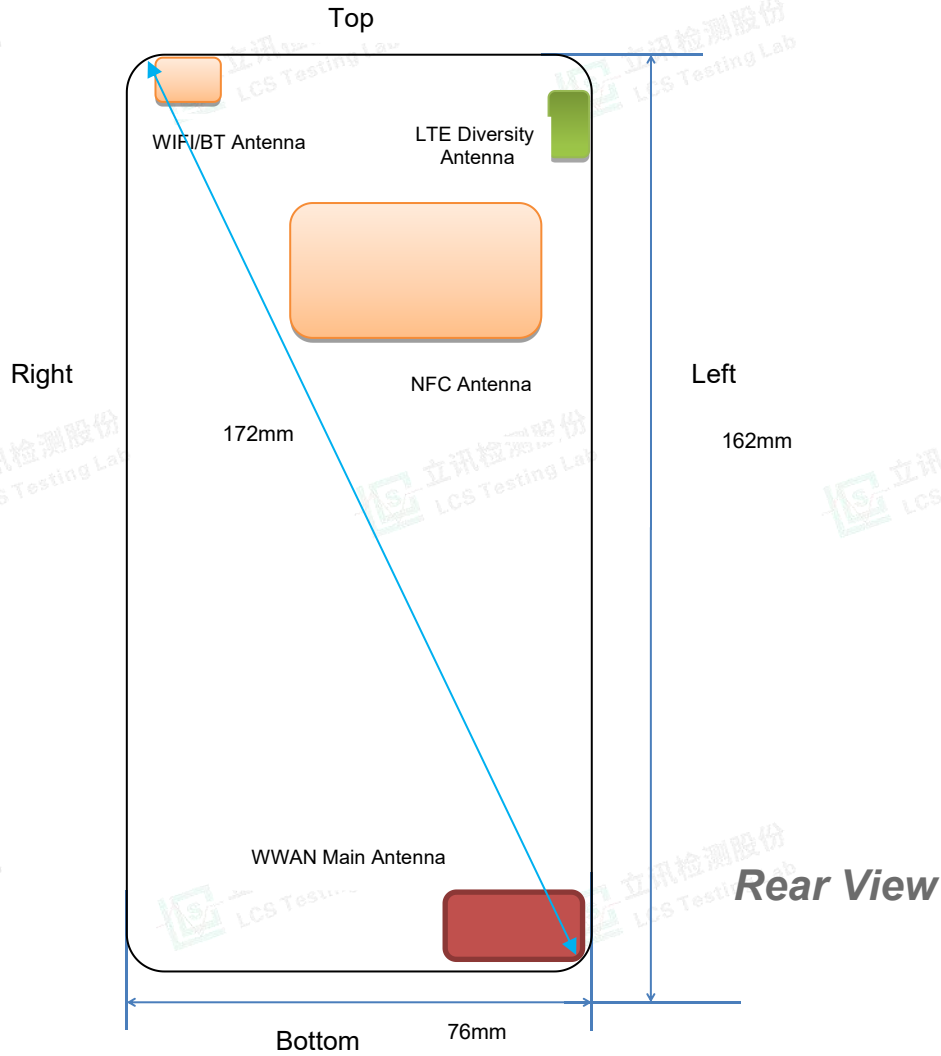

Antenna information:

WWAN Main Antenna	GSM/UMTS/LTE TX/RX
LTE Diversity antenna	Only RX
WLAN/BT Antenna	WLAN/BT TX/RX

Note:

- 1). Per KDB648474 D04, 10-g extremity SAR is not required when Body-Worn mode 1-g reported SAR < 1.2 W/Kg.
- 2). According to the KDB941225 D06 Hot Spot SAR v02, the edges with less than 25 mm distance to the antennas need to be tested for SAR.

Distance of The Antenna to the EUT surface and edge (mm)						
Antennas	Front	Back	Top Side	Bottom Side	Left Side	Right Side
WWAN	<5	<5	154	<5	<5	<5
BT/WLAN	<5	<5	<5	152	52	<5

Positions for SAR tests; Hotspot mode						
Antennas	Front	Back	Top Side	Bottom Side	Left Side	Right Side
WWAN	Yes	Yes	No	Yes	Yes	Yes
BT/WLAN	Yes	Yes	Yes	No	No	Yes

**General Note:** Referring to KDB 941225 D06 v02, When the overall device length and width are  $\geq 9\text{cm} \times 5\text{cm}$ , the test distance is 0mm, SAR must be measured for all sides and surfaces with a transmitting antenna located with 25mm from that surface or edge.





### 4.3. SAR Measurement Results

The calculated SAR is obtained by the following formula:

$$\text{Reported SAR} = \text{Measured SAR} * 10^{(P_{\text{target}} - P_{\text{measured}}) / 10}$$

$$\text{Scaling factor} = 10^{(P_{\text{target}} - P_{\text{measured}}) / 10}$$

$$\text{Reported SAR} = \text{Measured SAR} * \text{Scaling factor}$$

Where

$P_{\text{target}}$  is the power of manufacturing upper limit;

$P_{\text{measured}}$  is the measured power;

Measured SAR is measured SAR at measured power which including power drift)

Reported SAR which including Power Drift and Scaling factor

#### Duty Cycle

Test Mode	Duty Cycle
GPRS850	1:4
GPRS1900	1:2.67
UMTS	1:1
LTE	1:1
WLAN2450	1:1

#### 4.3.1 SAR Results

##### SAR Values [GSM 850]

Ch.	Freq. (MHz)	Time slots	Test Position	Conducted Power (dBm)	Maximum Allowed Power (dBm)	Power Drift (%)	Scaling Factor	SAR <sub>1-g</sub> results(W/kg)		Graph Results
								Measured	Reported	
measured / reported SAR numbers – Head										
190	836.6	Voice	Left Cheek	32.72	33.00	-1.78	1.067	<b>0.073</b>	<b>0.078</b>	Plot 1
190	836.6	Voice	Left Tilt	32.72	33.00	-2.05	1.067	0.040	0.043	
190	836.6	Voice	Right Cheek	32.72	33.00	-3.64	1.067	0.065	0.069	
190	836.6	Voice	Right Tilt	32.72	33.00	4.78	1.067	0.033	0.035	
measured / reported SAR numbers - Body (hotspot open, distance 10mm)										
190	836.6	2Txslots	Front	31.01	31.50	4.62	1.119	0.204	0.228	
190	836.6	2Txslots	Rear	31.01	31.50	0.45	1.119	<b>0.329</b>	<b>0.368</b>	Plot 2
190	836.6	2Txslots	Left	31.01	31.50	-4.44	1.119	0.196	0.219	
190	836.6	2Txslots	Right	31.01	31.50	0.32	1.119	0.178	0.199	
190	836.6	2Txslots	Bottom	31.01	31.50	3.65	1.119	0.166	0.186	

Remark:

1. The value with black color is the maximum SAR Value of each test band.
2. The frame average of GPRS (4Tx slots) higher than GSM and sample can support VoIP function, tested at GPRS (3Tx slots) mode for head.
3. Per FCC KDB Publication 447498 D01, if the reported (scaled) SAR measured at the middle channel or highest output power channel for each test configuration is  $\leq 0.8$  W/kg then testing at the other channels is optional for such test configuration(s).

##### SAR Values [GSM 1900]

Ch.	Freq. (MHz)	time slots	Test Position	Conduct ed Power (dBm)	Maximum Allowed Power (dBm)	Powe r Drift (%)	Scaling Factor	SAR <sub>1-g</sub> results(W/kg)		Graph Results
								Measured	Reported	
measured / reported SAR numbers – Head										
661	1880.0	Voice	Left Cheek	29.68	30.00	-0.86	1.076	<b>0.059</b>	<b>0.064</b>	Plot 3
661	1880.0	Voice	Left Tilt	29.68	30.00	-4.52	1.076	0.025	0.027	
661	1880.0	Voice	Right Cheek	29.68	30.00	3.12	1.076	0.050	0.054	
661	1880.0	Voice	Right Tilt	29.68	30.00	0.08	1.076	0.018	0.019	
measured / reported SAR numbers – Body (hotspot open, distance 10mm)										
661	1880.0	3Txslots	Front	26.53	27.00	-3.26	1.114	0.165	0.184	
661	1880.0	3Txslots	Rear	26.53	27.00	2.19	1.114	<b>0.232</b>	<b>0.259</b>	Plot 4
661	1880.0	3Txslots	Left	26.53	27.00	0.05	1.114	0.148	0.165	
661	1880.0	3Txslots	Right	26.53	27.00	-4.78	1.114	0.130	0.145	
661	1880.0	3Txslots	Bottom	26.53	27.00	3.56	1.114	0.118	0.131	



Shenzhen LCS Compliance Testing Laboratory Ltd.

Add: 101, 201 Bldg A & 301 Bldg C, Juji Industrial Park Yabianxueziwei, Shajing Street, Baoan District, Shenzhen, 518000, China

Tel: +(86) 0755-82591330 | E-mail: webmaster@lcs-cert.com | Web: www.lcs-cert.com

Scan code to check authenticity



## Remark:

1. The value with black color is the maximum SAR Value of each test band.
2. The frame average of GPRS (4Tx slots) higher than GSM and sample can support VoIP function, tested at GPRS (4Tx slots) mode for head.
3. Per FCC KDB Publication 447498 D01, if the reported (scaled) SAR measured at the middle channel or highest output power channel for each test configuration is  $\leq 0.8$  W/kg then testing at the other channels is optional for such test configuration(s).

## SAR Values [WCDMA Band V]

Ch.	Freq. (MHz)	Channel Type	Test Position	Conducted Power (dBm)	Maximum Allowed Power (dBm)	Power Drift (%)	Scaling Factor	SAR <sub>1-g</sub> results(W/kg)		Graph Results
								Measured	Reported	
measured / reported SAR numbers – Head										
4183	836.6	RMC*	Left Cheek	22.98	23.00	-4.15	1.005	<b>0.083</b>	<b>0.083</b>	<b>Plot 5</b>
4183	836.6	RMC*	Left Tilt	22.98	23.00	-3.33	1.005	0.044	0.044	
4183	836.6	RMC*	Right Cheek	22.98	23.00	0.45	1.005	0.075	0.075	
4183	836.6	RMC*	Right Tilt	22.98	23.00	1.96	1.005	0.035	0.035	
measured / reported SAR numbers – Body (hotspot open, distance 10mm)										
4183	836.6	RMC*	Front	22.98	23.00	-4.52	1.005	0.208	0.209	
4183	836.6	RMC*	Rear	22.98	23.00	0.24	1.005	<b>0.312</b>	<b>0.313</b>	<b>Plot 6</b>
4183	836.6	RMC*	Left	22.98	23.00	-4.74	1.005	0.199	0.200	
4183	836.6	RMC*	Right	22.98	23.00	1.56	1.005	0.182	0.183	
4183	836.6	RMC*	Bottom	22.98	23.00	0.34	1.005	0.169	0.170	

## Remark:

1. The value with black color is the maximum SAR Value of each test band.
2. Per FCC KDB Publication 447498 D01, if the reported (scaled) SAR measured at the middle channel or highest output power channel for each test configuration is  $\leq 0.8$  W/kg then testing at the other channels is optional for such test configuration(s).
3. RMC\* - RMC 12.2kbps mode;

## SAR Values [WCDMA Band IV]

Ch.	Freq. (MHz)	Channel Type	Test Position	Conducted Power (dBm)	Maximum Allowed Power (dBm)	Power Drift (%)	Scaling Factor	SAR <sub>1-g</sub> results(W/kg)		Graph Results
								Measured	Reported	
measured / reported SAR numbers – Head										
1413	1732.6	RMC	Left Cheek	23.34	23.50	2.99	1.038	<b>0.122</b>	<b>0.127</b>	<b>Plot 7</b>
1413	1732.6	RMC	Left Tilt	23.34	23.50	-3.56	1.038	0.074	0.077	
1413	1732.6	RMC	Right Cheek	23.34	23.50	0.29	1.038	0.113	0.117	
1413	1732.6	RMC	Right Tilt	23.34	23.50	3.52	1.038	0.064	0.066	
measured / reported SAR numbers – Body (hotspot open, distance 10mm)										
1413	1732.6	RMC	Front	23.34	23.50	3.87	1.038	0.224	0.232	
1413	1732.6	RMC	Rear	23.34	23.50	1.45	1.038	<b>0.299</b>	<b>0.310</b>	<b>Plot 8</b>
1413	1732.6	RMC	Left	23.34	23.50	0.25	1.038	0.213	0.221	
1413	1732.6	RMC	Right	23.34	23.50	-4.71	1.038	0.205	0.213	
1413	1732.6	RMC	Bottom	23.34	23.50	2.68	1.038	0.198	0.205	

## Remark:

1. The value with black color is the maximum SAR Value of each test band.
2. Per FCC KDB Publication 447498 D01, if the reported (scaled) SAR measured at the middle channel or highest output power channel for each test configuration is  $\leq 0.8$  W/kg then testing at the other channels is optional for such test configuration(s).
3. RMC\* - RMC 12.2kbps mode;



**SAR Values [WCDMA Band II]**

Ch.	Freq. (MHz)	Channel Type	Test Position	Conducted Power (dBm)	Maximum Allowed Power (dBm)	Power Drift (%)	Scaling Factor	SAR <sub>1-g</sub> results(W/kg)		Graph Results
								Measured	Reported	
<i>measured / reported SAR numbers – Head</i>										
9400	1880.0	RMC*	Left Cheek	23.44	23.50	-1.42	1.014	<b>0.115</b>	<b>0.117</b>	<b>Plot 9</b>
9400	1880.0	RMC*	Left Tilt	23.44	23.50	-4.78	1.014	0.063	0.064	
9400	1880.0	RMC*	Right Cheek	23.44	23.50	3.96	1.014	0.102	0.103	
9400	1880.0	RMC*	Right Tilt	23.44	23.50	1.14	1.014	0.052	0.053	
<i>measured / reported SAR numbers - Body (hotspot open, distance 10mm)</i>										
9400	1880.0	RMC*	Front	23.44	23.50	-2.56	1.014	0.358	0.363	
9400	1880.0	RMC*	Rear	23.44	23.50	-0.17	1.014	<b>0.418</b>	<b>0.424</b>	<b>Plot 10</b>
9400	1880.0	RMC*	Left	23.44	23.50	-4.44	1.014	0.337	0.342	
9400	1880.0	RMC*	Right	23.44	23.50	3.89	1.014	0.321	0.325	
9400	1880.0	RMC*	Bottom	23.44	23.50	0.35	1.014	0.312	0.316	

**Remark:**

- The value with black color is the maximum SAR Value of each test band.
- Per FCC KDB Publication 447498 D01, if the reported (scaled) SAR measured at the middle channel or highest output power channel for each test configuration is  $\leq 0.8$  W/kg then testing at the other channels is optional for such test configuration(s).
- RMC\* - RMC 12.2kbps mode;

**SAR Values [LTE Band 2]**

Ch.	Freq. (MHz)	Channel Type (10M)	Test Position	Conducted Power (dBm)	Maximum Allowed Power (dBm)	Power Drift (%)	Scaling Factor	SAR <sub>1-g</sub> results(W/kg)		Graph Results
								Measured	Reported	
<i>measured / reported SAR numbers - Head</i>										
19100	1900.0	1RB	Left Cheek	23.63	24.00	-0.82	1.089	<b>0.090</b>	<b>0.098</b>	<b>Plot 11</b>
19100	1900.0	1RB	Left Tilt	23.63	24.00	-3.33	1.089	0.042	0.046	
19100	1900.0	1RB	Right Cheek	23.63	24.00	1.52	1.089	0.083	0.090	
19100	1900.0	1RB	Right Tilt	23.63	24.00	-4.78	1.089	0.037	0.040	
19100	1900.0	50%RB	Left Cheek	22.40	22.50	2.69	1.023	0.046	0.047	
19100	1900.0	50%RB	Left Tilt	22.40	22.50	0.08	1.023	0.023	0.024	
19100	1900.0	50%RB	Right Cheek	22.40	22.50	1.98	1.023	0.040	0.041	
19100	1900.0	50%RB	Right Tilt	22.40	22.50	-2.48	1.023	0.018	0.018	
<i>measured / reported SAR numbers - Body (hotspot open, distance 10mm)</i>										
19100	1900.0	1RB	Front	23.63	24.00	-0.41	1.089	0.253	0.275	
19100	1900.0	1RB	Rear	23.63	24.00	0.50	1.089	<b>0.352</b>	<b>0.383</b>	<b>Plot 12</b>
19100	1900.0	1RB	Left	23.63	24.00	-4.52	1.089	0.236	0.257	
19100	1900.0	1RB	Right	23.63	24.00	3.65	1.089	0.224	0.244	
19100	1900.0	1RB	Bottom	23.63	24.00	0.28	1.089	0.214	0.233	
19100	1900.0	50%RB	Front	22.40	22.50	4.12	1.023	0.122	0.125	
19100	1900.0	50%RB	Rear	22.40	22.50	-2.98	1.023	0.173	0.177	
19100	1900.0	50%RB	Left	22.40	22.50	1.98	1.023	0.115	0.118	
19100	1900.0	50%RB	Right	22.40	22.50	3.35	1.023	0.106	0.108	
19100	1900.0	50%RB	Bottom	22.40	22.50	0.02	1.023	0.093	0.095	



**SAR Values [LTE Band 4]**

Ch.	Freq. (MHz)	Channel Type (10M)	Test Position	Conducted Power (dBm)	Maximum Allowed Power (dBm)	Power Drift (%)	Scaling Factor	SAR1-g results(W/kg)		Graph Results
								Measured	Reported	
<i>measured / reported SAR numbers - Head</i>										
20175	1732.5	1RB	Left Cheek	23.49	23.50	-2.81	1.002	<b>0.060</b>	<b>0.060</b>	<b>Plot 13</b>
20175	1732.5	1RB	Left Tilt	23.49	23.50	-4.21	1.002	0.028	0.028	
20175	1732.5	1RB	Right Cheek	23.49	23.50	2.58	1.002	0.054	0.054	
20175	1732.5	1RB	Right Tilt	23.49	23.50	-3.65	1.002	0.024	0.024	
20175	1732.5	50%RB	Left Cheek	22.31	22.50	-4.20	1.045	0.031	0.032	
20175	1732.5	50%RB	Left Tilt	22.31	22.50	1.77	1.045	0.015	0.016	
20175	1732.5	50%RB	Right Cheek	22.31	22.50	-3.33	1.045	0.027	0.028	
20175	1732.5	50%RB	Right Tilt	22.31	22.50	2.89	1.045	0.010	0.010	
<i>measured / reported SAR numbers - Body (hotspot open, distance 10mm)</i>										
20175	1732.5	1RB	Front	23.49	23.50	3.65	1.002	0.142	0.142	
20175	1732.5	1RB	Rear	23.49	23.50	-0.56	1.002	<b>0.218</b>	<b>0.219</b>	<b>Plot 14</b>
20175	1732.5	1RB	Left	23.49	23.50	-2.56	1.002	0.133	0.133	
20175	1732.5	1RB	Right	23.49	23.50	-4.78	1.002	0.124	0.124	
20175	1732.5	1RB	Bottom	23.49	23.50	-1.92	1.002	0.105	0.105	
20175	1732.5	50%RB	Front	22.31	22.50	1.56	1.045	0.075	0.078	
20175	1732.5	50%RB	Rear	22.31	22.50	-3.36	1.045	0.160	0.167	
20175	1732.5	50%RB	Left	22.31	22.50	-0.89	1.045	0.064	0.067	
20175	1732.5	50%RB	Right	22.31	22.50	2.56	1.045	0.057	0.060	
20175	1732.5	50%RB	Bottom	22.31	22.50	1.45	1.045	0.038	0.040	

**SAR Values [LTE Band 5]**

Ch.	Freq. (MHz)	Channel Type (10M)	Test Position	Conducted Power (dBm)	Maximum Allowed Power (dBm)	Power Drift (%)	Scaling Factor	SAR1-g results(W/kg)		Graph Results
								Measured	Reported	
<i>measured / reported SAR numbers - Head</i>										
20525	836.5	1RB	Left Cheek	24.55	25.00	-1.75	1.109	<b>0.054</b>	<b>0.060</b>	<b>Plot 15</b>
20525	836.5	1RB	Left Tilt	24.55	25.00	-4.52	1.109	0.026	0.029	
20525	836.5	1RB	Right Cheek	24.55	25.00	3.97	1.109	0.047	0.052	
20525	836.5	1RB	Right Tilt	24.55	25.00	1.03	1.109	0.021	0.023	
20525	836.5	50%RB	Left Cheek	23.62	24.00	2.56	1.091	0.028	0.031	
20525	836.5	50%RB	Left Tilt	23.62	24.00	-3.78	1.091	0.014	0.015	
20525	836.5	50%RB	Right Cheek	23.62	24.00	2.98	1.091	0.023	0.025	
20525	836.5	50%RB	Right Tilt	23.62	24.00	0.12	1.091	0.010	0.011	
<i>measured / reported SAR numbers - Body (hotspot open, distance 10mm)</i>										
20525	836.5	1RB	Front	24.55	25.00	3.45	1.109	0.160	0.177	
20525	836.5	1RB	Rear	24.55	25.00	1.12	1.109	<b>0.234</b>	<b>0.260</b>	<b>Plot 16</b>
20525	836.5	1RB	Left	24.55	25.00	-3.45	1.109	0.152	0.169	
20525	836.5	1RB	Right	24.55	25.00	1.98	1.109	0.139	0.154	
20525	836.5	1RB	Bottom	24.55	25.00	0.74	1.109	0.122	0.135	
20525	836.5	50%RB	Front	23.62	24.00	3.55	1.091	0.082	0.089	
20525	836.5	50%RB	Rear	23.62	24.00	1.44	1.091	0.122	0.133	
20525	836.5	50%RB	Left	23.62	24.00	-3.05	1.091	0.074	0.081	
20525	836.5	50%RB	Right	23.62	24.00	3.68	1.091	0.062	0.068	
20525	836.5	50%RB	Bottom	23.62	24.00	-1.11	1.091	0.045	0.049	



**SAR Values [LTE Band 7]**

Ch.	Freq. (MHz)	Channel Type (20M)	Test Position	Conducted Power (dBm)	Maximum Allowed Power (dBm)	Power Drift (%)	Scaling Factor	SAR <sub>1-g</sub> results(W/kg)		Graph Results
								Measured	Reported	
<i>measured / reported SAR numbers – Head</i>										
20850	2510.0	1RB	Left Cheek	21.41	21.50	-3.19	1.021	<b>0.049</b>	<b>0.050</b>	<b>Plot 17</b>
20850	2510.0	1RB	Left Tilt	21.41	21.50	-3.64	1.021	0.024	0.025	
20850	2510.0	1RB	Right Cheek	21.41	21.50	1.45	1.021	0.042	0.043	
20850	2510.0	1RB	Right Tilt	21.41	21.50	0.98	1.021	0.017	0.017	
21350	2560.0	50%RB	Left Cheek	20.29	20.50	-4.77	1.050	0.025	0.026	
21350	2560.0	50%RB	Left Tilt	20.29	20.50	3.26	1.050	0.013	0.014	
21350	2560.0	50%RB	Right Cheek	20.29	20.50	1.98	1.050	0.020	0.021	
21350	2560.0	50%RB	Right Tilt	20.29	20.50	-0.68	1.050	0.008	0.008	
<i>measured / reported SAR numbers - Body (hotspot open, distance 10mm)</i>										
20850	2510.0	1RB	Front	21.41	21.50	-4.65	1.021	0.582	0.594	
20850	2510.0	1RB	Rear	21.41	21.50	-0.15	1.021	<b>0.704</b>	<b>0.719</b>	<b>Plot 18</b>
20850	2510.0	1RB	Left	21.41	21.50	-3.35	1.021	0.577	0.589	
20850	2510.0	1RB	Right	21.41	21.50	-0.24	1.021	0.563	0.575	
20850	2510.0	1RB	Bottom	21.41	21.50	-1.78	1.021	0.548	0.559	
21350	2560.0	50%RB	Front	20.29	20.50	2.96	1.050	0.289	0.303	
21350	2560.0	50%RB	Rear	20.29	20.50	-2.33	1.050	0.354	0.372	
21350	2560.0	50%RB	Left	20.29	20.50	0.89	1.050	0.277	0.291	
21350	2560.0	50%RB	Right	20.29	20.50	-3.45	1.050	0.256	0.269	
21350	2560.0	50%RB	Bottom	20.29	20.50	0.67	1.050	0.241	0.253	

**SAR Values [LTE Band 12]**

Ch.	Freq. (MHz)	Channel Type (20M)	Test Position	Conducted Power (dBm)	Maximum Allowed Power (dBm)	Power Drift (%)	Scaling Factor	SAR <sub>1-g</sub> results(W/kg)		Graph Results
								Measured	Reported	
<i>measured / reported SAR numbers – Head</i>										
23130	711.0	1RB	Left Cheek	24.35	24.50	-2.26	1.035	<b>0.055</b>	<b>0.057</b>	<b>Plot 19</b>
23130	711.0	1RB	Left Tilt	24.35	24.50	-3.64	1.035	0.026	0.027	
23130	711.0	1RB	Right Cheek	24.35	24.50	2.58	1.035	0.049	0.051	
23130	711.0	1RB	Right Tilt	24.35	24.50	-4.73	1.035	0.021	0.022	
23060	704.0	50%RB	Left Cheek	23.37	23.50	2.06	1.030	0.028	0.029	
23060	704.0	50%RB	Left Tilt	23.37	23.50	3.97	1.030	0.013	0.013	
23060	704.0	50%RB	Right Cheek	23.37	23.50	2.02	1.030	0.024	0.025	
23060	704.0	50%RB	Right Tilt	23.37	23.50	-3.33	1.030	0.007	0.007	
<i>measured / reported SAR numbers - Body (hotspot open, distance 10mm)</i>										
23130	711.0	1RB	Front	24.35	24.50	-3.45	1.035	0.105	0.109	
23130	711.0	1RB	Rear	24.35	24.50	0.45	1.035	<b>0.165</b>	<b>0.171</b>	<b>Plot 20</b>
23130	711.0	1RB	Left	24.35	24.50	-1.09	1.035	0.094	0.097	
23130	711.0	1RB	Right	24.35	24.50	3.12	1.035	0.088	0.091	
23130	711.0	1RB	Bottom	24.35	24.50	-4.62	1.035	0.077	0.080	
23060	704.0	50%RB	Front	23.37	23.50	3.46	1.030	0.053	0.055	
23060	704.0	50%RB	Rear	23.37	23.50	0.97	1.030	0.082	0.084	
23060	704.0	50%RB	Left	23.37	23.50	1.11	1.030	0.042	0.043	
23060	704.0	50%RB	Right	23.37	23.50	-0.05	1.030	0.036	0.037	
23060	704.0	50%RB	Bottom	23.37	23.50	0.64	1.030	0.022	0.023	



**SAR Values [LTE Band 17]**

Ch.	Freq. (MHz)	Channel Type (20M)	Test Position	Conducted Power (dBm)	Maximum Allowed Power (dBm)	Power Drift (%)	Scaling Factor	SAR <sub>1-g</sub> results(W/kg)		Graph Results
								Measured	Reported	
<i>measured / reported SAR numbers – Head</i>										
23780	709.0	1RB	Left Cheek	24.27	24.50	-2.56	1.054	<b>0.061</b>	<b>0.064</b>	<b>Plot 21</b>
23780	709.0	1RB	Left Tilt	24.27	24.50	-3.05	1.054	0.029	0.031	
23780	709.0	1RB	Right Cheek	24.27	24.50	1.52	1.054	0.055	0.058	
23780	709.0	1RB	Right Tilt	24.27	24.50	-3.78	1.054	0.023	0.024	
23780	709.0	50%RB	Left Cheek	23.35	23.50	2.78	1.035	0.031	0.032	
23780	709.0	50%RB	Left Tilt	23.35	23.50	3.99	1.035	0.015	0.016	
23780	709.0	50%RB	Right Cheek	23.35	23.50	-4.10	1.035	0.025	0.026	
23780	709.0	50%RB	Right Tilt	23.35	23.50	2.98	1.035	0.010	0.010	
<i>measured / reported SAR numbers - Body (hotspot open, distance 10mm)</i>										
23780	709.0	1RB	Front	24.27	24.50	-0.05	1.054	0.123	0.130	
23780	709.0	1RB	Rear	24.27	24.50	-0.38	1.054	<b>0.192</b>	<b>0.202</b>	<b>Plot 22</b>
23780	709.0	1RB	Left	24.27	24.50	3.45	1.054	0.114	0.120	
23780	709.0	1RB	Right	24.27	24.50	2.89	1.054	0.103	0.109	
23780	709.0	1RB	Bottom	24.27	24.50	3.79	1.054	0.089	0.094	
23780	709.0	50%RB	Front	23.35	23.50	-3.33	1.035	0.063	0.065	
23780	709.0	50%RB	Rear	23.35	23.50	1.40	1.035	0.096	0.099	
23780	709.0	50%RB	Left	23.35	23.50	-0.52	1.035	0.056	0.058	
23780	709.0	50%RB	Right	23.35	23.50	-1.78	1.035	0.050	0.052	
23780	709.0	50%RB	Bottom	23.35	23.50	-0.03	1.035	0.044	0.046	

**SAR Values [LTE Band 66]**

Ch.	Freq. (MHz)	Channel Type (20M)	Test Position	Conducted Power (dBm)	Maximum Allowed Power (dBm)	Power Drift (%)	Scaling Factor	SAR <sub>1-g</sub> results(W/kg)		Graph Results
								Measured	Reported	
<i>measured / reported SAR numbers - Head</i>										
132422	1755.0	1RB	Left Cheek	23.51	24.00	3.78	1.119	<b>0.025</b>	<b>0.028</b>	<b>Plot 23</b>
132422	1755.0	1RB	Left Tilt	23.51	24.00	-4.23	1.119	0.012	0.013	
132422	1755.0	1RB	Right Cheek	23.51	24.00	-4.33	1.119	0.020	0.022	
132422	1755.0	1RB	Right Tilt	23.51	24.00	1.89	1.119	0.009	0.010	
132072	1720.0	50%RB	Left Cheek	22.19	22.50	0.50	1.074	0.014	0.015	
132072	1720.0	50%RB	Left Tilt	22.19	22.50	3.45	1.074	0.006	0.006	
132072	1720.0	50%RB	Right Cheek	22.19	22.50	-1.46	1.074	0.009	0.010	
132072	1720.0	50%RB	Right Tilt	22.19	22.50	3.45	1.074	0.004	0.004	
<i>measured / reported SAR numbers - Body (hotspot open, distance 10mm)</i>										
132422	1755.0	1RB	Front	23.51	24.00	-0.45	1.119	0.339	0.379	
132422	1755.0	1RB	Rear	23.51	24.00	-0.26	1.119	<b>0.693</b>	<b>0.776</b>	<b>Plot 24</b>
132422	1755.0	1RB	Left	23.51	24.00	-4.14	1.119	0.318	0.356	
132422	1755.0	1RB	Right	23.51	24.00	0.25	1.119	0.304	0.340	
132422	1755.0	1RB	Bottom	23.51	24.00	3.97	1.119	0.290	0.325	
132072	1720.0	50%RB	Front	22.19	22.50	-4.78	1.074	0.163	0.175	
132072	1720.0	50%RB	Rear	22.19	22.50	2.05	1.074	0.232	0.249	
132072	1720.0	50%RB	Left	22.19	22.50	-3.64	1.074	0.154	0.165	
132072	1720.0	50%RB	Right	22.19	22.50	1.78	1.074	0.143	0.154	
132072	1720.0	50%RB	Bottom	22.19	22.50	0.02	1.074	0.129	0.139	



Shenzhen LCS Compliance Testing Laboratory Ltd.

Add: 101, 201 Bldg A &amp; 301 Bldg C, Juji Industrial Park Yabianxueziwei, Shajing Street, Baoan District, Shenzhen, 518000, China

Tel: +(86) 0755-82591330 | E-mail: webmaster@lcs-cert.com | Web: www.lcs-cert.com

Scan code to check authenticity

**SAR Values [WIFI2.4G]**

Ch.	Freq. (MHz)	Service	Test Position	Conducted Power (dBm)	Maximum Allowed Power (dBm)	Power Drift (%)	Scaling Factor	SAR <sub>1-g</sub> results(W/kg)		Graph Results
								Measured	Reported	
<i>measured / reported SAR numbers – Head</i>										
6	2437	802.11n HT20	Left Cheek	15.00	15.00	-0.75	1.000	<b>0.011</b>	<b>0.011</b>	<b>Plot 25</b>
6	2437	802.11n HT20	Left Tilt	15.00	15.00	-4.47	1.000	0.006	0.006	
6	2437	802.11n HT20	Right Cheek	15.00	15.00	0.13	1.000	0.008	0.008	
6	2437	802.11n HT20	Right Tilt	15.00	15.00	2.96	1.000	0.004	0.004	
<i>measured / reported SAR numbers - Body (hotspot open, distance 10mm)</i>										
6	2437	802.11n HT20	Front	15.00	15.00	-4.75	1.000	0.101	0.101	
6	2437	802.11n HT20	Rear	15.00	15.00	-0.65	1.000	<b>0.147</b>	<b>0.147</b>	<b>Plot 26</b>
6	2437	802.11n HT20	Right	15.00	15.00	2.23	1.000	0.096	0.096	
6	2437	802.11n HT20	Top	15.00	15.00	-0.13	1.000	0.083	0.083	

**SAR Values [WIFI5.2G]**

Ch.	Freq. (MHz)	Service	Test Position	Conducted Power (dBm)	Maximum Allowed Power (dBm)	Power Drift (%)	Scaling Factor	SAR <sub>1-g</sub> results(W/kg)		Graph Results
								Measured	Reported	
<i>measured / reported SAR numbers – Head</i>										
40	5200	802.11n HT20	Left Cheek	13.86	14.00	-1.52	1.033	<b>0.046</b>	<b>0.048</b>	<b>Plot 27</b>
40	5200	802.11n HT20	Left Tilt	13.86	14.00	-3.12	1.033	0.024	0.025	
40	5200	802.11n HT20	Right Cheek	13.86	14.00	0.98	1.033	0.039	0.040	
40	5200	802.11n HT20	Right Tilt	13.86	14.00	2.77	1.033	0.018	0.019	
<i>measured / reported SAR numbers - Body (hotspot open, distance 10mm)</i>										
40	5200	802.11n HT20	Front	13.86	14.00	-4.36	1.033	0.029	0.030	
40	5200	802.11n HT20	Rear	13.86	14.00	0.25	1.033	<b>0.053</b>	<b>0.055</b>	<b>Plot 28</b>
40	5200	802.11n HT20	Right	13.86	14.00	-2.06	1.033	0.021	0.022	
40	5200	802.11n HT20	Top	13.86	14.00	1.11	1.033	0.015	0.015	

**SAR Values [WIFI5.8G]**

Ch.	Freq. (MHz)	Service	Test Position	Conducted Power (dBm)	Maximum Allowed Power (dBm)	Power Drift (%)	Scaling Factor	SAR <sub>1-g</sub> results(W/kg)		Graph Results
								Measured	Reported	
<i>measured / reported SAR numbers – Head</i>										
149	5745	802.11AC20	Left Cheek	14.96	15.00	-4.70	1.009	<b>0.016</b>	<b>0.016</b>	<b>Plot 29</b>
149	5745	802.11AC20	Left Tilt	14.96	15.00	-4.21	1.009	0.007	0.007	
149	5745	802.11AC20	Right Cheek	14.96	15.00	-3.12	1.009	0.011	0.011	
149	5745	802.11AC20	Right Tilt	14.96	15.00	0.45	1.009	0.005	0.005	
<i>measured / reported SAR numbers - Body (hotspot open, distance 10mm)</i>										
149	5745	802.11AC20	Front	14.96	15.00	-4.12	1.009	0.008	0.008	
149	5745	802.11AC20	Rear	14.96	15.00	-2.57	1.009	<b>0.014</b>	<b>0.014</b>	<b>Plot 30</b>
149	5745	802.11AC20	Right	14.96	15.00	-2.08	1.009	0.006	0.006	
149	5745	802.11AC20	Top	14.96	15.00	3.45	1.009	0.003	0.003	

**Remark:**

1. The value with black color is the maximum SAR Value of each test band.
2. Per FCC KDB Publication 447498 D01, if the reported (scaled) SAR measured at the middle channel or highest output power channel for each test configuration is  $\leq 0.8$  W/kg then testing at the other channels is optional for such test configuration(s).
3. When the same maximum output power is specified for both bands, begin SAR measurement in U-NII-2A band by applying the OFDM SAR requirements. 19 If the highest reported SAR for a test configuration is  $\leq 1.2$  W/kg, SAR is not required for U-NII-1 band for that configuration (802.11 mode and exposure condition); otherwise, each band is tested independently for SAR.







4. When different maximum output power is specified for the bands, begin SAR measurement in the band with higher specified maximum output power. The highest reported SAR for the tested configuration is adjusted by the ratio of lower to higher specified maximum output power for the two bands. When the adjusted SAR is  $\leq 1.2$  W/kg, SAR is not required for the band with lower maximum output power in that test configuration; otherwise, each band is tested independently for SAR.





### 4.3.2 Standalone SAR Test Exclusion Considerations and Estimated SAR

Per KDB447498 requires when the standalone SAR test exclusion of section 4.3.1 is applied to an antenna that transmits simultaneously with other antennas, the standalone SAR must be estimated according to the following to determine simultaneous transmission SAR test exclusion;

• (max. power of channel, including tune-up tolerance, mW)/(min. test separation distance, mm) • [ √ f(GHz)/x] W/kg for test separation distances ≤ 50 mm;

where x = 7.5 for 1-g SAR, and x = 18.75 for 10-g SAR.

• 0.4 W/kg for 1-g SAR and 1.0 W/kg for 10-g SAR, when the test separation distances is > 50 mm

Per FCC KD B447498 D01, simultaneous transmission SAR test exclusion may be applied when the sum of the 1-g SAR for all the transmitting antenna in a specific a physical test configuration is ≤1.6 W/Kg. When the sum is greater than the SAR limit, SAR test exclusion is determined by the SAR to peak location separation ratio.

$$\text{Ratio} = \frac{(\text{SAR}_1 + \text{SAR}_2)^{1.5}}{(\text{peak location separation, mm})} < 0.04$$

Estimated stand alone SAR					
Communication system	Frequency (MHz)	Configuration	Maximum Power (dBm)	Separation Distance (mm)	Estimated SAR <sub>1-g</sub> (W/kg)
Bluetooth*	2450	Head	3.0	5	0.084
Bluetooth*	2450	Hotspot	3.0	10	0.042
Bluetooth*	2450	Body-worn	3.0	10	0.042
NFC	13.56	Head	-28.69	5	0.0000653
NFC	13.56	Hotspot	-28.69	10	0.0000327
NFC	13.56	Body-worn	-28.69	10	0.0000327

Remark:

1. Bluetooth\*/NFC- Including Lower power Bluetooth
2. Maximum average power including tune-up tolerance;
3. When the minimum test separation distance is < 5 mm, a distance of 5 mm is applied to determine SAR test exclusion
4. Body as body use distance is 10mm from manufacturer declaration of user manual

### 4.4. Simultaneous TX SAR Considerations

#### 4.4.1 Introduction

Simultaneous transmission SAR test exclusion is determined for each operating configuration and exposure condition according to the reported standalone SAR of each applicable simultaneous transmitting antenna. The device has 4 antennas, WWAN main antenna, WWAN diversity antenna(RX only), and WiFi antenna supports 2.4Wi-Fi. The 2 TX antennas can always transmit simultaneously. The work mode combination is showed as below table.;

Application Simultaneous Transmission information:

Combination No.	Mode
1	WWAN+WIFI
2	WWAN+BT
3	WWAN+NFC
4	WIFI+ NFC
5	BT+ NFC





## 4.4.2 Evaluation of Simultaneous SAR

### Head Exposure Conditions

#### Simultaneous transmission SAR for WiFi and GSM

Test Position	GSM850 Reported SAR1-g (W/kg)	GSM1900 Reported SAR1-g (W/kg)	WiFi2.4G Reported SAR1-g (W/kg)	WiFi5.2G Reported SAR1-g (W/kg)	WiFi5.8G Reported SAR1-g (W/kg)	MAX. $\Sigma$ SAR1-g (W/kg)	SAR1-g Limit (W/kg)	Peak location separation ratio	Simut Meas. Required
Left Cheek	<b>0.078</b>	0.064	0.011	<b>0.048</b>	0.016	<b>0.126</b>	1.6	no	no
Left Tilt	<b>0.043</b>	0.027	0.006	<b>0.025</b>	0.007	0.068	1.6	no	no
Right Cheek	<b>0.069</b>	0.054	0.008	<b>0.040</b>	0.011	0.109	1.6	no	no
Right Tilt	<b>0.035</b>	0.019	0.004	<b>0.019</b>	0.005	0.054	1.6	no	no

#### Simultaneous transmission SAR for WiFi and UMTS

Test Position	UMTS Band V Reported SAR1-g (W/kg)	UMTS Band IV Reported SAR1-g (W/kg)	UMTS Band II Reported SAR1-g (W/kg)	WiFi2.4G Reported SAR1-g (W/kg)	WiFi5.2G Reported SAR1-g (W/kg)	WiFi5.8G Reported SAR1-g (W/kg)	MAX. $\Sigma$ SAR1-g (W/kg)	SAR1-g Limit (W/kg)	Peak location separation ratio	Simut Meas. Required
Left Cheek	0.083	<b>0.127</b>	0.117	0.011	<b>0.048</b>	0.016	<b>0.175</b>	1.6	no	no
Left Tilt	0.044	<b>0.077</b>	0.064	0.006	<b>0.025</b>	0.007	0.102	1.6	no	no
Right Cheek	0.075	<b>0.117</b>	0.103	0.008	<b>0.040</b>	0.011	0.157	1.6	no	no
Right Tilt	0.035	<b>0.066</b>	0.053	0.004	<b>0.019</b>	0.005	0.085	1.6	no	no

#### Simultaneous transmission SAR for WiFi and LTE

Reported SAR1-g(W/kg)	Test Position			
	Left Cheek	Left Tilt	Right Cheek	Right Tilt
LTE Band2	<b>0.098</b>	<b>0.046</b>	<b>0.090</b>	<b>0.040</b>
LTE Band4	0.060	0.028	0.054	0.024
LTE Band5	0.060	0.029	0.052	0.023
LTE Band7	0.050	0.025	0.043	0.017
LTE Band12	0.057	0.027	0.051	0.022
LTE Band17	0.064	0.031	0.058	0.024
LTE Band66	0.028	0.013	0.022	0.010
WiFi2.4G	0.011	0.006	0.008	0.004
WiFi5.2G	<b>0.048</b>	<b>0.025</b>	<b>0.040</b>	<b>0.019</b>
WiFi5.8G	0.016	0.007	0.011	0.005
MAX. $\Sigma$ SAR1-g (W/kg)	<b>0.146</b>	0.071	0.130	0.059
SAR1-g Limit (W/kg)	1.6	1.6	1.6	1.6
Peak location separation ratio	no	no	no	no
Simut Meas. Required	no	no	no	no

#### Simultaneous transmission SAR for BT and GSM

Test Position	GSM850 Reported SAR1-g (W/kg)	GSM1900 Reported SAR1-g (W/kg)	BT Estimated SAR1-g (W/kg)	MAX. $\Sigma$ SAR1-g (W/kg)	SAR1-g Limit (W/kg)	Peak location separation ratio	Simut Meas. Required
Left Cheek	<b>0.078</b>	0.064	<b>0.084</b>	<b>0.162</b>	1.6	no	no
LeftTilt	<b>0.043</b>	0.027	<b>0.084</b>	0.127	1.6	no	no
Right Cheek	<b>0.069</b>	0.054	<b>0.084</b>	0.153	1.6	no	no
Right Tilt	<b>0.035</b>	0.019	<b>0.084</b>	0.119	1.6	no	no

#### Simultaneous transmission SAR for BT and UMTS

Test Position	UMTS Band V Reported SAR1-g (W/kg)	UMTS Band IV Reported SAR1-g (W/kg)	UMTS Band II Reported SAR1-g (W/kg)	BT Estimated SAR1-g (W/kg)	MAX. $\Sigma$ SAR1-g (W/kg)	SAR1-g Limit (W/kg)	Peak location separation ratio	Simut Meas. Required
Left Cheek	0.083	<b>0.127</b>	0.117	<b>0.084</b>	<b>0.211</b>	1.6	no	no
LeftTilt	0.044	<b>0.077</b>	0.064	<b>0.084</b>	0.161	1.6	no	no
RightChek	0.075	<b>0.117</b>	0.103	<b>0.084</b>	0.201	1.6	no	no
Right Tilt	0.035	<b>0.066</b>	0.053	<b>0.084</b>	0.150	1.6	no	no



**Simultaneous transmission SAR for BT and LTE**

Reported SAR1-g(W/kg)	Test Position			
	Left Cheek	Left Tilt	Right Cheek	Right Tilt
LTE Band2	<b>0.098</b>	<b>0.046</b>	<b>0.090</b>	<b>0.040</b>
LTE Band4	0.060	0.028	0.054	0.024
LTE Band5	0.060	0.029	0.052	0.023
LTE Band7	0.050	0.025	0.043	0.017
LTE Band12	0.057	0.027	0.051	0.022
LTE Band17	0.064	0.031	0.058	0.024
LTE Band66	0.028	0.013	0.022	0.010
BT Estimated SAR1-g (W/kg)	<b>0.084</b>	<b>0.084</b>	<b>0.084</b>	<b>0.084</b>
MAX. $\Sigma$ SAR1-g (W/kg)	<b>0.182</b>	0.130	0.174	0.124
SAR1-g Limit (W/kg)	1.6	1.6	1.6	1.6
Peak location separation ratio	no	no	no	no
Simut Meas. Required	no	no	no	no

**Simultaneous transmission SAR for NFC and GSM**

Test Position	GSM850 Reported SAR1-g (W/kg)	GSM1900 Reported SAR1-g (W/kg)	NFC Reported SAR1-g (W/kg)	MAX. $\Sigma$ SAR1-g (W/kg)	SAR1-g Limit (W/kg)	Peak location separation ratio	Simut Meas. Required
Left Cheek	<b>0.078</b>	0.064	<b>0.0000653</b>	<b>0.0780653</b>	1.6	no	no
Left Tilt	<b>0.043</b>	0.027	<b>0.0000653</b>	0.0430653	1.6	no	no
Right Cheek	<b>0.069</b>	0.054	<b>0.0000653</b>	0.0690653	1.6	no	no
Right Tilt	<b>0.035</b>	0.019	<b>0.0000653</b>	0.0350653	1.6	no	no

**Simultaneous transmission SAR for NFC and UMTS**

Test Position	UMTS Band V Reported SAR1-g (W/kg)	UMTS Band IV Reported SAR1-g (W/kg)	UMTS Band II Reported SAR1-g (W/kg)	NFC Reported SAR1-g (W/kg)	MAX. $\Sigma$ SAR1-g (W/kg)	SAR1-g Limit (W/kg)	Peak location separation ratio	Simut Meas. Required
Left Cheek	0.083	<b>0.127</b>	0.117	<b>0.0000653</b>	<b>0.1270653</b>	1.6	no	no
Left Tilt	0.044	<b>0.077</b>	0.064	<b>0.0000653</b>	0.0770653	1.6	no	no
Right Cheek	0.075	<b>0.117</b>	0.103	<b>0.0000653</b>	0.1170653	1.6	no	no
Right Tilt	0.035	<b>0.066</b>	0.053	<b>0.0000653</b>	0.0660653	1.6	no	no

**Simultaneous transmission SAR for NFC and LTE**

Reported SAR1-g(W/kg)	Test Position			
	Left Cheek	Left Tilt	Right Cheek	Right Tilt
LTE Band2	<b>0.098</b>	<b>0.046</b>	<b>0.090</b>	<b>0.040</b>
LTE Band4	0.060	0.028	0.054	0.024
LTE Band5	0.060	0.029	0.052	0.023
LTE Band7	0.050	0.025	0.043	0.017
LTE Band12	0.057	0.027	0.051	0.022
LTE Band17	0.064	0.031	0.058	0.024
LTE Band66	0.028	0.013	0.022	0.010
NFC	<b>0.0000653</b>	<b>0.0000653</b>	<b>0.0000653</b>	<b>0.0000653</b>
MAX. $\Sigma$ SAR1-g (W/kg)	<b>0.0980653</b>	0.0460653	0.0900653	0.0400653
SAR1-g Limit (W/kg)	1.6	1.6	1.6	1.6
Peak location separation ratio	no	no	no	no
Simut Meas. Required	no	no	no	no

**Simultaneous transmission SAR for WiFi and NFC**

Test Position	NFC Reported SAR1-g (W/kg)	WiFi2.4G Reported SAR1-g (W/kg)	WiFi5.2G Reported SAR1-g (W/kg)	WiFi5.8G Reported SAR1-g (W/kg)	MAX. $\Sigma$ SAR1-g (W/kg)	SAR1-g Limit (W/kg)	Peak location separation ratio	Simut Meas. Required
Left Cheek	<b>0.0000653</b>	0.011	<b>0.048</b>	0.016	<b>0.0480653</b>	1.6	no	no
Left Tilt	<b>0.0000653</b>	0.006	<b>0.025</b>	0.007	0.0250653	1.6	no	no
Right Cheek	<b>0.0000653</b>	0.008	<b>0.040</b>	0.011	0.0400653	1.6	no	no
Right Tilt	<b>0.0000653</b>	0.004	<b>0.019</b>	0.005	0.0190653	1.6	no	no





## Simultaneous transmission SAR for BT and NFC

Test Position	NFC Reported SAR1-g (W/kg)	BT Estimated SAR1-g (W/kg)	MAX. ΣSAR1-g (W/kg)	SAR1-g Limit (W/kg)	Peak location separation ratio	Simut Meas. Required
Left Cheek	<b>0.0000653</b>	<b>0.084</b>	<b>0.0840653</b>	1.6	no	no
LeftTilt	<b>0.0000653</b>	<b>0.084</b>	0.0840653	1.6	no	no
Right Cheek	<b>0.0000653</b>	<b>0.084</b>	0.0840653	1.6	no	no
Right Tilt	<b>0.0000653</b>	<b>0.084</b>	0.0840653	1.6	no	no

## Body Hotspot Exposure Conditions

## Simultaneous transmission SAR for WiFi and GSM

Test Position	GSM850 Reported SAR1-g (W/kg)	GSM1900 Reported SAR1-g (W/kg)	WiFi2.4G Reported SAR1-g (W/kg)	WiFi5.2G Reported SAR1-g (W/kg)	WiFi5.8G Reported SAR1-g (W/kg)	MAX. ΣSAR1-g (W/kg)	SAR1-g Limit (W/kg)	Peak location separation ratio	Simut Meas. Required
Front	<b>0.228</b>	0.184	<b>0.101</b>	0.030	0.008	0.329	1.6	no	no
Rear	<b>0.368</b>	0.259	<b>0.147</b>	0.055	0.014	<b>0.515</b>	1.6	no	no
Left	<b>0.219</b>	0.165	/	/	/	0.219	1.6	no	no
Right	<b>0.199</b>	0.145	<b>0.096</b>	0.022	0.006	0.295	1.6	no	no
Bottom	<b>0.186</b>	0.131	/	/	/	0.186	1.6	no	no
Top	/	/	<b>0.083</b>	0.015	0.003	0.083	1.6	no	no

## Simultaneous transmission SAR for WiFi and UMTS

Test Position	UMTS Band V Reported SAR1-g (W/kg)	UMTS Band IV Reported SAR1-g (W/kg)	UMTS Band II Reported SAR1-g (W/kg)	WiFi2.4G Reported SAR1-g (W/kg)	WiFi5.2G Reported SAR1-g (W/kg)	WiFi5.8G Reported SAR1-g (W/kg)	MAX. ΣSAR1-g (W/kg)	SAR1-g Limit (W/kg)	Peak location separation ratio	Simut Meas. Required
Front	0.209	0.232	<b>0.363</b>	<b>0.101</b>	0.030	0.008	0.464	1.6	no	no
Rear	0.313	0.310	<b>0.424</b>	<b>0.147</b>	0.055	0.014	<b>0.571</b>	1.6	no	no
Left	0.200	0.221	<b>0.342</b>	/	/	/	0.342	1.6	no	no
Right	0.183	0.213	<b>0.325</b>	<b>0.096</b>	0.022	0.006	0.421	1.6	no	no
Bottom	0.170	0.205	<b>0.316</b>	/	/	/	0.316	1.6	no	no
Top	/	/	/	<b>0.083</b>	0.015	0.003	0.083	1.6	no	no

## SAR for WiFi and LTE

Reported SAR1-g(W/kg)	Test Position					
	Front	Rear	Left	Right	Bottom	Top
LTE Band2	0.275	0.383	0.257	0.244	0.233	/
LTE Band4	0.142	0.219	0.133	0.124	0.105	/
LTE Band5	0.177	0.260	0.169	0.154	0.135	/
LTE Band7	<b>0.594</b>	0.719	<b>0.589</b>	<b>0.575</b>	<b>0.559</b>	/
LTE Band12	0.109	0.171	0.097	0.091	0.080	/
LTE Band17	0.130	0.202	0.120	0.109	0.094	/
LTE Band66	0.379	<b>0.776</b>	0.356	0.340	0.325	/
WiFi2.4G	<b>0.101</b>	<b>0.147</b>	/	<b>0.096</b>	/	<b>0.083</b>
WiFi5.2G	0.030	0.055	/	0.022	/	0.015
WiFi5.8G	0.008	0.014	/	0.006	/	0.003
MAX. ΣSAR1-g (W/kg)	0.695	<b>0.923</b>	0.589	0.671	0.559	0.083
SAR1-g Limit (W/kg)	1.6	1.6	1.6	1.6	1.6	1.6
Peak location separation ra/tio	no	no	no	no	no	no
Simut Meas. Required	no	no	no	no	no	no

## Simultaneous transmission SAR for BT and GSM

Test Position	GSM850 Reported SAR1-g (W/kg)	GSM1900 Reported SAR1-g (W/kg)	BT Estimated SAR1-g (W/kg)	MAX. ΣSAR1-g (W/kg)	SAR1-g Limit (W/kg)	Peak location separation ratio	Simut Meas. Required
Front	<b>0.228</b>	0.184	<b>0.042</b>	0.270	1.6	no	no
Rear	<b>0.368</b>	0.259	<b>0.042</b>	<b>0.410</b>	1.6	no	no
Left	<b>0.219</b>	0.165	/	0.219	1.6	no	no
Right	<b>0.199</b>	0.145	<b>0.042</b>	0.241	1.6	no	no
Bottom	<b>0.186</b>	0.131	/	0.186	1.6	no	no
Top	/	/	<b>0.042</b>	0.042	1.6	no	no



Shenzhen LCS Compliance Testing Laboratory Ltd.

Add: 101, 201 Bldg A &amp; 301 Bldg C, Juji Industrial Park Yabianxueziwei, Shajing Street, Baoan District, Shenzhen, 518000, China

Tel: +(86) 0755-82591330 | E-mail: webmaster@lcs-cert.com | Web: www.lcs-cert.com

Scan code to check authenticity



## Simultaneous transmission SAR for BT and UMTS

Test Position	UMTS Band V Reported SAR1-g (W/kg)	UMTS Band IV Reported SAR1-g (W/kg)	UMTS Band II Reported SAR1-g (W/kg)	BT Estimated SAR1-g (W/kg)	MAX. ΣSAR1-g (W/kg)	SAR1-g Limit (W/kg)	Peak location separation ratio	Simut Meas. Required
Front	0.209	0.232	<b>0.363</b>	<b>0.042</b>	0.405	1.6	no	no
Rear	0.313	0.310	<b>0.424</b>	<b>0.042</b>	<b>0.466</b>	1.6	no	no
Left	0.200	0.221	<b>0.342</b>	/	0.342	1.6	no	no
Right	0.183	0.213	<b>0.325</b>	<b>0.042</b>	0.367	1.6	no	no
Bottom	0.170	0.205	<b>0.316</b>	/	0.316	1.6	no	no
Top	/	/	/	<b>0.042</b>	0.042	1.6	no	no

## Simultaneous transmission SAR for BT and LTE

Reported SAR1-g(W/kg)	Test Position						
	Front	Rear	Left	Right	Bottom	Top	
LTE Band2	0.275	0.383	0.257	0.244	0.233	/	
LTE Band4	0.142	0.219	0.133	0.124	0.105	/	
LTE Band5	0.177	0.260	0.169	0.154	0.135	/	
LTE Band7	<b>0.594</b>	0.719	<b>0.589</b>	<b>0.575</b>	<b>0.559</b>	/	
LTE Band12	0.109	0.171	0.097	0.091	0.080	/	
LTE Band17	0.130	0.202	0.120	0.109	0.094	/	
LTE Band66	0.379	<b>0.776</b>	0.356	0.340	0.325	/	
BT Estimated SAR1-g (W/kg)	<b>0.042</b>	<b>0.042</b>	/	<b>0.042</b>	/	<b>0.042</b>	
MAX. ΣSAR1-g (W/kg)	0.636	<b>0.818</b>	0.589	0.617	0.559	0.042	
SAR1-g Limit (W/kg)	1.6	1.6	1.6	1.6	1.6	1.6	
Peak location separation ratio	no	no	no	no	no	no	
Simut Meas. Required	no	no	no	no	no	no	

## Simultaneous transmission SAR for NFC and GSM

Test Position	GSM850 Reported SAR1-g (W/kg)	GSM1900 Reported SAR1-g (W/kg)	NFC Reported SAR1-g (W/kg)	MAX. ΣSAR1-g (W/kg)	SAR1-g Limit (W/kg)	Peak location separation ratio	Simut Meas. Required
Front	<b>0.228</b>	0.184	<b>0.0000327</b>	0.2280327	1.6	no	no
Rear	<b>0.368</b>	0.259	<b>0.0000327</b>	<b>0.3680327</b>	1.6	no	no
Left	<b>0.219</b>	0.165	<b>0.0000327</b>	0.2190327	1.6	no	no
Right	<b>0.199</b>	0.145	<b>0.0000327</b>	0.1990327	1.6	no	no
Bottom	<b>0.186</b>	0.131	/	0.1860000	1.6	no	no
Top	/	/	<b>0.0000327</b>	0.0000327	1.6	no	no

## Simultaneous transmission SAR for NFC and UMTS

Test Position	UMTS Band V Reported SAR1-g (W/kg)	UMTS Band IV Reported SAR1-g (W/kg)	UMTS Band II Reported SAR1-g (W/kg)	NFC Reported SAR1-g (W/kg)	MAX. ΣSAR1-g (W/kg)	SAR1-g Limit (W/kg)	Peak location separation ratio	Simut Meas. Required
Front	0.209	0.232	<b>0.363</b>	<b>0.0000327</b>	0.3630327	1.6	no	no
Rear	0.313	0.310	<b>0.424</b>	<b>0.0000327</b>	<b>0.4240327</b>	1.6	no	no
Left	0.200	0.221	<b>0.342</b>	<b>0.0000327</b>	0.3420327	1.6	no	no
Right	0.183	0.213	<b>0.325</b>	<b>0.0000327</b>	0.3250327	1.6	no	no
Bottom	0.170	0.205	<b>0.316</b>	/	0.3160000	1.6	no	no
Top	/	/	/	<b>0.0000327</b>	0.0000327	1.6	no	no



**SAR for NFC and LTE**

Reported SAR1-g(W/kg)	Test Position					
	Front	Rear	Left	Right	Bottom	Top
LTE Band2	0.275	0.383	0.257	0.244	0.233	/
LTE Band4	0.142	0.219	0.133	0.124	0.105	/
LTE Band5	0.177	0.260	0.169	0.154	0.135	/
LTE Band7	<b>0.594</b>	0.719	<b>0.589</b>	<b>0.575</b>	<b>0.559</b>	/
LTE Band12	0.109	0.171	0.097	0.091	0.080	/
LTE Band17	0.130	0.202	0.120	0.109	0.094	/
LTE Band66	0.379	<b>0.776</b>	0.356	0.340	0.325	/
NFC	<b>0.0000327</b>	<b>0.0000327</b>	<b>0.0000327</b>	<b>0.0000327</b>	/	<b>0.0000327</b>
MAX. $\Sigma$ SAR1-g (W/kg)	0.5940327	<b>0.7760327</b>	0.5890327	0.5750327	0.5590000	0.0000327
SAR1-g Limit (W/kg)	1.6	1.6	1.6	1.6	1.6	1.6
Peak location separation ra/tio	no	no	no	no	no	no
Simut Meas. Required	no	no	no	no	no	no

**Simultaneous transmission SAR for WiFi and NFC**

Test Position	NFC Reported SAR1-g (W/kg)	WiFi2.4G Reported SAR1-g (W/kg)	WiFi5.2G Reported SAR1-g (W/kg)	WiFi5.8G Reported SAR1-g (W/kg)	MAX. $\Sigma$ SAR1-g (W/kg)	SAR1-g Limit (W/kg)	Peak location separation ratio	Simut Meas. Required
Front	<b>0.0000327</b>	<b>0.101</b>	0.030	0.008	0.1010327	1.6	no	no
Rear	<b>0.0000327</b>	<b>0.147</b>	0.055	0.014	<b>0.1470327</b>	1.6	no	no
Left	<b>0.0000327</b>	/	/	/	0.0000327	1.6	no	no
Right	<b>0.0000327</b>	<b>0.096</b>	0.022	0.006	0.0960327	1.6	no	no
Bottom	/	/	/	/	/	1.6	no	no
Top	<b>0.0000327</b>	<b>0.083</b>	0.015	0.003	0.0830327	1.6	no	no

**Simultaneous transmission SAR for BT and NFC**

Test Position	NFC Reported SAR1-g (W/kg)	BT Estimated SAR1-g (W/kg)	MAX. $\Sigma$ SAR1-g (W/kg)	SAR1-g Limit (W/kg)	Peak location separation ratio	Simut Meas. Required
Front	<b>0.0000327</b>	<b>0.042</b>	0.0420327	1.6	no	no
Rear	<b>0.0000327</b>	<b>0.042</b>	<b>0.0420327</b>	1.6	no	no
Left	<b>0.0000327</b>	/	0.0000327	1.6	no	no
Right	<b>0.0000327</b>	<b>0.042</b>	0.0420327	1.6	no	no
Bottom	/	/	/	1.6	no	no
Top	<b>0.0000327</b>	<b>0.042</b>	0.0420327	1.6	no	no

**Note:**

1. The WiFi and BT share same antenna, so cannot transmit at same time.
2. The value with black color is the maximum values of standalone
3. The value with blue color is the maximum values of  $\Sigma$ SAR<sub>1-g</sub>





#### 4.5. SAR Measurement Variability

According to KDB865664, Repeated measurements are required only when the measured SAR is  $\geq 0.80$  W/kg. If the measured SAR value of the initial repeated measurement is  $< 1.45$  W/kg with  $\leq 20\%$  variation, only one repeated measurement is required to reaffirm that the results are not expected to have substantial variations, which may introduce significant compliance concerns. A second repeated measurement is required only if the measured result for the initial repeated measurement is within 10% of the SAR limit and vary by more than 20%, which are often related to device and measurement setup difficulties. The following procedures are applied to determine if repeated measurements are required. The same procedures should be adapted for measurements according to extremity and occupational exposure limits by applying a factor of 2.5 for extremity exposure and a factor of 5 for occupational exposure to the corresponding SAR thresholds.<sup>19</sup> The repeated measurement results must be clearly identified in the SAR report. All measured SAR, including the repeated results, must be considered to determine compliance and for reporting according to KDB 690783. Repeated measurement is not required when the original highest measured SAR is  $< 0.80$  W/kg; steps 2) through 4) do not apply.

- 3) When the original highest measured SAR is  $\geq 0.80$  W/kg, repeat that measurement once.
- 4) Perform a second repeated measurement only if the ratio of largest to smallest SAR for the original and first repeated measurements is  $> 1.20$  or when the original or repeated measurement is  $\geq 1.45$  W/kg ( $\sim 10\%$  from the 1-g SAR limit).
- 5) Perform a third repeated measurement only if the original, first or second repeated measurement is  $\geq 1.5$  W/kg and the ratio of largest to smallest SAR for the original, first and second repeated measurements is  $> 1.20$ .
- 6) Perform a third repeated measurement only if the original, first or second repeated measurement is  $\geq 1.5$  W/kg and the ratio of largest to smallest SAR for the original, first and second repeated measurements is  $> 1.20$ .

Frequency Band (MHz)	Air Interface	RF Exposure Configuration	Test Position	Repeated SAR (yes/no)	Highest Measured SAR <sub>1-g</sub> (W/Kg)	First Repeated	
						Measured SAR <sub>1-g</sub> (W/Kg)	Largest to Smallest SAR Ratio
750	LTE Band 12	Standalone	Body-Rear	no	0.165	n/a	n/a
	LTE Band 17	Standalone	Body-Rear	no	0.192	n/a	n/a
850	GSM 850	Standalone	Body-Rear	no	0.329	n/a	n/a
	WCDMA Band V	Standalone	Body-Rear	no	0.312	n/a	n/a
	LTE Band 5	Standalone	Body-Rear	no	0.234	n/a	n/a
1800	WCDMA Band IV	Standalone	Body-Rear	no	0.299	n/a	n/a
	LTE Band 4	Standalone	Body-Rear	no	0.218	n/a	n/a
	LTE Band 66	Standalone	Body-Rear	no	0.693	n/a	n/a
1900	GSM 1900	Standalone	Body-Rear	no	0.232	n/a	n/a
	WCDMA Band II	Standalone	Body-Rear	no	0.418	n/a	n/a
	LTE Band 2	Standalone	Body-Rear	no	0.352	n/a	n/a
2450	2.4GWLAN	Standalone	Body-Rear	no	0.147	n/a	n/a
2600	LTE Band 7	Standalone	Body-Rear	no	0.704	n/a	n/a
5200	5.2GWLAN	Standalone	Body-Rear	no	0.053	n/a	n/a
5800	5.8GWLAN	Standalone	Cheek- Left	no	0.016	n/a	n/a

#### Remark:

1. Second Repeated Measurement is not required since the ratio of the largest to smallest SAR for the original and first repeated measurement is not  $> 1.20$  or 3 (1-g or 10-g respectively)







#### 4.6. General description of test procedures

1. Test positions as described in the tables above are in accordance with the specified test standard.
2. Tests in body position were performed in that configuration, which generates the highest time based averaged output power (see conducted power results).
3. According to IEEE 1528 the SAR test shall be performed at middle channel. Testing of top and bottom channel is optional.
4. According to KDB 447498 D01 testing of other required channels within the operating mode of a frequency band is not required when the reported 1-g or 10-g SAR for the mid-band or highest output power channel is:
  - $\leq 0.8$  W/kg or 2.0 W/kg, for 1-g or 10-g respectively, when the transmission band is  $\leq 100$  MHz
  - $\leq 0.6$  W/kg or 1.5 W/kg, for 1-g or 10-g respectively, when the transmission band is between 100 MHz and 200 MHz
  - $\leq 0.4$  W/kg or 1.0 W/kg, for 1-g or 10-g respectively, when the transmission band is  $\geq 200$  MHz
5. IEEE 1528-2003 require the middle channel to be tested first. This generally applies to wireless devices that are designed to operate in technologies with tight tolerances for maximum output power variations across channels in the band. When the maximum output power variation across the required test channels is  $> \frac{1}{2}$  dB, instead of the middle channel, the highest output power channel must be used.
6. When the same maximum output power is specified for both bands, begin SAR measurement in U-NII-2A band by applying the OFDM SAR requirements.19 If the highest reported SAR for a test configuration is  $\leq 1.2$  W/kg, SAR is not required for U-NII-1 band for that configuration (802.11 mode and exposure condition); otherwise, each band is tested independently for SAR.
7. When different maximum output power is specified for the bands, begin SAR measurement in the band with higher specified maximum output power. The highest reported SAR for the tested configuration is adjusted by the ratio of lower to higher specified maximum output power for the two bands. When the adjusted SAR is  $\leq 1.2$  W/kg, SAR is not required for the band with lower maximum output power in that test configuration; otherwise, each band is tested independently for SAR.

#### 4.7. Measurement Uncertainty (450MHz-6GHz)

Not required as SAR measurement uncertainty analysis is required in SAR reports only when the highest measured SAR in a frequency band is  $\geq 1.5$  W/kg for 1-g SAR according to KDB865664D01.





### 4.8. System Check Results

Test mode:750MHz(Head)  
 Product Description:Validation  
 Model:Dipole SID750  
 E-Field Probe: SSE2(SN 25/22 EPGO376)  
 Test Date: May 15, 2023

Medium(liquid type)	HSL_750
Frequency (MHz)	750.0000
Relative permittivity (real part)	43.23
Conductivity (S/m)	0.86
Input power	100mW
Crest Factor	1.0
Conversion Factor	1.69
Variation (%)	-0.320000
SAR 10g (W/Kg)	0.573452
SAR 1g (W/Kg)	0.820413

#### SURFACE SAR

#### VOLUME SAR

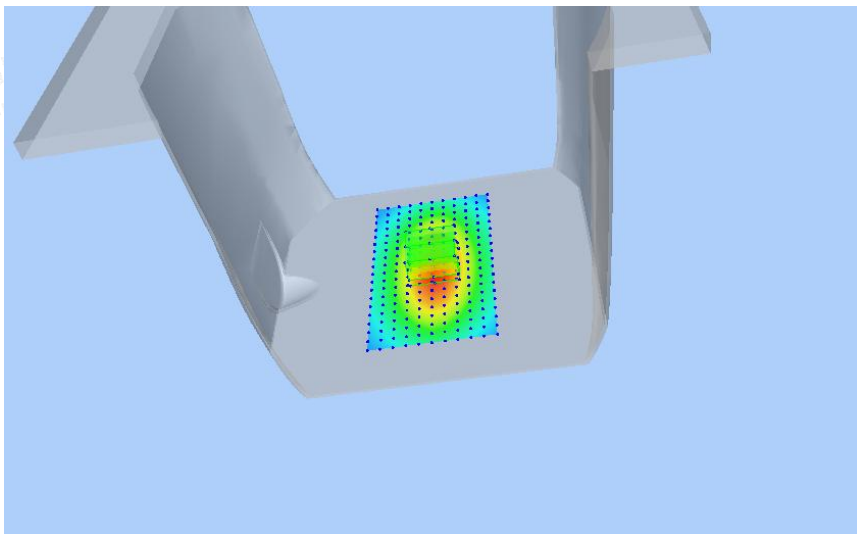
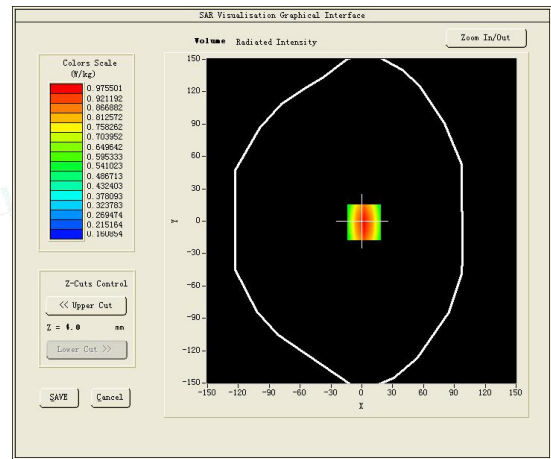
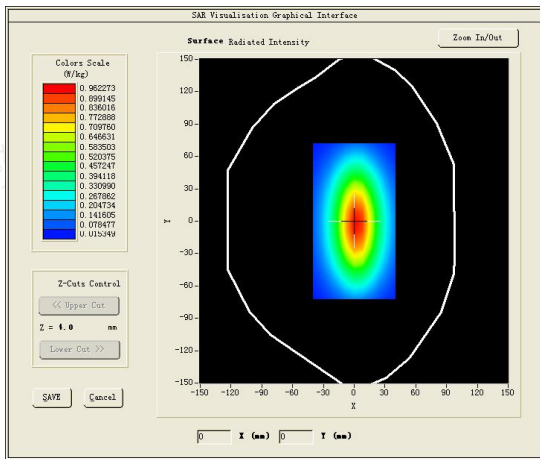



Test mode:835MHz(Head)  
 Product Description:Validation  
 Model:Dipole SID835  
 E-Field Probe:SSE2(SN 25/22 EPG0376)  
 Test Date: May 17, 2023

Medium(liquid type)	HSL 850
Frequency (MHz)	835.0000
Relative permittivity (real part)	42.60
Conductivity (S/m)	0.88
Input power	100mW
Crest Factor	1.0
Conversion Factor	1.75
Variation (%)	-0.630000
SAR 10g (W/Kg)	0.643132
SAR 1g (W/Kg)	0.981488
<b>SURFACE SAR</b>	<b>VOLUME SAR</b>

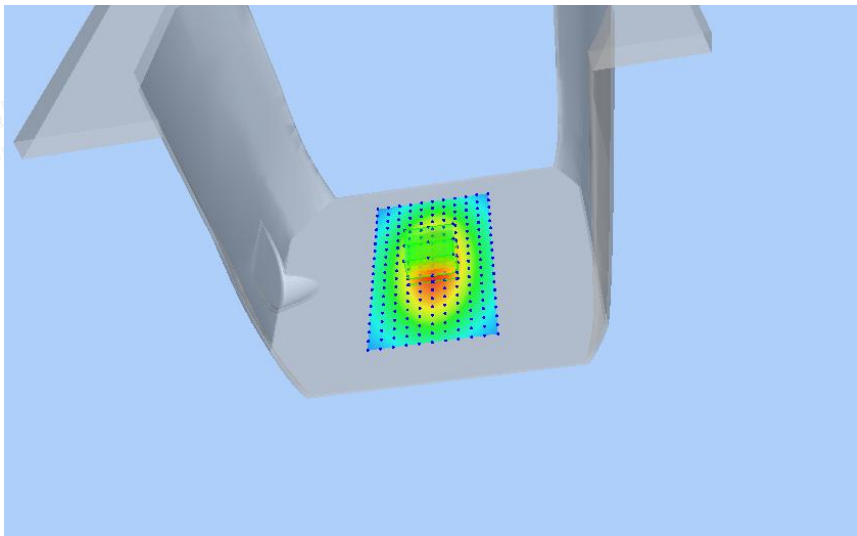
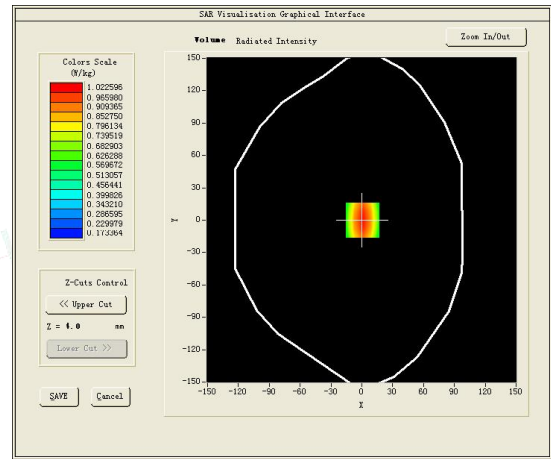
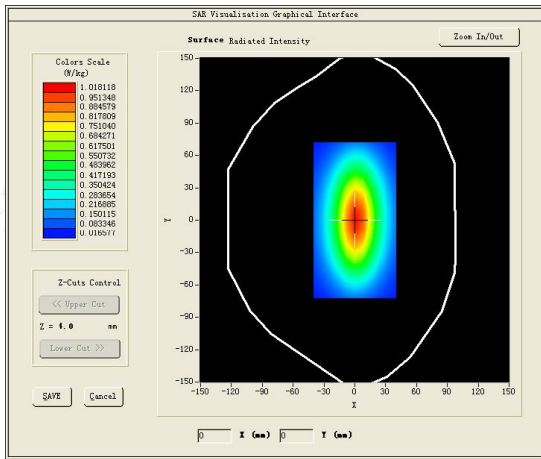



Test mode:1800MHz(Head)  
 Product Description:Validation  
 Model :Dipole SID1800  
 E-Field Probe:SSE2(SN 25/22 EPG0376)  
 Test Date: May 22, 2023

Medium(liquid type)	HSL_1800
Frequency (MHz)	1800.0000
Relative permittivity (real part)	41.43
Conductivity (S/m)	1.38
Input power	100mW
Crest Factor	1.0
Conversion Factor	2.09
Variation (%)	3.580000
SAR 10g (W/Kg)	2.001283
SAR 1g (W/Kg)	3.832085

**SURFACE SAR**

**VOLUME SAR**

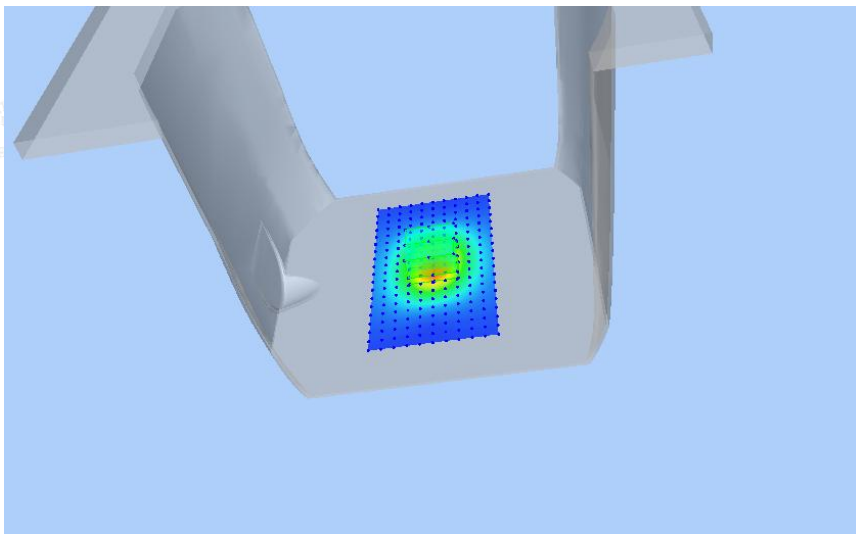
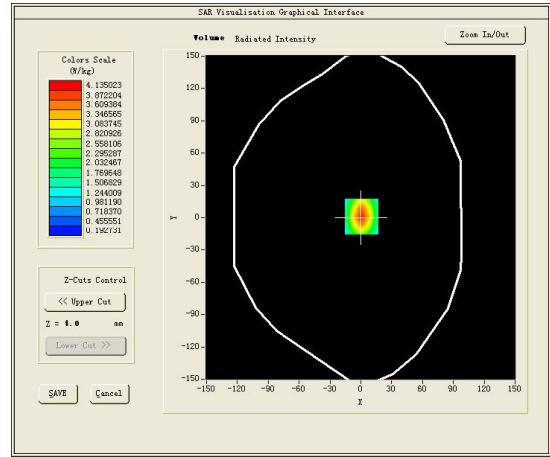
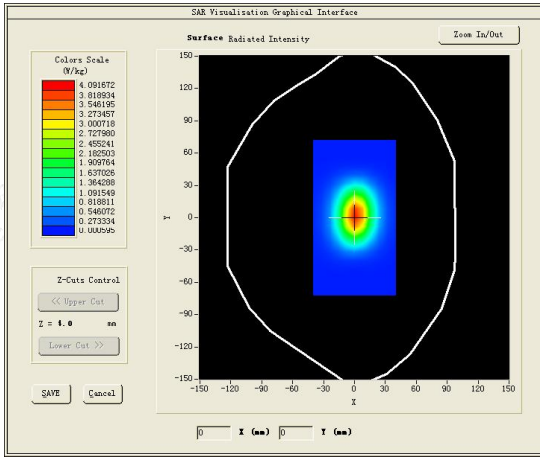



Test mode:1900MHz(Head)  
 Product Description:Validation  
 Model :Dipole SID1900  
 E-Field Probe:SSE2(SN 25/22 EPGO376)  
 Test Date: May 24, 2023

Medium(liquid type)	HSL_1900
Frequency (MHz)	1900.0000
Relative permittivity (real part)	41.03
Conductivity (S/m)	1.36
Input power	100mW
Crest Factor	1.0
Conversion Factor	2.14
Variation (%)	-1.110000
SAR 10g (W/Kg)	2.079260
SAR 1g (W/Kg)	3.954162
<b>SURFACE SAR</b>	<b>VOLUME SAR</b>

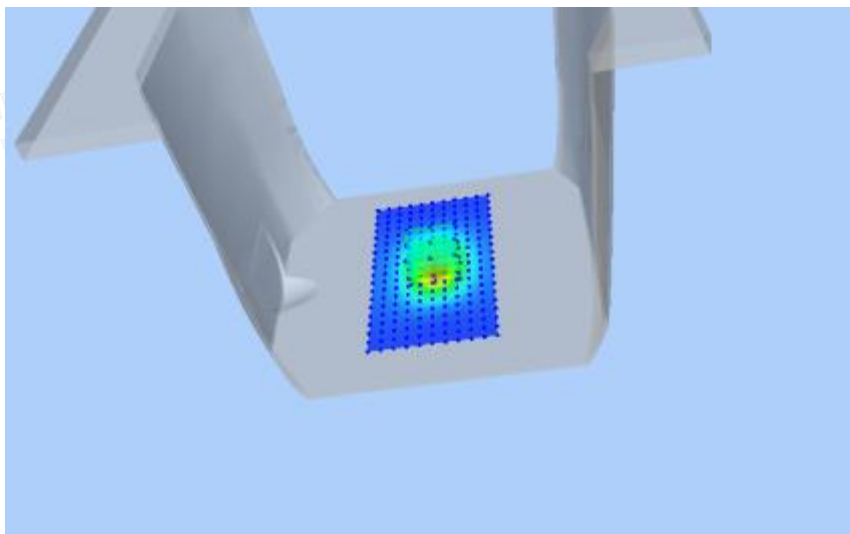
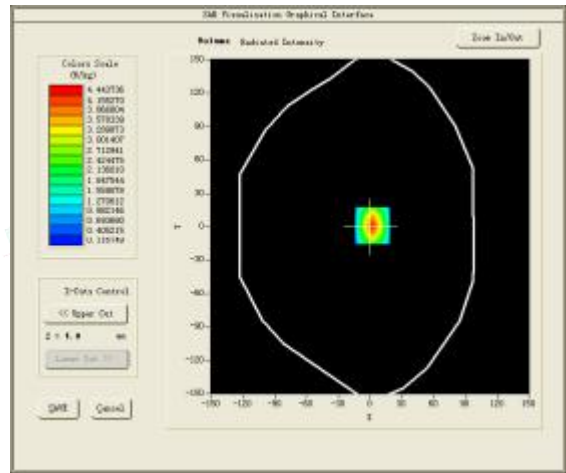
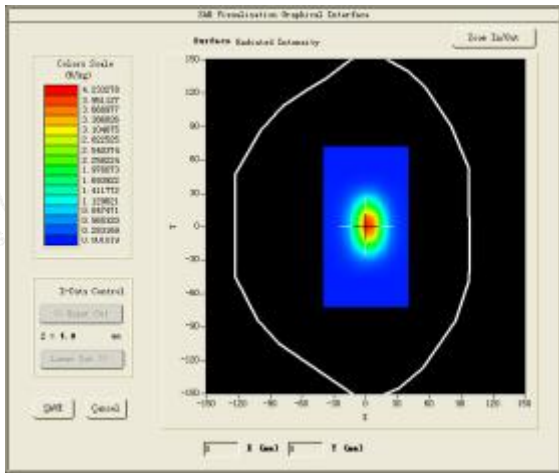



Test mode:2450MHz(Head)  
 Product Description:Validation  
 Model:Dipole SID2450  
 E-Field Probe:SSE2(SN 25/22 EPGO376)  
 Test Date: May 26, 2023

Medium(liquid type)	HSL_2450
Frequency (MHz)	2450.0000
Relative permittivity (real part)	40.30
Conductivity (S/m)	1.77
Input power	100mW
Crest Factor	1.0
Conversion Factor	2.60
Variation (%)	0.960000
SAR 10g (W/Kg)	2.357463
SAR 1g (W/Kg)	5.206016
<b>SURFACE SAR</b>	<b>VOLUME SAR</b>

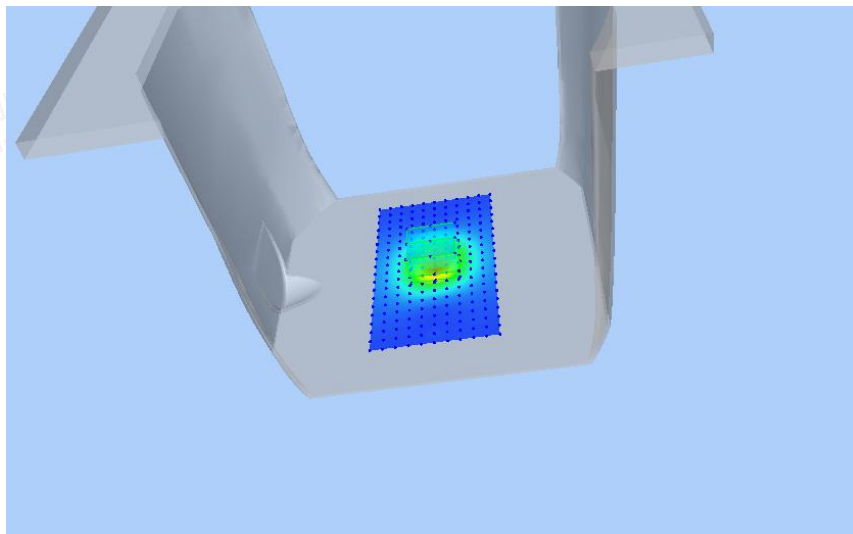
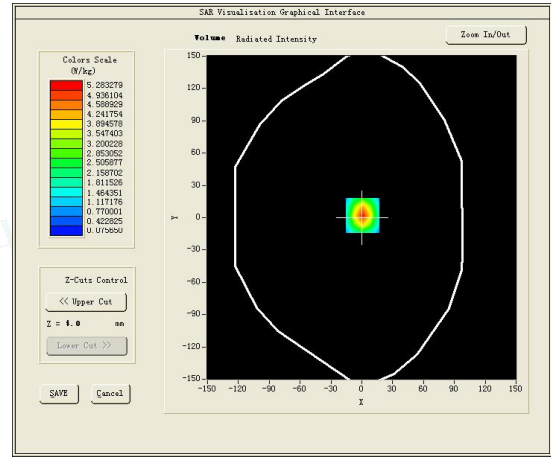
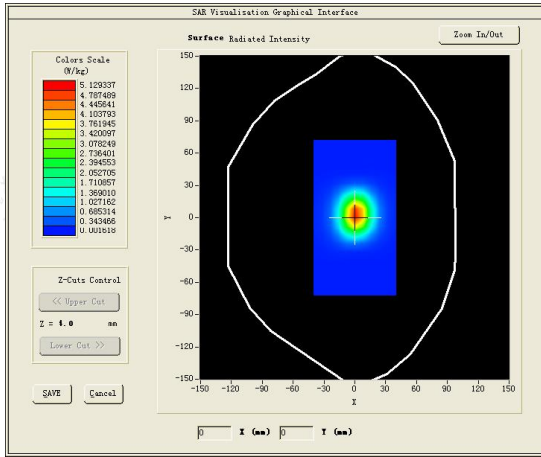



Test mode:2600MHz  
 Product Description:Validation  
 Model:Dipole SID2600  
 E-Field Probe: SSE2(SN 25/22 EPG0376)  
 Test Date: May 31, 2023

Medium(liquid type)	HSL_2600
Frequency (MHz)	2600.0000
Relative permittivity (real part)	40.12
Conductivity (S/m)	1.94
Input power	100mW
Crest Factor	1.0
Conversion Factor	2.39
Variation (%)	-2.050000
SAR 10g (W/Kg)	2.444235
SAR 1g (W/Kg)	5.547023
<b>SURFACE SAR</b>	<b>VOLUME SAR</b>

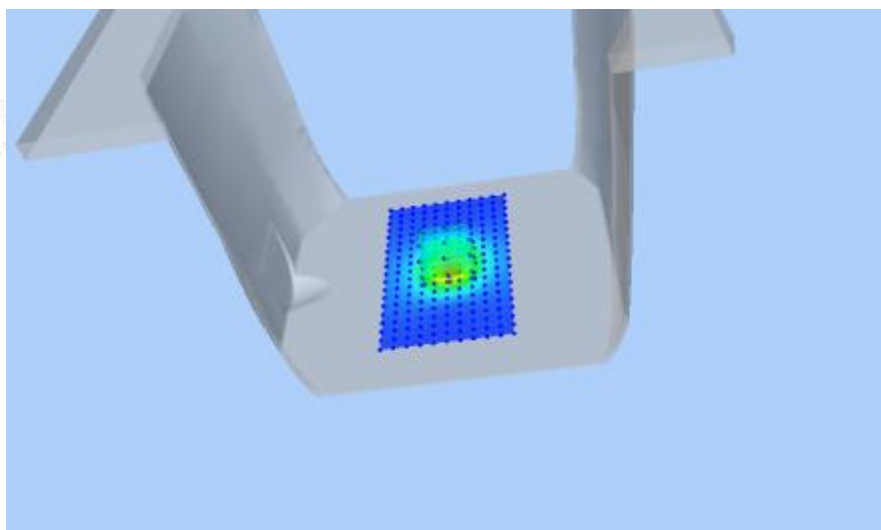
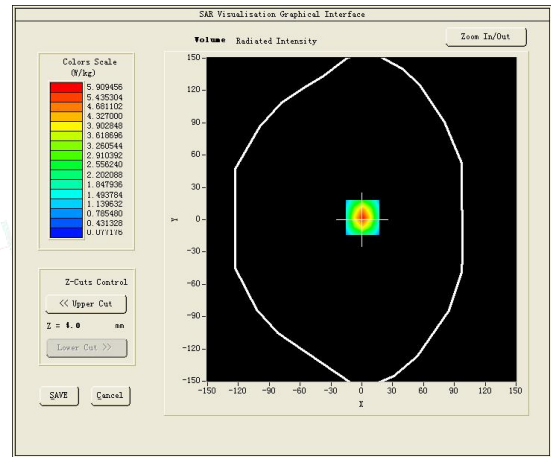
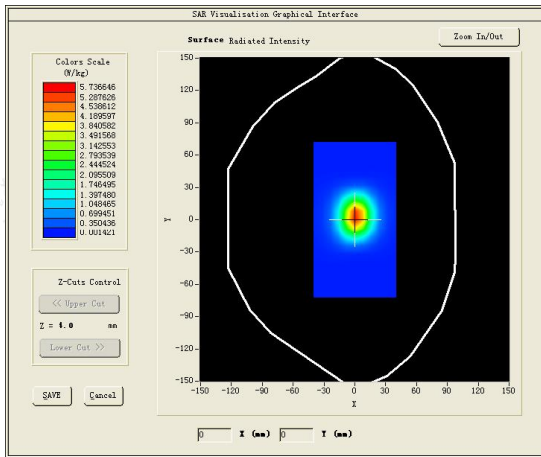



Test mode:5200MHz(Head)  
 Product Description:Validation  
 Model:Dipole SID5000  
 E-Field Probe: SSE2(SN 25/22 EPGO376)  
 Test Date: June 02, 2023

Medium(liquid type)	HSL_5000
Frequency (MHz)	5200.0000
Relative permittivity (real part)	35.65
Conductivity (S/m)	4.69
Input power	100mW
Crest Factor	1.0
Conversion Factor	1.85
Variation (%)	-0.240000
SAR 10g (W/Kg)	5.820210
SAR 1g (W/Kg)	15.465034
<b>SURFACE SAR</b>	<b>VOLUME SAR</b>

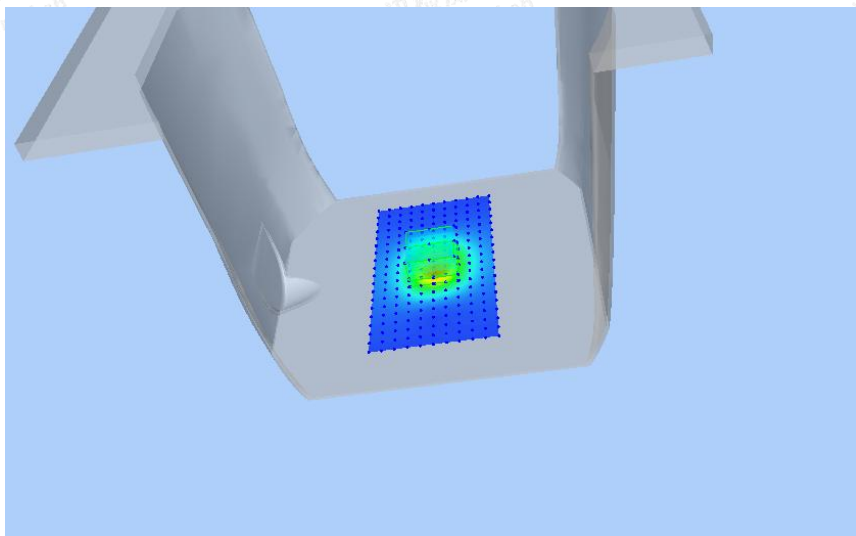
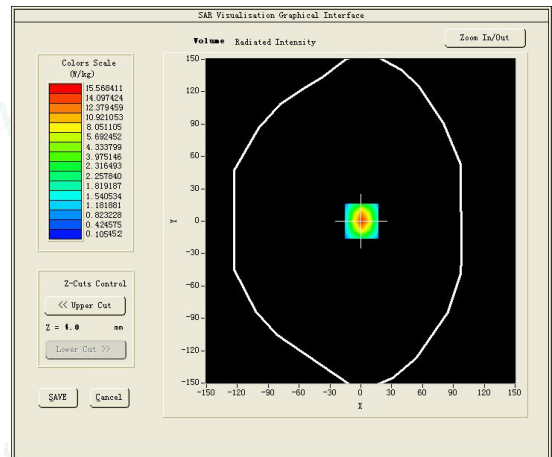
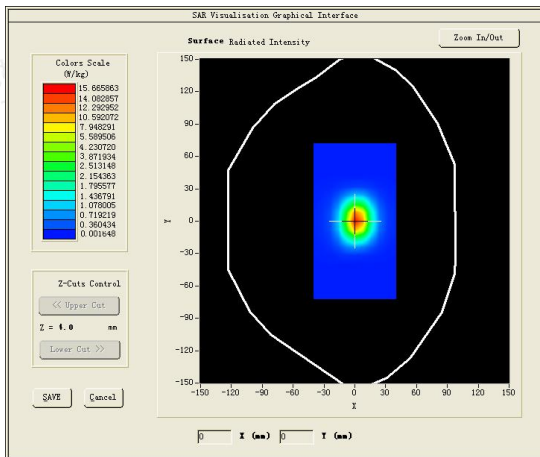





Test mode:5800MHz(Head)  
 Product Description:Validation  
 Model:Dipole SID5000  
 E-Field Probe: SSE2(SN 25/22 EPGO376)  
 Test Date: June 05, 2023

Medium(liquid type)	HSL_5000
Frequency (MHz)	5800.0000
Relative permittivity (real part)	36.47
Conductivity (S/m)	5.25
Input power	100mW
Crest Factor	1.0
Conversion Factor	2.01
Variation (%)	3.120000
SAR 10g (W/Kg)	5.798085
SAR 1g (W/Kg)	17.588250
<b>SURFACE SAR</b>	<b>VOLUME SAR</b>

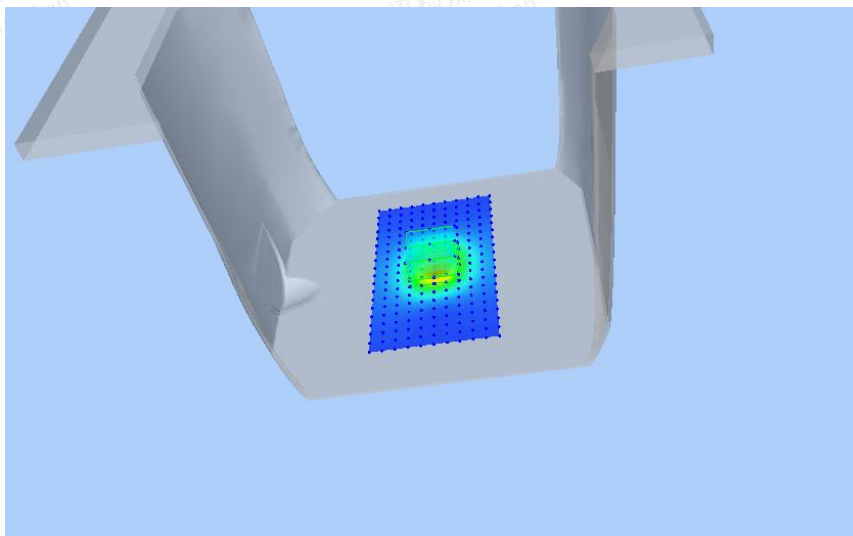
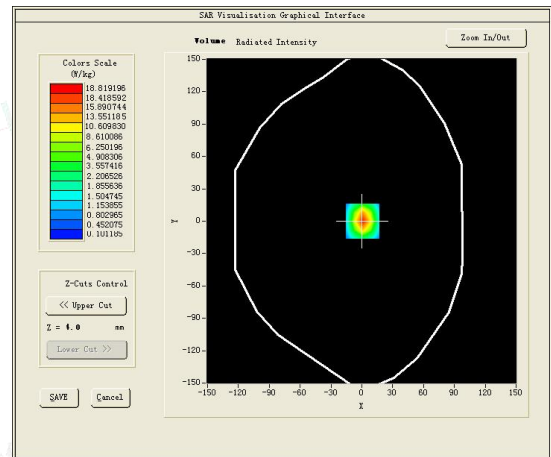
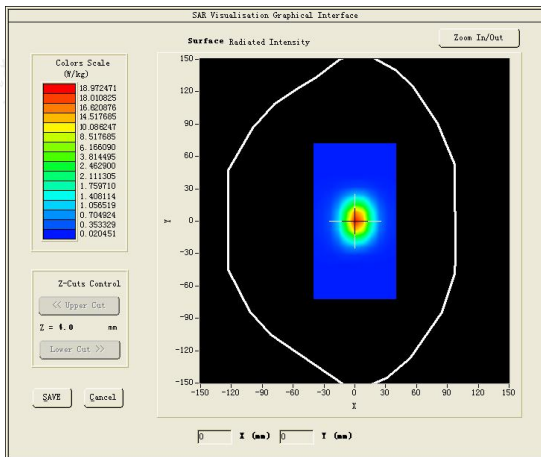

### 4.9. SAR Test Graph Results

SAR plots for the highest measured SAR in each exposure configuration, wireless mode and frequency band combination

#1 Test Mode: GSM850MHz, Middle channel (Head Left Cheek)

Product Description: Smartphone

Model: NOTE 50

Test Date: May 17, 2023

Medium (liquid type)	HSL 835
Frequency (MHz)	836.6000
Relative permittivity (real part)	43.21
Conductivity (S/m)	0.85
E-Field Probe	SN 25/22 EPG0376
Crest Factor	2.0
Conversion Factor	1.75
Sensor	4mm
Area Scan	dx=8mm dy=8mm
Zoom Scan	5x5x7, dx=8mm dy=8mm dz=5mm
Variation (%)	-1.780000
SAR 10g (W/Kg)	0.053873
SAR 1g (W/Kg)	0.073296
<b>SURFACE SAR</b>	<b>VOLUME SAR</b>

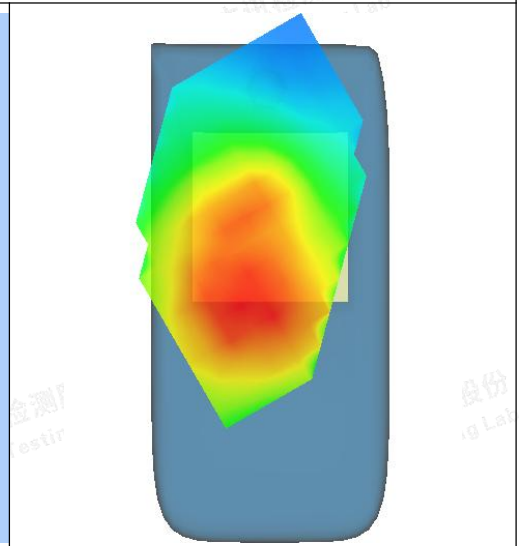
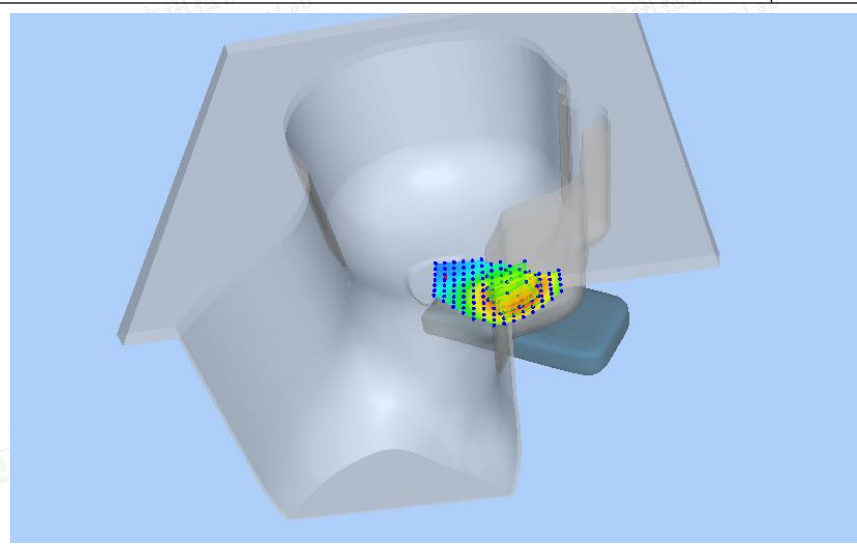
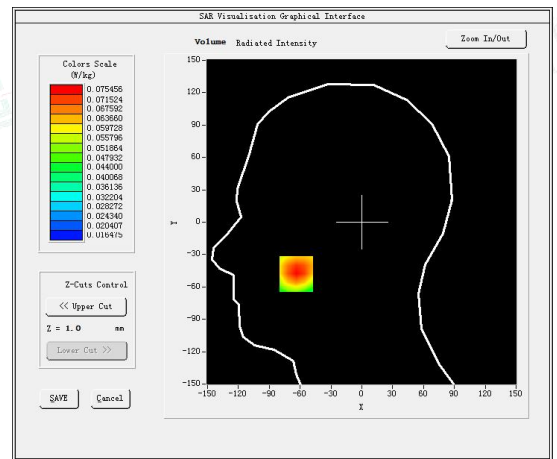
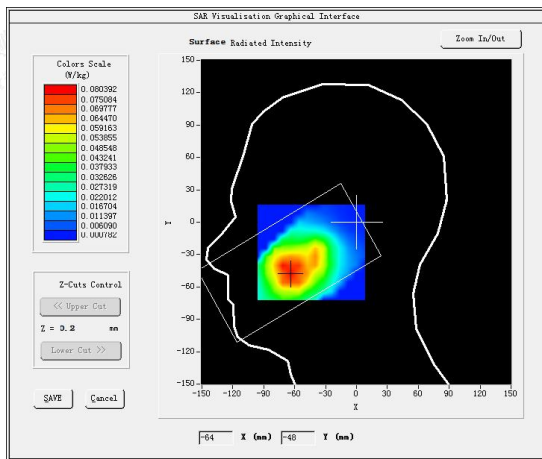



#2

Test Mode: GSM850MHz, Middle channel(Body Rear Side)

Product Description:Smartphone

Model:NOTE 50

Test Date: May 17, 2023

Medium(liquid type)	HSL_835
Frequency (MHz)	836.6000
Relative permittivity (real part)	43.21
Conductivity (S/m)	0.85
E-Field Probe	SN 25/22 EPG0376
Crest Factor	2.0
Conversion Factor	1.75
Sensor	4mm
Area Scan	dx=8mm dy=8mm
Zoom Scan	5x5x7,dx=8mm dy=8mm dz=5mm
Variation (%)	0.450000
SAR 10g (W/Kg)	0.232897
SAR 1g (W/Kg)	0.328532

**SURFACE SAR**

**VOLUME SAR**

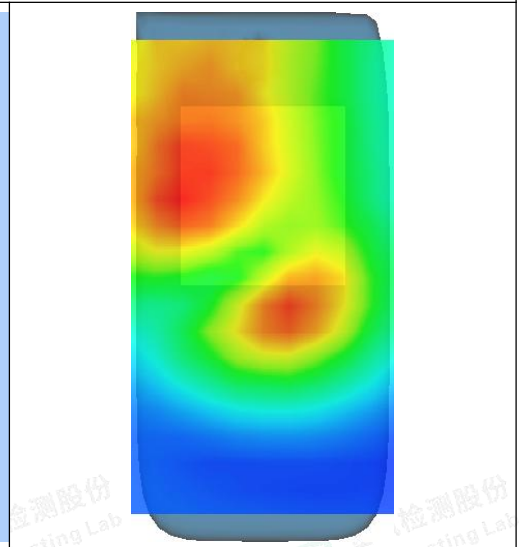
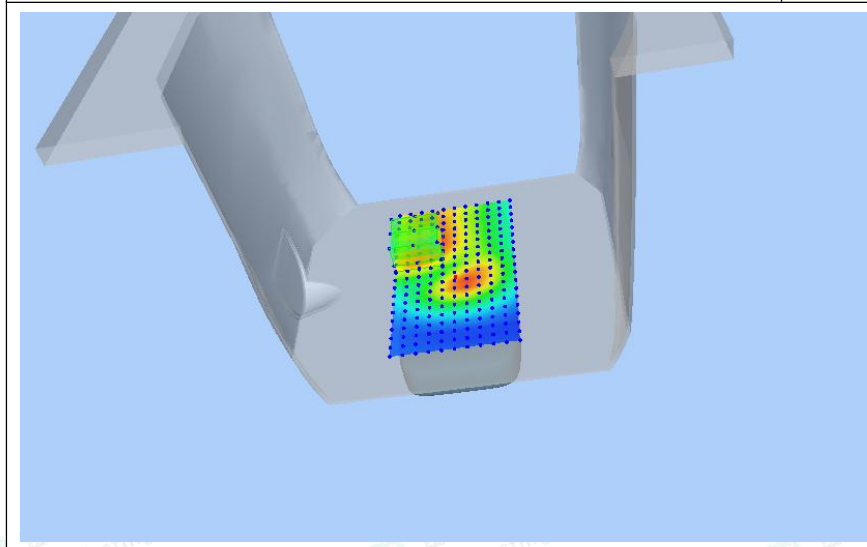
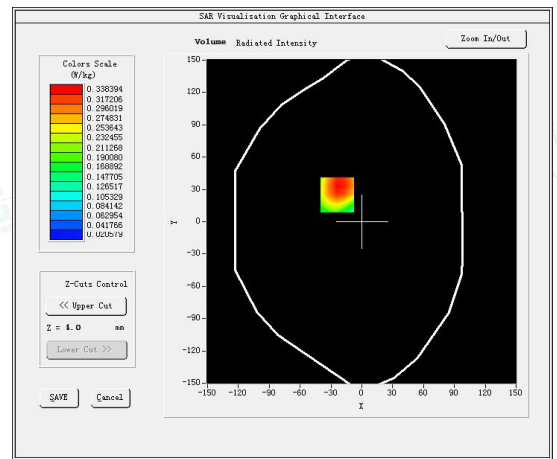
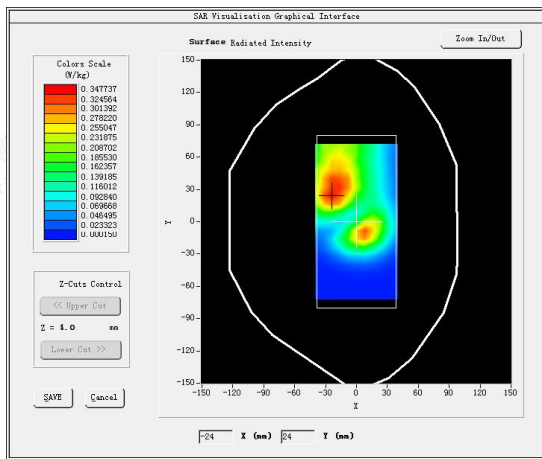



#3

Test Mode: GPRS1900MHz, Middle channel(Head Left Cheek)

Product Description:Smartphone

Model:NOTE 50

Test Date: May 24, 2023

Medium(liquid type)	HSL 1900
Frequency (MHz)	1880.0000
Relative permittivity (real part)	42.21
Conductivity (S/m)	1.34
E-Field Probe	SN 25/22 EPGO376
Crest Factor	2.0
Conversion Factor	2.14
Sensor	4mm
Area Scan	dx=8mm dy=8mm
Zoom Scan	5x5x7,dx=8mm dy=8mm dz=5mm
Variation (%)	-0.860000
SAR 10g (W/Kg)	0.034895
SAR 1g (W/Kg)	0.058607

**SURFACE SAR**

**VOLUME SAR**

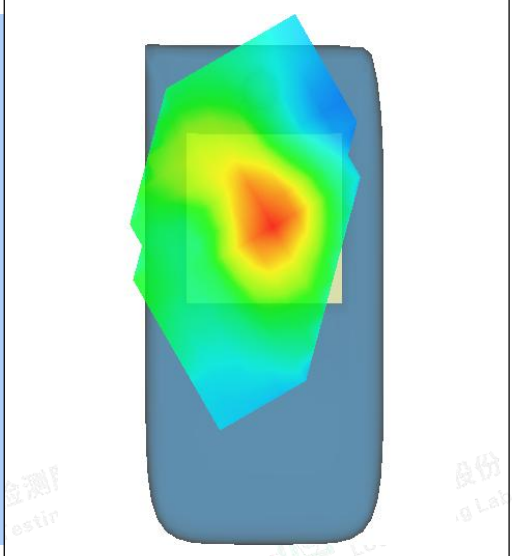
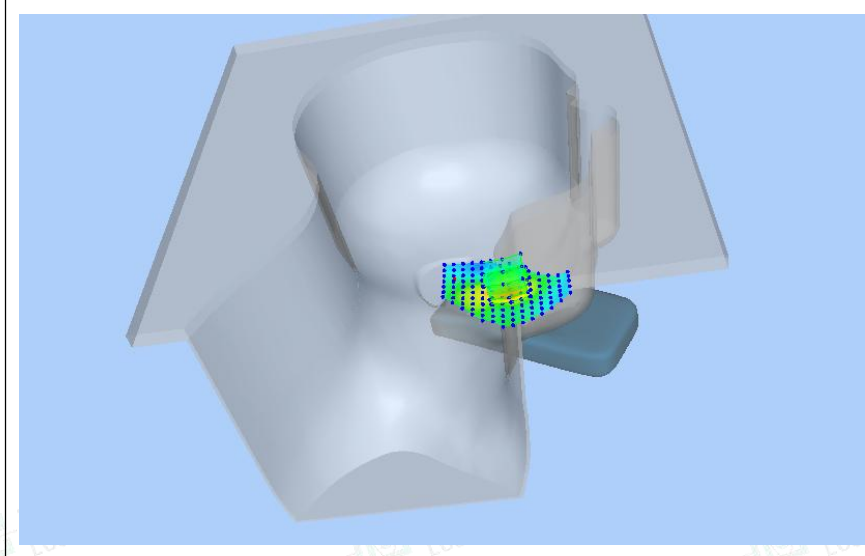
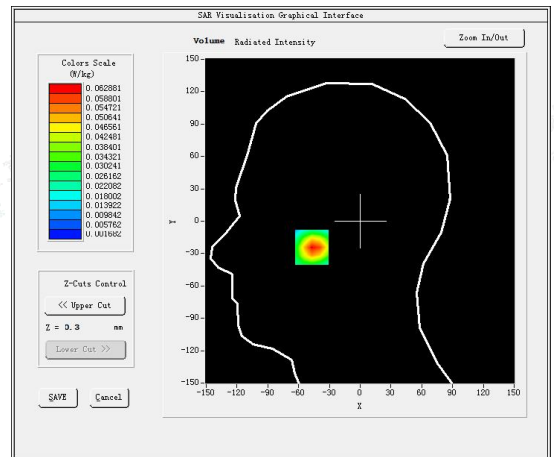
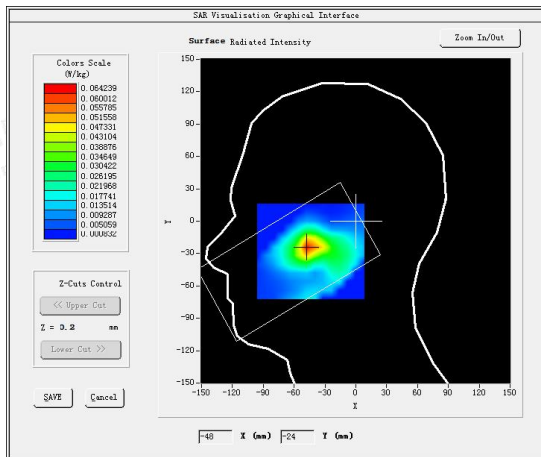



#4

Test Mode: GPRS1900MHz,Middle channel(Body Rear Side)

Product Description:Smartphone

Model:NOTE 50

Test Date: May 24, 2023

Medium(liquid type)	HSL 1900
Frequency (MHz)	1880.0000
Relative permittivity (real part)	42.21
Conductivity (S/m)	1.34
E-Field Probe	SN 25/22 EPGO376
Crest Factor	2.0
Conversion Factor	2.14
Sensor	4mm
Area Scan	dx=8mm dy=8mm
Zoom Scan	5x5x7,dx=8mm dy=8mm dz=5mm
Variation (%)	2.190000
SAR 10g (W/Kg)	0.130368
SAR 1g (W/Kg)	0.231933

**SURFACE SAR**

**VOLUME SAR**

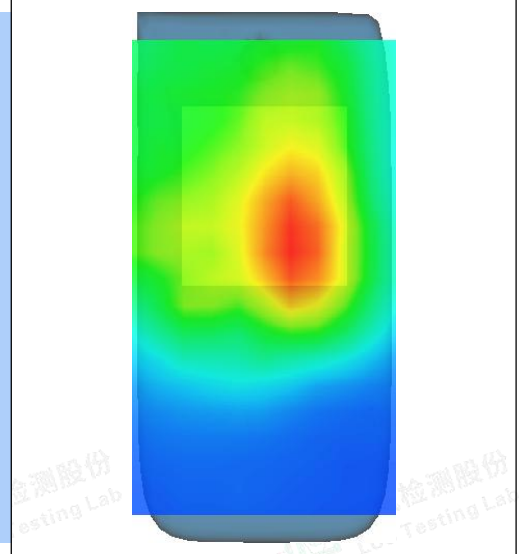
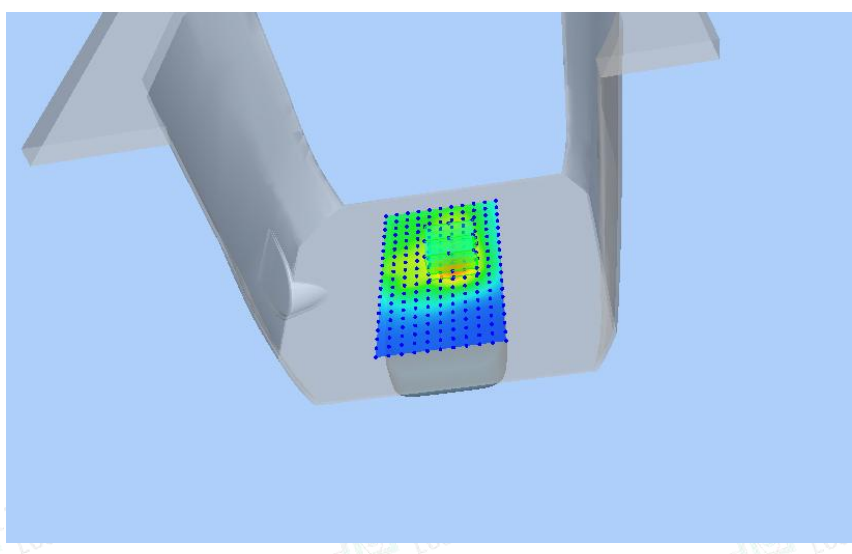
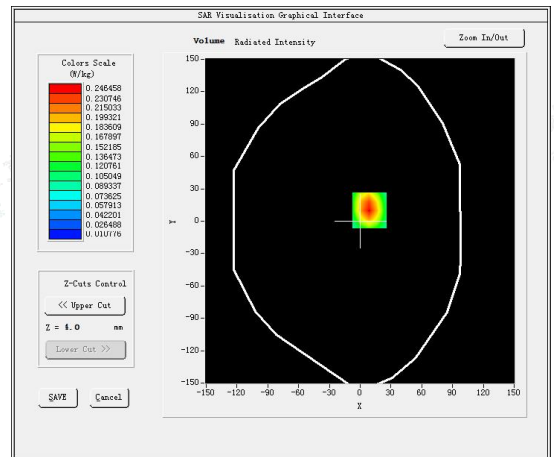
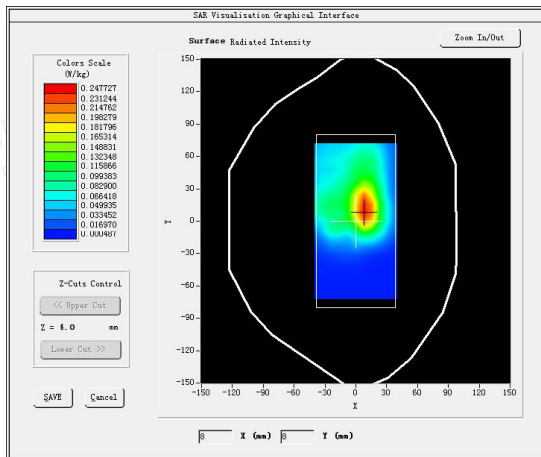



#5

Test Mode: WCDMA Band V, Middle channel(Head Left Cheek)

Product Description:Smartphone

Model:NOTE 50

Test Date: May 17, 2023

Medium(liquid type)	HSL_835
Frequency (MHz)	836.6000
Relative permittivity (real part)	43.21
Conductivity (S/m)	0.85
E-Field Probe	SN 25/22 EPGO376
Crest Factor	1.0
Conversion Factor	1.75
Sensor	4mm
Area Scan	dx=8mm dy=8mm
Zoom Scan	5x5x7,dx=8mm dy=8mm dz=5mm
Variation (%)	-4.150000
SAR 10g (W/Kg)	0.061632
SAR 1g (W/Kg)	0.082998
<b>SURFACE SAR</b>	<b>VOLUME SAR</b>

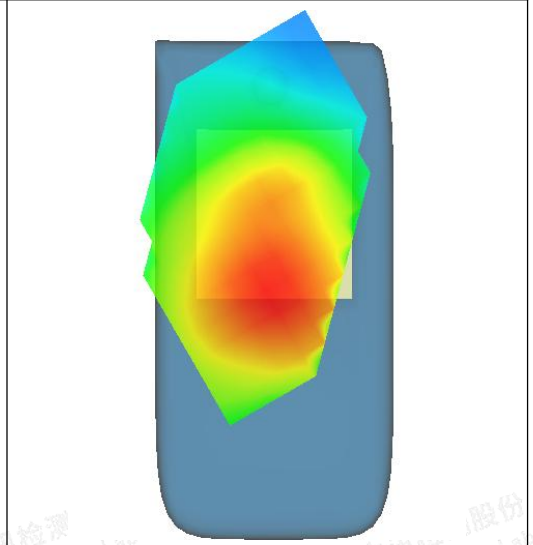
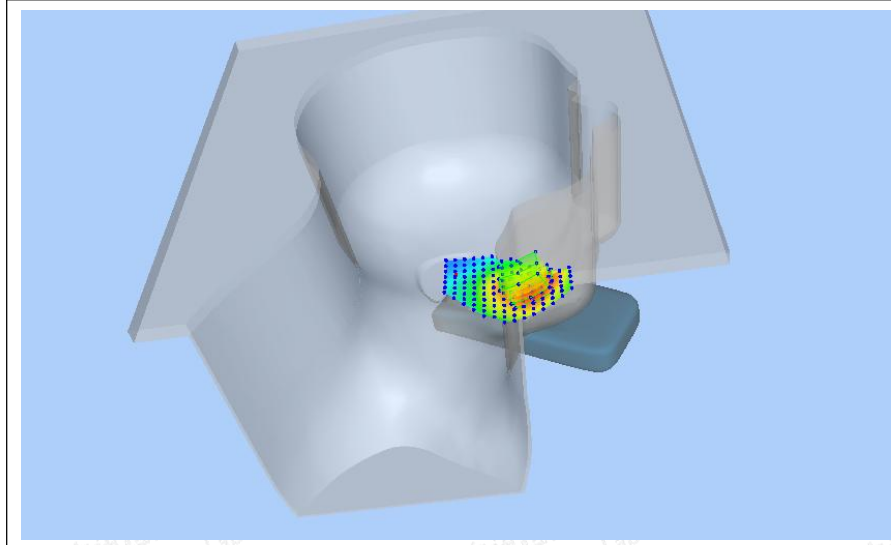
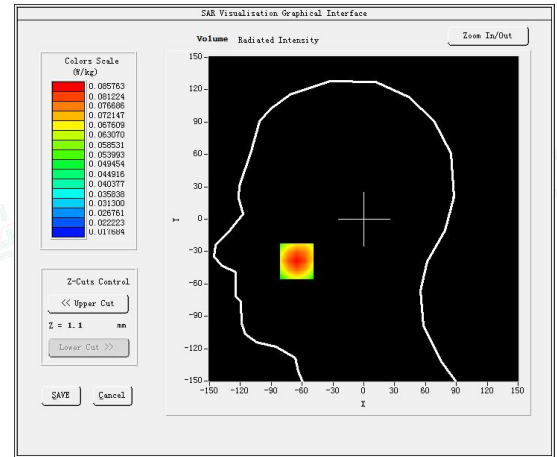
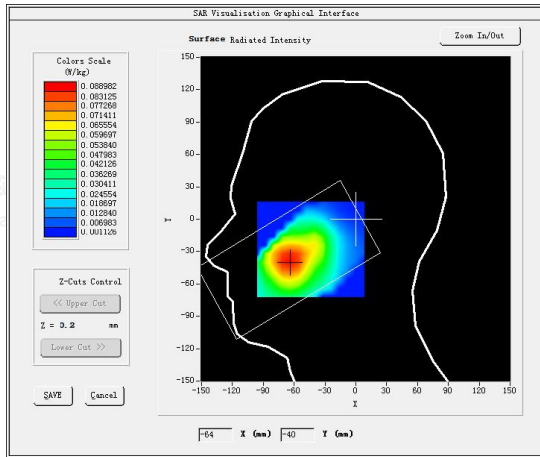



#6

Test Mode: WCDMA Band V, Middle channel(Body Rear Side)

Product Description:Smartphone

Model:NOTE 50

Test Date: May 17, 2023

Medium(liquid type)	HSL_835
Frequency (MHz)	836.6000
Relative permittivity (real part)	43.21
Conductivity (S/m)	0.85
E-Field Probe	SN 25/22 EPGO376
Crest Factor	1.0
Conversion Factor	1.75
Sensor	4mm
Area Scan	dx=8mm dy=8mm
Zoom Scan	5x5x7,dx=8mm dy=8mm dz=5mm
Variation (%)	0.240000
SAR 10g (W/Kg)	0.218782
SAR 1g (W/Kg)	0.311666
<b>SURFACE SAR</b>	<b>VOLUME SAR</b>

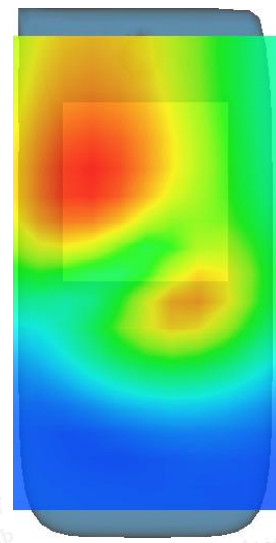
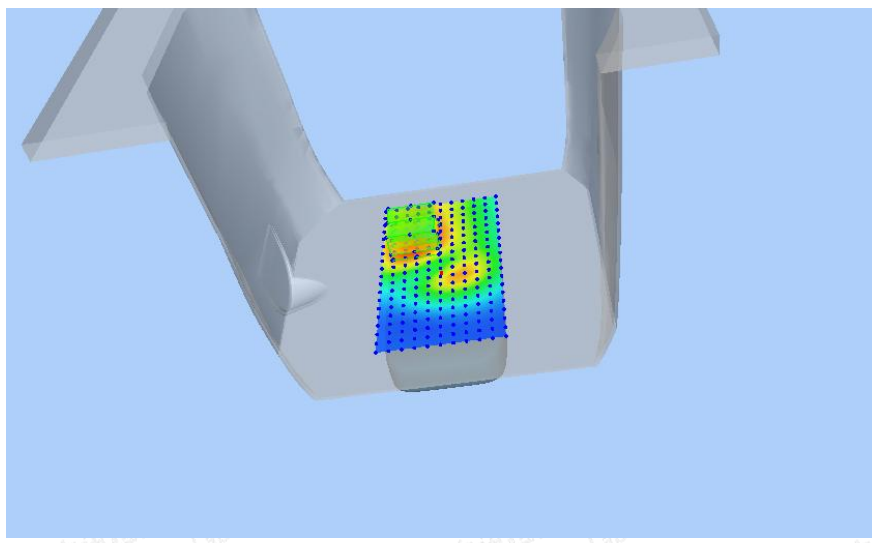
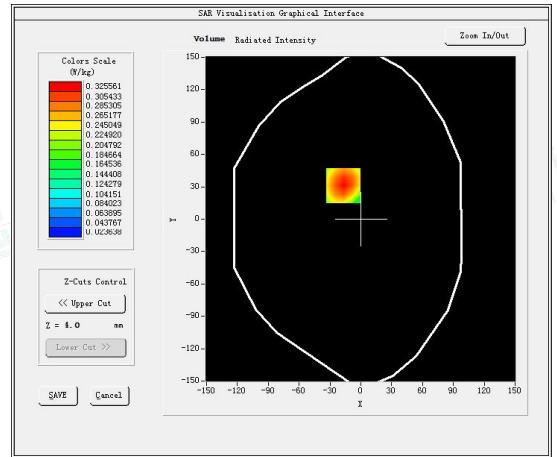
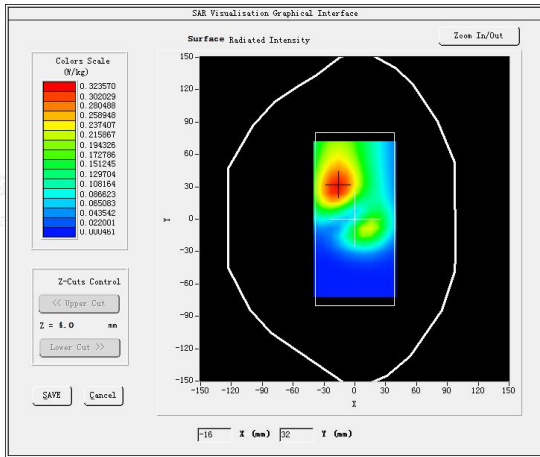



#7

Test Mode: WCDMA Band IV, Middle channel(Head Left Cheek)

Product Description: Smartphone

Model: NOTE 50

Test Date: May 22, 2023

Medium(liquid type)	HSL_1800
Frequency (MHz)	1732.6000
Relative permittivity (real part)	42.35
Conductivity (S/m)	1.36
E-Field Probe	SN 25/22 EPGO376
Crest Factor	1.0
Conversion Factor	2.09
Sensor	4mm
Area Scan	dx=8mm dy=8mm
Zoom Scan	5x5x7,dx=8mm dy=8mm dz=5mm
Variation (%)	2.990000
SAR 10g (W/Kg)	0.071703
SAR 1g (W/Kg)	0.121863
<b>SURFACE SAR</b>	<b>VOLUME SAR</b>

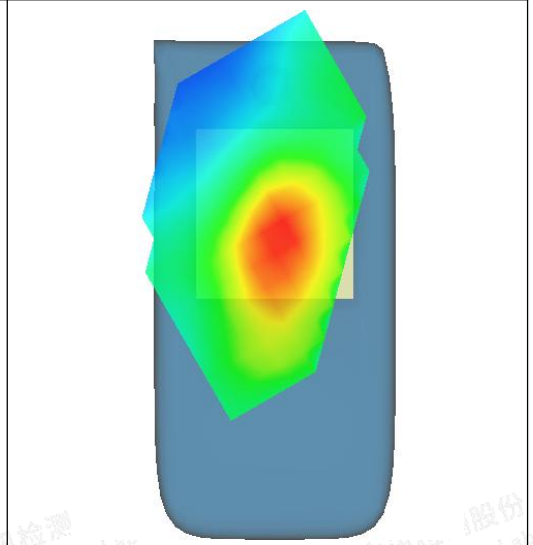
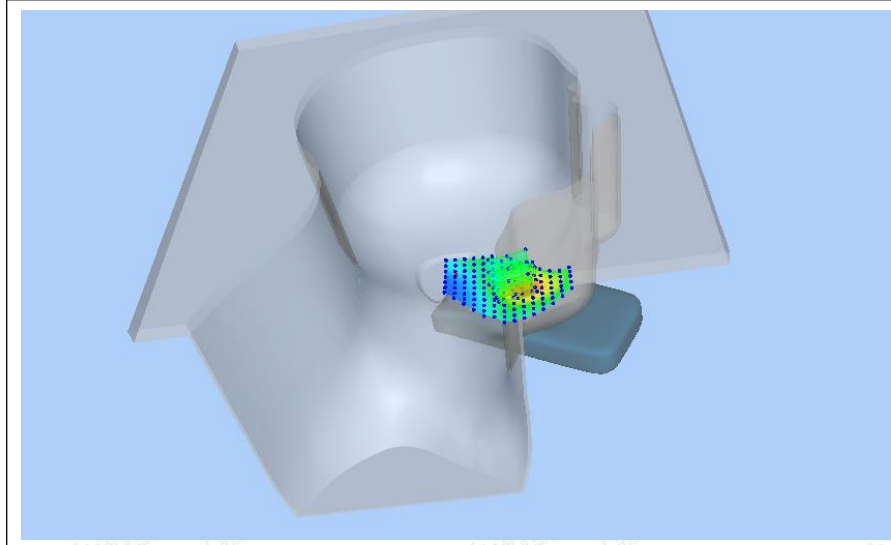
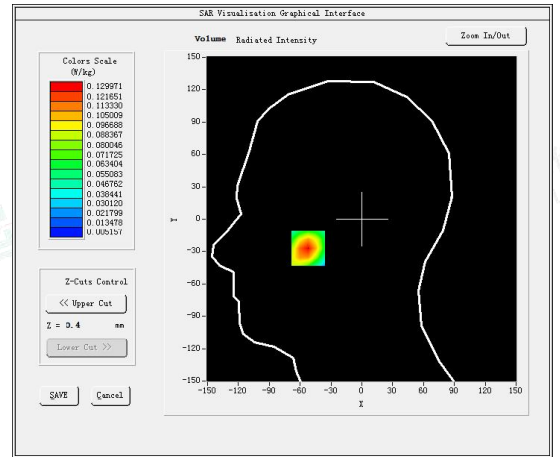
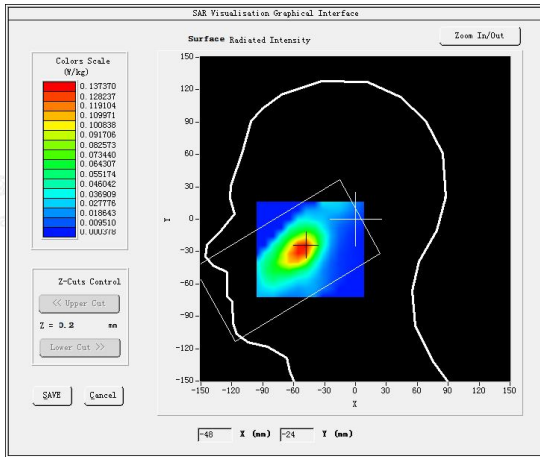





#8

Test Mode: WCDMA Band IV, Middle channel(Body Rear Side)

Product Description:Smartphone

Model:NOTE 50

Test Date: May 22, 2023

Medium(liquid type)	HSL_1800
Frequency (MHz)	1732.6000
Relative permittivity (real part)	42.35
Conductivity (S/m)	1.36
E-Field Probe	SN 25/22 EPGO376
Crest Factor	1.0
Conversion Factor	2.09
Sensor	4mm
Area Scan	dx=8mm dy=8mm
Zoom Scan	5x5x7,dx=8mm dy=8mm dz=5mm
Variation (%)	1.450000
SAR 10g (W/Kg)	0.173622
SAR 1g (W/Kg)	0.298538
<b>SURFACE SAR</b>	<b>VOLUME SAR</b>

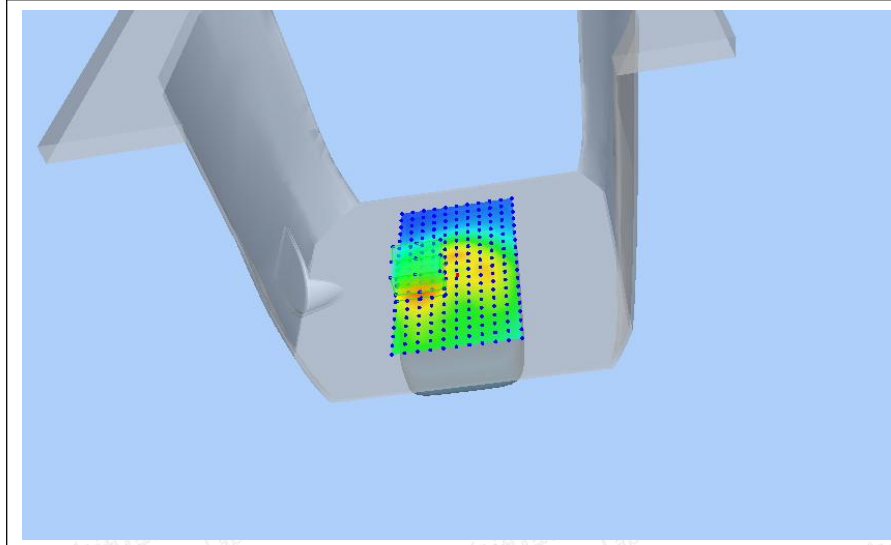
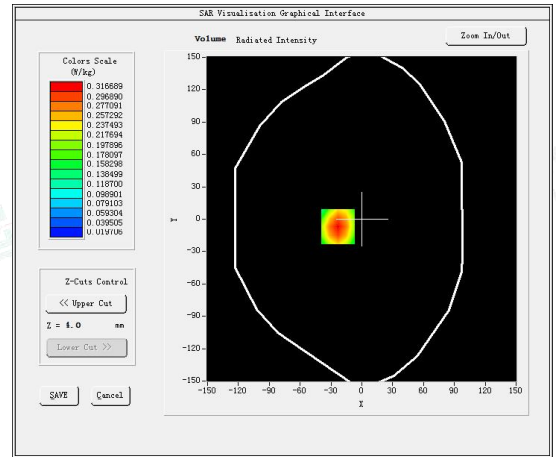
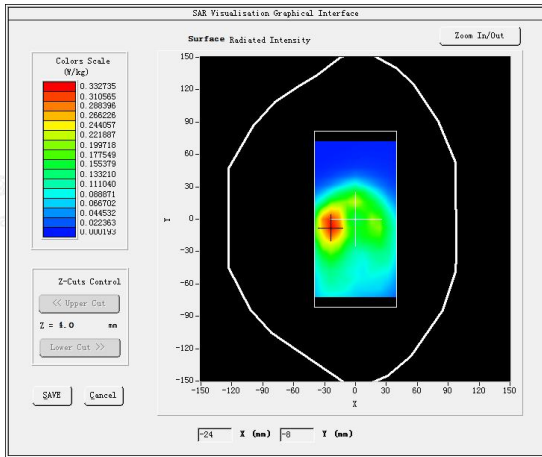



#9

Test Mode: WCDMA Band II, Middle channel(Head Left Cheek)

Product Description:Smartphone

Model:NOTE 50

Test Date: May 24, 2023

Medium(liquid type)	HSL 1900
Frequency (MHz)	1880.0000
Relative permittivity (real part)	42.21
Conductivity (S/m)	1.34
E-Field Probe	SN 25/22 EPGO376
Crest Factor	1.0
Conversion Factor	2.14
Sensor	4mm
Area Scan	dx=8mm dy=8mm
Zoom Scan	5x5x7,dx=8mm dy=8mm dz=5mm
Variation (%)	-1.420000
SAR 10g (W/Kg)	0.067825
SAR 1g (W/Kg)	0.114937
<b>SURFACE SAR</b>	<b>VOLUME SAR</b>

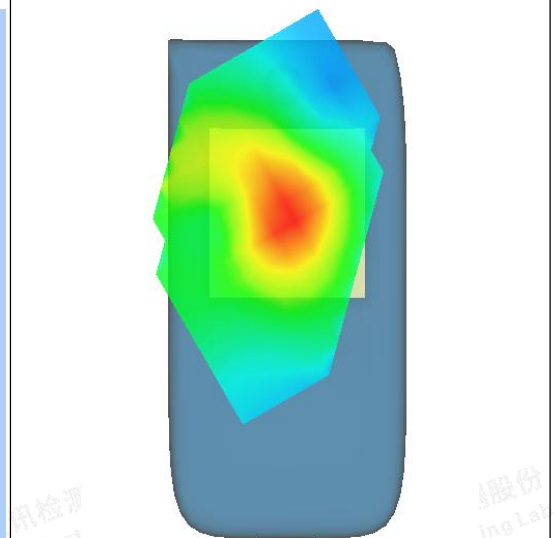
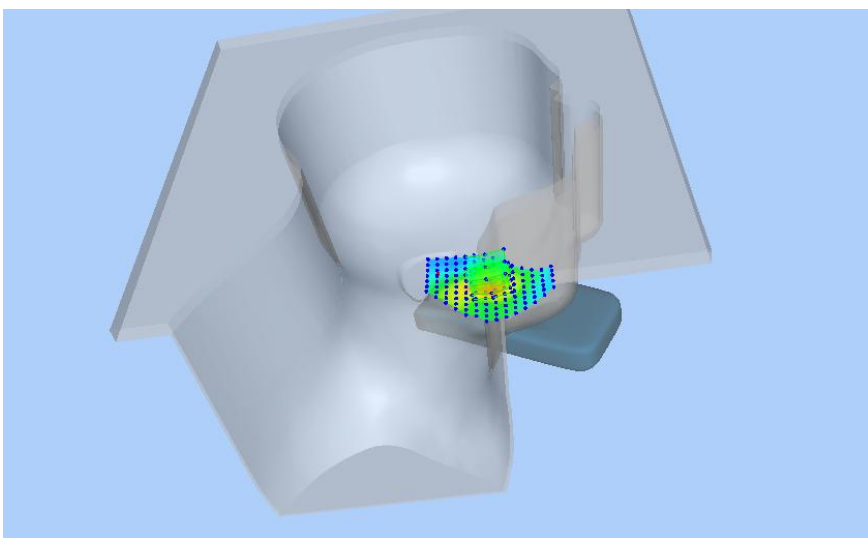
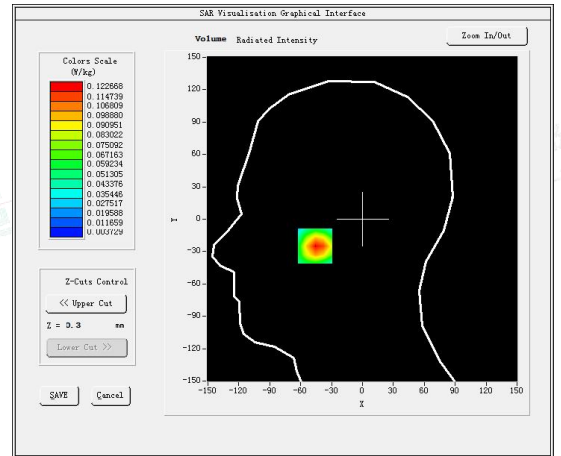
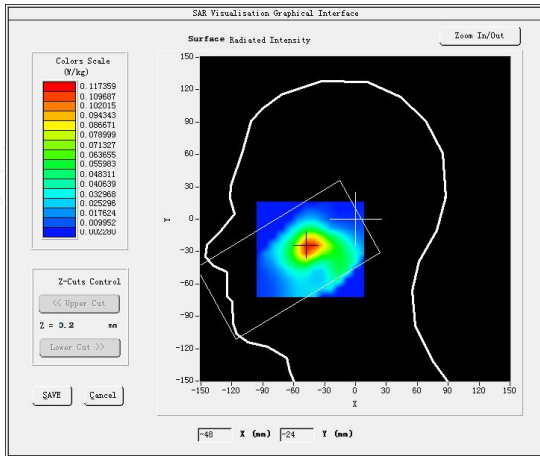



#10

Test Mode: WCDMA Band II, Middle channel(Body Rear Side)

Product Description:Smartphone

Model:NOTE 50

Test Date: May 24, 2023

Medium(liquid type)	HSL 1900
Frequency (MHz)	1880.0000
Relative permittivity (real part)	42.21
Conductivity (S/m)	1.34
E-Field Probe	SN 25/22 EPGO376
Crest Factor	1.0
Conversion Factor	2.14
Sensor	4mm
Area Scan	dx=8mm dy=8mm
Zoom Scan	5x5x7,dx=8mm dy=8mm dz=5mm
Variation (%)	-0.170000
SAR 10g (W/Kg)	0.240629
SAR 1g (W/Kg)	0.418051
<b>SURFACE SAR</b>	<b>VOLUME SAR</b>

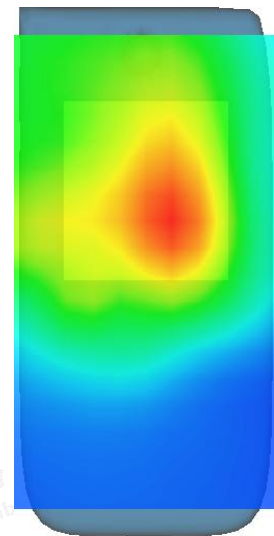
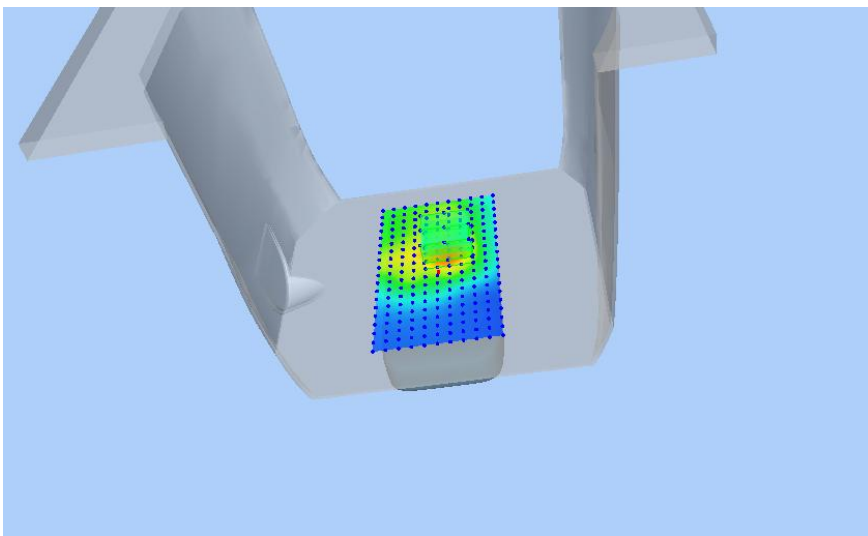
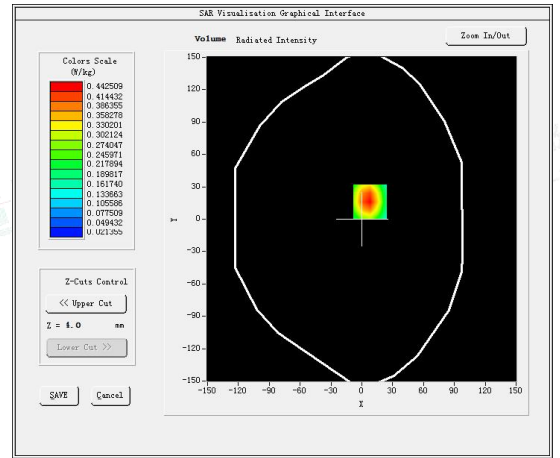
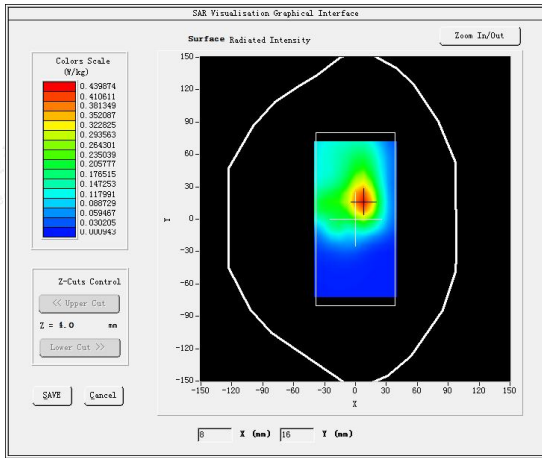

#11

Test Mode: LTE Band 2, 1RB, High channel (Head Left Cheek)

Product Description: Smartphone

Model: NOTE 50

Test Date: May 24, 2023

Medium (liquid type)	HSL 1900
Frequency (MHz)	1900.0000
Relative permittivity (real part)	42.21
Conductivity (S/m)	1.34
E-Field Probe	SN 25/22 EPGO376
Crest Factor	1.0
Conversion Factor	2.14
Sensor	4mm
Area Scan	dx=8mm dy=8mm
Zoom Scan	5x5x7, dx=8mm dy=8mm dz=5mm
Variation (%)	-0.820000
SAR 10g (W/Kg)	0.053155
SAR 1g (W/Kg)	0.089623
<b>SURFACE SAR</b>	<b>VOLUME SAR</b>

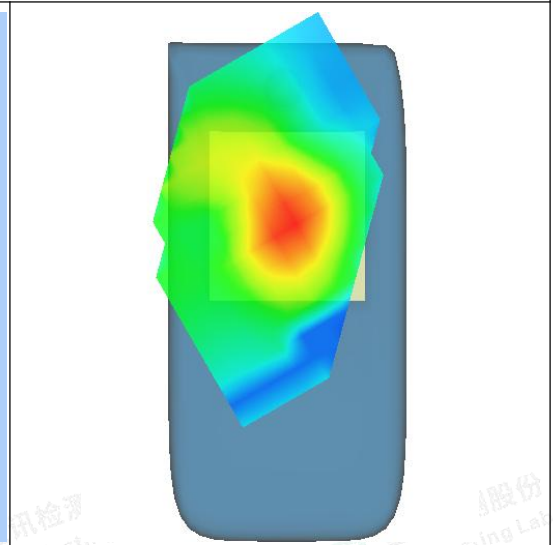
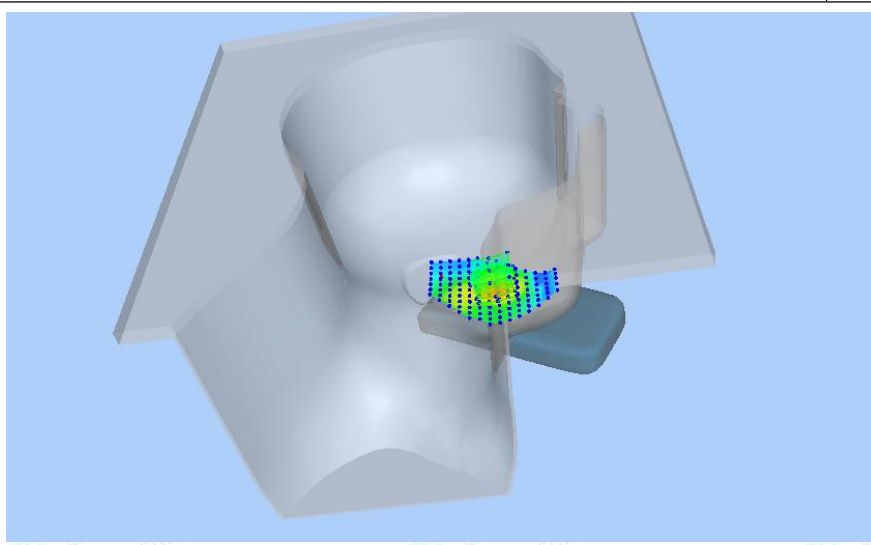
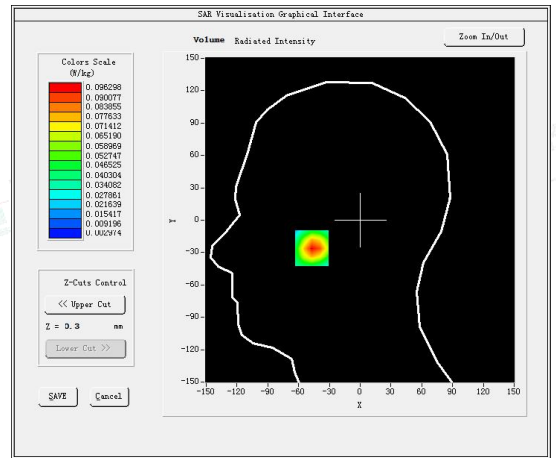
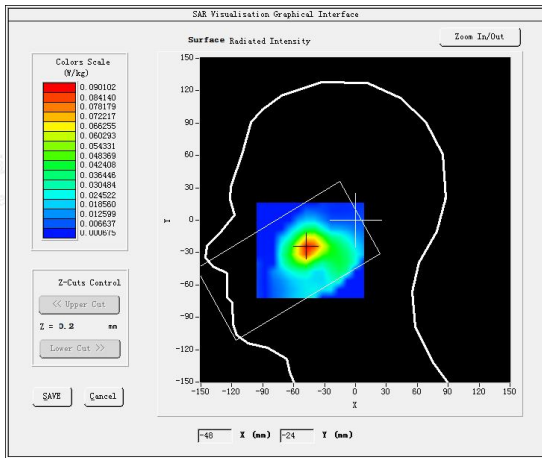



#12

Test Mode: LTE Band 2, 1RB,High channel(Body Rear Side)

Product Description:Smartphone

Model:NOTE 50

Test Date: May 24, 2023

Medium(liquid type)	HSL 1900
Frequency (MHz)	1900.0000
Relative permittivity (real part)	42.21
Conductivity (S/m)	1.34
E-Field Probe	SN 25/22 EPGO376
Crest Factor	1.0
Conversion Factor	2.14
Sensor	4mm
Area Scan	dx=8mm dy=8mm
Zoom Scan	5x5x7,dx=8mm dy=8mm dz=5mm
Variation (%)	0.500000
SAR 10g (W/Kg)	0.183782
SAR 1g (W/Kg)	0.351635
<b>SURFACE SAR</b>	<b>VOLUME SAR</b>

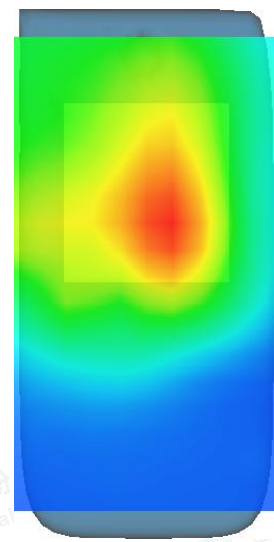
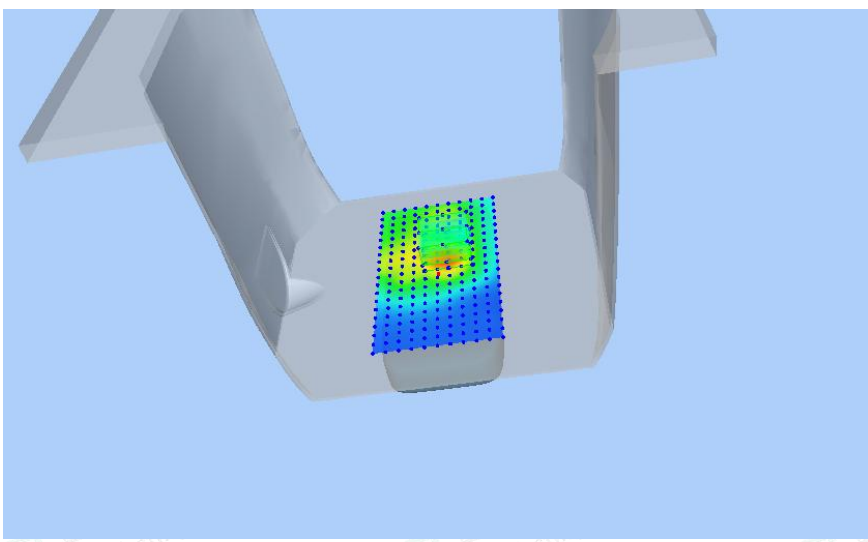
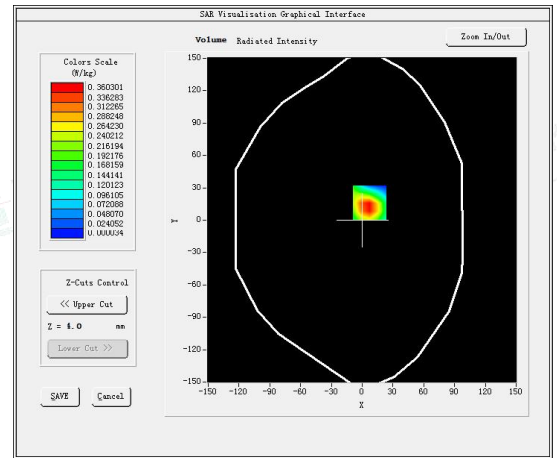
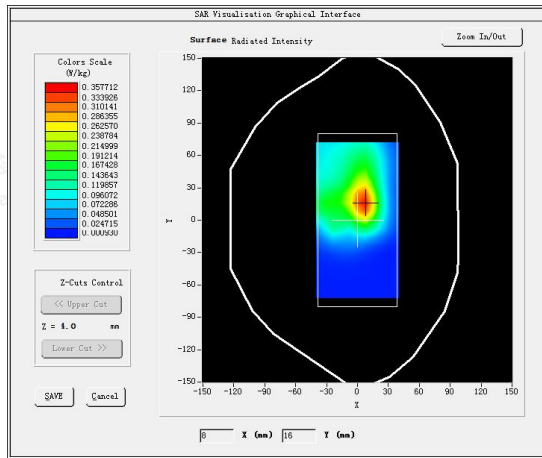



#13

Test Mode: LTE Band 4, 1RB,Middle channel(Head Left Cheek)

Product Description:Smartphone

Model:NOTE 50

Test Date: May 22, 2023

Medium(liquid type)	HSL_1800
Frequency (MHz)	1732.5000
Relative permittivity (real part)	42.35
Conductivity (S/m)	1.36
E-Field Probe	SN 25/22 EPGO376
Crest Factor	1.0
Conversion Factor	2.09
Sensor	4mm
Area Scan	dx=8mm dy=8mm
Zoom Scan	5x5x7,dx=8mm dy=8mm dz=5mm
Variation (%)	-2.810000
SAR 10g (W/Kg)	0.035774
SAR 1g (W/Kg)	0.060430
<b>SURFACE SAR</b>	<b>VOLUME SAR</b>

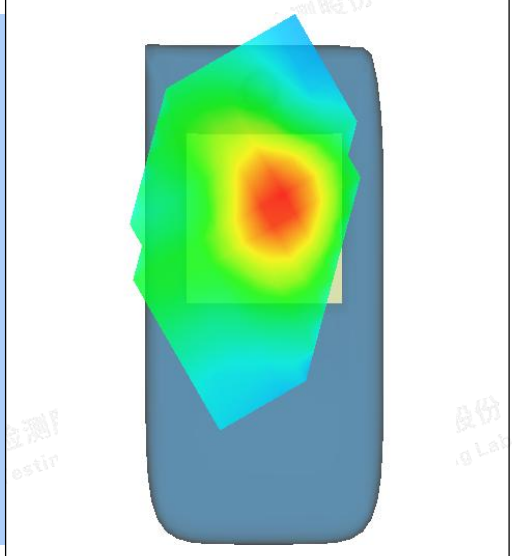
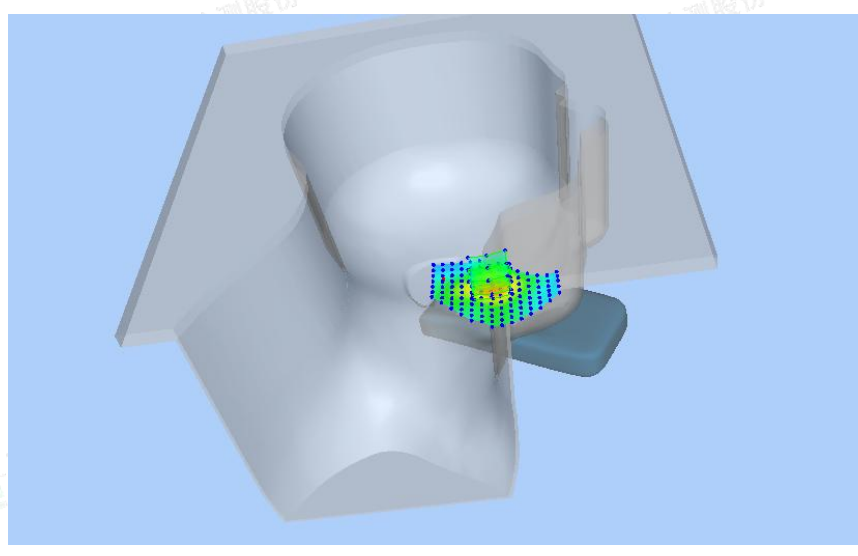
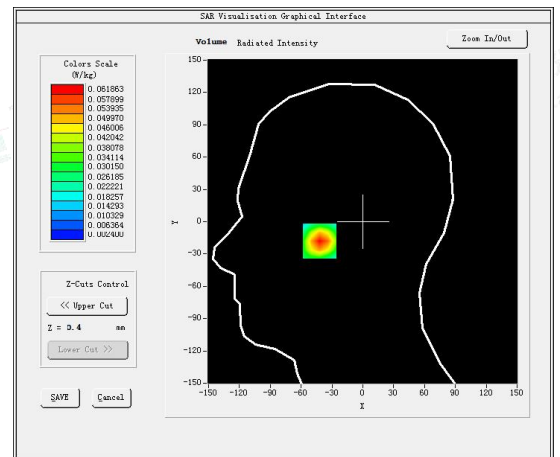
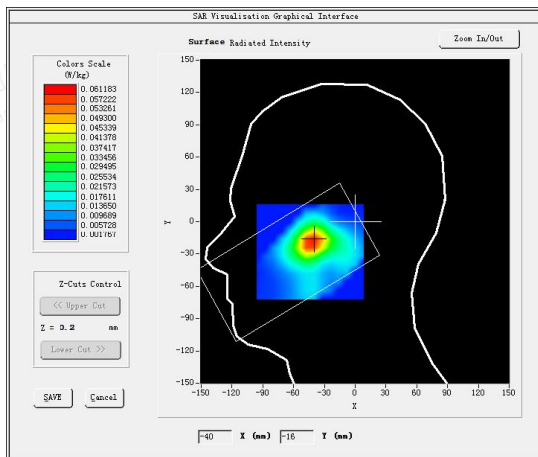



#14

Test Mode: LTE Band 4, 1RB, Middle channel(Body Rear Side)

Product Description:Smartphone

Model:NOTE 50

Test Date: May 22, 2023

Medium(liquid type)	HSL_1800
Frequency (MHz)	1732.5000
Relative permittivity (real part)	42.35
Conductivity (S/m)	1.36
E-Field Probe	SN 25/22 EPGO376
Crest Factor	1.0
Conversion Factor	2.09
Sensor	4mm
Area Scan	dx=8mm dy=8mm
Zoom Scan	5x5x7,dx=8mm dy=8mm dz=5mm
Variation (%)	-0.560000
SAR 10g (W/Kg)	0.109080
SAR 1g (W/Kg)	0.218352

**SURFACE SAR**

**VOLUME SAR**

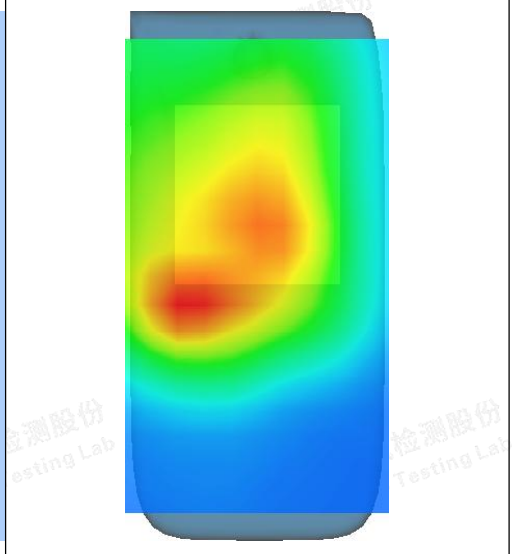
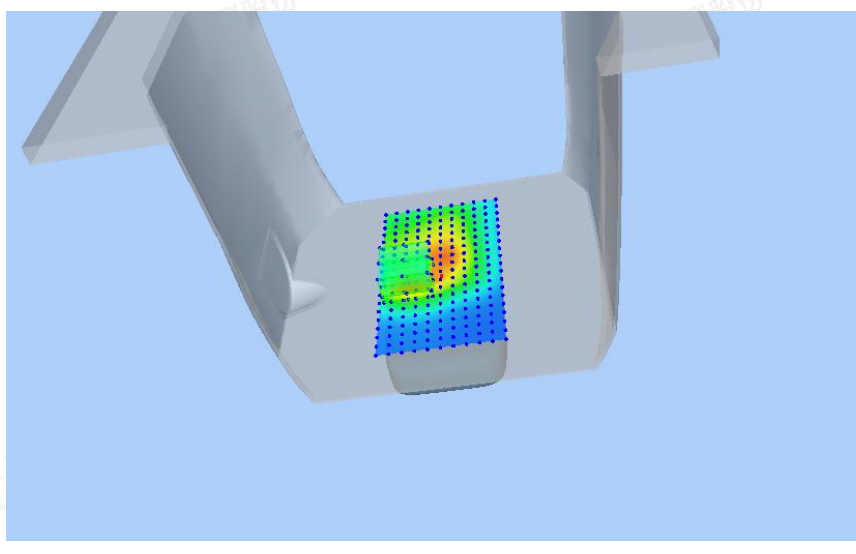
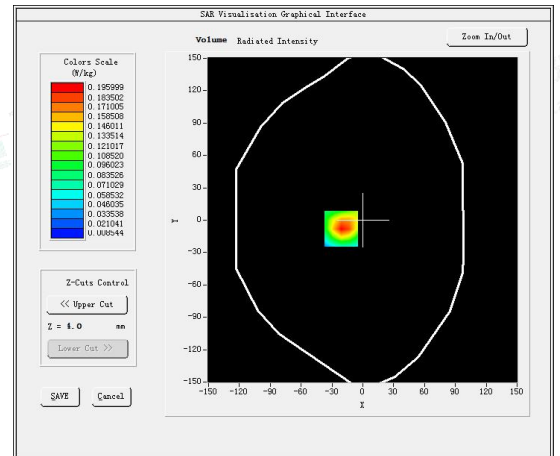
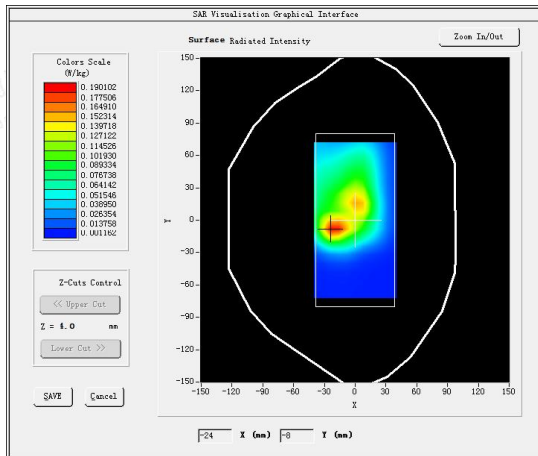



#15

Test Mode: LTE Band 5, 1RB, Middle channel(Head Left Cheek)

Product Description:Smartphone

Model:NOTE 50

Test Date: May 17, 2023

Medium(liquid type)	HSL 835
Frequency (MHz)	836.5000
Relative permittivity (real part)	43.21
Conductivity (S/m)	0.85
E-Field Probe	SN 25/22 EPGO376
Crest Factor	1.0
Conversion Factor	1.75
Sensor	4mm
Area Scan	dx=8mm dy=8mm
Zoom Scan	5x5x7,dx=8mm dy=8mm dz=5mm
Variation (%)	-1.750000
SAR 10g (W/Kg)	0.039905
SAR 1g (W/Kg)	0.054225
<b>SURFACE SAR</b>	<b>VOLUME SAR</b>

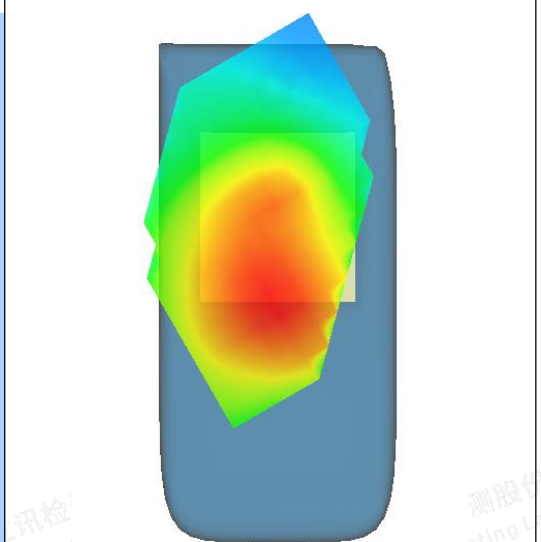
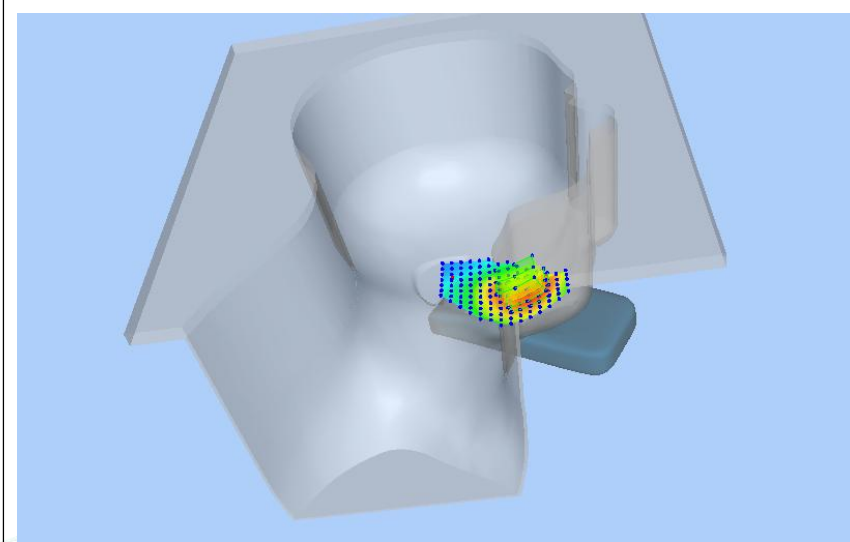
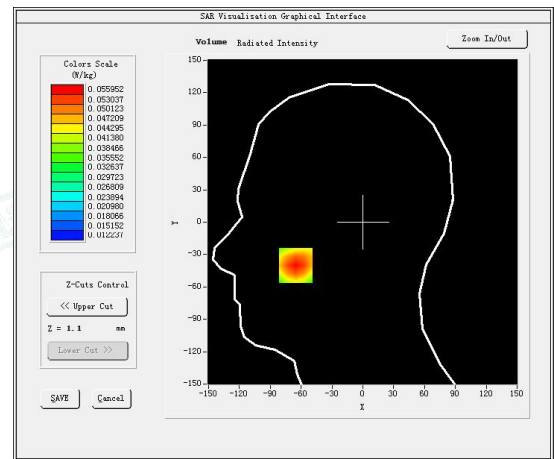
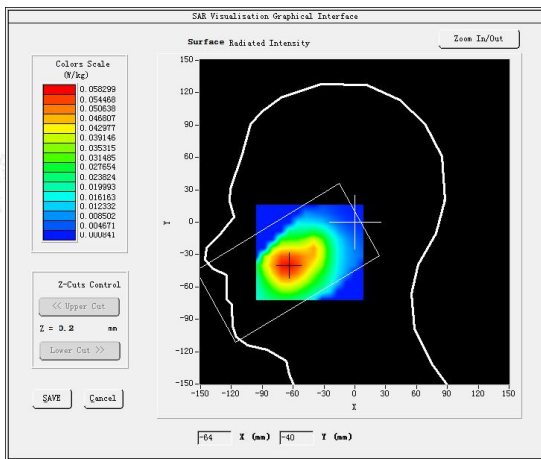





#16

Test Mode: LTE Band 5, 1RB, Middle channel(Body Rear Side)

Product Description:Smartphone

Model:NOTE 50

Test Date: May 17, 2023

Medium(liquid type)	HSL 835
Frequency (MHz)	836.5000
Relative permittivity (real part)	43.21
Conductivity (S/m)	0.85
E-Field Probe	SN 25/22 EPGO376
Crest Factor	1.0
Conversion Factor	1.75
Sensor	4mm
Area Scan	dx=8mm dy=8mm
Zoom Scan	5x5x7,dx=8mm dy=8mm dz=5mm
Variation (%)	1.120000
SAR 10g (W/Kg)	0.162845
SAR 1g (W/Kg)	0.233833
<b>SURFACE SAR</b>	<b>VOLUME SAR</b>

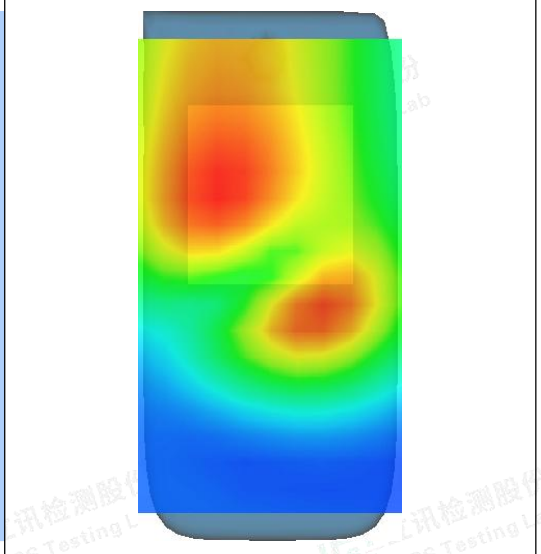
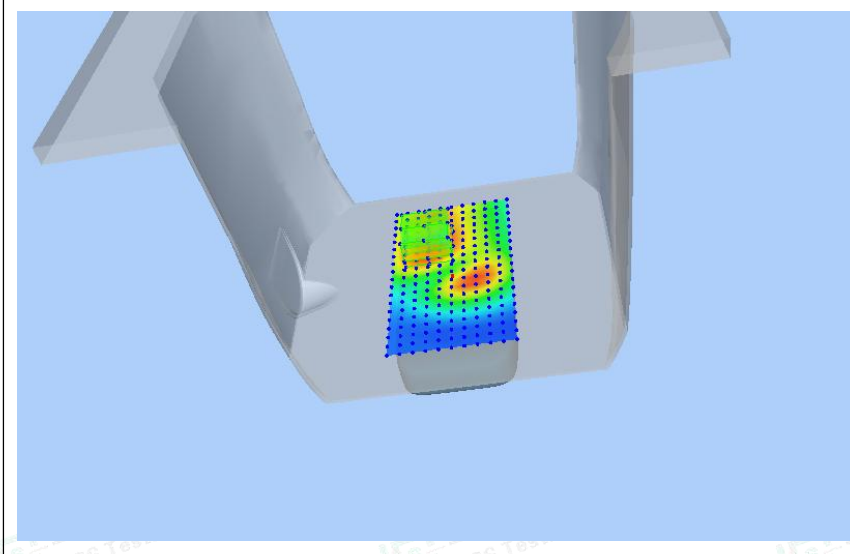
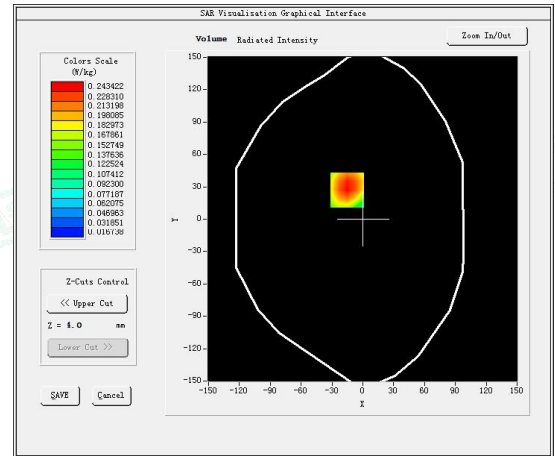
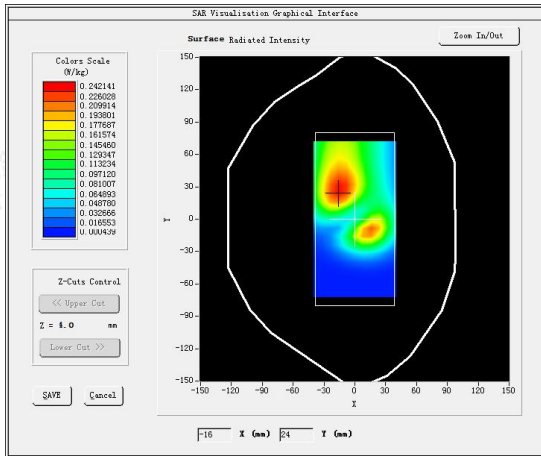



#17

Test Mode: LTE Band 7, 1RB, Low channel (Head Left Cheek)

Product Description: Smartphone

Model: NOTE 50

Test Date: May 31, 2023

Medium (liquid type)	HSL 2600
Frequency (MHz)	2510.0000
Relative permittivity (real part)	41.11
Conductivity (S/m)	1.93
E-Field Probe	SN 25/22 EPGO376
Crest Factor	1.0
Conversion Factor	2.39
Sensor	4mm
Area Scan	dx=8mm dy=8mm
Zoom Scan	5x5x7, dx=8mm dy=8mm dz=5mm
Variation (%)	-3.190000
SAR 10g (W/Kg)	0.025254
SAR 1g (W/Kg)	0.049336
<b>SURFACE SAR</b>	<b>VOLUME SAR</b>

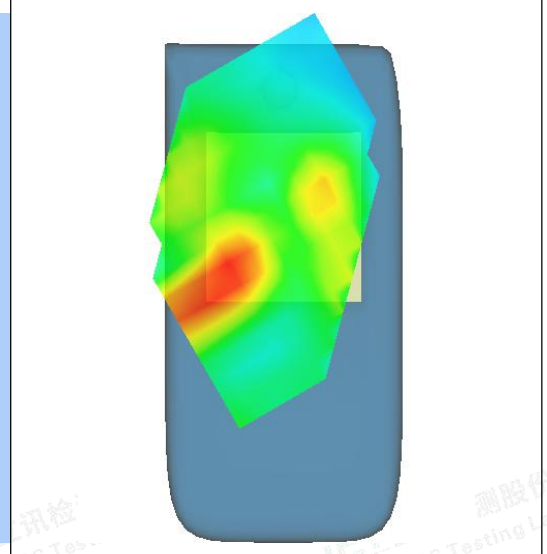
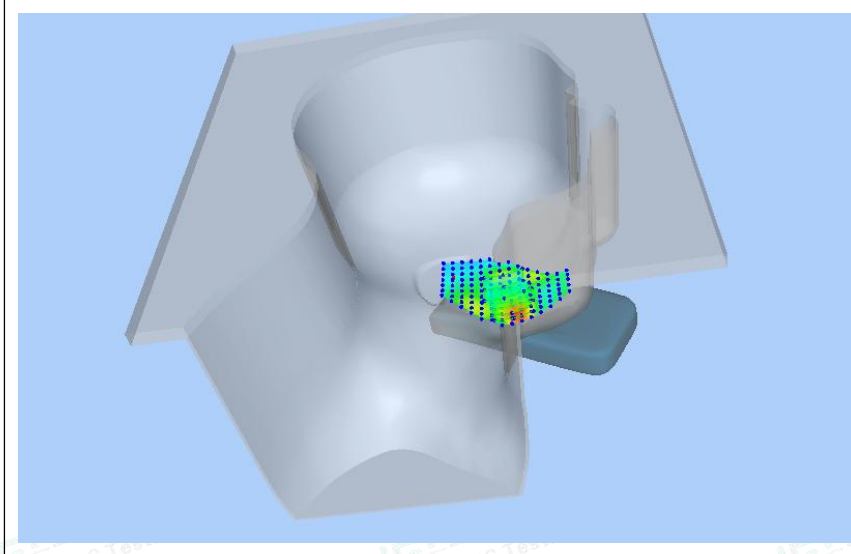
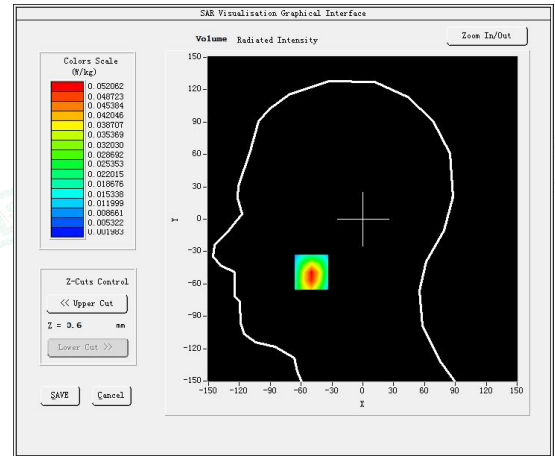
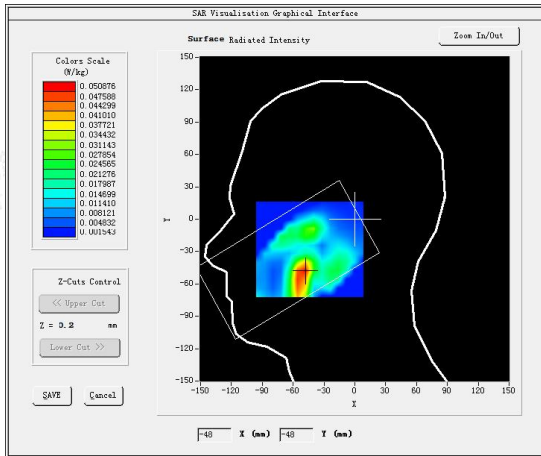



#18

Test Mode: LTE Band 7, 1RB,Low channel(Body Rear Side)

Product Description:Smartphone

Model:NOTE 50

Test Date: May 31, 2023

Medium(liquid type)	HSL 2600
Frequency (MHz)	2510.0000
Relative permittivity (real part)	41.11
Conductivity (S/m)	1.93
E-Field Probe	SN 25/22 EPGO376
Crest Factor	1.0
Conversion Factor	2.39
Sensor	4mm
Area Scan	dx=8mm dy=8mm
Zoom Scan	5x5x7,dx=8mm dy=8mm dz=5mm
Variation (%)	-0.150000
SAR 10g (W/Kg)	0.368225
SAR 1g (W/Kg)	0.704163
<b>SURFACE SAR</b>	<b>VOLUME SAR</b>

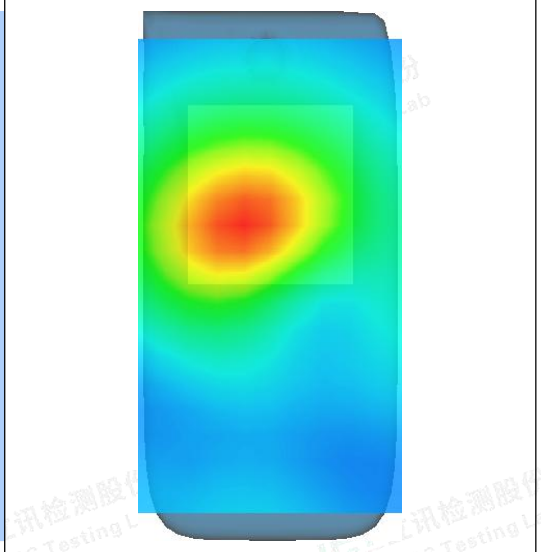
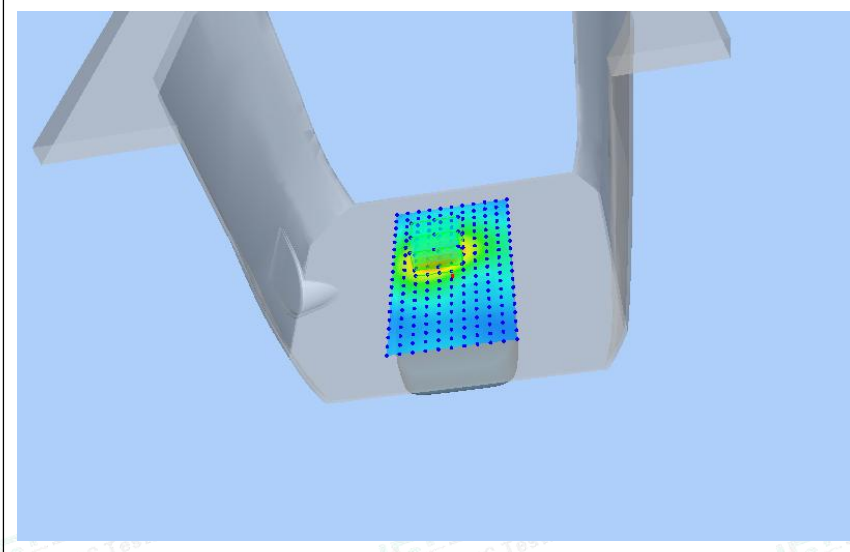
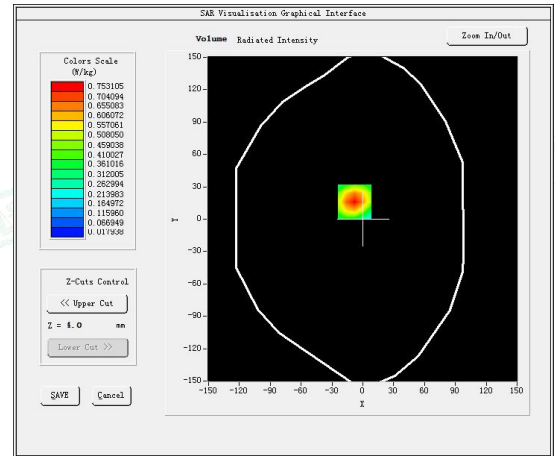
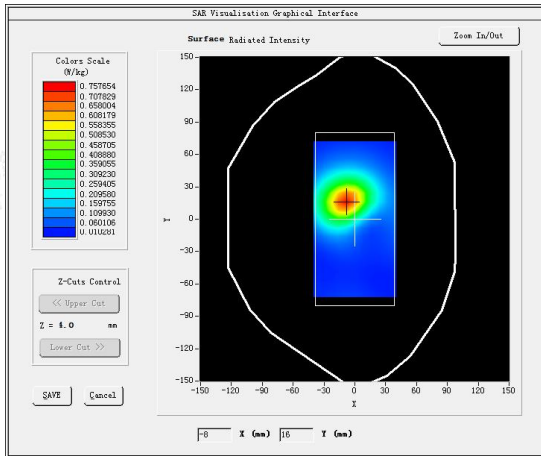



#19

Test Mode: LTE Band 12, 1RB, High channel (Head Left Cheek)

Product Description: Smartphone

Model: NOTE 50

Test Date: May 15, 2023

Medium(liquid type)	HSL_750
Frequency (MHz)	711.0000
Relative permittivity (real part)	42.44
Conductivity (S/m)	0.87
E-Field Probe	SN 25/22 EPGO376
Crest Factor	1.0
Conversion Factor	1.69
Sensor	4mm
Area Scan	dx=8mm dy=8mm
Zoom Scan	5x5x7,dx=8mm dy=8mm dz=5mm
Variation (%)	-2.260000
SAR 10g (W/Kg)	0.045482
SAR 1g (W/Kg)	0.055062
<b>SURFACE SAR</b>	<b>VOLUME SAR</b>

