

FCC SAR EVALUATION REPORT

**In accordance with the requirements of
FCC 47 CFR Part 2(2.1093), ANSI/IEEE C95.1-1992 and
IEEE Std 1528-2013**

Product Name : Smartphone
Brand Name : CUBOT
Model Name : KINGKONG 5 Pro
Family Model : N/A
Report No. : S21012002811001
FCC ID : 2AHZ5KK5P

Prepared for

Shenzhen Huafurui Technology Co., Ltd
Unit 1401 14/F, Jin qi zhi gu mansion Liu xian street, Xili,
Nan shan district, Shenzhen, China

Prepared by

Shenzhen NTEK Testing Technology Co., Ltd.
1/F, Building E, Fenda Science Park, Sanwei Community, Xixiang Street,
Bao'an District, Shenzhen 518126 P.R.China.
Tel. 400-800-6106, 0755-2320 0050, 0755-2320 0090
Website: <http://www.ntek.org.cn>

TEST RESULT CERTIFICATION

Applicant's name: Shenzhen Huafurui Technology Co., Ltd
 Address.....: Unit 1401 14/F, Jin qi zhi gu mansion Liu xian street, Xili,
 Nan shan district, Shenzhen, China
Manufacturer's Name.....: Shenzhen Huafurui Technology Co., Ltd
 Address.....: Unit 1401 14/F, Jin qi zhi gu mansion Liu xian street, Xili,
 Nan shan district, Shenzhen, China

Product description

Product name.....: Smartphone
 Brand Name: CUBOT
 Model and/or type reference .: KINGKONG 5 Pro
 Family Model.....: N/A

Standards: FCC 47 CFR Part 2(2.1093)
 ANSI/IEEE C95.1-1992
 IEEE Std 1528-2013
 Published RF exposure KDB procedures

This device described above has been tested by Shenzhen NTEK. In accordance with the measurement methods and procedures specified in IEEE Std 1528-2013 and KDB 865664 D01. Testing has shown that this device is capable of compliance with localized specific absorption rate (SAR) specified in FCC 47 CFR Part 2(2.1093) and ANSI/IEEE C95.1-1992. The test results in this report apply only to the tested sample of the stated device/equipment. Other similar device/equipment will not necessarily produce the same results due to production tolerance and measurement uncertainties.

This report shall not be reproduced except in full, without the written approval of Shenzhen NTEK, this document may be altered or revised by Shenzhen NTEK, personal only, and shall be noted in the revision of the document.

Date of Test

Date (s) of performance of tests: Feb. 02, 2021 ~ Feb. 26, 2021
 Date of Issue: Mar. 17, 2021
 Test Result.....: **Pass**

Prepared By : Cheng Jiawen
 (Test Engineer) :
 (Cheng Jiawen)

Approved By : Alex
 (Lab Manager) :
 (Alex Li)

※ ※ Revision History ※ ※

REV.	DESCRIPTION	ISSUED DATE	REMARK
Rev.1.0	Initial Test Report Release	Mar. 17, 2021	Cheng Jiawen

TABLE OF CONTENTS

1. General Information	6
1.1. RF exposure limits	6
1.2. Statement of Compliance.....	7
1.3. EUT Description	7
1.4. Test specification(s)	9
1.5. Ambient Condition	9
2. SAR Measurement System	10
2.1. SATIMO SAR Measurement Set-up Diagram	10
2.2. Robot	11
2.3. E-Field Probe	12
2.3.1. E-Field Probe Calibration.....	12
2.4. SAM phantoms	13
2.4.1. Technical Data	14
2.5. Device Holder	15
2.6. Test Equipment List	16
3. SAR Measurement Procedures	18
3.1. Power Reference.....	18
3.2. Area scan & Zoom scan	18
3.3. Description of interpolation/extrapolation scheme	20
3.4. Volumetric Scan	20
3.5. Power Drift	20
4. System Verification Procedure.....	21
4.1. Tissue Verification.....	21
4.1.1. Tissue Dielectric Parameter Check Results	22
4.2. System Verification Procedure	23
4.2.1. System Verification Results	24
5. SAR Measurement variability and uncertainty	25
5.1. SAR measurement variability	25
5.2. SAR measurement uncertainty.....	25
6. RF Exposure Positions	26
6.1. Ear and handset reference point.....	26
6.2. Definition of the cheek position	26
6.3. Definition of the tilt position.....	28
6.4. Body Worn Accessory	28
6.5. Wireless Router Devices.....	29
7. RF Output Power	30
7.1. GSM Conducted Power	30
7.2. WCDMA Conducted Power.....	31
7.3. LTE Conducted Power.....	32

7.4. WLAN & Bluetooth Output Power.....	56
8. Antenna Location.....	58
9. Stand-alone SAR test exclusion.....	59
10. SAR Results.....	60
10.1. SAR measurement Result.....	60
10.1.1. SAR measurement Result of GSM850.....	60
10.1.2. SAR measurement Result of GSM1900.....	60
10.1.3. SAR measurement Result of WCDMA Band 2.....	62
10.1.4. SAR measurement Result of WCDMA Band 4.....	63
10.1.5. SAR measurement Result of WCDMA Band 5.....	64
10.1.6. SAR measurement Result of LTE Band 2.....	65
10.1.7. SAR measurement Result of LTE Band 4.....	67
10.1.8. SAR measurement Result of LTE Band 5.....	69
10.1.9. SAR measurement Result of LTE Band 7.....	71
10.1.10. SAR measurement Result of LTE Band 12.....	73
10.1.11. SAR measurement Result of LTE Band 13.....	75
10.1.12. SAR measurement Result of LTE Band 17.....	77
10.1.13. SAR measurement Result of LTE Band 25.....	79
10.1.14. SAR measurement Result of LTE Band 26A.....	81
10.1.15. SAR measurement Result of LTE Band 26B.....	83
10.1.16. SAR measurement Result of LTE Band 41.....	85
10.1.17. SAR measurement Result of LTE Band 66.....	87
10.1.18. SAR measurement Result of WLAN 2.4G.....	89
10.1.19. SAR measurement Result of WLAN 5.2G.....	90
10.1.20. SAR measurement Result of WLAN 5.8G.....	91
10.2. Simultaneous Transmission Analysis.....	92
11. Appendix A. Photo documentation.....	93
12. Appendix B. System Check Plots.....	94
13. Appendix C. Plots of High SAR Measurement.....	111
14. Appendix D. Calibration Certificate.....	194

1. General Information

1.1. RF exposure limits

(A).Limits for Occupational/Controlled Exposure (W/kg)

Whole-Body	Partial-Body	Hands, Wrists, Feet and Ankles
0.4	8.0	20.0

(B).Limits for General Population/Uncontrolled Exposure (W/kg)

Whole-Body	Partial-Body	Hands, Wrists, Feet and Ankles
0.08	1.6	4.0

NOTE: **Whole-Body SAR** is averaged over the entire body, **partial-body SAR** is averaged over any 1 gram of tissue defined as a tissue volume in the shape of a cube. **SAR for hands, wrists, feet and ankles** is averaged over any 10 grams of tissue defined as a tissue volume in the shape of a cube.

Occupational/Controlled Environments:

Are defined as locations where there is exposure that may be incurred by people who are aware of the potential for exposure, (i.e. as a result of employment or occupation).

General Population/Uncontrolled Environments:

Are defined as locations where there is the exposure of individuals who have no knowledge or control of their exposure.

NOTE
 HEAD AND TRUNK LIMIT
 1.6 W/kg
 APPLIED TO THIS EUT

1.2. Statement of Compliance

The maximum results of Specific Absorption Rate (SAR) found during testing for KINGKONG 5 Pro are as follows.

RF Exposure Conditions		Equipment Class - Highest Reported SAR (W/kg)			
		PCE	DTS	NII	DSS
1-g Head		0.540	0.344	0.306	N/A
1-g Body-Worn (Separation distance of 10mm)		1.178	0.090	0.114	N/A
1-g Hotspot (Separation distance of 10mm)		1.178	0.090	0.114	N/A
Max Simultaneous Tx	Head	0.884	0.884	0.846	0.805
	Body-Worn	1.310	1.268	1.292	1.310
	Hotspot	1.310	1.268	1.292	1.310

Note: The Max Simultaneous Tx is calculated based on the same configuration and test position.

This device is in compliance with Specific Absorption Rate (SAR) for general population/uncontrolled exposure limits (1.6 W/kg) specified in FCC 47 CFR Part 2(2.1093) and ANSI/IEEE C95.1-1992, and had been tested in accordance with the measurement methods and procedures specified in IEEE Std 1528-2013 & KDB 865664 D01.

1.3. EUT Description

Device Information			
Product Name	Smartphone		
Brand Name	CUBOT		
Model Name	KINGKONG 5 Pro		
Family Model	N/A		
FCC ID	2AHZ5KK5P		
Device Phase	Identical Prototype		
Exposure Category	General population / Uncontrolled environment		
Antenna Type	PIFA Antenna		
Battery Information	DC 3.85V, 8000mAh		
Device Operating Configurations			
Supporting Mode(s)	GSM 850/1900, WCDMA Band 2/4/5, LTE Band 2/4/5/7/12/13/17/25/26/41/66, WLAN 2.4G/5.2G/5.8G, Bluetooth, NFC		
Test Modulation	GSM(GMSK/8PSK), WCDMA(QPSK), LTE(QPSK/16QAM), WLAN(DSSS/OFDM), Bluetooth(GFSK, π/4-DQPSK, 8DPSK), NFC(ASK)		
Device Class	B		
Operating Frequency Range(s)	Band	Tx (MHz)	Rx (MHz)

	GSM 850	824-849	869-894
	GSM 1900	1850-1910	1930-1990
	WCDMA Band 2	1850-1910	1930-1990
	WCDMA Band 4	1710-1755	2110-2155
	WCDMA Band 5	824-849	869-894
	LTE Band 2	1850-1910	1930-1990
	LTE Band 4	1710-1755	2110-2155
	LTE Band 5	824-849	869-894
	LTE Band 7	2500-2570	2620-2690
	LTE Band 12	699-716	729-746
	LTE Band 13	777-787	746-756
	LTE Band 17	704-716	734-746
	LTE Band 25	1850-1915	1930-1995
	LTE Band 26	814-849	859-894
	LTE Band 41	2496-2690	
	LTE Band 66	1710-1780	2110-2200
	WLAN 2.4G	2412-2462	
	WLAN 5.2G	5180-5240	
	WLAN 5.8G	5745-5825	
	Bluetooth	2402-2480	
	NFC	13.56	
GPRS Multislot Class(12)	Max Number of Timeslots in Uplink		4
	Max Number of Timeslots in Downlink		4
	Max Total Timeslot		5
EDGE Multislot Class(12)	Max Number of Timeslots in Uplink		4
	Max Number of Timeslots in Downlink		4
	Max Total Timeslot		5
Power Class	4, tested with power level 5(GSM 850)		
	1, tested with power level 0(GSM 1900)		
	3, tested with power control "all 1"(WCDMA Band 2)		
	3, tested with power control "all 1"(WCDMA Band 4)		
	3, tested with power control "all 1"(WCDMA Band 5)		
	3, tested with power control all Max.(LTE Band 2)		
	3, tested with power control all Max.(LTE Band 4)		
	3, tested with power control all Max.(LTE Band 5)		
	3, tested with power control all Max.(LTE Band 7)		
	3, tested with power control all Max.(LTE Band 12)		
	3, tested with power control all Max.(LTE Band 13)		
	3, tested with power control all Max.(LTE Band 17)		
	3, tested with power control all Max.(LTE Band 25)		

	3, tested with power control all Max.(LTE Band 26)
	3, tested with power control all Max.(LTE Band 41)
	3, tested with power control all Max.(LTE Band 66)

1.4. Test specification(s)

FCC 47 CFR Part 2(2.1093)
ANSI/IEEE C95.1-1992
IEEE Std 1528-2013
KDB 865664 D01 SAR measurement 100 MHz to 6 GHz
KDB 865664 D02 RF Exposure Reporting
KDB 447498 D01 General RF Exposure Guidance
KDB 248227 D01 802.11 Wi-Fi SAR
KDB 941225 D01 3G SAR Procedures
KDB 941225 D05 SAR for LTE Devices
KDB 941225 D06 Hotspot SAR
KDB 648474 D04 Handset SAR

1.5. Ambient Condition

Ambient temperature	20°C – 24°C
Relative Humidity	30% – 70%

2. SAR Measurement System

2.1. SATIMO SAR Measurement Set-up Diagram

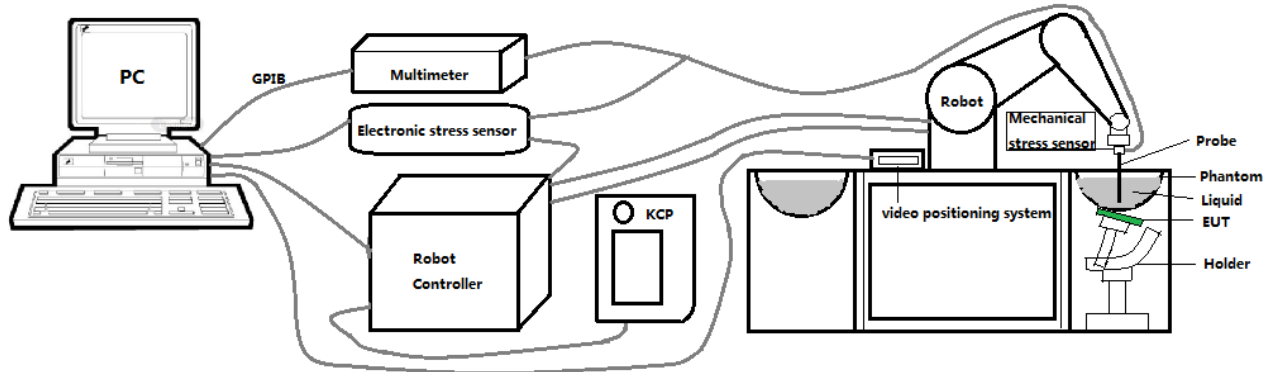

These measurements were performed with the automated near-field scanning system OPENSAR from SATIMO. The system is based on a high precision robot (working range: 901 mm), which positions the probes with a positional repeatability of better than ± 0.03 mm. The SAR measurements were conducted with dosimetric probe (manufactured by SATIMO), designed in the classical triangular configuration and optimized for dosimetric evaluation.

The first step of the field measurement is the evaluation of the voltages induced on the probe by the device under test. Probe diode detectors are nonlinear. Below the diode compression point, the output voltage is proportional to the square of the applied E-field; above the diode compression point, it is linear to the applied E-field. The compression point depends on the diode, and a calibration procedure is necessary for each sensor of the probe.

The Keithley multimeter reads the voltage of each sensor and send these three values to the PC. The corresponding E field value is calculated using the probe calibration factors, which are stored in the working directory. This evaluation includes linearization of the diode characteristics. The field calculation is done separately for each sensor. Each component of the E field is displayed on the "Dipole Area Scan Interface" and the total E field is displayed on the "3D Interface"

2.2. Robot

The SATIMO SAR system uses the high precision robots from KUKA. For the 6-axis controller system, the robot controller version (KUKA) from KUKA is used. The KUKA robot series have many features that are important for our application:



- High precision (repeatability ± 0.03 mm)
- High reliability (industrial design)
- Jerk-free straight movements
- Low ELF interference (the closed metallic construction shields against motor control fields)

2.3. E-Field Probe

This E-field detection probe is composed of three orthogonal dipoles linked to special Schottky diodes with low detection thresholds. The probe allows the measurement of electric fields in liquids such as the one defined in the IEEE and CENELEC standards.

For the measurements the Specific Dosimetric E-Field Probe SN 41/18 EPGO330 with following specifications is used



- Dynamic range: 0.01-100 W/kg
 - Tip Diameter: 2.5 mm
 - Distance between probe tip and sensor center: 1 mm
 - Distance between sensor center and the inner phantom surface: 2 mm (repeatability better than ± 1 mm).
 - Probe linearity: ± 0.10 dB
 - Axial isotropy: 0.06 dB
 - Hemispherical Isotropy: 0.09 dB
 - Calibration range: 650MHz to 5900MHz for head & body simulating liquid.
 - Lower detection limit: 9mW/kg
- Angle between probe axis (evaluation axis) and surface normal line: less than 30° .

2.3.1. E-Field Probe Calibration

Each probe needs to be calibrated according to a dosimetric assessment procedure with accuracy better than $\pm 10\%$. The spherical isotropy shall be evaluated and within ± 0.25 dB. The sensitivity parameters (Norm X, Norm Y, and Norm Z), the diode compression parameter (DCP) and the conversion factor (Conv F) of the probe are tested. The calibration data can be referred to appendix D of this report.

2.4. SAM phantoms

Photo of SAM phantom SN 16/15 SAM119



The SAM phantom is used to measure the SAR relative to people exposed to electro-magnetic field radiated by mobile phones.

2.4.1. Technical Data

Serial Number	Shell thickness	Filling volume	Dimensions	Positionner Material	Permittivity	Loss Tangent
SN 16/15 SAM119	2 mm ±0.2 mm	27 liters	Length:1000 mm Width:500 mm Height:200 mm	Gelcoat with fiberglass	3.4	0.02

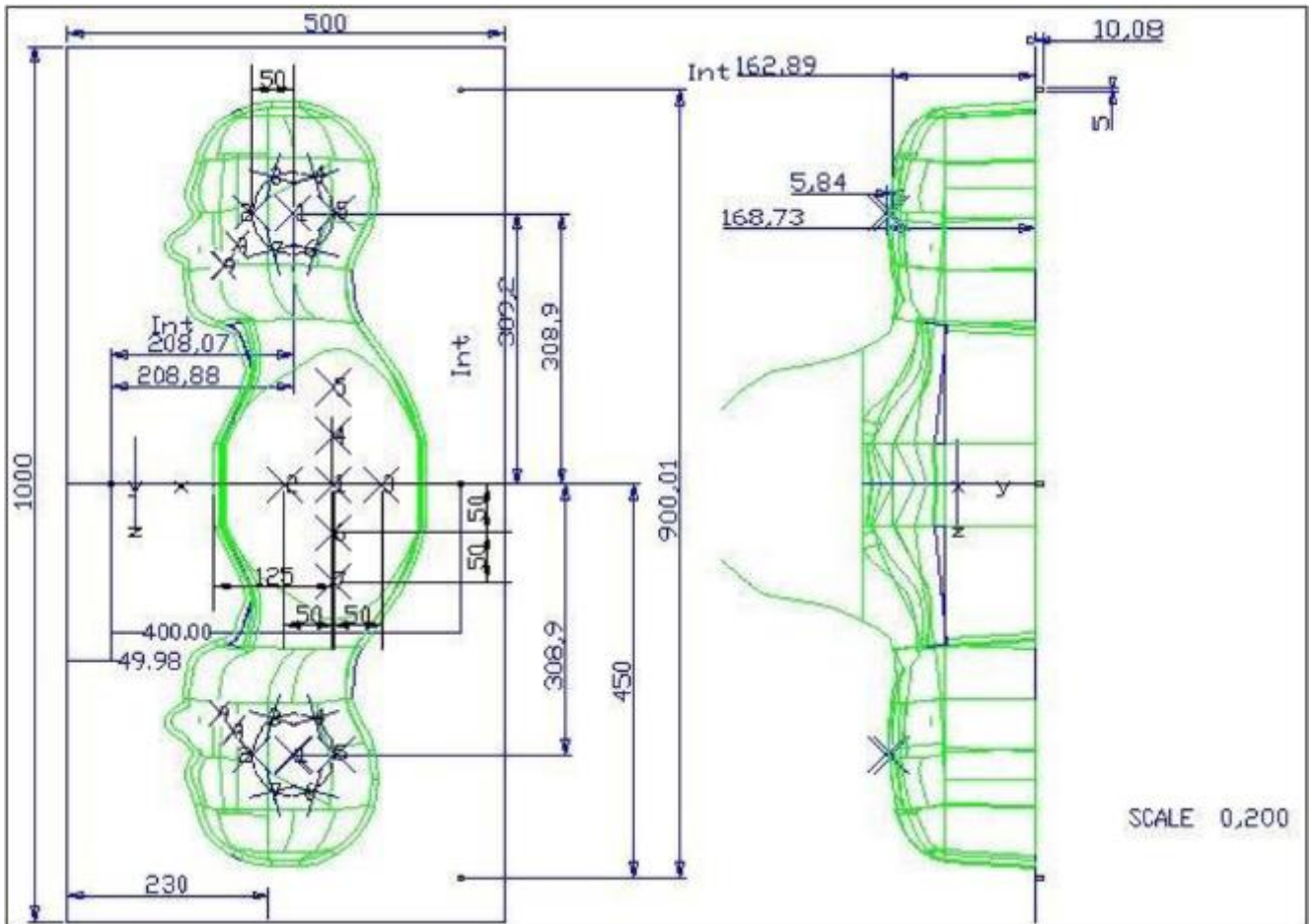

Serial Number	Left Head(mm)		Right Head(mm)		Flat Part(mm)	
	1	2	1	2	1	2
SN 16/15 SAM119	2	2.02	2	2.08	1	2.09
	3	2.05	3	2.06	2	2.06
	4	2.07	4	2.07	3	2.08
	5	2.08	5	2.08	4	2.10
	6	2.05	6	2.07	5	2.10
	7	2.05	7	2.05	6	2.07
	8	2.07	8	2.06	7	2.07
	9	2.08	9	2.06	-	-

The test, based on ultrasonic system, allows measuring the thickness with an accuracy of 10 µm.

2.5. Device Holder

The positioning system allows obtaining cheek and tilting position with a very good accuracy. In compliance with CENELEC, the tilt angle uncertainty is lower than 1 degree.

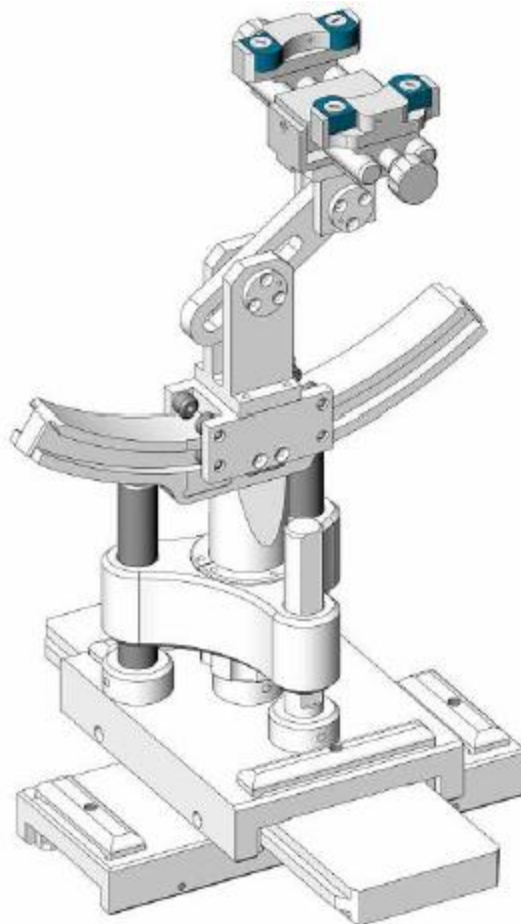

Serial Number	Holder Material	Permittivity	Loss Tangent
SN 16/15 MSH100	Delrin	3.7	0.005

2.6. Test Equipment List

This table gives a complete overview of the SAR measurement equipment.

Devices used during the test described are marked

	Manufacturer	Name of Equipment	Type/Model	Serial Number	Calibration	
					Last Cal.	Due Date
<input checked="" type="checkbox"/>	MVG	E FIELD PROBE	SSE2	SN 41/18 EPGO330	Sep. 21, 2020	Sep. 20, 2021
<input checked="" type="checkbox"/>	MVG	750 MHz Dipole	SID750	SN 03/15 DIP 0G750-355	Apr. 19, 2018	Apr. 18, 2021
<input checked="" type="checkbox"/>	MVG	835 MHz Dipole	SID835	SN 03/15 DIP 0G835-347	Apr. 19, 2018	Apr. 18, 2021
<input type="checkbox"/>	MVG	900 MHz Dipole	SID900	SN 03/15 DIP 0G900-348	Apr. 19, 2018	Apr. 18, 2021
<input checked="" type="checkbox"/>	MVG	1800 MHz Dipole	SID1800	SN 03/15 DIP 1G800-349	Apr. 19, 2018	Apr. 18, 2021
<input checked="" type="checkbox"/>	MVG	1900 MHz Dipole	SID1900	SN 03/15 DIP 1G900-350	Apr. 19, 2018	Apr. 18, 2021
<input type="checkbox"/>	MVG	2000 MHz Dipole	SID2000	SN 03/15 DIP 2G000-351	Apr. 19, 2018	Apr. 18, 2021
<input checked="" type="checkbox"/>	MVG	2450 MHz Dipole	SID2450	SN 03/15 DIP 2G450-352	Apr. 19, 2018	Apr. 18, 2021
<input checked="" type="checkbox"/>	MVG	2600 MHz Dipole	SID2600	SN 03/15 DIP 2G600-356	Apr. 19, 2018	Apr. 18, 2021
<input checked="" type="checkbox"/>	MVG	5000 MHz Dipole	SWG5500	SN 13/14 WGA 33	Apr. 19, 2018	Apr. 18, 2021
<input checked="" type="checkbox"/>	MVG	Liquid measurement Kit	SCLMP	SN 21/15 OCPG 72	NCR	NCR
<input checked="" type="checkbox"/>	MVG	Power Amplifier	N.A	AMPLISAR_28/14_003	NCR	NCR
<input checked="" type="checkbox"/>	KEITHLEY	Millivoltmeter	2000	4072790	NCR	NCR
<input checked="" type="checkbox"/>	R&S	Universal radio communication tester	CMU200	117858	Jul. 13, 2020	Jul. 12, 2021
<input checked="" type="checkbox"/>	R&S	Wideband radio communication tester	CMW500	103917	Jul. 13, 2020	Jul. 12, 2021
<input checked="" type="checkbox"/>	HP	Network Analyzer	8753D	3410J01136	Jul. 13, 2020	Jul. 12, 2021
<input checked="" type="checkbox"/>	Agilent	PSG Analog Signal Generator	E8257D	MY51110112	Jul. 13, 2020	Jul. 12, 2021

<input checked="" type="checkbox"/>	Agilent	Power meter	E4419B	MY45102538	Jul. 13, 2020	Jul. 12, 2021
<input checked="" type="checkbox"/>	Agilent	Power sensor	E9301A	MY41495644	Jul. 13, 2020	Jul. 12, 2021
<input checked="" type="checkbox"/>	Agilent	Power sensor	E9301A	US39212148	Jul. 13, 2020	Jul. 12, 2021
<input checked="" type="checkbox"/>	MCLI/USA	Directional Coupler	CB11-20	0D2L51502	Jul. 17, 2020	Jul. 16, 2023

3. SAR Measurement Procedures

The measurement procedures are as follows:

<Conducted power measurement>

- (a) For WWAN power measurement, use base station simulator to configure EUT WWAN transmission in conducted connection with RF cable, at maximum power in each supported wireless interface and frequency band.
- (b) Read the WWAN RF power level from the base station simulator.
- (c) For Wi-Fi/BT power measurement, use engineering software to configure EUT Wi-Fi/BT continuously transmission, at maximum RF power in each supported wireless interface and frequency band.
- (d) Connect EUT RF port through RF cable to the power meter, and measure Wi-Fi/BT output power.

<SAR measurement>

- (a) Use base station simulator to configure EUT WWAN transmission in radiated connection, and engineering software to configure EUT Wi-Fi/BT continuously transmission, at maximum RF power, in the highest power channel.
- (b) Place the EUT in the positions as Appendix A demonstrates.
- (c) Set scan area, grid size and other setting on the OPENSAR software.
- (d) Measure SAR results for the highest power channel on each testing position.
- (e) Find out the largest SAR result on these testing positions of each band.
- (f) Measure SAR results for other channels in worst SAR testing position if the reported SAR of highest power channel is larger than 0.8 W/kg.

According to the test standard, the recommended procedure for assessing the peak spatial-average SAR value consists of the following steps:

- (a) Power reference measurement
- (b) Area scan
- (c) Zoom scan
- (d) Power drift measurement

3.1. Power Reference

The Power Reference Measurement and Power Drift Measurements are for monitoring the power drift of the device under test in the batch process. The minimum distance of probe sensors to surface determines the closest measurement point to phantom surface. This distance cannot be smaller than the distance of sensor calibration points to probe tip as defined in the probe properties.

3.2. Area scan & Zoom scan

The area scan is a 2D scan to find the hot spot location on the DUT. The zoom scan is a 3D scan

above the hot spot to calculate the 1g and 10g SAR value.

Measurement of the SAR distribution with a grid of 8 to 16 mm * 8 to 16 mm and a constant distance to the inner surface of the phantom. Since the sensors cannot directly measure at the inner phantom surface, the values between the sensors and the inner phantom surface are extrapolated. With these values the area of the maximum SAR is calculated by an interpolation scheme. Around this point, a cube of 30 * 30 * 30 mm or 32 * 32 * 32 mm is assessed by measuring 5 or 8 * 5 or 8 * 4 or 5 mm. With these data, the peak spatial-average SAR value can be calculated.

From the scanned SAR distribution, identify the position of the maximum SAR value, in addition identify the positions of any local maxima with SAR values within 2 dB of the maximum value that will not be within the zoom scan of other peaks; additional peaks shall be measured only when the primary peak is within 2 dB of the SAR compliance limit (e.g., 1 W/kg for 1,6 W/kg 1 g limit, or 1,26 W/kg for 2 W/kg, 10 g limit).

Area scan & Zoom scan scan parameters extracted from FCC KDB 865664 D01 SAR measurement 100 MHz to 6 GHz.

		≤ 3 GHz	> 3 GHz	
Maximum distance from closest measurement point (geometric center of probe sensors) to phantom surface		5 ± 1 mm	½·δ·ln(2) ± 0.5 mm	
Maximum probe angle from probe axis to phantom surface normal at the measurement location		30° ± 1°	20° ± 1°	
Maximum area scan spatial resolution: Δx _{Area} , Δy _{Area}		≤ 2 GHz: ≤ 15 mm 2 – 3 GHz: ≤ 12 mm	3 – 4 GHz: ≤ 12 mm 4 – 6 GHz: ≤ 10 mm	
		When the x or y dimension of the test device, in the measurement plane orientation, is smaller than the above, the measurement resolution must be ≤ the corresponding x or y dimension of the test device with at least one measurement point on the test device.		
Maximum zoom scan spatial resolution: Δx _{Zoom} , Δy _{Zoom}		≤ 2 GHz: ≤ 8 mm 2 – 3 GHz: ≤ 5 mm*	3 – 4 GHz: ≤ 5 mm* 4 – 6 GHz: ≤ 4 mm*	
Maximum zoom scan spatial resolution, normal to phantom surface	uniform grid: Δz _{Zoom} (n)	≤ 5 mm	3 – 4 GHz: ≤ 4 mm 4 – 5 GHz: ≤ 3 mm 5 – 6 GHz: ≤ 2 mm	
	graded grid	Δz _{Zoom} (1): between 1 st two points closest to phantom surface	≤ 4 mm	3 – 4 GHz: ≤ 3 mm 4 – 5 GHz: ≤ 2.5 mm 5 – 6 GHz: ≤ 2 mm
		Δz _{Zoom} (n>1): between subsequent points	≤ 1.5·Δz _{Zoom} (n-1)	
Minimum zoom scan volume	x, y, z	≥ 30 mm	3 – 4 GHz: ≥ 28 mm 4 – 5 GHz: ≥ 25 mm 5 – 6 GHz: ≥ 22 mm	

Note: δ is the penetration depth of a plane-wave at normal incidence to the tissue medium; see draft standard IEEE P1528-2011 for details.

* When zoom scan is required and the *reported* SAR from the *area scan based 1-g SAR estimation* procedures of KDB 447498 is ≤ 1.4 W/kg, ≤ 8 mm, ≤ 7 mm and ≤ 5 mm zoom scan resolution may be applied, respectively, for 2 GHz to 3 GHz, 3 GHz to 4 GHz and 4 GHz to 6 GHz.

3.3. Description of interpolation/extrapolation scheme

The local SAR inside the phantom is measured using small dipole sensing elements inside a probe body. The probe tip must not be in contact with the phantom surface in order to minimise measurements errors, but the highest local SAR will occur at the surface of the phantom.

An extrapolation is using to determinate this highest local SAR values. The extrapolation is based on a fourth-order least-square polynomial fit of measured data. The local SAR value is then extrapolated from the liquid surface with a 1 mm step.

The measurements have to be performed over a limited time (due to the duration of the battery) so the step of measurement is high. It could vary between 5 and 8 mm. To obtain an accurate assessment of the maximum SAR averaged over 10 grams and 1 gram requires a very fine resolution in the three dimensional scanned data array.

3.4. Volumetric Scan

The volumetric scan consists to a full 3D scan over a specific area. This 3D scan is useful form multi Tx SAR measurement. Indeed, it is possible with OpenSAR to add, point by point, several volumetric scan to calculate the SAR value of the combined measurement as it is define in the standard IEEE1528 and IEC62209.

3.5. Power Drift

All SAR testing is under the EUT install full charged battery and transmit maximum output power. In OpenSAR measurement software, the power reference measurement and power drift measurement procedures are used for monitoring the power drift of EUT during SAR test. Both these procedures measure the field at a specified reference position before and after the SAR testing. The software will calculate the field difference in V/m. If the power drifts more than $\pm 5\%$, the SAR will be retested.

4. System Verification Procedure

4.1. Tissue Verification

The following tissue formulations are provided for reference only as some of the parameters have not been thoroughly verified. The composition of ingredients may be modified accordingly to achieve the desired target tissue parameters required for routine SAR evaluation.

Ingredients (% of weight)	Head Tissue									
	750	835	900	1800	1900	2000	2450	2600	5200	5800
Frequency Band (MHz)										
Water	34.40	34.40	34.40	55.36	55.36	57.87	57.87	57.87	65.53	65.53
NaCl	0.79	0.79	0.79	0.35	0.35	0.16	0.16	0.16	0.00	0.00
1,2-Propanediol	64.81	64.81	64.81	0.00	0.00	0.00	0.00	0.00	0.00	0.00
Triton X-100	0.00	0.00	0.00	30.45	30.45	19.97	19.97	19.97	24.24	24.24
DGBE	0.00	0.00	0.00	13.84	13.84	22.00	22.00	22.00	10.23	10.23

For SAR measurement of the field distribution inside the phantom, the phantom must be filled with homogeneous tissue simulating liquid to a depth of at least 15 cm. For head SAR testing, the liquid depth from the ear reference point (ERP) of the phantom to the liquid top surface is larger than 15 cm.

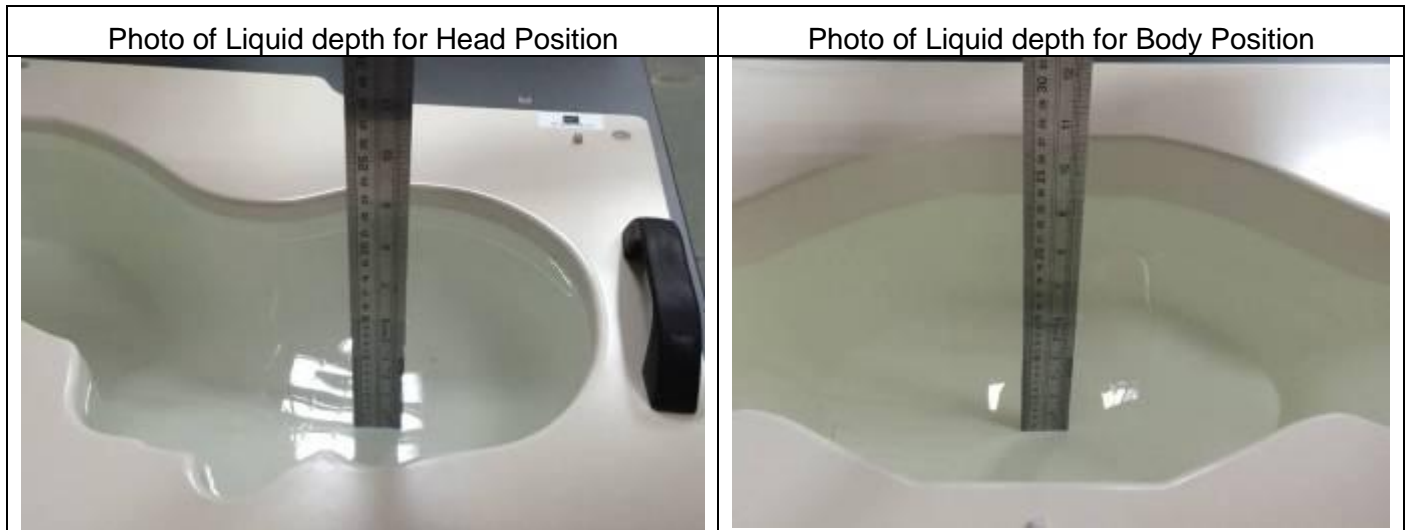

4.1.1. Tissue Dielectric Parameter Check Results

The simulating liquids should be checked at the beginning of a series of SAR measurements to determine if the dielectric parameters are within the tolerances of the specified target values. The measured conductivity and relative permittivity should be within $\pm 5\%$ of the target values.

Tissue Type	Measured Frequency (MHz)	Target Tissue		Measured Tissue		Liquid Temp.	Test Date
		ϵ_r ($\pm 5\%$)	σ (S/m) ($\pm 5\%$)	ϵ_r	σ (S/m)		
Head 750	750	41.96 (39.86~44.06)	0.89 (0.85~0.93)	42.41	0.91	21.5 °C	Feb. 20, 2021
Head 850	835	41.50 (39.43~43.58)	0.90 (0.86~0.95)	41.96	0.90	21.5 °C	Feb. 02, 2021
Head 1800	1800	40.00 (38.00~42.00)	1.40 (1.33~1.47)	39.74	1.40	21.7 °C	Feb. 26, 2021
Head 1900	1900	40.00 (38.00~42.00)	1.40 (1.33~1.47)	39.50	1.42	21.5 °C	Feb. 03, 2021
Head 2450	2450	39.20 (37.24~41.16)	1.80 (1.71~1.89)	39.54	1.84	21.5 °C	Feb. 02, 2021
Head 2600	2600	39.01 (37.06~40.96)	1.96 (1.86~2.06)	39.09	1.99	21.4 °C	Feb. 03, 2021
Head 5200	5200	36.00 (34.20~37.80)	4.66 (4.43~4.89)	37.08	4.59	21.5 °C	Feb. 06, 2021
Head 5800	5800	35.30 (33.54~37.07)	5.27 (5.01~5.53)	35.54	5.25	21.9 °C	Feb. 07, 2021

NOTE: The dielectric parameters of the tissue-equivalent liquid should be measured under similar ambient conditions and within 2 °C of the conditions expected during the SAR evaluation to satisfy protocol requirements.

4.2. System Verification Procedure

The system verification is performed for verifying the accuracy of the complete measurement system and performance of the software. The dipole is connected to the signal source consisting of signal generator and amplifier via a directional coupler, N-connector cable and adaption to SMA. It is fed with a power of 100mW (below 5GHz) or 100mW (above 5GHz). To adjust this power a power meter is used. The power sensor is connected to the cable before the system verification to measure the power at this point and do adjustments at the signal generator. At the outputs of the directional coupler both return loss as well as forward power are controlled during the system verification to make sure that emitted power at the dipole is kept constant. This can also be checked by the power drift measurement after the test (result on plot).

The system verification is shown as below picture:

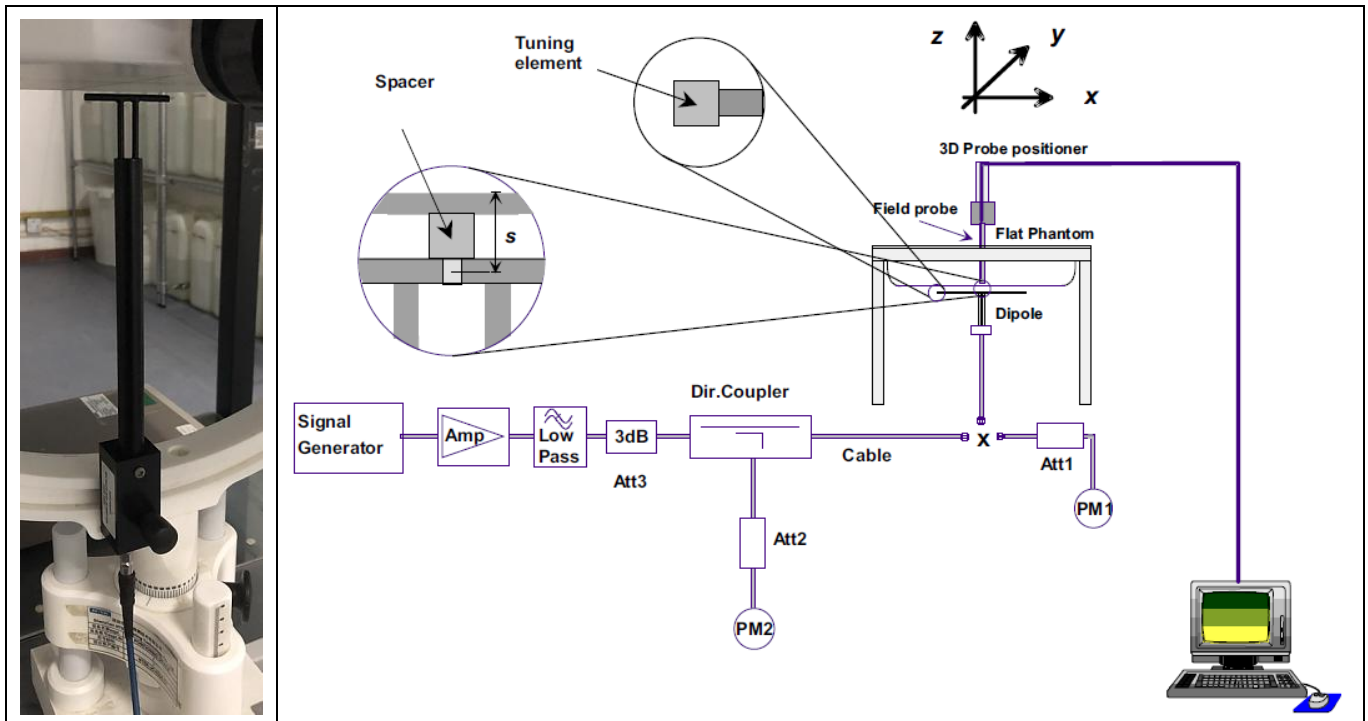

4.2.1. System Verification Results

Comparing to the original SAR value provided by SATIMO, the verification data should be within its specification of $\pm 10\%$. Below table shows the target SAR and measured SAR after normalized to 1W input power. The table below indicates the system performance verification can meet the variation criterion and the plots can be referred to Appendix B of this report.

System Verification	Target SAR (1W) ($\pm 10\%$)		Measured SAR (Normalized to 1W)		Liquid Temp.	Test Date
	1-g (W/Kg)	10-g (W/Kg)	1-g (W/Kg)	10-g (W/Kg)		
750MHz Head	8.56 (7.70~9.42)	5.55 (5.00~6.11)	8.53	5.66	21.5 °C	Feb. 20, 2021
835MHz Head	9.55 (8.60~10.51)	6.10 (5.49~6.71)	10.16	6.16	21.5 °C	Feb. 02, 2021
1800MHz Head	38.11 (34.30~41.92)	20.05 (18.05~22.06)	39.88	20.63	21.7 °C	Feb. 26, 2021
1900MHz Head	38.92 (35.03~42.81)	20.09 (18.08~22.10)	37.90	20.05	21.5 °C	Feb. 03, 2021
2450MHz Head	53.76 (48.38~59.14)	24.12 (21.71~26.53)	52.15	24.06	21.5 °C	Feb. 02, 2021
2600MHz Head	55.60 (50.04~61.16)	24.60 (22.14~27.06)	53.95	25.58	21.4 °C	Feb. 03, 2021
5200MHz Head	160.94 (144.85~177.03)	55.97 (50.37~61.57)	161.40	53.45	21.5 °C	Feb. 06, 2021
5800MHz Head	184.13 (165.72~202.54)	62.74 (56.47~69.01)	186.93	64.74	21.9 °C	Feb. 07, 2021

5. SAR Measurement variability and uncertainty

5.1. SAR measurement variability

Per KDB865664 D01 SAR measurement 100 MHz to 6 GHz, SAR measurement variability must be assessed for each frequency band, which is determined by the SAR probe calibration point and tissue-equivalent medium used for the device measurements. The additional measurements are repeated after the completion of all measurements requiring the same head or body tissue-equivalent medium in a frequency band. The test device should be returned to ambient conditions (normal room temperature) with the battery fully charged before it is re-mounted on the device holder for the repeated measurement(s) to minimize any unexpected variations in the repeated results.

- 1) Repeated measurement is not required when the original highest measured SAR is < 0.80 W/kg; steps 2) through 4) do not apply.
- 2) When the original highest measured SAR is ≥ 0.80 W/kg, repeat that measurement once.
- 3) Perform a second repeated measurement only if the ratio of largest to smallest SAR for the original and first repeated measurements is > 1.20 or when the original or repeated measurement is ≥ 1.45 W/kg (~ 10% from the 1-g SAR limit).
- 4) Perform a third repeated measurement only if the original, first or second repeated measurement is ≥ 1.5 W/kg and the ratio of largest to smallest SAR for the original, first and second repeated measurements is > 1.20 .

5.2. SAR measurement uncertainty

Per KDB865664 D01 SAR Measurement 100 MHz to 6 GHz, when the highest measured 1-g SAR within a frequency band is < 1.5 W/kg, the extensive SAR measurement uncertainty analysis described in IEEE Std 1528-2013 is not required in SAR reports submitted for equipment approval. The equivalent ratio (1.5/1.6) is applied to extremity and occupational exposure conditions.

6. RF Exposure Positions

6.1. Ear and handset reference point

Figure 6.1.1 shows the front, back, and side views of the SAM phantom. The center-of-mouth reference point is labeled “M”, the left ear reference point (ERP) is marked “LE”, and the right ERP is marked “RE”.

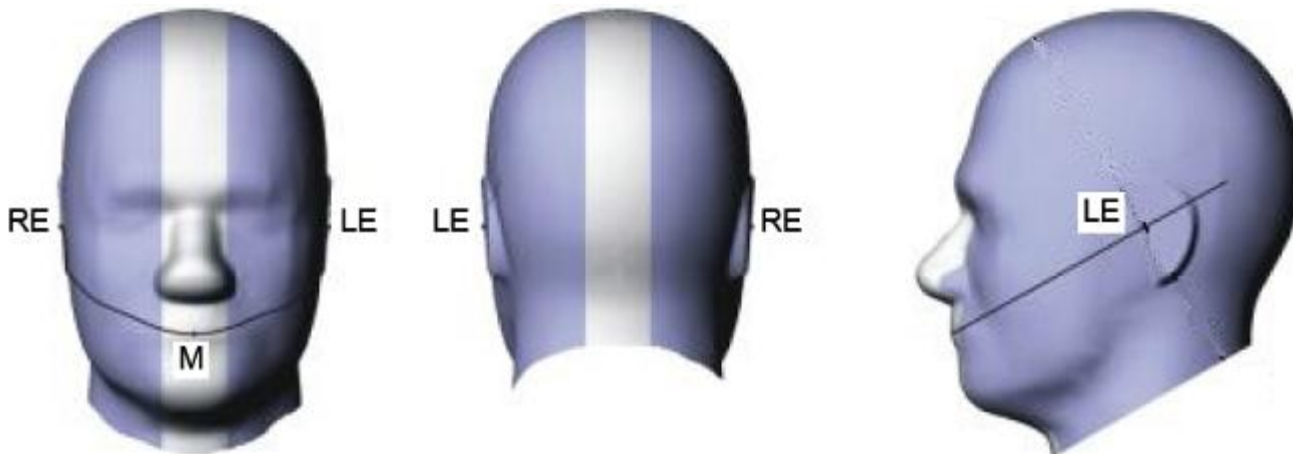

Fig 6.1.1 Front, back, and side views of SAM phantom

6.2. Definition of the cheek position

1. Define two imaginary lines on the handset, the vertical centerline and the horizontal line. The vertical centerline passes through two points on the front side of the handset: the midpoint of the width w_t of the handset at the level of the acoustic output (point A in Figure 6.2.1 and Figure 6.2.2), and the midpoint of the width w_b of the bottom of the handset (point B). The horizontal line is perpendicular to the vertical centerline and passes through the center of the acoustic output (see Figure 6.2.1). The two lines intersect at point A. Note that for many handsets, point A coincides with the center of the acoustic output; however, the acoustic output may be located elsewhere on the horizontal line. Also note that the vertical centerline is not necessarily parallel to the front face of the handset (see Figure 6.2.2), especially for clamshell handsets, handsets with flip covers, and other irregularly-shaped handsets.
2. Position the handset close to the surface of the phantom such that point A is on the (virtual) extension of the line passing through points RE and LE on the phantom (see Figure 6.2.3), such that the plane defined by the vertical centerline and the horizontal line of the handset is approximately parallel to the sagittal plane of the phantom.
3. Translate the handset towards the phantom along the line passing through RE and LE until handset point A touches the pinna at the ERP
4. While maintaining the handset in this plane, rotate it around the LE-RE line until the vertical centerline is in the plane normal to the plane containing B-M and N-F lines, i.e., the Reference Plane.
5. Rotate the handset around the vertical centerline until the handset (horizontal line) is parallel to the N-F line.

6. While maintaining the vertical centerline in the Reference Plane, keeping point A on the line passing through RE and LE, and maintaining the handset contact with the pinna, rotate the handset about the N-F line until any point on the handset is in contact with a phantom point below the pinna on the cheek. See Figure 6.2.3. The actual rotation angles should be documented in the test report.

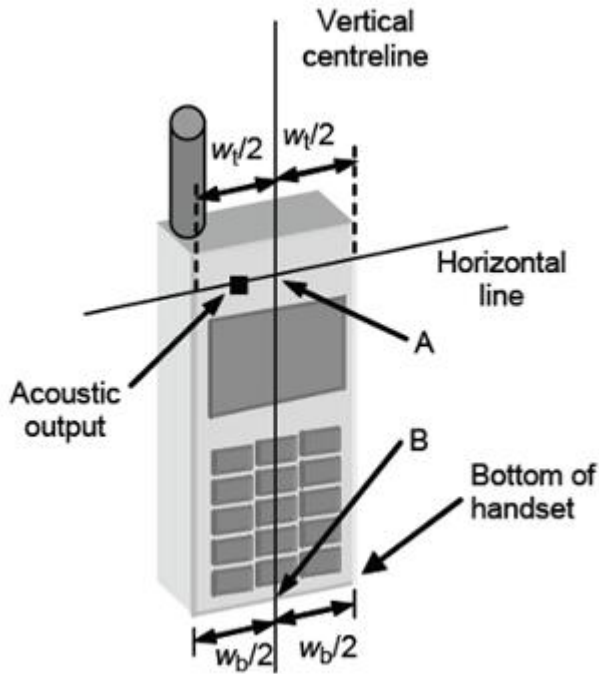

Fig 6.2.1 Handset vertical and horizontal reference lines—“fixed case”

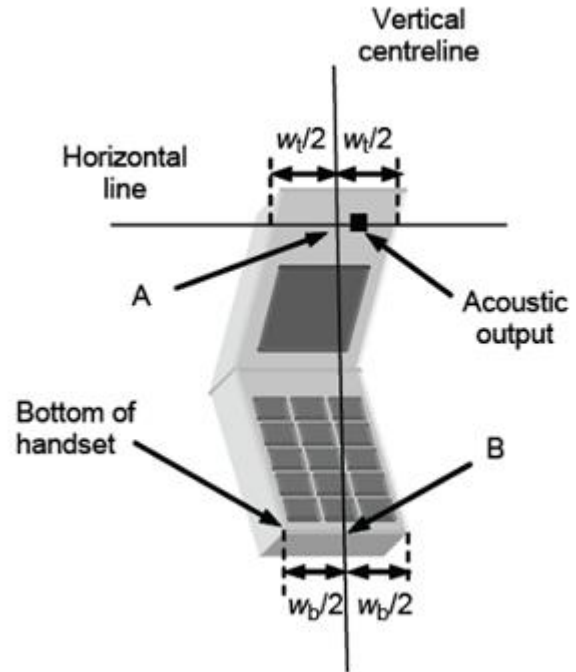

Fig 6.2.2 Handset vertical and horizontal reference lines—“clam-shell case”

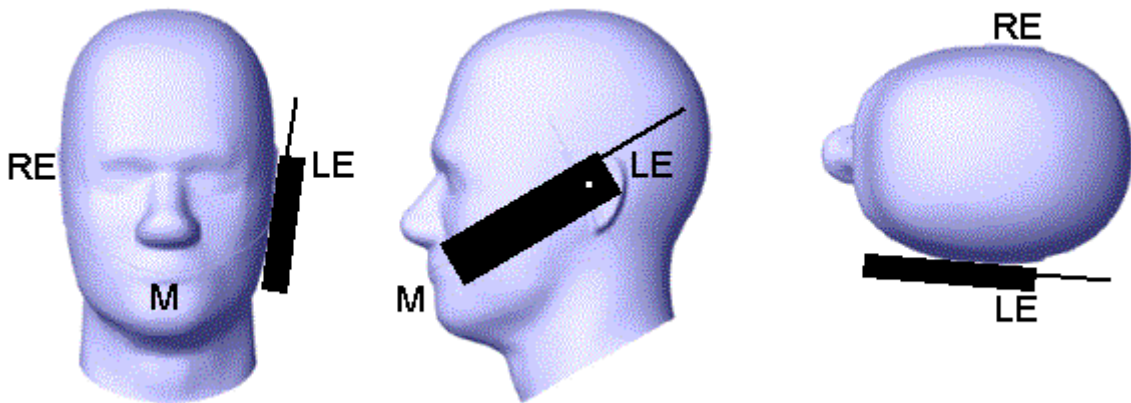

Fig 6.2.3 cheek or touch position. The reference points for the right ear (RE), left ear (LE), and mouth (M), which establish the Reference Plane for handset positioning, are indicated.

6.3. Definition of the tilt position

1. While maintaining the orientation of the handset, retract the handset parallel to the reference plane far enough away from the phantom to enable a rotation of the device by 15 degree.
2. Rotate the Handset around the horizontal line by 15 degree (see Figure 6.3.1).
3. While maintaining the orientation of the handset, move the handset towards the phantom on a line passing through RE and LE until any part of the handset touches the ear. The tilt position is obtained when the contact is on the pinna. If the contact is at any location other than the pinna, e.g., the antenna with the back of the phantom head, the angle of the handset shall be reduced. In this case, the tilt position is obtained if any part of the handset is in contact with the pinna as well as a second part of the handset is in contact with the phantom, e.g., the antenna with the back of the head.

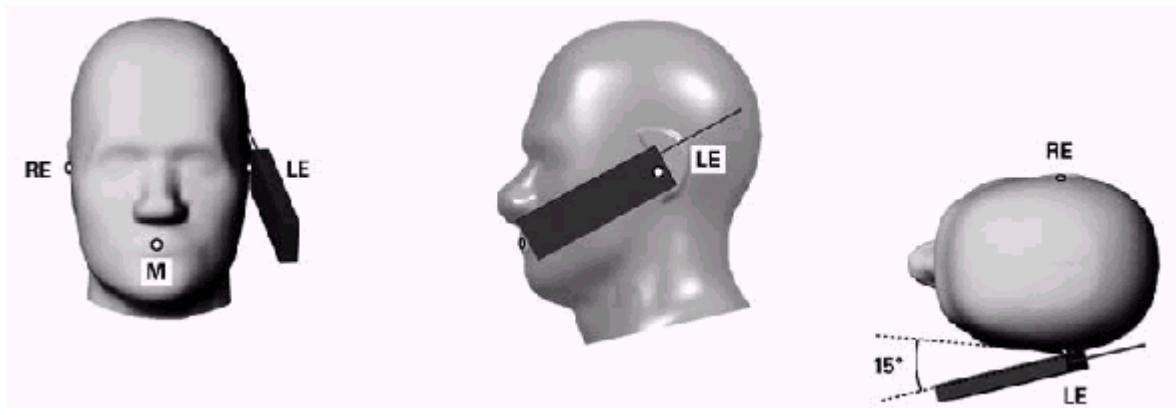

Figure 6.3.1 – Tilt position of the wireless device on the left side of SAM

6.4. Body Worn Accessory

1. Body-worn operating configurations are tested with the belt-clips and holsters attached to the device and positioned against a flat phantom in a normal use configuration (see Figure 6.4.1). Per KDB 648474 D04, body-worn accessory exposure is typically related to voice mode operations when handsets are carried in body-worn accessories. The body-worn accessory procedures in FCC KDB 447498 D01 should be used to test for body-worn accessory SAR compliance, without a headset connected to it. This enables the test results for such configuration to be compatible with that required for hotspot mode when the body-worn accessory test separation distance is greater than or equal to that required for hotspot mode, when applicable. When the reported SAR for body-worn accessory, measured without a headset connected to the handset is $< 1.2 \text{ W/kg}$, the highest reported SAR configuration for that wireless mode and frequency band should be repeated for that body-worn accessory with a handset attached to the handset.
2. Accessories for body-worn operation configurations are divided into two categories: those that do not contain metallic components and those that do contain metallic components and those that do contain metallic components. When multiple accessories that do not contain metallic components are supplied with the device, the device is tested with only the accessory that dictates the closest

spacing to the body. Then multiple accessories that contain metallic components are test with the device with each accessory. If multiple accessories share an identical metallic component (i.e. the same metallic belt-clip used with different holsters with no other metallic components) only the accessory that dictates the closest spacing to the body is tested.

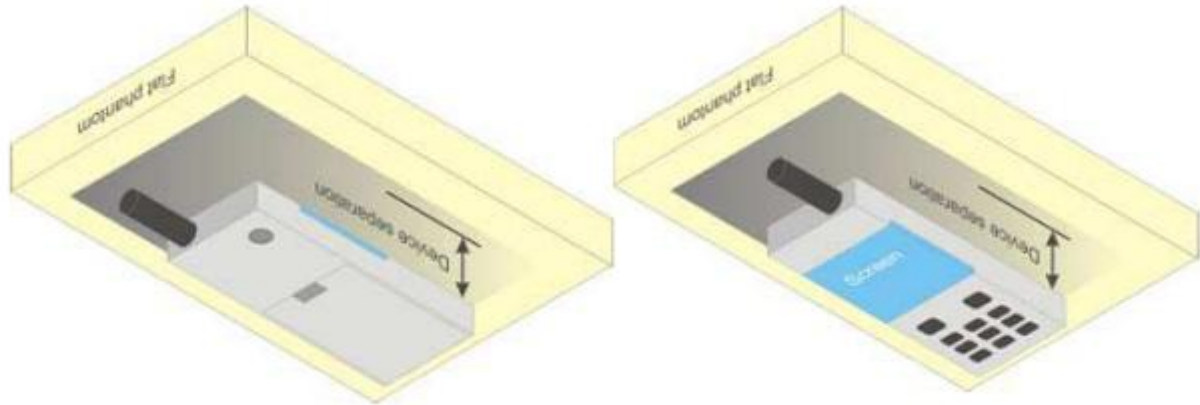

Figure 6.4.1 – Test positions for body-worn devices

6.5. Wireless Router Devices

Some battery-operated handsets have the capability to transmit and receive user through simultaneous transmission of WLAN simultaneously with a separate licensed transmitter. The FCC has provided guidance in FCC KDB Publication 941225 D06 where SAR test considerations for handsets ($L \times W \geq 9 \text{ cm} \times 5 \text{ cm}$) are based on a composite test separation distance of 10mm from the front, back and edges of the device containing transmitting antennas within 2.5cm of their edges, determined from general mixed use conditions for this type of devices. Since the hotspot SAR results may overlap with the body-worn accessory SAR requirements, the more conservative configurations can be considered, thus excluding some body-worn accessory SAR tests.

When the user enables the personal wireless router functions for the handset, actual operations include simultaneous transmission of both the WLAN transmitter and another licensed transmitter. Both transmitters often do not transmit at the same transmitting frequency and thus cannot be evaluated for SAR under actual use conditions due to the limitations of the SAR assessment probes. Therefore, SAR must be evaluated for each frequency transmission and mode separately and spatially summed with the WLAN transmitter according to FCC KDB Publication 447498 D01 publication procedures. The “Portable Hotspot” feature on the handset was NOT activated during SAR assessments, to ensure the SAR measurements were evaluated for a single transmission frequency RF signal at a time.

7. RF Output Power

7.1. GSM Conducted Power

Band GSM850		Burst-Averaged output Power (dBm)			Frame-Averaged output Power (dBm)			
Tx Channel	Tune-up (dBm)	128	189	251	Tune-up	128	189	251
Frequency (MHz)		824.2	836.4	848.8	(dBm)	824.2	836.4	848.8
GSM (GMSK)	33.00	32.85	32.69	32.65	23.97	23.82	23.66	23.62
GPRS(GMSK, 1 TS)	33.00	32.84	32.66	32.62	23.97	23.81	23.63	23.59
GPRS(GMSK, 2 TS)	32.50	32.06	31.92	31.85	26.48	26.04	25.90	25.83
GPRS(GMSK, 3 TS)	30.50	30.28	30.20	30.07	26.24	26.02	25.94	25.81
GPRS(GMSK, 4 TS)	29.50	29.26	29.18	29.04	26.49	26.25	26.17	26.03
EDGE(GMSK, 1 TS)	26.00	25.87	25.83	25.23	16.97	16.84	16.80	16.20
EDGE(GMSK, 2 TS)	25.00	24.80	24.45	24.03	18.98	18.78	18.43	18.01
EDGE(GMSK, 3 TS)	23.00	22.84	22.64	22.41	18.74	18.58	18.38	18.15
EDGE(GMSK, 4 TS)	22.00	21.55	21.52	21.31	18.99	18.54	18.51	18.30
Band GSM1900		Burst-Averaged output Power (dBm)			Frame-Averaged output Power (dBm)			
Tx Channel	Tune-up (dBm)	512	661	810	Tune-up	512	661	810
Frequency (MHz)		1850.2	1880.0	1909.8	(dBm)	1850.2	1880.0	1909.8
GSM (GMSK)	30.50	29.29	29.83	30.27	21.47	20.26	20.80	21.24
GPRS(GMSK, 1 TS)	30.50	29.28	29.81	30.26	21.47	20.25	20.78	21.23
GPRS(GMSK, 2 TS)	29.50	28.45	28.98	29.47	23.48	22.43	22.96	23.45
GPRS(GMSK, 3 TS)	28.00	26.53	27.08	27.67	23.74	22.27	22.82	23.41
GPRS(GMSK, 4 TS)	27.00	25.41	25.99	26.56	23.99	22.40	22.98	23.55
EDGE(GMSK, 1 TS)	27.00	25.68	25.80	26.73	17.97	16.65	16.77	17.70
EDGE(GMSK, 2 TS)	26.00	24.74	25.08	25.58	19.98	18.72	19.06	19.56
EDGE(GMSK, 3 TS)	24.00	23.01	23.08	23.82	19.74	18.75	18.82	19.56
EDGE(GMSK, 4 TS)	23.00	21.87	22.08	22.50	19.99	18.86	19.07	19.49

Note: The frame-averaged power is linearly scaled the maximum burst averaged power over 8 time slots.

The calculated method are shown as below:

Frame-averaged power = Maximum burst averaged power (1 TS) - 9.03 dB

Frame-averaged power = Maximum burst averaged power (2 TS) - 6.02 dB

Frame-averaged power = Maximum burst averaged power (3 TS) - 4.26 dB

Frame-averaged power = Maximum burst averaged power (4 TS) - 3.01 dB

7.2. WCDMA Conducted Power

Band		WCDMA Band 2		
Tx Channel	Tune-up	9262	9400	9538
Frequency (MHz)		1852.4	1880	1907.6
RMC 12.2Kbps	23.50	23.14	23.13	22.59
HSDPA Subtest-1	22.50	22.23	22.20	21.65
HSDPA Subtest-2	22.00	21.91	21.72	21.25
HSDPA Subtest-3	21.00	20.42	20.88	20.29
HSDPA Subtest-4	21.00	20.89	20.92	19.88
HSUPA Subtest-1	22.00	21.19	21.97	21.57
HSUPA Subtest-2	22.50	22.23	22.12	21.58
HSUPA Subtest-3	21.50	20.43	21.04	20.49
HSUPA Subtest-4	22.50	22.22	22.20	21.67
HSUPA Subtest-5	22.00	20.91	21.51	20.88
Band		WCDMA Band 4		
Tx Channel	Tune-up	1312	1413	1513
Frequency (MHz)		1712.4	1732.6	1752.6
RMC 12.2Kbps	23.50	23.36	23.25	23.23
HSDPA Subtest-1	22.50	22.41	22.30	22.33
HSDPA Subtest-2	22.50	22.01	21.86	21.90
HSDPA Subtest-3	21.50	21.06	20.82	20.94
HSDPA Subtest-4	21.00	20.74	20.96	20.89
HSUPA Subtest-1	22.50	21.01	22.13	22.10
HSUPA Subtest-2	22.50	22.31	22.19	22.22
HSUPA Subtest-3	21.50	20.57	21.00	21.04
HSUPA Subtest-4	22.50	22.43	22.30	22.31
HSUPA Subtest-5	22.00	20.98	21.60	21.60
Band		WCDMA Band 5		
Tx Channel	Tune-up	4132	4182	4233
Frequency (MHz)		826.4	836.4	846.6
RMC 12.2Kbps	23.00	22.72	22.73	22.86
HSDPA Subtest-1	22.00	21.80	21.76	21.86
HSDPA Subtest-2	21.50	21.38	21.43	21.45
HSDPA Subtest-3	21.00	20.36	20.43	20.56
HSDPA Subtest-4	20.50	20.02	20.36	20.03
HSUPA Subtest-1	22.00	21.03	21.54	21.67
HSUPA Subtest-2	22.00	21.63	21.69	21.80
HSUPA Subtest-3	21.00	19.85	20.50	20.66
HSUPA Subtest-4	22.00	21.77	21.77	21.86

HSUPA Subtest-5	21.50	20.29	21.06	21.12
-----------------	-------	-------	-------	-------

7.3. LTE Conducted Power

Band	Band Width	Modulation	RB Configuration		Tune-up	Channel/Frequency(MHz)		
			RB Size	RB Offset		18607/1850.7	18900/1880	19193/1909.3
LTE Band 2	1.4MHz	QPSK	1	0	23.50	23.16	23.04	22.47
			1	2	23.50	23.32	23.14	22.59
			1	5	23.50	23.17	23.01	22.46
			3	0	23.50	23.20	23.10	22.57
			3	1	23.50	23.22	23.13	22.54
			3	2	23.50	23.20	23.12	22.50
		16QAM	1	0	22.50	22.26	22.19	21.30
			1	2	22.50	22.38	22.33	21.47
			1	5	22.50	22.24	22.20	21.30
			3	0	22.50	22.29	22.31	21.66
			3	1	22.50	22.37	22.31	21.67
			3	2	22.50	22.28	22.29	21.68
			6	0	21.50	21.38	21.28	20.74
Band	Band Width	Modulation	RB Configuration		Tune-up	Channel/Frequency(MHz)		
			RB Size	RB Offset		18615/1851.5	18900/1880	19185/1908.5
LTE Band 2	3MHz	QPSK	1	0	23.50	23.17	23.08	22.47
			1	7	23.50	23.44	23.31	22.69
			1	14	23.50	23.20	23.00	22.45
			8	0	22.50	22.15	22.09	21.49
			8	4	22.50	22.16	22.09	21.53
			8	7	22.50	22.20	22.06	21.48
			15	0	22.50	22.13	22.04	21.47
		16QAM	1	0	23.00	22.01	22.45	21.68
			1	7	23.00	22.27	22.73	21.95
			1	14	23.00	21.96	22.37	21.58
			8	0	21.50	21.18	21.10	20.54
			8	4	21.50	21.17	21.13	20.53
			8	7	21.50	21.17	21.11	20.49
			15	0	21.50	21.19	21.06	20.46

Band	Band Width	Modulation	RB Configuration		Tune-up	Channel/Frequency(MHz)		
			RB Size	RB Offset		18625/1852.5	18900/1880	19175/1907.5
LTE Band 2	5MHz	QPSK	1	0	23.50	23.00	23.02	22.45
			1	12	23.50	23.26	23.41	22.82
			1	24	23.50	23.01	22.93	22.40
			12	0	22.50	22.04	22.03	21.51
			12	6	22.50	22.20	22.08	21.54
			12	11	22.50	22.15	22.03	21.46
			25	0	22.50	22.14	22.05	21.47
		16QAM	1	0	23.00	22.32	22.44	21.74
			1	12	23.00	22.71	22.83	22.07
			1	24	23.00	22.27	22.36	21.70
			12	0	21.50	21.11	21.06	20.49
			12	6	21.50	21.21	21.11	20.50
			12	11	21.50	21.20	21.05	20.36
			25	0	21.50	21.12	21.05	20.55
Band	Band Width	Modulation	RB Configuration		Tune-up	Channel/Frequency(MHz)		
			RB Size	RB Offset		18650/1855	18900/1880	19150/1905
LTE Band 2	10MHz	QPSK	1	0	23.50	23.22	23.13	22.65
			1	24	23.50	23.33	23.16	22.63
			1	49	23.50	23.23	23.00	22.42
			25	0	22.50	22.10	22.11	21.58
			25	12	22.50	22.15	22.07	21.56
			25	24	22.50	22.24	22.12	21.42
			50	0	22.50	22.12	22.07	21.53
		16QAM	1	0	23.00	21.98	22.48	21.76
			1	24	23.00	22.04	22.53	21.79
			1	49	23.00	21.99	22.32	21.63
			25	0	21.50	21.08	21.16	20.61
			25	12	21.50	21.16	21.14	20.60
			25	24	21.50	21.27	21.13	20.52
			50	0	21.50	21.14	21.09	20.54
Band	Band Width	Modulation	RB Configuration		Tune-up	Channel/Frequency(MHz)		
			RB Size	RB Offset		18675/1857.5	18900/1880	19125/1902.5

LTE Band 2	15MHz	QPSK	1	0	23.50	23.11	23.09	22.73
			1	37	23.50	23.34	23.22	22.83
			1	74	23.50	22.97	22.81	22.34
			36	0	22.50	22.20	22.16	21.74
			36	18	22.50	22.30	22.17	21.69
			36	37	22.50	22.26	22.14	21.59
			75	0	22.50	22.24	22.14	21.64
		16QAM	1	0	23.00	22.21	22.41	21.95
			1	37	23.00	22.53	22.73	22.01
			1	74	23.00	22.13	22.16	21.54
			36	0	21.50	21.12	21.15	20.86
			36	18	21.50	21.22	21.18	20.73
			36	37	21.50	21.20	21.13	20.62
			75	0	21.50	21.24	21.13	20.63
Band	Band Width	Modulation	RB Configuration		Tune-up	Channel/Frequency(MHz)		
			RB Size	RB Offset		18700/1860	18900/1880	19100/1900
LTE Band 2	20MHz	QPSK	1	0	23.50	22.92	22.93	22.72
			1	49	23.50	23.27	23.22	22.82
			1	99	23.50	22.89	22.71	22.21
			50	0	22.50	22.03	22.01	21.95
			50	24	22.50	22.18	22.09	21.74
			50	49	22.50	22.10	22.03	21.63
			100	0	22.50	22.08	22.05	21.78
		16QAM	1	0	22.50	22.12	22.11	21.99
			1	49	22.50	22.43	22.38	22.13
			1	99	22.50	22.14	21.90	21.55
			50	0	21.50	20.99	21.10	20.98
			50	24	21.50	21.25	21.14	20.82
			50	49	21.50	21.13	21.12	20.71
			100	0	21.50	21.12	21.11	20.82

Band	Band Width	Modulation	RB Configuration		Tune-up	Channel/Frequency(MHz)		
			RB Size	RB Offset		19957/1710.7	20175/1732.5	20393/1754.3
LTE Band 4	1.4MHz	QPSK	1	0	24.00	22.90	23.34	23.17
			1	2	24.00	24.00	23.52	23.29
			1	5	24.00	23.87	23.34	23.17

Band	Band Width	Modulation	RB Configuration		Tune-up	Channel/Frequency(MHz)		
			RB Size	RB Offset		19965/1711.5	20175/1732.5	20385/1753.5
			3	0	24.00	23.95	23.42	23.22
			3	1	24.00	23.96	23.44	23.28
			3	2	24.00	23.95	23.42	23.28
			6	0	23.00	22.93	22.35	22.24
		16QAM	1	0	23.00	22.65	22.46	22.36
			1	2	23.00	22.78	22.61	22.42
			1	5	23.00	22.67	22.46	22.34
			3	0	23.00	22.59	22.51	22.44
			3	1	23.00	22.55	22.53	22.44
			3	2	23.00	22.59	22.52	22.43
6	0	22.00	21.64	21.59	21.42			
LTE Band 4	3MHz	QPSK	1	0	24.00	23.40	23.36	23.23
			1	7	24.00	23.72	23.46	23.46
			1	14	24.00	23.43	23.28	23.20
			8	0	22.50	22.40	22.35	22.20
			8	4	22.50	22.43	22.38	22.23
			8	7	22.50	22.39	22.34	22.23
			15	0	22.50	22.38	22.31	22.17
		16QAM	1	0	23.00	22.23	22.71	22.41
			1	7	23.00	22.46	22.88	22.65
			1	14	23.00	22.22	22.68	22.34
			8	0	21.50	21.39	21.39	21.24
			8	4	21.50	21.44	21.42	21.27
			8	7	21.50	21.42	21.38	21.22
			15	0	21.50	21.45	21.36	21.18
Band	Band Width	Modulation	RB Configuration		Tune-up	Channel/Frequency(MHz)		
			RB Size	RB Offset		19975/1712.5	20175/1732.5	20375/1752.5
LTE Band 4	5MHz	QPSK	1	0	24.00	23.23	23.26	23.15
			1	12	24.00	23.56	23.41	23.48
			1	24	24.00	23.21	23.23	23.14
			12	0	22.50	22.38	22.38	22.26
			12	6	22.50	22.42	22.35	22.27
			12	11	22.50	22.36	22.32	22.18
			25	0	22.50	22.39	22.34	22.21

Band	Band Width	Modulation	RB Configuration		Tune-up	Channel/Frequency(MHz)		
			RB Size	RB Offset		20000/1715	20175/1732.5	20350/1750
LTE Band 4	10MHz	16QAM	1	0	23.50	22.51	22.68	22.42
			1	12	23.50	22.89	23.07	22.70
			1	24	23.50	22.53	22.67	22.38
			12	0	21.50	21.40	21.35	21.19
			12	6	21.50	21.49	21.38	21.20
			12	11	21.50	21.43	21.33	21.15
			25	0	21.50	21.41	21.33	21.22
LTE Band 4	10MHz	QPSK	1	0	24.00	22.42	23.28	23.20
			1	24	24.00	23.49	23.44	23.28
			1	49	24.00	24.00	23.31	23.18
			25	0	22.50	22.40	22.36	22.28
			25	12	22.50	22.42	22.36	22.21
			25	24	22.50	22.45	22.36	22.25
		16QAM	50	0	22.50	22.41	22.35	22.22
			1	0	23.00	22.19	22.67	22.36
			1	24	23.00	22.34	22.76	22.44
			1	49	23.00	22.20	22.68	22.33
			25	0	21.50	21.46	21.39	21.32
			25	12	21.50	21.47	21.41	21.24
			25	24	21.50	21.48	21.43	21.22
			50	0	21.50	21.45	21.38	21.28
Band	Band Width	Modulation	RB Configuration		Tune-up	Channel/Frequency(MHz)		
			RB Size	RB Offset		20025/1717.5	20175/1732.5	20325/1747.5
LTE Band 4	15MHz	QPSK	1	0	24.00	23.26	23.25	23.19
			1	37	24.00	23.57	23.63	23.36
			1	74	24.00	23.23	23.19	23.09
			36	0	22.50	22.42	22.42	22.32
			36	18	22.50	22.47	22.43	22.27
			36	37	22.50	22.43	22.34	22.28
		16QAM	75	0	22.50	22.46	22.41	22.30
			1	0	23.00	22.34	22.60	22.33
			1	37	23.00	22.60	22.87	22.53
			1	74	23.00	22.34	22.55	22.22
			36	0	21.50	21.38	21.39	21.39

Band	Band Width	Modulation	RB Configuration		Tune-up	Channel/Frequency(MHz)		
			RB Size	RB Offset		20050/1720	20175/1732.5	20300/1745
			36	18		21.50	21.40	21.42
36	37	21.50	21.40	21.35	21.30			
75	0	21.50	21.47	21.38	21.25			
LTE Band 4	20MHz	QPSK	1	0	24.00	23.08	23.11	23.08
			1	49	24.00	23.40	24.00	23.36
			1	99	24.00	23.10	23.07	22.97
			50	0	22.50	22.28	22.28	22.35
			50	24	22.50	22.34	22.34	22.28
			50	49	22.50	22.36	22.24	22.16
			100	0	22.50	22.31	22.23	22.25
		16QAM	1	0	23.00	22.30	22.25	22.34
			1	49	23.00	22.63	22.63	22.63
			1	99	23.00	22.29	22.23	22.22
			50	0	21.50	21.32	21.34	21.39
			50	24	21.50	21.39	21.40	21.32
			50	49	21.50	21.39	21.28	21.25
			100	0	21.50	21.35	21.30	21.28

Band	Band Width	Modulation	RB Configuration		Tune-up	Channel/Frequency(MHz)		
			RB Size	RB Offset		20407/824.7	20525/836.5	20643/848.3
LTE Band 5	1.4MHz	QPSK	1	0	23.50	21.92	22.84	22.82
			1	2	23.50	23.09	22.95	22.98
			1	5	23.50	22.86	22.83	22.90
			3	0	23.00	22.92	22.84	22.90
			3	1	23.00	22.87	22.85	22.94
			3	2	23.00	22.85	22.84	22.95
			6	0	22.00	21.91	21.80	21.93
		16QAM	1	0	22.50	21.62	21.91	22.03
			1	2	22.50	21.77	22.00	22.10
			1	5	22.50	21.58	21.89	21.98
			3	0	22.50	21.88	21.99	22.08
			3	1	22.50	21.94	22.00	22.10
			3	2	22.50	21.91	21.97	22.07
			6	0	21.50	21.01	20.95	21.02

Band	Band Width	Modulation	RB Configuration		Tune-up	Channel/Frequency(MHz)		
			RB Size	RB Offset		20415/825.5	20525/836.5	20635/847.5
LTE Band 5	3MHz	QPSK	1	0	23.50	22.97	22.84	22.87
			1	7	23.50	23.28	23.06	23.20
			1	14	23.50	22.97	22.73	22.97
			8	0	22.00	21.90	21.84	21.85
			8	4	22.00	21.89	21.84	21.91
			8	7	22.00	21.87	21.80	21.86
			15	0	22.00	21.78	21.75	21.87
		16QAM	1	0	22.50	21.65	22.25	22.04
			1	7	22.50	21.83	22.42	22.38
			1	14	22.50	21.62	22.11	22.00
			8	0	21.00	20.82	20.78	20.87
			8	4	21.00	20.79	20.85	20.90
			8	7	21.00	20.76	20.83	20.83
			15	0	21.00	20.86	20.80	20.84
Band	Band Width	Modulation	RB Configuration		Tune-up	Channel/Frequency(MHz)		
			RB Size	RB Offset		20425/826.5	20525/836.5	20625/846.5
LTE Band 5	5MHz	QPSK	1	0	23.50	22.82	22.69	22.82
			1	12	23.50	23.27	23.07	23.19
			1	24	23.50	22.84	22.72	22.90
			12	0	22.00	21.82	21.84	21.83
			12	6	22.00	21.87	21.84	21.92
			12	11	22.00	21.75	21.79	21.86
			25	0	22.00	21.80	21.80	21.89
		16QAM	1	0	23.00	22.00	22.00	22.23
			1	12	23.00	22.42	22.37	22.76
			1	24	23.00	21.98	21.96	22.21
			12	0	21.00	20.78	20.81	20.80
			12	6	21.00	20.76	20.87	20.89
			12	11	21.00	20.67	20.82	20.84
			25	0	21.00	20.77	20.78	20.87
Band	Band Width	Modulation	RB Configuration		Tune-up	Channel/Frequency(MHz)		
			RB Size	RB Offset		20450/829	20525/836.5	20600/844

LTE Band 5	10MHz	QPSK	1	0	23.50	22.95	22.84	22.85
			1	24	23.50	23.03	22.95	22.99
			1	49	23.50	22.92	22.90	22.95
			25	0	22.00	21.90	21.82	21.97
			25	12	22.00	21.81	21.86	21.89
			25	24	22.00	21.83	21.84	21.88
			50	0	22.00	21.87	21.78	21.96
		16QAM	1	0	22.50	21.93	21.60	22.18
			1	24	22.50	21.97	21.79	22.27
			1	49	22.50	21.96	21.63	22.22
			25	0	21.00	20.84	20.82	20.98
			25	12	21.00	20.78	20.82	20.88
			25	24	21.00	20.82	20.82	20.90
			50	0	21.00	20.84	20.80	20.96

Band	Band Width	Modulation	RB Configuration		Tune-up	Channel/Frequency(MHz)		
			RB Size	RB Offset		20775/2502.5	21100/2535	21425/2567.5
LTE Band 7	5MHz	QPSK	1	0	24.00	23.37	23.19	23.27
			1	12	24.00	23.65	23.55	23.77
			1	24	24.00	23.28	23.18	23.38
			12	0	22.50	22.37	22.25	22.37
			12	6	22.50	22.45	22.31	22.45
			12	11	22.50	22.41	22.27	22.33
			25	0	22.50	22.43	22.25	22.39
		16QAM	1	0	23.50	22.77	22.43	22.47
			1	12	23.50	23.07	22.77	22.84
			1	24	23.50	22.74	22.42	22.53
			12	0	21.50	21.36	21.17	21.37
			12	6	21.50	21.47	21.27	21.47
			12	11	21.50	21.42	21.21	21.38
			25	0	21.50	21.40	21.31	21.33
Band	Band Width	Modulation	RB Configuration		Tune-up	Channel/Frequency(MHz)		
			RB Size	RB Offset		20800/2505	21100/2535	21400/2565

LTE Band 7	10MHz	QPSK	1	0	24.00	23.51	23.30	23.27
			1	24	24.00	23.63	23.44	23.47
			1	49	24.00	23.43	23.31	23.44
			25	0	22.50	22.42	22.27	22.29
			25	12	22.50	22.47	22.31	22.37
			25	24	22.50	22.41	22.33	22.37
			50	0	22.50	22.38	22.28	22.33
		16QAM	1	0	23.00	22.55	22.13	22.61
			1	24	23.00	22.65	22.23	22.82
			1	49	23.00	22.46	22.10	22.71
			25	0	21.50	21.47	21.29	21.35
			25	12	21.50	21.46	21.31	21.44
			25	24	21.50	21.44	21.39	21.43
			50	0	21.50	21.45	21.30	21.37
Band	Band Width	Modulation	RB Configuration		Tune-up	Channel/Frequency(MHz)		
			RB Size	RB Offset		20825/2507.5	21100/2535	21375/2562.5
LTE Band 7	15MHz	QPSK	1	0	24.00	23.49	23.18	23.21
			1	37	24.00	23.69	23.43	23.60
			1	74	24.00	23.25	23.12	23.35
			36	0	22.50	22.49	22.34	22.38
			36	18	22.50	22.47	22.37	22.46
			36	37	22.50	22.41	22.34	22.49
			75	0	22.50	22.44	22.34	22.39
		16QAM	1	0	23.00	22.52	22.30	22.55
			1	37	23.00	22.75	22.63	22.92
			1	74	23.00	22.38	22.24	22.64
			36	0	22.00	21.51	21.29	21.35
			36	18	22.00	21.53	21.33	21.46
			36	37	22.00	21.44	21.32	21.50
			75	0	21.50	21.42	21.36	21.41
Band	Band Width	Modulation	RB Configuration		Tune-up	Channel/Frequency(MHz)		
			RB Size	RB Offset		20850/2510	21100/2535	21350/2560

LTE Band 7	20MHz	QPSK	1	0	24.00	23.24	23.06	23.03
			1	49	24.00	24.00	23.40	23.44
			1	99	24.00	23.07	23.11	23.30
			50	0	22.50	22.36	22.18	22.25
			50	24	22.50	22.37	22.30	22.38
			50	49	22.50	22.23	22.22	22.39
			100	0	22.50	22.26	22.22	22.35
		16QAM	1	0	23.00	22.41	22.31	22.21
			1	49	23.00	22.67	22.62	22.59
			1	99	23.00	22.25	22.36	22.41
			50	0	21.50	21.40	21.20	21.28
			50	24	21.50	21.42	21.33	21.37
			50	49	21.50	21.29	21.30	21.39
			100	0	21.50	21.33	21.25	21.30

Band	Band Width	Modulation	RB Configuration		Tune-up	Channel/Frequency(MHz)		
			RB Size	RB Offset		23017/699.7	23095/707.5	23173/715.3
LTE Band 12	1.4MHz	QPSK	1	0	23.00	21.79	22.42	22.48
			1	2	23.00	22.76	22.58	22.57
			1	5	23.00	22.49	22.40	22.45
			3	0	23.00	22.57	22.42	22.53
			3	1	23.00	22.56	22.47	22.50
			3	2	23.00	22.54	22.43	22.46
			6	0	21.50	21.49	21.36	21.45
		16QAM	1	0	22.00	21.43	21.51	21.61
			1	2	22.00	21.49	21.60	21.72
			1	5	22.00	21.34	21.48	21.62
			3	0	22.00	21.64	21.55	21.68
			3	1	22.00	21.67	21.56	21.73
			3	2	22.00	21.69	21.50	21.71
			6	0	21.00	20.68	20.52	20.60
Band	Band Width	Modulation	RB Configuration		Tune-up	Channel/Frequency(MHz)		
			RB Size	RB Offset		23025/700.5	23095/707.5	23165/714.5
LTE Band	3MHz	QPSK	1	0	23.00	22.54	22.36	22.49
			1	7	23.00	22.78	22.60	22.73

12			1	14	23.00	22.49	22.39	22.42
			8	0	21.50	21.49	21.34	21.47
			8	4	21.50	21.48	21.37	21.47
			8	7	21.50	21.46	21.35	21.47
			15	0	21.50	21.43	21.33	21.43
		16QAM	1	0	22.50	21.68	21.25	21.84
			1	7	22.50	21.95	21.46	22.12
			1	14	22.50	21.63	21.18	21.83
			8	0	21.00	20.49	20.28	20.49
			8	4	21.00	20.47	20.30	20.48
			8	7	21.00	20.40	20.32	20.51
			15	0	20.50	20.37	20.38	20.46
			Band	Band Width	Modulation	RB Configuration		Tune-up
RB Size	RB Offset	23035/701.5				23095/707.5	23155/713.5	
LTE Band 12	5MHz	QPSK	1	0	23.00	22.41	22.25	22.30
			1	12	23.00	22.74	22.69	22.81
			1	24	23.00	22.34	22.26	22.40
			12	0	22.00	21.48	21.17	21.50
			12	6	22.00	21.45	21.35	21.46
			12	11	22.00	21.39	21.23	21.48
			25	0	22.00	21.49	21.24	21.53
		16QAM	1	0	22.50	21.73	21.56	21.77
			1	12	22.50	22.13	21.85	22.44
			1	24	22.50	21.60	21.53	21.94
			12	0	20.50	20.41	20.23	20.48
			12	6	20.50	20.44	20.32	20.47
			12	11	20.50	20.35	20.26	20.45
			25	0	20.50	20.47	20.22	20.49
Band	Band Width	Modulation	RB Configuration		Tune-up	Channel/Frequency(MHz)		
			RB Size	RB Offset		23060/704	23095/707.5	23130/711
LTE Band 12	10MHz	QPSK	1	0	23.00	22.52	22.38	22.26
			1	24	23.00	22.53	22.42	22.45
			1	49	23.00	22.47	22.41	22.46
			25	0	22.00	21.49	21.18	21.52
			25	12	22.00	21.37	21.32	21.39
			25	24	22.00	21.53	21.15	21.37

	16QAM	50	0	22.00	21.50	21.17	21.47
		1	0	22.00	21.34	21.78	21.42
		1	24	22.00	21.32	21.81	21.60
		1	49	22.00	21.17	21.84	21.60
		25	0	21.00	20.47	20.16	20.49
		25	12	21.00	20.36	20.35	20.41
		25	24	21.00	20.54	20.14	20.37
		50	0	20.50	20.47	20.15	20.49

Band	Band Width	Modulation	RB Configuration		Tune-up	Channel/Frequency(MHz)		
			RB Size	RB Offset		23205/779.5	23230/782	23255/784.5
LTE Band 13	5MHz	QPSK	1	0	22.50	22.05	21.96	21.86
			1	12	22.50	22.36	22.29	22.14
			1	24	22.50	21.88	21.82	21.78
			12	0	21.50	20.93	20.89	20.93
			12	6	21.50	21.09	21.00	20.95
			12	11	21.50	21.16	20.86	20.87
		16QAM	1	0	22.00	21.52	21.23	21.11
			1	12	22.00	21.85	21.71	21.46
			1	24	22.00	21.43	21.11	21.12
			12	0	20.50	20.00	19.75	19.94
			12	6	20.50	20.08	19.90	19.94
			12	11	20.50	20.13	19.80	19.90
			25	0	20.50	20.05	19.86	19.87

Band	Band Width	Modulation	RB Configuration		Tune-up	Channel/Frequency(MHz)		
			RB Size	RB Offset		23230/782		

LTE Band 13	10MHz	QPSK	1	0	22.50	22.07
			1	24	22.50	22.08
			1	49	22.50	21.91
			25	0	21.00	20.80
			25	12	21.00	20.96
			25	24	21.00	20.88
			50	0	21.00	20.78
		16QAM	1	0	21.50	21.42
			1	24	21.50	21.41

			1	49	21.50	21.33
			25	0	20.00	19.82
			25	12	20.00	19.96
			25	24	20.00	19.87
			50	0	20.00	19.81

Band	Band Width	Modulation	RB Configuration		Tune-up	Channel/Frequency(MHz)		
			RB Size	RB Offset		23755/706.5	23790/710	23825/713.5
LTE Band 17	5MHz	QPSK	1	0	23.00	22.09	22.07	22.11
			1	12	23.00	22.50	22.48	22.61
			1	24	23.00	22.13	22.10	22.23
			12	0	21.50	21.04	21.20	21.29
			12	6	21.50	21.21	21.23	21.27
			12	11	21.50	21.20	20.98	21.29
		16QAM	1	0	22.50	21.40	21.34	21.60
			1	12	22.50	21.78	21.71	22.16
			1	24	22.50	21.39	21.40	21.74
			12	0	20.50	19.99	20.17	20.25
			12	6	20.50	20.13	20.20	20.28
			12	11	20.50	20.12	20.00	20.27
			25	0	20.50	20.13	20.09	20.25
						RB Configuration		Tune-up
RB Size	RB Offset	23780/709				23790/710	23800/711	
LTE Band 17	10MHz	QPSK	1	0	23.00	22.22	22.11	22.07
			1	24	23.00	22.28	22.29	22.24
			1	49	23.00	22.31	22.32	22.27
			25	0	21.50	21.01	21.14	21.26
			25	12	21.50	21.11	21.17	21.16
			25	24	21.50	20.95	21.02	21.17
			50	0	21.50	20.95	21.10	21.27
		16QAM	1	0	22.00	21.00	21.56	21.20
			1	24	22.00	21.04	21.62	21.36
			1	49	22.00	21.12	21.67	21.42
			25	0	20.50	20.02	20.12	20.21
			25	12	20.50	20.14	20.12	20.15

			25	24	20.50	19.94	20.01	20.13
			50	0	20.50	19.93	20.03	20.24

Band	Band Width	Modulation	RB Configuration		Tune-up	Channel/Frequency(MHz)		
			RB Size	RB Offset		26047/1850.7	26365/1882.5	26683/1914.3
LTE Band 25	1.4MHz	QPSK	1	0	23.50	22.16	23.02	22.29
			1	2	23.50	23.29	23.17	22.41
			1	5	23.50	23.11	22.98	22.28
			3	0	23.50	23.14	23.07	22.38
			3	1	23.50	23.14	23.01	22.42
			3	2	23.50	23.11	23.08	22.34
		16QAM	6	0	22.50	22.16	22.00	21.33
			1	0	22.50	21.92	22.08	21.49
			1	2	22.50	22.13	22.23	21.53
			1	5	22.50	21.90	22.07	21.47
			3	0	22.50	22.19	22.15	21.58
			3	1	22.50	22.18	22.17	21.57
			3	2	22.50	22.17	22.15	21.58
			6	0	21.50	21.32	21.19	20.53
Band	Band Width	Modulation	RB Configuration		Tune-up	Channel/Frequency(MHz)		
			RB Size	RB Offset		26055/1851.5	26365/1882.5	26675/1913.5
LTE Band 25	3MHz	QPSK	1	0	23.50	23.11	23.04	22.42
			1	7	23.50	23.43	23.41	22.62
			1	14	23.50	23.17	23.00	22.29
			8	0	22.50	22.11	22.02	21.41
			8	4	22.50	22.12	22.06	21.35
			8	7	22.50	22.15	22.00	21.33
			15	0	22.50	22.08	21.98	21.33
		16QAM	1	0	22.50	22.27	21.87	21.78
			1	7	22.50	22.42	22.20	22.05
			1	14	22.50	22.22	21.79	21.73
			8	0	21.50	21.12	21.05	20.46
			8	4	21.50	21.15	21.01	20.45
			8	7	21.50	21.14	20.99	20.40
			15	0	21.50	21.01	21.06	20.40
Band	Band	Modulation	RB		Tune-up	Channel/Frequency(MHz)		

	Width		Configuration					
			RB Size	RB Offset		26065/1852.5	26365/1882.5	26665/1912.5
LTE Band 25	5MHz	QPSK	1	0	23.50	23.04	22.90	22.29
			1	12	23.50	23.38	23.34	22.74
			1	24	23.50	23.05	22.84	22.27
			12	0	22.50	22.03	22.00	21.46
			12	6	22.50	22.15	22.02	21.41
			12	11	22.50	22.14	21.94	21.28
			25	0	22.50	22.10	21.98	21.39
		16QAM	1	0	23.00	22.28	22.19	21.77
			1	12	23.00	22.65	22.57	22.07
			1	24	23.00	22.26	22.13	21.71
			12	0	21.50	20.99	21.01	20.55
			12	6	21.50	21.10	21.06	20.45
			12	11	21.50	21.08	20.98	20.29
			25	0	21.50	21.10	20.97	20.42
Band	Band Width	Modulation	RB Configuration		Tune-up	Channel/Frequency(MHz)		
			RB Size	RB Offset		26090/1855	26365/1882.5	26640/1910
LTE Band 25	10MHz	QPSK	1	0	23.50	23.14	23.05	22.46
			1	24	23.50	23.32	23.14	22.47
			1	49	23.50	23.14	22.90	22.28
			25	0	22.50	21.99	22.05	21.58
			25	12	22.50	22.10	22.01	21.44
			25	24	22.50	22.13	22.06	21.22
			50	0	22.50	22.07	22.02	21.44
		16QAM	1	0	22.50	22.20	21.90	21.82
			1	24	22.50	22.29	21.95	21.85
			1	49	22.50	22.14	21.74	21.67
			25	0	21.50	21.01	21.03	20.66
			25	12	21.50	21.12	21.03	20.49
			25	24	21.50	21.19	21.08	20.29
			50	0	21.50	21.12	21.01	20.47
Band	Band Width	Modulation	RB Configuration		Tune-up	Channel/Frequency(MHz)		
			RB Size	RB Offset		26115/1857.5	26365/1882.5	26615/1907.5
LTE	15MHz	QPSK	1	0	23.50	23.02	23.00	22.52

Band	Band Width	Modulation	RB Configuration		Tune-up	Channel/Frequency(MHz)		
			RB Size	RB Offset		26140/1860	26365/1882.5	26590/1905
Band 25			1	37	23.50	23.28	23.25	22.48
			1	74	23.50	22.89	22.76	22.14
			36	0	22.50	22.13	22.04	21.52
			36	18	22.50	22.22	22.08	21.53
			36	37	22.50	22.18	22.06	21.28
			75	0	22.50	22.17	22.07	21.44
			75	0	22.50	22.17	22.07	21.44
		16QAM	1	0	23.00	22.40	22.14	21.62
			1	37	23.00	22.55	22.44	21.61
			1	74	23.00	22.39	21.89	21.34
			36	0	21.50	21.09	21.12	20.46
			36	18	21.50	21.18	21.08	20.49
			36	37	21.50	21.18	21.10	20.28
			75	0	21.50	21.11	21.06	20.45
LTE Band 25	20MHz	QPSK	1	0	23.50	22.90	22.87	22.49
			1	49	23.50	23.18	23.09	22.57
			1	99	23.50	22.82	22.55	22.08
			50	0	22.50	21.92	21.94	21.52
			50	24	22.50	22.06	22.04	21.49
			50	49	22.50	22.04	21.90	21.14
			100	0	22.50	22.01	21.97	21.34
		16QAM	1	0	22.50	22.04	22.13	21.76
			1	49	22.50	22.34	22.34	21.82
			1	99	22.50	22.03	21.91	21.34
			50	0	21.50	21.00	21.05	20.54
			50	24	21.50	21.16	21.10	20.51
			50	49	21.50	21.13	20.97	20.16
			100	0	21.50	21.02	20.98	20.35

Band	Band Width	Modulation	RB Configuration		Tune-up	Channel/Frequency(MHz)		
			RB Size	RB Offset		26697/814.7	26740/819	26783/823.3
LTE Band 26A	1.4MHz	QPSK	1	0	24.00	23.63	23.54	23.53
			1	2	24.00	23.76	23.65	23.65
			1	5	24.00	23.62	23.52	23.49
			3	0	24.00	23.60	23.56	23.45

			3	1	24.00	23.63	23.56	23.29
			3	2	24.00	23.65	23.56	23.19
			6	0	23.00	22.66	22.60	22.30
		16QAM	1	0	23.00	22.63	22.65	21.82
			1	2	23.00	22.79	22.73	21.91
			1	5	23.00	22.67	22.67	21.71
			3	0	23.00	22.70	22.71	22.06
			3	1	23.00	22.74	22.70	22.06
			3	2	23.00	22.70	22.72	22.08
			6	0	22.00	21.76	21.67	21.13
Band	Band Width		Modulation	RB Configuration		Tune-up	Channel/Frequency(MHz)	
		RB Size		RB Offset	26705/815.5		26740/819	26775/822.5
LTE Band 26A	3MHz	QPSK	1	0	24.00	23.52	23.11	23.02
			1	7	24.00	23.41	23.45	23.29
			1	14	24.00	23.17	23.02	23.00
			8	0	22.50	22.09	22.06	21.99
			8	4	22.50	22.13	22.05	22.04
			8	7	22.50	22.15	22.02	21.97
		16QAM	1	0	23.00	21.95	22.42	22.11
			1	7	23.00	22.15	22.62	22.34
			1	14	23.00	21.92	22.36	22.04
			8	0	21.50	21.07	21.03	20.97
			8	4	21.50	21.06	21.07	20.99
			8	7	21.50	21.10	21.02	20.91
			15	0	21.50	21.12	20.99	20.86
			Band	Band Width	Modulation	RB Configuration		Tune-up
RB Size	RB Offset	26715/816.5				26740/819	26765/821.5	
LTE Band 26A	5MHz	QPSK	1	0	24.00	23.49	23.01	22.96
			1	12	24.00	23.97	23.45	23.27
			1	24	24.00	23.44	23.00	22.96
			12	0	23.00	22.51	22.00	21.97
			12	6	23.00	22.63	22.07	22.04
			12	11	23.00	22.58	21.99	21.95
			25	0	23.00	22.58	22.03	21.99
		16QAM	1	0	23.50	22.73	22.47	22.18

Band	Band Width	Modulation	RB Configuration		Tune-up	Channel/Frequency(MHz)		
			RB Size	RB Offset		26740/819		
LTE Band 26A	10MHz	QPSK	1	0	24.00	23.07		
			1	24	24.00	23.81		
			1	49	24.00	23.08		
			25	0	22.50	22.03		
			25	12	22.50	21.98		
			25	24	22.50	22.02		
		16QAM	50	0	22.00	21.97		
			1	0	23.00	22.39		
			1	24	23.00	22.51		
			1	49	23.00	22.29		
			25	0	21.50	21.02		
			25	12	21.50	21.01		
			25	24	21.50	20.99		
			50	0	21.00	20.97		

Band	Band Width	Modulation	RB Configuration		Tune-up	Channel/Frequency(MHz)		
			RB Size	RB Offset		26797/824.7	26915/836.5	27033/848.3
LTE Band 26B	1.4MHz	QPSK	1	0	23.50	22.96	22.78	22.91
			1	2	23.50	23.08	22.88	23.07
			1	5	23.50	22.93	22.77	22.93
			3	0	23.00	22.85	22.82	22.94
			3	1	23.00	22.88	22.79	22.92
			3	2	23.00	22.81	22.80	22.87
			6	0	22.00	21.91	21.82	21.88
		16QAM	1	0	22.50	21.94	21.61	22.03
			1	2	22.50	22.05	21.75	22.01
			1	5	22.50	21.95	21.62	21.92
			3	0	22.50	22.02	21.95	22.06

			3	1	22.50	22.06	21.94	22.00
			3	2	22.50	22.04	21.94	21.99
			6	0	21.50	20.99	20.97	21.04
Band	Band Width	Modulation	RB Configuration		Tune-up	Channel/Frequency(MHz)		
			RB Size	RB Offset		26805/825.5	26915/836.5	27025/847.5
LTE Band 26B	3MHz	QPSK	1	0	23.50	22.96	22.79	22.85
			1	7	23.50	23.29	23.07	23.27
			1	14	23.50	22.88	22.81	22.97
			8	0	22.00	21.91	21.78	21.92
			8	4	22.00	21.94	21.86	21.95
			8	7	22.00	21.89	21.82	21.85
			15	0	22.00	21.85	21.80	21.88
		16QAM	1	0	22.50	22.20	22.01	21.80
			1	7	22.50	22.42	22.30	22.09
			1	14	22.50	22.14	21.96	21.66
			8	0	21.00	20.88	20.82	20.91
			8	4	21.00	20.89	20.84	20.91
			8	7	21.00	20.84	20.82	20.83
			15	0	21.00	20.82	20.76	20.95
Band	Band Width	Modulation	RB Configuration		Tune-up	Channel/Frequency(MHz)		
			RB Size	RB Offset		26815/826.5	26915/836.5	27015/846.5
LTE Band 26B	5MHz	QPSK	1	0	23.50	22.73	22.71	22.80
			1	12	23.50	23.12	23.16	23.25
			1	24	23.50	22.70	22.75	22.84
			12	0	22.00	21.85	21.76	21.94
			12	6	22.00	21.90	21.87	21.95
			12	11	22.00	21.78	21.82	21.89
			25	0	22.00	21.82	21.82	21.92
		16QAM	1	0	23.00	22.00	22.21	22.06
			1	12	23.00	22.24	22.71	22.47
			1	24	23.00	21.90	22.22	22.03
			12	0	21.00	20.83	20.78	20.87
			12	6	21.00	20.84	20.87	20.91
			12	11	21.00	20.74	20.82	20.78
			25	0	21.00	20.79	20.79	20.94
Band	Band	Modulation	RB		Tune-up	Channel/Frequency(MHz)		

	Width		Configuration					
			RB Size	RB Offset		26840/829.0	26915/836.5	26990/844
LTE Band 26B	10MHz	QPSK	1	0	23.50	22.98	22.82	22.82
			1	24	23.50	23.07	22.96	23.02
			1	49	23.50	22.92	22.89	22.89
			25	0	22.50	21.91	21.81	22.05
			25	12	22.50	21.78	21.81	21.89
			25	24	22.50	21.83	21.80	21.90
			50	0	22.00	21.82	21.82	22.00
		16QAM	1	0	22.50	21.95	21.61	22.15
			1	24	22.50	22.01	21.74	22.37
			1	49	22.50	21.95	21.66	22.23
			25	0	21.50	20.89	20.83	21.04
			25	12	21.50	20.80	20.86	20.92
			25	24	21.50	20.79	20.79	20.94
			50	0	21.50	20.85	20.80	21.01
Band	Band Width	Modulation	RB Configuration		Tune-up	Channel/Frequency(MHz)		
			RB Size	RB Offset		26865/831.5	26915/836.5	26965/841.5
LTE Band 26B	15MHz	QPSK	1	0	23.50	22.90	22.72	22.73
			1	37	23.50	23.07	23.07	23.08
			1	74	23.50	22.74	22.77	22.81
			36	0	22.00	22.00	21.87	21.91
			36	18	22.00	21.91	21.89	21.95
			36	37	22.00	21.88	21.83	21.90
			75	0	22.00	21.94	21.92	21.89
		16QAM	1	0	22.50	21.90	21.77	22.09
			1	37	22.50	22.12	22.14	22.30
			1	74	22.50	21.92	21.88	22.15
			36	0	21.00	20.93	20.81	20.92
			36	18	21.00	20.90	20.80	20.93
			36	37	21.00	20.91	20.75	20.85
			75	0	21.00	20.87	20.87	20.84

Band	Band Width	Modulation	RB Configuration		Tune-up	Channel/Frequency(MHz)		
			RB Size	RB Offset		40065/2537.5	40640/2595	41215/2652.5

LTE Band 41	5MHz	QPSK	1	0	24.50	23.55	23.78	23.77
			1	12	24.50	23.86	24.12	24.17
			1	24	24.50	23.50	23.82	23.78
			12	0	23.00	22.47	22.87	22.77
			12	6	23.00	22.59	22.90	22.84
			12	11	23.00	22.54	22.92	22.69
			25	0	23.00	22.48	22.83	22.74
		16QAM	1	0	23.50	22.78	22.98	22.83
			1	12	23.50	23.09	23.25	23.08
			1	24	23.50	22.81	22.98	22.72
			12	0	22.00	21.41	21.74	21.73
			12	6	22.00	21.49	21.84	21.78
			12	11	22.00	21.46	21.82	21.66
			25	0	22.00	21.42	21.82	21.65
Band	Band Width	Modulation	RB Configuration		Tune-up	Channel/Frequency(MHz)		
			RB Size	RB Offset		40090/2564	40640/2595	41190/2650
LTE Band 41	10MHz	QPSK	1	0	24.50	23.59	23.93	23.81
			1	24	24.50	23.66	24.04	23.96
			1	49	24.50	23.52	23.93	23.84
			25	0	23.00	22.51	22.85	22.83
			25	12	23.00	22.50	22.88	22.82
			25	24	23.00	22.47	22.99	22.77
			50	0	23.00	22.47	22.89	22.78
		16QAM	1	0	23.50	22.79	22.96	22.71
			1	24	23.50	22.90	23.07	22.79
			1	49	23.50	22.78	22.98	22.57
			25	0	22.00	21.48	21.82	21.78
			25	12	22.00	21.49	21.87	21.74
			25	24	22.00	21.47	21.98	21.74
			50	0	22.00	21.44	21.88	21.72
Band	Band Width	Modulation	RB Configuration		Tune-up	Channel/Frequency(MHz)		
			RB Size	RB Offset		40115/2542.5	40640/2595	41165/2647.5
LTE Band 41	15MHz	QPSK	1	0	24.50	23.43	23.83	23.76
			1	37	24.50	23.72	24.19	24.02
			1	74	24.50	23.40	23.88	23.67
			36	0	23.00	22.67	22.93	22.95

Band	Band Width	Modulation	RB Configuration		Tune-up	Channel/Frequency(MHz)		
			RB Size	RB Offset		40140/2545	40640/2595	41140/2645
		16QAM	36	18	23.00	22.63	22.98	22.99
			36	37	23.00	22.58	23.00	22.91
			75	0	23.00	22.60	22.97	22.98
			1	0	23.50	22.72	22.86	22.95
			1	37	23.50	23.00	23.18	23.16
			1	74	23.50	22.71	22.93	22.71
			36	0	22.50	21.55	21.89	21.82
			36	18	22.50	21.57	21.96	21.83
			36	37	22.50	21.53	22.01	21.74
			75	0	22.00	21.51	21.91	21.88
LTE Band 41	20MHz	QPSK	1	0	24.50	23.28	23.61	23.63
			1	49	24.50	23.60	24.03	24.00
			1	99	24.50	23.28	23.70	23.57
			50	0	23.00	22.47	22.68	22.82
			50	24	23.00	22.46	22.88	22.83
			50	49	23.00	22.38	22.96	22.74
		16QAM	100	0	23.00	22.42	22.82	22.81
			1	0	23.50	22.35	22.73	22.78
			1	49	23.50	22.67	23.11	23.06
			1	99	23.50	22.35	22.83	22.55
			50	0	22.00	21.42	21.71	21.78
			50	24	22.00	21.47	21.90	21.85
			50	49	22.00	21.31	21.96	21.79
			100	0	22.00	21.37	21.83	21.80

Band	Band Width	Modulation	RB Configuration		Tune-up	Channel/Frequency(MHz)		
			RB Size	RB Offset		131979/1710.7	132322/1745	132665/1779.3
LTE Band 66	1.4MHz	QPSK	1	0	23.50	23.08	22.91	22.70
			1	2	23.50	23.21	23.00	22.81
			1	5	23.50	23.44	22.88	22.71
			3	0	23.50	23.12	22.99	22.79
			3	1	23.50	23.17	23.07	22.77
			3	2	23.50	23.18	22.99	22.73
			6	0	22.50	22.14	22.03	21.84

		16QAM	1	0	22.50	22.11	22.09	21.54
			1	2	22.50	22.25	22.21	21.71
			1	5	22.50	22.14	22.12	21.54
			3	0	22.50	22.24	22.21	21.85
			3	1	22.50	22.27	22.23	21.90
			3	2	22.50	22.24	22.22	21.91
			6	0	21.50	21.30	21.17	20.96
Band	Band Width	Modulation	RB Configuration		Tune-up	Channel/Frequency(MHz)		
			RB Size	RB Offset		131987/1711.5	132322/1745	132657/1778.5
LTE Band 66	3MHz	QPSK	1	0	23.50	23.15	22.92	22.72
			1	7	23.50	23.34	23.24	23.09
			1	14	23.50	23.09	22.95	22.73
			8	0	22.50	22.08	22.01	21.78
			8	4	22.50	22.11	22.02	21.82
			8	7	22.50	22.09	21.98	21.77
			15	0	22.50	22.07	21.99	21.72
		16QAM	1	0	23.00	22.44	22.13	21.60
			1	7	23.00	22.75	22.44	21.89
			1	14	23.00	22.38	22.11	21.56
			8	0	21.50	21.16	21.01	20.73
			8	4	21.50	21.17	21.00	20.78
			8	7	21.50	21.13	20.98	20.72
			15	0	21.50	21.10	20.90	20.76
Band	Band Width	Modulation	RB Configuration		Tune-up	Channel/Frequency(MHz)		
			RB Size	RB Offset		131997/1712.5	132322/1745	132647/1777.5
LTE Band 66	5MHz	QPSK	1	0	23.50	22.92	22.86	22.62
			1	12	23.50	23.22	23.22	23.11
			1	24	23.50	22.92	22.85	22.63
			12	0	22.50	22.08	21.95	21.71
			12	6	22.50	22.13	22.03	21.80
			12	11	22.50	22.11	21.94	21.75
			25	0	22.50	22.08	21.99	21.75
		16QAM	1	0	23.00	22.20	22.34	21.89
			1	12	23.00	22.66	22.74	22.37
			1	24	23.00	22.23	22.33	21.88
			12	0	21.50	21.15	20.99	20.64

Band	Band Width	Modulation	RB Configuration		Tune-up	Channel/Frequency(MHz)		
			RB Size	RB Offset		132022/1715	132322/1745	132622/1775
			12	6	21.50	21.19	21.01	20.72
			12	11	21.50	21.12	20.94	20.64
			25	0	21.50	21.11	20.95	20.71
LTE Band 66	10MHz	QPSK	1	0	23.50	23.16	22.96	22.77
			1	24	23.50	23.24	23.10	22.82
			1	49	23.50	23.11	22.94	22.68
			25	0	22.50	22.12	22.11	21.84
			25	12	22.50	22.12	22.03	21.82
			25	24	22.50	22.13	21.96	21.80
			50	0	22.50	22.16	22.04	21.78
		16QAM	1	0	22.50	22.11	21.88	22.12
			1	24	22.50	22.30	21.98	22.22
			1	49	22.50	22.16	21.82	22.05
			25	0	21.50	21.16	21.12	20.81
			25	12	21.50	21.16	21.04	20.82
			25	24	21.50	21.19	20.97	20.81
			50	0	21.50	21.18	21.01	20.80
Band	Band Width	Modulation	RB Configuration		Tune-up	Channel/Frequency(MHz)		
			RB Size	RB Offset		132047/1717.5	132322/1745	132597/1772.5
LTE Band 66	15MHz	QPSK	1	0	23.50	22.91	22.97	22.74
			1	37	23.50	23.21	23.11	22.82
			1	74	23.50	22.83	22.83	22.57
			36	0	22.50	22.14	22.11	21.84
			36	18	22.50	22.14	22.05	21.91
			36	37	22.50	22.17	22.03	21.86
			75	0	22.50	22.15	22.09	21.85
		16QAM	1	0	23.00	22.30	22.09	21.87
			1	37	23.00	22.63	22.40	22.09
			1	74	23.00	22.34	22.03	21.73
			36	0	21.50	21.10	21.14	20.74
			36	18	21.50	21.12	21.05	20.76
			36	37	21.50	21.16	21.02	20.76
			75	0	21.50	21.13	21.00	20.80

Band	Band Width	Modulation	RB Configuration		Tune-up	Channel/Frequency(MHz)		
			RB Size	RB Offset		132072/1720	132322/1745	132572/1770
LTE Band 66	20MHz	QPSK	1	0	23.50	22.83	22.76	22.63
			1	49	23.50	23.11	23.06	22.86
			1	99	23.50	22.83	22.69	22.48
			50	0	22.50	21.99	22.08	21.74
			50	24	22.50	22.05	22.03	21.79
			50	49	22.50	22.09	21.94	21.76
			100	0	22.50	22.02	22.00	21.76
		16QAM	1	0	22.50	22.00	22.10	21.88
			1	49	22.50	22.33	22.35	22.07
			1	99	22.50	22.07	22.03	21.67
			50	0	21.50	21.07	21.07	20.68
			50	24	21.50	21.13	21.02	20.72
			50	49	21.50	21.17	20.92	20.72
			100	0	21.50	21.08	20.99	20.73

7.4. WLAN & Bluetooth Output Power

Mode	Channel	Frequency (MHz)	Tune-up	Output Power (dBm)
802.11b	1	2412	14.50	14.32
	6	2437	14.50	13.40
	11	2462	14.50	14.23
802.11g	1	2412	14.50	14.02
	6	2437	14.50	13.04
	11	2462	14.50	13.82
802.11n HT20	1	2412	14.50	14.07
	6	2437	14.50	12.88
	11	2462	14.50	13.76
802.11n HT40	3	2422	12.50	12.47
	6	2437	12.50	12.33
	9	2452	12.50	12.42

NOTE: Power measurement results of WLAN 2.4G.

Mode	Channel	Frequency (MHz)	Tune-up	Output Power (dBm)
802.11a	36	5180	10.000	9.919
	40	5200	10.000	9.613
	48	5240	10.000	9.741

802.11n HT20	36	5180	10.000	9.946
	40	5200	10.000	9.752
	48	5240	10.000	9.539
802.11n HT40	38	5190	10.000	9.849
	46	5230	10.000	9.561

NOTE: Power measurement results of WLAN 5.2G.

Mode	Channel	Frequency (MHz)	Tune-up	Output Power (dBm)
802.11a	149	5745	10.500	9.677
	157	5785	10.500	10.207
	165	5825	10.500	9.543
802.11n HT20	149	5745	10.000	9.689
	157	5785	10.000	9.946
	165	5825	10.000	9.414
802.11n HT40	151	5755	10.000	9.490
	159	5795	10.000	9.870

NOTE: Power measurement results of WLAN 5.8G.

BR+EDR	Output Power (dBm)				
	Data Rates	Tune-up	Channel		
			0CH	39CH	78CH
1M	8.000	6.451	7.590	7.519	
2M	7.000	5.621	6.798	6.869	
3M	7.000	5.580	6.836	6.937	

BLE	Channel	Tune-up	Output Power (dBm)	
			1M	2M
	0CH	-4.000	-4.759	-4.340
19CH	-4.000	-4.466	-4.133	
39CH	-4.000	-4.822	-4.461	

NOTE: Power measurement results of Bluetooth.

8. Antenna Location

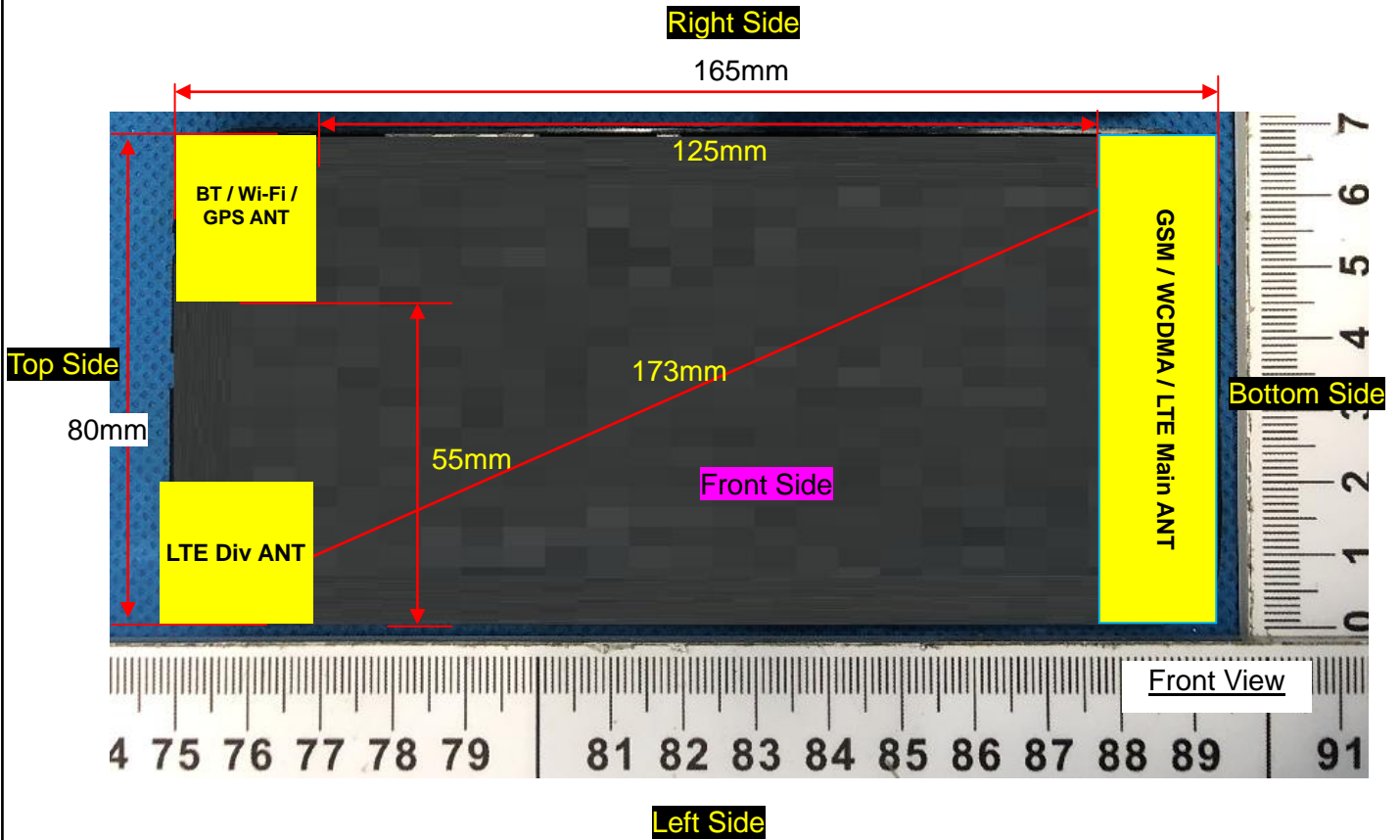

Note: Since the confidentiality request of EUT, the antenna location example diagram see as above.

Distance of the Antenna to the EUT surface/edge						
Antennas	Front Side	Back Side	Left Side	Right Side	Top Side	Bottom Side
WWAN Main	≤ 25mm	≤ 25mm	≤ 25mm	≤ 25mm	>25mm	≤ 25mm
WLAN & Bluetooth	≤ 25mm	≤ 25mm	>25mm	≤ 25mm	≤ 25mm	>25mm
Positions for SAR tests						
Antennas	Front Side	Back Side	Left Side	Right Side	Top Side	Bottom Side
WWAN Main	Yes	Yes	Yes	Yes	NO	Yes
WLAN & Bluetooth	Yes	Yes	NO	Yes	Yes	NO

9. Stand-alone SAR test exclusion

Refer to FCC KDB 447498D01, the 1-g SAR and 10-g SAR test exclusion thresholds for 100 MHz to 6 GHz at test separation distances ≤ 50 mm are determined by:

$[(\text{max. power of channel, including tune-up tolerance, mW}) / (\text{min. test separation distance, mm})] \cdot [\sqrt{f_{(\text{GHz})}}] \leq 3.0$ for 1-g SAR and ≤ 7.5 for 10-g extremity SAR, where:

- $f_{(\text{GHz})}$ is the RF channel transmit frequency in GHz
- Power and distance are rounded to the nearest mW and mm before calculation
- The result is rounded to one decimal place for comparison

When the minimum test separation distance is < 5 mm, a distance of 5 mm is applied to determine SAR test exclusion.

Mode	P_{max} (dBm)	P_{max} (mW)	Distance (mm)	f (GHz)	Calculation Result	SAR Exclusion threshold	SAR test exclusion
Bluetooth	8.000	6.310	5	2.480	1.99	3.0	YES

NOTE: Standalone SAR test exclusion for Bluetooth.

When standalone SAR test exclusion applies to an antenna that transmits simultaneously with other antennas, the standalone SAR must be estimated according to following to determine simultaneous transmission SAR test exclusion:

$[(\text{max. power of channel, including tune-up tolerance, mW}) / (\text{min. test separation distance, mm})] \cdot [\sqrt{f_{(\text{GHz})} / x}] \text{ W/kg}$ for test separation distances ≤ 50 mm, where $x = 7.5$ for 1-g SAR and $x = 18.75$ for 10-g SAR.

When the minimum test separation distance is < 5 mm, a distance of 5 mm is applied to determine SAR test exclusion.

Mode	Position	P_{max} (dBm)	P_{max} (mW)	Distance (mm)	f (GHz)	x	Estimated SAR (W/Kg)
Bluetooth	Head	8.000	6.310	5	2.480	7.5	0.265
Bluetooth	Body	8.000	6.310	10	2.480	7.5	0.132
Bluetooth	Hotspot	8.000	6.310	10	2.480	7.5	0.132

NOTE: Estimated SAR calculation for Bluetooth

10. SAR Results

10.1. SAR measurement Result

10.1.1. SAR measurement Result of GSM850

Test Position of Head	Test channel /Freq.	Test Mode	SAR Value (W/kg)		Power Drift (±5%)	Conducted power (dBm)	Tune-up power (dBm)	Scaled SAR 1g (W/Kg)	Date
			1g	10g					
Left Cheek	189/836.4	GPRS(GMSK 4TS)	0.353	0.252	1.18	29.18	29.50	0.380	2021/2/02
Left Tilt 15 Degree	189/836.4	GPRS(GMSK 4TS)	0.196	0.135	0.76	29.18	29.50	0.211	2021/2/02
Right Cheek	189/836.4	GPRS(GMSK 4TS)	0.316	0.231	4.35	29.18	29.50	0.340	2021/2/02
Right Tilt 15 Degree	189/836.4	GPRS(GMSK 4TS)	0.155	0.108	1.05	29.18	29.50	0.167	2021/2/02

NOTE: Head SAR test results of GSM850.

Test Position of Body-Worn with 10mm	Test channel /Freq.	Test Mode	SAR Value (W/kg)		Power Drift (±5%)	Conducted power (dBm)	Tune-up power (dBm)	Scaled SAR 1g (W/Kg)	Date
			1g	10g					
Front Side	189/836.4	GPRS(GMSK 4TS)	0.309	0.220	0.06	29.18	29.50	0.333	2021/2/02
Back Side	189/836.4	GPRS(GMSK 4TS)	0.380	0.267	-2.00	29.18	29.50	0.409	2021/2/02

NOTE: Body-Worn SAR test results of GSM850

Test Position of Hotspot with 10mm	Test channel /Freq.	Test Mode	SAR Value (W/kg)		Power Drift (±5%)	Conducted power (dBm)	Tune-up power (dBm)	Scaled SAR 1g (W/Kg)	Date
			1g	10g					
Front Side	189/836.4	GPRS(GMSK 4TS)	0.309	0.220	0.06	29.18	29.50	0.333	2021/2/02
Back Side	189/836.4	GPRS(GMSK 4TS)	0.380	0.267	-2.00	29.18	29.50	0.409	2021/2/02
Left Side	189/836.4	GPRS(GMSK 4TS)	0.170	0.119	-2.66	29.18	29.50	0.183	2021/2/02
Right Side	189/836.4	GPRS(GMSK 4TS)	0.145	0.099	1.55	29.18	29.50	0.156	2021/2/02
Bottom Side	189/836.4	GPRS(GMSK 4TS)	0.287	0.201	-3.49	29.18	29.50	0.309	2021/2/02

NOTE: Hotspot SAR test results of GSM850

10.1.2. SAR measurement Result of GSM1900

Test Position of Head	Test channel /Freq.	Test Mode	SAR Value (W/kg)		Power Drift (±5%)	Conducted power (dBm)	Tune-up power (dBm)	Scaled SAR 1g (W/Kg)	Date
			1g	10g					
Left	661/1880	GPRS(GMSK	0.285	0.160	2.31	25.99	27.00	0.360	2021/2/03

Cheek		4TS)							
Left Tilt 15 Degree	661/1880	GPRS(GMSK 4TS)	0.155	0.087	2.56	25.99	27.00	0.196	2021/2/03
Right Cheek	661/1880	GPRS(GMSK 4TS)	0.242	0.134	2.98	25.99	27.00	0.305	2021/2/03
Right Tilt 15 Degree	661/1880	GPRS(GMSK 4TS)	0.127	0.072	0.49	25.99	27.00	0.160	2021/2/03

NOTE: Head SAR test results of GSM1900

Test Position of Body-Worn with 10mm	Test channel /Freq.	Test Mode	SAR Value (W/kg)		Power Drift (±5%)	Conducted power (dBm)	Tune-up power (dBm)	Scaled SAR 1g (W/Kg)	Date
			1g	10g					
Front Side	661/1880	GPRS(GMSK 4TS)	0.545	0.283	-4.77	25.99	27.00	0.688	2021/2/03
Back Side	661/1880	GPRS(GMSK 4TS)	0.722	0.369	-0.72	25.99	27.00	0.911	2021/2/03
Back Side	512/1850.2	GPRS(GMSK 4TS)	0.679	0.355	1.25	25.41	27.00	0.979	2021/2/03
Back Side	810/1909.8	GPRS(GMSK 4TS)	0.701	0.359	0.34	26.56	27.00	0.776	2021/2/03

NOTE: Body-Worn SAR test results of GSM1900

Test Position of Hotspot with 10mm	Test channel /Freq.	Test Mode	SAR Value (W/kg)		Power Drift (±5%)	Conducted power (dBm)	Tune-up power (dBm)	Scaled SAR 1g (W/Kg)	Date
			1g	10g					
Front Side	661/1880	GPRS(GMSK 4TS)	0.545	0.283	-4.77	25.99	27.00	0.688	2021/2/03
Back Side	661/1880	GPRS(GMSK 4TS)	0.722	0.369	-0.72	25.99	27.00	0.911	2021/2/03
Left Side	661/1880	GPRS(GMSK 4TS)	0.336	0.168	0.04	25.99	27.00	0.424	2021/2/03
Right Side	661/1880	GPRS(GMSK 4TS)	0.266	0.139	-3.55	25.99	27.00	0.336	2021/2/03
Bottom Side	661/1880	GPRS(GMSK 4TS)	0.514	0.258	-4.47	25.99	27.00	0.649	2021/2/03
Back Side	512/1850.2	GPRS(GMSK 4TS)	0.679	0.355	1.25	25.41	27.00	0.979	2021/2/03

Back Side	810/1909.8	GPRS(GMSK 4TS)	0.701	0.359	0.34	26.56	27.00	0.776	2021/2/03
-----------	------------	-------------------	-------	-------	------	-------	-------	-------	-----------

NOTE: Hotspot SAR test results of GSM1900

10.1.3. SAR measurement Result of WCDMA Band 2

Test Position of Head	Test channel /Freq.	Test Mode	SAR Value (W/kg)		Power Drift (±5%)	Conducted power (dBm)	Tune-up power (dBm)	Scaled SAR 1g (W/Kg)	Date
			1g	10g					
Left Cheek	9400/1880	RMC12.2K	0.283	0.167	-2.93	23.13	23.50	0.308	2021/2/03
Left Tilt 15 Degree	9400/1880	RMC12.2K	0.147	0.089	4.45	23.13	23.50	0.160	2021/2/03
Right Cheek	9400/1880	RMC12.2K	0.259	0.152	-2.67	23.13	23.50	0.282	2021/2/03
Right Tilt 15 Degree	9400/1880	RMC12.2K	0.140	0.085	2.04	23.13	23.50	0.152	2021/2/03

NOTE: Head SAR test results of WCDMA Band 2

Test Position of Body-Worn with 10mm	Test channel /Freq.	Test Mode	SAR Value (W/kg)		Power Drift (±5%)	Conducted power (dBm)	Tune-up power (dBm)	Scaled SAR 1g (W/Kg)	Date
			1g	10g					
Front Side	9400/1880	RMC12.2K	0.676	0.349	-4.48	23.13	23.50	0.736	2021/2/03
Back Side	9400/1880	RMC12.2K	0.837	0.438	-1.95	23.13	23.50	0.911	2021/2/03
Back Side Repeated	9400/1880	RMC12.2K	0.834	0.436	0.37	23.13	23.50	0.908	2021/2/03
Back Side	9262/1852.4	RMC12.2K	0.806	0.423	-2.10	23.14	23.50	0.876	2021/2/03
Back Side	9538/1907.6	RMC12.2K	0.819	0.422	-1.18	22.59	23.50	1.010	2021/2/03

NOTE: Body-Worn SAR test results of WCDMA Band 2

Test Position of Hotspot with 10mm	Test channel /Freq.	Test Mode	SAR Value (W/kg)		Power Drift (±5%)	Conducted power (dBm)	Tune-up power (dBm)	Scaled SAR 1g (W/Kg)	Date
			1g	10g					
Front Side	9400/1880	RMC12.2K	0.676	0.349	-4.48	23.13	23.50	0.736	2021/2/03
Back Side	9400/1880	RMC12.2K	0.837	0.438	-1.95	23.13	23.50	0.911	2021/2/03
Back Side Repeated	9400/1880	RMC12.2K	0.834	0.436	0.37	23.13	23.50	0.908	2021/2/03
Left Side	9400/1880	RMC12.2K	0.400	0.205	4.46	23.13	23.50	0.436	2021/2/03

Right Side	9400/1880	RMC12.2K	0.306	0.157	-4.24	23.13	23.50	0.333	2021/2/03
Bottom Side	9400/1880	RMC12.2K	0.657	0.346	-1.23	23.13	23.50	0.715	2021/2/03
Back Side	9262/1852.4	RMC12.2K	0.806	0.423	-2.10	23.14	23.50	0.876	2021/2/03
Back Side	9538/1907.6	RMC12.2K	0.819	0.422	-1.18	22.59	23.50	1.010	2021/2/03

NOTE: Hotspot SAR test results of WCDMA Band 2

10.1.4. SAR measurement Result of WCDMA Band 4

Test Position of Head	Test channel /Freq.	Test Mode	SAR Value (W/kg)		Power Drift (±5%)	Conducted power (dBm)	Tune-up power (dBm)	Scaled SAR 1g (W/Kg)	Date
			1g	10g					
Left Cheek	1413/1732.6	RMC12.2K	0.277	0.171	0.41	23.25	23.50	0.293	2021/2/26
Left Tilt 15 Degree	1413/1732.6	RMC12.2K	0.160	0.098	3.51	23.25	23.50	0.169	2021/2/26
Right Cheek	1413/1732.6	RMC12.2K	0.247	0.151	3.03	23.25	23.50	0.262	2021/2/26
Right Tilt 15 Degree	1413/1732.6	RMC12.2K	0.130	0.082	-0.43	23.25	23.50	0.138	2021/2/26

NOTE: Head SAR test results of WCDMA Band 4

Test Position of Body-Worn with 10mm	Test channel /Freq.	Test Mode	SAR Value (W/kg)		Power Drift (±5%)	Conducted power (dBm)	Tune-up power (dBm)	Scaled SAR 1g (W/Kg)	Date
			1g	10g					
Front Side	1413/1732.6	RMC12.2K	0.684	0.365	1.36	23.25	23.50	0.725	2021/2/26
Back Side	1413/1732.6	RMC12.2K	0.863	0.459	-1.36	23.25	23.50	0.914	2021/2/26
Back Side	1312/1712.4	RMC12.2K	1.019	0.549	-0.30	23.36	23.50	1.052	2021/2/26
Back Side Repeated	1312/1712.4	RMC12.2K	1.010	0.548	1.25	23.36	23.50	1.043	2021/2/26
Back Side	1513/1752.6	RMC12.2K	0.766	0.410	-1.22	23.23	23.50	0.815	2021/2/26

NOTE: Body-Worn SAR test results of WCDMA Band 4

Test Position of Hotspot with 10mm	Test channel /Freq.	Test Mode	SAR Value (W/kg)		Power Drift (±5%)	Conducted power (dBm)	Tune-up power (dBm)	Scaled SAR 1g (W/Kg)	Date
			1g	10g					
Front Side	1413/1732.6	RMC12.2K	0.684	0.365	1.36	23.25	23.50	0.725	2021/2/26
Back Side	1413/1732.6	RMC12.2K	0.863	0.459	-1.36	23.25	23.50	0.914	2021/2/26
Left Side	1413/1732.6	RMC12.2K	0.386	0.207	3.00	23.25	23.50	0.409	2021/2/26
Right Side	1413/1732.6	RMC12.2K	0.327	0.173	4.99	23.25	23.50	0.346	2021/2/26

Bottom Side	1413/1732.6	RMC12.2K	0.677	0.358	4.96	23.25	23.50	0.717	2021/2/26
Back Side	1312/1712.4	RMC12.2K	1.019	0.549	-0.30	23.36	23.50	1.052	2021/2/26
Back Side Repeated	1312/1712.4	RMC12.2K	1.010	0.548	1.25	23.36	23.50	1.043	2021/2/26
Back Side	1513/1752.6	RMC12.2K	0.766	0.410	-1.22	23.23	23.50	0.815	2021/2/26

NOTE: Hotspot SAR test results of WCDMA Band 4

10.1.5. SAR measurement Result of WCDMA Band 5

Test Position of Head	Test channel /Freq.	Test Mode	SAR Value (W/kg)		Power Drift ($\pm 5\%$)	Conducted power (dBm)	Tune-up power (dBm)	Scaled SAR 1g (W/Kg)	Date
			1g	10g					
Left Cheek	4182/836.4	RMC12.2K	0.308	0.230	-1.65	22.73	23.00	0.328	2021/2/02
Left Tilt 15 Degree	4182/836.4	RMC12.2K	0.169	0.127	3.96	22.73	23.00	0.180	2021/2/02
Right Cheek	4182/836.4	RMC12.2K	0.280	0.208	2.17	22.73	23.00	0.298	2021/2/02
Right Tilt 15 Degree	4182/836.4	RMC12.2K	0.128	0.097	-4.43	22.73	23.00	0.136	2021/2/02

NOTE: Head SAR test results of WCDMA Band 5

Test Position of Body-Worn with 10mm	Test channel /Freq.	Test Mode	SAR Value (W/kg)		Power Drift ($\pm 5\%$)	Conducted power (dBm)	Tune-up power (dBm)	Scaled SAR 1g (W/Kg)	Date
			1g	10g					
Front Side	4182/836.4	RMC12.2K	0.264	0.197	1.92	22.73	23.00	0.281	2021/2/02
Back Side	4182/836.4	RMC12.2K	0.332	0.250	-0.07	22.73	23.00	0.353	2021/2/02

NOTE: Body-Worn SAR test results of WCDMA Band 5

Test Position of Hotspot with 10mm	Test channel /Freq.	Test Mode	SAR Value (W/kg)		Power Drift ($\pm 5\%$)	Conducted power (dBm)	Tune-up power (dBm)	Scaled SAR 1g (W/Kg)	Date
			1g	10g					
Front Side	4182/836.4	RMC12.2K	0.264	0.197	1.92	22.73	23.00	0.281	2021/2/02
Back Side	4182/836.4	RMC12.2K	0.332	0.250	-0.07	22.73	23.00	0.353	2021/2/02
Left Side	4182/836.4	RMC12.2K	0.159	0.120	4.10	22.73	23.00	0.169	2021/2/02
Right Side	4182/836.4	RMC12.2K	0.115	0.086	3.25	22.73	23.00	0.122	2021/2/02
Bottom Side	4182/836.4	RMC12.2K	0.238	0.178	3.71	22.73	23.00	0.253	2021/2/02

NOTE: Hotspot SAR test results of WCDMA Band 5

10.1.6. SAR measurement Result of LTE Band 2

Test Position of Head	Test channel /Freq.	Test Mode	SAR Value (W/kg)		Power Drift (±5%)	Conducted power (dBm)	Tune-up power (dBm)	Scaled SAR 1g (W/Kg)	Date
			1g	10g					
1RB									
Left Cheek	18900/1880	20M QPSK(1,49)	0.312	0.182	-4.13	23.22	23.50	0.333	2021/2/03
Left Tilt 15 Degree	18900/1880	20M QPSK(1,49)	0.170	0.098	-0.85	23.22	23.50	0.181	2021/2/03
Right Cheek	18900/1880	20M QPSK(1,49)	0.295	0.177	4.80	23.22	23.50	0.315	2021/2/03
Right Tilt 15 Degree	18900/1880	20M QPSK(1,49)	0.150	0.083	-3.37	23.22	23.50	0.160	2021/2/03
50%RB									
Left Cheek	18900/1880	1.4M QPSK(3,1)	0.286	0.168	-4.84	23.13	23.50	0.311	2021/2/03
Left Tilt 15 Degree	18900/1880	1.4M QPSK(3,1)	0.159	0.089	0.22	23.13	23.50	0.173	2021/2/03
Right Cheek	18900/1880	1.4M QPSK(3,1)	0.275	0.155	1.57	23.13	23.50	0.299	2021/2/03
Right Tilt 15 Degree	18900/1880	1.4M QPSK(3,1)	0.134	0.071	-2.79	23.13	23.50	0.146	2021/2/03

NOTE: Head SAR test results of LTE Band 2

Test Position of Body-Worn with 10mm	Test channel /Freq.	Test Mode	SAR Value (W/kg)		Power Drift (±5%)	Conducted power (dBm)	Tune-up power (dBm)	Scaled SAR 1g (W/Kg)	Date
			1g	10g					
1RB									
Front Side	18900/1880	20M QPSK(1,49)	0.684	0.351	-4.59	23.22	23.50	0.730	2021/2/03
Back Side	18900/1880	20M QPSK(1,49)	0.877	0.451	-0.14	23.22	23.50	0.935	2021/2/03
Back Side Repeated	18900/1880	20M QPSK(1,49)	0.870	0.450	1.25	23.22	23.50	0.928	2021/2/03
Back Side	18700/1860	20M	0.867	0.445	-0.29	23.27	23.50	0.914	2021/2/03

		QPSK(1,49)							
Back Side	19100/1900	20M QPSK(1,49)	0.871	0.444	-0.81	22.82	23.50	1.019	2021/2/03
50%RB									
Front Side	18900/1880	1.4M QPSK(3,1)	0.366	0.200	-4.69	23.13	23.50	0.399	2021/2/03
Back Side	18900/1880	1.4M QPSK(3,1)	0.465	0.237	0.08	23.13	23.50	0.506	2021/2/03
100%RB									
Back Side	18900/1880	20M QPSK(100,0)	0.335	0.195	0.08	22.05	22.50	0.372	2021/2/03

NOTE: Body-Worn SAR test results of LTE Band 2

Test Position of Hotspot with 10mm	Test channel /Freq.	Test Mode	SAR Value (W/kg)		Power Drift (±5%)	Conducted power (dBm)	Tune-up power (dBm)	Scaled SAR 1g (W/Kg)	Date
			1g	10g					
1RB									
Front Side	18900/1880	20M QPSK(1,49)	0.684	0.351	-4.59	23.22	23.50	0.730	2021/2/03
Back Side	18900/1880	20M QPSK(1,49)	0.877	0.451	-0.14	23.22	23.50	0.935	2021/2/03
Back Side Repeated	18900/1880	20M QPSK(1,49)	0.870	0.450	1.25	23.22	23.50	0.928	2021/2/03
Left Side	18900/1880	20M QPSK(1,49)	0.390	0.201	-3.63	23.22	23.50	0.416	2021/2/03
Right Side	18900/1880	20M QPSK(1,49)	0.313	0.158	0.41	23.22	23.50	0.334	2021/2/03
Bottom Side	18900/1880	20M QPSK(1,49)	0.639	0.330	2.79	23.22	23.50	0.682	2021/2/03
Back Side	18700/1860	20M QPSK(1,49)	0.867	0.445	-0.29	23.27	23.50	0.914	2021/2/03
Back Side	19100/1900	20M QPSK(1,49)	0.871	0.444	-0.81	22.82	23.50	1.019	2021/2/03
50%RB									
Front Side	18900/1880	1.4M QPSK(3,1)	0.366	0.200	-4.69	23.13	23.50	0.399	2021/2/03
Back Side	18900/1880	1.4M QPSK(3,1)	0.465	0.237	0.08	23.13	23.50	0.506	2021/2/03
Left Side	18900/1880	1.4M	0.210	0.111	-2.28	23.13	23.50	0.229	2021/2/03

		QPSK(3,1)							
Right Side	18900/1880	1.4M QPSK(3,1)	0.179	0.086	2.19	23.13	23.50	0.195	2021/2/03
Bottom Side	18900/1880	1.4M QPSK(3,1)	0.328	0.193	3.63	23.13	23.50	0.357	2021/2/03
100%RB									
Back Side	18900/1880	20M QPSK(100,0)	0.335	0.195	0.08	22.05	22.50	0.372	2021/2/03

NOTE: Hotspot SAR test results of LTE Band 2

10.1.7. SAR measurement Result of LTE Band 4

Test Position of Head	Test channel /Freq.	Test Mode	SAR Value (W/kg)		Power Drift (±5%)	Conducted power (dBm)	Tune-up power (dBm)	Scaled SAR 1g (W/Kg)	Date
			1g	10g					
1RB									
Left Cheek	20175/1732.5	20M QPSK(1,49)	0.390	0.237	-2.88	24.00	24.00	0.390	2021/2/26
Left Tilt 15 Degree	20175/1732.5	20M QPSK(1,49)	0.222	0.131	-1.71	24.00	24.00	0.222	2021/2/26
Right Cheek	20175/1732.5	20M QPSK(1,49)	0.357	0.213	-1.33	24.00	24.00	0.357	2021/2/26
Right Tilt 15 Degree	20175/1732.5	20M QPSK(1,49)	0.193	0.114	-2.94	24.00	24.00	0.193	2021/2/26
50%RB									
Left Cheek	20175/1732.5	1.4M QPSK(3,1)	0.354	0.219	-1.64	23.44	24.00	0.403	2021/2/26
Left Tilt 15 Degree	20175/1732.5	1.4M QPSK(3,1)	0.198	0.123	-4.41	23.44	24.00	0.225	2021/2/26
Right Cheek	20175/1732.5	1.4M QPSK(3,1)	0.326	0.190	3.70	23.44	24.00	0.371	2021/2/26
Right Tilt 15 Degree	20175/1732.5	1.4M QPSK(3,1)	0.174	0.102	-3.44	23.44	24.00	0.198	2021/2/26

NOTE: Head SAR test results of LTE Band 4

Test	Test channel	Test Mode	SAR Value	Power	Conducted	Tune-up	Scaled	Date
------	--------------	-----------	-----------	-------	-----------	---------	--------	------

Position of Body-Worn with 10mm	/Freq.		(W/kg)		Drift (±5%)	power (dBm)	power (dBm)	SAR 1g (W/Kg)	
			1g	10g					
1RB									
Front Side	20175/1732.5	20M QPSK(1,49)	0.608	0.324	-4.07	24.00	24.00	0.608	2021/2/26
Back Side	20175/1732.5	20M QPSK(1,49)	1.138	0.605	-2.36	24.00	24.00	1.138	2021/2/26
Back Side Repeated	20175/1732.5	20M QPSK(1,49)	1.130	0.600	-1.36	24.00	24.00	1.130	2021/2/26
Back Side	20050/1720	20M QPSK(1,49)	1.010	0.535	-1.03	23.40	24.00	1.160	2021/2/26
Back Side	20300/1745	20M QPSK(1,49)	1.017	0.539	-0.76	23.36	24.00	1.178	2021/2/26
50%RB									
Front Side	20175/1732.5	1.4M QPSK(3,1)	0.315	0.173	-2.53	23.44	24.00	0.358	2021/2/26
Back Side	20175/1732.5	1.4M QPSK(3,1)	0.603	0.325	-2.95	23.44	24.00	0.686	2021/2/26
100%RB									
Back Side	20175/1732.5	1.4M QPSK(6,0)	0.245	0.115	1.25	22.35	23.00	0.285	2021/2/26

NOTE: Body-Worn SAR test results of LTE Band 4

Test Position of Hotspot with 10mm	Test channel /Freq.	Test Mode	SAR Value (W/kg)		Power Drift (±5%)	Conducted power (dBm)	Tune-up power (dBm)	Scaled SAR 1g (W/Kg)	Date
			1g	10g					
1RB									
Front Side	20175/1732.5	20M QPSK(1,49)	0.608	0.324	-4.07	24.00	24.00	0.608	2021/2/26
Back Side	20175/1732.5	20M QPSK(1,49)	1.138	0.605	-2.36	24.00	24.00	1.138	2021/2/26
Back Side Repeated	20175/1732.5	20M QPSK(1,49)	1.130	0.600	-1.36	24.00	24.00	1.130	2021/2/26
Left Side	20175/1732.5	20M QPSK(1,49)	0.543	0.285	-1.28	24.00	24.00	0.543	2021/2/26
Right Side	20175/1732.5	20M QPSK(1,49)	0.414	0.219	-3.96	24.00	24.00	0.414	2021/2/26
Bottom	20175/1732.5	20M	0.619	0.330	-1.74	24.00	24.00	0.619	2021/2/26

Side		QPSK(1,49)							
Back Side	20050/1720	20M QPSK(1,49)	1.010	0.535	-1.03	23.40	24.00	1.160	2021/2/26
Back Side	20300/1745	20M QPSK(1,49)	1.017	0.539	-0.76	23.36	24.00	1.178	2021/2/26
50%RB									
Front Side	20175/1732.5	1.4M QPSK(3,1)	0.315	0.173	-2.53	23.44	24.00	0.358	2021/2/26
Back Side	20175/1732.5	1.4M QPSK(3,1)	0.603	0.325	-2.95	23.44	24.00	0.686	2021/2/26
Left Side	20175/1732.5	1.4M QPSK(3,1)	0.298	0.144	2.76	23.44	24.00	0.339	2021/2/26
Right Side	20175/1732.5	1.4M QPSK(3,1)	0.230	0.125	-1.75	23.44	24.00	0.262	2021/2/26
Bottom Side	20175/1732.5	1.4M QPSK(3,1)	0.362	0.171	3.76	23.44	24.00	0.412	2021/2/26
100%RB									
Back Side	20175/1732.5	1.4M QPSK(6,0)	0.245	0.115	1.25	22.35	23.00	0.285	2021/2/26

NOTE: Hotspot SAR test results of LTE Band 4

10.1.8. SAR measurement Result of LTE Band 5

Test Position of Head	Test channel /Freq.	Test Mode	SAR Value (W/kg)		Power Drift (±5%)	Conducted power (dBm)	Tune-up power (dBm)	Scaled SAR 1g (W/Kg)	Date
			1g	10g					
1RB									
Left Cheek	20525/836.5	10M QPSK(1,24)	0.329	0.284	-2.09	22.95	23.50	0.373	2021/2/02
Left Tilt 15 Degree	20525/836.5	10M QPSK(1,24)	0.179	0.150	1.77	22.95	23.50	0.203	2021/2/02
Right Cheek	20525/836.5	10M QPSK(1,24)	0.280	0.237	-2.23	22.95	23.50	0.318	2021/2/02
Right Tilt 15 Degree	20525/836.5	10M QPSK(1,24)	0.144	0.123	-0.33	22.95	23.50	0.163	2021/2/02
50%RB									
Left Cheek	20525/836.5	1.4M QPSK(3,2)	0.284	0.266	-3.78	22.84	23.00	0.295	2021/2/02

Left Tilt 15 Degree	20525/836.5	1.4M QPSK(3,2)	0.166	0.128	3.49	22.84	23.00	0.172	2021/2/02
Right Cheek	20525/836.5	1.4M QPSK(3,2)	0.241	0.222	-4.24	22.84	23.00	0.250	2021/2/02
Right Tilt 15 Degree	20525/836.5	1.4M QPSK(3,2)	0.124	0.107	0.42	22.84	23.00	0.129	2021/2/02

NOTE: Head SAR test results of LTE Band 5

Test Position of Body-Worn with 10mm	Test channel /Freq.	Test Mode	SAR Value (W/kg)		Power Drift (±5%)	Conducted power (dBm)	Tune-up power (dBm)	Scaled SAR 1g (W/Kg)	Date
			1g	10g					
1RB									
Front Side	20525/836.5	10M QPSK(1,24)	0.382	0.318	1.30	22.95	23.50	0.434	2021/2/02
Back Side	20525/836.5	10M QPSK(1,24)	0.459	0.386	-1.35	22.95	23.50	0.521	2021/2/02
50%RB									
Front Side	20525/836.5	1.4M QPSK(3,2)	0.353	0.273	-1.03	22.84	23.00	0.366	2021/2/02
Back Side	20525/836.5	1.4M QPSK(3,2)	0.401	0.354	2.50	22.84	23.00	0.416	2021/2/02

NOTE: Body-Worn SAR test results of LTE Band 5

Test Position of Hotspot with 10mm	Test channel /Freq.	Test Mode	SAR Value (W/kg)		Power Drift (±5%)	Conducted power (dBm)	Tune-up power (dBm)	Scaled SAR 1g (W/Kg)	Date
			1g	10g					
1RB									
Front Side	20525/836.5	10M QPSK(1,24)	0.382	0.318	1.30	22.95	23.50	0.434	2021/2/02
Back Side	20525/836.5	10M QPSK(1,24)	0.459	0.386	-1.35	22.95	23.50	0.521	2021/2/02
Left Side	20525/836.5	10M QPSK(1,24)	0.200	0.169	2.04	22.95	23.50	0.227	2021/2/02
Right Side	20525/836.5	10M QPSK(1,24)	0.158	0.132	-4.94	22.95	23.50	0.179	2021/2/02

Bottom Side	20525/836.5	10M QPSK(1,24)	0.353	0.301	1.44	22.95	23.50	0.401	2021/2/02
50%RB									
Front Side	20525/836.5	1.4M QPSK(3,2)	0.353	0.273	-1.03	22.84	23.00	0.366	2021/2/02
Back Side	20525/836.5	1.4M QPSK(3,2)	0.401	0.354	2.50	22.84	23.00	0.416	2021/2/02
Left Side	20525/836.5	1.4M QPSK(3,2)	0.186	0.154	-2.91	22.84	23.00	0.193	2021/2/02
Right Side	20525/836.5	1.4M QPSK(3,2)	0.137	0.118	-3.92	22.84	23.00	0.142	2021/2/02
Bottom Side	20525/836.5	1.4M QPSK(3,2)	0.308	0.281	4.14	22.84	23.00	0.320	2021/2/02

NOTE: Hotspot SAR test results of LTE Band 5

10.1.9. SAR measurement Result of LTE Band 7

Test Position of Head	Test channel /Freq.	Test Mode	SAR Value (W/kg)		Power Drift (±5%)	Conducted power (dBm)	Tune-up power (dBm)	Scaled SAR 1g (W/Kg)	Date
			1g	10g					
1RB									
Left Cheek	21100/2535	20M QPSK(1,49)	0.253	0.145	1.26	23.40	24.00	0.290	2021/2/03
Left Tilt 15 Degree	21100/2535	20M QPSK(1,49)	0.152	0.091	2.05	23.40	24.00	0.175	2021/2/03
Right Cheek	21100/2535	20M QPSK(1,49)	0.237	0.132	-1.57	23.40	24.00	0.272	2021/2/03
Right Tilt 15 Degree	21100/2535	20M QPSK(1,49)	0.125	0.068	3.43	23.40	24.00	0.144	2021/2/03
50%RB									
Left Cheek	21100/2535	20M QPSK(50,49)	0.225	0.132	1.20	22.22	22.50	0.240	2021/2/03
Left Tilt 15 Degree	21100/2535	20M QPSK(50,49)	0.141	0.079	0.08	22.22	22.50	0.150	2021/2/03
Right Cheek	21100/2535	20M QPSK(50,49)	0.204	0.112	-2.52	22.22	22.50	0.218	2021/2/03
Right	21100/2535	20M	0.114	0.064	1.49	22.22	22.50	0.122	2021/2/03

Tilt 15 Degree		QPSK(50,49)							
----------------	--	-------------	--	--	--	--	--	--	--

NOTE: Head SAR test results of LTE Band 7

Test Position of Body-Worn with 10mm	Test channel /Freq.	Test Mode	SAR Value (W/kg)		Power Drift (±5%)	Conducted power (dBm)	Tune-up power (dBm)	Scaled SAR 1g (W/Kg)	Date
			1g	10g					
1RB									
Front Side	21100/2535	20M QPSK(1,49)	0.563	0.267	2.13	23.40	24.00	0.646	2021/2/03
Back Side	21100/2535	20M QPSK(1,49)	0.993	0.466	-3.21	23.40	24.00	1.140	2021/2/03
Back Side	20850/2510	20M QPSK(1,49)	1.021	0.462	-1.51	24.00	24.00	1.021	2021/2/03
Back Side Repeated	20850/2510	20M QPSK(1,49)	1.016	0.459	-1.23	24.00	24.00	1.016	2021/2/03
Back Side	21350/2560	20M QPSK(1,49)	1.014	0.459	0.22	23.44	24.00	1.154	2021/2/03
50%RB									
Front Side	21100/2535	20M QPSK(50,49)	0.315	0.151	2.52	22.22	22.50	0.336	2021/2/03
Back Side	21100/2535	20M QPSK(50,49)	0.584	0.235	-1.55	22.22	22.50	0.623	2021/2/03
100%RB									
Back Side	21100/2535	20M QPSK(100,0)	0.443	0.185	0.23	22.22	22.50	0.473	2021/2/03

NOTE: Body-Worn SAR test results of LTE Band 7

Test Position of Hotspot with 10mm	Test channel /Freq.	Test Mode	SAR Value (W/kg)		Power Drift (±5%)	Conducted power (dBm)	Tune-up power (dBm)	Scaled SAR 1g (W/Kg)	Date
			1g	10g					
1RB									
Front Side	21100/2535	20M QPSK(1,49)	0.563	0.267	2.13	23.40	24.00	0.646	2021/2/03
Back Side	21100/2535	20M QPSK(1,49)	0.993	0.466	-3.21	23.40	24.00	1.140	2021/2/03
Left Side	21100/2535	20M	0.476	0.225	0.87	23.40	24.00	0.547	2021/2/03

		QPSK(1,49)							
Right Side	21100/2535	20M QPSK(1,49)	0.387	0.177	2.15	23.40	24.00	0.444	2021/2/03
Bottom Side	21100/2535	20M QPSK(1,49)	0.558	0.263	0.86	23.40	24.00	0.641	2021/2/03
Back Side	20850/2510	20M QPSK(1,49)	1.021	0.462	-1.51	24.00	24.00	1.021	2021/2/03
Back Side Repeated	20850/2510	20M QPSK(1,49)	1.016	0.459	-1.23	24.00	24.00	1.016	2021/2/03
Back Side	21350/2560	20M QPSK(1,49)	1.014	0.459	0.22	23.44	24.00	1.154	2021/2/03
50%RB									
Front Side	21100/2535	20M QPSK(50,49)	0.315	0.151	2.52	22.22	22.50	0.336	2021/2/03
Back Side	21100/2535	20M QPSK(50,49)	0.584	0.235	-1.55	22.22	22.50	0.623	2021/2/03
Left Side	21100/2535	20M QPSK(50,49)	0.284	0.123	-4.12	22.22	22.50	0.303	2021/2/03
Right Side	21100/2535	20M QPSK(50,49)	0.223	0.093	3.40	22.22	22.50	0.238	2021/2/03
Bottom Side	21100/2535	20M QPSK(50,49)	0.302	0.153	4.67	22.22	22.50	0.322	2021/2/03
100%RB									
Back Side	21100/2535	20M QPSK(100,0)	0.443	0.185	0.23	22.22	22.50	0.473	2021/2/03

NOTE: Hotspot SAR test results of LTE Band 7

10.1.10. SAR measurement Result of LTE Band 12

Test Position of Head	Test channel /Freq.	Test Mode	SAR Value (W/kg)		Power Drift (±5%)	Conducted power (dBm)	Tune-up power (dBm)	Scaled SAR 1g (W/Kg)	Date
			1g	10g					
1RB									
Left Cheek	23095/707.5	10M QPSK(1,24)	0.268	0.173	-3.36	22.42	23.00	0.306	2021/2/20
Left Tilt 15 Degree	23095/707.5	10M QPSK(1,24)	0.151	0.100	-1.54	22.42	23.00	0.173	2021/2/20
Right Cheek	23095/707.5	10M QPSK(1,24)	0.243	0.155	-3.05	22.42	23.00	0.278	2021/2/20

Right Tilt 15 Degree	23095/707.5	10M QPSK(1,24)	0.128	0.083	-0.21	22.42	23.00	0.146	2021/2/20
50%RB									
Left Cheek	23095/707.5	1.4M QPSK(3,0)	0.232	0.162	-4.44	22.42	23.00	0.265	2021/2/20
Left Tilt 15 Degree	23095/707.5	1.4M QPSK(3,0)	0.138	0.091	-1.88	22.42	23.00	0.158	2021/2/20
Right Cheek	23095/707.5	1.4M QPSK(3,0)	0.225	0.137	-2.48	22.42	23.00	0.257	2021/2/20
Right Tilt 15 Degree	23095/707.5	1.4M QPSK(3,0)	0.119	0.074	-3.83	22.42	23.00	0.136	2021/2/20

NOTE: Head SAR test results of LTE Band 12

Test Position of Body-Worn with 10mm	Test channel /Freq.	Test Mode	SAR Value (W/kg)		Power Drift (±5%)	Conducted power (dBm)	Tune-up power (dBm)	Scaled SAR 1g (W/Kg)	Date
			1g	10g					
1RB									
Front Side	23095/707.5	10M QPSK(1,24)	0.421	0.361	2.26	22.42	23.00	0.481	2021/2/20
Back Side	23095/707.5	10M QPSK(1,24)	0.534	0.458	-0.11	22.42	23.00	0.610	2021/2/20
50%RB									
Front Side	23095/707.5	1.4M QPSK(3,0)	0.361	0.342	4.38	22.42	23.00	0.413	2021/2/20
Back Side	23095/707.5	1.4M QPSK(3,0)	0.475	0.391	-2.09	22.42	23.00	0.543	2021/2/20

NOTE: Body-Worn SAR test results of LTE Band 12

Test Position of Hotspot with 10mm	Test channel /Freq.	Test Mode	SAR Value (W/kg)		Power Drift (±5%)	Conducted power (dBm)	Tune-up power (dBm)	Scaled SAR 1g (W/Kg)	Date
			1g	10g					
1RB									
Front Side	23095/707.5	10M QPSK(1,24)	0.421	0.361	2.26	22.42	23.00	0.481	2021/2/20
Back Side	23095/707.5	10M QPSK(1,24)	0.534	0.458	-0.11	22.42	23.00	0.610	2021/2/20
Left Side	23095/707.5	10M QPSK(1,24)	0.246	0.215	-0.68	22.42	23.00	0.281	2021/2/20

Right Side	23095/707.5	10M QPSK(1,24)	0.183	0.157	1.84	22.42	23.00	0.209	2021/2/20
Bottom Side	23095/707.5	10M QPSK(1,24)	0.424	0.368	3.37	22.42	23.00	0.485	2021/2/20
50%RB									
Front Side	23095/707.5	1.4M QPSK(3,0)	0.361	0.342	4.38	22.42	23.00	0.413	2021/2/20
Back Side	23095/707.5	1.4M QPSK(3,0)	0.475	0.391	-2.09	22.42	23.00	0.543	2021/2/20
Left Side	23095/707.5	1.4M QPSK(3,0)	0.211	0.204	4.93	22.42	23.00	0.241	2021/2/20
Right Side	23095/707.5	1.4M QPSK(3,0)	0.160	0.139	3.04	22.42	23.00	0.183	2021/2/20
Bottom Side	23095/707.5	1.4M QPSK(3,0)	0.379	0.327	-4.61	22.42	23.00	0.433	2021/2/20

NOTE: Hotspot SAR test results of LTE Band 12

10.1.11. SAR measurement Result of LTE Band 13

Test Position of Head	Test channel /Freq.	Test Mode	SAR Value (W/kg)		Power Drift (±5%)	Conducted power (dBm)	Tune-up power (dBm)	Scaled SAR 1g (W/Kg)	Date
			1g	10g					
1RB									
Left Cheek	23230/782	10M QPSK(1,24)	0.218	0.188	2.91	22.08	22.50	0.240	2021/2/20
Left Tilt 15 Degree	23230/782	10M QPSK(1,24)	0.129	0.111	1.36	22.08	22.50	0.142	2021/2/20
Right Cheek	23230/782	10M QPSK(1,24)	0.191	0.169	-0.47	22.08	22.50	0.210	2021/2/20
Right Tilt 15 Degree	23230/782	10M QPSK(1,24)	0.093	0.084	1.93	22.08	22.50	0.102	2021/2/20
50%RB									
Left Cheek	23230/782	5M QPSK(12,11)	0.201	0.161	3.04	20.86	21.50	0.233	2021/2/20
Left Tilt 15 Degree	23230/782	5M QPSK(12,11)	0.118	0.102	3.75	20.86	21.50	0.137	2021/2/20
Right	23230/782	5M	0.165	0.151	-3.64	20.86	21.50	0.191	2021/2/20

Cheek		QPSK(12,11)							
Right Tilt 15 Degree	23230/782	5M QPSK(12,11)	0.086	0.078	3.40	20.86	21.50	0.100	2021/2/20

NOTE: Head SAR test results of LTE Band 13

Test Position of Body-Worn with 10mm	Test channel /Freq.	Test Mode	SAR Value (W/kg)		Power Drift (±5%)	Conducted power (dBm)	Tune-up power (dBm)	Scaled SAR 1g (W/Kg)	Date
			1g	10g					
1RB									
Front Side	23230/782	10M QPSK(1,24)	0.324	0.188	-1.82	22.08	22.50	0.357	2021/2/20
Back Side	23230/782	10M QPSK(1,24)	0.425	0.241	-1.36	22.08	22.50	0.468	2021/2/20
50%RB									
Front Side	23230/782	5M QPSK(12,11)	0.278	0.164	-0.63	20.86	21.50	0.322	2021/2/20
Back Side	23230/782	5M QPSK(12,11)	0.380	0.213	-3.96	20.86	21.50	0.440	2021/2/20

NOTE: Body-Worn SAR test results of LTE Band 13

Test Position of Hotspot with 10mm	Test channel /Freq.	Test Mode	SAR Value (W/kg)		Power Drift (±5%)	Conducted power (dBm)	Tune-up power (dBm)	Scaled SAR 1g (W/Kg)	Date
			1g	10g					
1RB									
Front Side	23230/782	10M QPSK(1,24)	0.324	0.188	-1.82	22.08	22.50	0.357	2021/2/20
Back Side	23230/782	10M QPSK(1,24)	0.425	0.241	-1.36	22.08	22.50	0.468	2021/2/20
Left Side	23230/782	10M QPSK(1,24)	0.188	0.106	4.11	22.08	22.50	0.207	2021/2/20
Right Side	23230/782	10M QPSK(1,24)	0.157	0.087	-3.15	22.08	22.50	0.173	2021/2/20
Bottom Side	23230/782	10M QPSK(1,24)	0.306	0.178	-0.80	22.08	22.50	0.337	2021/2/20
50%RB									
Front	23230/782	5M	0.278	0.164	-0.63	20.86	21.50	0.322	2021/2/20

Side		QPSK(12,11)							
Back Side	23230/782	5M QPSK(12,11)	0.380	0.213	-3.96	20.86	21.50	0.440	2021/2/20
Left Side	23230/782	5M QPSK(12,11)	0.163	0.097	3.97	20.86	21.50	0.189	2021/2/20
Right Side	23230/782	5M QPSK(12,11)	0.145	0.077	1.61	20.86	21.50	0.168	2021/2/20
Bottom Side	23230/782	5M QPSK(12,11)	0.262	0.153	-3.69	20.86	21.50	0.304	2021/2/20

NOTE: Hotspot SAR test results of LTE Band 13

10.1.12. SAR measurement Result of LTE Band 17

Test Position of Head	Test channel /Freq.	Test Mode	SAR Value (W/kg)		Power Drift (±5%)	Conducted power (dBm)	Tune-up power (dBm)	Scaled SAR 1g (W/Kg)	Date
			1g	10g					
1RB									
Left Cheek	23790/710	10M QPSK(1,49)	0.462	0.252	-0.23	22.32	23.00	0.540	2021/2/20
Left Tilt 15 Degree	23790/710	10M QPSK(1,49)	0.260	0.138	-4.61	22.32	23.00	0.304	2021/2/20
Right Cheek	23790/710	10M QPSK(1,49)	0.420	0.230	1.43	22.32	23.00	0.491	2021/2/20
Right Tilt 15 Degree	23790/710	10M QPSK(1,49)	0.218	0.116	4.48	22.32	23.00	0.255	2021/2/20
50%RB									
Left Cheek	23790/710	10M QPSK(25,0)	0.419	0.226	-4.61	21.14	21.50	0.455	2021/2/20
Left Tilt 15 Degree	23790/710	10M QPSK(25,0)	0.225	0.119	-3.81	21.14	21.50	0.244	2021/2/20
Right Cheek	23790/710	10M QPSK(25,0)	0.360	0.205	2.95	21.14	21.50	0.391	2021/2/20
Right Tilt 15 Degree	23790/710	10M QPSK(25,0)	0.188	0.102	-3.49	21.14	21.50	0.204	2021/2/20

NOTE: Head SAR test results of LTE Band17

Test Position of Body-Worn with 10mm	Test channel /Freq.	Test Mode	SAR Value (W/kg)		Power Drift (±5%)	Conducted power (dBm)	Tune-up power (dBm)	Scaled SAR 1g (W/Kg)	Date
			1g	10g					
1RB									
Front Side	23790/710	10M QPSK(1,49)	0.400	0.341	-4.07	22.32	23.00	0.468	2021/2/20
Back Side	23790/710	10M QPSK(1,49)	0.528	0.453	0.46	22.32	23.00	0.617	2021/2/20
50%RB									
Front Side	23790/710	10M QPSK(25,0)	0.343	0.316	-4.44	21.14	21.50	0.373	2021/2/20
Back Side	23790/710	10M QPSK(25,0)	0.459	0.424	-2.10	21.14	21.50	0.499	2021/2/20

NOTE: Body-Worn SAR test results of LTE Band 17

Test Position of Hotspot with 10mm	Test channel /Freq.	Test Mode	SAR Value (W/kg)		Power Drift (±5%)	Conducted power (dBm)	Tune-up power (dBm)	Scaled SAR 1g (W/Kg)	Date
			1g	10g					
1RB									
Front Side	23790/710	10M QPSK(1,49)	0.400	0.341	-4.07	22.32	23.00	0.468	2021/2/20
Back Side	23790/710	10M QPSK(1,49)	0.528	0.453	0.46	22.32	23.00	0.617	2021/2/20
Left Side	23790/710	10M QPSK(1,49)	0.237	0.207	2.39	22.32	23.00	0.277	2021/2/20
Right Side	23790/710	10M QPSK(1,49)	0.197	0.165	-4.41	22.32	23.00	0.230	2021/2/20
Bottom Side	23790/710	10M QPSK(1,49)	0.385	0.334	-4.40	22.32	23.00	0.450	2021/2/20
50%RB									
Front Side	23790/710	10M QPSK(25,0)	0.343	0.316	-4.44	21.14	21.50	0.373	2021/2/20
Back Side	23790/710	10M QPSK(25,0)	0.459	0.424	-2.10	21.14	21.50	0.499	2021/2/20
Left Side	23790/710	10M QPSK(25,0)	0.215	0.182	2.12	21.14	21.50	0.234	2021/2/20
Right	23790/710	10M	0.176	0.147	-3.20	21.14	21.50	0.191	2021/2/20

Side		QPSK(25,0)							
Bottom Side	23790/710	10M QPSK(25,0)	0.343	0.313	-3.90	21.14	21.50	0.373	2021/2/20

NOTE: Hotspot SAR test results of LTE Band 17

10.1.13. SAR measurement Result of LTE Band 25

Test Position of Head	Test channel /Freq.	Test Mode	SAR Value (W/kg)		Power Drift (±5%)	Conducted power (dBm)	Tune-up power (dBm)	Scaled SAR 1g (W/Kg)	Date
			1g	10g					
1RB									
Left Cheek	26365/1882.5	20M QPSK(1,49)	0.303	0.176	-3.23	23.09	23.50	0.333	2021/2/3
Left Tilt 15 Degree	26365/1882.5	20M QPSK(1,49)	0.157	0.092	0.86	23.09	23.50	0.173	2021/2/3
Right Cheek	26365/1882.5	20M QPSK(1,49)	0.278	0.161	1.65	23.09	23.50	0.306	2021/2/3
Right Tilt 15 Degree	26365/1882.5	20M QPSK(1,49)	0.152	0.083	-1.07	23.09	23.50	0.167	2021/2/3
50%RB									
Left Cheek	26365/1882.5	1.4M QPSK(3,0)	0.259	0.155	-4.36	23.07	23.50	0.286	2021/2/3
Left Tilt 15 Degree	26365/1882.5	1.4M QPSK(3,0)	0.147	0.083	-2.48	23.07	23.50	0.162	2021/2/3
Right Cheek	26365/1882.5	1.4M QPSK(3,0)	0.246	0.153	-4.92	23.07	23.50	0.272	2021/2/3
Right Tilt 15 Degree	26365/1882.5	1.4M QPSK(3,0)	0.136	0.077	-3.40	23.07	23.50	0.150	2021/2/3

NOTE: Head SAR test results of LTE Band 25

Test Position of Body-Worn with 10mm	Test channel /Freq.	Test Mode	SAR Value (W/kg)		Power Drift (±5%)	Conducted power (dBm)	Tune-up power (dBm)	Scaled SAR 1g (W/Kg)	Date
			1g	10g					
1RB									
Front Side	26365/1882.5	20M QPSK(1,49)	0.714	0.339	-4.34	23.09	23.50	0.785	2021/2/3

Back Side	26365/1882.5	20M QPSK(1,49)	0.992	0.472	-1.64	23.09	23.50	1.090	2021/2/3
Back Side Repeated	26365/1882.5	20M QPSK(1,49)	0.987	0.470	2.31	23.09	23.50	1.085	2021/2/3
Back Side	26140/1860	20M QPSK(1,49)	0.809	0.425	-4.02	23.18	23.50	0.871	2021/2/3
Back Side	26590/1905	20M QPSK(1,49)	0.863	0.439	-0.99	22.57	23.50	1.069	2021/2/3
50%RB									
Front Side	26365/1882.5	1.4M QPSK(3,0)	0.383	0.177	-0.01	23.07	23.50	0.423	2021/2/3
Back Side	26365/1882.5	1.4M QPSK(3,0)	0.557	0.281	-2.90	23.07	23.50	0.615	2021/2/3
100%RB									
Back Side	26365/1882.5	20M QPSK(100,0)	0.336	0.168	1.24	21.97	22.50	0.380	2021/2/3

NOTE: Body-Worn SAR test results of LTE Band 25

Test Position of Hotspot with 10mm	Test channel /Freq.	Test Mode	SAR Value (W/kg)		Power Drift (±5%)	Conducted power (dBm)	Tune-up power (dBm)	Scaled SAR 1g (W/Kg)	Date
			1g	10g					
1RB									
Front Side	26365/1882.5	20M QPSK(1,49)	0.714	0.339	-4.34	23.09	23.50	0.785	2021/2/3
Back Side	26365/1882.5	20M QPSK(1,49)	0.992	0.472	-1.64	23.09	23.50	1.090	2021/2/3
Back Side Repeated	26365/1882.5	20M QPSK(1,49)	0.987	0.470	2.31	23.09	23.50	1.085	2021/2/3
Left Side	26365/1882.5	20M QPSK(1,49)	0.438	0.206	-0.01	23.09	23.50	0.481	2021/2/3
Right Side	26365/1882.5	20M QPSK(1,49)	0.386	0.181	-0.97	23.09	23.50	0.424	2021/2/3
Bottom Side	26365/1882.5	20M QPSK(1,49)	0.612	0.294	-3.41	23.09	23.50	0.673	2021/2/3
Back Side	26140/1860	20M QPSK(1,49)	0.809	0.425	-4.02	23.18	23.50	0.871	2021/2/3
Back Side	26590/1905	20M QPSK(1,49)	0.863	0.439	-0.99	22.57	23.50	1.069	2021/2/3

50%RB									
Front Side	26365/1882.5	1.4M QPSK(3,0)	0.383	0.177	-0.01	23.07	23.50	0.423	2021/2/3
Back Side	26365/1882.5	1.4M QPSK(3,0)	0.557	0.281	-2.90	23.07	23.50	0.615	2021/2/3
Left Side	26365/1882.5	1.4M QPSK(3,0)	0.256	0.110	-0.06	23.07	23.50	0.283	2021/2/3
Right Side	26365/1882.5	1.4M QPSK(3,0)	0.199	0.098	1.24	23.07	23.50	0.220	2021/2/3
Bottom Side	26365/1882.5	1.4M QPSK(3,0)	0.306	0.173	-2.46	23.07	23.50	0.338	2021/2/3
100%RB									
Back Side	26365/1882.5	20M QPSK(100,0)	0.336	0.168	1.24	21.97	22.50	0.380	2021/2/3

NOTE: Head SAR test results of LTE Band 25

10.1.14. SAR measurement Result of LTE Band 26A

Test Position of Head	Test channel /Freq.	Test Mode	SAR Value (W/kg)		Power Drift (±5%)	Conducted power (dBm)	Tune-up power (dBm)	Scaled SAR 1g (W/Kg)	Date
			1g	10g					
1RB									
Left Cheek	26740/819	10M QPSK(1,24)	0.254	0.188	1.20	23.81	24.00	0.265	2021/2/2
Left Tilt 15 Degree	26740/819	10M QPSK(1,24)	0.135	0.103	-4.86	23.81	24.00	0.141	2021/2/2
Right Cheek	26740/819	10M QPSK(1,24)	0.237	0.171	-4.95	23.81	24.00	0.248	2021/2/2
Right Tilt 15 Degree	26740/819	10M QPSK(1,24)	0.122	0.088	0.60	23.81	24.00	0.127	2021/2/2
50%RB									
Left Cheek	26740/819	1.4M QPSK(3,2)	0.217	0.174	3.39	23.56	24.00	0.240	2021/2/2
Left Tilt 15 Degree	26740/819	1.4M QPSK(3,2)	0.121	0.089	-4.40	23.56	24.00	0.134	2021/2/2
Right Cheek	26740/819	1.4M QPSK(3,2)	0.207	0.150	-0.65	23.56	24.00	0.229	2021/2/2

Right Tilt 15 Degree	26740/819	1.4M QPSK(3,2)	0.112	0.079	-3.35	23.56	24.00	0.124	2021/2/2
----------------------	-----------	----------------	-------	-------	-------	-------	-------	-------	----------

NOTE: Head SAR test results of LTE Band 26A

Test Position of Body-Worn with 10mm	Test channel /Freq.	Test Mode	SAR Value (W/kg)		Power Drift (±5%)	Conducted power (dBm)	Tune-up power (dBm)	Scaled SAR 1g (W/Kg)	Date
			1g	10g					
1RB									
Front Side	26740/819	10M QPSK(1,24)	0.144	0.110	-2.48	23.81	24.00	0.150	2021/2/2
Back Side	26740/819	10M QPSK(1,24)	0.230	0.174	0.87	23.81	24.00	0.240	2021/2/2
50%RB									
Front Side	26740/819	1.4M QPSK(3,2)	0.127	0.095	2.67	23.56	24.00	0.141	2021/2/2
Back Side	26740/819	1.4M QPSK(3,2)	0.213	0.162	-4.87	23.56	24.00	0.236	2021/2/2

NOTE: Body-Worn SAR test results of LTE Band 26A

Test Position of Hotspot with 10mm	Test channel /Freq.	Test Mode	SAR Value (W/kg)		Power Drift (±5%)	Conducted power (dBm)	Tune-up power (dBm)	Scaled SAR 1g (W/Kg)	Date
			1g	10g					
1RB									
Front Side	26740/819	10M QPSK(1,24)	0.144	0.110	-2.48	23.81	24.00	0.150	2021/2/2
Back Side	26740/819	10M QPSK(1,24)	0.230	0.174	0.87	23.81	24.00	0.240	2021/2/2
Left Side	26740/819	10M QPSK(1,24)	0.050	0.042	0.23	23.81	24.00	0.052	2021/2/2
Right Side	26740/819	10M QPSK(1,24)	0.078	0.056	-2.93	23.81	24.00	0.081	2021/2/2
Bottom Side	26740/819	10M QPSK(1,24)	0.170	0.115	4.10	23.81	24.00	0.178	2021/2/2
50%RB									
Front Side	26740/819	1.4M QPSK(3,2)	0.127	0.095	2.67	23.56	24.00	0.141	2021/2/2

Back Side	26740/819	1.4M QPSK(3,2)	0.213	0.162	-4.87	23.56	24.00	0.236	2021/2/2
Left Side	26740/819	1.4M QPSK(3,2)	0.043	0.038	0.41	23.56	24.00	0.048	2021/2/2
Right Side	26740/819	1.4M QPSK(3,2)	0.072	0.050	0.25	23.56	24.00	0.080	2021/2/2
Bottom Side	26740/819	1.4M QPSK(3,2)	0.136	0.086	-0.96	23.56	24.00	0.151	2021/2/2

NOTE: Hotspot SAR test results of LTE Band 26A

10.1.15. SAR measurement Result of LTE Band 26B

Test Position of Head	Test channel /Freq.	Test Mode	SAR Value (W/kg)		Power Drift (±5%)	Conducted power (dBm)	Tune-up power (dBm)	Scaled SAR 1g (W/Kg)	Date
			1g	10g					
1RB									
Left Cheek	26915/836.5	15M QPSK(1,37)	0.347	0.301	2.41	23.07	23.50	0.383	2021/2/2
Left Tilt 15 Degree	26915/836.5	15M QPSK(1,37)	0.200	0.171	-1.34	23.07	23.50	0.221	2021/2/2
Right Cheek	26915/836.5	15M QPSK(1,37)	0.303	0.262	-0.58	23.07	23.50	0.335	2021/2/2
Right Tilt 15 Degree	26915/836.5	15M QPSK(1,37)	0.140	0.123	-4.24	23.07	23.50	0.155	2021/2/2
50%RB									
Left Cheek	26915/836.5	1.4M QPSK(3,0)	0.299	0.283	1.82	22.82	23.00	0.312	2021/2/2
Left Tilt 15 Degree	26915/836.5	1.4M QPSK(3,0)	0.178	0.146	3.07	22.82	23.00	0.186	2021/2/2
Right Cheek	26915/836.5	1.4M QPSK(3,0)	0.265	0.245	3.21	22.82	23.00	0.276	2021/2/2
Right Tilt 15 Degree	26915/836.5	1.4M QPSK(3,0)	0.132	0.112	-1.54	22.82	23.00	0.138	2021/2/2

NOTE: Head SAR test results of LTE Band 26B

Test Position of Body-Worn with 10mm	Test channel /Freq.	Test Mode	SAR Value (W/kg)		Power Drift (±5%)	Conducted power (dBm)	Tune-up power (dBm)	Scaled SAR 1g (W/Kg)	Date
			1g	10g					
1RB									
Front Side	26915/836.5	15M QPSK(1,37)	0.372	0.316	1.64	23.07	23.50	0.411	2021/2/2
Back Side	26915/836.5	15M QPSK(1,37)	0.486	0.411	-1.99	23.07	23.50	0.537	2021/2/2
50%RB									
Front Side	26915/836.5	1.4M QPSK(3,0)	0.340	0.299	-4.63	22.82	23.00	0.354	2021/2/2
Back Side	26915/836.5	1.4M QPSK(3,0)	0.458	0.389	-2.04	22.82	23.00	0.477	2021/2/2

NOTE: Body-Worn SAR test results of LTE Band 26B

Test Position of Hotspot with 10mm	Test channel /Freq.	Test Mode	SAR Value (W/kg)		Power Drift (±5%)	Conducted power (dBm)	Tune-up power (dBm)	Scaled SAR 1g (W/Kg)	Date
			1g	10g					
1RB									
Front Side	26915/836.5	15M QPSK(1,37)	0.372	0.316	1.64	23.07	23.50	0.411	2021/2/2
Back Side	26915/836.5	15M QPSK(1,37)	0.486	0.411	-1.99	23.07	23.50	0.537	2021/2/2
Left Side	26915/836.5	15M QPSK(1,37)	0.234	0.193	-3.92	23.07	23.50	0.258	2021/2/2
Right Side	26915/836.5	15M QPSK(1,37)	0.193	0.161	0.55	23.07	23.50	0.213	2021/2/2
Bottom Side	26915/836.5	15M QPSK(1,37)	0.370	0.315	4.10	23.07	23.50	0.409	2021/2/2
50%RB									
Front Side	26915/836.5	1.4M QPSK(3,0)	0.340	0.299	-4.63	22.82	23.00	0.354	2021/2/2
Back Side	26915/836.5	1.4M QPSK(3,0)	0.458	0.389	-2.04	22.82	23.00	0.477	2021/2/2
Left Side	26915/836.5	1.4M QPSK(3,0)	0.216	0.181	-0.34	22.82	23.00	0.225	2021/2/2

Right Side	26915/836.5	1.4M QPSK(3,0)	0.180	0.149	-1.62	22.82	23.00	0.188	2021/2/2
Bottom Side	26915/836.5	1.4M QPSK(3,0)	0.336	0.286	-0.96	22.82	23.00	0.350	2021/2/2

NOTE: Hotspot SAR test results of LTE Band 26B

10.1.16. SAR measurement Result of LTE Band 41

Test Position of Head	Test channel /Freq.	Test Mode	SAR Value (W/kg)		Power Drift (±5%)	Conducted power (dBm)	Tune-up power (dBm)	Scaled SAR 1g (W/Kg)	Date
			1g	10g					
1RB									
Left Cheek	40640/2595	20M QPSK(1,49)	0.132	0.082	-0.04	24.03	24.50	0.147	2021/2/3
Left Tilt 15 Degree	40640/2595	20M QPSK(1,49)	0.071	0.047	3.74	24.03	24.50	0.079	2021/2/3
Right Cheek	40640/2595	20M QPSK(1,49)	0.113	0.068	1.16	24.03	24.50	0.126	2021/2/3
Right Tilt 15 Degree	40640/2595	20M QPSK(1,49)	0.061	0.034	-3.48	24.03	24.50	0.068	2021/2/3
50%RB									
Left Cheek	40640/2595	20M QPSK(50,49)	0.122	0.070	3.10	22.96	23.00	0.123	2021/2/3
Left Tilt 15 Degree	40640/2595	20M QPSK(50,49)	0.062	0.041	1.51	22.96	23.00	0.063	2021/2/3
Right Cheek	40640/2595	20M QPSK(50,49)	0.104	0.059	4.67	22.96	23.00	0.105	2021/2/3
Right Tilt 15 Degree	40640/2595	20M QPSK(50,49)	0.056	0.032	-1.38	22.96	23.00	0.057	2021/2/3

NOTE: Head SAR test results of LTE Band 41

Test Position of Body-Worn with 10mm	Test channel /Freq.	Test Mode	SAR Value (W/kg)		Power Drift (±5%)	Conducted power (dBm)	Tune-up power (dBm)	Scaled SAR 1g (W/Kg)	Date
			1g	10g					
1RB									
Front Side	40640/2595	20M QPSK(1,49)	0.623	0.285	1.97	24.03	24.50	0.694	2021/2/3

Back Side	40640/2595	20M QPSK(1,49)	0.821	0.377	2.95	24.03	24.50	0.915	2021/2/3
Back Side Repeated	40640/2595	20M QPSK(1,49)	0.816	0.373	1.23	24.03	24.50	0.909	2021/2/3
Back Side	40140/2545	20M QPSK(1,49)	0.801	0.356	1.33	23.60	24.50	0.985	2021/2/3
Back Side	41140/2645	20M QPSK(1,49)	0.785	0.349	0.34	24.00	24.50	0.881	2021/2/3
50%RB									
Front Side	40640/2595	20M QPSK(50,49)	0.538	0.246	1.85	22.96	23.00	0.543	2021/2/3
Back Side	40640/2595	20M QPSK(50,49)	0.772	0.343	3.30	22.96	23.00	0.779	2021/2/3
100%RB									
Back Side	40640/2595	20M QPSK(100,0)	0.672	0.333	-2.34	22.82	23.00	0.700	2021/2/3

NOTE: Body-Worn SAR test results of LTE Band 41

Test Position of Hotspot with 10mm	Test channel /Freq.	Test Mode	SAR Value (W/kg)		Power Drift (±5%)	Conducted power (dBm)	Tune-up power (dBm)	Scaled SAR 1g (W/Kg)	Date
			1g	10g					
1RB									
Front Side	40640/2595	20M QPSK(1,49)	0.623	0.285	1.97	24.03	24.50	0.694	2021/2/3
Back Side	40640/2595	20M QPSK(1,49)	0.821	0.377	2.95	24.03	24.50	0.915	2021/2/3
Back Side Repeated	40640/2595	20M QPSK(1,49)	0.816	0.373	1.23	24.03	24.50	0.909	2021/2/3
Left Side	40640/2595	20M QPSK(1,49)	0.376	0.170	-3.14	24.03	24.50	0.419	2021/2/3
Right Side	40640/2595	20M QPSK(1,49)	0.302	0.135	-4.31	24.03	24.50	0.337	2021/2/3
Bottom Side	40640/2595	20M QPSK(1,49)	0.612	0.279	4.32	24.03	24.50	0.682	2021/2/3
Back Side	40140/2545	20M QPSK(1,49)	0.801	0.356	1.33	23.60	24.50	0.985	2021/2/3
Back Side	41140/2645	20M QPSK(1,49)	0.785	0.349	0.34	24.00	24.50	0.881	2021/2/3
50%RB									

Front Side	40640/2595	20M QPSK(50,49)	0.538	0.246	1.85	22.96	23.00	0.543	2021/2/3
Back Side	40640/2595	20M QPSK(50,49)	0.772	0.343	3.30	22.96	23.00	0.779	2021/2/3
Left Side	40640/2595	20M QPSK(50,49)	0.357	0.155	-0.79	22.96	23.00	0.360	2021/2/3
Right Side	40640/2595	20M QPSK(50,49)	0.268	0.118	-2.15	22.96	23.00	0.270	2021/2/3
Bottom Side	40640/2595	20M QPSK(50,49)	0.539	0.258	-0.97	22.96	23.00	0.544	2021/2/3
100%RB									
Back Side	40640/2595	20M QPSK(100,0)	0.672	0.333	-2.34	22.82	23.00	0.700	2021/2/3

NOTE: Head SAR test results of LTE Band 41

10.1.17. SAR measurement Result of LTE Band 66

Test Position of Head	Test channel /Freq.	Test Mode	SAR Value (W/kg)		Power Drift (±5%)	Conducted power (dBm)	Tune-up power (dBm)	Scaled SAR 1g (W/Kg)	Date
			1g	10g					
1RB									
Left Cheek	132322/1745	20M QPSK(1,49)	0.310	0.179	-0.50	23.06	23.50	0.343	2021/2/26
Left Tilt 15 Degree	132322/1745	20M QPSK(1,49)	0.168	0.096	-3.24	23.06	23.50	0.186	2021/2/26
Right Cheek	132322/1745	20M QPSK(1,49)	0.266	0.146	3.88	23.06	23.50	0.294	2021/2/26
Right Tilt 15 Degree	132322/1745	20M QPSK(1,49)	0.123	0.068	-2.05	23.06	23.50	0.136	2021/2/26
50%RB									
Left Cheek	132322/1745	1.4M QPSK(3,2)	0.287	0.157	-1.63	22.99	23.50	0.323	2021/2/26
Left Tilt 15 Degree	132322/1745	1.4M QPSK(3,2)	0.158	0.089	3.38	22.99	23.50	0.178	2021/2/26
Right Cheek	132322/1745	1.4M QPSK(3,2)	0.237	0.129	-0.04	22.99	23.50	0.267	2021/2/26
Right Tilt 15 Degree	132322/1745	1.4M QPSK(3,2)	0.108	0.062	-3.18	22.99	23.50	0.121	2021/2/26

Degree									
--------	--	--	--	--	--	--	--	--	--

NOTE: Head SAR test results of LTE Band 66

Test Position of Body-Worn with 10mm	Test channel /Freq.	Test Mode	SAR Value (W/kg)		Power Drift (±5%)	Conducted power (dBm)	Tune-up power (dBm)	Scaled SAR 1g (W/Kg)	Date
			1g	10g					
1RB									
Front Side	132322/1745	20M QPSK(1,49)	0.692	0.374	1.02	23.06	23.50	0.766	2021/2/26
Back Side	132322/1745	20M QPSK(1,49)	0.962	0.518	-0.72	23.06	23.50	1.065	2021/2/26
Back Side Repeated	132322/1745	20M QPSK(1,49)	0.958	0.515	0.35	23.06	23.50	1.060	2021/2/26
Back Side	132072/1720	20M QPSK(1,49)	0.958	0.513	-0.33	23.11	23.50	1.048	2021/2/26
Back Side	132572/1770	20M QPSK(1,49)	0.960	0.515	-0.71	22.86	23.50	1.112	2021/2/26
50%RB									
Front Side	132322/1745	1.4M QPSK(3,2)	0.372	0.198	2.61	22.99	23.50	0.418	2021/2/26
Back Side	132322/1745	1.4M QPSK(3,2)	0.490	0.260	-4.52	22.99	23.50	0.551	2021/2/26
100%RB									
Back Side	132322/1745	20M QPSK(100,0)	0.330	0.175	0.32	22.00	22.50	0.370	2021/2/26

NOTE: Body-Worn SAR test results of LTE Band 66

Test Position of Hotspot with 10mm	Test channel /Freq.	Test Mode	SAR Value (W/kg)		Power Drift (±5%)	Conducted power (dBm)	Tune-up power (dBm)	Scaled SAR 1g (W/Kg)	Date
			1g	10g					
1RB									
Front Side	132322/1745	20M QPSK(1,49)	0.692	0.374	1.02	23.06	23.50	0.766	2021/2/26
Back Side	132322/1745	20M QPSK(1,49)	0.962	0.518	-0.72	23.06	23.50	1.065	2021/2/26
Back Side	132322/1745	20M QPSK(1,49)	0.958	0.515	0.35	23.06	23.50	1.060	2021/2/26

Repeated									
Left Side	132322/1745	20M QPSK(1,49)	0.423	0.231	-1.04	23.06	23.50	0.468	2021/2/26
Right Side	132322/1745	20M QPSK(1,49)	0.366	0.199	-2.78	23.06	23.50	0.405	2021/2/26
Bottom Side	132322/1745	20M QPSK(1,49)	0.587	0.315	-2.22	23.06	23.50	0.650	2021/2/26
Back Side	132072/1720	20M QPSK(1,49)	0.958	0.513	-0.33	23.11	23.50	1.048	2021/2/26
Back Side	132572/1770	20M QPSK(1,49)	0.960	0.515	-0.71	22.86	23.50	1.112	2021/2/26
50%RB									
Front Side	132322/1745	1.4M QPSK(3,2)	0.372	0.198	2.61	22.99	23.50	0.418	2021/2/26
Back Side	132322/1745	1.4M QPSK(3,2)	0.490	0.260	-4.52	22.99	23.50	0.551	2021/2/26
Left Side	132322/1745	1.4M QPSK(3,2)	0.245	0.117	0.21	22.99	23.50	0.276	2021/2/26
Right Side	132322/1745	1.4M QPSK(3,2)	0.207	0.113	-0.63	22.99	23.50	0.233	2021/2/26
Bottom Side	132322/1745	1.4M QPSK(3,2)	0.323	0.169	-1.88	22.99	23.50	0.363	2021/2/26
100%RB									
Back Side	132322/1745	20M QPSK(100,0)	0.330	0.175	0.32	22.00	22.50	0.370	2021/2/26

NOTE: Head SAR test results of LTE Band 66

10.1.18. SAR measurement Result of WLAN 2.4G

Test Position of Head	Test channel /Freq.	Test Mode	SAR Value (W/kg)		Power Drift (±5%)	Conducted power (dBm)	Tune-up power (dBm)	Scaled SAR 1g (W/Kg)	Date
			1g	10g					
Left Cheek	6/2437	802.11 b	0.267	0.144	-1.20	13.40	14.50	0.344	2021/2/02
Left Tilt 15 Degree	6/2437	802.11 b	0.141	0.072	-3.50	13.40	14.50	0.182	2021/2/02
Right Cheek	6/2437	802.11 b	0.240	0.133	-2.41	13.40	14.50	0.309	2021/2/02
Right Tilt 15 Degree	6/2437	802.11 b	0.114	0.057	-2.56	13.40	14.50	0.147	2021/2/02

NOTE: Head SAR test results of WLAN 2.4G

Test Position of Body-Worn with 10mm	Test channel /Freq.	Test Mode	SAR Value (W/kg)		Power Drift (±5%)	Conducted power (dBm)	Tune-up power (dBm)	Scaled SAR 1g (W/Kg)	Date
			1g	10g					
Front Side	6/2437	802.11 b	0.045	0.030	-4.00	13.40	14.50	0.058	2021/2/02
Back Side	6/2437	802.11 b	0.070	0.047	0.87	13.40	14.50	0.090	2021/2/02

NOTE: Body-Worn SAR test results of WLAN 2.4G

Test Position of Hotspot with 10mm	Test channel /Freq.	Test Mode	SAR Value (W/kg)		Power Drift (±5%)	Conducted power (dBm)	Tune-up power (dBm)	Scaled SAR 1g (W/Kg)	Date
			1g	10g					
Front Side	6/2437	802.11 b	0.045	0.030	-4.00	13.40	14.50	0.058	2021/2/02
Back Side	6/2437	802.11 b	0.070	0.047	0.87	13.40	14.50	0.090	2021/2/02
Right Side	6/2437	802.11 b	0.016	0.010	2.08	13.40	14.50	0.021	2021/2/02
Top Side	6/2437	802.11 b	0.024	0.016	3.93	13.40	14.50	0.031	2021/2/02

NOTE: Hotspot SAR test results of WLAN 2.4G

10.1.19. SAR measurement Result of WLAN 5.2G

Test Position of Head	Test channel /Freq.	Test Mode	SAR Value (W/kg)		Power Drift (±5%)	Conducted power (dBm)	Tune-up power (dBm)	Scaled SAR 1g (W/Kg)	Date
			1g	10g					
Left Cheek	40/5200	802.11a	0.115	0.071	-2.34	9.613	10.000	0.126	2021/2/6
Left Tilt 15 Degree	40/5200	802.11a	0.066	0.041	1.51	9.613	10.000	0.072	2021/2/6
Right Cheek	40/5200	802.11a	0.109	0.065	-2.04	9.613	10.000	0.119	2021/2/6
Right Tilt 15 Degree	40/5200	802.11a	0.058	0.035	-2.98	9.613	10.000	0.063	2021/2/6

NOTE: Head SAR test results of WLAN 5.2G

Test Position of Body-Worn with 10mm	Test channel /Freq.	Test Mode	SAR Value (W/kg)		Power Drift (±5%)	Conducted power (dBm)	Tune-up power (dBm)	Scaled SAR 1g (W/Kg)	Date
			1g	10g					
Front Side	40/5200	802.11a	0.057	0.033	2.57	9.613	10.000	0.062	2021/2/6
Back Side	40/5200	802.11a	0.090	0.055	-3.20	9.613	10.000	0.098	2021/2/6

NOTE: Body-Worn SAR test results of WLAN 5.2G

Test Position of Hotspot with 10mm	Test channel /Freq.	Test Mode	SAR Value (W/kg)		Power Drift (±5%)	Conducted power (dBm)	Tune-up power (dBm)	Scaled SAR 1g (W/Kg)	Date
			1g	10g					
Front Side	40/5200	802.11a	0.057	0.033	2.57	9.613	10.000	0.062	2021/2/6
Back Side	40/5200	802.11a	0.090	0.055	-3.20	9.613	10.000	0.098	2021/2/6
Right Side	40/5200	802.11a	0.020	0.014	4.99	9.613	10.000	0.022	2021/2/6
Top Side	40/5200	802.11a	0.031	0.019	3.74	9.613	10.000	0.034	2021/2/6

NOTE: Hotspot SAR test results of WLAN 5.2G

10.1.20. SAR measurement Result of WLAN 5.8G

Test Position of Head	Test channel /Freq.	Test Mode	SAR Value (W/kg)		Power Drift (±5%)	Conducted power (dBm)	Tune-up power (dBm)	Scaled SAR 1g (W/Kg)	Date
			1g	10g					
Left Cheek	157/5785	802.11a	0.286	0.136	3.40	10.207	10.500	0.306	2021/2/7
Left Tilt 15 Degree	157/5785	802.11a	0.148	0.068	-1.79	10.207	10.500	0.158	2021/2/7
Right Cheek	157/5785	802.11a	0.258	0.123	0.10	10.207	10.500	0.276	2021/2/7
Right Tilt 15 Degree	157/5785	802.11a	0.139	0.065	-1.75	10.207	10.500	0.149	2021/2/7

NOTE: Head SAR test results of WLAN 5.8G

Test Position of Body-Worn with 10mm	Test channel /Freq.	Test Mode	SAR Value (W/kg)		Power Drift (±5%)	Conducted power (dBm)	Tune-up power (dBm)	Scaled SAR 1g (W/Kg)	Date
			1g	10g					
Front Side	157/5785	802.11a	0.073	0.050	4.50	10.207	10.500	0.078	2021/2/7
Back Side	157/5785	802.11a	0.107	0.060	-1.02	10.207	10.500	0.114	2021/2/7

NOTE: Body-Worn SAR test results of WLAN 5.8G

Test Position of Hotspot with 10mm	Test channel /Freq.	Test Mode	SAR Value (W/kg)		Power Drift (±5%)	Conducted power (dBm)	Tune-up power (dBm)	Scaled SAR 1g (W/Kg)	Date
			1g	10g					
Front Side	157/5785	802.11a	0.073	0.050	4.50	10.207	10.500	0.078	2021/2/7
Back Side	157/5785	802.11a	0.107	0.060	-1.02	10.207	10.500	0.114	2021/2/7
Right Side	157/5785	802.11a	0.024	0.018	-4.88	10.207	10.500	0.026	2021/2/7
Top Side	157/5785	802.11a	0.037	0.028	-0.62	10.207	10.500	0.040	2021/2/7

NOTE: Hotspot SAR test results of WLAN 5.8G

10.2. Simultaneous Transmission Analysis

Per KDB 447498 D01, simultaneous transmission SAR is compliant if,

- 1) Scalar SAR summation < 1.6W/kg.
- 2) SPLSR = $(SAR_1 + SAR_2)^{1.5} / (\text{min. separation distance, mm})$, and the peak separation distance is determined from the square root of $[(x_1-x_2)^2 + (y_1-y_2)^2 + (z_1-z_2)^2]$, where (x_1, y_1, z_1) and (x_2, y_2, z_2) are the coordinates of the extrapolated peak SAR locations in the zoom scan. If $SPLSR \leq 0.04$, simultaneously transmission SAR measurement is not necessary.

Test Position		Scaled SAR _{MAX}		Σ 1-g SAR (W/Kg)	SPLSR	Remark
		PCE	DTS			
Head	Left Cheek	0.540	0.344	0.884	N/A	N/A
	Left Tilt 15 Degree	0.304	0.182	0.486	N/A	N/A
	Right Cheek	0.491	0.309	0.800	N/A	N/A
	Right Tilt 15 Degree	0.255	0.147	0.402	N/A	N/A
Body-Worn	Front Side	0.785	0.058	0.843	N/A	N/A
	Back Side	1.178	0.090	1.268	N/A	N/A
Hotspot	Front Side	0.785	0.058	0.843	N/A	N/A
	Back Side	1.178	0.090	1.268	N/A	N/A
	Left Side	0.547	N/A	0.547	N/A	N/A
	Right Side	0.444	0.021	0.465	N/A	N/A
	Top Side	N/A	0.031	0.031	N/A	N/A
	Bottom Side	0.717	N/A	0.717	N/A	N/A

Test Position		Scaled SAR _{MAX}		Σ 1-g SAR (W/Kg)	SPLSR	Remark
		PCE	NII			
Head	Left Cheek	0.540	0.306	0.846	N/A	N/A
	Left Tilt 15 Degree	0.304	0.158	0.462	N/A	N/A
	Right Cheek	0.491	0.276	0.767	N/A	N/A
	Right Tilt 15 Degree	0.255	0.149	0.404	N/A	N/A
Body-Worn	Front Side	0.785	0.078	0.863	N/A	N/A
	Back Side	1.178	0.114	1.292	N/A	N/A
Hotspot	Front Side	0.785	0.078	0.863	N/A	N/A
	Back Side	1.178	0.114	1.292	N/A	N/A
	Left Side	0.547	N/A	0.547	N/A	N/A
	Right Side	0.444	0.026	0.470	N/A	N/A
	Top Side	N/A	0.040	0.040	N/A	N/A

	Bottom Side	0.717	N/A	0.717	N/A	N/A
Test Position		Scaled SAR _{MAX}		Σ 1-g SAR (W/Kg)	SPLSR	Remark
		PCE	DSS			
Head	Left Cheek	0.540	0.265	0.805	N/A	N/A
	Left Tilt 15 Degree	0.304	0.265	0.569	N/A	N/A
	Right Cheek	0.491	0.265	0.756	N/A	N/A
	Right Tilt 15 Degree	0.255	0.265	0.520	N/A	N/A
Body-Worn	Front Side	0.785	0.132	0.917	N/A	N/A
	Back Side	1.178	0.132	1.310	N/A	N/A
Hotspot	Front Side	0.785	0.132	0.917	N/A	N/A
	Back Side	1.178	0.132	1.310	N/A	N/A
	Left Side	0.547	N/A	0.547	N/A	N/A
	Right Side	0.444	0.132	0.576	N/A	N/A
	Top Side	N/A	0.132	0.132	N/A	N/A
	Bottom Side	0.717	N/A	0.717	N/A	N/A

11. Appendix A. Photo documentation

Refer to appendix Test Setup photo---SAR

12. Appendix B. System Check Plots

Table of contents
MEASUREMENT 1 System Performance Check - 750MHz
MEASUREMENT 2 System Performance Check - 835MHz
MEASUREMENT 3 System Performance Check - 1800MHz
MEASUREMENT 4 System Performance Check - 1900MHz
MEASUREMENT 5 System Performance Check - 2450MHz
MEASUREMENT 6 System Performance Check - 2600MHz
MEASUREMENT 7 System Performance Check - 5200MHz
MEASUREMENT 8 System Performance Check - 5800MHz

MEASUREMENT 1

Date of measurement: 20/2/2021

A. Experimental conditions.

Area Scan	<u>dx=15mm dy=15mm, h= 5.00 mm</u>
ZoomScan	<u>5x5x7,dx=8mm dy=8mm dz=5mm</u>
Phantom	<u>Validation plane</u>
Device Position	<u>Dipole</u>
Band	<u>CW750</u>
Channels	<u>Middle</u>
Signal	<u>CW (Crest factor: 1.0)</u>

B. SAR Measurement Results

Frequency (MHz)	750.000000
Relative permittivity (real part)	42.413162
Relative permittivity (imaginary part)	21.881263
Conductivity (S/m)	0.910362
Variation (%)	-1.810000

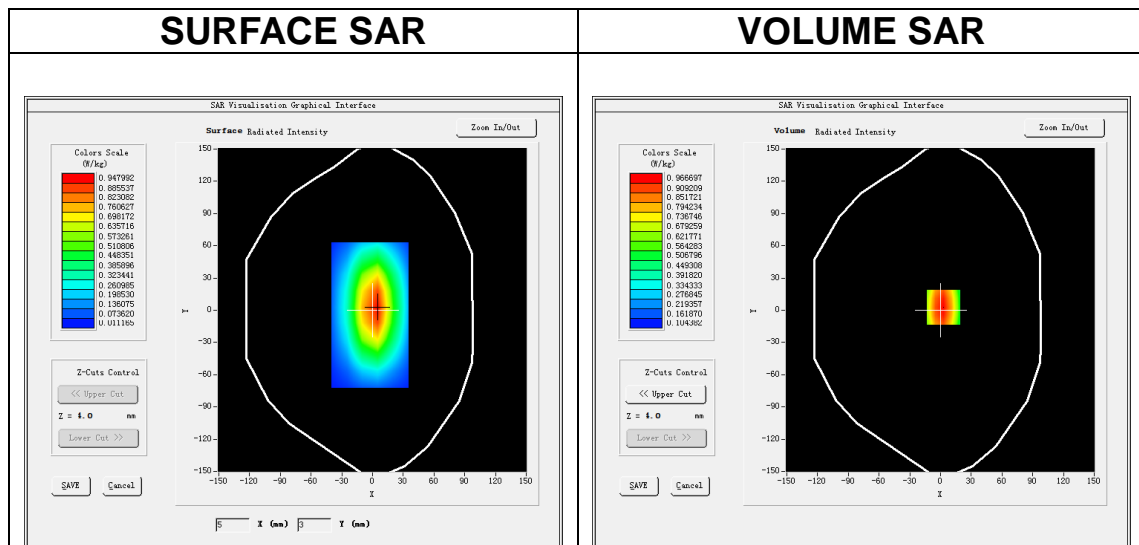

Maximum location: X=3.00, Y=3.00

SAR Peak: 1.30 W/kg

SAR 10g (W/Kg)	0.566218
SAR 1g (W/Kg)	0.853062

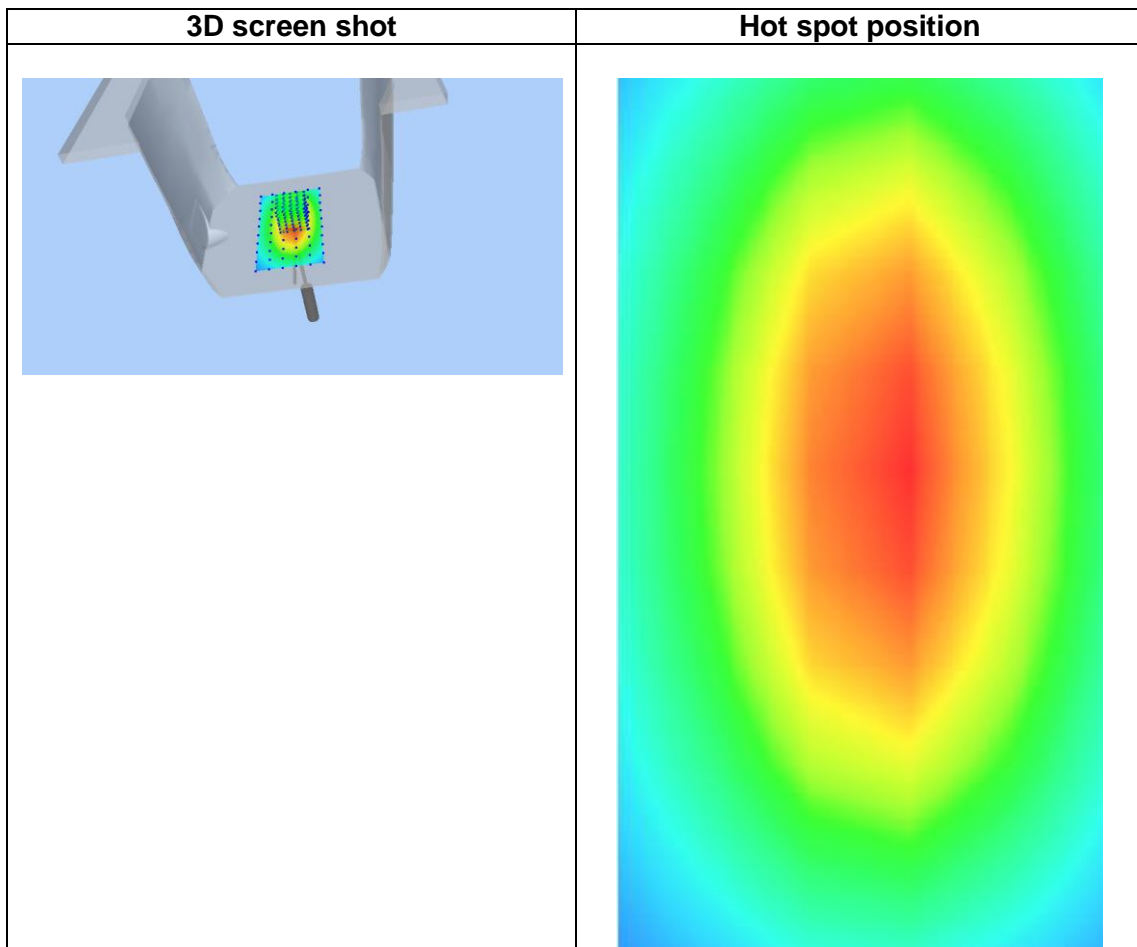
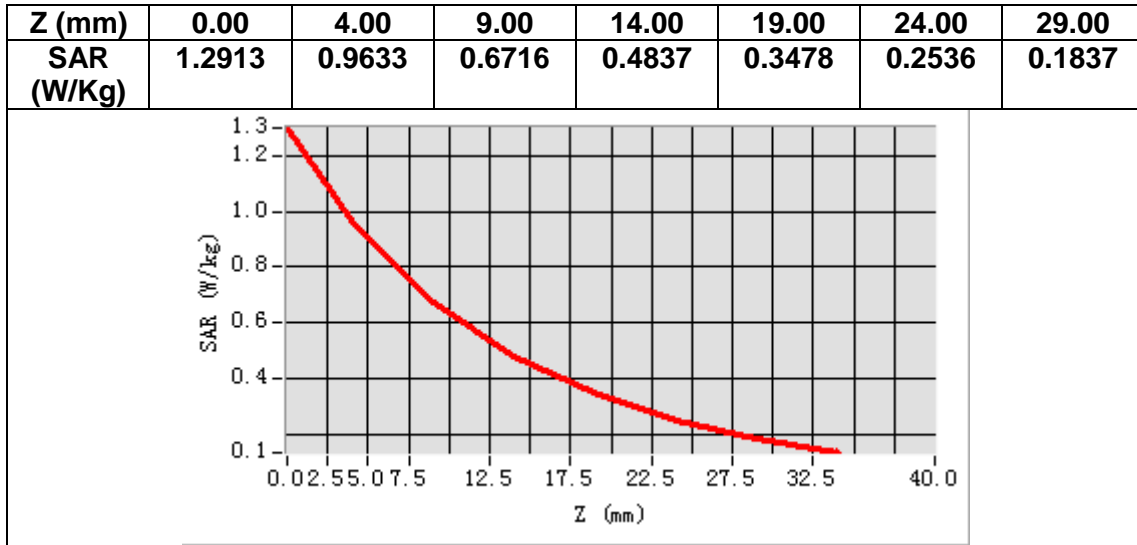

MEASUREMENT 2

Date of measurement: 2/2/2021

A. Experimental conditions.

Area Scan	<u>dx=15mm dy=15mm, h= 5.00 mm</u>
ZoomScan	<u>5x5x7, dx=8mm dy=8mm dz=5mm</u>
Phantom	<u>Validation plane</u>
Device Position	<u>Dipole</u>
Band	<u>CW835</u>
Channels	<u>Middle</u>
Signal	<u>CW (Crest factor: 1.0)</u>

B. SAR Measurement Results

Frequency (MHz)	835.000000
Relative permittivity (real part)	41.963500
Relative permittivity (imaginary part)	19.501602
Conductivity (S/m)	0.900502
Variation (%)	1.870000

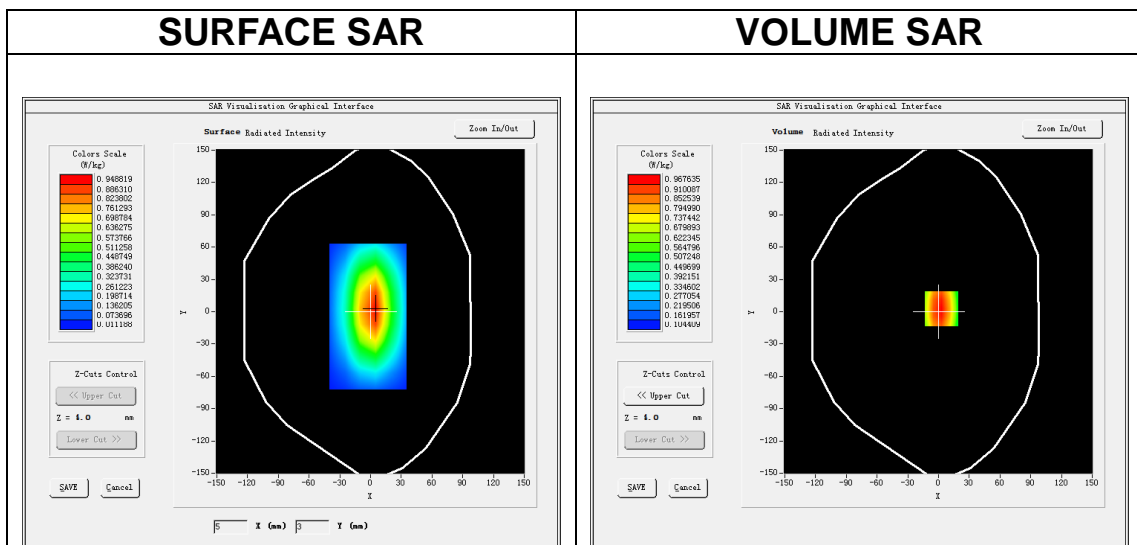

Maximum location: X=3.00, Y=3.00

SAR Peak: 1.30 W/kg

SAR 10g (W/Kg)	0.616433
SAR 1g (W/Kg)	1.016035

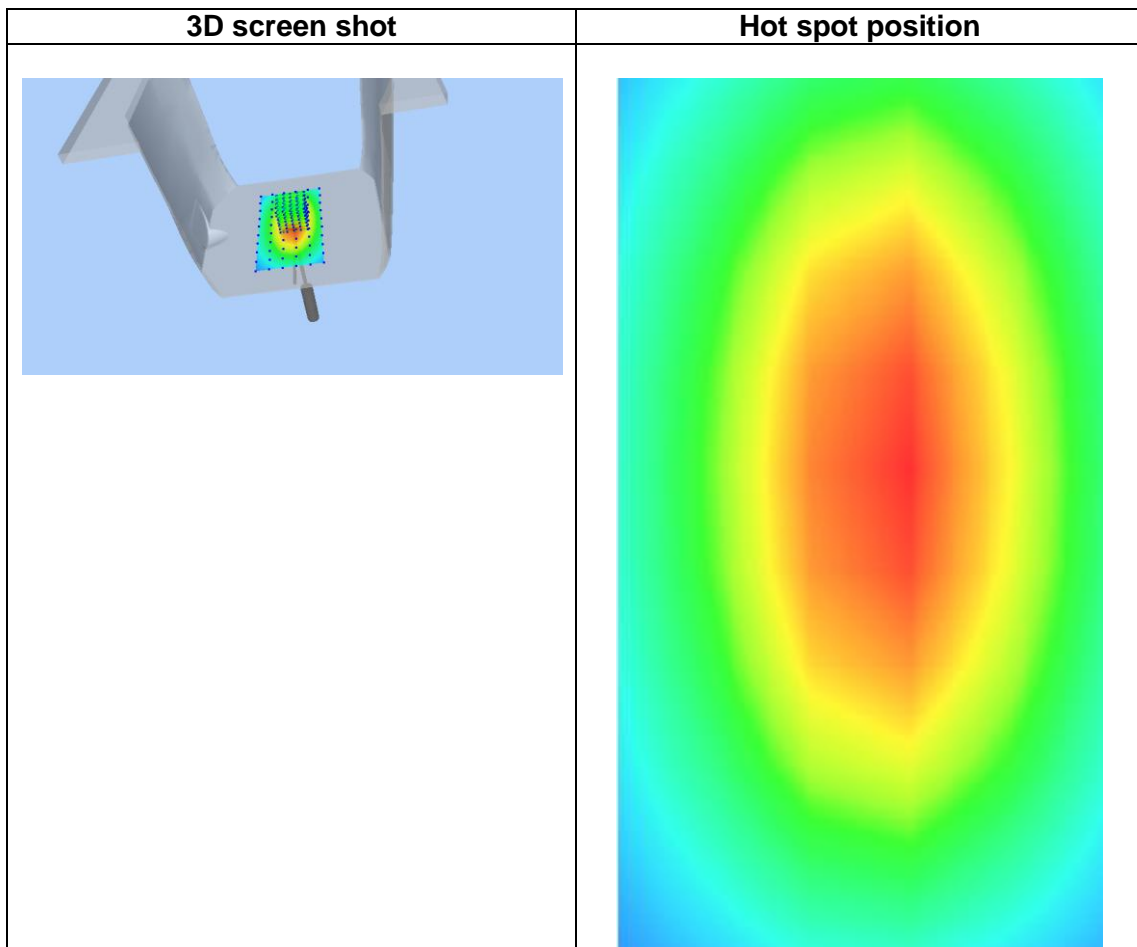
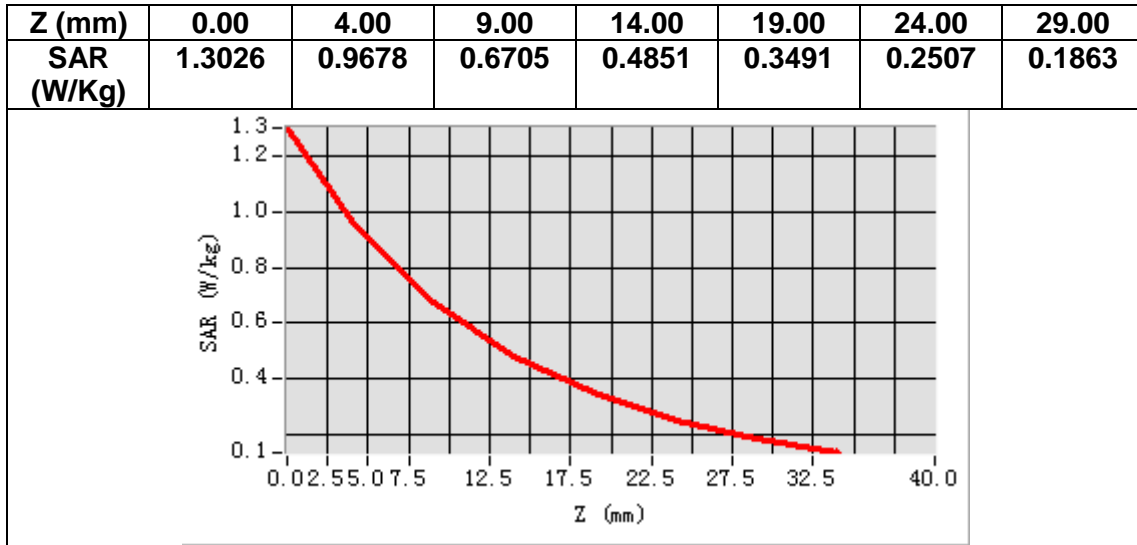

MEASUREMENT 3

Date of measurement: 26/2/2021

A. Experimental conditions.

Area Scan	<u>dx=15mm dy=15mm, h= 5.00 mm</u>
ZoomScan	<u>5x5x7, dx=8mm dy=8mm dz=5mm</u>
Phantom	<u>Validation plane</u>
Device Position	<u>Dipole</u>
Band	<u>CW1800</u>
Channels	<u>Middle</u>
Signal	<u>CW (Crest factor: 1.0)</u>

B. SAR Measurement Results

Frequency (MHz)	1800.000000
Relative permittivity (real part)	39.741237
Relative permittivity (imaginary part)	13.993229
Conductivity (S/m)	1.401367
Variation (%)	-2.11000

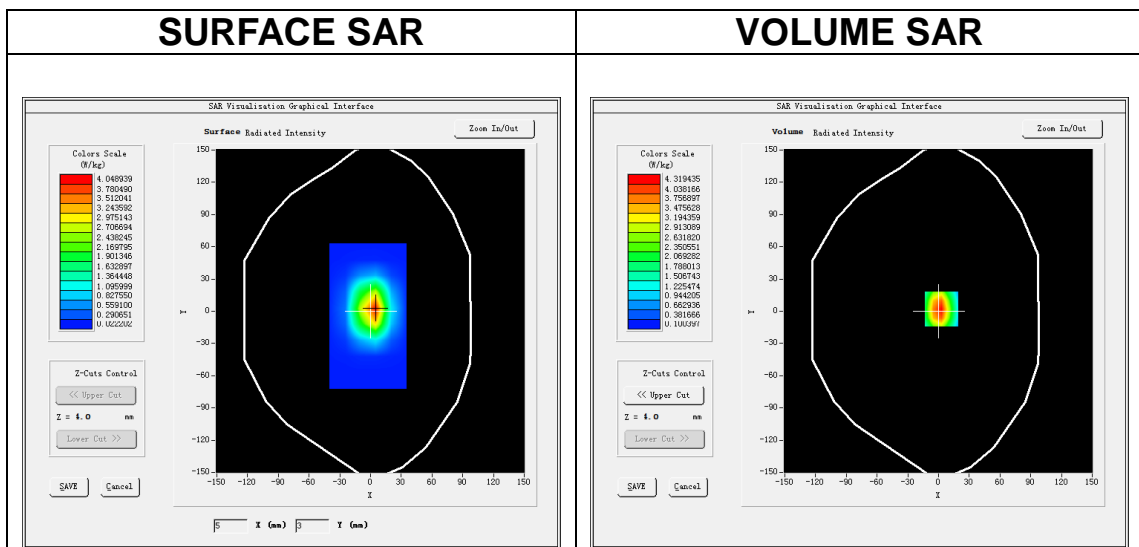

Maximum location: X=3.00, Y=2.00

SAR Peak: 6.82 W/kg

SAR 10g (W/Kg)	2.063397
SAR 1g (W/Kg)	3.988451

Z (mm)	0.00	4.00	9.00	14.00	19.00	24.00	29.00
SAR (W/Kg)	6.7434	4.3126	2.4318	1.4277	0.8554	0.5237	0.3279

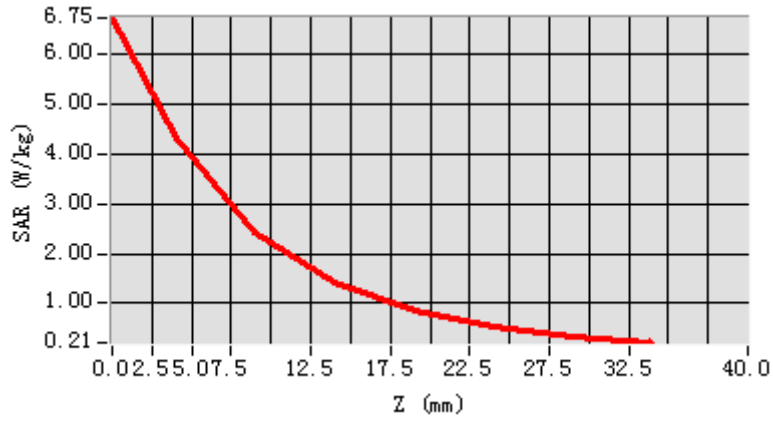

3D screen shot

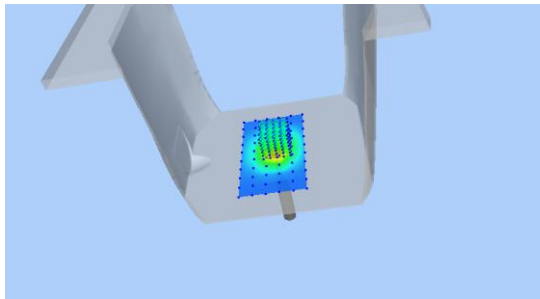

Hot spot position

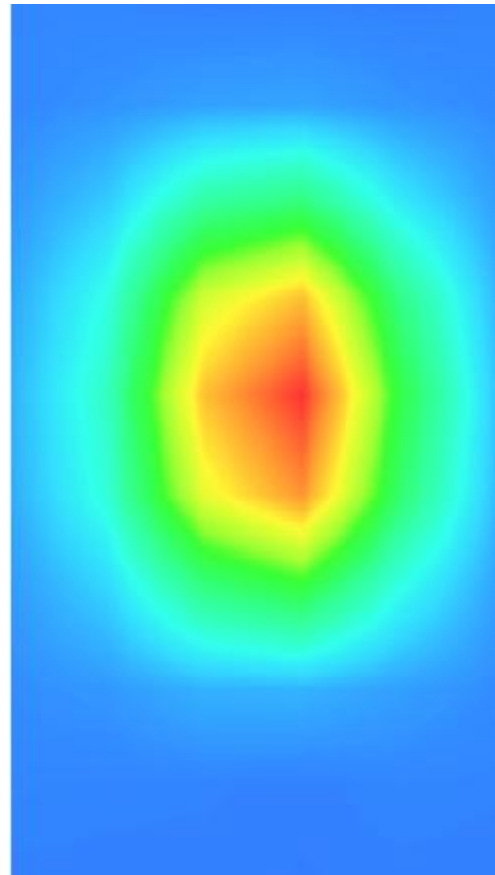

MEASUREMENT 4

Date of measurement: 3/2/2021

A. Experimental conditions.

Area Scan	<u>dx=15mm dy=15mm, h= 5.00 mm</u>
ZoomScan	<u>5x5x7, dx=8mm dy=8mm dz=5mm</u>
Phantom	<u>Validation plane</u>
Device Position	<u>Dipole</u>
Band	<u>CW1900</u>
Channels	<u>Middle</u>
Signal	<u>CW (Crest factor: 1.0)</u>

B. SAR Measurement Results

Frequency (MHz)	1900.000000
Relative permittivity (real part)	39.501017
Relative permittivity (imaginary part)	13.413006
Conductivity (S/m)	1.420302
Variation (%)	-1.430000

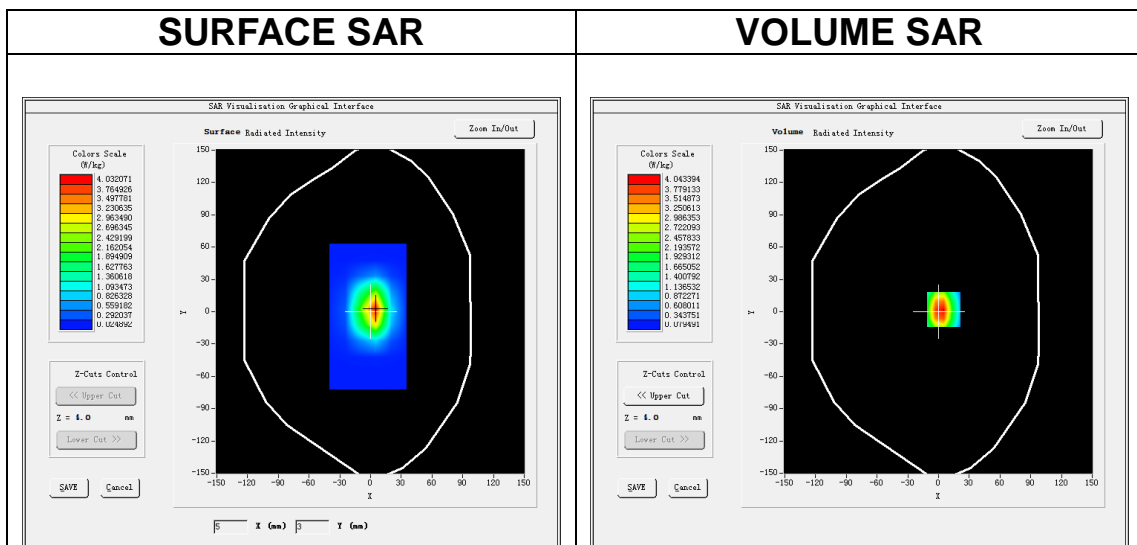

Maximum location: X=5.00, Y=2.00

SAR Peak: 6.70 W/kg

SAR 10g (W/Kg)	2.005452
SAR 1g (W/Kg)	3.790361

Z (mm)	0.00	4.00	9.00	14.00	19.00	24.00	29.00
SAR (W/Kg)	6.3211	4.0432	2.2653	1.3077	0.7635	0.4533	0.2735

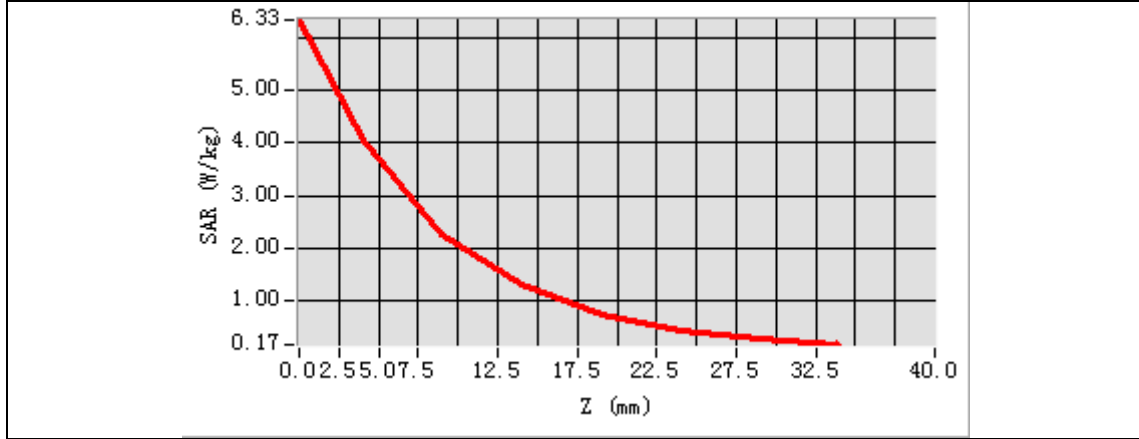

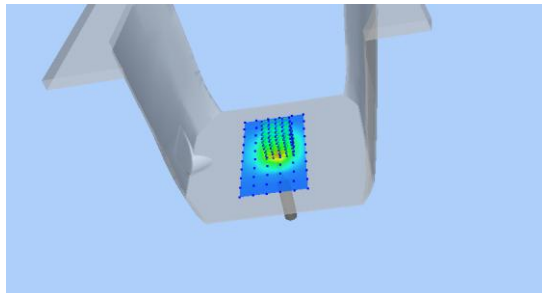
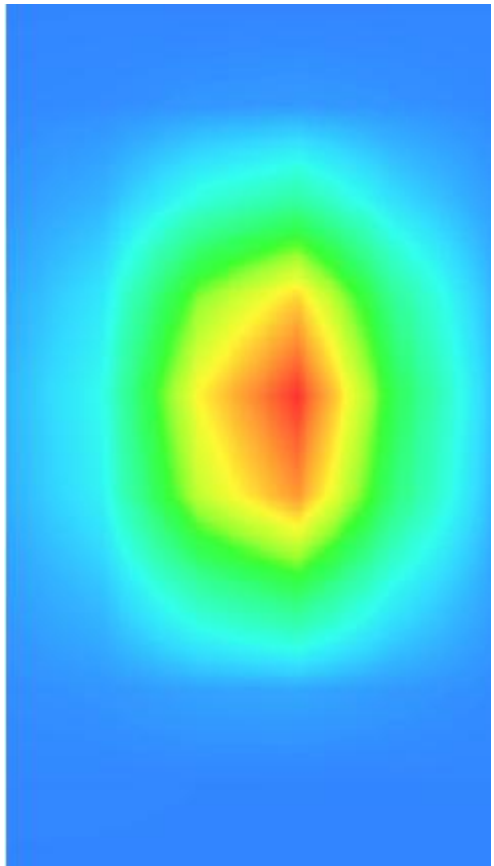
3D screen shot	Hot spot position
	

MEASUREMENT 5

Date of measurement: 2/2/2021

A. Experimental conditions.

Area Scan	<u>dx=12mm dy=12mm, h= 5.00 mm</u>
ZoomScan	<u>7x7x7, dx=5mm dy=5mm dz=5mm</u>
Phantom	<u>Validation plane</u>
Device Position	<u>Dipole</u>
Band	<u>CW2450</u>
Channels	<u>Middle</u>
Signal	<u>CW (Crest factor: 1.0)</u>

B. SAR Measurement Results

Frequency (MHz)	2450.000000
Relative permittivity (real part)	39.541421
Relative permittivity (imaginary part)	13.482631
Conductivity (S/m)	1.840663
Variation (%)	-3.350000

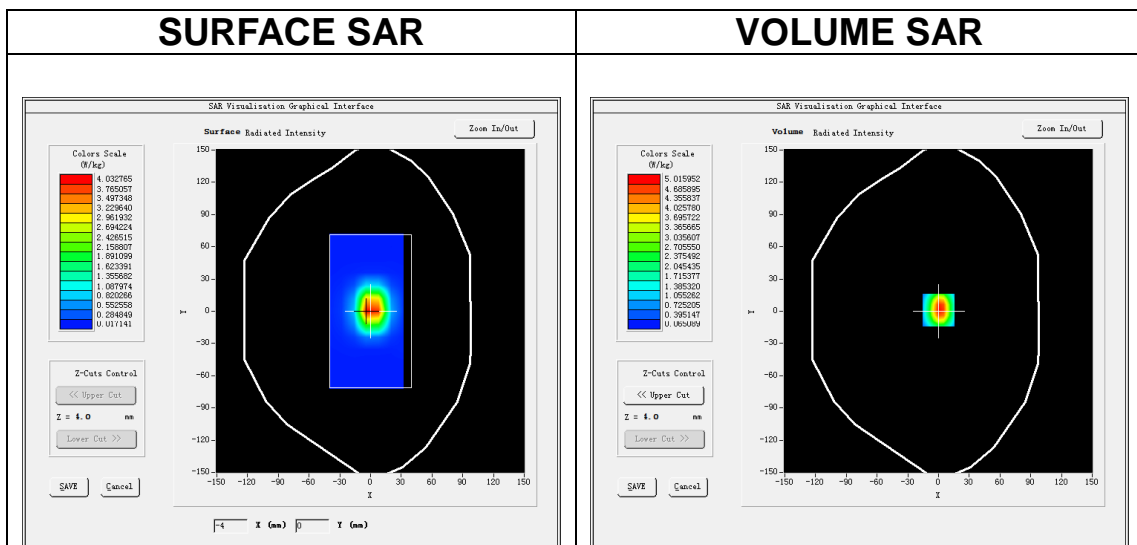

Maximum location: X=0.00, Y=1.00

SAR Peak: 8.14 W/kg

SAR 10g (W/Kg)	2.406375
SAR 1g (W/Kg)	5.215435

Z (mm)	0.00	4.00	9.00	14.00	19.00	24.00	29.00
SAR (W/Kg)	8.0302	5.0113	2.6947	1.4868	0.8390	0.4693	0.2643

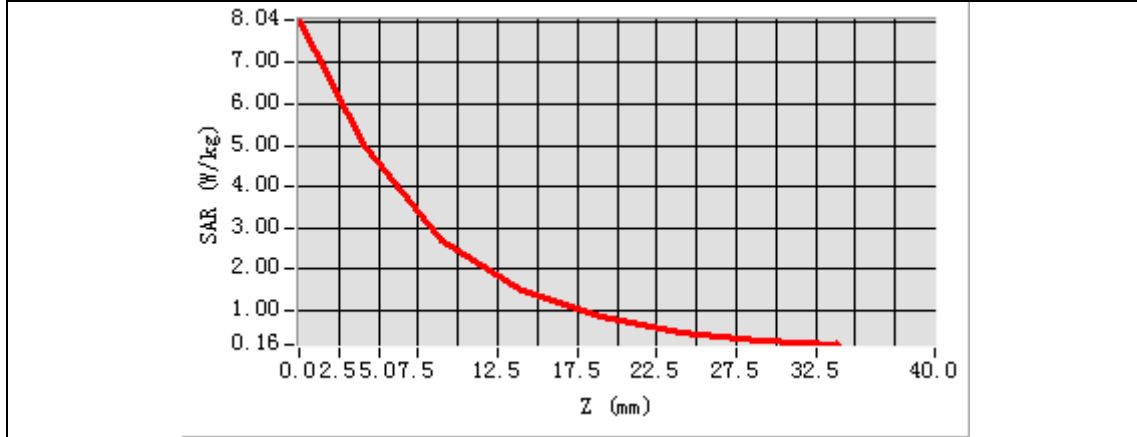

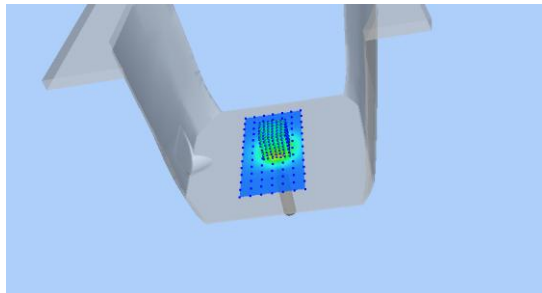
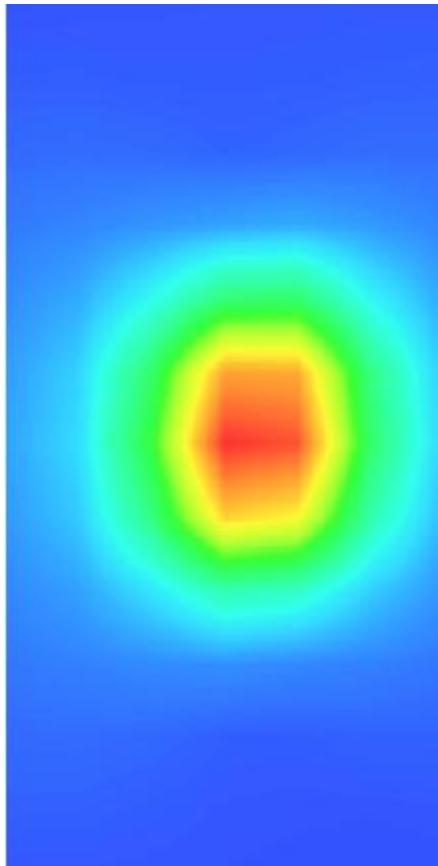
3D screen shot	Hot spot position
	

MEASUREMENT 6

Date of measurement: 3/2/2021

A. Experimental conditions.

Area Scan	<u>dx=12mm dy=12mm, h= 5.00 mm</u>
ZoomScan	<u>7x7x7, dx=5mm dy=5mm dz=5mm</u>
Phantom	<u>Validation plane</u>
Device Position	<u>Dipole</u>
Band	<u>CW2600</u>
Channels	<u>Middle</u>
Signal	<u>CW (Crest factor: 1.0)</u>

B. SAR Measurement Results

Frequency (MHz)	2600.000000
Relative permittivity (real part)	39.092638
Relative permittivity (imaginary part)	13.813997
Conductivity (S/m)	1.993631
Variation (%)	-0.040000

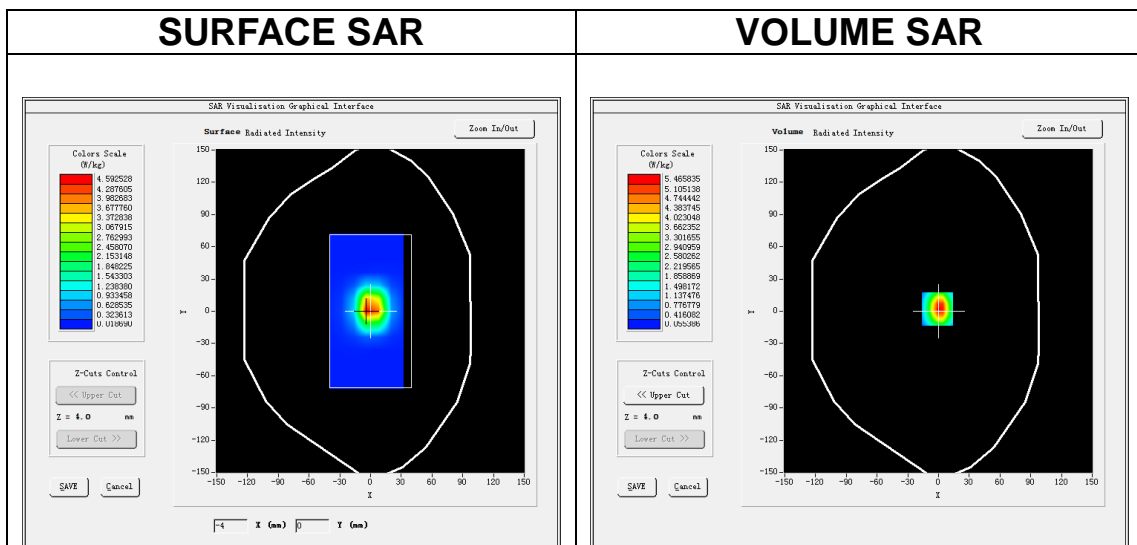

Maximum location: X=-1.00, Y=2.00

SAR Peak: 9.07 W/kg

SAR 10g (W/Kg)	2.558205
SAR 1g (W/Kg)	5.395267

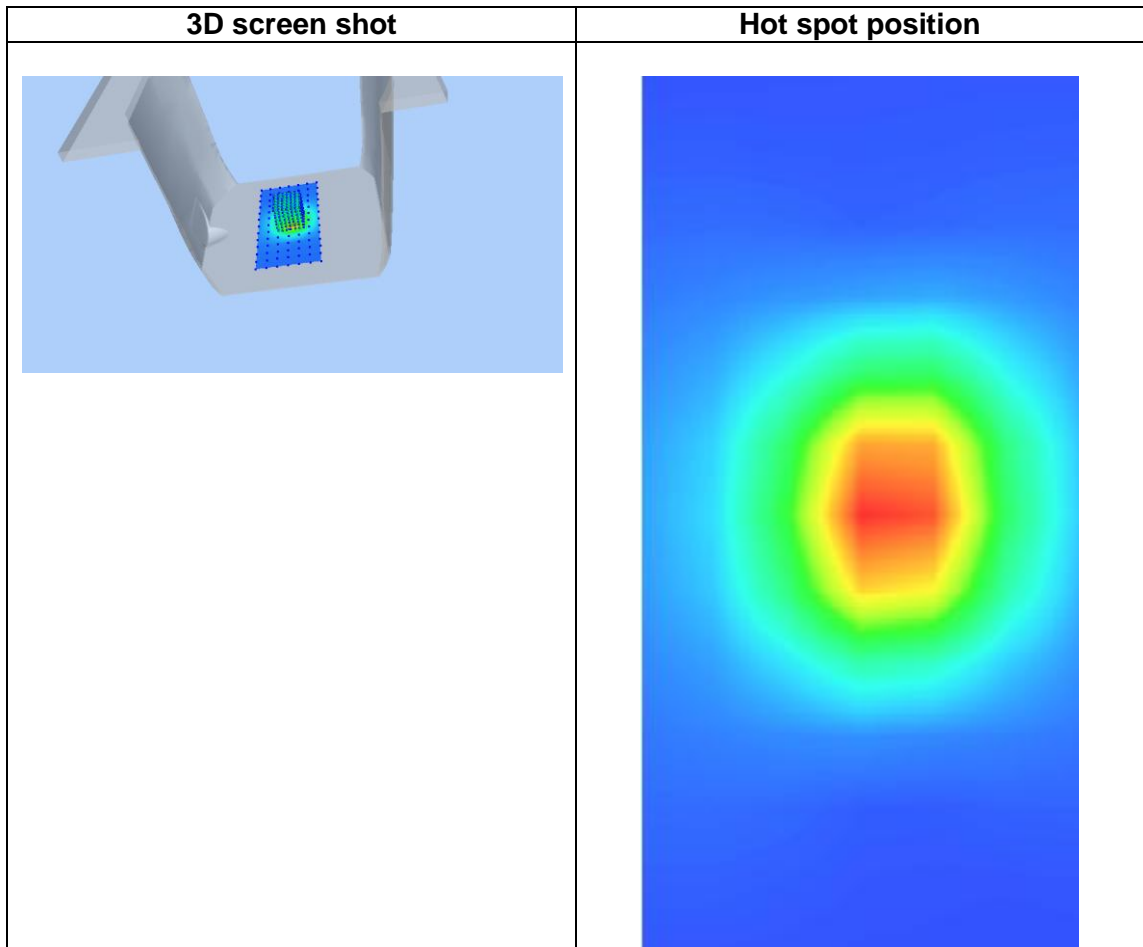
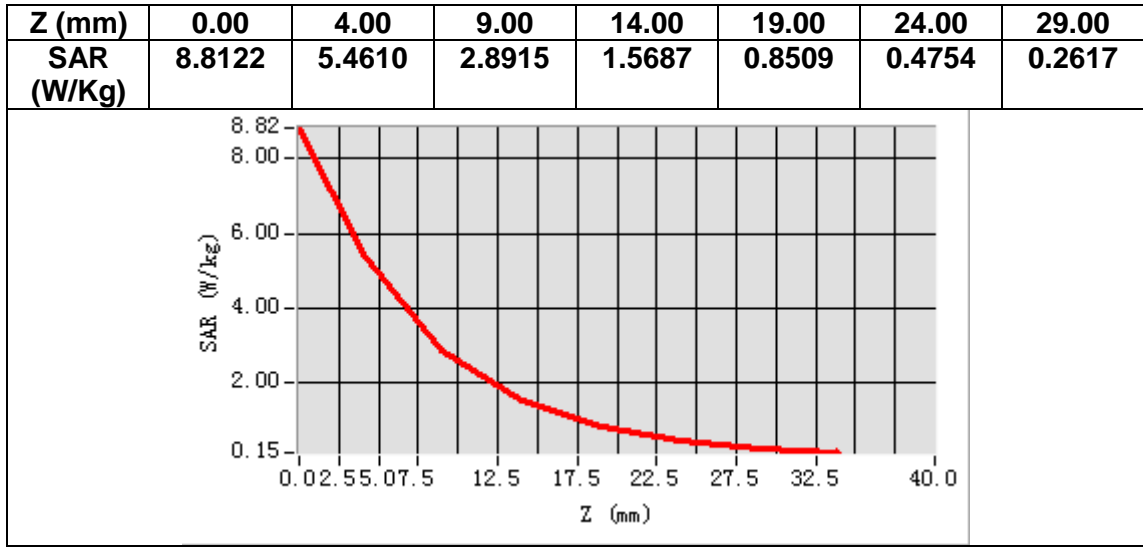

MEASUREMENT 7

Date of measurement: 6/2/2021

A. Experimental conditions.

Area Scan	<u>dx=10mm dy=10mm, h= 2.00 mm</u>
ZoomScan	<u>7x7x12,dx=4mm dy=4mm dz=2mm</u>
Phantom	<u>Validation plane</u>
Device Position	<u>Dipole</u>
Band	<u>CW5200</u>
Channels	<u>Middle</u>
Signal	<u>CW (Crest factor: 1.0)</u>

B. SAR Measurement Results

Frequency (MHz)	5200.000000
Relative permittivity (real part)	37.077827
Relative permittivity (imaginary part)	15.877089
Conductivity (S/m)	4.586715
Variation (%)	1.660000

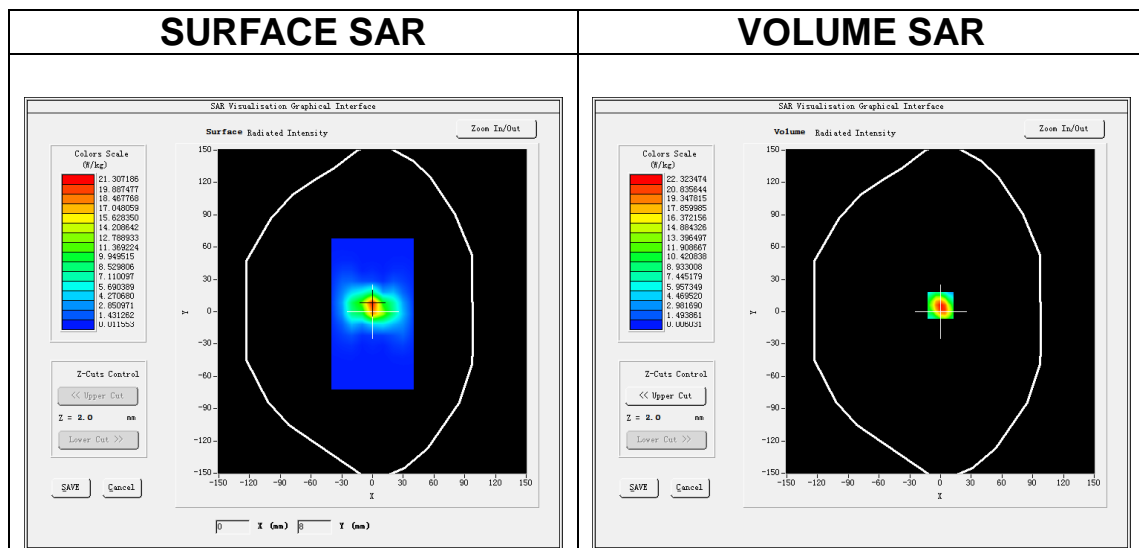

Maximum location: X=0.00, Y=6.00

SAR Peak: 40.06 W/kg

SAR 10g (W/Kg)	5.345495
SAR 1g (W/Kg)	16.140221

Z (m)	0.00	2.00	4.00	6.00	8.00	10.00	12.00	14.00	16.00	18.00	20.00	22.00
SAR (W/Kg)	37.8356	22.3278	11.3730	5.6618	2.8255	1.4093	0.7124	0.3660	0.1808	0.1012	0.0513	0.0323

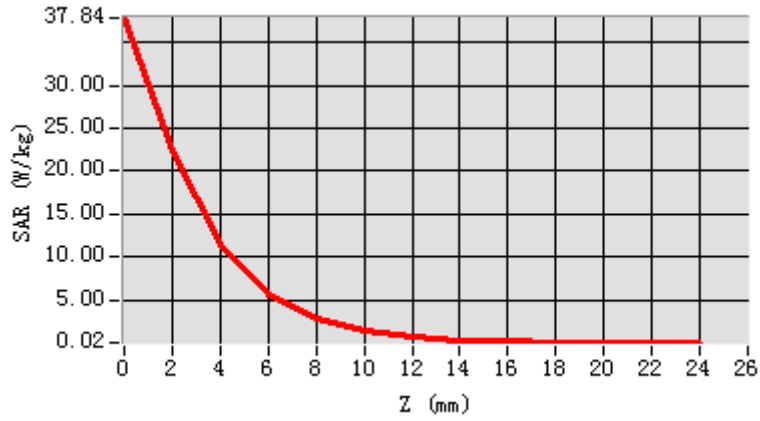

3D screen shot

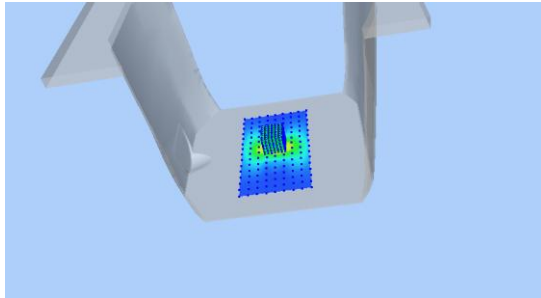

Hot spot position

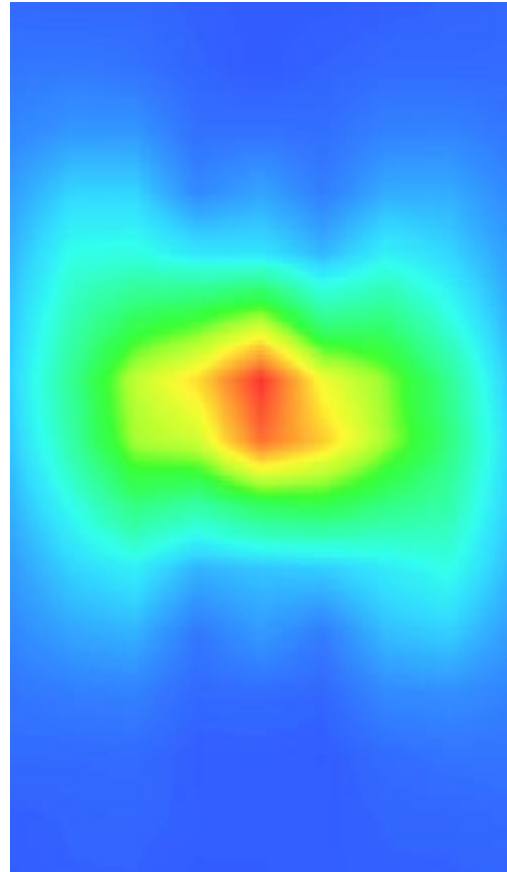

MEASUREMENT 8

Date of measurement: 7/2/2021

A. Experimental conditions.

Area Scan	<u>dx=10mm dy=10mm, h= 2.00 mm</u>
ZoomScan	<u>7x7x12,dx=4mm dy=4mm dz=2mm</u>
Phantom	<u>Validation plane</u>
Device Position	<u>Dipole</u>
Band	<u>CW5800</u>
Channels	<u>Middle</u>
Signal	<u>CW (Crest factor: 1.0)</u>

B. SAR Measurement Results

Frequency (MHz)	5800.000000
Relative permittivity (real part)	35.541512
Relative permittivity (imaginary part)	16.303082
Conductivity (S/m)	5.250981
Variation (%)	1.880000

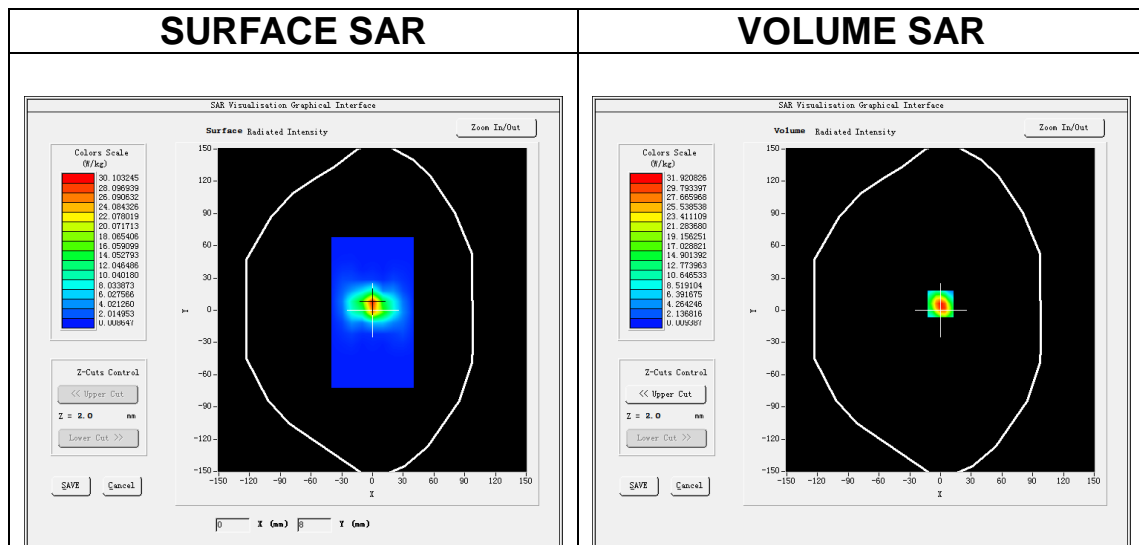

Maximum location: X=0.00, Y=6.00

SAR Peak: 57.37 W/kg

SAR 10g (W/Kg)	6.474095
SAR 1g (W/Kg)	18.693093

Z (m)	0.00	2.00	4.00	6.00	8.00	10.00	12.00	14.00	16.00	18.00	20.00	22.00
SAR (W/Kg)	54.0337	31.9251	16.1709	8.1795	4.0815	2.0572	1.0329	0.5177	0.2763	0.1542	0.0782	0.0446

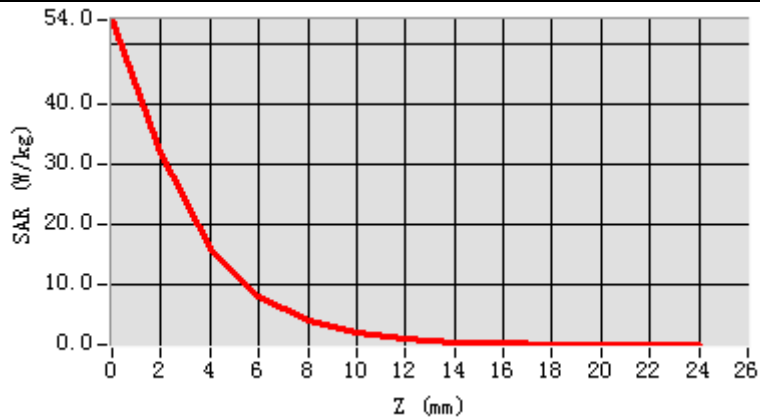

3D screen shot

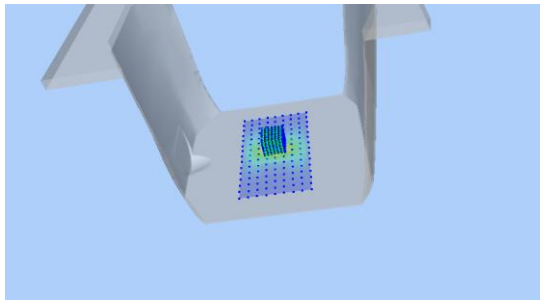

Hot spot position

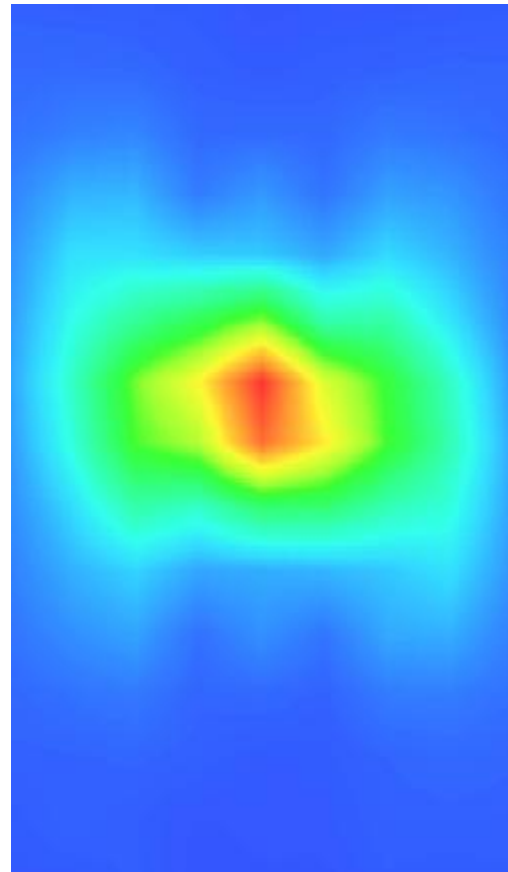

13. Appendix C. Plots of High SAR Measurement

Table of contents
MEASUREMENT 1 GSM 850 Head
MEASUREMENT 2 GSM 850 Body
MEASUREMENT 3 GSM 1900 Head
MEASUREMENT 4 GSM 1900 Body
MEASUREMENT 5 WCDMA Band 2 Head
MEASUREMENT 6 WCDMA Band 2 Body
MEASUREMENT 7 WCDMA Band 4 Head
MEASUREMENT 8 WCDMA Band 4 Body
MEASUREMENT 9 WCDMA Band 5 Head
MEASUREMENT 10 WCDMA Band 5 Body
MEASUREMENT 11 WLAN 5.2G Head
MEASUREMENT 12 WLAN 5.8G Head
MEASUREMENT 13 WLAN 5.2G Body
MEASUREMENT 14 WLAN 5.8G Body
MEASUREMENT 15 WLAN 2.4G Head
MEASUREMENT 16 WLAN 2.4G Body
MEASUREMENT 17 LTE Band 2 Head
MEASUREMENT 18 LTE Band 2 Body
MEASUREMENT 19 LTE Band 4 Head
MEASUREMENT 20 LTE Band 4 Body
MEASUREMENT 21 LTE Band 5 Head
MEASUREMENT 22 LTE Band 5 Body
MEASUREMENT 23 LTE Band 7 Head
MEASUREMENT 24 LTE Band 7 Body
MEASUREMENT 25 LTE Band 12 Head
MEASUREMENT 26 LTE Band 12 Body
MEASUREMENT 27 LTE Band 13 Head
MEASUREMENT 28 LTE Band 13 Body
MEASUREMENT 29 LTE Band 17 Head
MEASUREMENT 30 LTE Band 17 Body
MEASUREMENT 31 LTE Band 25 Head
MEASUREMENT 32 LTE Band 25 Body
MEASUREMENT 33 LTE Band 26A Head
MEASUREMENT 34 LTE Band 26A Body
MEASUREMENT 35 LTE Band 26B Head
MEASUREMENT 36 LTE Band 26B Body
MEASUREMENT 37 LTE Band 41 Head

MEASUREMENT 38 LTE Band 41 Body

MEASUREMENT 39 LTE Band 66 Head

MEASUREMENT 40 LTE Band 66 Body

MEASUREMENT 1

Date of measurement: 2/2/2021

A. Experimental conditions.

Area Scan	<u>dx=15mm dy=15mm, h= 5.00 mm</u>
ZoomScan	<u>5x5x7, dx=8mm dy=8mm dz=5mm</u>
Phantom	<u>Left head</u>
Device Position	<u>Cheek</u>
Band	<u>GSM850</u>
Channels	<u>Middle</u>
Signal	<u>TDMA (Crest factor: 2.0)</u>

B. SAR Measurement Results

Frequency (MHz)	836.400000
Relative permittivity (real part)	41.876575
Relative permittivity (imaginary part)	19.524746
Conductivity (S/m)	0.907250
Variation (%)	1.180000

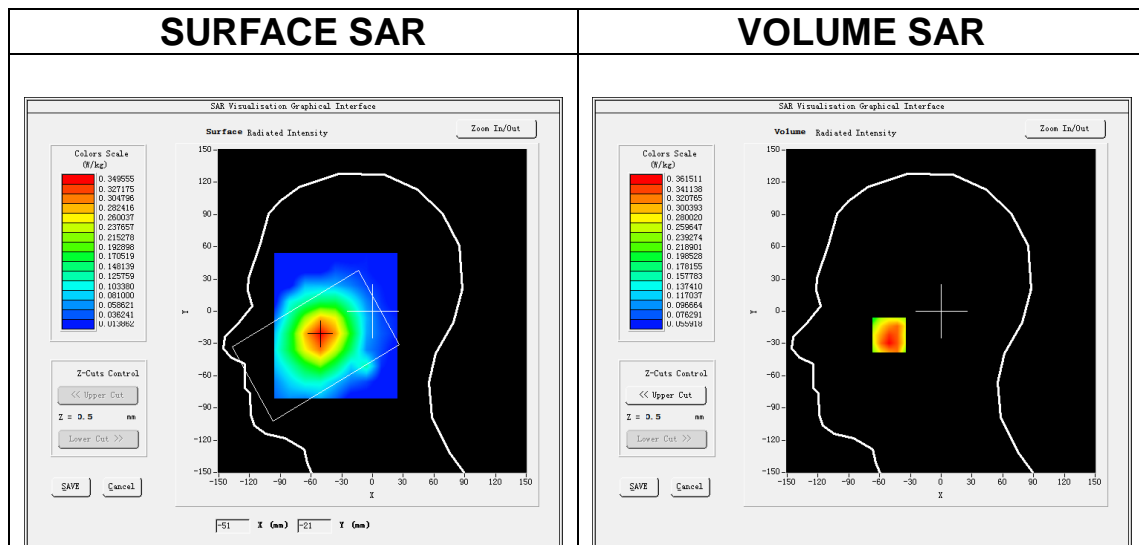

Maximum location: X=-51.00, Y=-22.00

SAR Peak: 0.49 W/kg

SAR 10g (W/Kg)	0.252413
SAR 1g (W/Kg)	0.353241

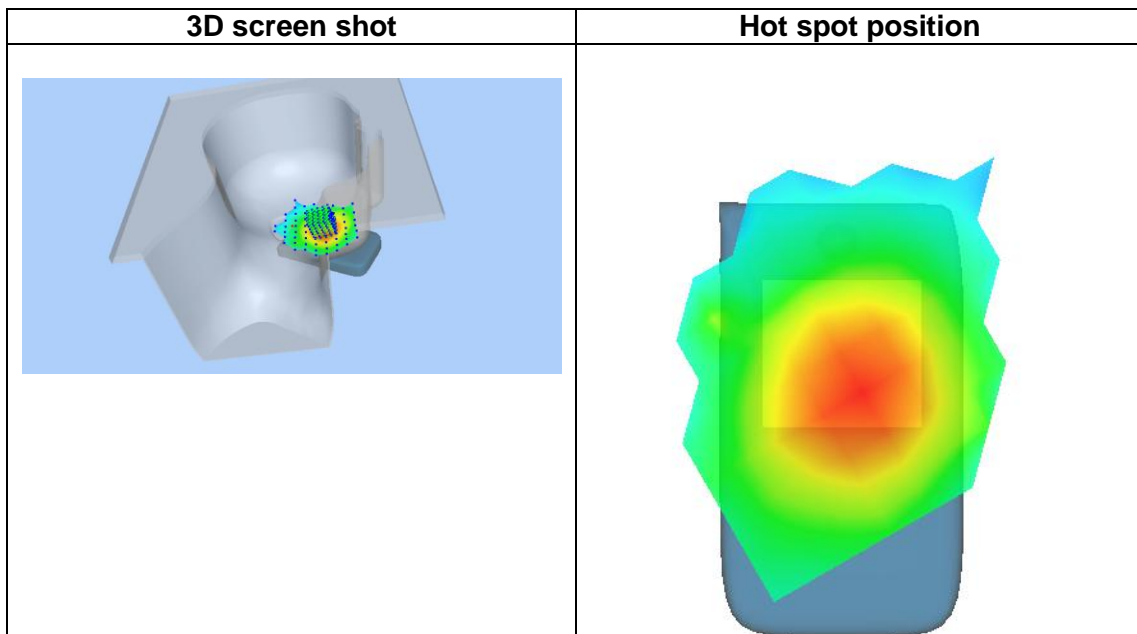
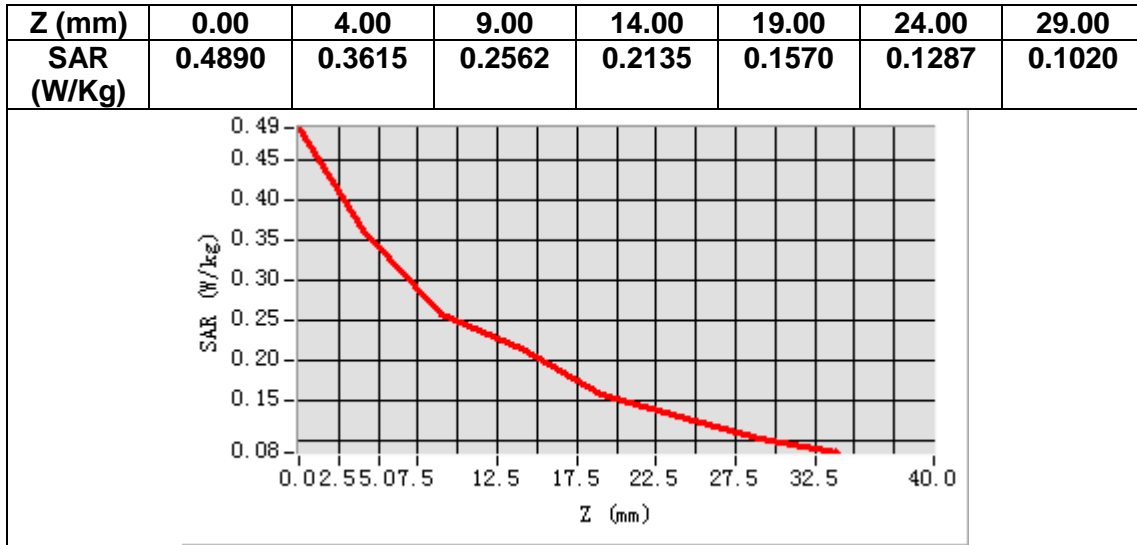

MEASUREMENT 2

Date of measurement: 2/2/2021

A. Experimental conditions.

Area Scan	<u>dx=15mm dy=15mm, h= 5.00 mm</u>
ZoomScan	<u>5x5x7, dx=8mm dy=8mm dz=5mm</u>
Phantom	<u>Validation plane</u>
Device Position	<u>Body</u>
Band	<u>GSM850</u>
Channels	<u>Middle</u>
Signal	<u>TDMA (Crest factor: 2.0)</u>

B. SAR Measurement Results

Frequency (MHz)	836.400000
Relative permittivity (real part)	41.876575
Relative permittivity (imaginary part)	19.524746
Conductivity (S/m)	0.907250
Variation (%)	-2.000000

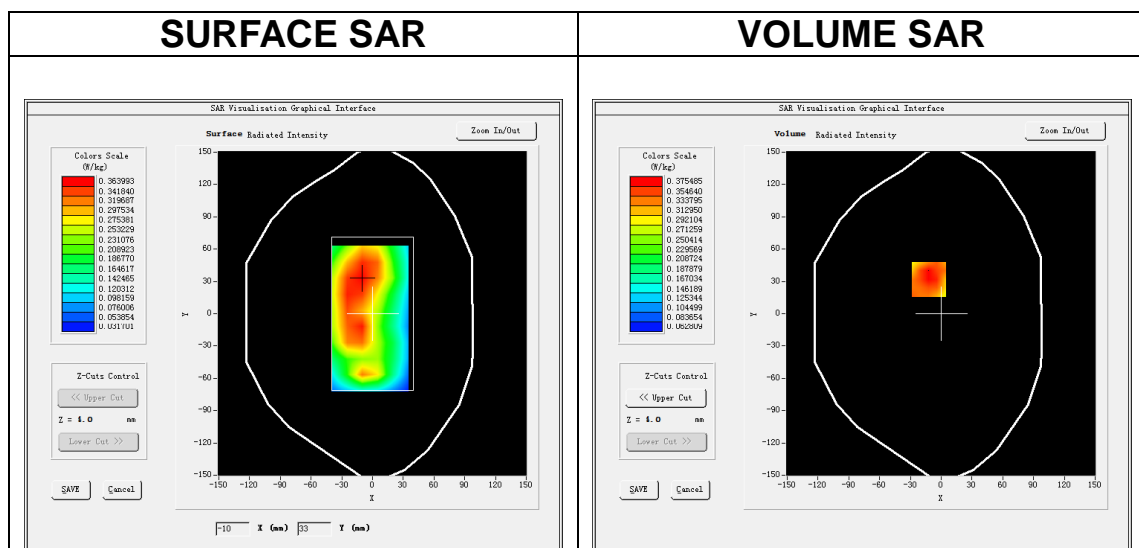

Maximum location: X=-12.00, Y=32.00
SAR Peak: 0.57 W/kg

SAR 10g (W/Kg)	0.266538
SAR 1g (W/Kg)	0.379802

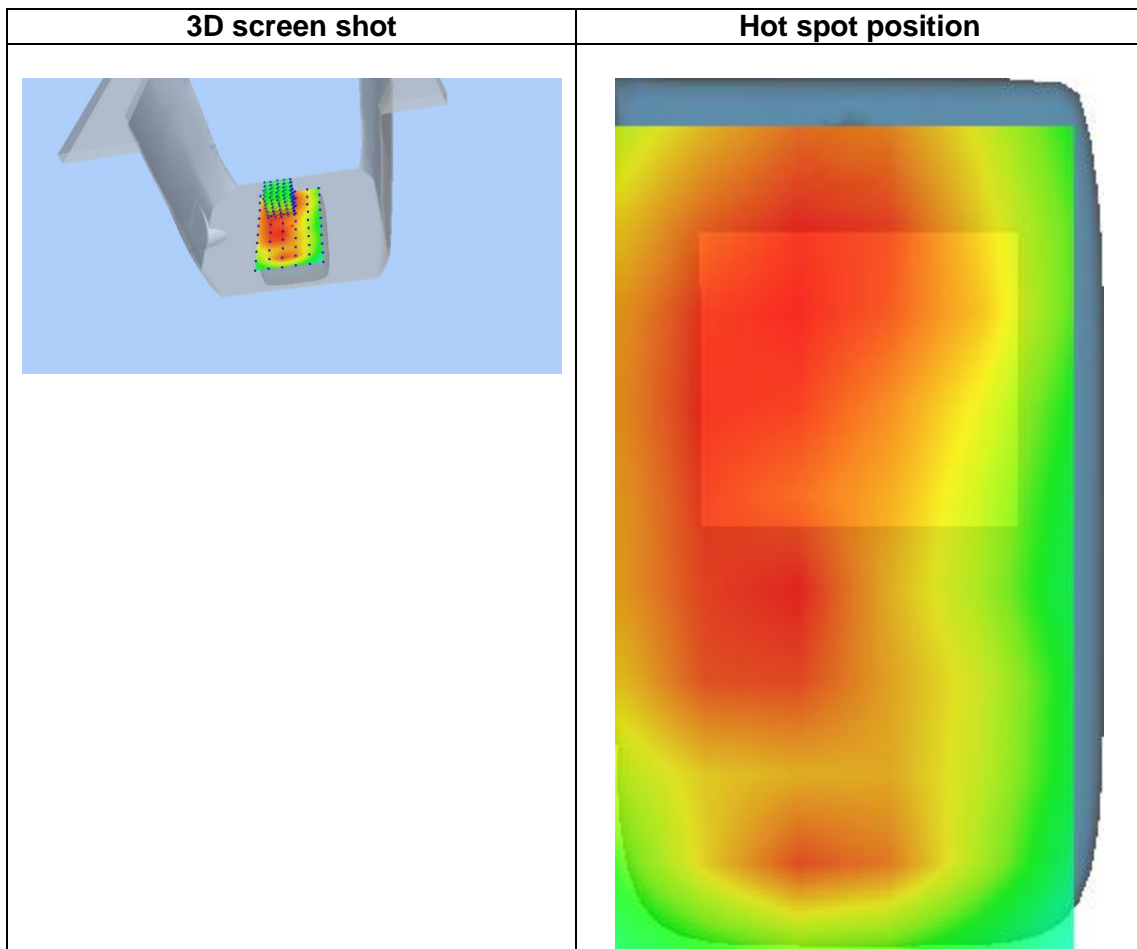
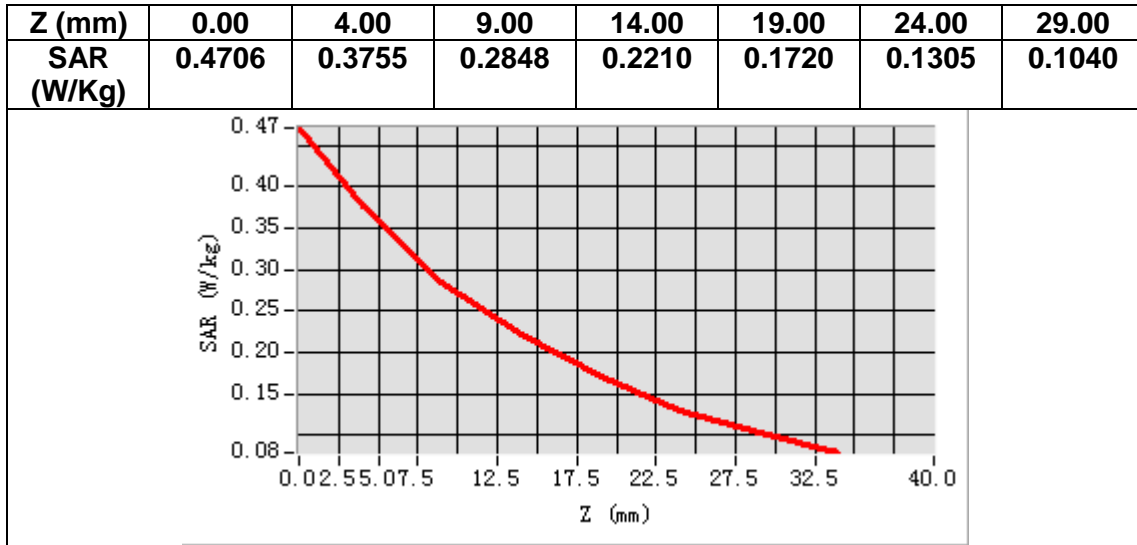

MEASUREMENT 3

Date of measurement: 3/2/2021

A. Experimental conditions.

Area Scan	<u>dx=15mm dy=15mm, h= 5.00 mm</u>
ZoomScan	<u>5x5x7, dx=8mm dy=8mm dz=5mm</u>
Phantom	<u>Left head</u>
Device Position	<u>Cheek</u>
Band	<u>GSM1900</u>
Channels	<u>Middle</u>
Signal	<u>TDMA (Crest factor: 2.0)</u>

B. SAR Measurement Results

Frequency (MHz)	1880.000000
Relative permittivity (real part)	39.868156
Relative permittivity (imaginary part)	13.057934
Conductivity (S/m)	1.363829
Variation (%)	2.310000

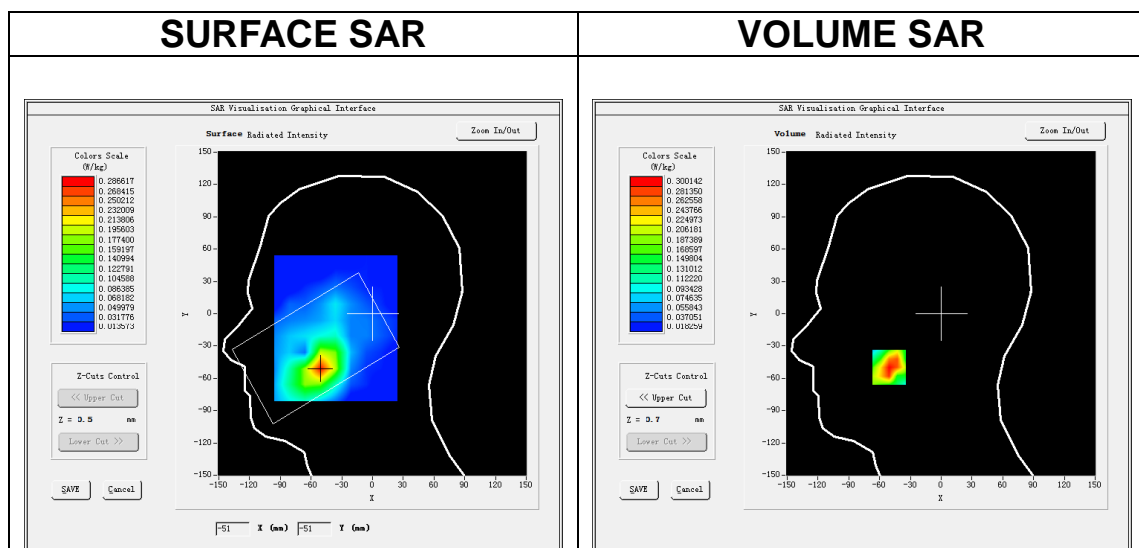

Maximum location: X=-51.00, Y=-50.00

SAR Peak: 0.49 W/kg

SAR 10g (W/Kg)	0.160364
SAR 1g (W/Kg)	0.284922

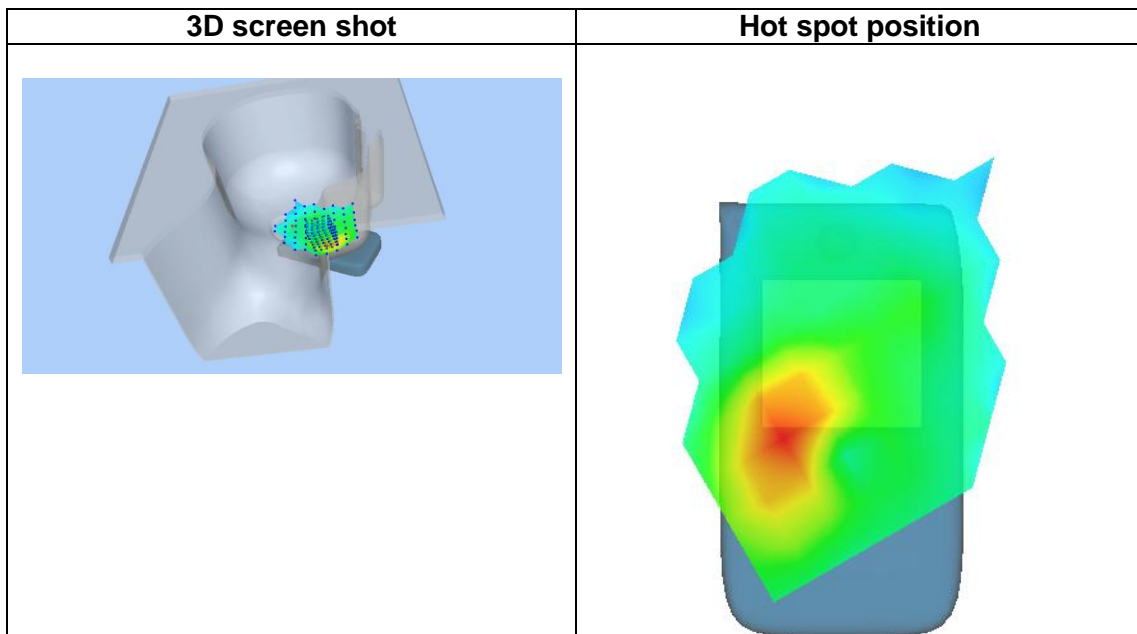
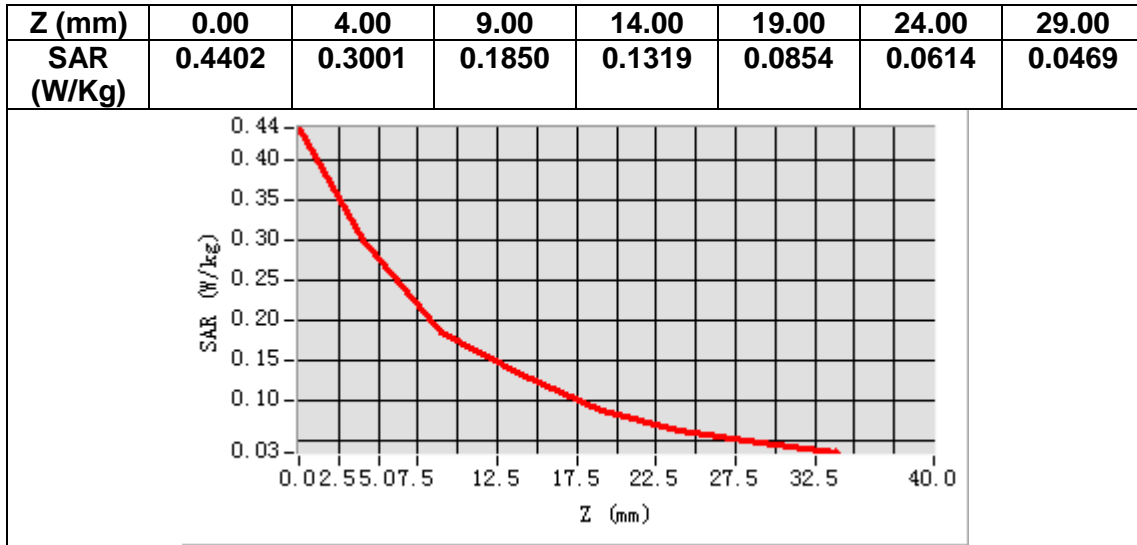

MEASUREMENT 4

Date of measurement: 3/2/2021

A. Experimental conditions.

Area Scan	<u>dx=15mm dy=15mm, h= 5.00 mm</u>
ZoomScan	<u>5x5x7, dx=8mm dy=8mm dz=5mm</u>
Phantom	<u>Validation plane</u>
Device Position	<u>Body</u>
Band	<u>GSM1900</u>
Channels	<u>Middle</u>
Signal	<u>TDMA (Crest factor: 2.0)</u>

B. SAR Measurement Results

Frequency (MHz)	1880.000000
Relative permittivity (real part)	39.868156
Relative permittivity (imaginary part)	13.057934
Conductivity (S/m)	1.363829
Variation (%)	-0.720000

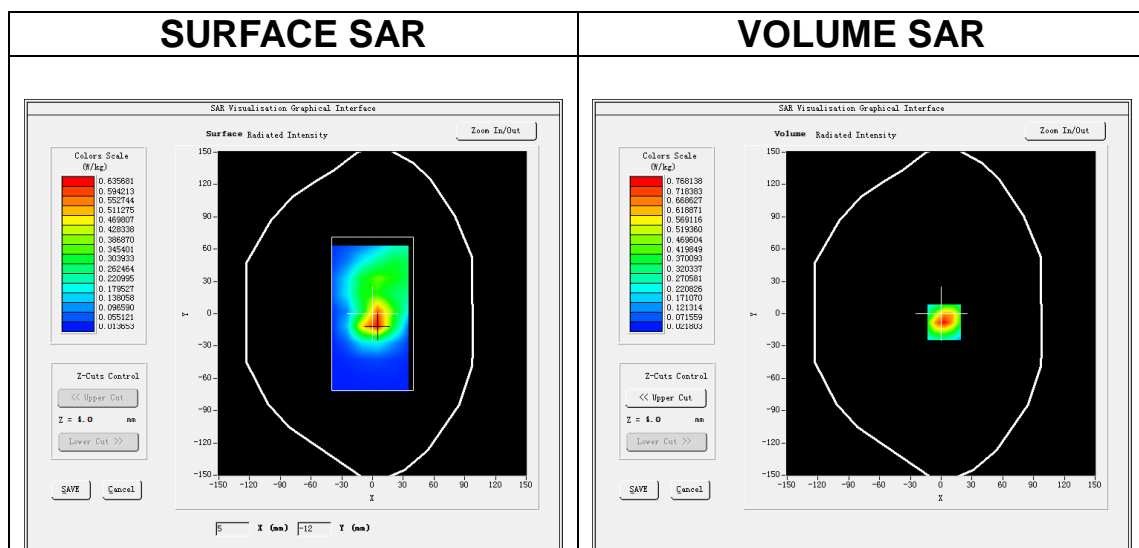

Maximum location: X=3.00, Y=-8.00

SAR Peak: 1.24 W/kg

SAR 10g (W/Kg)	0.368604
SAR 1g (W/Kg)	0.721741

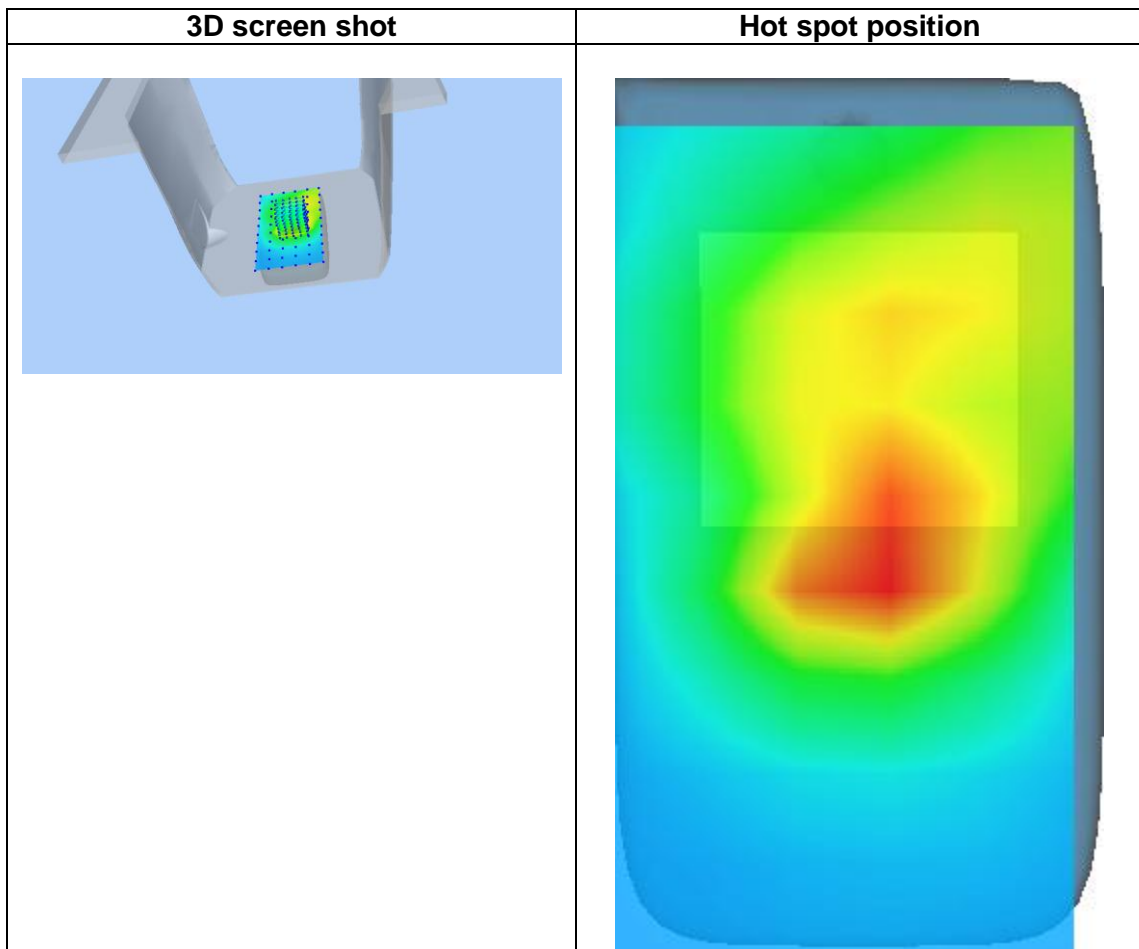
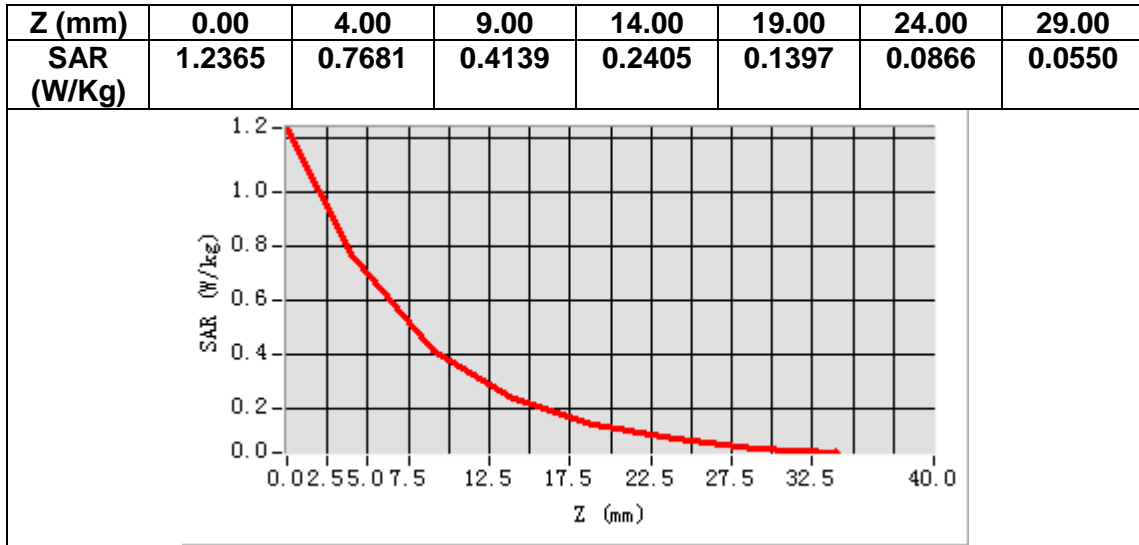

MEASUREMENT 5

Date of measurement: 3/2/2021

A. Experimental conditions.

Area Scan	<u>dx=15mm dy=15mm, h= 5.00 mm</u>
ZoomScan	<u>5x5x7, dx=8mm dy=8mm dz=5mm</u>
Phantom	<u>Left head</u>
Device Position	<u>Cheek</u>
Band	<u>Band2_WCDMA1900</u>
Channels	<u>Middle</u>
Signal	<u>WCDMA (Crest factor: 1.0)</u>

B. SAR Measurement Results

Frequency (MHz)	1880.000000
Relative permittivity (real part)	39.868156
Relative permittivity (imaginary part)	13.057934
Conductivity (S/m)	1.363829
Variation (%)	-2.930000

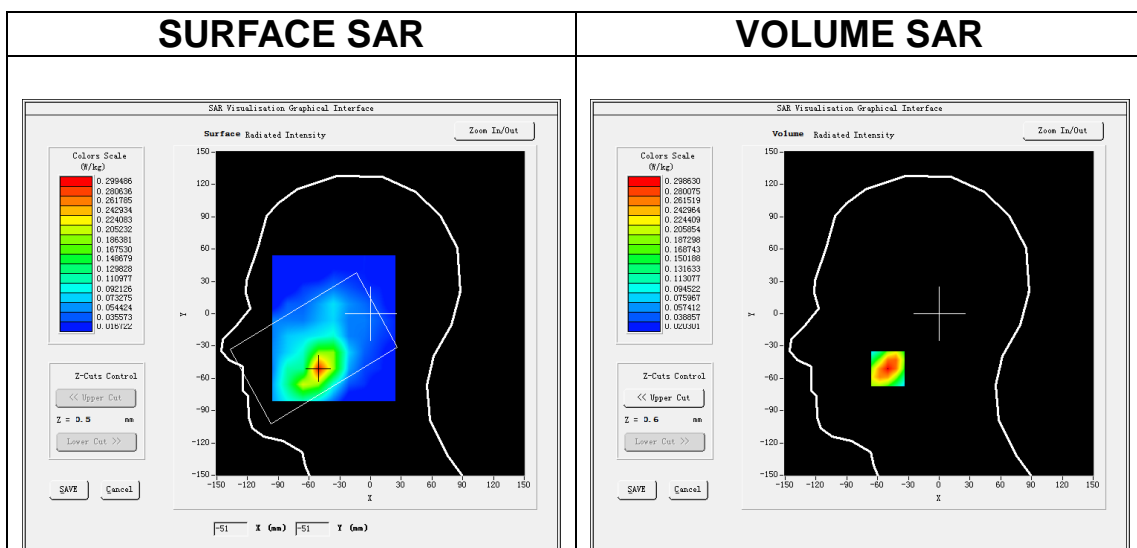

Maximum location: X=-50.00, Y=-51.00

SAR Peak: 0.43 W/kg

SAR 10g (W/Kg)	0.166568
SAR 1g (W/Kg)	0.283079

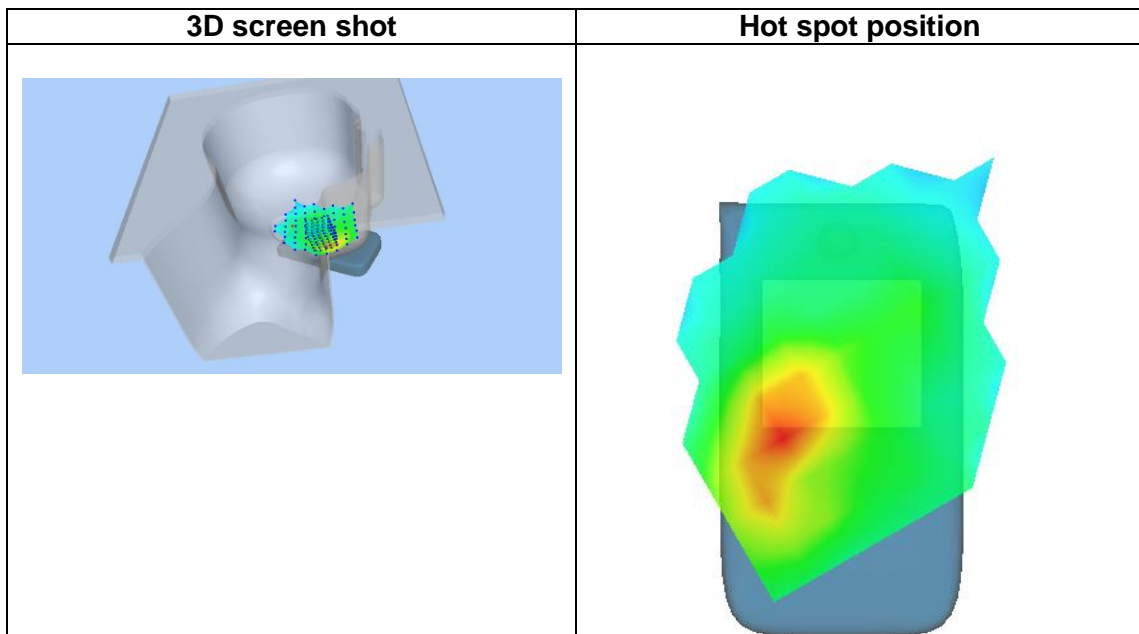
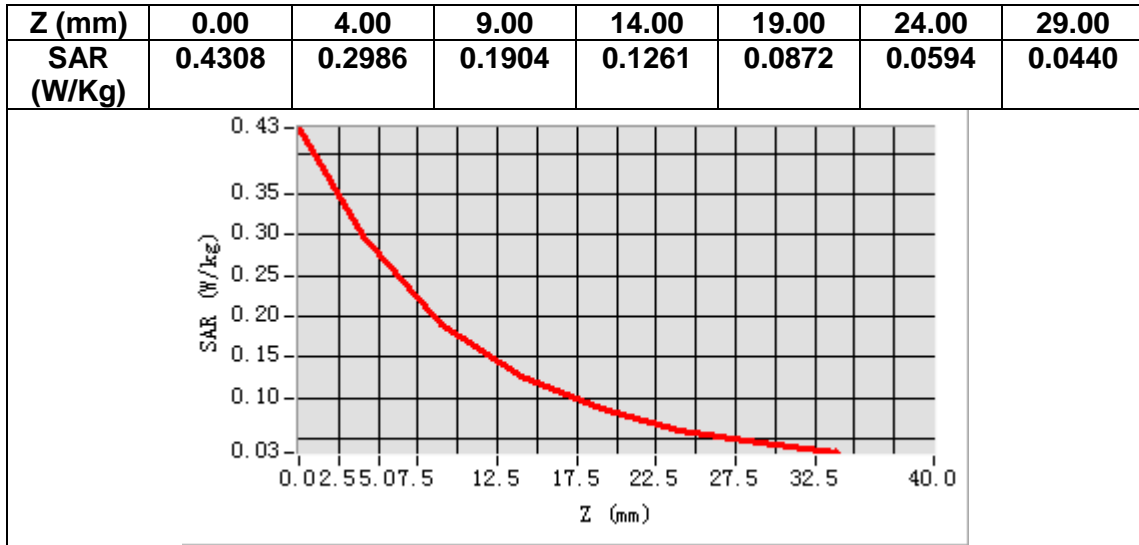

MEASUREMENT 6

Date of measurement: 3/2/2021

A. Experimental conditions.

Area Scan	<u>dx=15mm dy=15mm, h= 5.00 mm</u>
ZoomScan	<u>5x5x7, dx=8mm dy=8mm dz=5mm</u>
Phantom	<u>Validation plane</u>
Device Position	<u>Body</u>
Band	<u>Band2_WCDMA1900</u>
Channels	<u>Middle</u>
Signal	<u>WCDMA (Crest factor: 1.0)</u>

B. SAR Measurement Results

Frequency (MHz)	1880.000000
Relative permittivity (real part)	39.868156
Relative permittivity (imaginary part)	13.057934
Conductivity (S/m)	1.363829
Variation (%)	-1.950000

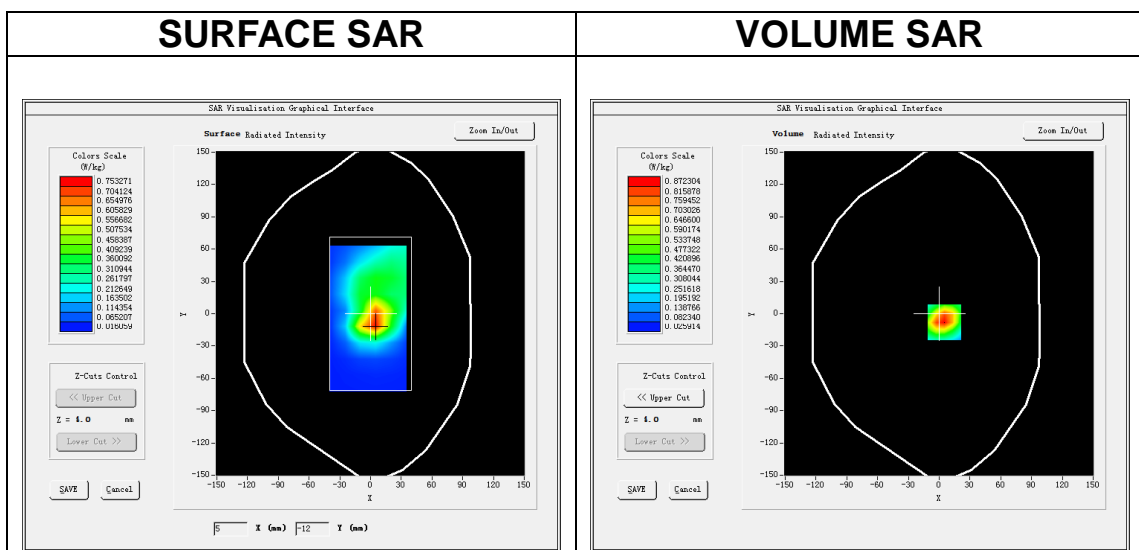

Maximum location: X=5.00, Y=-8.00

SAR Peak: 1.39 W/kg

SAR 10g (W/Kg)	0.437558
SAR 1g (W/Kg)	0.837242

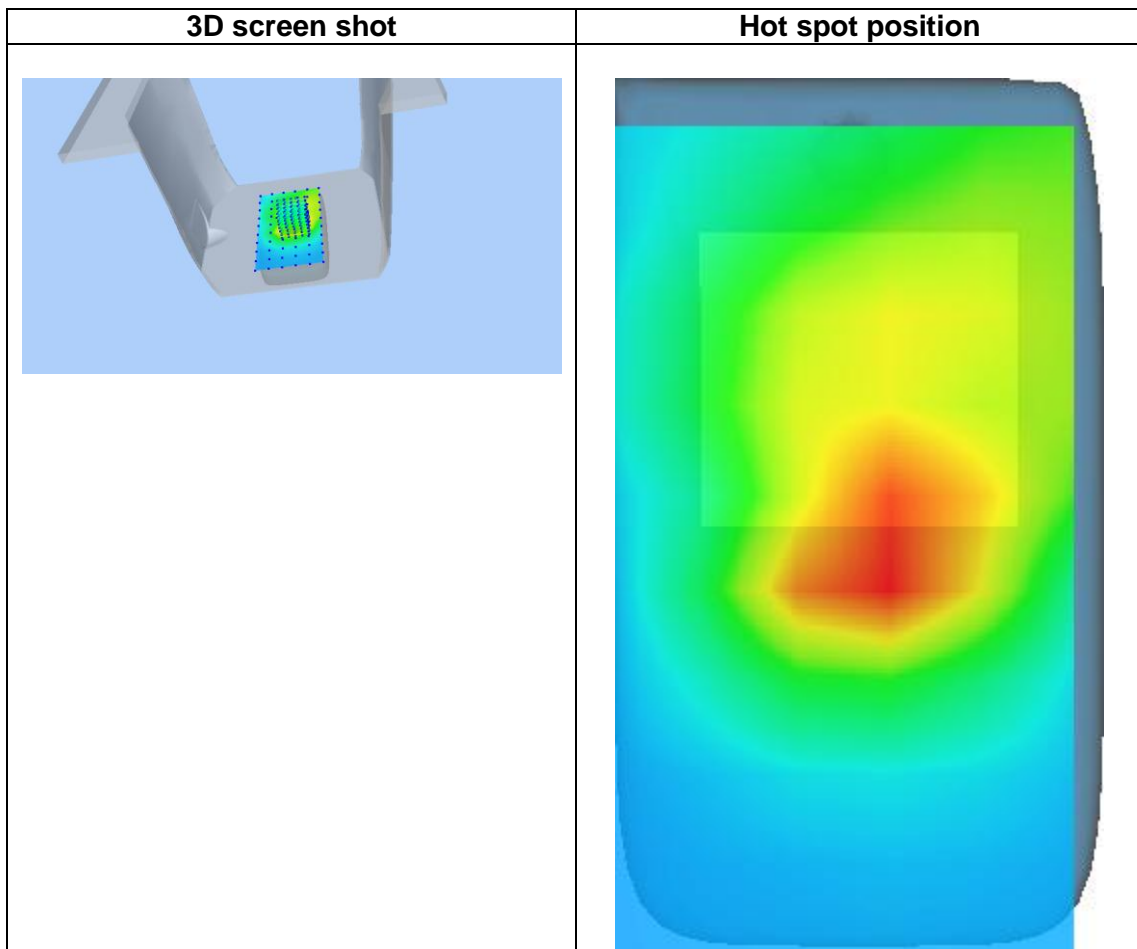
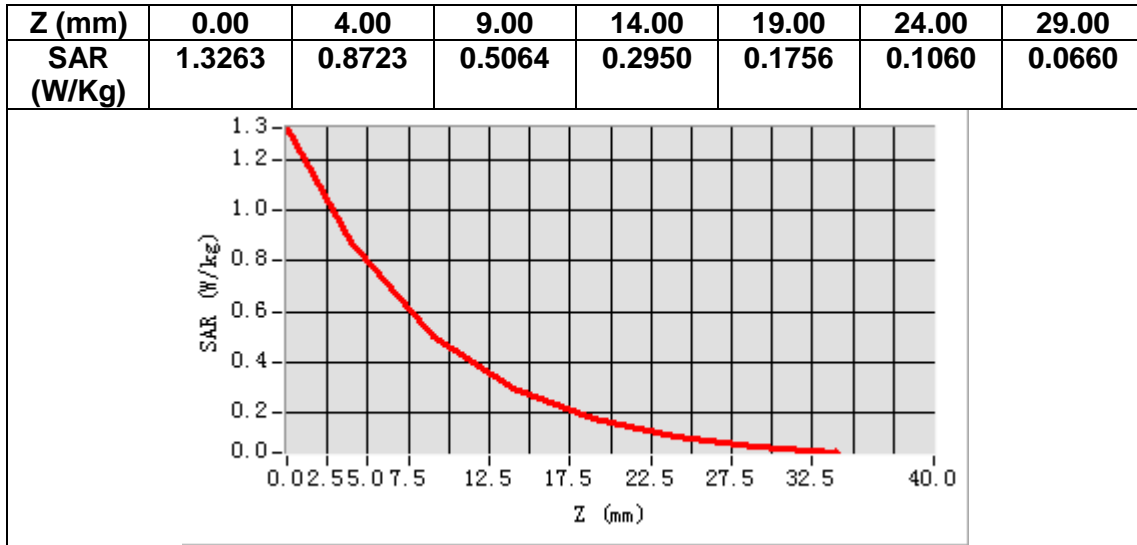

MEASUREMENT 7

Date of measurement: 26/2/2021

A. Experimental conditions.

Area Scan	<u>dx=15mm dy=15mm, h= 5.00 mm</u>
ZoomScan	<u>5x5x7, dx=8mm dy=8mm dz=5mm</u>
Phantom	<u>Left head</u>
Device Position	<u>Cheek</u>
Band	<u>Band4 WCDMA1700</u>
Channels	<u>Middle</u>
Signal	<u>WCDMA (Crest factor: 1.0)</u>

B. SAR Measurement Results

Frequency (MHz)	1732.600000
Relative permittivity (real part)	40.200775
Relative permittivity (imaginary part)	13.941212
Conductivity (S/m)	1.341454
Variation (%)	0.410000

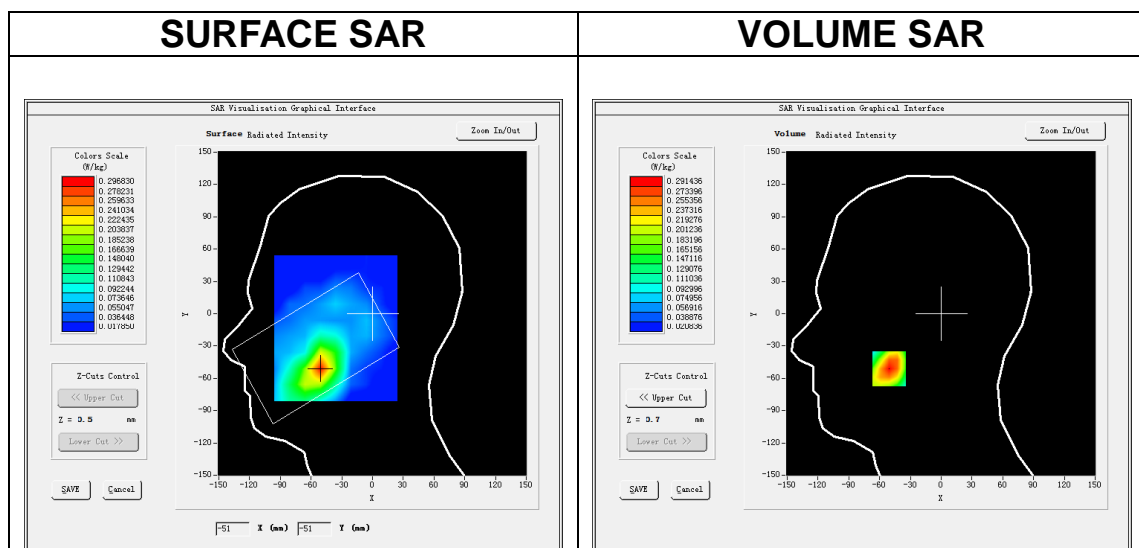

Maximum location: X=-51.00, Y=-51.00

SAR Peak: 0.40 W/kg

SAR 10g (W/Kg)	0.171383
SAR 1g (W/Kg)	0.276900

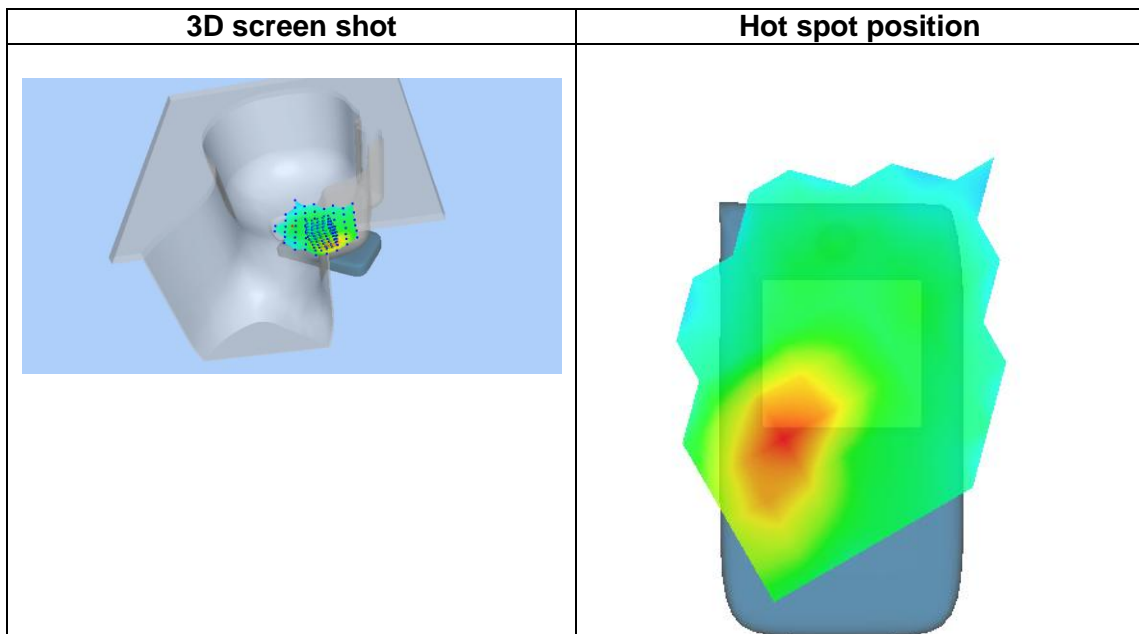
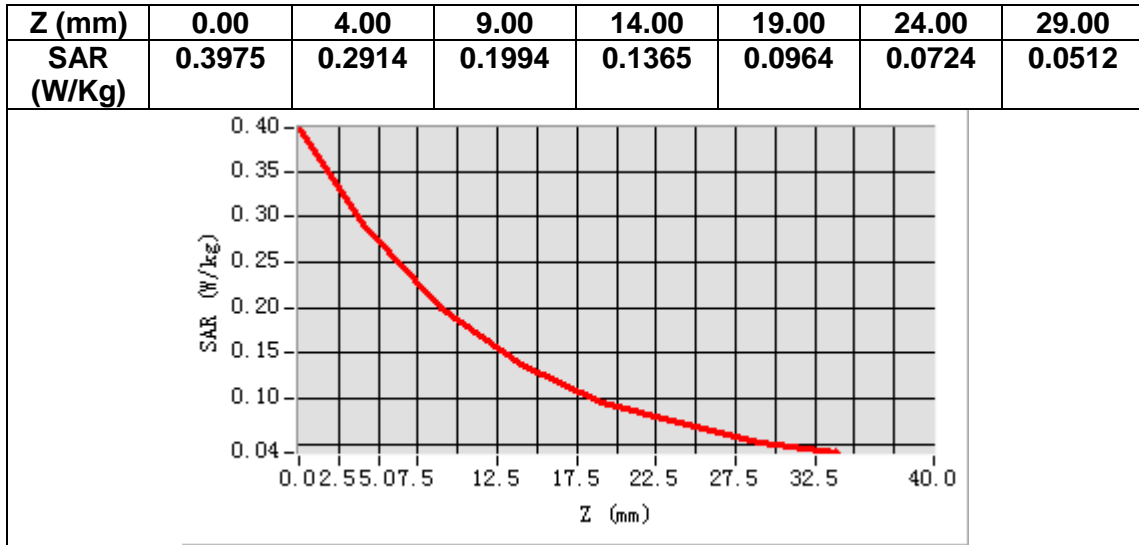

MEASUREMENT 8

Date of measurement: 26/2/2021

A. Experimental conditions.

Area Scan	<u>dx=15mm dy=15mm, h= 5.00 mm</u>
ZoomScan	<u>5x5x7, dx=8mm dy=8mm dz=5mm</u>
Phantom	<u>Validation plane</u>
Device Position	<u>Body</u>
Band	<u>Band4 WCDMA1700</u>
Channels	<u>Low</u>
Signal	<u>WCDMA (Crest factor: 1.0)</u>

B. SAR Measurement Results

Frequency (MHz)	1712.400000
Relative permittivity (real part)	40.366474
Relative permittivity (imaginary part)	13.887812
Conductivity (S/m)	1.320885
Variation (%)	-0.300000

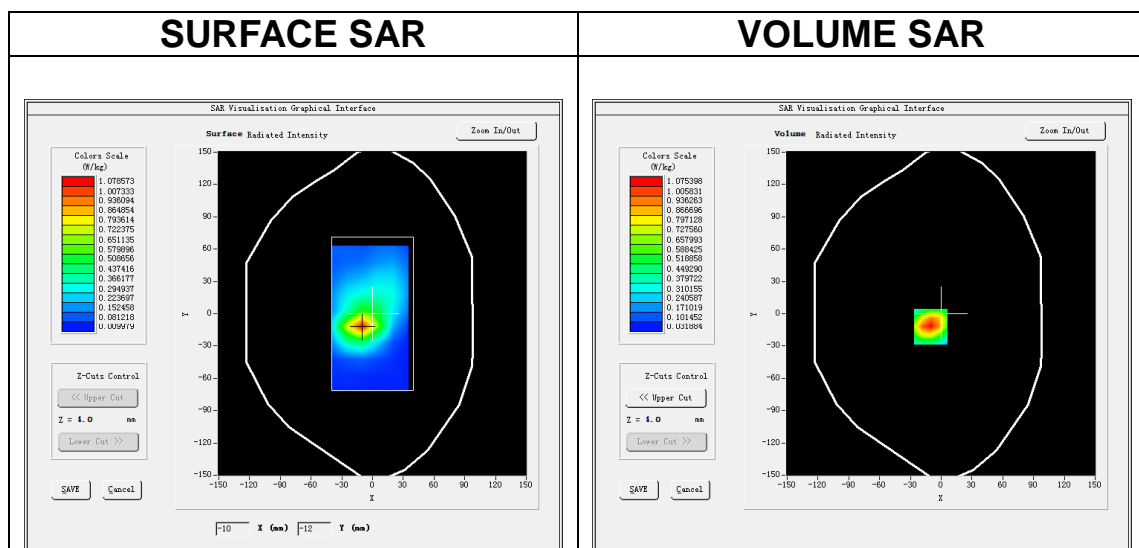

Maximum location: X=-10.00, Y=-12.00

SAR Peak: 1.65 W/kg

SAR 10g (W/Kg)	0.549032
SAR 1g (W/Kg)	1.019110

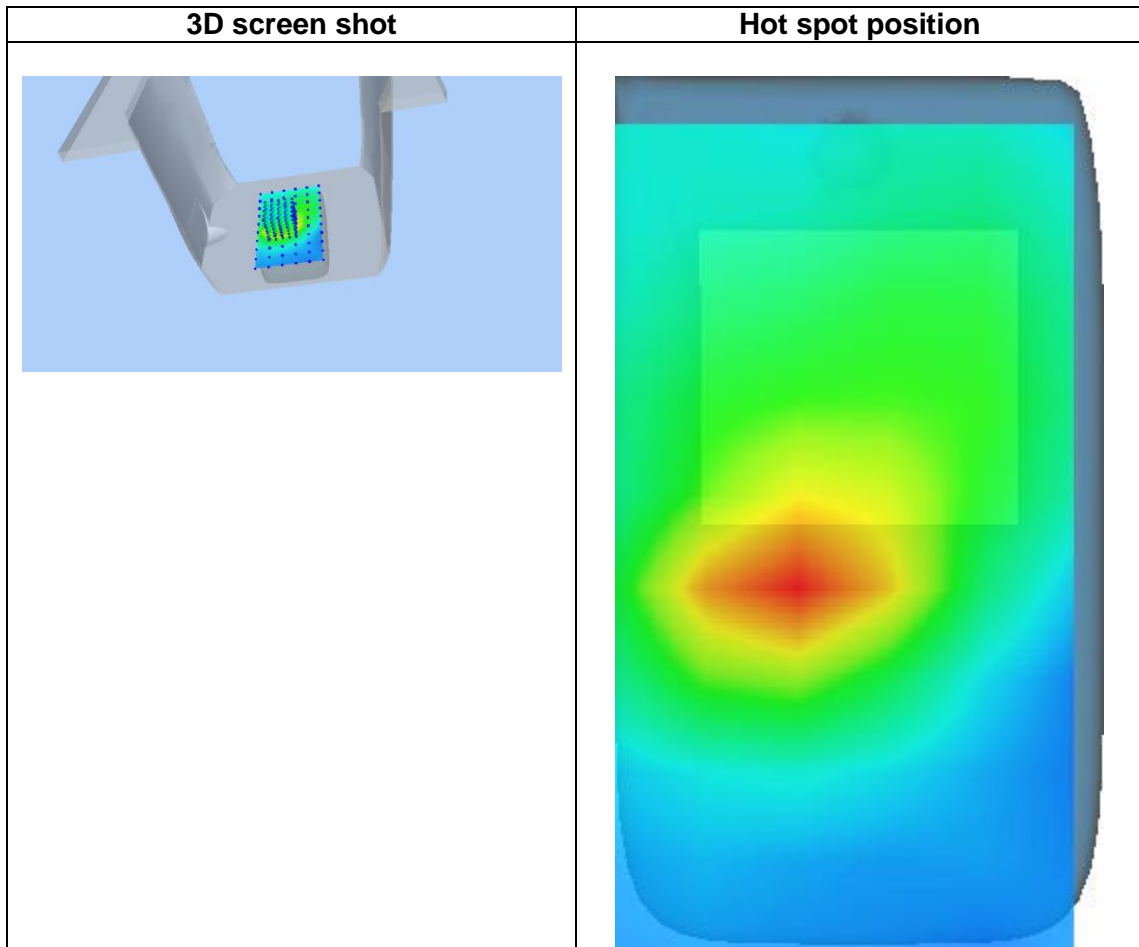
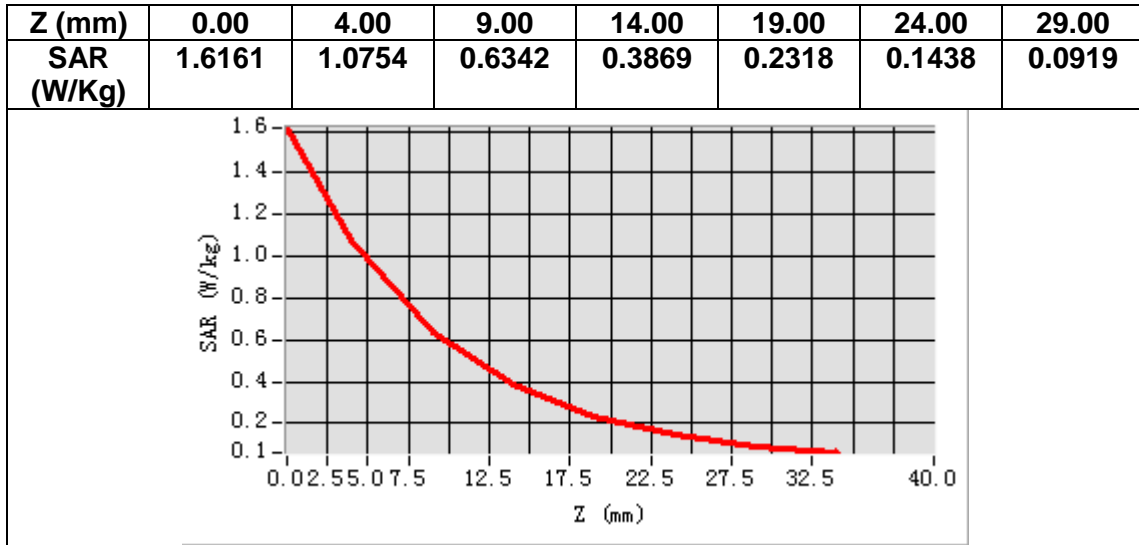

MEASUREMENT 9

Date of measurement: 2/2/2021

A. Experimental conditions.

Area Scan	<u>dx=15mm dy=15mm, h= 5.00 mm</u>
ZoomScan	<u>5x5x7, dx=8mm dy=8mm dz=5mm</u>
Phantom	<u>Left head</u>
Device Position	<u>Cheek</u>
Band	<u>Band5_WCDMA850</u>
Channels	<u>Middle</u>
Signal	<u>WCDMA (Crest factor: 1.0)</u>

B. SAR Measurement Results

Frequency (MHz)	836.400000
Relative permittivity (real part)	41.876575
Relative permittivity (imaginary part)	19.524746
Conductivity (S/m)	0.907250
Variation (%)	-1.650000

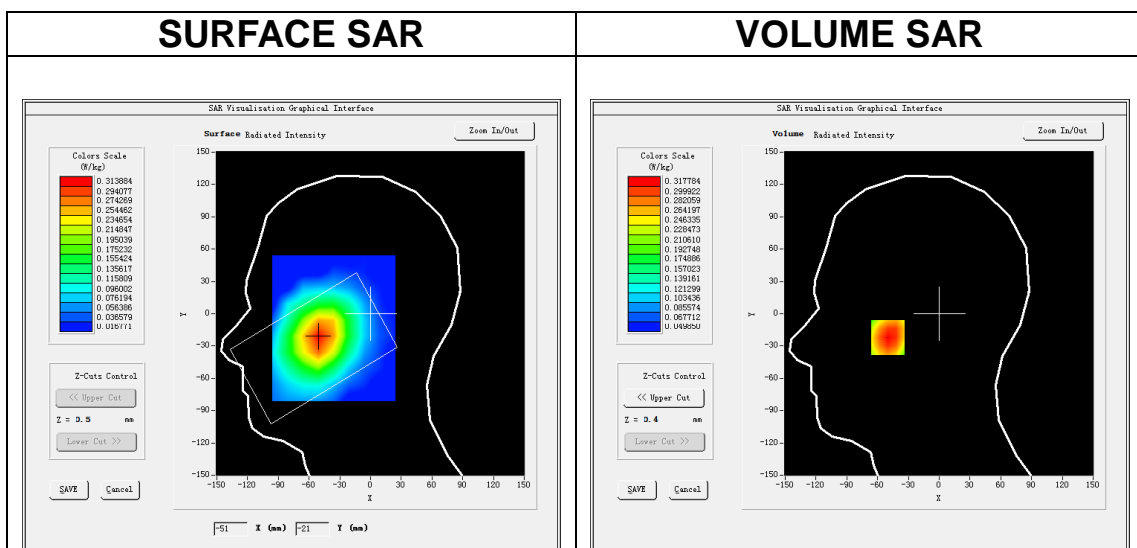

Maximum location: X=-50.00, Y=-22.00
SAR Peak: 0.38 W/kg

SAR 10g (W/Kg)	0.229738
SAR 1g (W/Kg)	0.307744

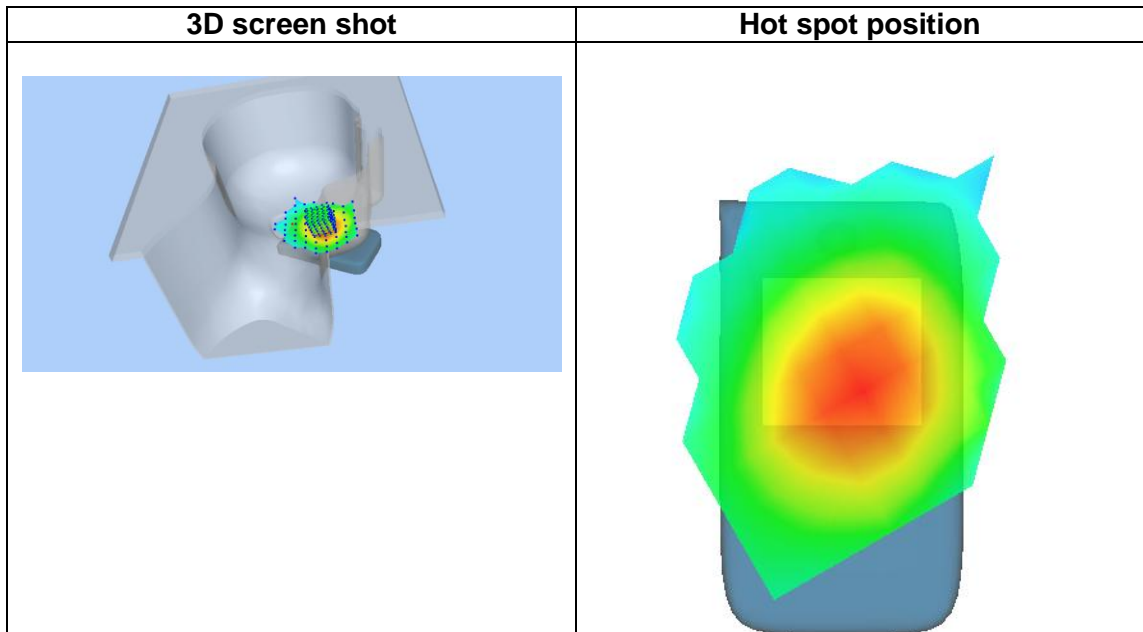
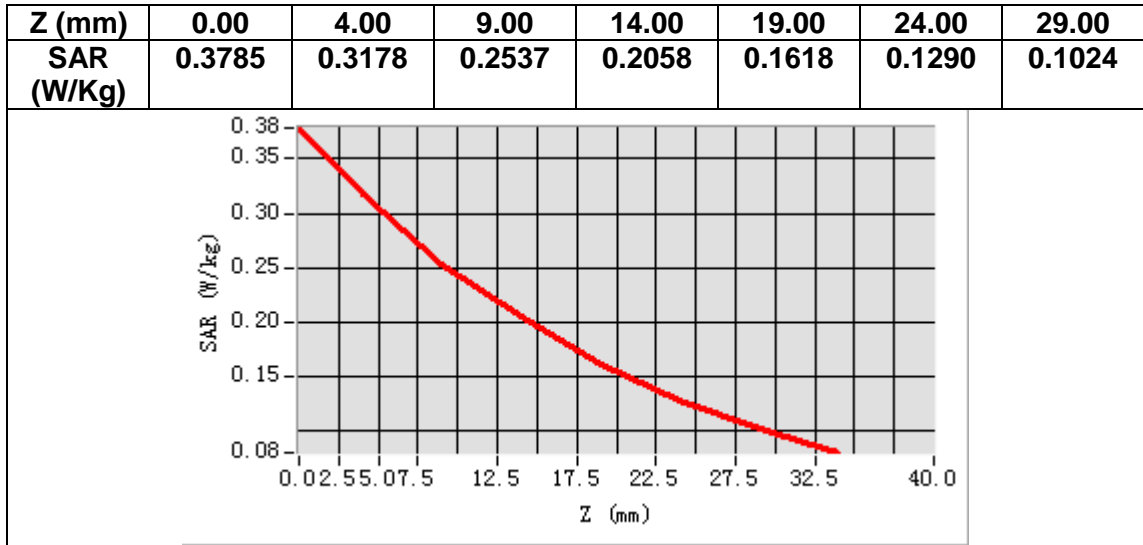

MEASUREMENT 10

Date of measurement: 2/2/2021

A. Experimental conditions.

Area Scan	<u>dx=15mm dy=15mm, h= 5.00 mm</u>
ZoomScan	<u>5x5x7, dx=8mm dy=8mm dz=5mm</u>
Phantom	<u>Validation plane</u>
Device Position	<u>Body</u>
Band	<u>Band5_WCDMA850</u>
Channels	<u>Middle</u>
Signal	<u>WCDMA (Crest factor: 1.0)</u>

B. SAR Measurement Results

Frequency (MHz)	836.400000
Relative permittivity (real part)	41.876575
Relative permittivity (imaginary part)	19.524746
Conductivity (S/m)	0.907250
Variation (%)	-0.070000

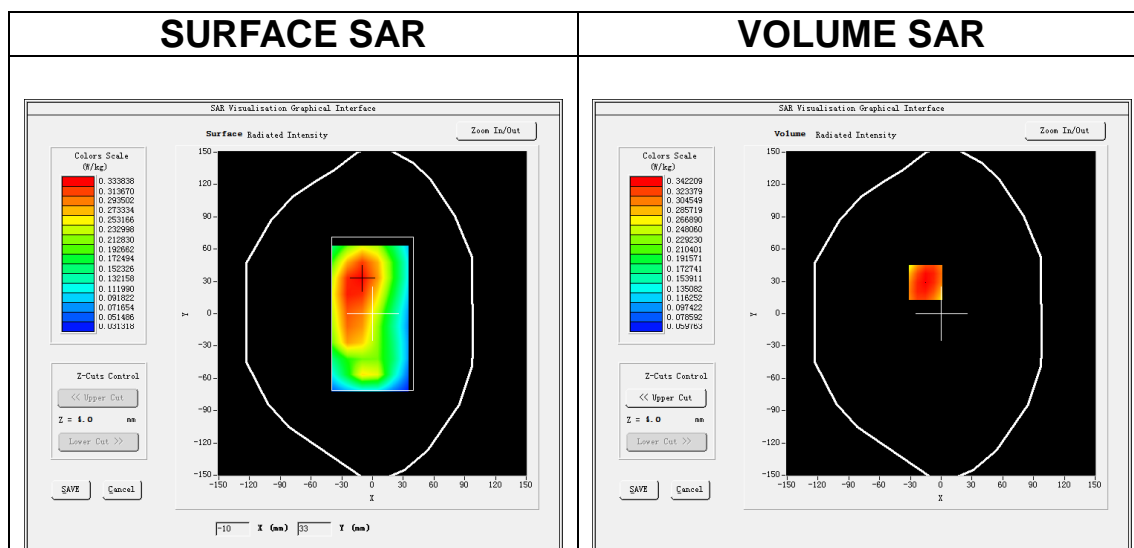

Maximum location: X=-15.00, Y=29.00

SAR Peak: 0.42 W/kg

SAR 10g (W/Kg)	0.250331
SAR 1g (W/Kg)	0.332466

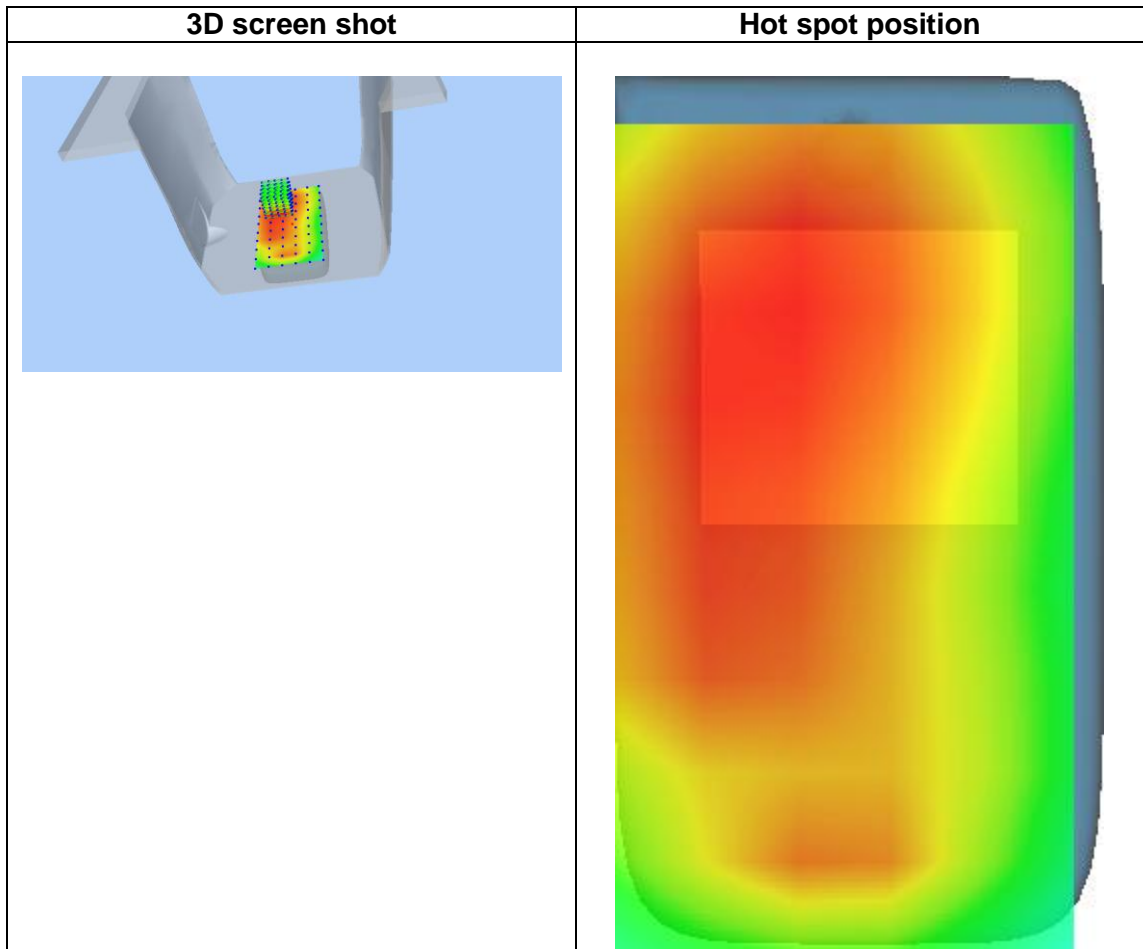
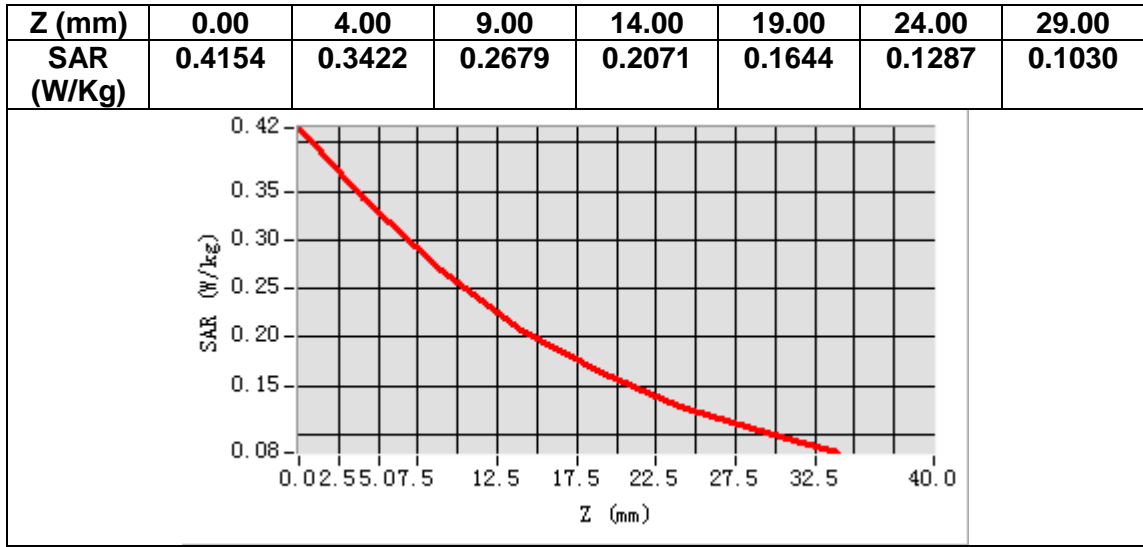

MEASUREMENT 11

Date of measurement: 6/2/2021

A. Experimental conditions.

Area Scan	<u>dx=10mm dy=10mm, h= 2.00 mm</u>
ZoomScan	<u>7x7x12,dx=4mm dy=4mm dz=2mm</u>
Phantom	<u>Left head</u>
Device Position	<u>Cheek</u>
Band	<u>IEEE 802.11a U-NII</u>
Channels	<u>Middle</u>
Signal	<u>IEEE802.11a (Crest factor: 1.0)</u>

B. SAR Measurement Results

Frequency (MHz)	5200.000000
Relative permittivity (real part)	37.077827
Relative permittivity (imaginary part)	15.877089
Conductivity (S/m)	4.586715
Variation (%)	-2.340000

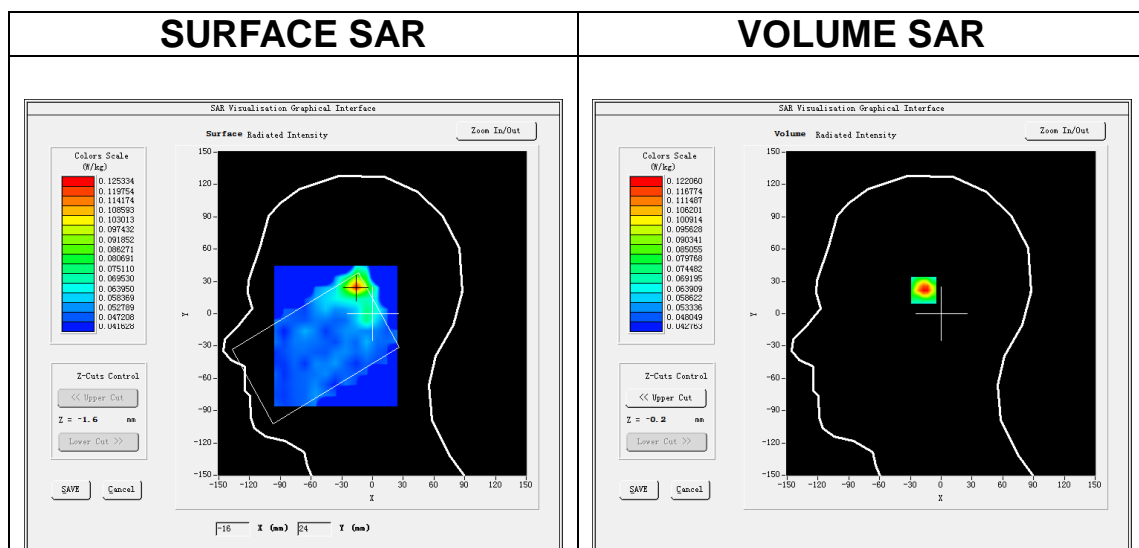

Maximum location: X=-16.00, Y=25.00

SAR Peak: 0.25 W/kg

SAR 10g (W/Kg)	0.071477
SAR 1g (W/Kg)	0.114840

Z (m)	0.00	2.00	4.00	6.00	8.00	10.00	12.00	14.00	16.00	18.00	20.00	22.00
SAR (W/Kg)	0.1622	0.1221	0.0841	0.0741	0.0595	0.0527	0.0465	0.0488	0.0513	0.0528	0.0545	0.0494

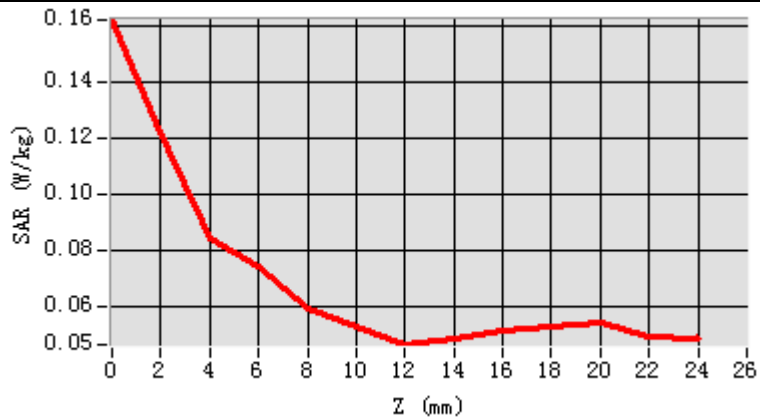

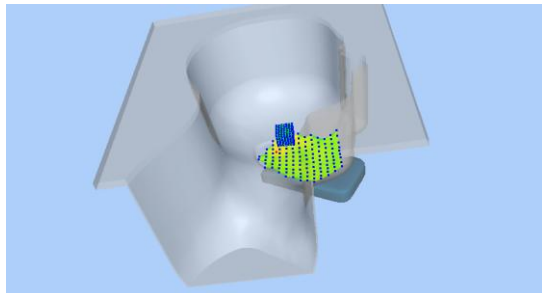
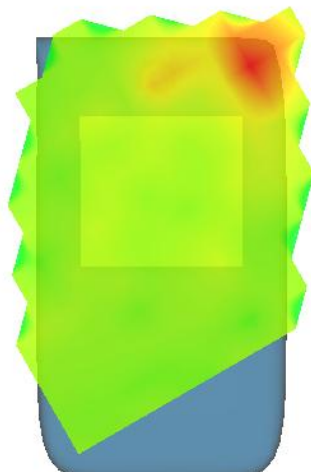
3D screen shot	Hot spot position
	

MEASUREMENT 12

Date of measurement: 7/2/2021

A. Experimental conditions.

Area Scan	<u>dx=10mm dy=10mm, h= 2.00 mm</u>
ZoomScan	<u>7x7x12,dx=4mm dy=4mm dz=2mm</u>
Phantom	<u>Left head</u>
Device Position	<u>Cheek</u>
Band	<u>IEEE 802.11a U-NII</u>
Channels	<u>Middle</u>
Signal	<u>IEEE802.11a (Crest factor: 1.0)</u>

B. SAR Measurement Results

Frequency (MHz)	5785.000000
Relative permittivity (real part)	35.616467
Relative permittivity (imaginary part)	16.174400
Conductivity (S/m)	5.198272
Variation (%)	3.400000

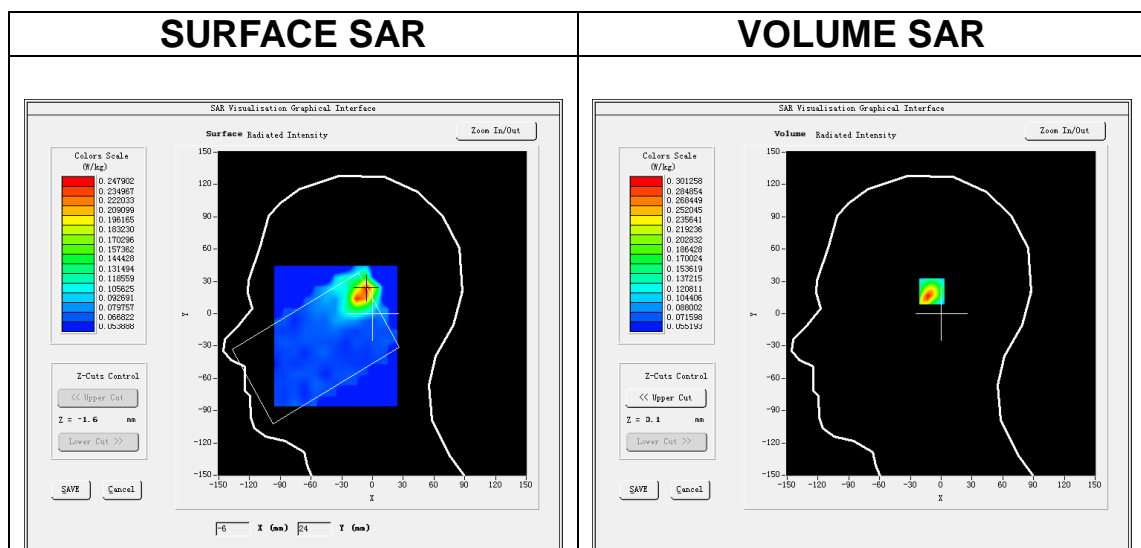

Maximum location: X=-6.00, Y=23.00

SAR Peak: 0.74 W/kg

SAR 10g (W/Kg)	0.136298
SAR 1g (W/Kg)	0.285811

Z (m m)	0.00	2.00	4.00	6.00	8.00	10.0	12.0	14.0	16.0	18.0	20.0	22.0
SAR (W/ Kg)	0.49 05	0.30 13	0.13 36	0.11 33	0.08 15	0.07 79	0.06 52	0.06 76	0.06 72	0.06 13	0.07 30	0.06 38

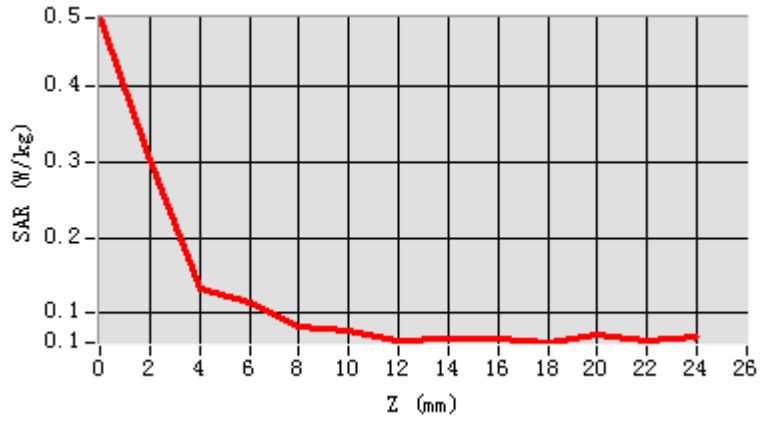

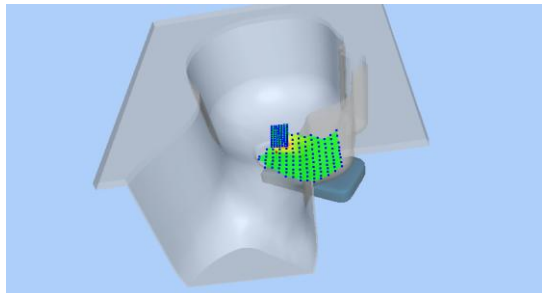
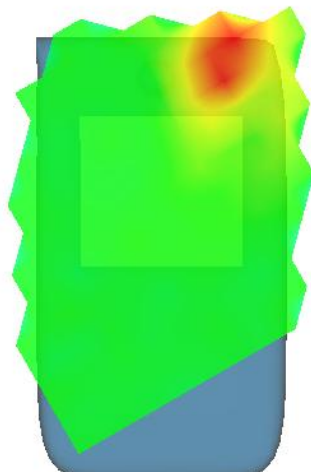
3D screen shot	Hot spot position
	

MEASUREMENT 13

Date of measurement: 6/2/2021

A. Experimental conditions.

Area Scan	<u>dx=10mm dy=10mm, h= 2.00 mm</u>
ZoomScan	<u>7x7x12,dx=4mm dy=4mm dz=2mm</u>
Phantom	<u>Validation plane</u>
Device Position	<u>Body(10mm)</u>
Band	<u>IEEE 802.11a U-NII</u>
Channels	<u>Middle</u>
Signal	<u>IEEE802.11a (Crest factor: 1.0)</u>

B. SAR Measurement Results

Frequency (MHz)	5200.000000
Relative permittivity (real part)	37.077827
Relative permittivity (imaginary part)	15.877089
Conductivity (S/m)	4.586715
Variation (%)	-3.200000

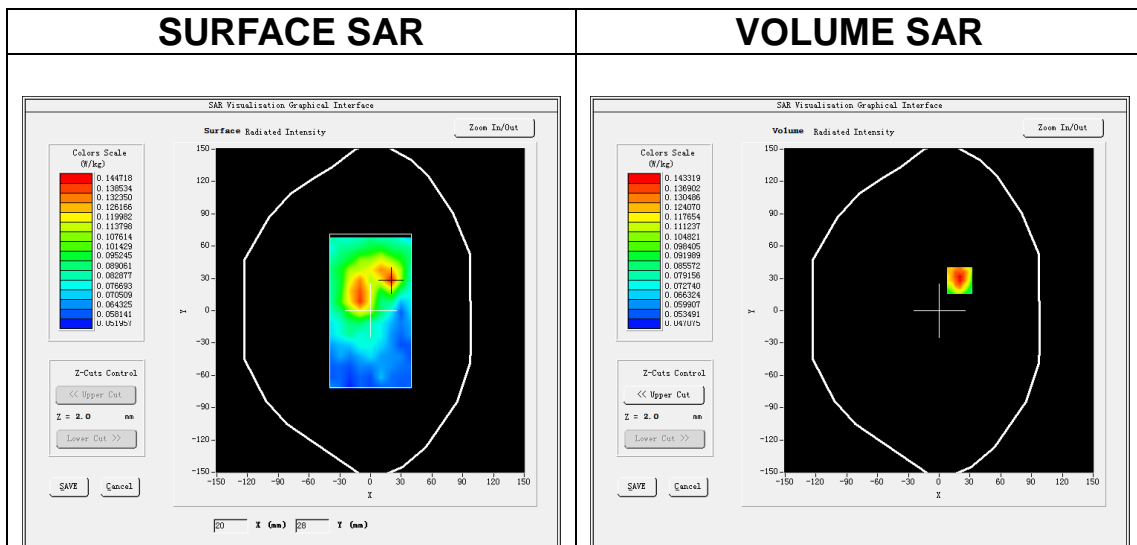

Maximum location: X=20.00, Y=28.00
SAR Peak: 0.21 W/kg

SAR 10g (W/Kg)	0.055476
SAR 1g (W/Kg)	0.090339

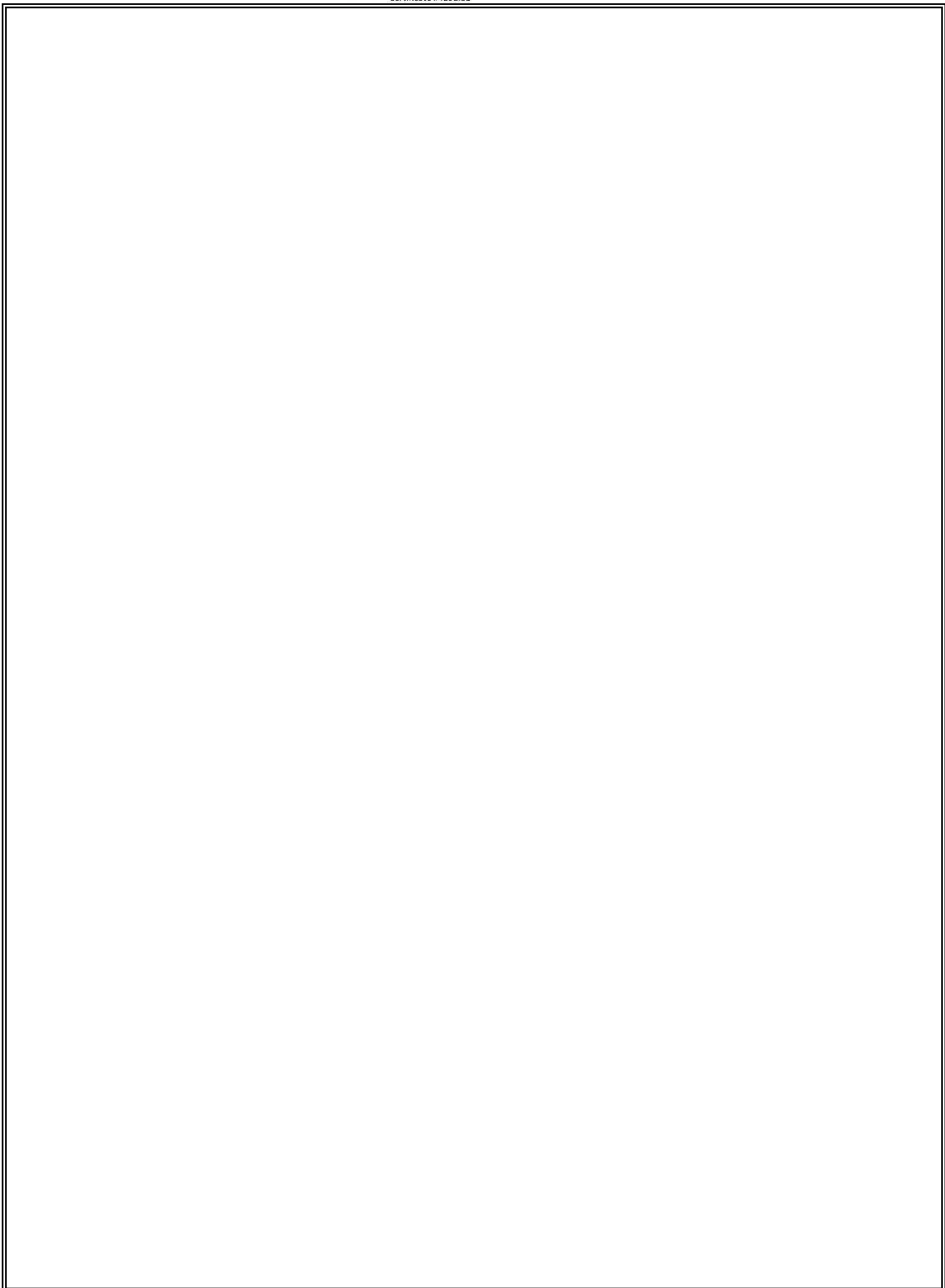

Z (m)	0.00	2.00	4.00	6.00	8.00	10.00	12.00	14.00	16.00	18.00	20.00	22.00
SAR (W/Kg)	0.1902	0.1433	0.0952	0.0882	0.0778	0.0668	0.0639	0.0593	0.0583	0.0595	0.0556	0.0639

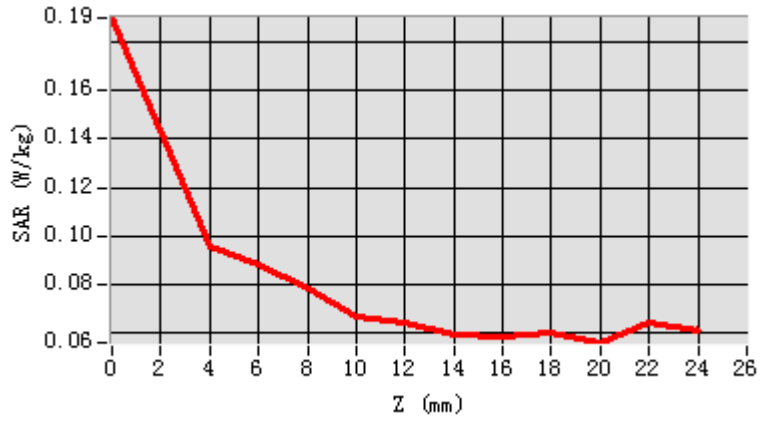

3D screen shot

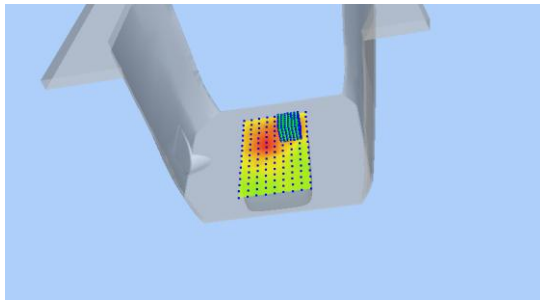

Hot spot position

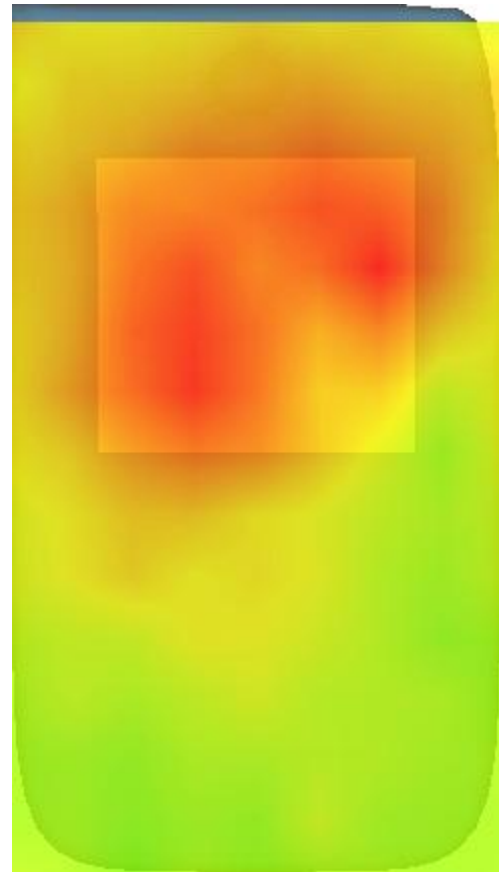

MEASUREMENT 14

Date of measurement: 7/2/2021

A. Experimental conditions.

Area Scan	<u>dx=10mm dy=10mm, h= 2.00 mm</u>
ZoomScan	<u>7x7x12,dx=4mm dy=4mm dz=2mm</u>
Phantom	<u>Validation plane</u>
Device Position	<u>Body</u>
Band	<u>IEEE 802.11a U-NII</u>
Channels	<u>Middle</u>
Signal	<u>IEEE802.11a (Crest factor: 1.0)</u>

B. SAR Measurement Results

Frequency (MHz)	5785.000000
Relative permittivity (real part)	35.616467
Relative permittivity (imaginary part)	16.174400
Conductivity (S/m)	5.198272
Variation (%)	-1.020000

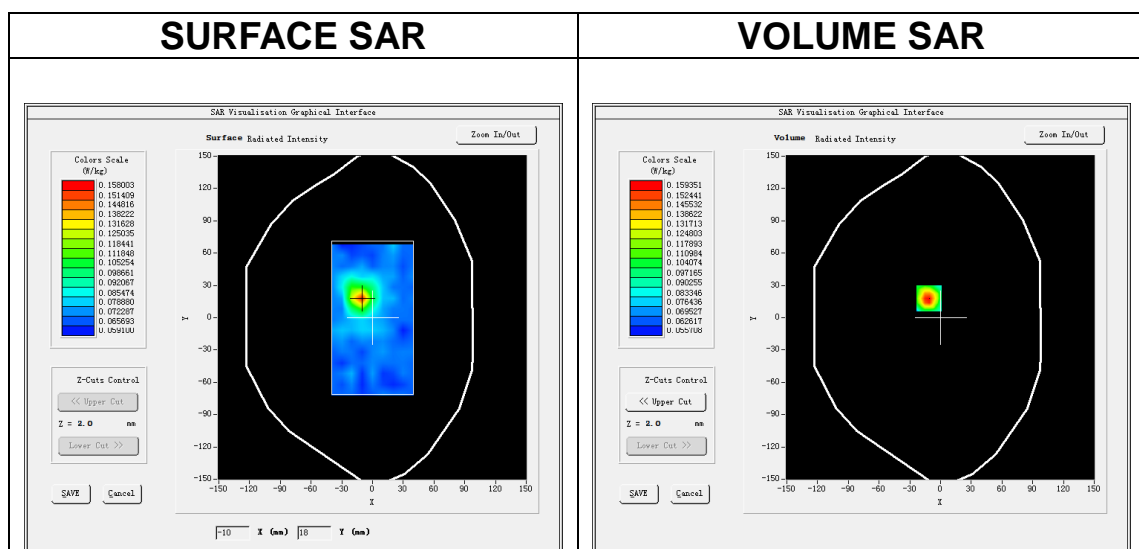

Maximum location: X=-11.00, Y=18.00
SAR Peak: 0.24 W/kg

SAR 10g (W/Kg)	0.060011
SAR 1g (W/Kg)	0.107076

Z (m m)	0.00	2.00	4.00	6.00	8.00	10.0	12.0	14.0	16.0	18.0	20.0	22.0
SAR (W/ Kg)	0.23 09	0.15 94	0.10 38	0.09 13	0.06 88	0.06 78	0.06 91	0.07 01	0.06 73	0.07 03	0.06 76	0.06 56

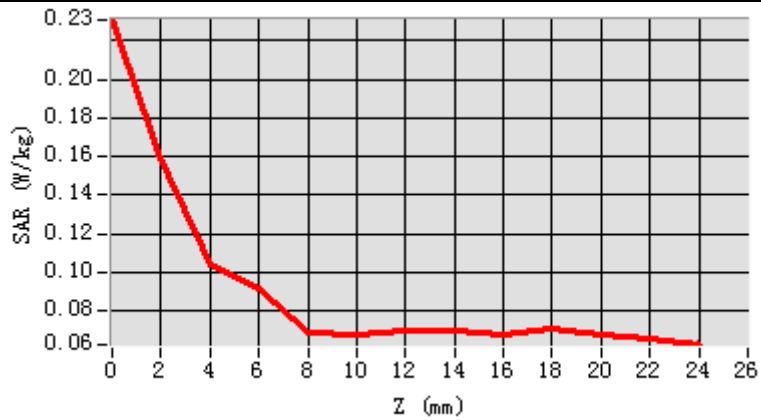

3D screen shot

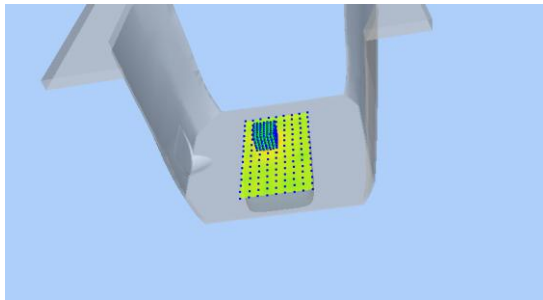

Hot spot position

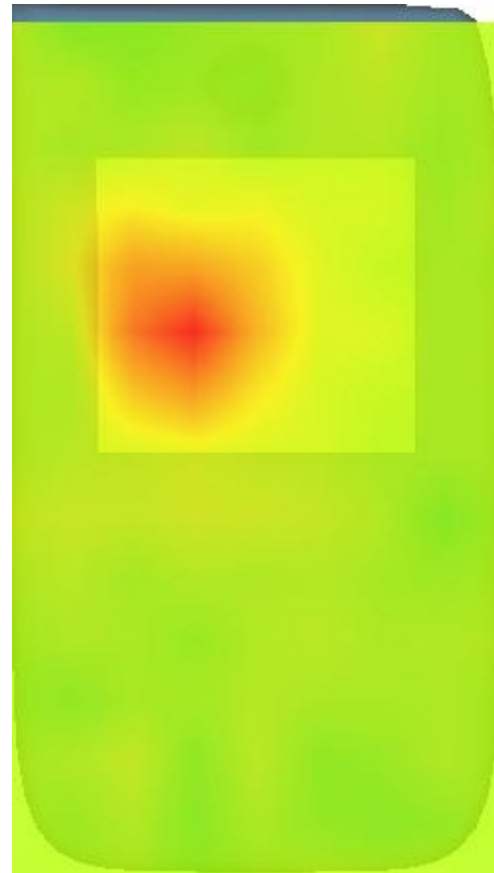

MEASUREMENT 15

Date of measurement: 2/2/2021

A. Experimental conditions.

Area Scan	<u>dx=12mm dy=12mm, h= 5.00 mm</u>
ZoomScan	<u>7x7x7,dx=5mm dy=5mm dz=5mm</u>
Phantom	<u>Left head</u>
Device Position	<u>Cheek</u>
Band	<u>IEEE 802.11b ISM</u>
Channels	<u>Middle</u>
Signal	<u>IEEE802.11b (Crest factor: 1.0)</u>

B. SAR Measurement Results

Frequency (MHz)	2437.000000
Relative permittivity (real part)	39.592679
Relative permittivity (imaginary part)	13.401491
Conductivity (S/m)	1.814413
Variation (%)	-1.200000

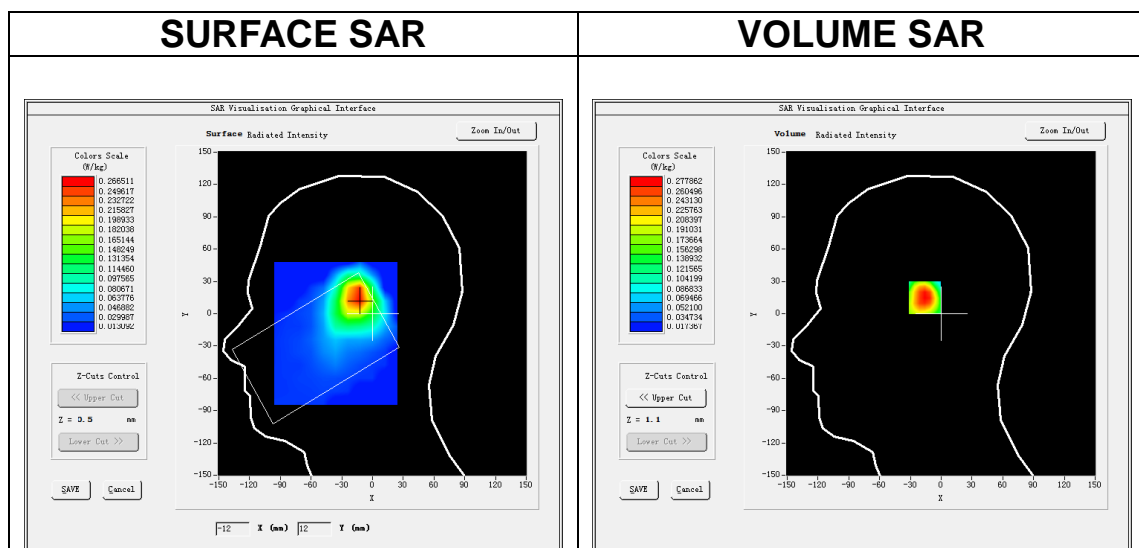

Maximum location: X=-14.00, Y=16.00
SAR Peak: 0.46 W/kg

SAR 10g (W/Kg)	0.143895
SAR 1g (W/Kg)	0.267421

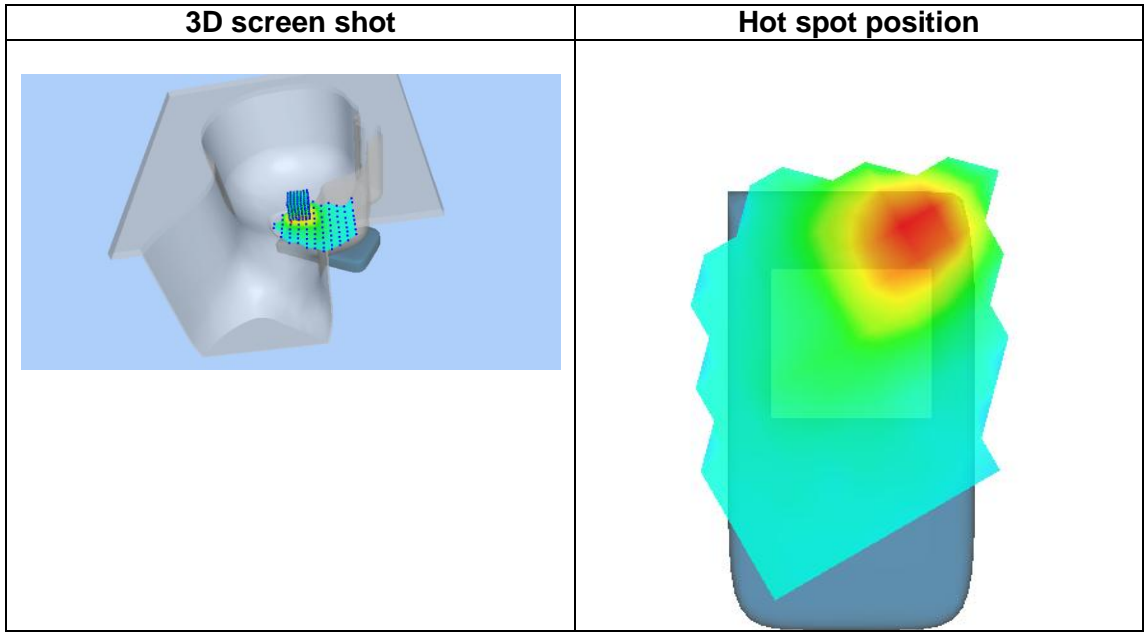
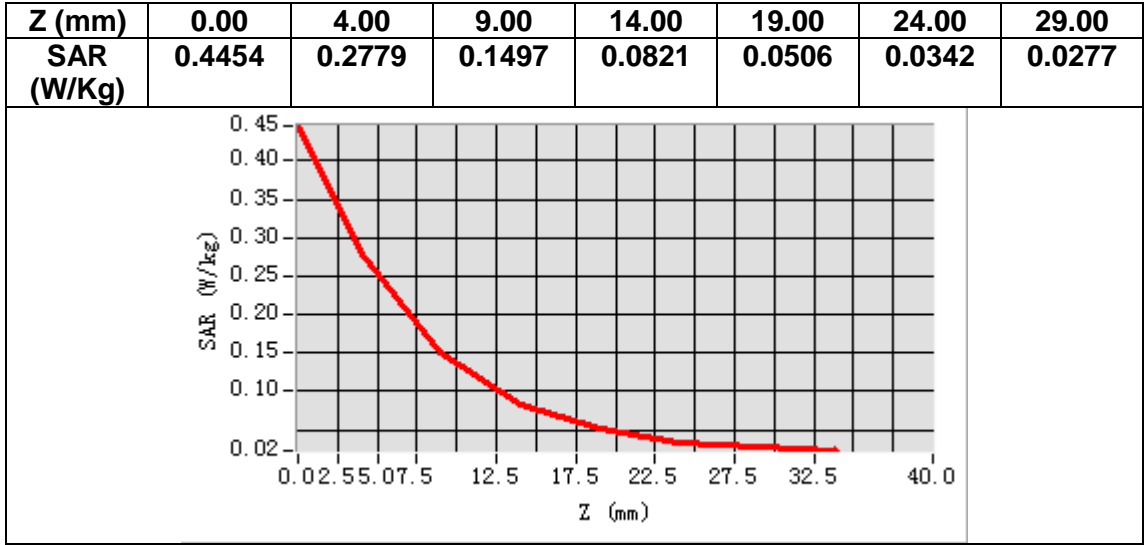

MEASUREMENT 16

Date of measurement: 2/2/2021

A. Experimental conditions.

Area Scan	<u>dx=12mm dy=12mm, h= 5.00 mm</u>
ZoomScan	<u>7x7x7, dx=5mm dy=5mm dz=5mm</u>
Phantom	<u>Validation plane</u>
Device Position	<u>Body</u>
Band	<u>IEEE 802.11b ISM</u>
Channels	<u>Middle</u>
Signal	<u>IEEE802.11b (Crest factor: 1.0)</u>

B. SAR Measurement Results

Frequency (MHz)	2437.000000
Relative permittivity (real part)	39.592679
Relative permittivity (imaginary part)	13.401491
Conductivity (S/m)	1.814413
Variation (%)	0.870000

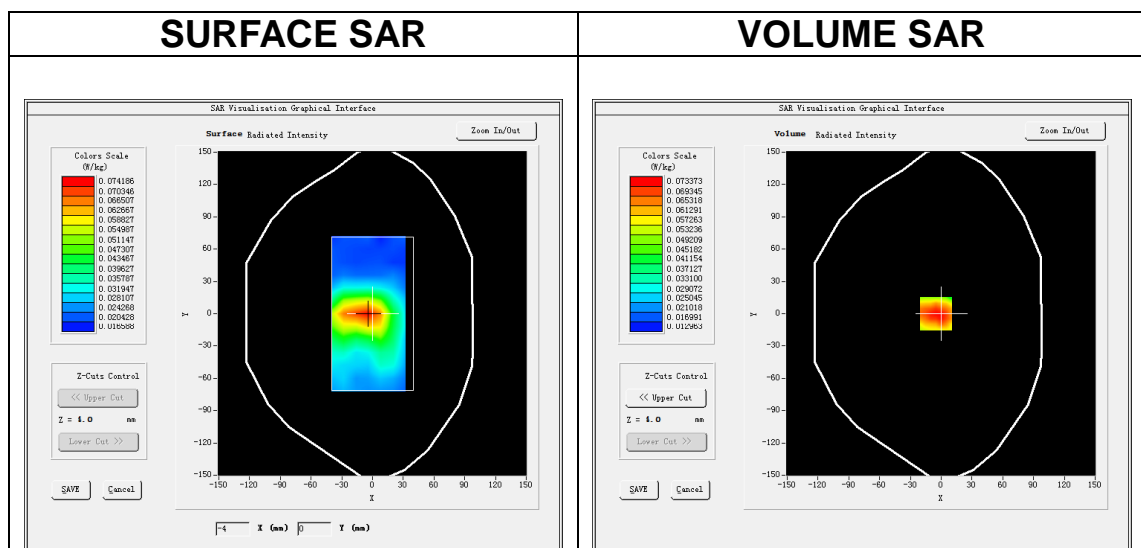

Maximum location: X=-5.00, Y=0.00

SAR Peak: 0.12 W/kg

SAR 10g (W/Kg)	0.047215
SAR 1g (W/Kg)	0.070186

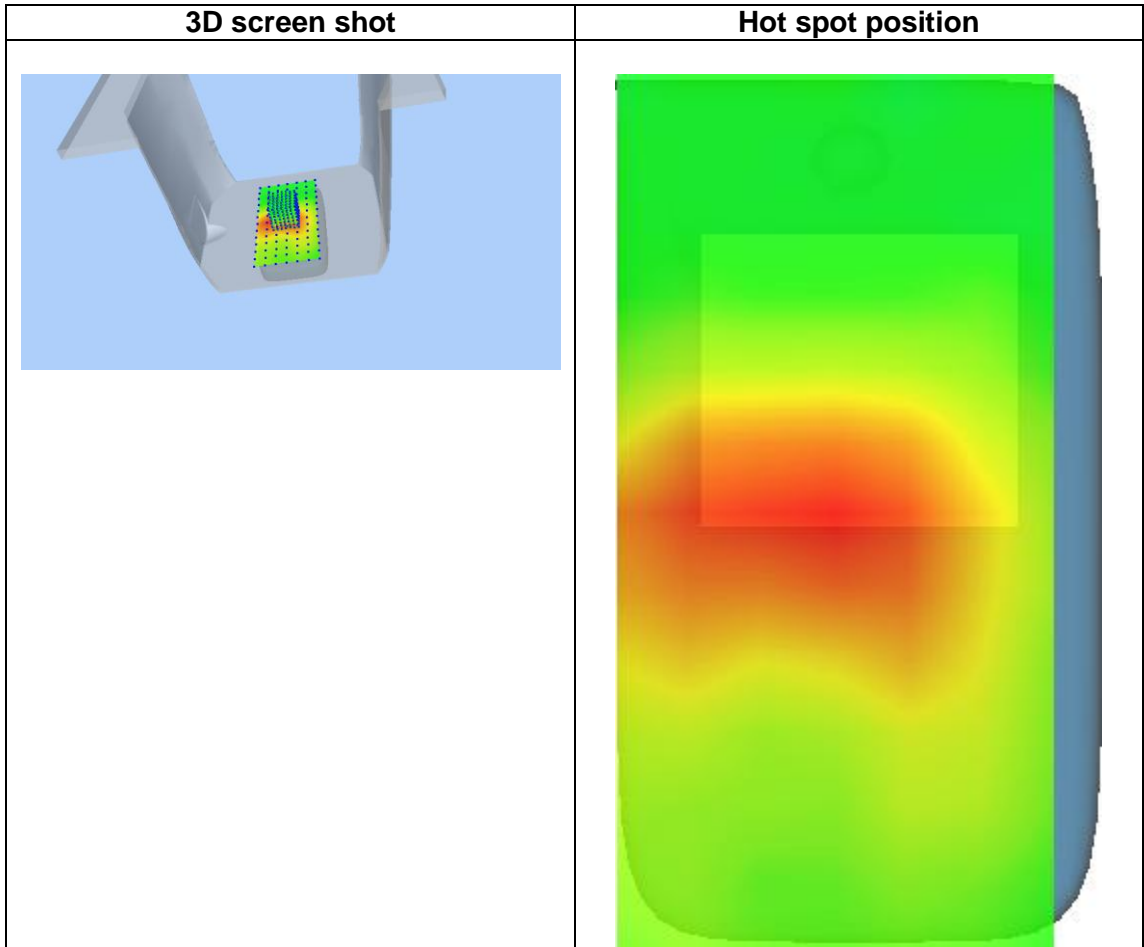
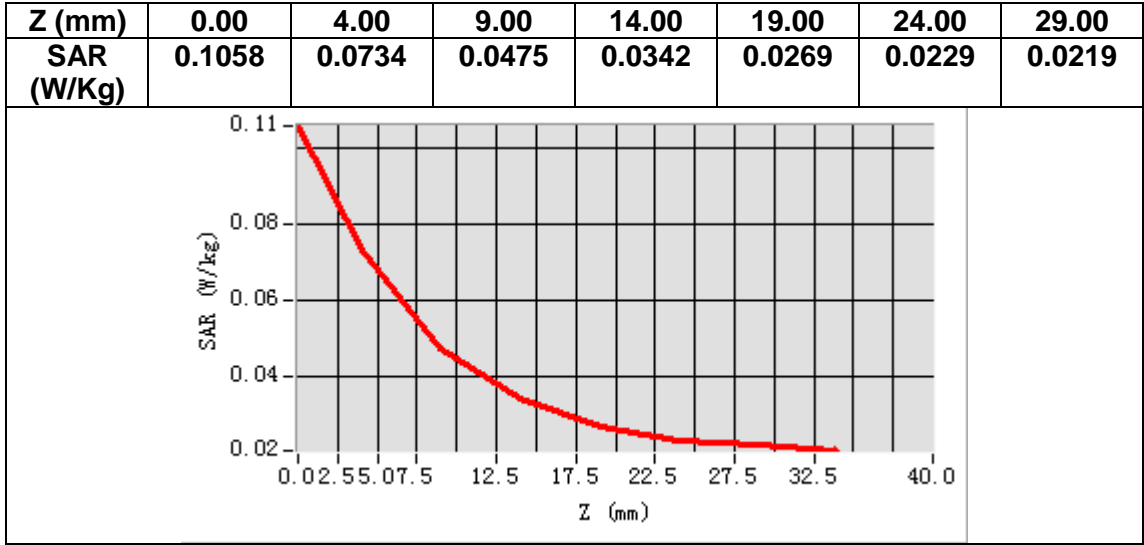

MEASUREMENT 17

Date of measurement: 3/2/2021

A. Experimental conditions.

Area Scan	<u>dx=15mm dy=15mm, h= 5.00 mm</u>
ZoomScan	<u>5x5x7, dx=8mm dy=8mm dz=5mm</u>
Phantom	<u>Left head</u>
Device Position	<u>Cheek</u>
Band	<u>LTE band 2</u>
Channels	<u>Middle</u>
Signal	<u>LTE (Crest factor: 1.0)</u>

B. SAR Measurement Results

Frequency (MHz)	1880.000000
Relative permittivity (real part)	39.868156
Relative permittivity (imaginary part)	13.057934
Conductivity (S/m)	1.363829
Variation (%)	-4.130000

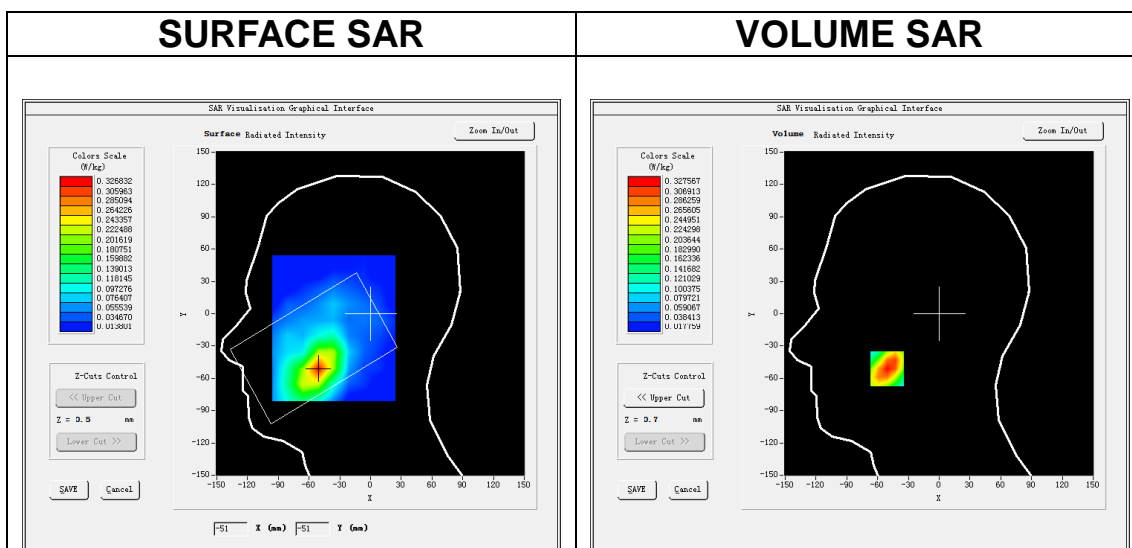

Maximum location: X=-51.00, Y=-51.00
SAR Peak: 0.48 W/kg

SAR 10g (W/Kg)	0.182187
SAR 1g (W/Kg)	0.311892

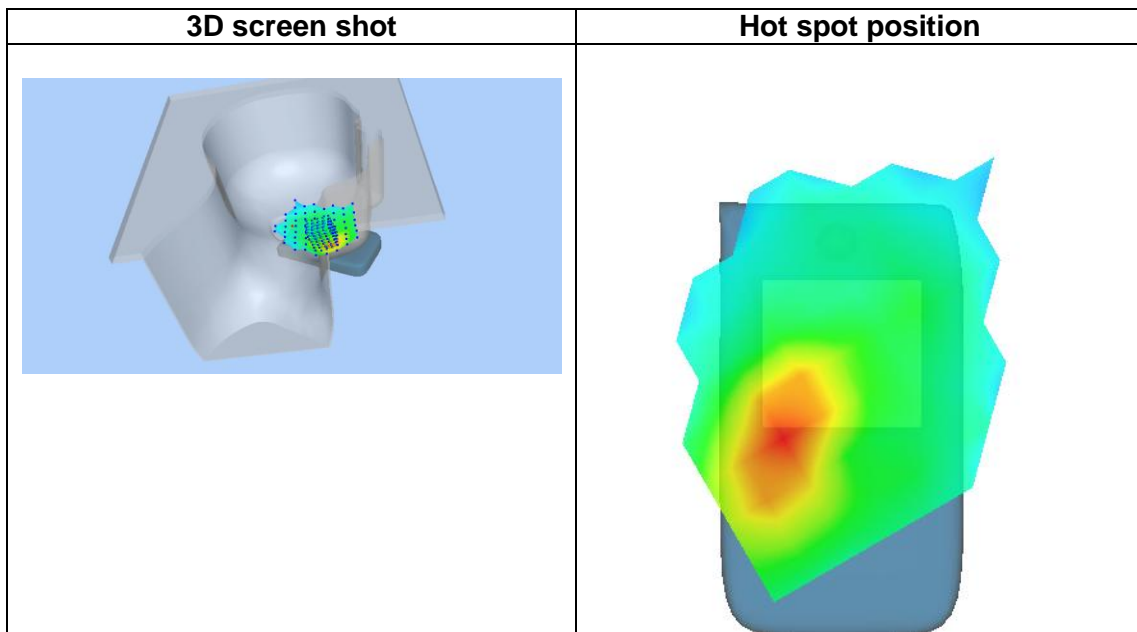
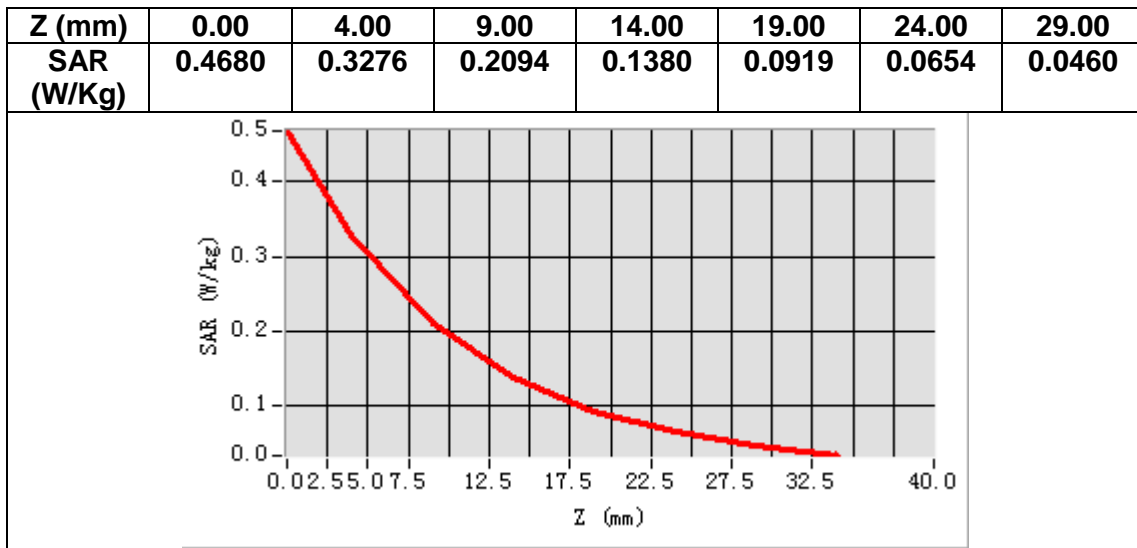

MEASUREMENT 18

Date of measurement: 3/2/2021

A. Experimental conditions.

Area Scan	<u>dx=15mm dy=15mm, h= 5.00 mm</u>
ZoomScan	<u>5x5x7, dx=8mm dy=8mm dz=5mm</u>
Phantom	<u>Validation plane</u>
Device Position	<u>Body</u>
Band	<u>LTE band 2</u>
Channels	<u>Middle</u>
Signal	<u>LTE (Crest factor: 1.0)</u>

B. SAR Measurement Results

Frequency (MHz)	1880.000000
Relative permittivity (real part)	39.868156
Relative permittivity (imaginary part)	13.057934
Conductivity (S/m)	1.363829
Variation (%)	-0.140000

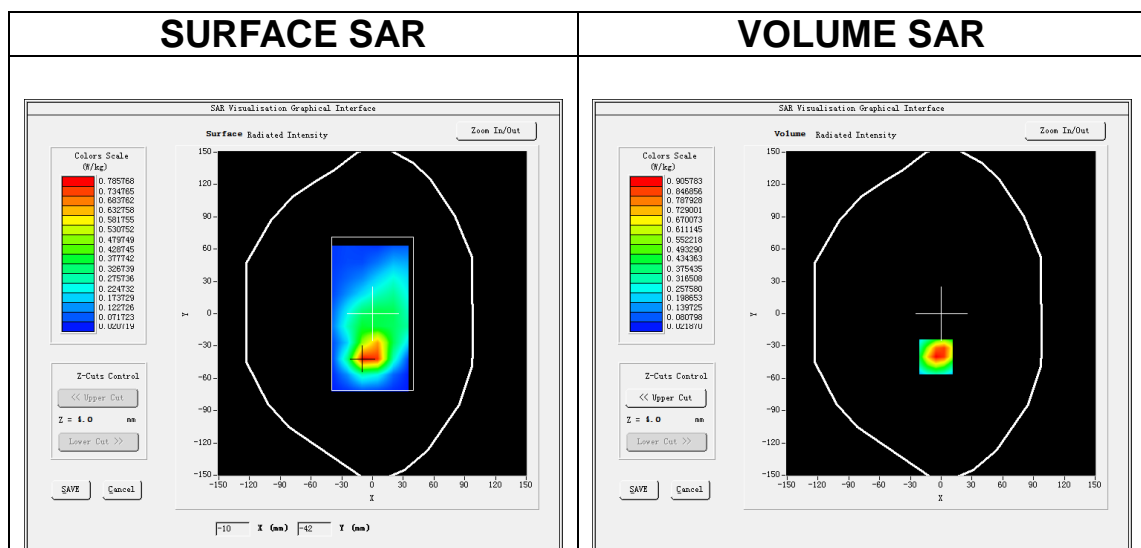

Maximum location: X=-5.00, Y=-40.00

SAR Peak: 1.49 W/kg

SAR 10g (W/Kg)	0.450984
SAR 1g (W/Kg)	0.876631

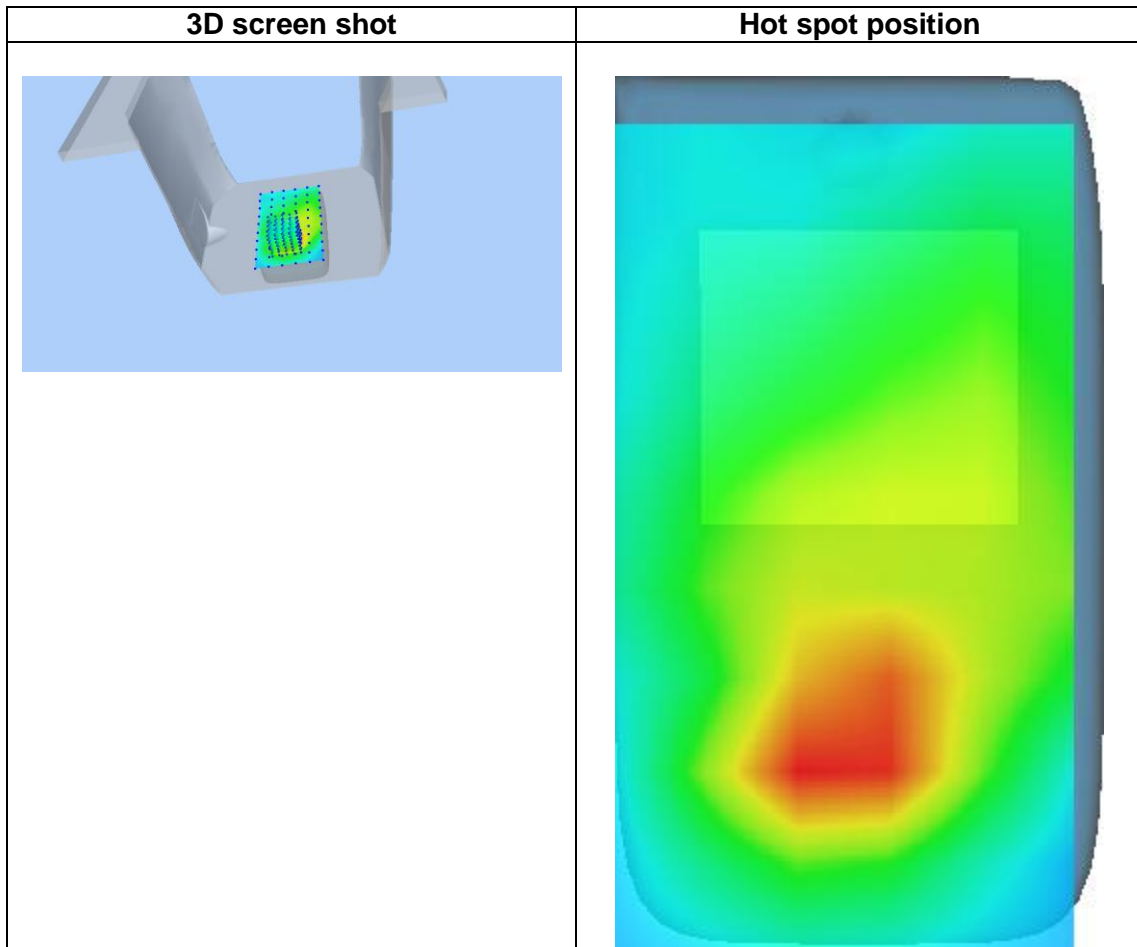
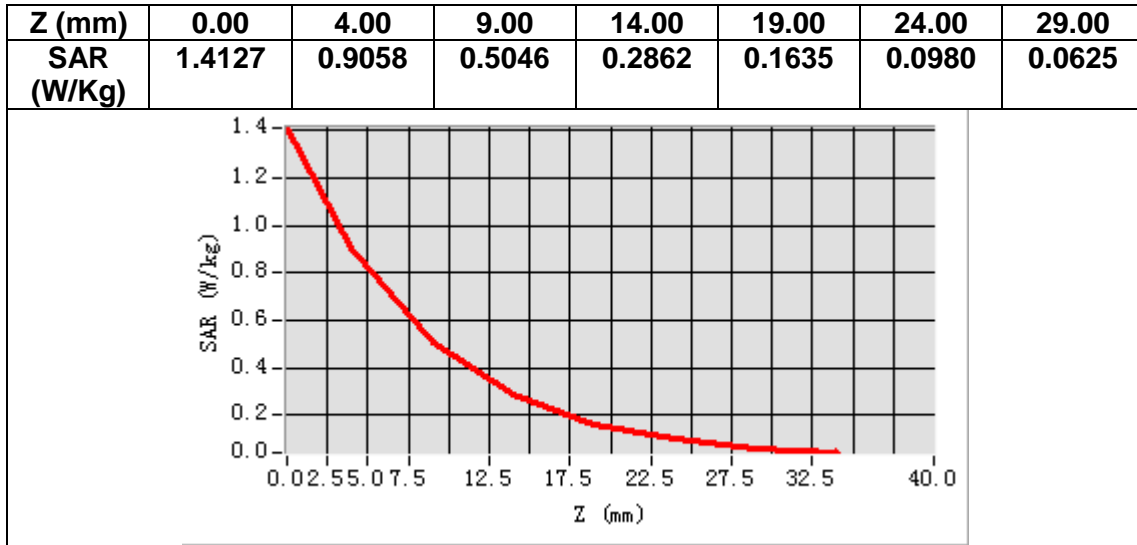

MEASUREMENT 19

Date of measurement: 26/2/2021

A. Experimental conditions.

<u>Area Scan</u>	<u>dx=15mm dy=15mm, h= 5.00 mm</u>
<u>ZoomScan</u>	<u>5x5x7, dx=8mm dy=8mm dz=5mm</u>
<u>Phantom</u>	<u>Left head</u>
<u>Device Position</u>	<u>Cheek</u>
<u>Band</u>	<u>LTE band 4</u>
<u>Channels</u>	<u>Middle</u>
<u>Signal</u>	<u>LTE (Crest factor: 1.0)</u>

B. SAR Measurement Results

Frequency (MHz)	1732.500000
Relative permittivity (real part)	40.208675
Relative permittivity (imaginary part)	13.926062
Conductivity (S/m)	1.340383
Variation (%)	-2.880000

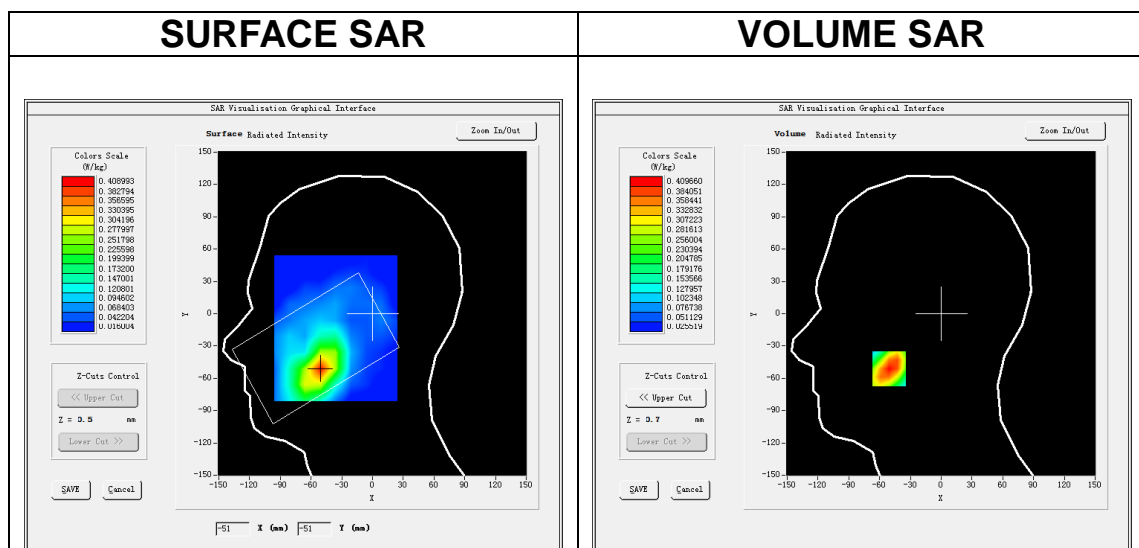

Maximum location: X=-51.00, Y=-51.00

SAR Peak: 0.58 W/kg

SAR 10g (W/Kg)	0.237235
SAR 1g (W/Kg)	0.390445

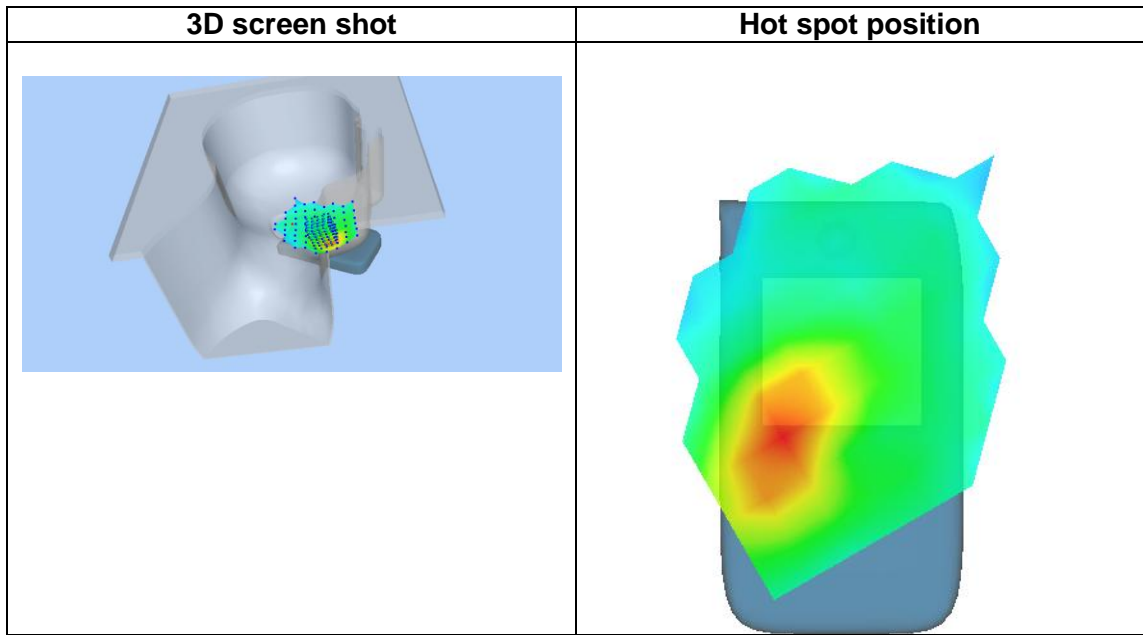
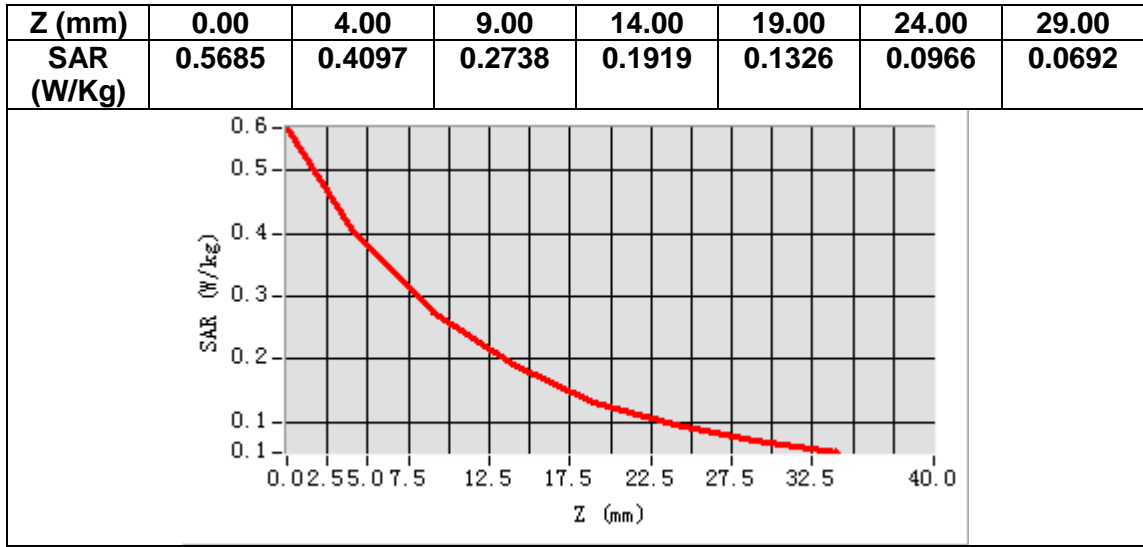

MEASUREMENT 20

Date of measurement: 26/2/2021

A. Experimental conditions.

Area Scan	<u>dx=15mm dy=15mm, h= 5.00 mm</u>
ZoomScan	<u>5x5x7, dx=8mm dy=8mm dz=5mm</u>
Phantom	<u>Validation plane</u>
Device Position	<u>Body</u>
Band	<u>LTE band 4</u>
Channels	<u>Middle</u>
Signal	<u>LTE (Crest factor: 1.0)</u>

B. SAR Measurement Results

Frequency (MHz)	1732.500000
Relative permittivity (real part)	40.208675
Relative permittivity (imaginary part)	13.926062
Conductivity (S/m)	1.340383
Variation (%)	-2.360000

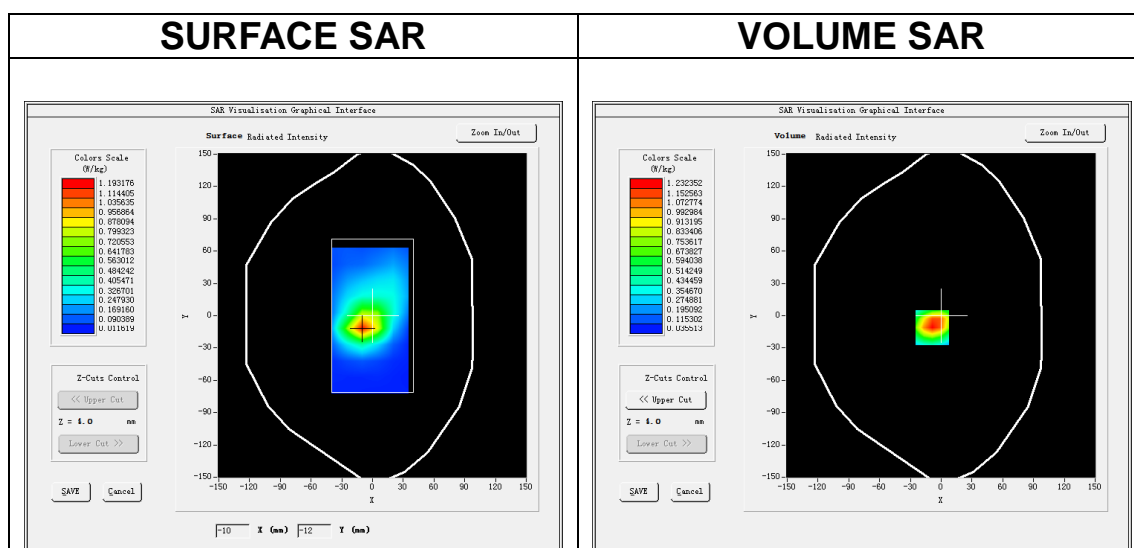

Maximum location: X=-9.00, Y=-11.00

SAR Peak: 1.96 W/kg

SAR 10g (W/Kg)	0.604562
SAR 1g (W/Kg)	1.138170

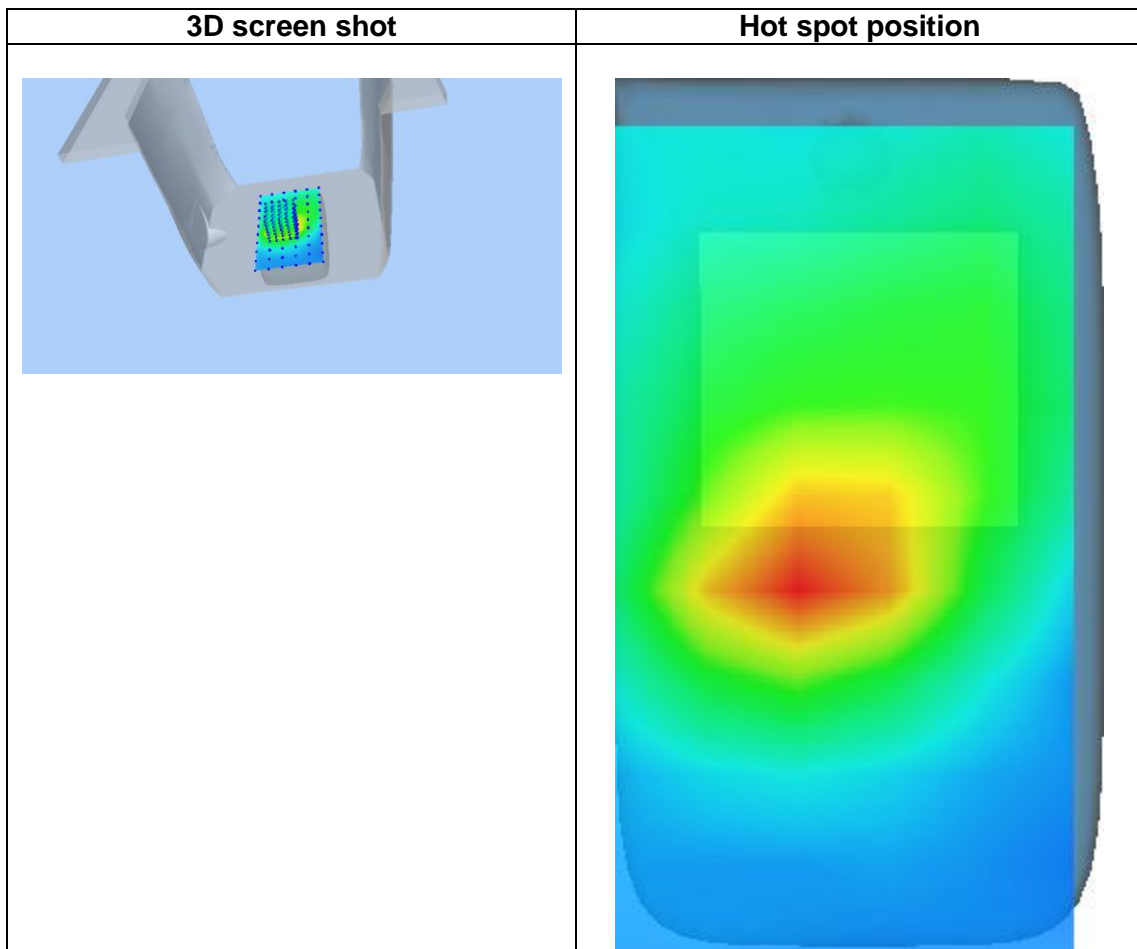
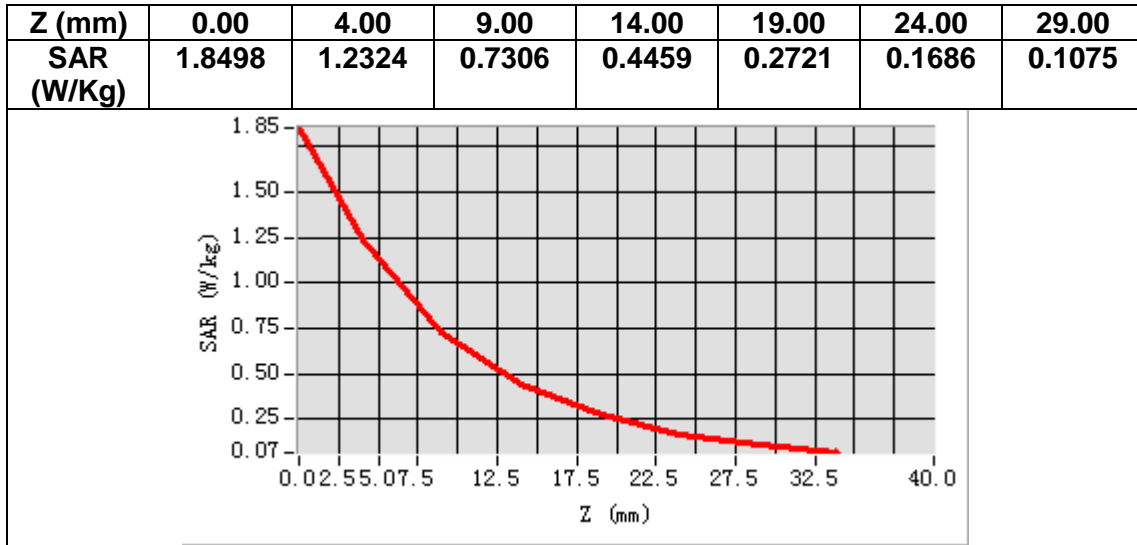

MEASUREMENT 21

Date of measurement: 2/2/2021

A. Experimental conditions.

Area Scan	<u>dx=15mm dy=15mm, h= 5.00 mm</u>
ZoomScan	<u>5x5x7, dx=8mm dy=8mm dz=5mm</u>
Phantom	<u>Left head</u>
Device Position	<u>Cheek</u>
Band	<u>LTE band 5</u>
Channels	<u>Middle</u>
Signal	<u>LTE (Crest factor: 1.0)</u>

B. SAR Measurement Results

Frequency (MHz)	836.500000
Relative permittivity (real part)	41.879166
Relative permittivity (imaginary part)	19.523405
Conductivity (S/m)	0.907296
Variation (%)	-2.090000

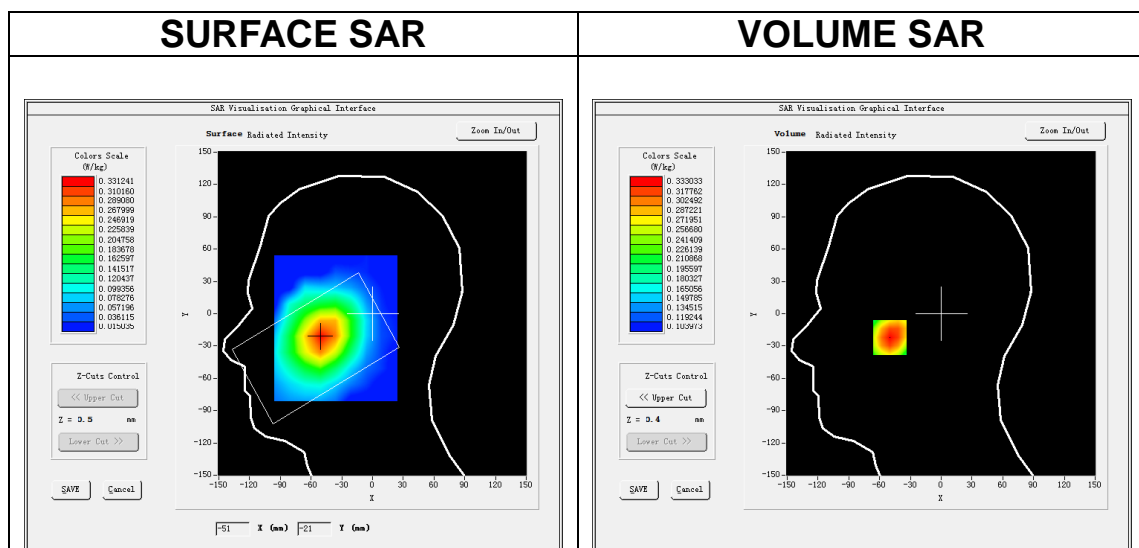

Maximum location: X=-50.00, Y=-22.00

SAR Peak: 0.36 W/kg

SAR 10g (W/Kg)	0.283528
SAR 1g (W/Kg)	0.328924

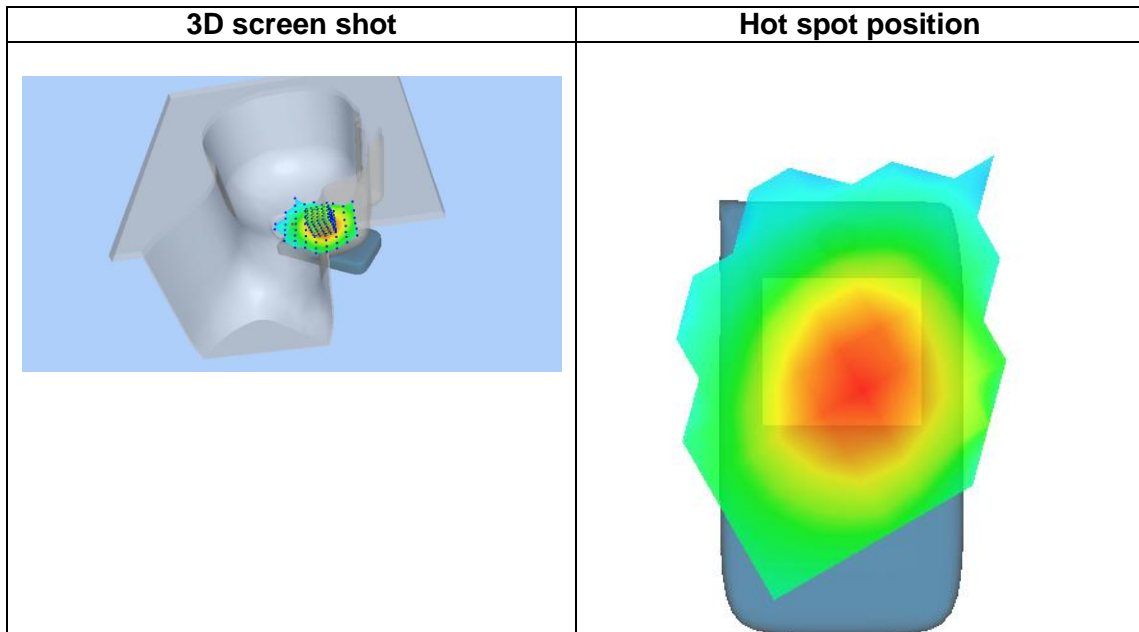
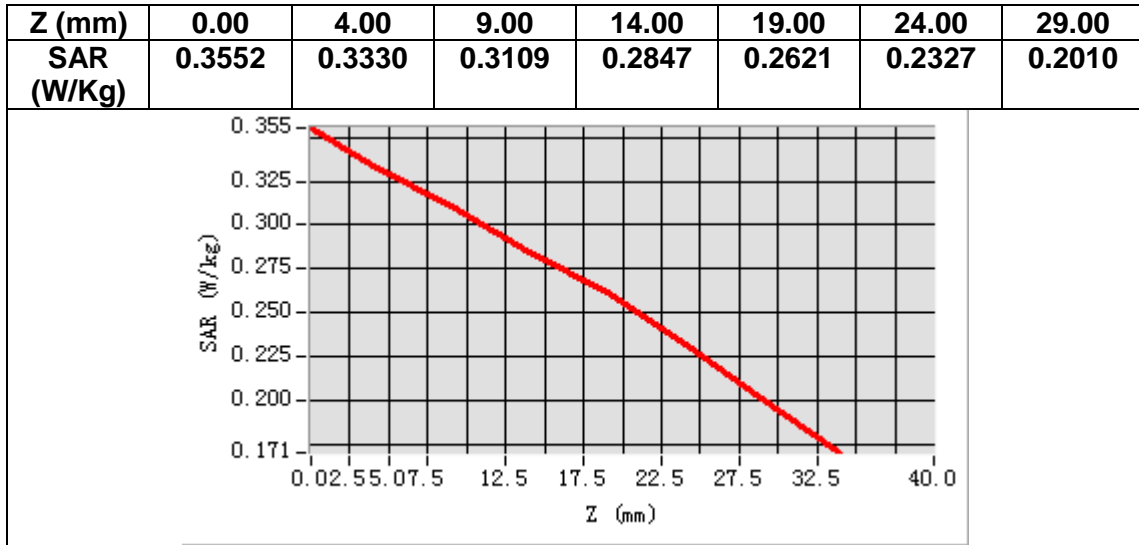

MEASUREMENT 22

Date of measurement: 2/2/2021

A. Experimental conditions.

Area Scan	<u>dx=15mm dy=15mm, h= 5.00 mm</u>
ZoomScan	<u>5x5x7, dx=8mm dy=8mm dz=5mm</u>
Phantom	<u>Validation plane</u>
Device Position	<u>Body</u>
Band	<u>LTE band 5</u>
Channels	<u>Middle</u>
Signal	<u>LTE (Crest factor: 1.0)</u>

B. SAR Measurement Results

Frequency (MHz)	836.500000
Relative permittivity (real part)	41.879166
Relative permittivity (imaginary part)	19.523405
Conductivity (S/m)	0.907296
Variation (%)	-1.350000

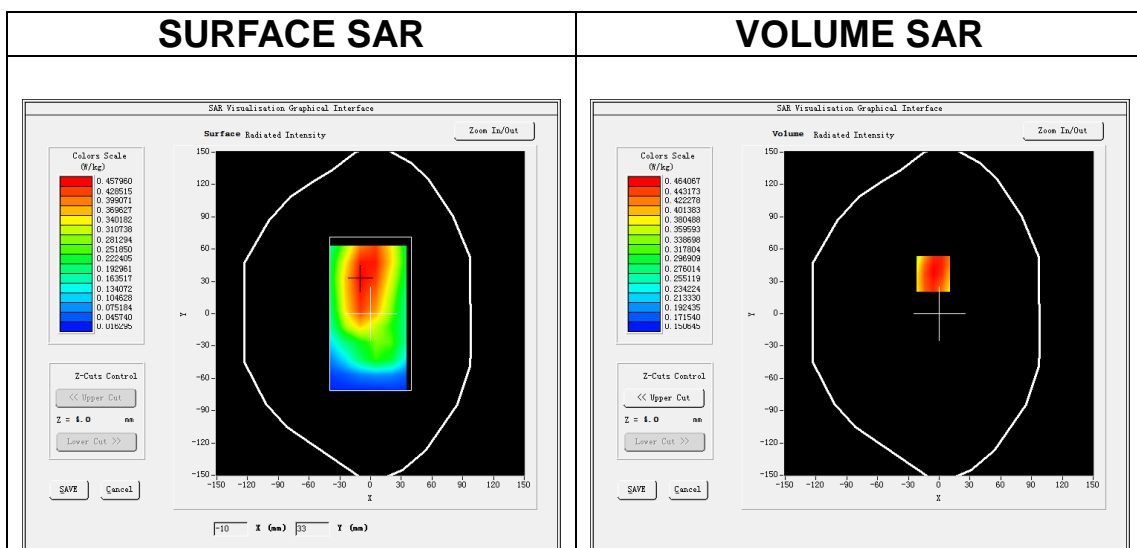

Maximum location: X=-6.00, Y=37.00

SAR Peak: 0.53 W/kg

SAR 10g (W/Kg)	0.385850
SAR 1g (W/Kg)	0.458959

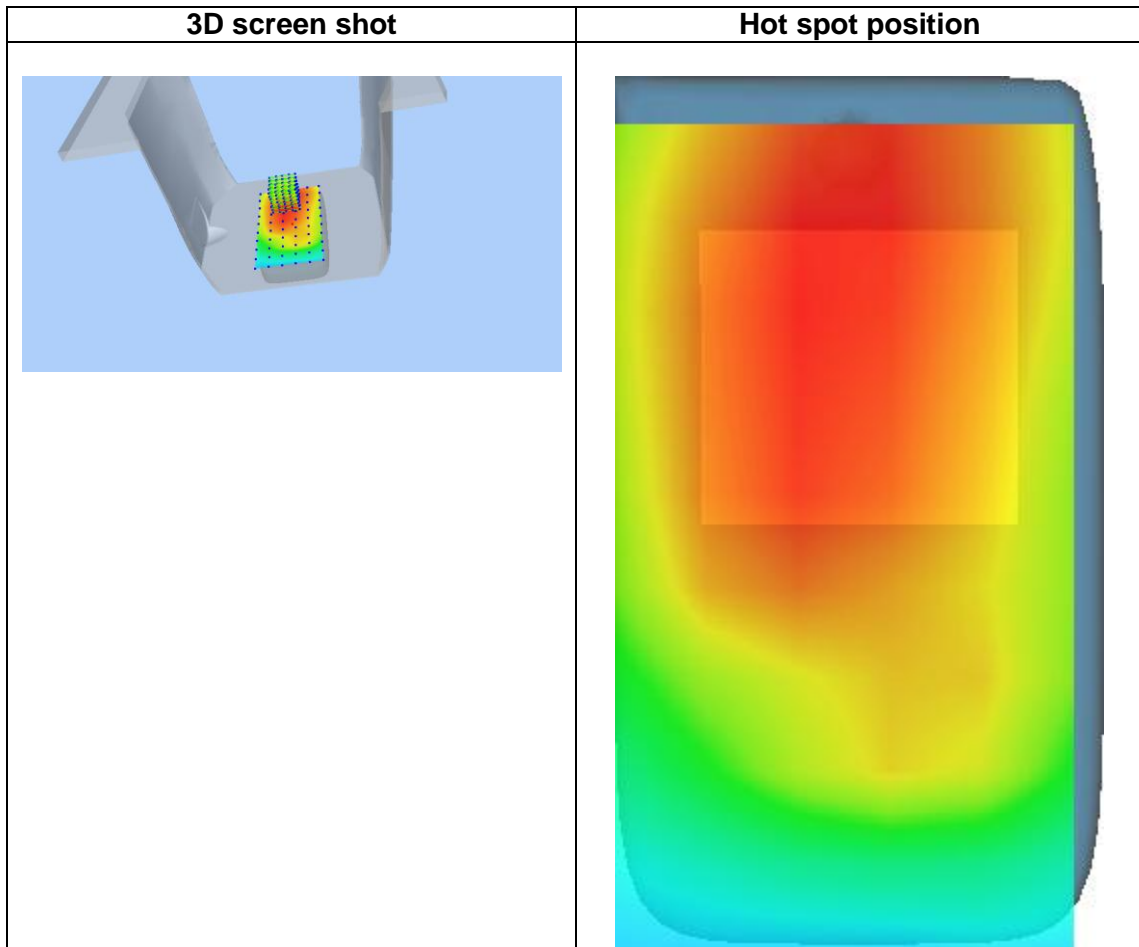
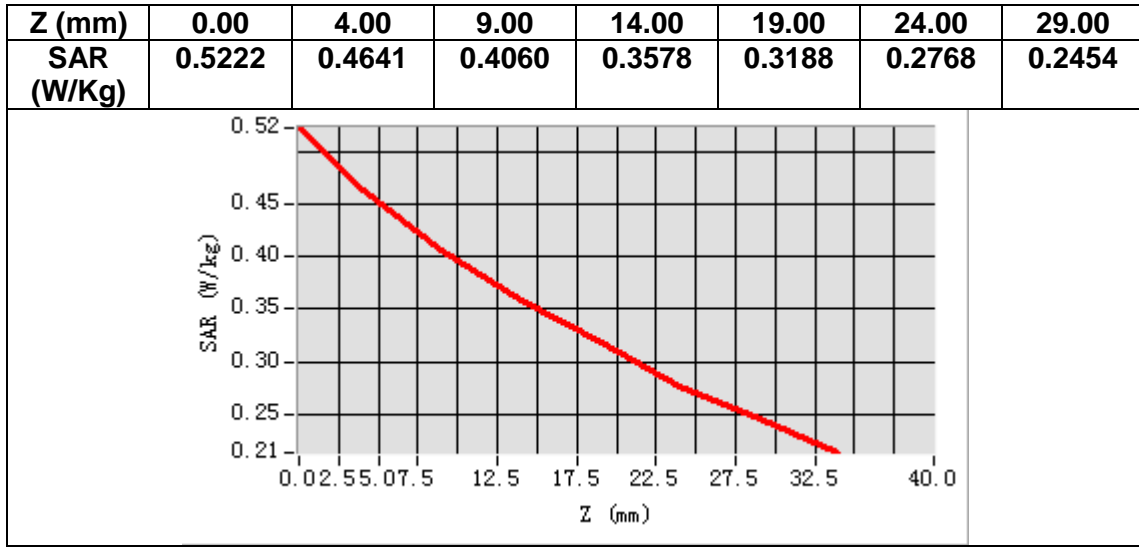

MEASUREMENT 23

Date of measurement: 3/2/2021

A. Experimental conditions.

Area Scan	<u>dx=12mm dy=12mm, h= 5.00 mm</u>
ZoomScan	<u>7x7x7, dx=5mm dy=5mm dz=5mm</u>
Phantom	<u>Left head</u>
Device Position	<u>Cheek</u>
Band	<u>LTE band 7</u>
Channels	<u>Middle</u>
Signal	<u>LTE (Crest factor: 1.0)</u>

B. SAR Measurement Results

Frequency (MHz)	2535.000000
Relative permittivity (real part)	39.427166
Relative permittivity (imaginary part)	13.678030
Conductivity (S/m)	1.926323
Variation (%)	1.260000

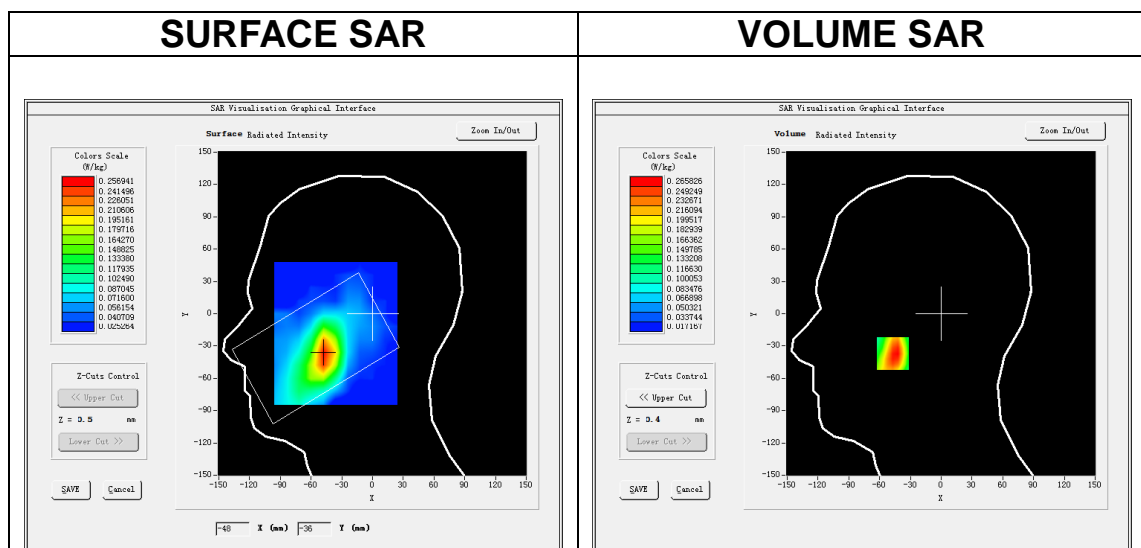

Maximum location: X=-47.00, Y=-37.00

SAR Peak: 0.40 W/kg

SAR 10g (W/Kg)	0.144937
SAR 1g (W/Kg)	0.252927

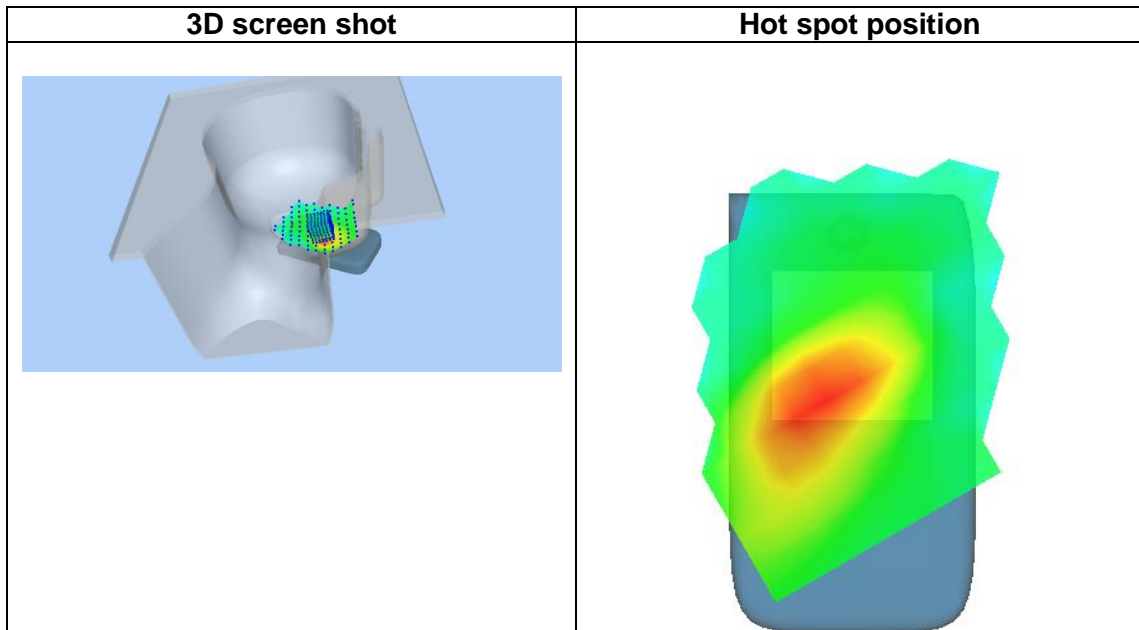
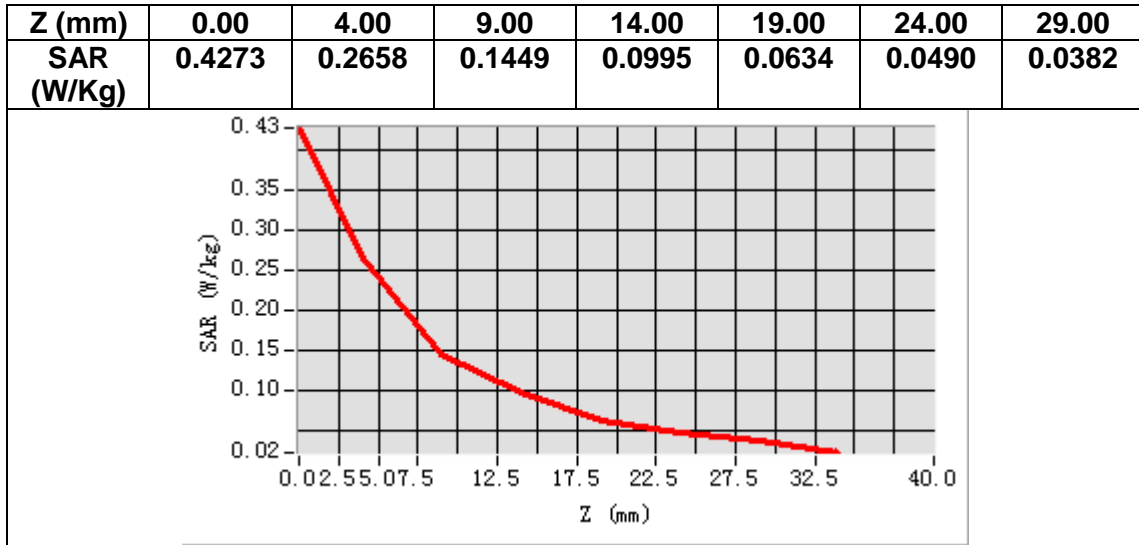

MEASUREMENT 24

Date of measurement: 3/2/2021

A. Experimental conditions.

Area Scan	<u>dx=12mm dy=12mm, h= 5.00 mm</u>
ZoomScan	<u>7x7x7, dx=5mm dy=5mm dz=5mm</u>
Phantom	<u>Validation plane</u>
Device Position	<u>Body</u>
Band	<u>LTE band 7</u>
Channels	<u>Low</u>
Signal	<u>LTE (Crest factor: 1.0)</u>

B. SAR Measurement Results

Frequency (MHz)	2510.000000
Relative permittivity (real part)	39.542267
Relative permittivity (imaginary part)	13.620730
Conductivity (S/m)	1.899335
Variation (%)	-1.510000

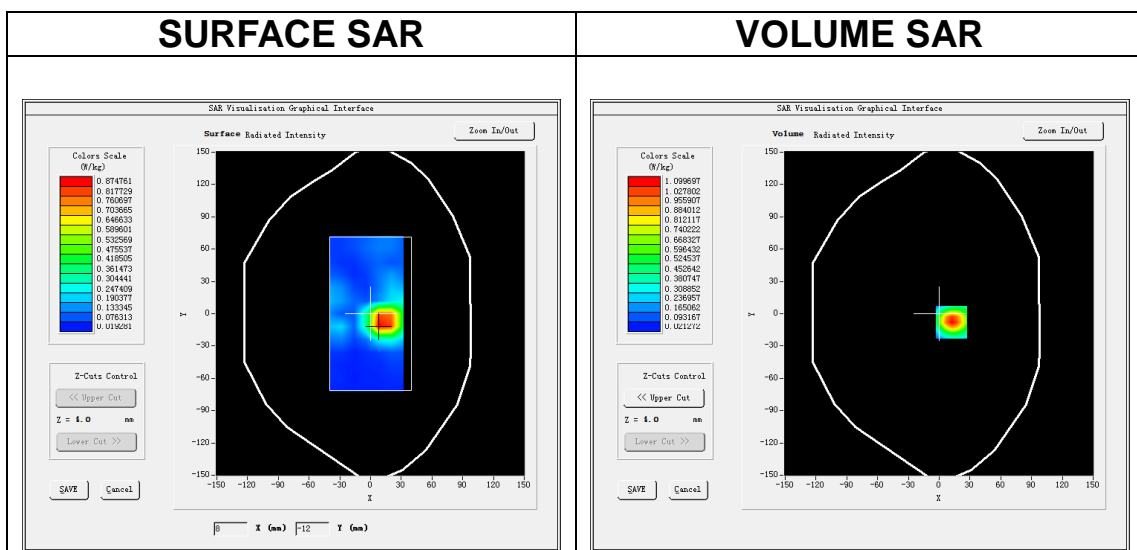

Maximum location: X=12.00, Y=-8.00

SAR Peak: 1.88 W/kg

SAR 10g (W/Kg)	0.461671
SAR 1g (W/Kg)	1.020611

Z (mm)	0.00	4.00	9.00	14.00	19.00	24.00	29.00
SAR (W/Kg)	1.8669	1.0997	0.5287	0.2541	0.1242	0.0695	0.0479

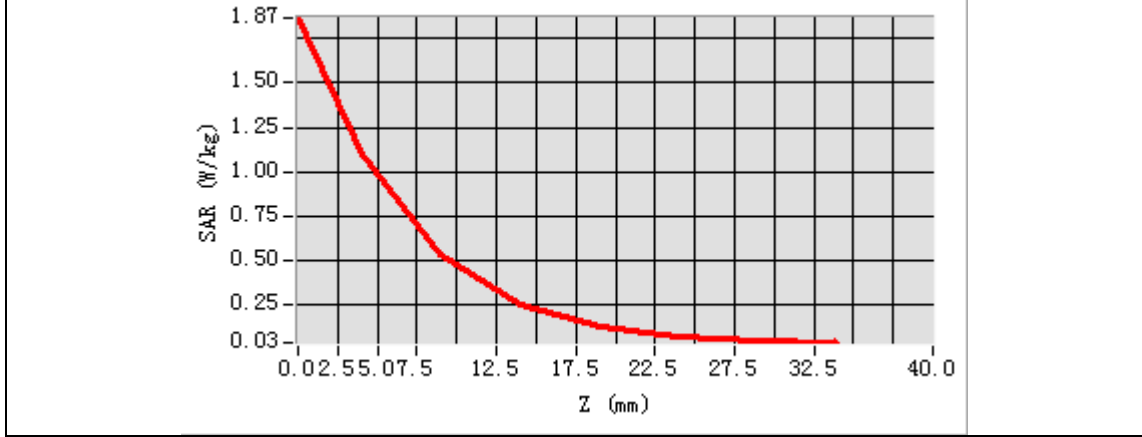

3D screen shot	Hot spot position

MEASUREMENT 25

Date of measurement: 20/2/2021

A. Experimental conditions.

Area Scan	<u>dx=15mm dy=15mm, h= 5.00 mm</u>
ZoomScan	<u>5x5x7, dx=8mm dy=8mm dz=5mm</u>
Phantom	<u>Left head</u>
Device Position	<u>Cheek</u>
Band	<u>LTE band 12</u>
Channels	<u>Middle</u>
Signal	<u>LTE (Crest factor: 1.0)</u>

B. SAR Measurement Results

Frequency (MHz)	707.500000
Relative permittivity (real part)	42.927418
Relative permittivity (imaginary part)	21.680969
Conductivity (S/m)	0.852183
Variation (%)	-3.360000

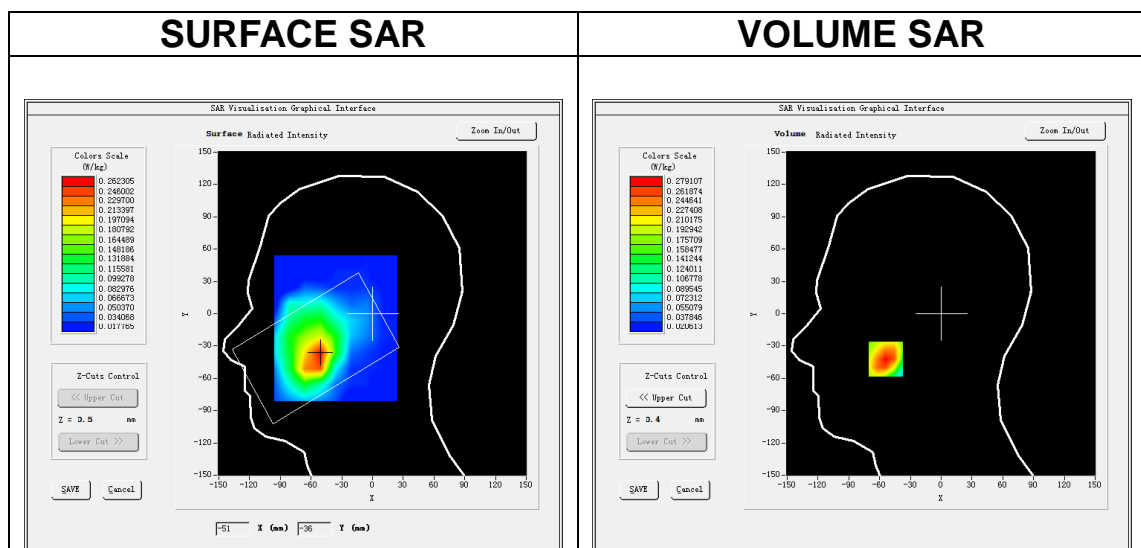

Maximum location: X=-54.00, Y=-42.00

SAR Peak: 0.38 W/kg

SAR 10g (W/Kg)	0.173348
SAR 1g (W/Kg)	0.267777

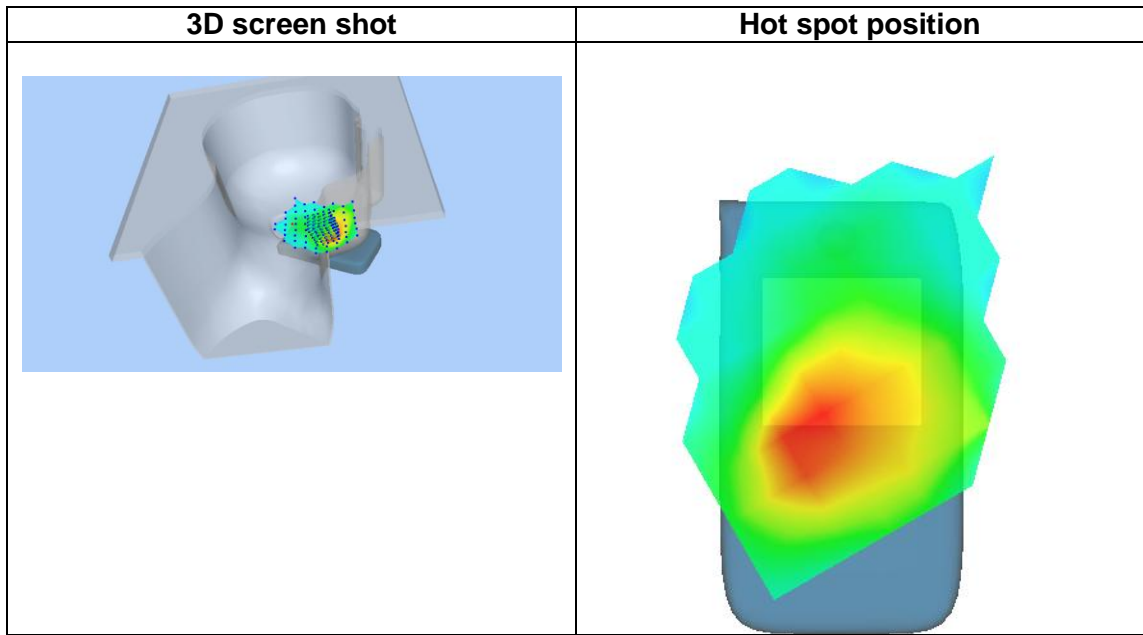
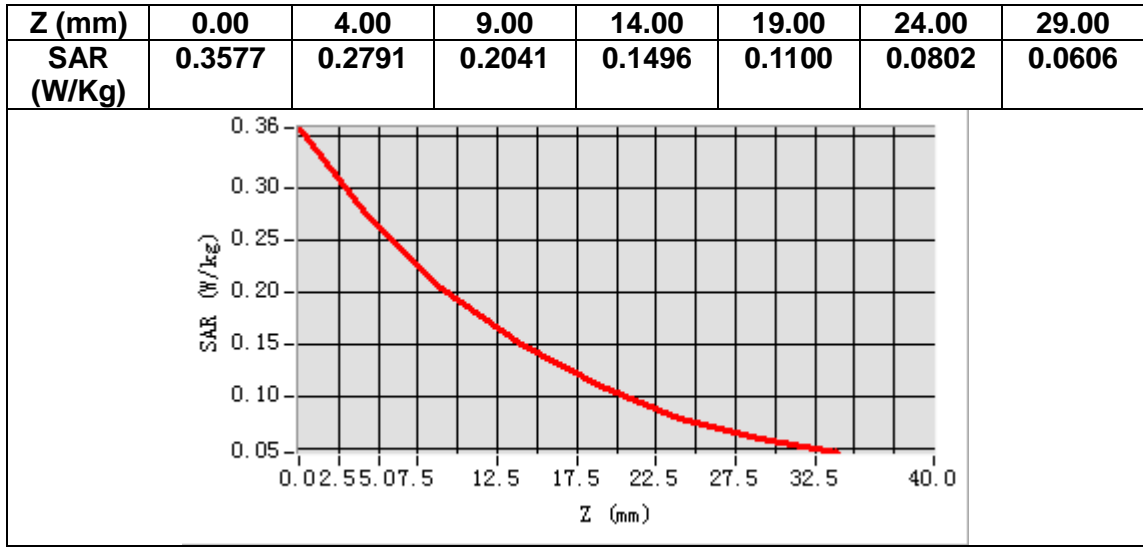

MEASUREMENT 26

Date of measurement: 20/2/2021

A. Experimental conditions.

Area Scan	<u>dx=15mm dy=15mm, h= 5.00 mm</u>
ZoomScan	<u>5x5x7, dx=8mm dy=8mm dz=5mm</u>
Phantom	<u>Validation plane</u>
Device Position	<u>Body</u>
Band	<u>LTE band 12</u>
Channels	<u>Middle</u>
Signal	<u>LTE (Crest factor: 1.0)</u>

B. SAR Measurement Results

Frequency (MHz)	707.500000
Relative permittivity (real part)	42.927418
Relative permittivity (imaginary part)	21.680969
Conductivity (S/m)	0.852183
Variation (%)	-0.110000

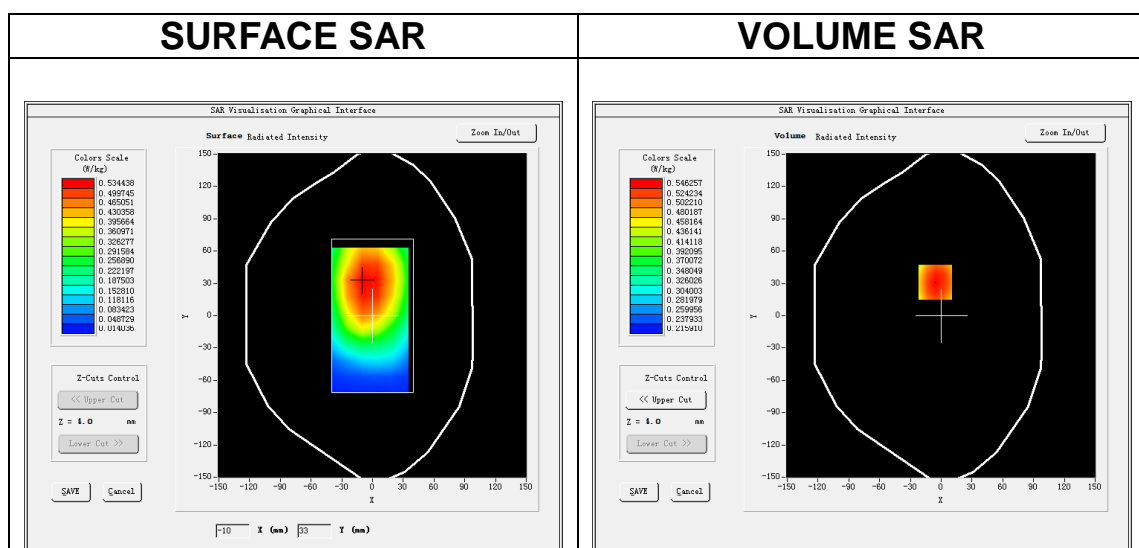

Maximum location: X=-6.00, Y=31.00

SAR Peak: 0.60 W/kg

SAR 10g (W/Kg)	0.458338
SAR 1g (W/Kg)	0.533763

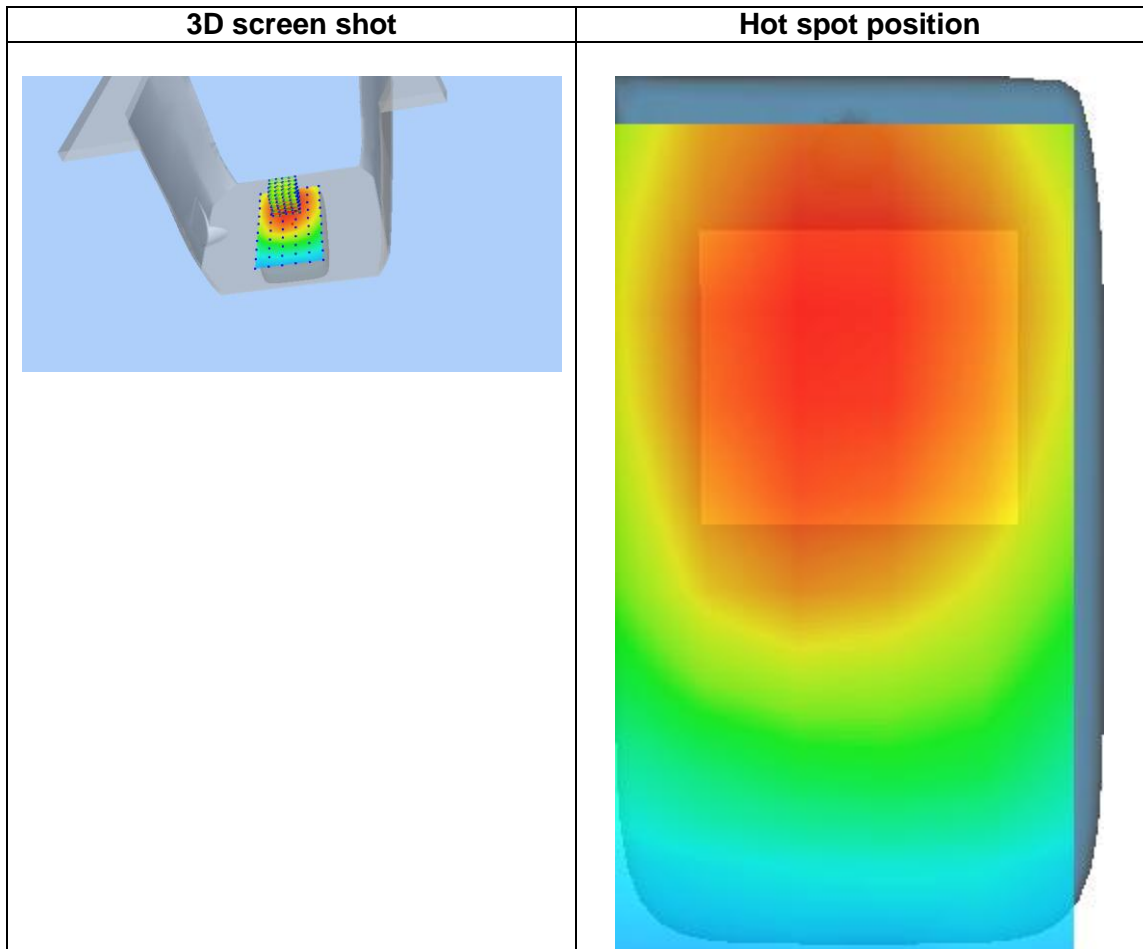
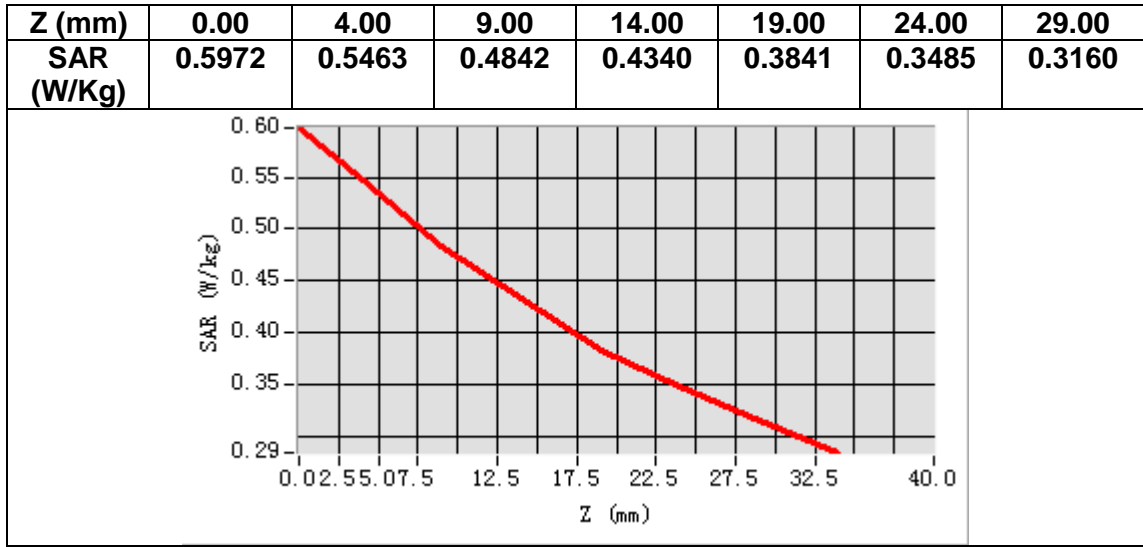

MEASUREMENT 27

Date of measurement: 20/2/2021

A. Experimental conditions.

Area Scan	<u>dx=15mm dy=15mm, h= 5.00 mm</u>
ZoomScan	<u>5x5x7, dx=8mm dy=8mm dz=5mm</u>
Phantom	<u>Left head</u>
Device Position	<u>Cheek</u>
Band	<u>LTE band 13</u>
Channels	<u>Middle</u>
Signal	<u>LTE (Crest factor: 1.0)</u>

B. SAR Measurement Results

Frequency (MHz)	782.000000
Relative permittivity (real part)	41.969368
Relative permittivity (imaginary part)	21.038170
Conductivity (S/m)	0.913407
Variation (%)	2.910000

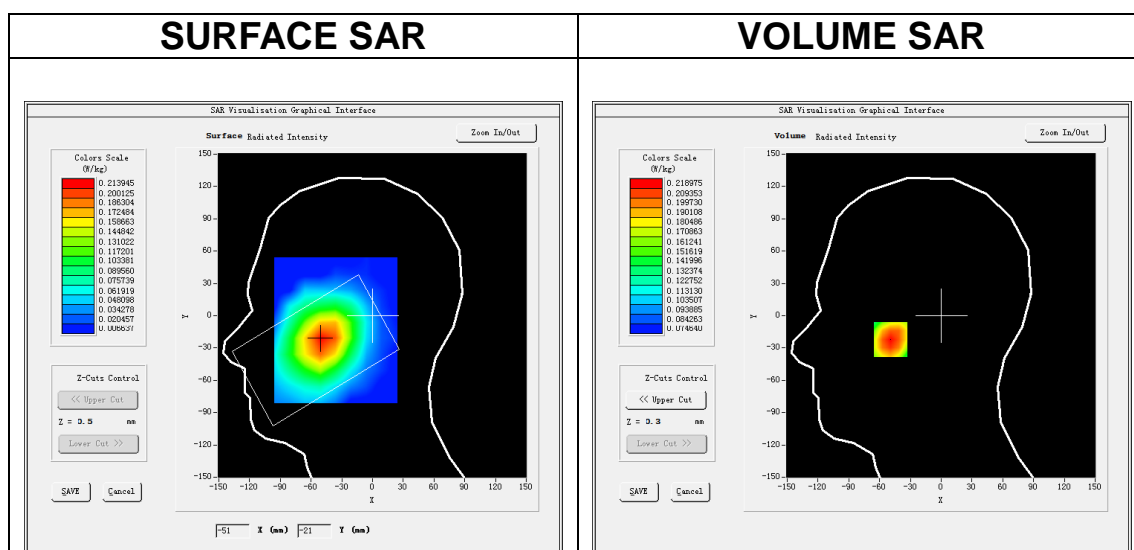

Maximum location: X=-49.00, Y=-22.00
SAR Peak: 0.23 W/kg

SAR 10g (W/Kg)	0.188248
SAR 1g (W/Kg)	0.218439

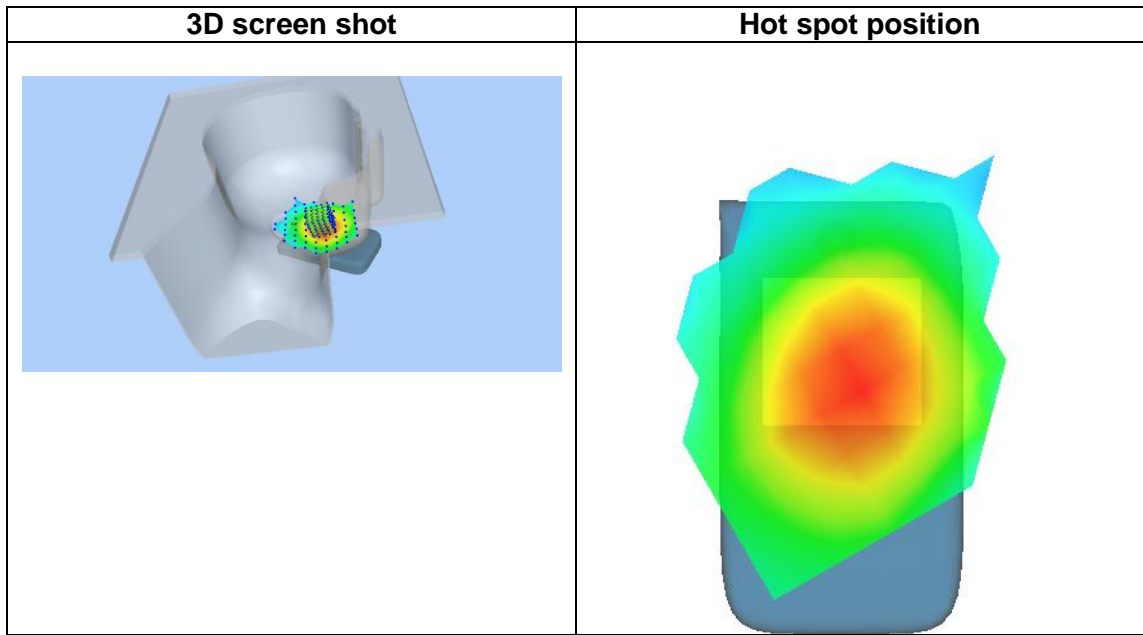
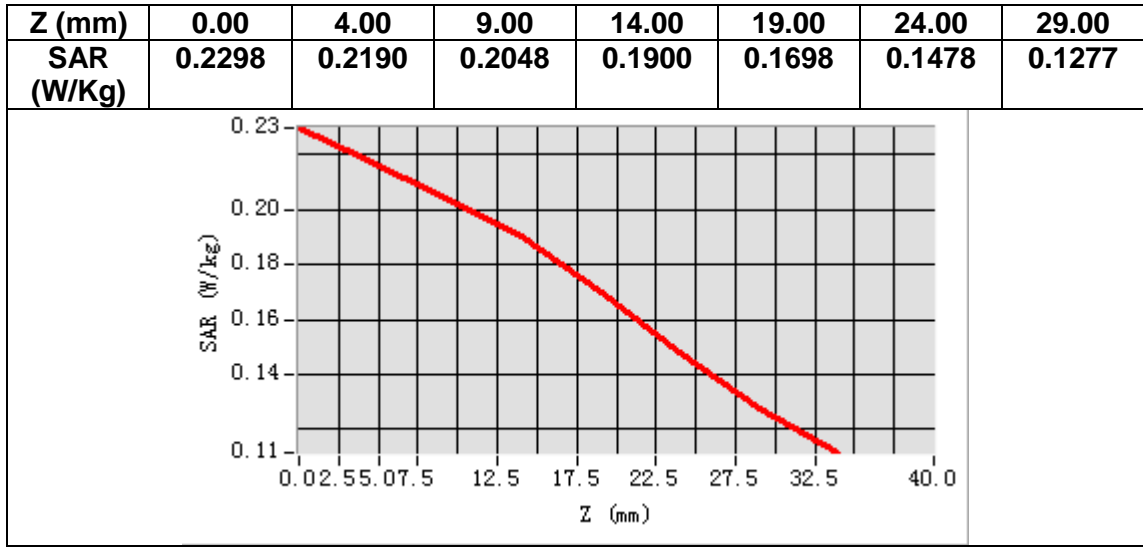

MEASUREMENT 28

Date of measurement: 20/2/2021

A. Experimental conditions.

Area Scan	<u>dx=15mm dy=15mm, h= 5.00 mm</u>
ZoomScan	<u>5x5x7, dx=8mm dy=8mm dz=5mm</u>
Phantom	<u>Validation plane</u>
Device Position	<u>Body</u>
Band	<u>LTE band 13</u>
Channels	<u>Middle</u>
Signal	<u>LTE (Crest factor: 1.0)</u>

B. SAR Measurement Results

Frequency (MHz)	782.000000
Relative permittivity (real part)	41.969368
Relative permittivity (imaginary part)	21.038170
Conductivity (S/m)	0.913407
Variation (%)	-1.360000

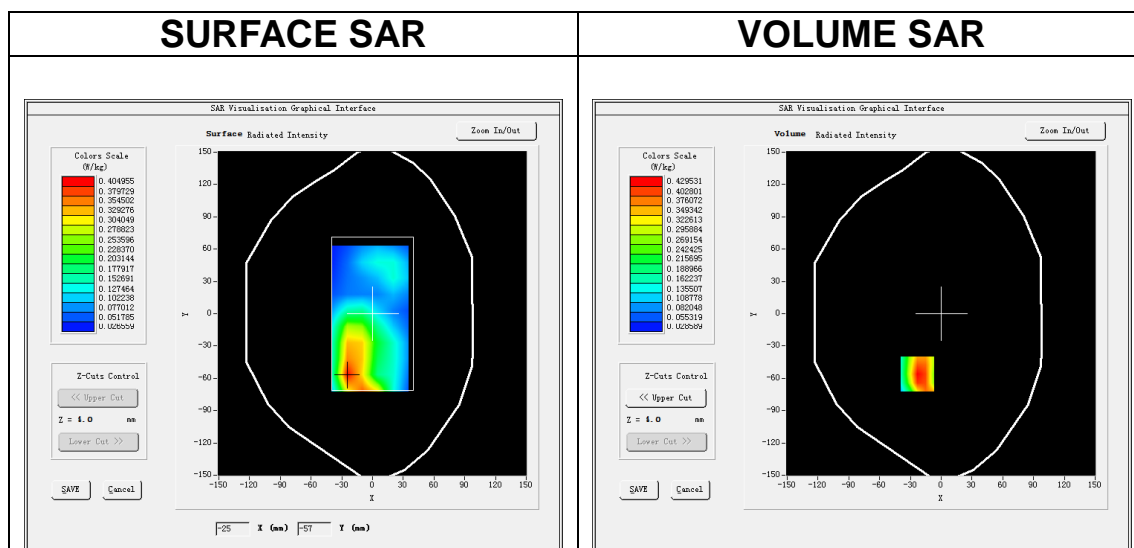

Maximum location: X=-23.00, Y=-56.00

SAR Peak: 0.67 W/kg

SAR 10g (W/Kg)	0.240867
SAR 1g (W/Kg)	0.424754

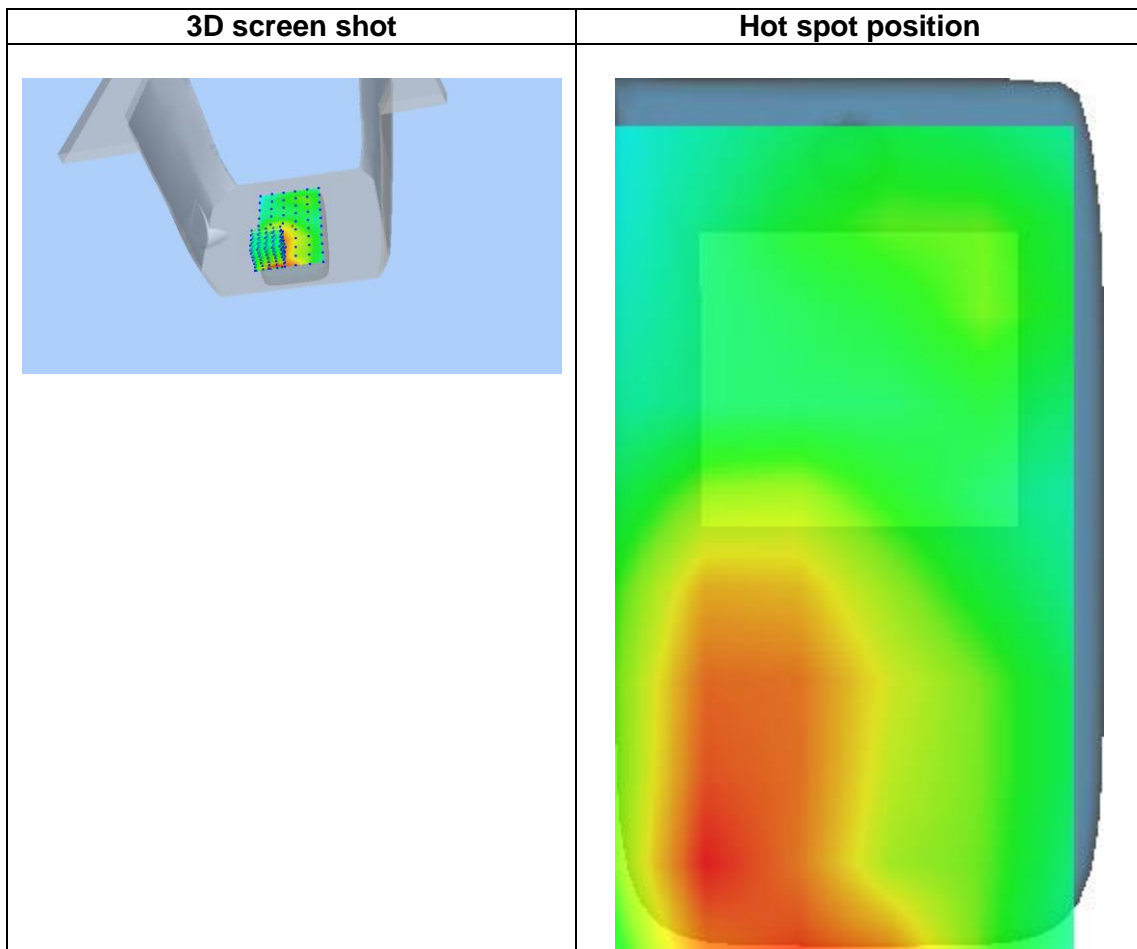
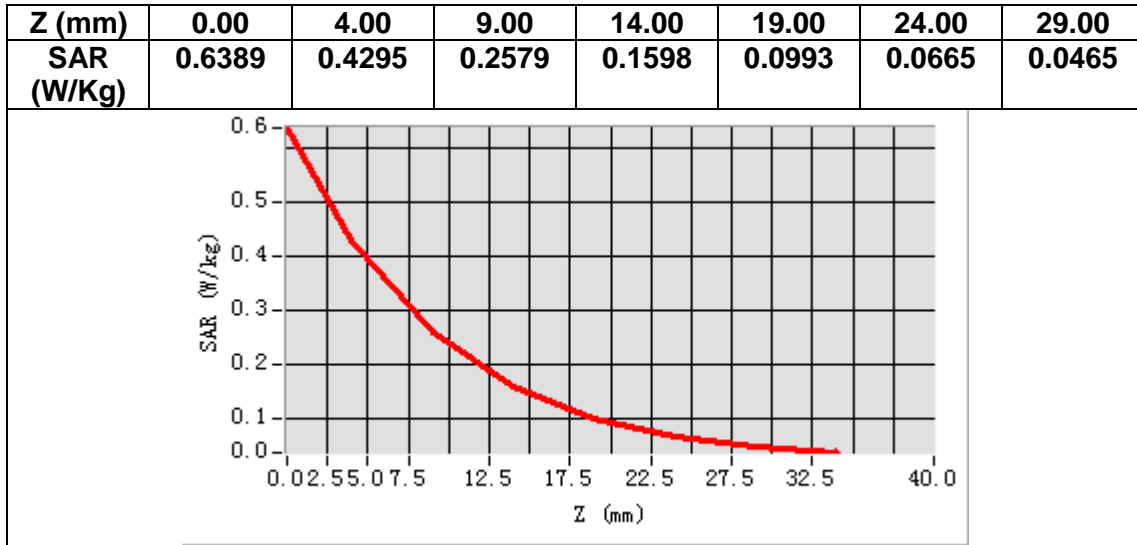

MEASUREMENT 29

Date of measurement: 20/2/2021

A. Experimental conditions.

Area Scan	<u>dx=15mm dy=15mm, h= 5.00 mm</u>
ZoomScan	<u>5x5x7, dx=8mm dy=8mm dz=5mm</u>
Phantom	<u>Left head</u>
Device Position	<u>Cheek</u>
Band	<u>LTE band 17</u>
Channels	<u>Middle</u>
Signal	<u>LTE (Crest factor: 1.0)</u>

B. SAR Measurement Results

Frequency (MHz)	710.000000
Relative permittivity (real part)	42.906170
Relative permittivity (imaginary part)	21.709370
Conductivity (S/m)	0.856314
Variation (%)	-0.230000

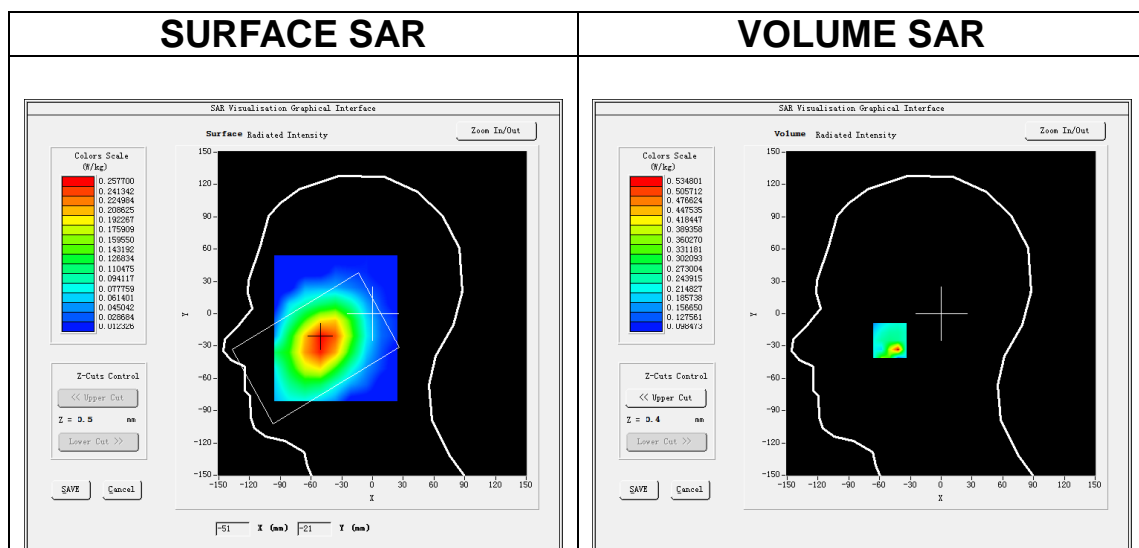

Maximum location: X=-50.00, Y=-25.00

SAR Peak: 1.11 W/kg

SAR 10g (W/Kg)	0.251786
SAR 1g (W/Kg)	0.462215

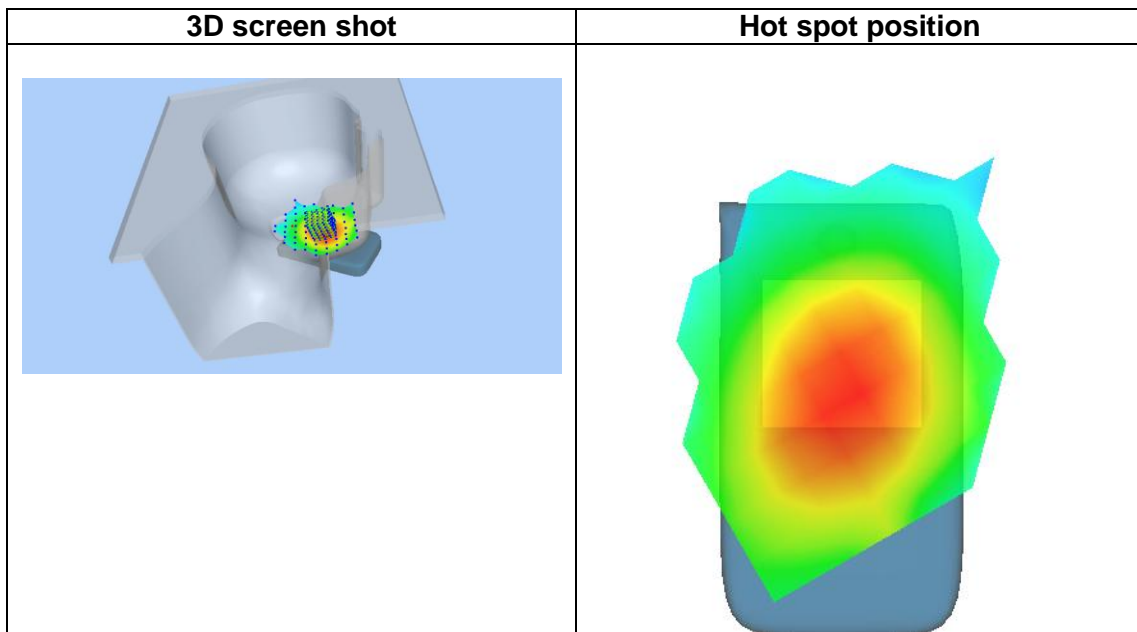
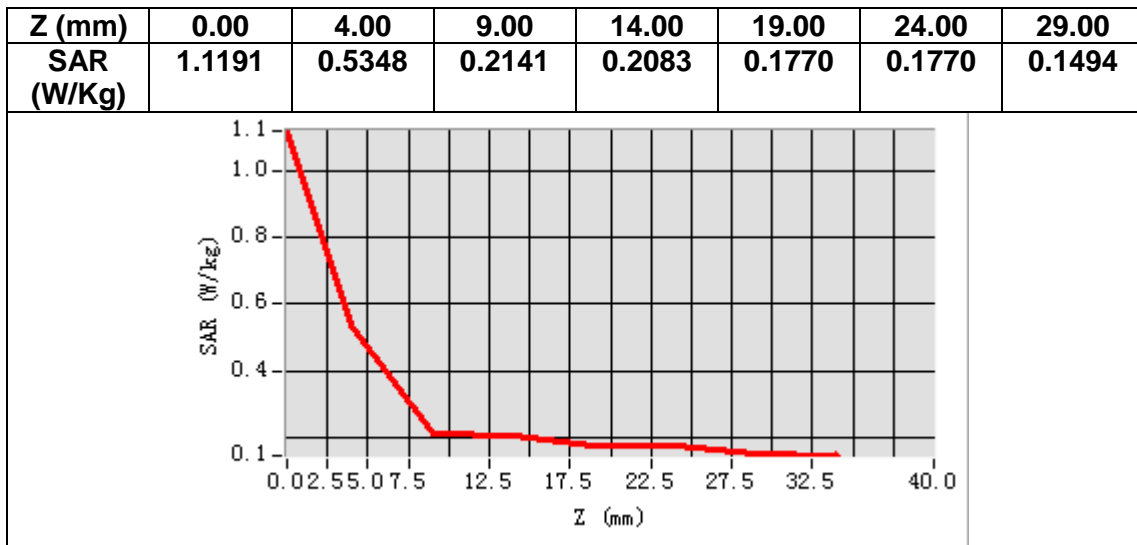

MEASUREMENT 30

Date of measurement: 20/2/2021

A. Experimental conditions.

Area Scan	<u>dx=15mm dy=15mm, h= 5.00 mm</u>
ZoomScan	<u>5x5x7, dx=8mm dy=8mm dz=5mm</u>
Phantom	<u>Validation plane</u>
Device Position	<u>Body</u>
Band	<u>LTE band 17</u>
Channels	<u>Middle</u>
Signal	<u>LTE (Crest factor: 1.0)</u>

B. SAR Measurement Results

Frequency (MHz)	710.000000
Relative permittivity (real part)	42.906170
Relative permittivity (imaginary part)	21.709370
Conductivity (S/m)	0.856314
Variation (%)	0.460000

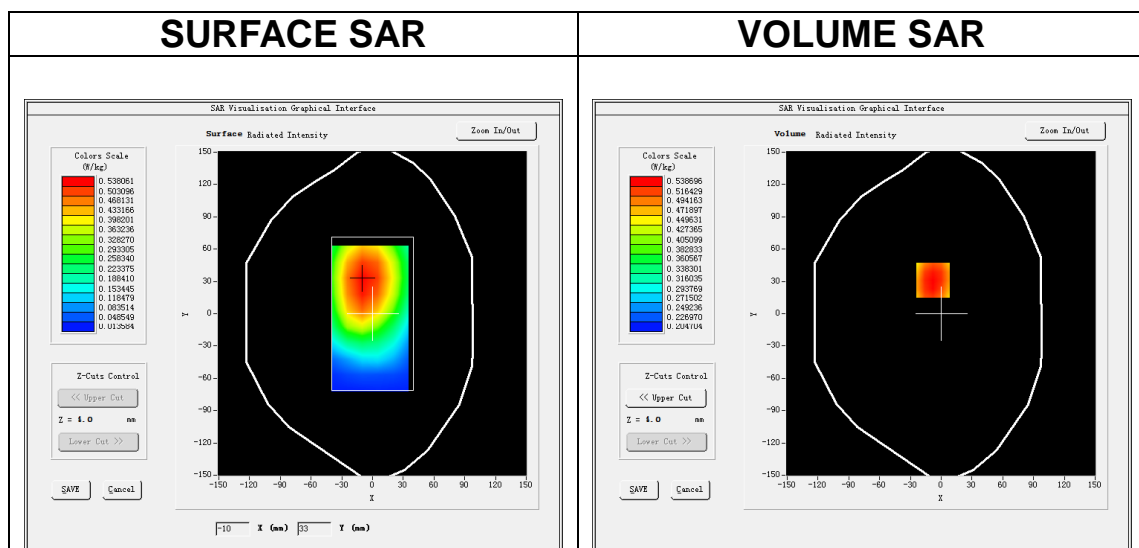

Maximum location: X=-8.00, Y=31.00

SAR Peak: 0.59 W/kg

SAR 10g (W/Kg)	0.452953
SAR 1g (W/Kg)	0.527754

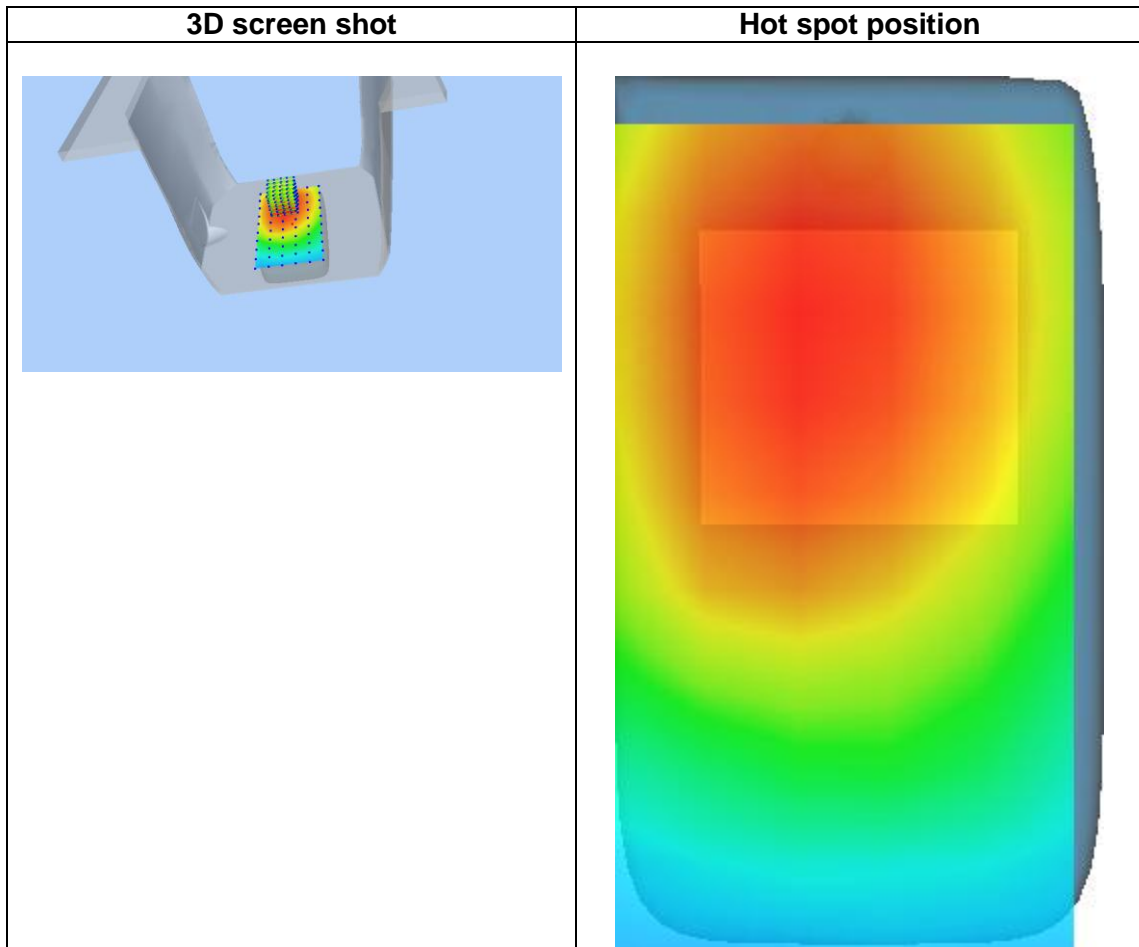
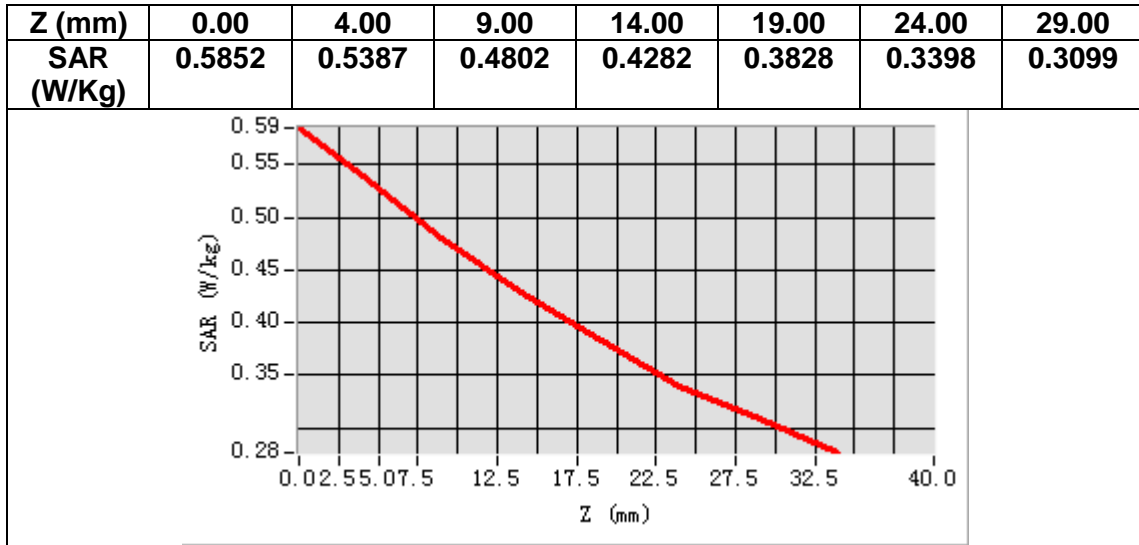

MEASUREMENT 31

Date of measurement: 3/2/2021

A. Experimental conditions.

Area Scan	<u>dx=15mm dy=15mm, h= 5.00 mm</u>
ZoomScan	<u>5x5x7, dx=8mm dy=8mm dz=5mm</u>
Phantom	<u>Left head</u>
Device Position	<u>Cheek</u>
Band	<u>LTE band 25</u>
Channels	<u>Middle</u>
Signal	<u>LTE (Crest factor: 1.0)</u>

B. SAR Measurement Results

Frequency (MHz)	1882.500000
Relative permittivity (real part)	39.821957
Relative permittivity (imaginary part)	13.051034
Conductivity (S/m)	1.364558
Variation (%)	-3.230000

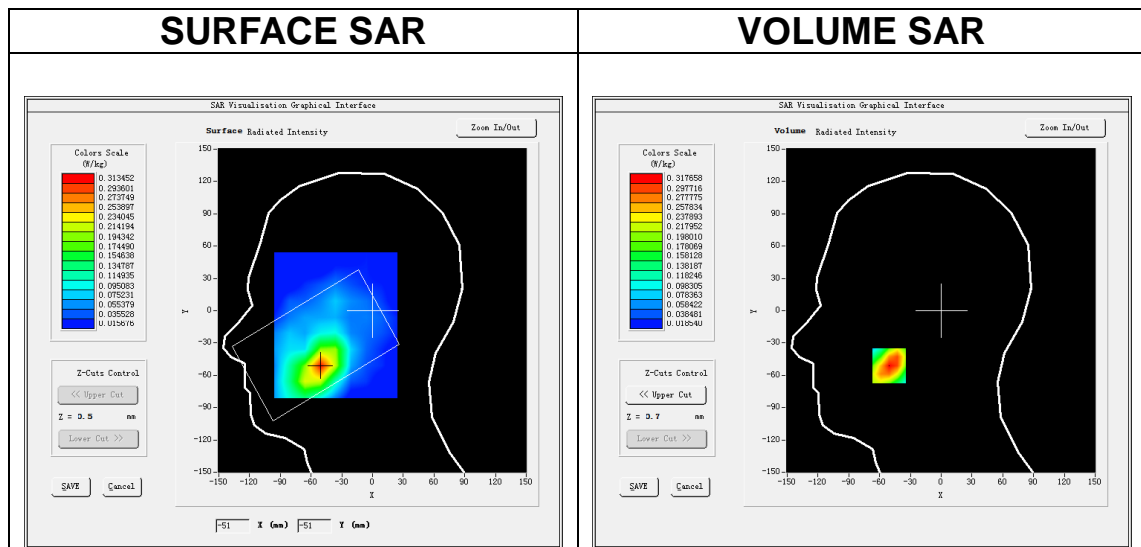

Maximum location: X=-51.00, Y=-51.00

SAR Peak: 0.47 W/kg

SAR 10g (W/Kg)	0.175654
SAR 1g (W/Kg)	0.303198

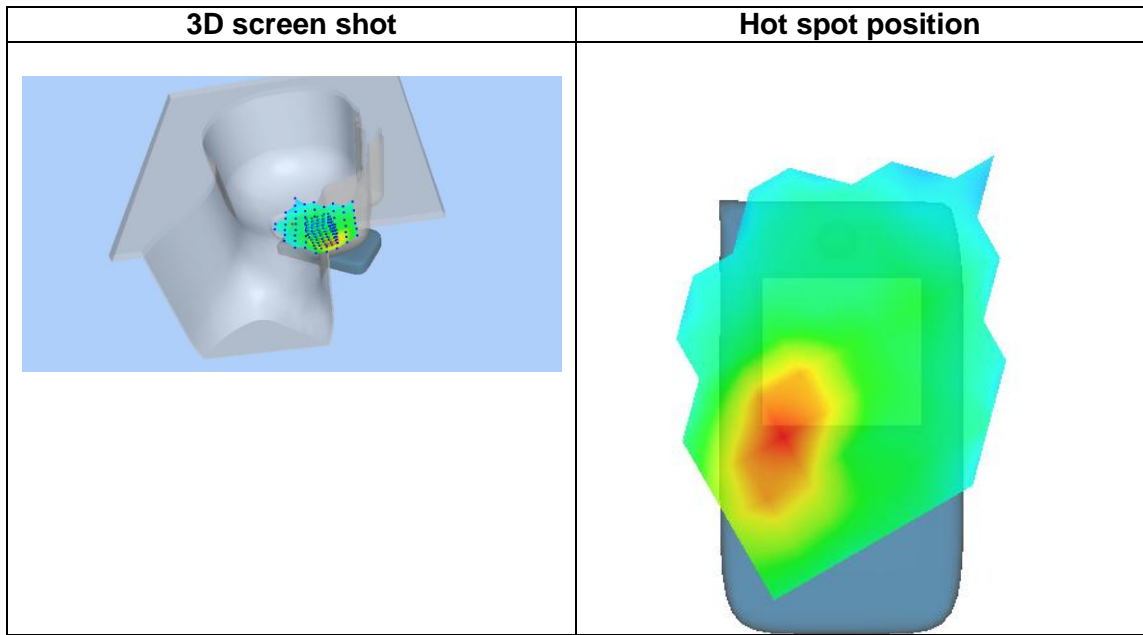
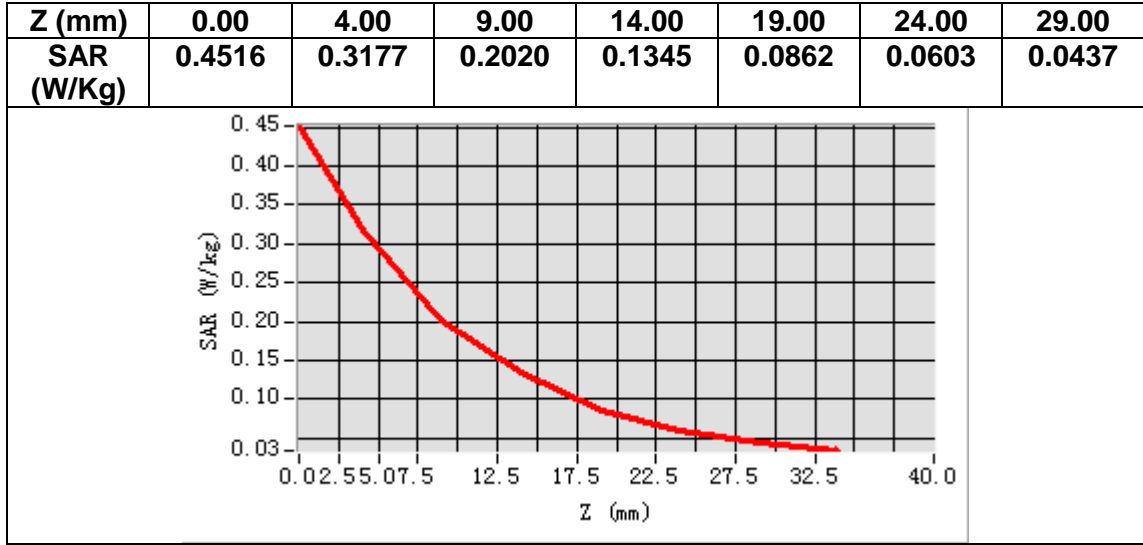

MEASUREMENT 32

Date of measurement: 3/2/2021

A. Experimental conditions.

Area Scan	<u>dx=15mm dy=15mm, h= 5.00 mm</u>
ZoomScan	<u>5x5x7, dx=8mm dy=8mm dz=5mm</u>
Phantom	<u>Validation plane</u>
Device Position	<u>Body</u>
Band	<u>LTE band 25</u>
Channels	<u>Middle</u>
Signal	<u>LTE (Crest factor: 1.0)</u>

B. SAR Measurement Results

Frequency (MHz)	1882.500000
Relative permittivity (real part)	39.821957
Relative permittivity (imaginary part)	13.051034
Conductivity (S/m)	1.364558
Variation (%)	-1.640000

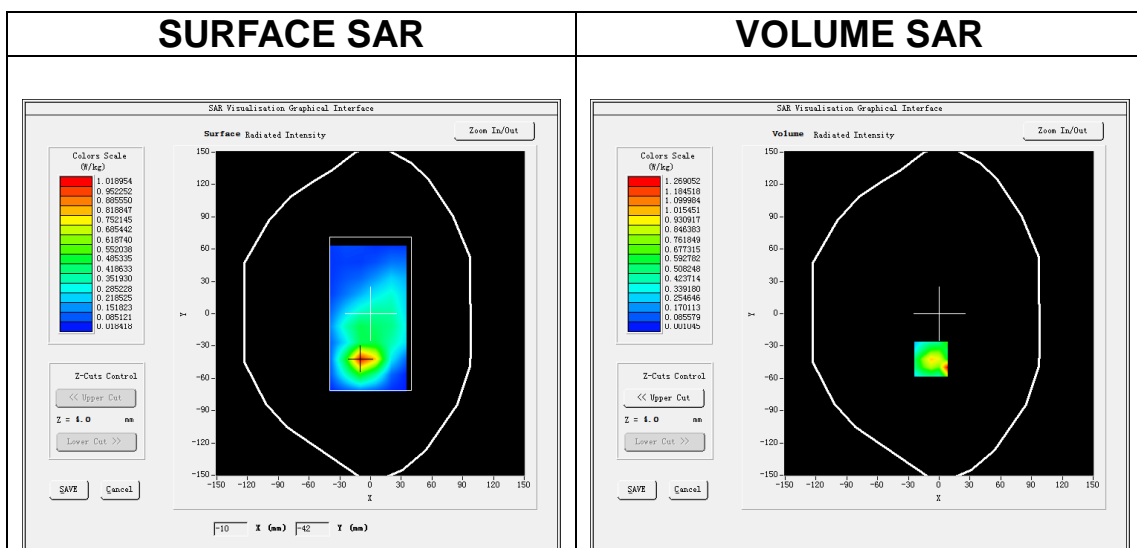

Maximum location: X=-8.00, Y=-42.00

SAR Peak: 2.92 W/kg

SAR 10g (W/Kg)	0.472316
SAR 1g (W/Kg)	0.992166

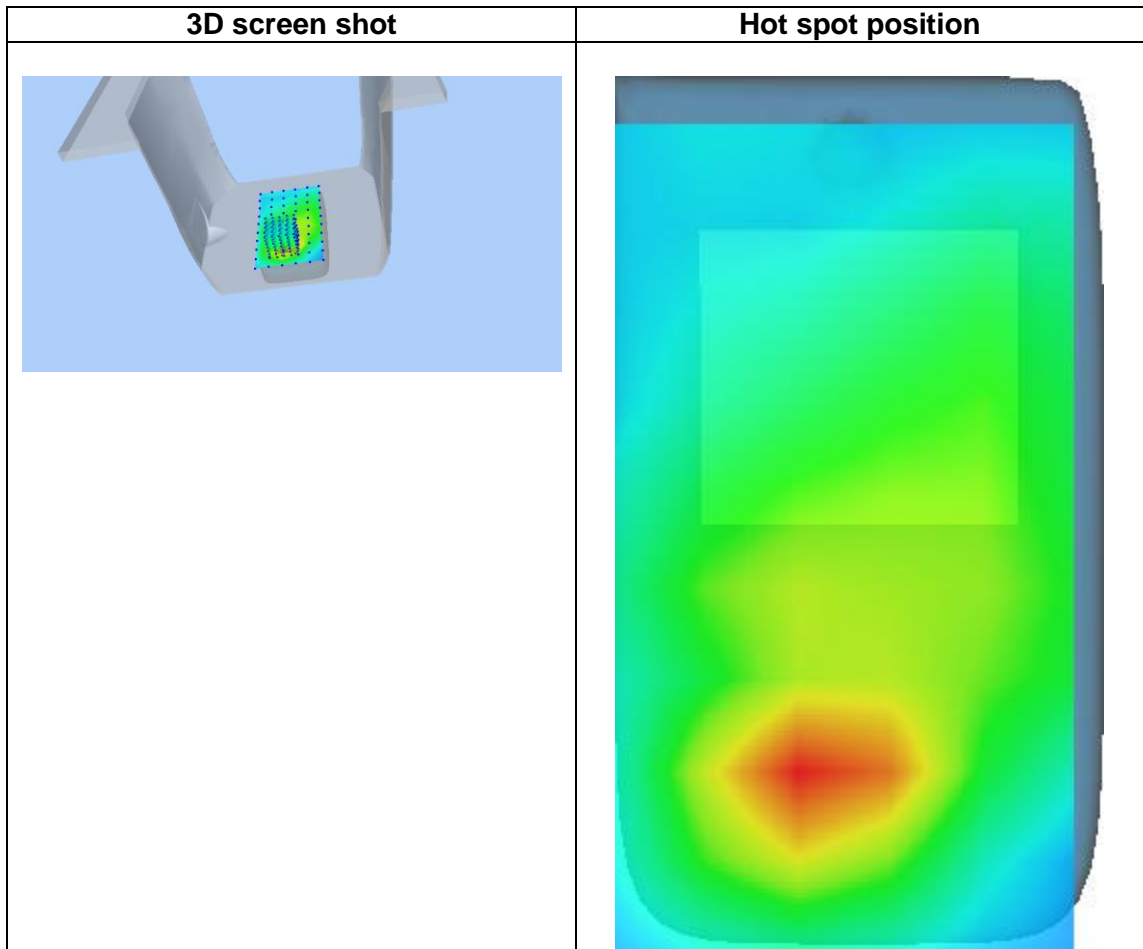
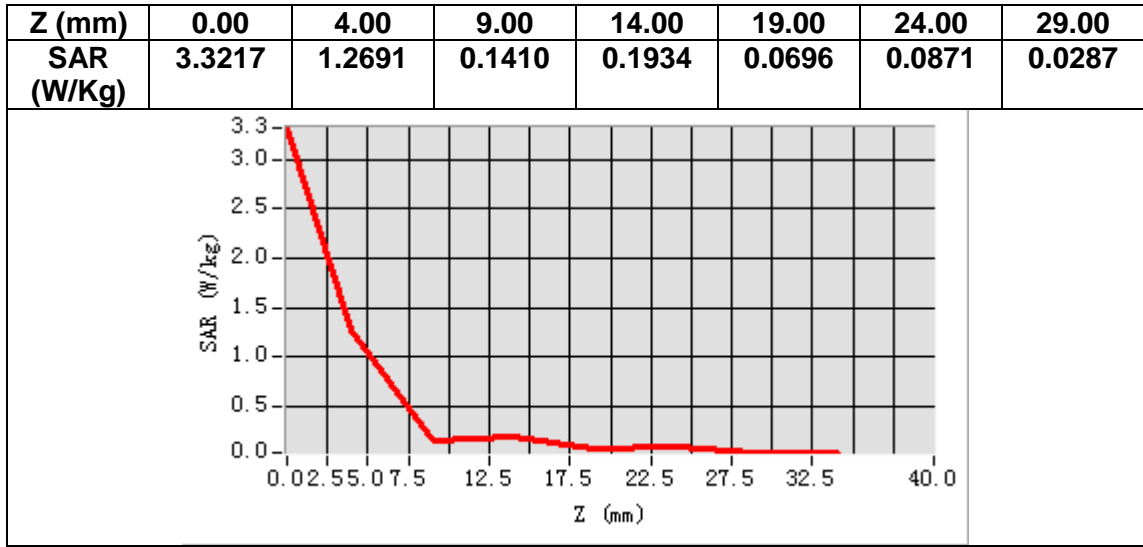

MEASUREMENT 33

Date of measurement: 2/2/2021

A. Experimental conditions.

Area Scan	<u>dx=15mm dy=15mm, h= 5.00 mm</u>
ZoomScan	<u>5x5x7, dx=8mm dy=8mm dz=5mm</u>
Phantom	<u>Left head</u>
Device Position	<u>Body</u>
Band	<u>LTE band 26A</u>
Channels	<u>Middle</u>
Signal	<u>LTE (Crest factor: 1.0)</u>

B. SAR Measurement Results

Frequency (MHz)	819.000000
Relative permittivity (real part)	42.145817
Relative permittivity (imaginary part)	19.507206
Conductivity (S/m)	0.887578
Variation (%)	1.200000

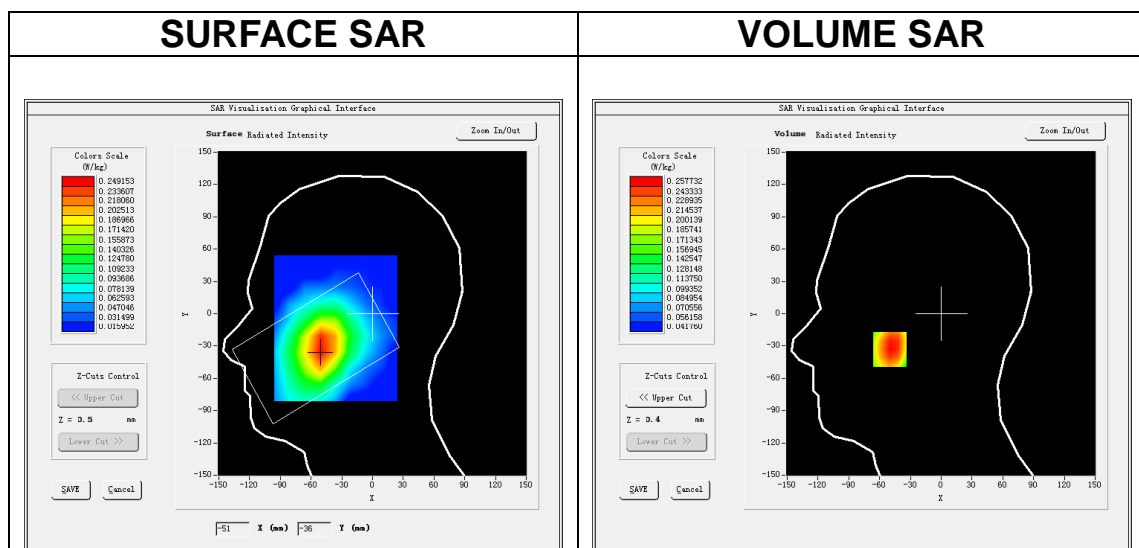

Maximum location: X=-50.00, Y=-33.00

SAR Peak: 0.32 W/kg

SAR 10g (W/Kg)	0.188385
SAR 1g (W/Kg)	0.254499

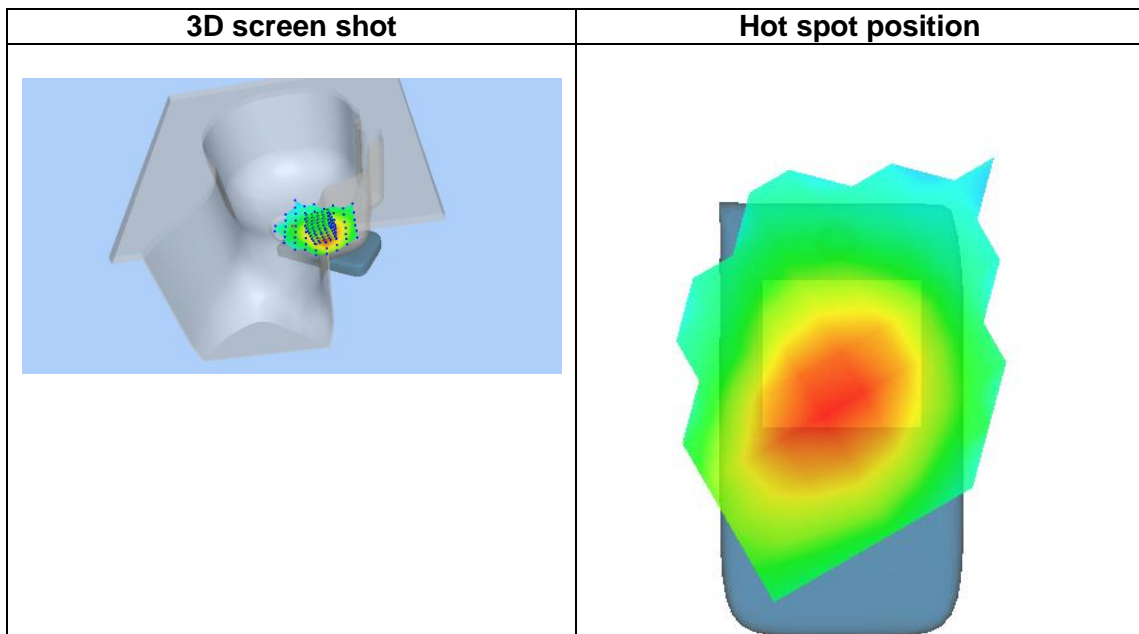
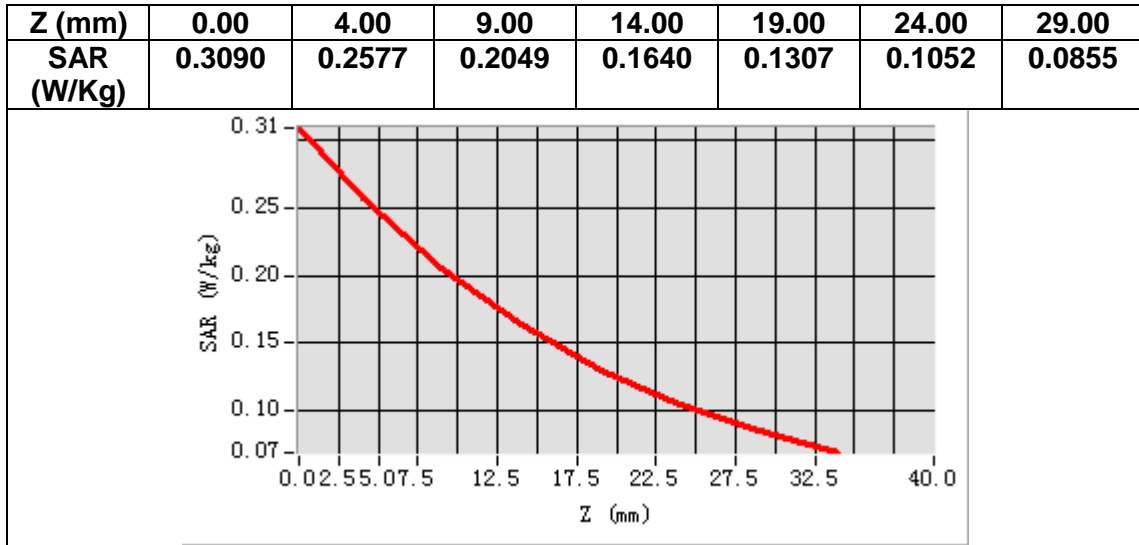

MEASUREMENT 34

Date of measurement: 2/2/2021

A. Experimental conditions.

Area Scan	<u>dx=15mm dy=15mm, h= 5.00 mm</u>
ZoomScan	<u>5x5x7, dx=8mm dy=8mm dz=5mm</u>
Phantom	<u>Validation plane</u>
Device Position	<u>Body</u>
Band	<u>LTE band 26A</u>
Channels	<u>Middle</u>
Signal	<u>LTE (Crest factor: 1.0)</u>

B. SAR Measurement Results

Frequency (MHz)	819.000000
Relative permittivity (real part)	42.145817
Relative permittivity (imaginary part)	19.507206
Conductivity (S/m)	0.887578
Variation (%)	0.870000

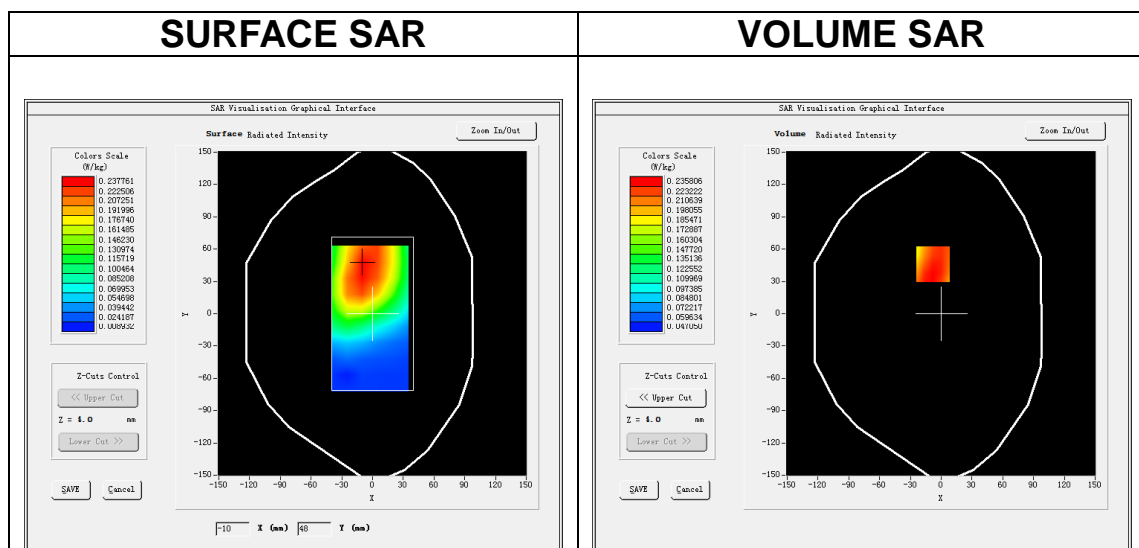

Maximum location: X=-8.00, Y=46.00

SAR Peak: 0.29 W/kg

SAR 10g (W/Kg)	0.174330
SAR 1g (W/Kg)	0.229754

