



FCC TEST REPORT

Test report
On Behalf of
Shenzhen Huafurui Technology Co., Ltd.
For
Smart Phone
Model No.: KINGKONG 3

FCC ID: 2AHZ5KINGKONG3

Prepared for : Shenzhen Huafurui Technology Co., Ltd.
Unit 1401 &1402, 14/F, Jin qi zhi gu mansion (No. 4 building of Chong wen Garden),
Crossing of the Liu xian street and Tang ling road, Tao yuan street, Nan shan district,
Shenzhen,P.R. China

Prepared By : Shenzhen HUAKE Testing Technology Co., Ltd.
1F, B2 Building, Junfeng Zhongcheng Zhizao Innovation Park, Fuhai Street, Bao'an
District, Shenzhen City, China

Date of Test: Aug. 24, 2018~Sep. 26, 2018

Date of Report: Sep. 26, 2018

Report Number: HK1809111022E



TEST RESULT CERTIFICATION

Applicant's name : Shenzhen Huafurui Technology Co., Ltd.
 Address : Unit 1401 &1402, 14/F, Jin qi zhi gu mansion (No. 4 building of Chong wen Garden), Crossing of the Liu xian street and Tang ling road, Tao yuan street, Nan shan district, Shenzhen,P.R. China

Manufacture's Name..... : Shenzhen Huafurui Technology Co., Ltd.
 Address : Unit 1401 &1402, 14/F, Jin qi zhi gu mansion (No. 4 building of Chong wen Garden), Crossing of the Liu xian street and Tang ling road, Tao yuan street, Nan shan district, Shenzhen,P.R. China

Product description : Smart Phone
 Brand Name : CUBOT
 Mode Name : KINGKONG 3

Standards : FCC Rules and Regulations Part 15B

This publication may be reproduced in whole or in part for non-commercial purposes as long as the Shenzhen HUAKE Testing Technology Co., Ltd. is acknowledged as copyright owner and source of the material. Shenzhen HUAKE Testing Technology Co., Ltd. takes no responsibility for and will not assume liability for damages resulting from the reader's interpretation of the reproduced material due to its placement and context.

Date of Test :
 Date (s) of performance of tests : **Aug. 24, 2018~Sep. 26, 2018**
 Date of Issue : **Sep. 26, 2018**
 Test Result..... : **Pass**

Testing Engineer : 

 (Gary Qian)

Technical Manager : 

 (Eden Hu)

Authorized Signatory : 

 (Jason Zhou)



Revision	Issue Date	Revisions	Revised By
V1.0	Sep. 26, 2018	Initial Issue	Jason Zhou



TABLE OF CONTENTS

1. SYSTEM DESCRIPTION	5
2. MEASUREMENT UNCERTAINTY	6
3. PRODUCT INFORMATION	7
4. SUPPORT EQUIPMENT	8
5. TEST FACILITY	9
6. TEST ITEMS AND THE RESULTS	10
7. FCCLINE CONDUCTED EMISSION TEST	11
7.1. LIMITS OF LINE CONDUCTED EMISSION TEST	11
7.2. BLOCK DIAGRAM OF TEST SETUP.....	11
7.3. PROCEDURE OF LINE CONDUCTED EMISSION TEST	12
7.4. TEST RESULT OF LINE CONDUCTED EMISSION TEST	13
8. FCC RADIATED EMISSION TEST	15
8.1. EXCEPT FOR CLASS A DIGITAL DEVICES, THE FIELD STRENGTH OF RADIATED EMISSIONS FROM UNINTENTIONAL RADIATORS AT A DISTANCE OF 3 METERS SHALL NOT EXCEED THE FOLLOWING VALUES:.....	15
8.2. BLOCK DIAGRAM OF TEST SETUP.....	16
8.3. PROCEDURE OF RADIATED EMISSION TEST	17
8.4. TEST RESULT OF RADIATED EMISSION TEST	18
APPENDIX A: PHOTOGRAPHS OF TEST SETUP	22



1. SYSTEM DESCRIPTION

EUT test procedure:

1. Connect EUT and peripheral devices (PC) through USB port.
2. Power on the EUT, use the software to transfer data between EUT and PC.
3. Make sure the EUT operates normally during the test.

Test Mode

TEST MODE DESCRIPTION		
NO.	TEST MODE DESCRIPTION	WORST
1	USB (connection for data transferring)	V

Note:
1. V means EMI worst mode



2. MEASUREMENT UNCERTAINTY

Test	Measurement Uncertainty	Notes
Transmitter power conducted	± 0.57 dB	(1)
Transmitter power Radiated	± 2.20 dB	(1)
Conducted spurious emission 9KHz-40 GHz	± 2.20 dB	(1)
Occupied Bandwidth	± 0.01 ppm	(1)
Radiated Emission 30~1000MHz	± 4.10 dB	(1)
Radiated Emission Above 1GHz	± 4.32 dB	(1)
Conducted Disturbance 0.15~30MHz	± 3.20 dB	(1)

Note: This uncertainty represents an expanded uncertainty expressed at approximately the 95% confidence level using a coverage factor of $k=2$.



3. PRODUCT INFORMATION

Housing Type	Plastic and metal
Hardware Version	A756_MAIN_PCB_V1.2
Software Version	CUBOT_KING_KONG_3_8091C_V04+20180816
EUT Input Rating	DC3.85V by battery or DC 5V by Micro-USB

I/O Port Information (Applicable Not Applicable)

I/O Port of EUT			
I/O Port Type	Number	Specific	Tested With
USB Port	1	0.8 Unshielded	1



4. SUPPORT EQUIPMENT

Device Type	Manufacturer	Model Name	Serial No.	Data Cable	Power Cable
PC	Lenovo Inc.	--	--	--	0.8m Unshielded
Adapter	Lenovo Inc.	--	--	--	1.25m Unshielded

Note: All the above equipment/cables were placed in worse case positions to maximize emission signals during emission test.



5. TEST FACILITY

Site	Shenzhen HUAKE Testing Technology Co., Ltd.
Location	1F, B2 Building, Junfeng Zhongcheng Zhizao Innovation Park, Fuhai Street, Bao'an District, Shenzhen City, China
Designation Number	CN1229
Test Firm Registration Number : 616276	

TEST EQUIPMENT OF CONDUCTED EMISSION TEST

Conducted Emission Shielding Room Test Site (744)				
Equipment	Manufacturer	Model	Serial Number	Calibration Due
Receiver	R&S	ESCI 7	HKE-010	Dec. 28, 2018
LISN	R&S	ENV216	HKE-002	Dec. 28, 2018
Conducted test software	Tonscend	TS+ Rev 2.5.0.0	HKE-081	N/A

TEST EQUIPMENT OF RADIATED EMISSION TEST

Radiated Emission Test Site (966)				
Name of Equipment	Manufacturer	Model	Serial Number	Calibration Due
Receiver	R&S	ESCI-7	HKE-010	Dec. 28, 2018
Spectrum analyzer	Agilent	N9020A	HKE-048	Dec. 28, 2018
Preamplifier	EMCI	EMC051845SE	HKE-015	Dec. 28, 2018
Preamplifier	Agilent	83051A	HKE-016	Dec. 28, 2018
Loop antenna	Schwarzbeck	FMZB 1519 B	HKE-014	Dec. 28, 2018
Broadband antenna	Schwarzbeck	VULB 9163	HKE-012	Dec. 28, 2018
Horn antenna	Schwarzbeck	9120D	HKE-013	Dec. 28, 2018
Antenna Mast	Keleto	CC-A-4M	N/A	N/A
Position controller	Taiwan MF	MF7802	HKE-011	Dec. 28, 2018
Radiated test software	Tonscend	TS+ Rev 2.5.0.0	HKE-082	N/A
RF cable (9KHz-1GHz)	Times	381806-001	N/A	N/A
RF cable	Times	1-40G	HKE-034	Dec. 28, 2018

**6. TEST ITEMS AND THE RESULTS**

Test item	Test Requirement	Test Method	Class/Severity	Result
CONDUCTED EMISSION	FCC Part 15.107 Rules	ANSI C63.4:2014	Class B	Pass
RADIATED EMISSION	FCC Part 15.109 Rules	ANSI C63.4:2014	Class B	Pass

7. FCCLINE CONDUCTED EMISSION TEST

7.1. LIMITS OF LINE CONDUCTED EMISSION TEST

Frequency	Maximum RF Line Voltage	
	Q.P.(dBuV)	Average(dBuV)
150kHz-500kHz	66-56	56-46
500kHz-5MHz	56	46
5MHz-30MHz	60	50

Note:

1. The lower limit shall apply at the transition frequency.
2. The limit decreases linearly with the logarithm of the frequency in the range 0.15 MHz to 0.50MHz.

7.2. BLOCK DIAGRAM OF TEST SETUP

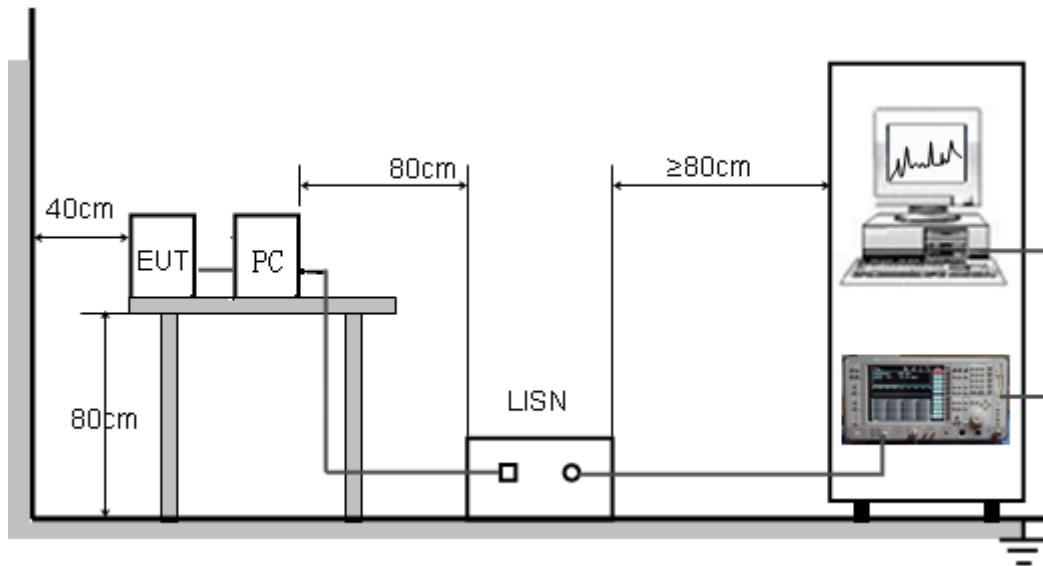



7.3. PROCEDURE OF LINE CONDUCTED EMISSION TEST

- (1) The equipment was set up as per the test configuration to simulate typical actual usage per the user's manual. When the EUT is a tabletop system, a wooden table with a height of 0.8 meters is used and is placed on the ground plane as per ANSI C63.4 (see Test Facility for the dimensions of the ground plane used). When the EUT is a floor-standing equipment, it is placed on the ground plane which has a 3-12 mm non-conductive covering to insulate the EUT from the ground plane.
- (2) Support equipment, if needed, was placed as per ANSI C63.4.
- (3) All I/O cables were positioned to simulate typical actual usage as per ANSI C63.4.
- (4) The EUT received DC5V power from PC with receive AC120V/60Hz power from a LISN.
- (5) The EUT test program was started. Emissions were measured on each current carrying line of the EUT using a spectrum Analyzer / Receiver connected to the LISN powering the EUT. The LISN has two monitoring points: Line 1 (Hot Side) and Line 2 (Neutral Side). Two scans were taken: one with Line 1 connected to Analyzer / Receiver and Line 2 connected to a 50 ohm load; the second scan had Line 1 connected to a 50 ohm load and Line 2 connected to the Analyzer / Receiver.
- (6) Analyzer / Receiver scanned from 150 kHz to 30MHz for emissions in each of the test modes.
- (7) During the above scans, the emissions were maximized by cable manipulation.
- (8) A scan was taken on both power lines, Line 1 and Line 2, recording at least the six highest emissions.
- (9) Emission frequency and amplitude were recorded into a computer in which correction factors were used to calculate the emission level and compare reading to the applicable limit. If EUT emission level was less -2dB to the A.V. limit in Peak mode, then the emission signal was re-checked using Q.P and Average detector.

The test data of the worst case condition (mode 1) was reported on the Summary Data page.



7.4. TEST RESULT OF LINE CONDUCTED EMISSION TEST

LINE CONDUCTED EMISSION TEST-L

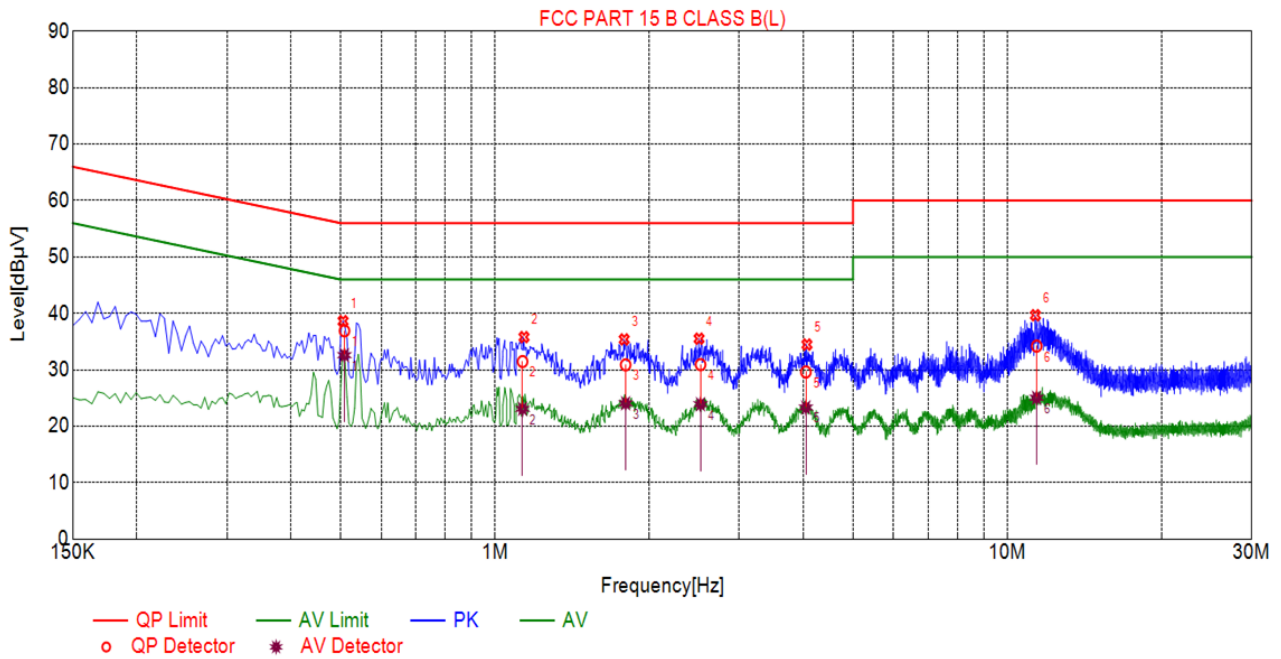

Suspected List						
NO.	Freq. [MHz]	Level [dBµV]	Factor [dB]	Limit [dBµV]	Margin [dB]	Detector
1	0.5055	38.62	10.04	56.00	17.38	PK
2	1.1400	35.79	10.09	56.00	20.21	PK
3	1.7880	35.38	10.14	56.00	20.62	PK
4	2.5035	35.51	10.19	56.00	20.49	PK
5	4.0650	34.47	10.25	56.00	21.53	PK
6	11.3505	39.67	10.00	60.00	20.33	PK

Final Data List								
NO.	Freq. [MHz]	Factor [dB]	QP Value [dBµV]	QP Limit [dBµV]	QP Margin [dB]	AV Value [dBµV]	AV Limit [dBµV]	AV Margin [dB]
1	0.5086	10.04	36.91	56.00	19.09	32.59	46.00	13.41
2	1.1323	10.08	31.46	56.00	24.54	23.08	46.00	22.92
3	1.7995	10.14	30.88	56.00	25.12	24.06	46.00	21.94
4	2.5199	10.19	30.91	56.00	25.09	23.89	46.00	22.11
5	4.0455	10.25	29.61	56.00	26.39	23.32	46.00	22.68
6	11.4083	10.00	34.21	60.00	25.79	25.04	50.00	24.96



LINE CONDUCTED EMISSION TEST-N

FCC PART 15 B CLASS B(N)

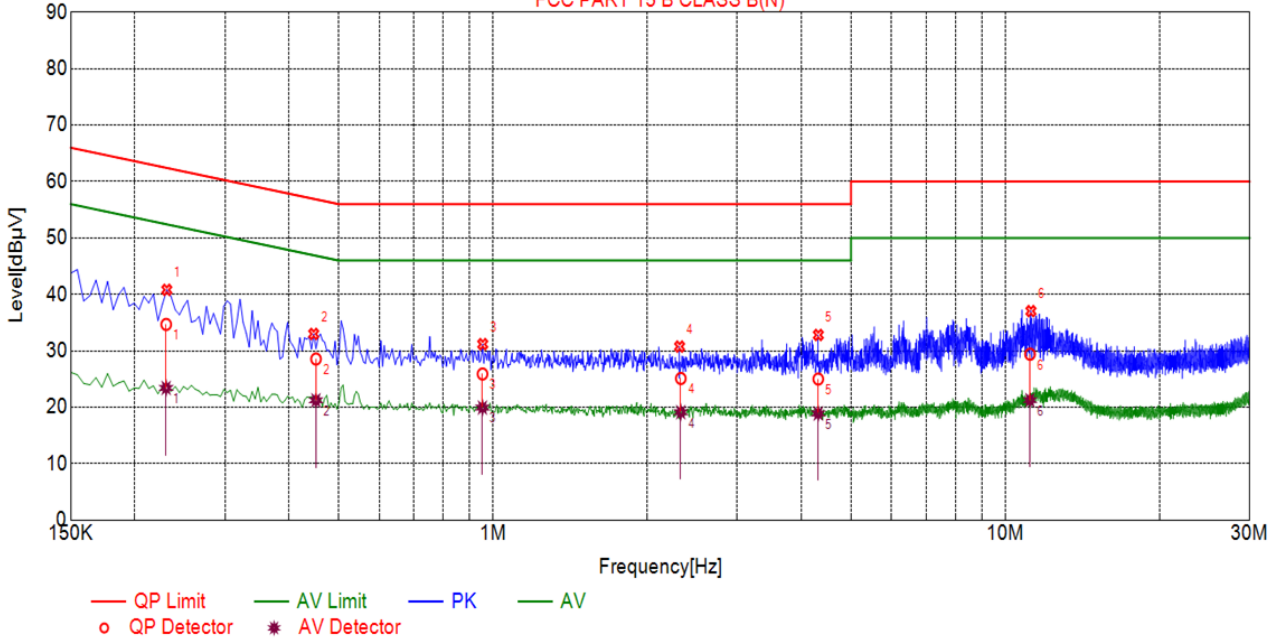

Suspected List						
NO.	Freq. [MHz]	Level [dBµV]	Factor [dB]	Limit [dBµV]	Margin [dB]	Detector
1	0.2310	40.80	10.03	62.41	21.61	PK
2	0.4470	32.99	10.04	56.93	23.94	PK
3	0.9555	31.17	10.06	56.00	24.83	PK
4	2.3145	30.74	10.18	56.00	25.26	PK
5	4.3170	32.80	10.25	56.00	23.20	PK
6	11.2245	37.03	10.01	60.00	22.97	PK

Final Data List								
NO.	Freq. [MHz]	Factor [dB]	QP Value [dBµV]	QP Limit [dBµV]	QP Margin [dB]	AV Value [dBµV]	AV Limit [dBµV]	AV Margin [dB]
1	0.2303	10.03	34.68	62.44	27.76	23.41	52.44	29.03
2	0.4515	10.04	28.54	56.85	28.31	21.23	46.85	25.62
3	0.9543	10.06	25.89	56.00	30.11	19.93	46.00	26.07
4	2.3266	10.18	25.09	56.00	30.91	19.11	46.00	26.89
5	4.3148	10.25	24.99	56.00	31.01	18.89	46.00	27.11
6	11.1732	10.01	29.40	60.00	30.60	21.25	50.00	28.75

RESULT: PASS



8. FCC RADIATED EMISSION TEST

8.1. EXCEPT FOR CLASS A DIGITAL DEVICES, THE FIELD STRENGTH OF RADIATED EMISSIONS FROM UNINTENTIONAL RADIATORS AT A DISTANCE OF 3 METERS SHALL NOT EXCEED THE FOLLOWING VALUES:

Frequency (MHz)	Distance (m)	Maximum Field Strength Limit (dBuV/m/ Q.P.)
30~88	3	40.0
88~216	3	43.5
216~960	3	46.0
Above 960	3	54.0

Note: The lower limit shall apply at the transition frequency.

8.1.1 The following table is the setting of spectrum analyzer and receiver:

Spectrum Parameter	Setting
Start ~Stop Frequency	9KHz~150KHz/RB 200Hz for QP
Start ~Stop Frequency	150KHz~30MHz/RB 9KHz for QP
Start ~Stop Frequency	30MHz~1000MHz/RB 120KHz for QP
Start ~Stop Frequency	1GHz~26.5GHz 1MHz/1MHz for Peak, 1MHz/10Hz for Average

Receiver Parameter	Setting
Start ~Stop Frequency	9KHz~150KHz/RB 200Hz for QP
Start ~Stop Frequency	150KHz~30MHz/RB 9KHz for QP
Start ~Stop Frequency	30MHz~1000MHz/RB 120KHz for QP

8.2. BLOCK DIAGRAM OF TEST SETUP

System Diagram of Connections between EUT and Simulators

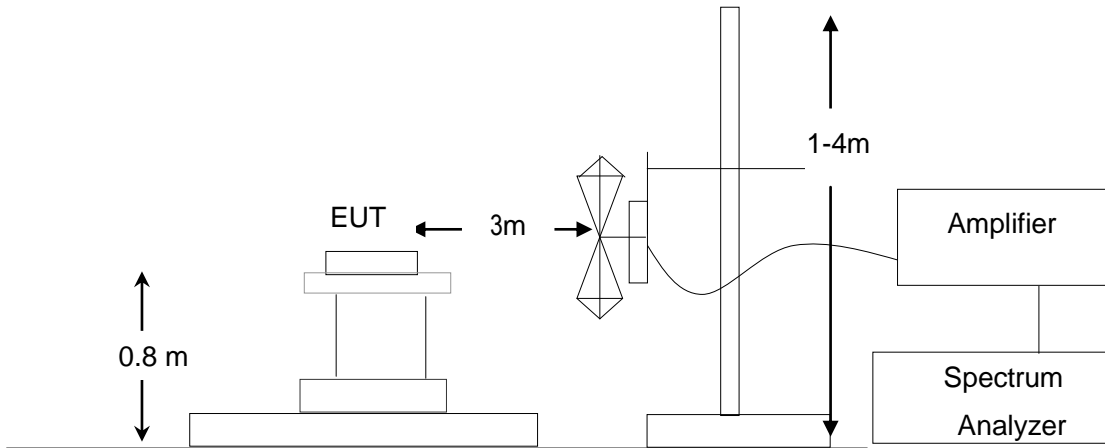

RADIATED EMISSION TEST SETUP ABOVE 1000MHz

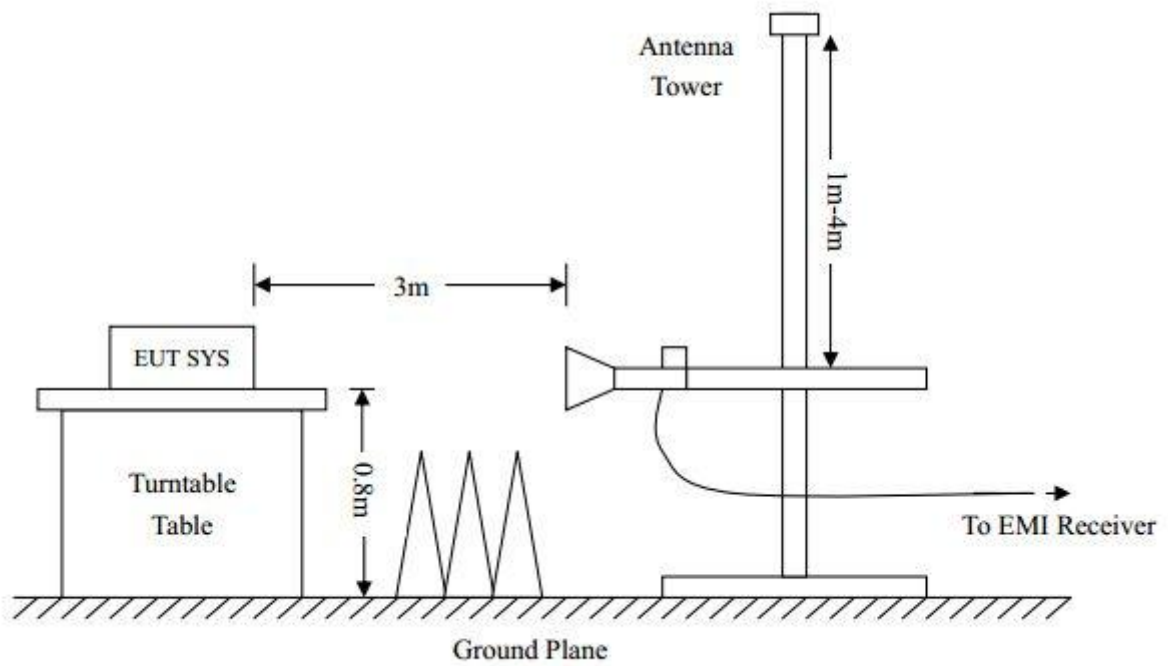



8.3. PROCEDURE OF RADIATED EMISSION TEST

1. Configure the EUT according to ANSI C63.4. The EUT was placed on the top of the turntable 0.8 meter above ground. The phase center of the receiving antenna mounted on the top of a height-variable antenna tower was placed 3 meters far away from the turntable.
2. Power on the EUT and all the supporting units. The turntable was rotated by 360 degrees to determine the position of the highest radiation.
3. The height of the broadband receiving antenna was varied between one meter and four meters above ground to find the maximum emissions field strength of both horizontal and vertical polarization.
4. For each suspected emissions, the antenna tower was scan (from 1 M to 4 M) and then the turntable was rotated (from 0 degree to 360 degrees) to find the maximum reading.
5. Set the test-receiver system to Peak or CISPR quasi-peak Detect Function with specified bandwidth under Maximum Hold Mode.
6. For emissions above 1GHz, use 1MHz RBW and 3MHz VBW for peak reading. Then 1MHz RBW and 3MHz VBW for average reading in spectrum analyzer. The EUT was placed on the top of the turntable 0.8 meter above ground. The phase center of the receiving antenna mounted on the top of a height-variable antenna tower was placed 3 meters far away from the turntable.
7. When the radiated emissions limits are expressed in terms of the average value of the emissions, and pulsed operation is employed, the measurement field strength shall be determined by averaging over one complete pulse train, including blanking intervals, as long as the pulse train does not exceed 0.1 seconds. As an alternative (provided the transmitter operates for longer than 0.1 seconds) or in cases where the pulse train exceeds 0.1 seconds, the measured field strength shall be determined from the average absolute voltage during a 0.1 second interval during which the field strength is at its maximum values.
8. If the emissions level of the EUT in peak mode was 3 dB lower than the average limit specified, then testing will be stopped and peak values of EUT will be reported, otherwise, the emissions which do not have 3 dB margin will be repeated one by one using the quasi-peak method for below 1GHz.
9. If the emission level of the EUT in peak mode was 10 dB lower than the limit specified, then testing could be stopped and the peak values of the EUT would be reported. Otherwise the emissions that did not have 10 dB margin would be re-tested one by one using peak, quasi-peak or average method as specified and then reported in a data sheet.
10. In case the emission is lower than 30MHz, loop antenna has to be used for measurement and the recorded data should be QP measured by receiver. High - Low scan is not required in this case.
11. The test data of the worst case condition (mode 1) was reported on the Summary Data page.



8.4. TEST RESULT OF RADIATED EMISSION TEST

RADIATED EMISSION TEST AT 3M DISTANCE-HORIZONTAL

66.9 dBuV/m

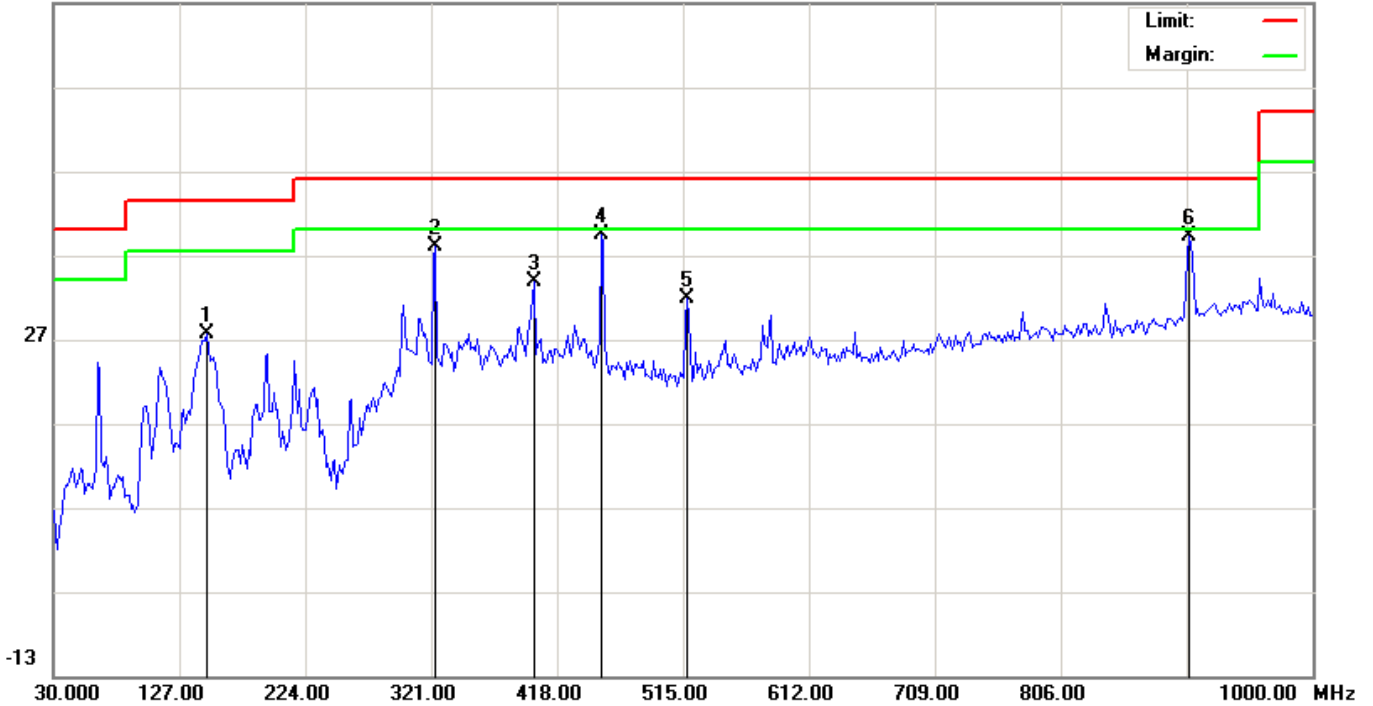

No.	Mk	Freq.	Reading	Factor	Measurement	Limit	Over	Detector	Antenna Height	Table Degree	Comment
		MHz	dBuV	dB/m	dBuV/m	dBuV/m	dB		cm	degree	
1		148.0167	14.26	13.25	27.51	43.50	-15.99	peak			
2		324.2333	21.01	17.02	38.03	46.00	-7.97	peak			
3		400.2167	14.71	19.08	33.79	46.00	-12.21	peak			
4	*	451.9500	18.81	20.61	39.42	46.00	-6.58	peak			
5		518.2333	10.23	21.62	31.85	46.00	-14.15	peak			
6		904.6167	10.55	28.74	39.29	46.00	-6.71	peak			

RESULT: PASS



RADIATED EMISSION TEST AT 3M DISTANCE-VERTICAL

66.9 dBuV/m

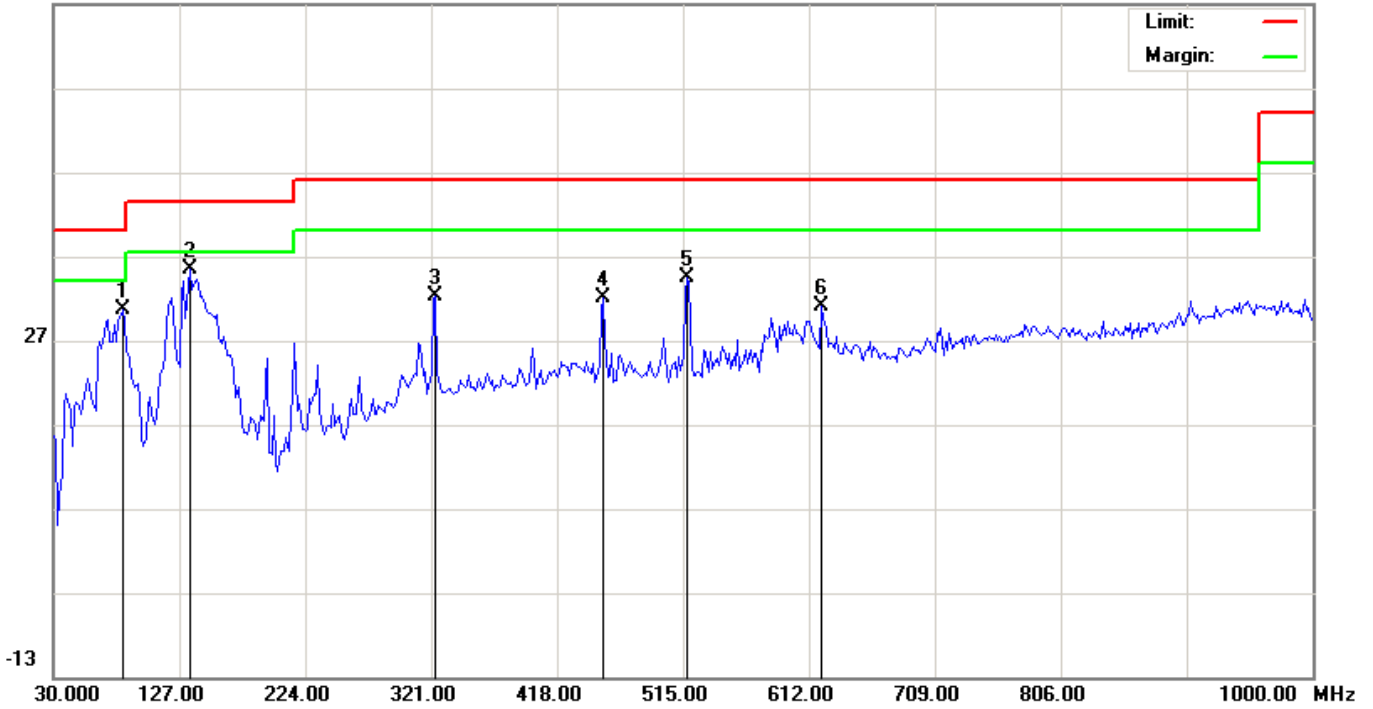

No.	Mk	Freq.	Reading	Factor	Measurement	Limit	Over	Detector	Antenna Height	Table Degree	Comment
		MHz	dBuV	dB/m	dBuV/m	dBuV/m	dB		cm	degree	
1		83.3500	27.52	3.00	30.52	40.00	-9.48	peak			
2	*	135.0833	22.23	13.15	35.38	43.50	-8.12	peak			
3		324.2333	15.24	17.02	32.26	46.00	-13.74	peak			
4		453.5667	11.33	20.63	31.96	46.00	-14.04	peak			
5		518.2333	12.82	21.62	34.44	46.00	-11.56	peak			
6		621.7000	7.74	23.22	30.96	46.00	-15.04	peak			

RESULT: PASS

Note: 1.Measurement = Reading + Factor, Over = Measurement – Limit.

2. The “Factor” value can be calculated automatically by software of measurement system.



RADIATED EMISSION ABOVE 1GHZ (1-10TH HARMONICS) –HORIZONTAL

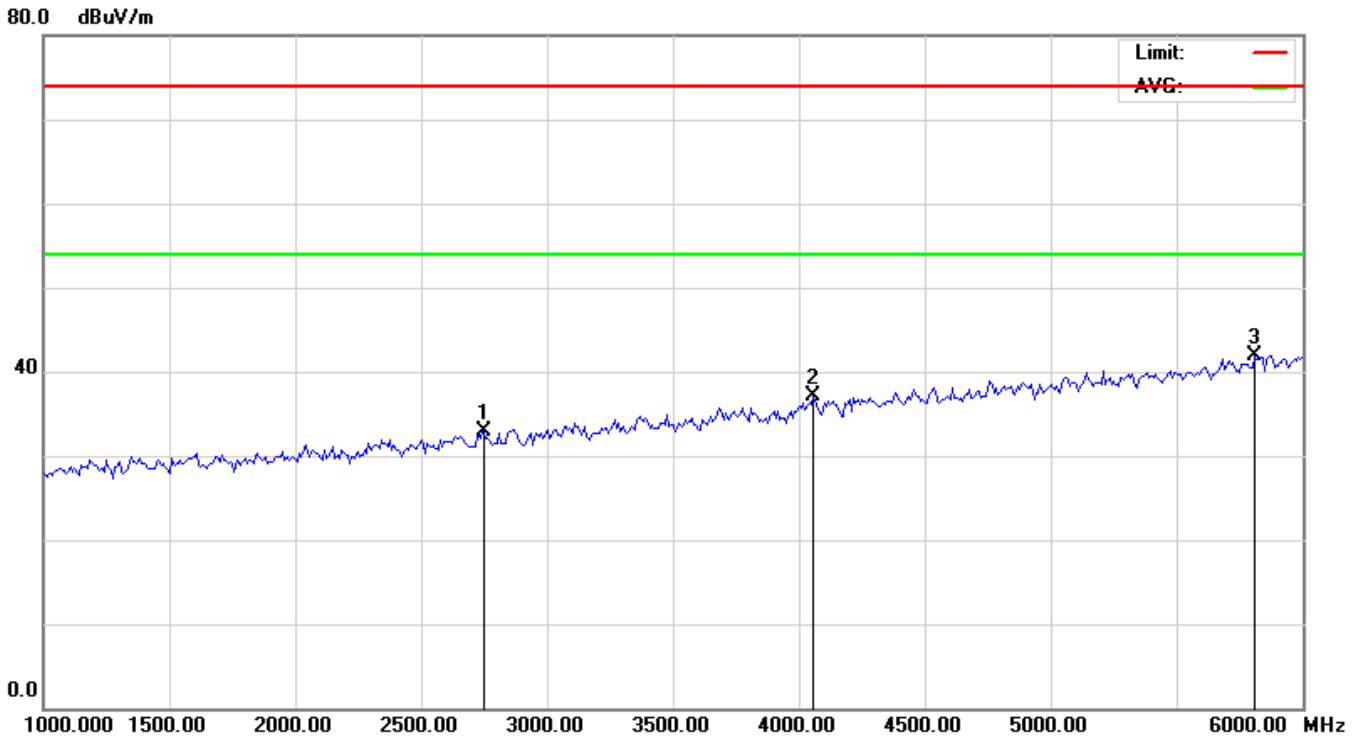

No.	Mk	Freq.	Reading	Factor	Measurement	Limit	Over	Detector	Antenna Height	Table Degree	Comment
		MHz	dBuV	dB/m	dBuV/m	dBuV/m	dB		cm	degree	
1		2750.000	16.96	15.97	32.93	74.00	-41.07	peak			
2		4058.333	20.23	16.97	37.20	74.00	-36.80	peak			
3	*	5808.333	25.95	15.89	41.84	74.00	-32.16	peak			



RADIATED EMISSION ABOVE 1GHZ (1-10TH HARMONICS) –VERTICAL

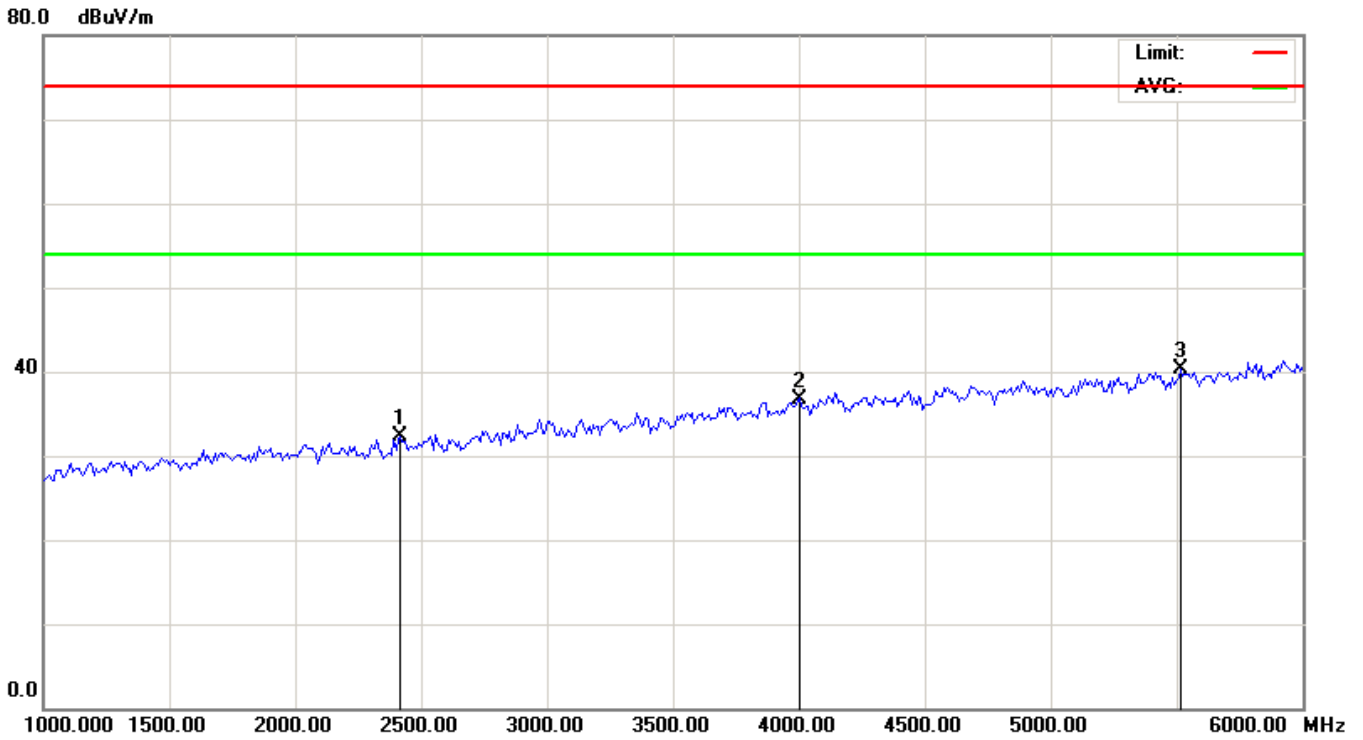

No.	Mk	Freq.	Reading	Factor	Measurement	Limit	Over	Detector	Antenna	Table	Comment
		MHz	dBuV	dB/m	dBuV/m	dBuV/m	dB		Height	Degree	
									cm	degree	
1		2416.667	16.74	15.65	32.39	74.00	-41.61	peak			
2		4000.000	19.59	17.21	36.80	74.00	-37.20	peak			
3	*	5516.667	24.49	15.84	40.33	74.00	-33.67	peak			

- Note:** 1. Emissions range from 6GHz to 12.5GHz have 20dB margin. No recording in the test report.
 2. Factor=Antenna Factor + Cable loss - Amplifier gain, Margin=Measurement-Limit.
 3. The “Factor” value can be calculated automatically by software of measurement system.



APPENDIX A: PHOTOGRAPHS OF TEST SETUP

FCC LINE CONDUCTED EMISSION TEST SETUP



FCC RADIATED EMISSION TEST SETUP

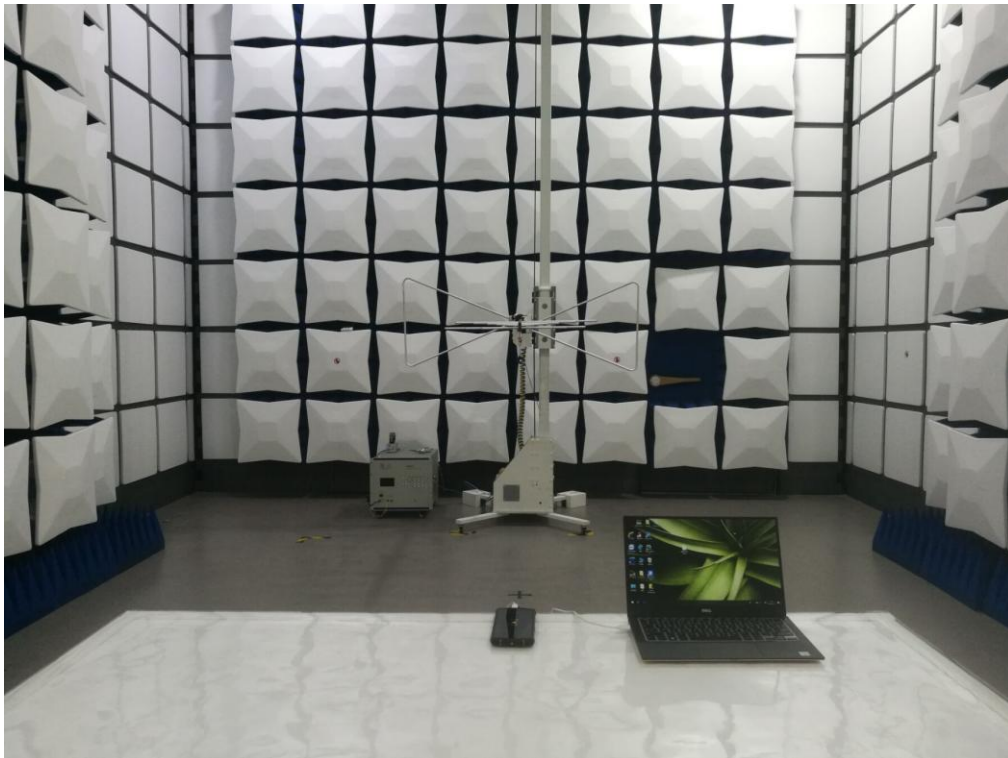



FCC RADIATED EMISSION TEST SETUP

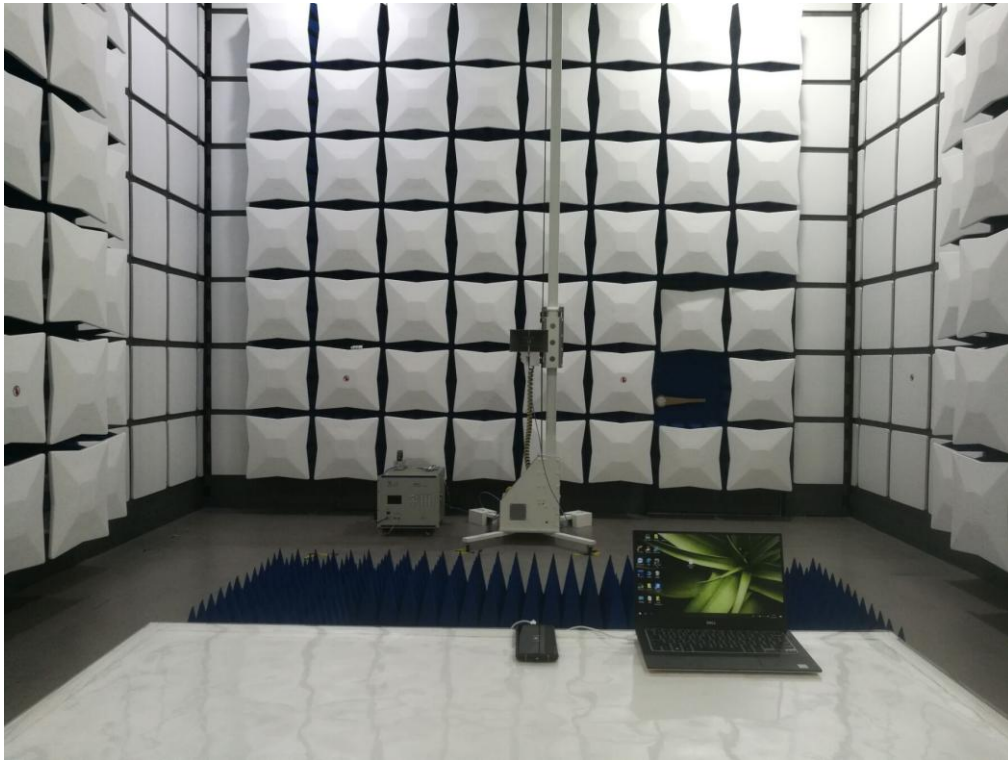

----END OF REPORT----