



# FCC TEST REPORT

**Test report  
On Behalf of  
Shenzhen Huafurui Technology Co., Ltd.  
For  
Smart Phone  
Model No.: KINGKONG 3**

**FCC ID: 2AHZ5KINGKONG3**

**Prepared for :** Shenzhen Huafurui Technology Co., Ltd.  
Unit 1401 &1402, 14/F, Jin qi zhi gu mansion (No. 4 building of Chong wen Garden),  
Crossing of the Liu xian street and Tang ling road, Tao yuan street, Nan shan district,  
Shenzhen,P.R. China

**Prepared By :** Shenzhen HUAKE Testing Technology Co., Ltd.  
1F, B2 Building, Junfeng Zhongcheng Zhizao Innovation Park, Fuhai Street, Bao'an  
District, Shenzhen City, China

**Date of Test:** Aug. 24, 2018~Sep. 26, 2018

**Date of Report:** Oct. 15, 2018

**Report Number:** HK1809111023E



### TEST RESULT CERTIFICATION

**Applicant's name** ..... : Shenzhen Huafurui Technology Co., Ltd.  
Unit 1401 &1402, 14/F, Jin qi zhi gu mansion (No. 4 building of Chong  
wen Garden), Crossing of the Liu xian street and Tang ling road, Tao  
Address ..... : yuan street, Nan shan district, Shenzhen,P.R. China

**Manufacture's Name**..... : Shenzhen Huafurui Technology Co., Ltd.  
Unit 1401 &1402, 14/F, Jin qi zhi gu mansion (No. 4 building of Chong  
wen Garden), Crossing of the Liu xian street and Tang ling road, Tao  
Address ..... : yuan street, Nan shan district, Shenzhen,P.R. China

**Product description** : Smart Phone  
Brand Name : CUBOT  
Mode Name : KINGKONG 3  
FCC Rules and Regulations Part 15 Subpart C Section 15.247

**Standards** ..... : ANSI C63.10: 2013

This publication may be reproduced in whole or in part for non-commercial purposes as long as the Shenzhen HUAK Testing Technology Co., Ltd. is acknowledged as copyright owner and source of the material. Shenzhen HUAK Testing Technology Co., Ltd. takes no responsibility for and will not assume liability for damages resulting from the reader's interpretation of the reproduced material due to its placement and context.

**Date of Test** ..... :  
Date (s) of performance of tests ..... : **Aug. 24, 2018~Sep. 26, 2018**  
Date of Issue..... : **Oct. 15, 2018**  
Test Result..... : **Pass**

Testing Engineer :   
\_\_\_\_\_  
(Gary Qian)

Technical Manager :   
\_\_\_\_\_  
(Eden Hu)

Authorized Signatory :   
\_\_\_\_\_  
(Jason Zhou)



Revision	Issue Date	Revisions	Revised By
V1.0	Sep. 26, 2018	Initial Issue	Jason Zhou
V1.1	Oct. 15, 2018	Revise Report	Jason Zhou



## TABLE OF CONTENTS

<b>1. VERIFICATION OF CONFORMITY</b> .....	<b>6</b>
1.1. PRODUCT DESCRIPTION .....	6
1.2. TABLE OF CARRIER FREQUENCIES .....	7
1.3. RECEIVER INPUT BANDWIDTH .....	8
1.4. EXAMPLE OF A HOPPING SEQUENCY IN DATA MODE .....	8
1.5. EQUALLY AVERAGE USE OF FREQUENCIES AND BEHAVIOUR .....	8
1.6. RELATED SUBMITTAL(S) / GRANT (S) .....	9
1.7. TEST METHODOLOGY .....	9
1.8. SPECIAL ACCESSORIES .....	9
1.9. EQUIPMENT MODIFICATIONS.....	9
<b>2. MEASUREMENT UNCERTAINTY</b> .....	<b>10</b>
<b>3. DESCRIPTION OF TEST MODES</b> .....	<b>11</b>
<b>4. SYSTEM TEST CONFIGURATION</b> .....	<b>12</b>
4.1. CONFIGURATION OF EUT SYSTEM.....	12
4.2. EQUIPMENT USED IN EUT SYSTEM.....	12
4.3. SUMMARY OF TEST RESULTS .....	12
<b>5. TEST FACILITY</b> .....	<b>13</b>
<b>6. PEAK OUTPUT POWER</b> .....	<b>14</b>
6.1. MEASUREMENT PROCEDURE .....	14
6.2. TEST SET-UP (BLOCK DIAGRAM OF CONFIGURATION) .....	14
6.3. LIMITS AND MEASUREMENT RESULT .....	15
<b>7. 20DB BANDWIDTH</b> .....	<b>18</b>
8.1. MEASUREMENT PROCEDURE .....	18
7.2. TEST SET-UP (BLOCK DIAGRAM OF CONFIGURATION) .....	18
7.3. LIMITS AND MEASUREMENT RESULTS .....	18
<b>8. CONDUCTED SPURIOUS EMISSION</b> .....	<b>21</b>
8.1. MEASUREMENT PROCEDURE .....	21
8.2. TEST SET-UP (BLOCK DIAGRAM OF CONFIGURATION) .....	21
8.3. MEASUREMENT EQUIPMENT USED .....	22
8.4. LIMITS AND MEASUREMENT RESULT .....	22
<b>9. RADIATED EMISSION</b> .....	<b>28</b>
9.1. MEASUREMENT PROCEDURE .....	28
9.2. TEST SETUP.....	29
9.3. LIMITS AND MEASUREMENT RESULT .....	30
9.4. TEST RESULT.....	31



- 10. BAND EDGE EMISSION ..... 34**
  - 10.1. MEASUREMENT PROCEDURE ..... 34
  - 10.2. TEST SET-UP ..... 34
  - 10.3. RADIATED TEST RESULT ..... 35
  - 10.4 CONDUCTED TEST RESULT ..... 36
- 11. NUMBER OF HOPPING FREQUENCY ..... 38**
  - 11.1. MEASUREMENT PROCEDURE ..... 38
  - 11.2. TEST SETUP (BLOCK DIAGRAM OF CONFIGURATION) ..... 38
  - 11.3. MEASUREMENT EQUIPMENT USED ..... 38
  - 11.4. LIMITS AND MEASUREMENT RESULT ..... 38
- 12. TIME OF OCCUPANCY (DWELL TIME)..... 39**
  - 12.1. MEASUREMENT PROCEDURE ..... 39
  - 12.2. TEST SETUP (BLOCK DIAGRAM OF CONFIGURATION) ..... 39
  - 12.3. MEASUREMENT EQUIPMENT USED ..... 39
  - 12.4. LIMITS AND MEASUREMENT RESULT ..... 40
- 13. FREQUENCY SEPARATION ..... 41**
  - 13.1. MEASUREMENT PROCEDURE ..... 41
  - 13.2. TEST SETUP (BLOCK DIAGRAM OF CONFIGURATION) ..... 41
  - 13.3. MEASUREMENT EQUIPMENT USED ..... 41
  - 13.4. LIMITS AND MEASUREMENT RESULT ..... 41
- 14. FCC LINE CONDUCTED EMISSION TEST ..... 42**
  - 15.1. LIMITS OF LINE CONDUCTED EMISSION TEST ..... 42
  - 14.2. BLOCK DIAGRAM OF LINE CONDUCTED EMISSION TEST ..... 42
  - 14.3. PRELIMINARY PROCEDURE OF LINE CONDUCTED EMISSION TEST ..... 43
  - 14.4. FINAL PROCEDURE OF LINE CONDUCTED EMISSION TEST ..... 43
  - 14.5. TEST RESULT OF LINE CONDUCTED EMISSION TEST ..... 44
- APPENDIX A: PHOTOGRAPHS OF TEST SETUP ..... 46**



## 1. VERIFICATION OF CONFORMITY

### 1.1. PRODUCT DESCRIPTION

Equipment	Smart Phone
Model Name	KINGKONG 3
Hardware Version	A756_MAIN_PCB_V1.2
Software Version	CUBOT_KING_KONG_3_8091C_V04+20180816
FCC ID	HK1809111022E
Antenna Type	PIFA Antenna
Antenna Gain	1.0dBi
BT Operation frequency	2.402 GHz to 2.480GHz
Number of Channels	79(For BR/EDR)
Modulation Type	GFSK, $\pi/4$ -DQPSK, 8DPSK
Power Supply	DC3.85V by Battery

**1.2. TABLE OF CARRIER FREQUENCIES**

Frequency Band	Channel Number	Frequency
2400~2483.5MHZ	0	2402MHZ
	1	2403MHZ
	:	:
	38	2440 MHZ
	39	2441 MHZ
	40	2442 MHZ
	:	:
	77	2479 MHZ
	78	2480 MHZ



### 1.3. RECEIVER INPUT BANDWIDTH

The input bandwidth of the receiver is 1.3MHz. In every connection one Bluetooth device is the master and the other one is slave. The master determines the hopping sequence. The slave follows this sequence. Both devices shift between RX and TX time slot according to the clock of the master. Additionally the type of connection (e.g. single or multislotted packet) is set up at the beginning of the connection. The master adapts its hopping frequency and its TX/RX timing according to the packet type of the connection. Also the slave of the connection will use these settings.

Repeating of a packet has no influence on the hopping sequence. The hopping sequence generated by the master of the connection will be followed in any case. That means, a repeated packet will not be sent on the same frequency, it is sent on the next frequency of the hopping sequence.

### 1.4. EXAMPLE OF A HOPPING SEQUENCE IN DATA MODE

Example of a 79 hopping sequence in data mode:

40,21,44,23,42,53,46,55,48,33,52,35,50,65,54,67  
56,37,60,39,58,69,62,71,64,25,68,27,66,57,70,59  
72,29,76,31,74,61,78,63,01,41,05,43,03,73,07,75  
09,45,13,47,11,77,15,00,64,49,66,53,68,02,70,06  
01, 51, 03, 55, 05, 04

### 1.5. EQUALLY AVERAGE USE OF FREQUENCIES AND BEHAVIOUR

The generation of the hopping sequence in connection mode depends essentially on two input values:

1. LAP/UAP of the master of the connection.
2. Internal master clock

The LAP (lower address part) are the 24 LSB's of the 48 BD\_ADDRESS. The BD\_ADDRESS is an unambiguous number of every Bluetooth unit. The UAP (upper address part) are the 24 MSB's of the 48BD\_ADDRESS

The internal clock of a Bluetooth unit is derived from a free running clock which is never adjusted and is never turned off. For synchronization with other units only offsets are used. It has no relation to the time of the day. Its resolution is at least half the RX/TX slot length of 312.5µs. The clock has a cycle of about one day (23h30). In most cases it is implemented as 28-bit counter. For the deriving of the hopping sequence the entire LAP (24 bits), 4 LSB's (4 bits) (Input 1) and the 27 MSB's of the clock (Input 2) are used. With these input values different mathematical procedures (permutations, additions, XOR-operations) are performed to generate the sequence. This will be done at the beginning of every new transmission.

Regarding short transmissions the Bluetooth system has the following behavior:

The first connection between the two devices is established, a hopping sequence was generated. For transmitting the wanted data the complete hopping sequence was not used. The connection ended.

The second connection will be established. A new hopping sequence is generated. Due to the fact the Bluetooth clock has a different value, because the period between the two transmissions is longer (and it cannot be shorter) than the minimum resolution of the clock (312.5µs). The hopping sequence will always differ from the first one.





#### **1.6. RELATED SUBMITTAL(S) / GRANT (S)**

This submittal(s) (test report) is intended for **FCC ID: 2AHZ5KINGKONG3** filing to comply with Section 15.247 of the FCC Part 15, Subpart C Rules.

#### **1.7. TEST METHODOLOGY**

Both conducted and radiated testing was performed according to the procedures in ANSI C63.10 (2013). Radiated testing was performed at an antenna to EUT distance 3 meters.

#### **1.8. SPECIAL ACCESSORIES**

Refer to section 5.2.

#### **1.9. EQUIPMENT MODIFICATIONS**

Not available for this EUT intended for grant.



## 2. MEASUREMENT UNCERTAINTY

Test	Measurement Uncertainty	Notes
Transmitter power conducted	$\pm 0.57$ dB	(1)
Transmitter power Radiated	$\pm 2.20$ dB	(1)
Conducted spurious emission 9KHz-40 GHz	$\pm 2.20$ dB	(1)
Occupied Bandwidth	$\pm 0.01$ ppm	(1)
Radiated Emission 30~1000MHz	$\pm 4.10$ dB	(1)
Radiated Emission Above 1GHz	$\pm 4.32$ dB	(1)
Conducted Disturbance 0.15~30MHz	$\pm 3.20$ dB	(1)

Note: This uncertainty represents an expanded uncertainty expressed at approximately the 95% confidence level using a coverage factor of  $k=2$ .



### 3. DESCRIPTION OF TEST MODES

NO.	TEST MODE DESCRIPTION
1	Low channel GFSK
2	Middle channel GFSK
3	High channel GFSK
4	Low channel $\pi/4$ -DQPSK
5	Middle channel $\pi/4$ -DQPSK
6	High channel $\pi/4$ -DQPSK
7	Low channel 8DPSK
8	Middle channel 8DPSK
9	High channel 8DPSK
10	Normal Hopping

Note:

1. All the test modes can be supply by Built-in Li-ion battery, only the result of the worst case was recorded in the report, if no other cases.
2. For Radiated Emission, 3axis were chosen for testing for each applicable mode.



## 4. SYSTEM TEST CONFIGURATION

### 4.1. CONFIGURATION OF EUT SYSTEM

Configuration:

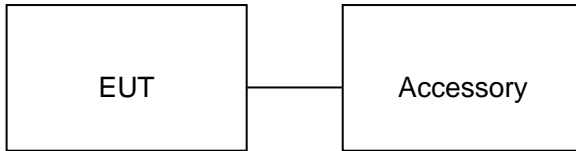

### 4.2. EQUIPMENT USED IN EUT SYSTEM

Item	Equipment	Model No.	ID or Specification	Remark
1	Smart Phone	KINGKONG 3	2AHZ5KINGKONG3	EUT
2	Adapter	KINGKONG 3	DC 9.0V 2A	Accessory
3	Battery	KINGKONG 3	DC3.85V/ 6000mAh	Accessory
4	USB	N/A	N/A	Accessory

### 4.3. SUMMARY OF TEST RESULTS

FCC RULES	DESCRIPTION OF TEST	RESULT
§15.247	Peak Output Power	Compliant
§15.247	20 dB Bandwidth	Compliant
§15.247	Spurious Emission	Compliant
§15.209	Radiated Emission	Compliant
§15.247	Band Edges	Compliant
§15.207	Power Line Conduction Emission	Compliant
§15.247	Number of Hopping Frequency	Compliant
§15.247	Time of Occupancy	Compliant
§15.247	Frequency Separation	Compliant



## 5. TEST FACILITY

<b>Site</b>	Shenzhen HUAKE Testing Technology Co., Ltd.
<b>Location</b>	1F, B2 Building, Junfeng Zhongcheng Zhizao Innovation Park, Fuhai Street, Bao'an District, Shenzhen City, China
<b>Designation Number</b>	CN1229
Test Firm Registration Number : 616276	

### ALL TEST EQUIPMENT LIST

RF Test Room				
Equipment	Manufacturer	Model	Serial Number	Calibration Due
Power meter	Agilent	E4417B	HKE-107	Dec. 28, 2018
Power Sensor	Agilent	E9327A	HKE-113	Dec. 28, 2018
RF cable	Times	1-40G	HKE-034	Dec. 28, 2018
RF automatic control unit	Tonscend	JS0806-2	HKE-060	Dec. 28, 2018
Spectrum analyzer	Agilent	N9020A	HKE-048	Dec. 28, 2018
RF Cable (9KHz-26.5GHz)	Tonscend	170660	N/A	Dec. 28, 2018
Signal generator	Agilent	N5183A	HKE-071	Dec. 28, 2018
Receiver	R&S	ESCI-7	HKE-010	Dec. 28, 2018
Spectrum analyzer	Agilent	N9020A	HKE-048	Dec. 28, 2018
Preamplifier	EMCI	EMC051845SE	HKE-015	Dec. 28, 2018
Preamplifier	Agilent	83051A	HKE-016	Dec. 28, 2018
Loop antenna	Schwarzbeck	FMZB 1519 B	HKE-014	Dec. 28, 2018
Broadband antenna	Schwarzbeck	VULB 9163	HKE-012	Dec. 28, 2018
Horn antenna	Schwarzbeck	9120D	HKE-013	Dec. 28, 2018
Antenna Mast	Keleto	CC-A-4M	N/A	N/A
Position controller	Taiwan MF	MF7802	HKE-011	Dec. 28, 2018
Radiated test software	Tonscend	TS+ Rev 2.5.0.0	HKE-082	N/A
RF cable (9KHz-1GHz)	Times	381806-001	N/A	N/A
RF cable	Times	1-40G	HKE-034	Dec. 28, 2018



## 6. PEAK OUTPUT POWER

### 6.1. MEASUREMENT PROCEDURE

For peak power test:

1. Connect EUT RF output port to the Spectrum Analyzer through an RF attenuator
2. Set the EUT Work on the top, middle and the bottom operation frequency individually.
3. Use the following spectrum analyzer settings:
  - 1) Span : Approximately five times the 20 dB bandwidth, centered on a hopping channel.
  - 2) RBW > 20 dB bandwidth of the emission being measured.
  - 3) VBW  $\geq$  RBW.
  - 4) Sweep: Auto.
  - 5) Detector function: Peak.
  - 6) Trace: Max hold.
4. Record the maximum power from the Spectrum Analyzer.

**Note :** The EUT was tested according for compliance ANSI C63.10 (2013) requirements.

### 6.2. TEST SET-UP (BLOCK DIAGRAM OF CONFIGURATION)

#### PEAK POWER TEST SETUP

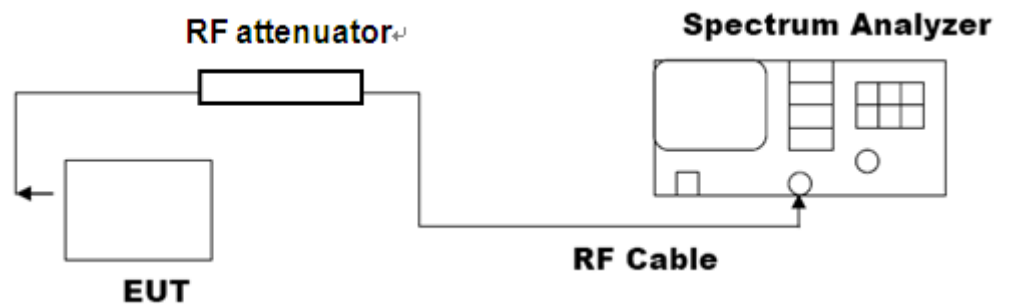

**6.3. LIMITS AND MEASUREMENT RESULT**

Mode	Frequency (GHz)	Peak Power (dBm)	Applicable Limits (dBm)	Pass or Fail
GFSK	2.402	-0.061	30	Pass
	2.441	-0.590	30	Pass
	2.480	-2.153	30	Pass

Mode	Frequency (GHz)	Peak Power (dBm)	Applicable Limits (dBm)	Pass or Fail
$\pi$ /4-DQPSK	2.402	-1.537	30	Pass
	2.441	-1.676	30	Pass
	2.480	-3.202	30	Pass

Mode	Frequency (GHz)	Peak Power (dBm)	Applicable Limits (dBm)	Pass or Fail
8DPSK	2.402	-1.605	30	Pass
	2.441	-1.729	30	Pass
	2.480	-3.096	30	Pass



### Test Graph

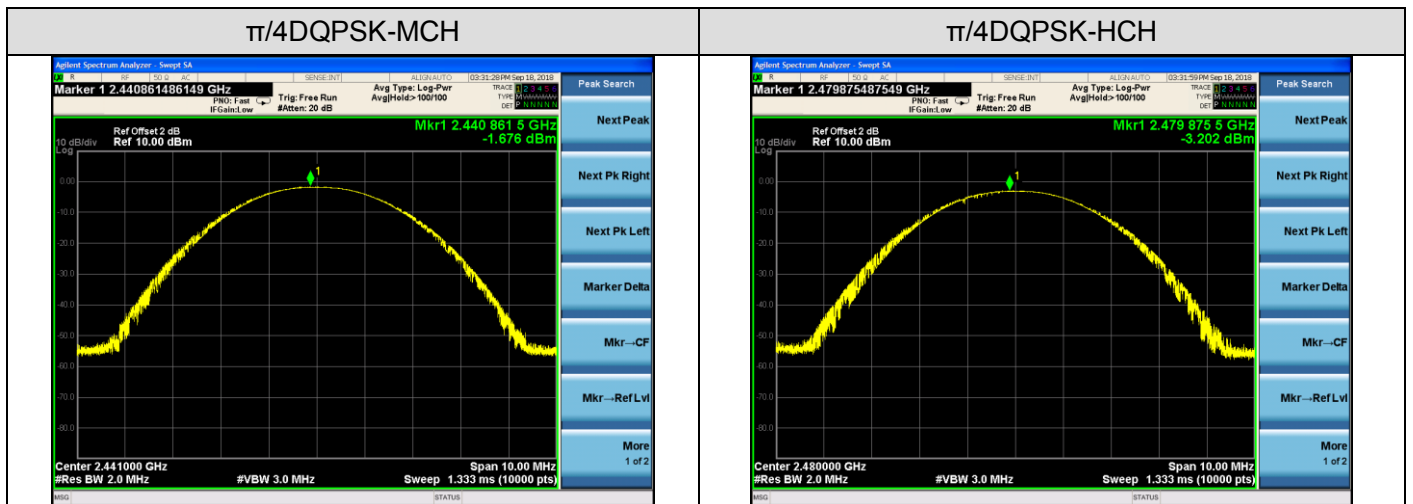
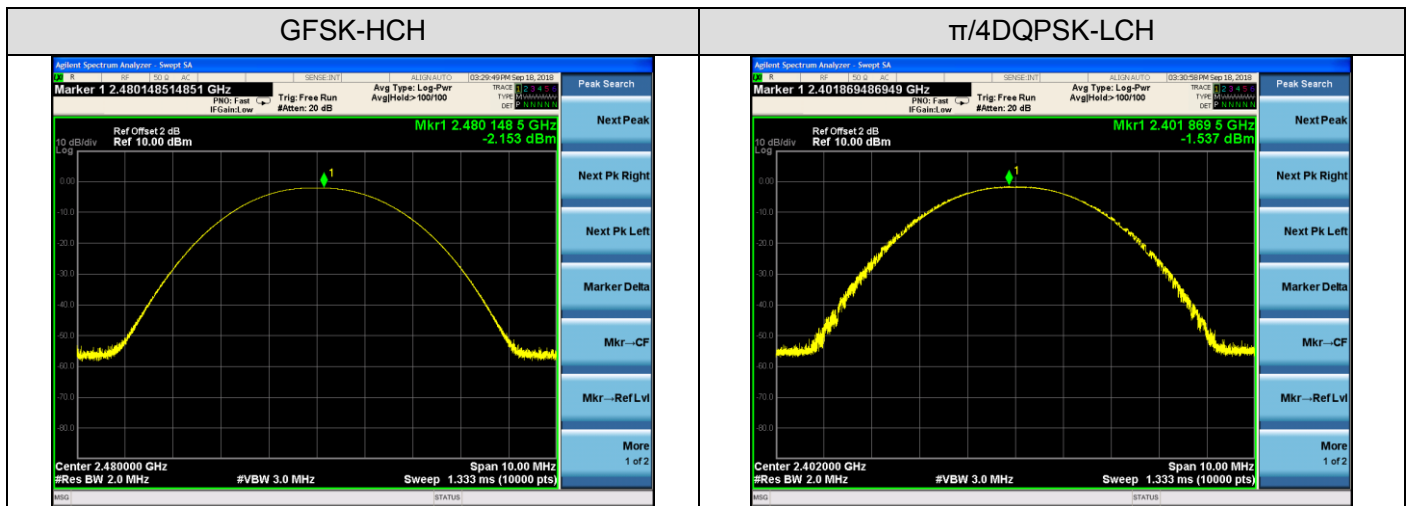
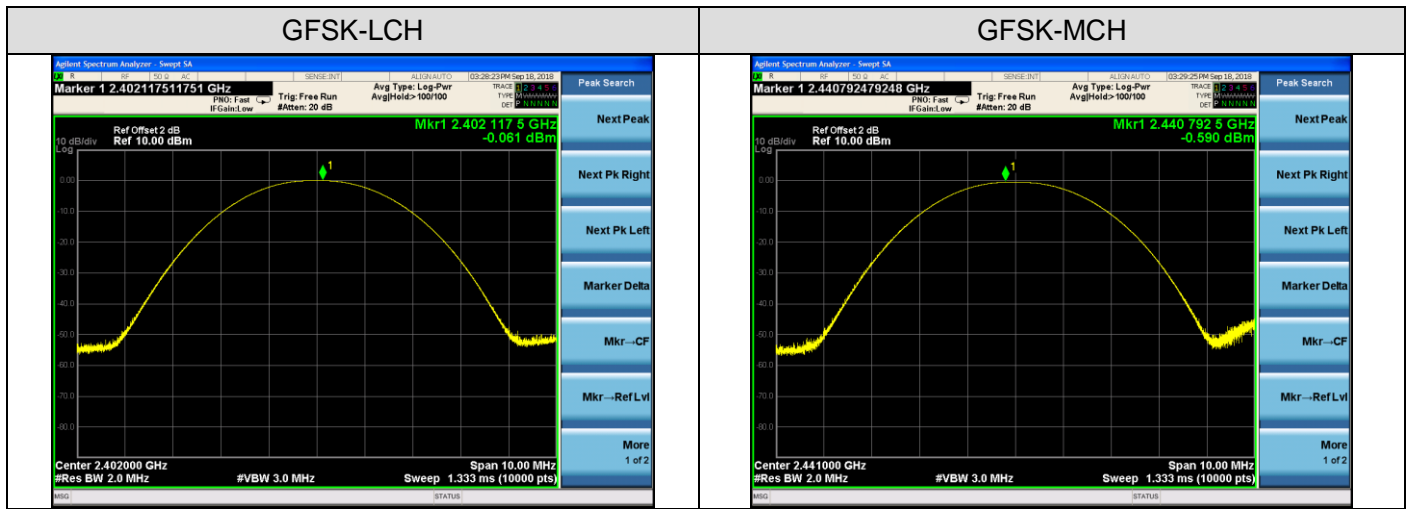





### 8DPSK-LCH

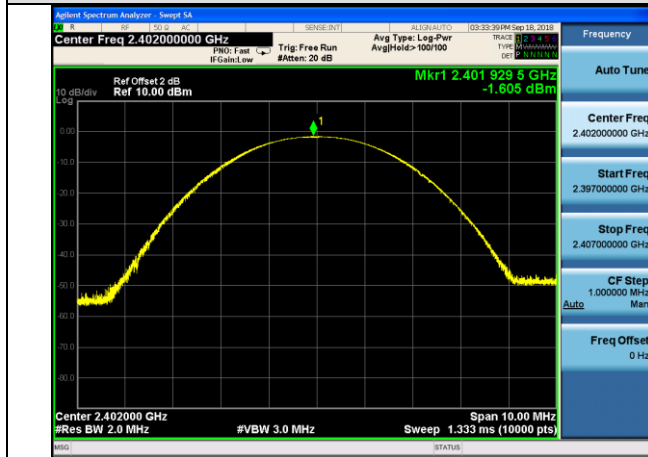

### 8DPSK-MCH

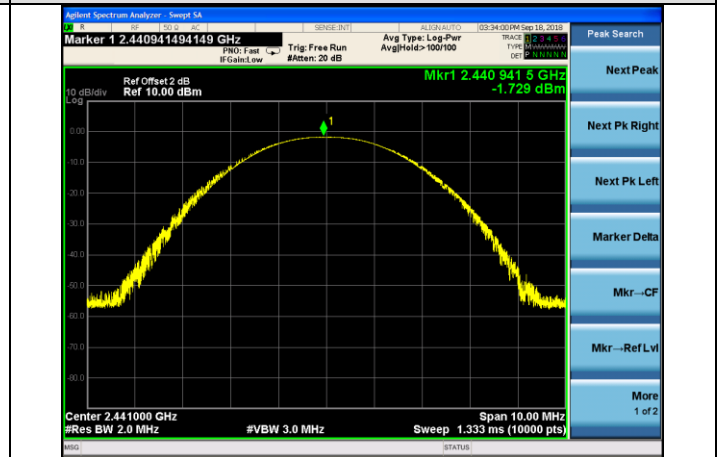

### 8DPSK-HCH

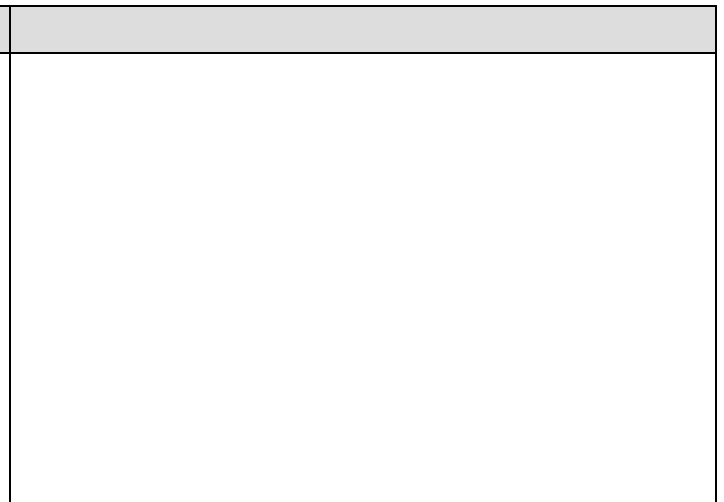
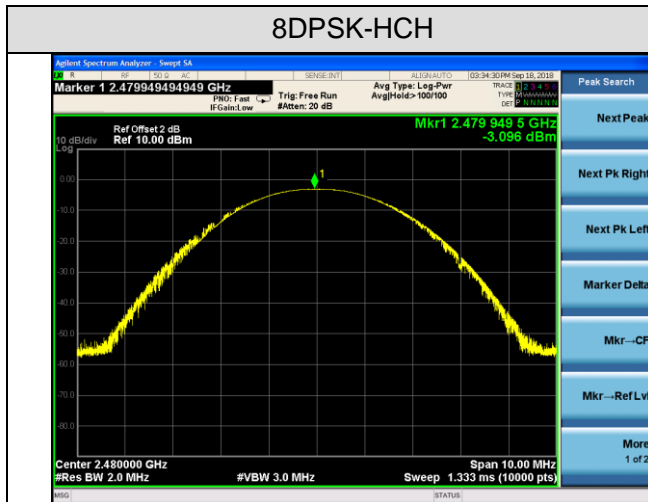



## 7. 20DB BANDWIDTH

### 8.1. MEASUREMENT PROCEDURE

1. Connect EUT RF output port to the Spectrum Analyzer through an RF attenuator
2. Set the EUT Work on the top, the middle and the bottom operation frequency individually.
3. Set Span = approximately 2 to 3 times the 20 dB bandwidth, centered on a hopping channel  
RBW  $\geq$  1% of the 20 dB bandwidth, VBW  $\geq$  RBW; Sweep = auto; Detector function = peak
4. Set SPA Trace 1 Max hold, then View.

### 7.2. TEST SET-UP (BLOCK DIAGRAM OF CONFIGURATION)

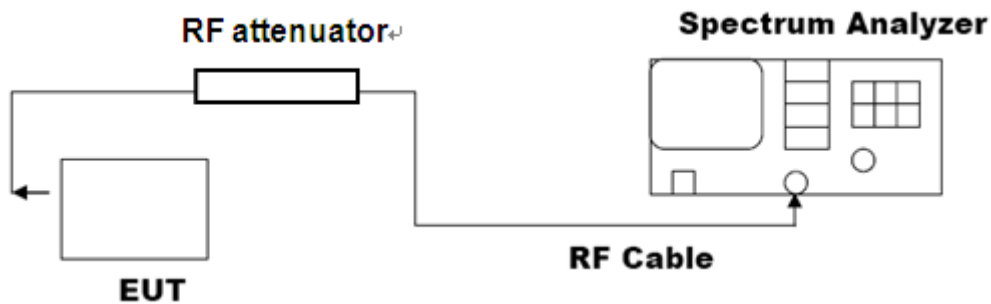

### 7.3. LIMITS AND MEASUREMENT RESULTS

Mode	Channel.	20dB Bandwidth [KHz]	Verdict
GFSK	LCH	820.2	PASS
GFSK	MCH	826.5	PASS
GFSK	HCH	829.3	PASS
$\pi/4$ DQPSK	LCH	1.130	PASS
$\pi/4$ DQPSK	MCH	1.129	PASS
$\pi/4$ DQPSK	HCH	1.126	PASS
8DPSK	LCH	1.149	PASS
8DPSK	MCH	1.125	PASS
8DPSK	HCH	1.112	PASS



### Test Graph

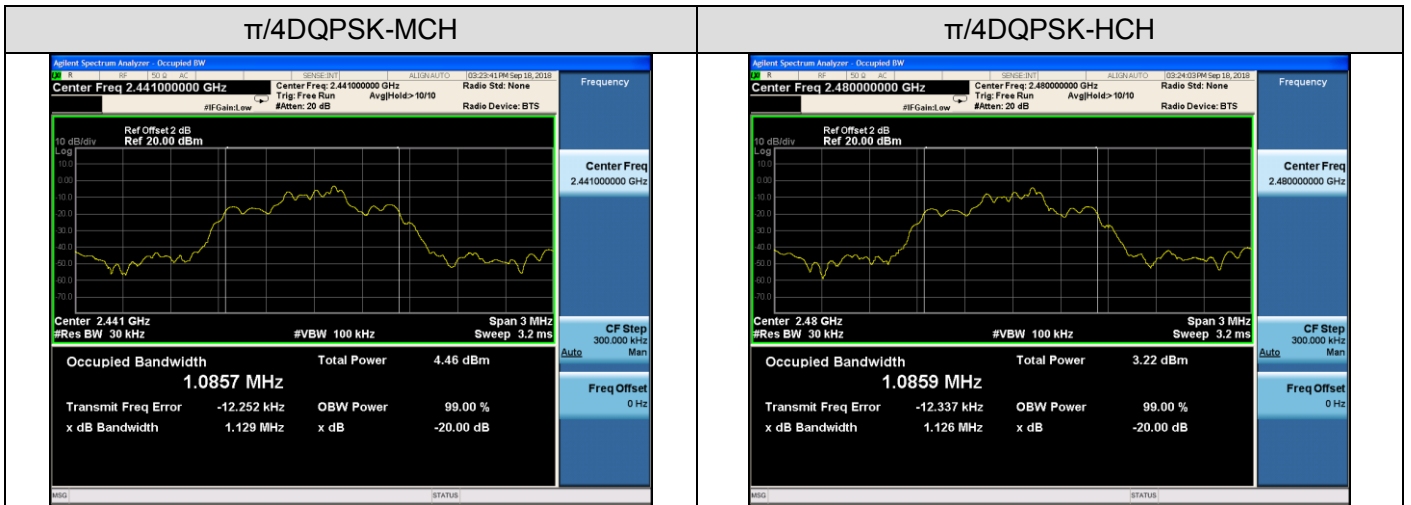
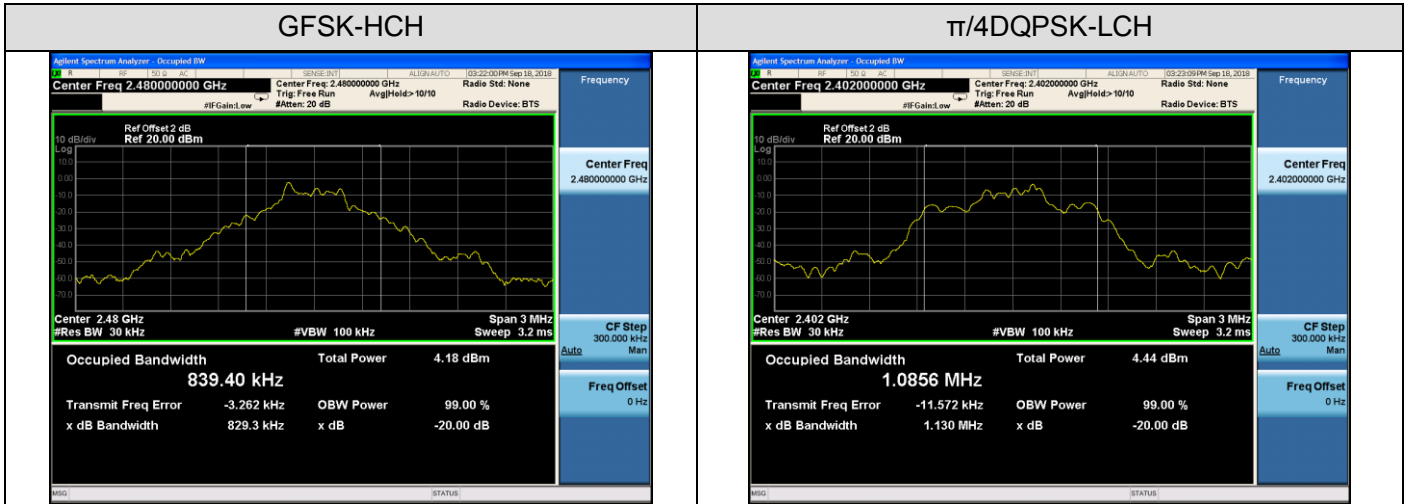
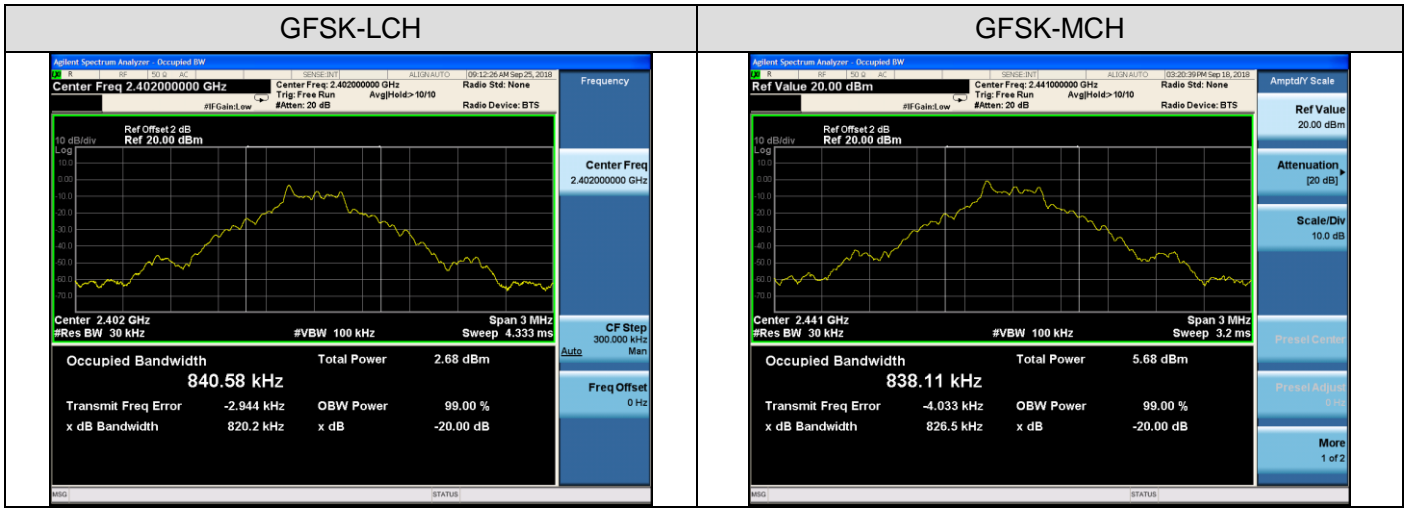



### 8DPSK-LCH

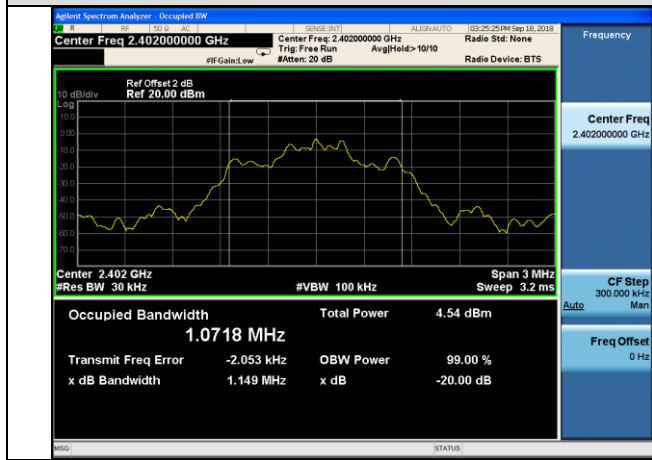

### 8DPSK-MCH

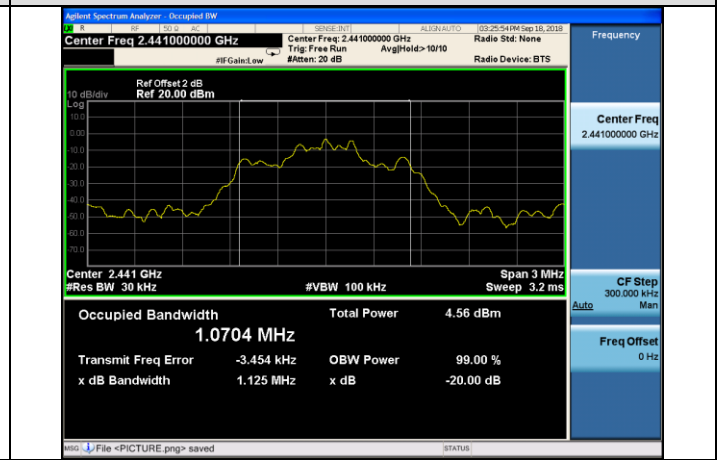

### 8DPSK-HCH

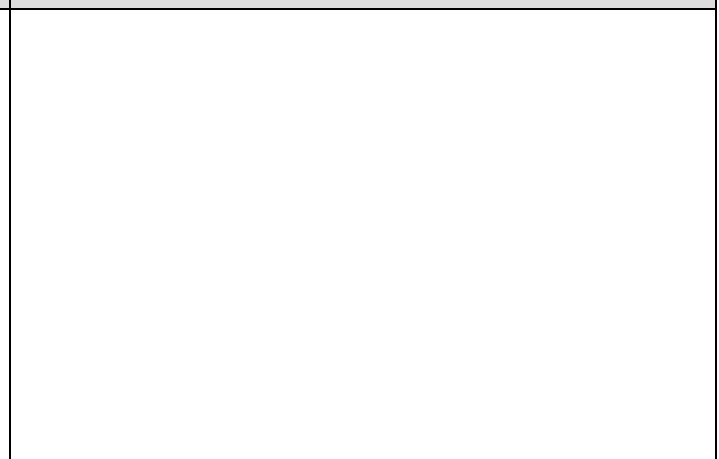
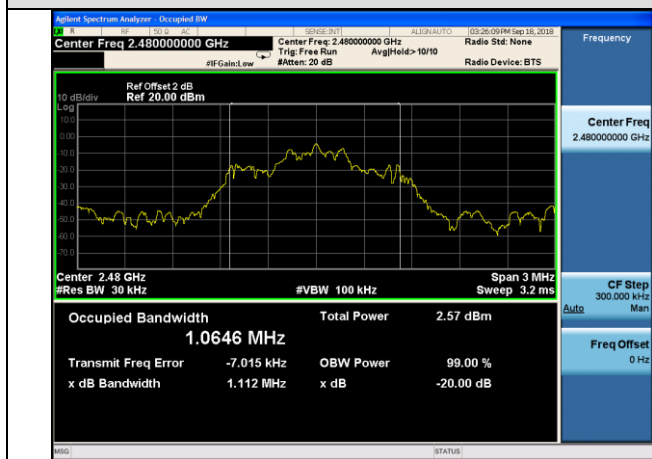



## 8. CONDUCTED SPURIOUS EMISSION

### 8.1. MEASUREMENT PROCEDURE

1. Connect EUT RF output port to the Spectrum Analyzer through an RF attenuator
2. Set the EUT Work on the top, the Middle and the bottom operation frequency individually.
3. Set the Span = wide enough to capture the peak level of the in-band emission and all spurious emissions from the lowest frequency generated in the EUT up through the 10th harmonic.  
RBW = 100 kHz; VBW  $\geq$  RBW; Sweep = auto; Detector function = peak.
4. Set SPA Trace 1 Max hold, then View.

**Note:** The EUT was tested according for compliance ANSI C63.10 (2013) requirements. Owing to satisfy the requirements of the number of measurement points, we set the RBW=1MHz, VBW > RBW, scan up through 10th harmonic, and consider the tested results as the worst case, if the tested results conform to the requirement, we can deem that the real tested results(set the RBW=100KHz, VBW > RBW) are conform to the requirement.

### 8.2. TEST SET-UP (BLOCK DIAGRAM OF CONFIGURATION)

The same as described in section 8.2



### 8.3. MEASUREMENT EQUIPMENT USED

The same as described in section 6

### 8.4. LIMITS AND MEASUREMENT RESULT

LIMITS AND MEASUREMENT RESULT		
Applicable Limits	Measurement Result	
	Test Data	Criteria
<p>In any 100 KHz Bandwidth Outside the frequency band in which the spread spectrum intentional radiator is operating, the radio frequency power that is produce by the intentional radiator shall be at least 20 dB below that in 100KHz bandwidth within the band that contains the highest level of the desired power.</p> <p>In addition, radiation emissions which fall in the restricted bands, as defined in §15.205(a), must also comply with the radiated emission limits specified in§15.209(a)</p>	Refer Test Graph	PASS



### Test Graph

#### GFSK-LCH

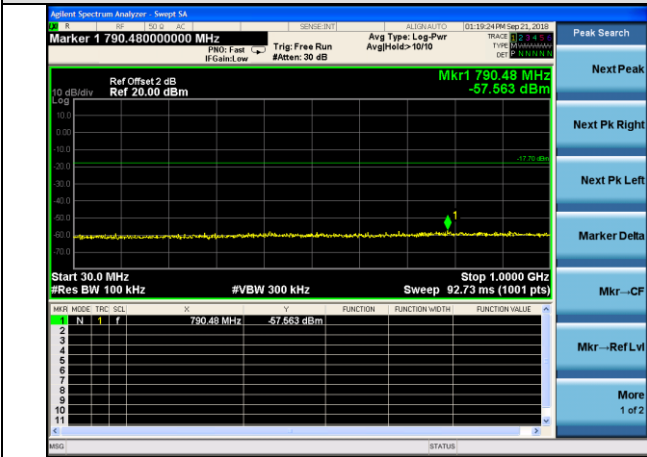

#### GFSK-LCH

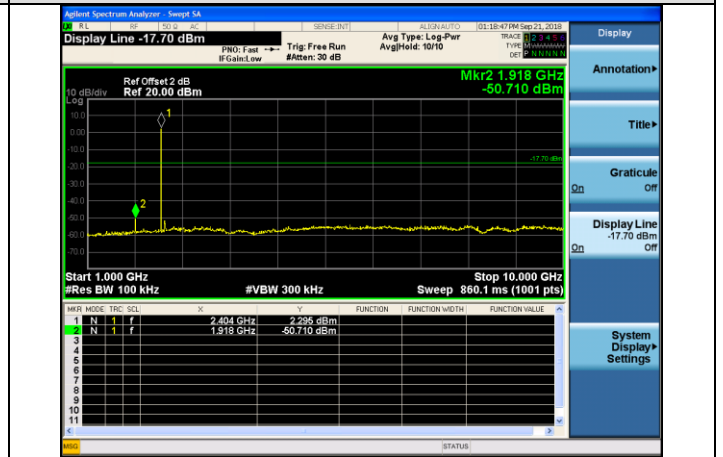

#### GFSK-LCH

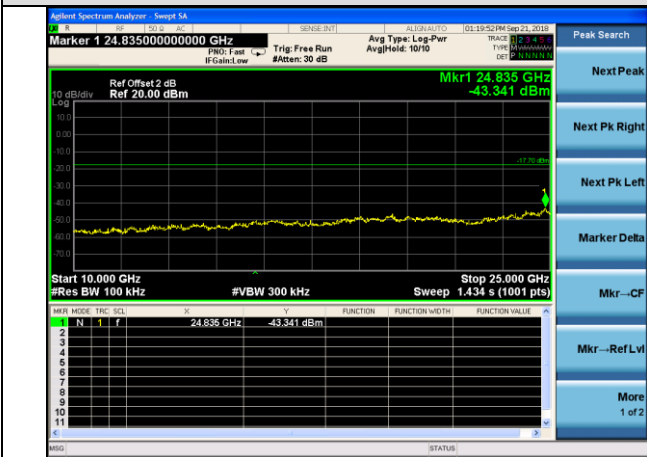

#### GFSK-MCH

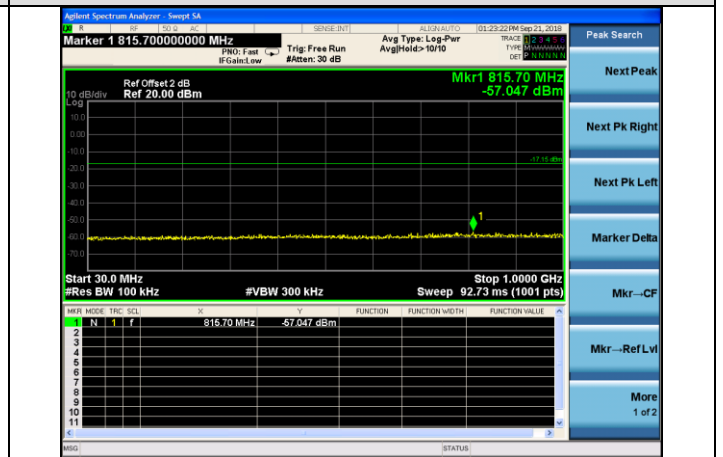

#### GFSK-MCH

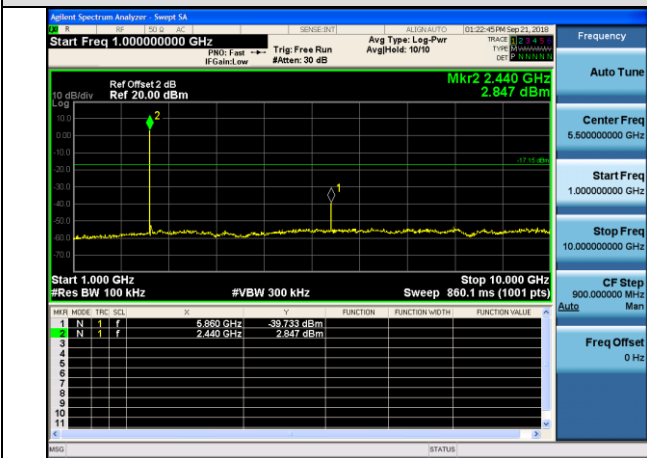

#### GFSK-MCH

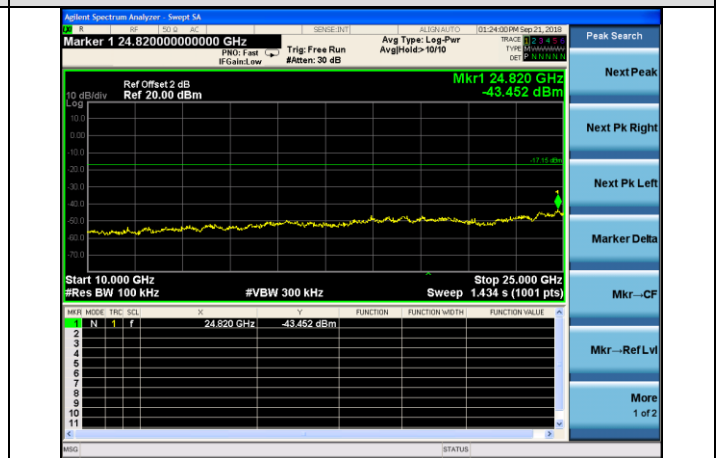



### GFSK-HCH

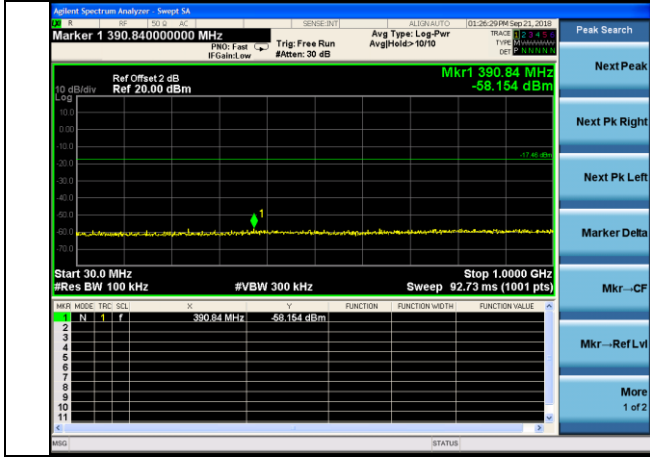

### GFSK-HCH

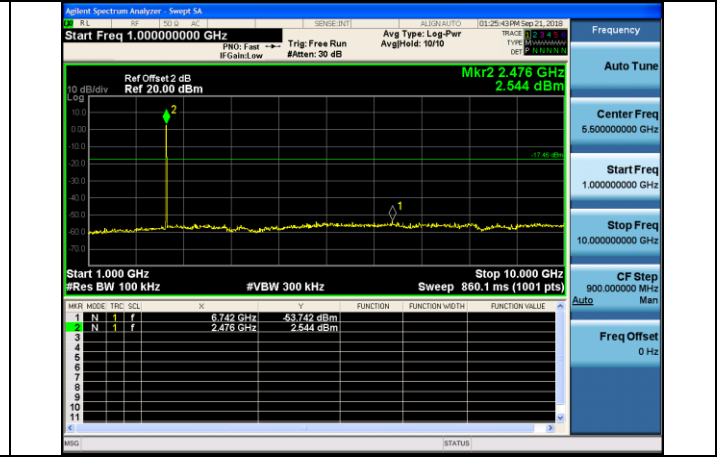

### GFSK-HCH

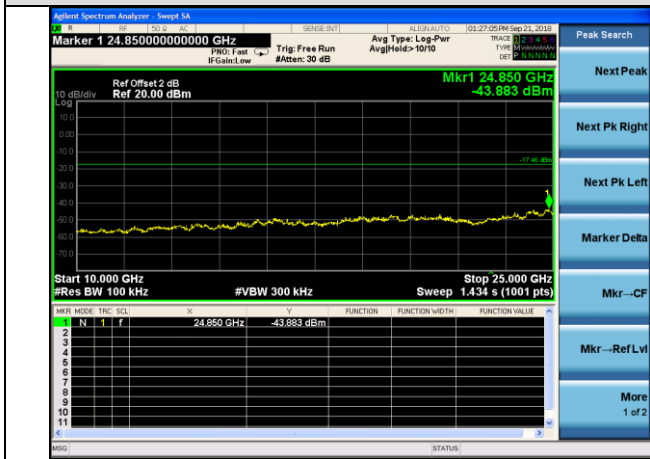

### $\pi/4$ DQPSK-LCH

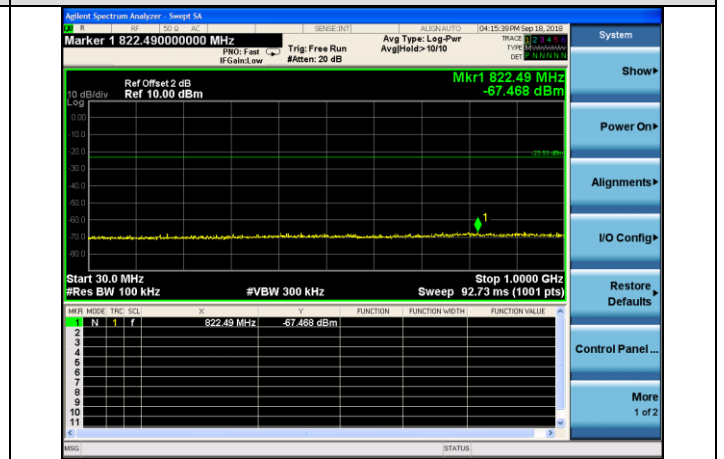

### $\pi/4$ DQPSK-LCH

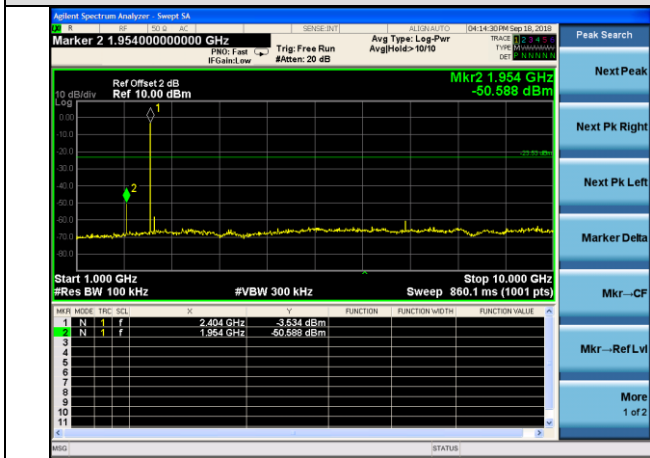

### $\pi/4$ DQPSK-LCH

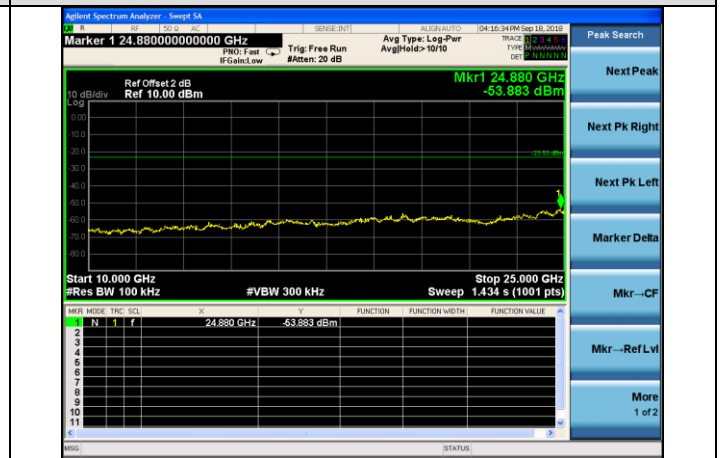





### $\pi/4$ DQPSK-MCH

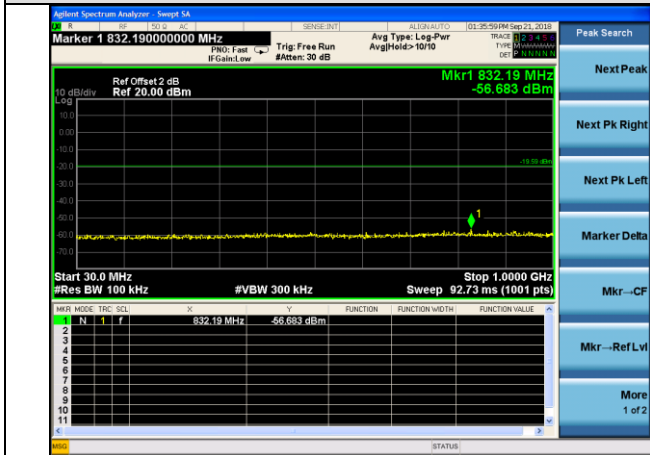

### $\pi/4$ DQPSK-MCH

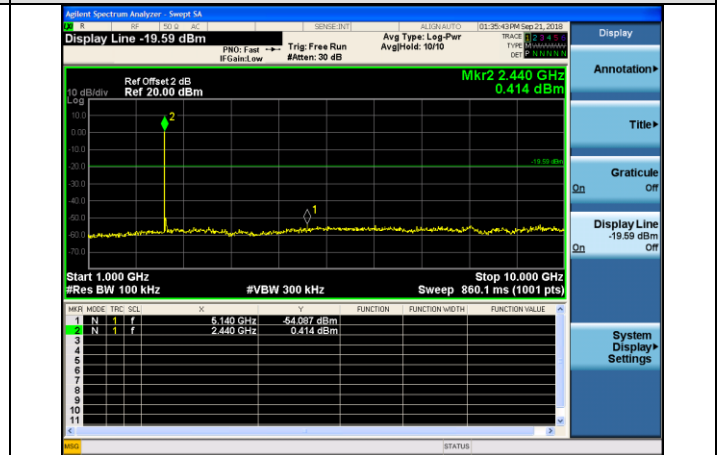

### $\pi/4$ DQPSK-MCH

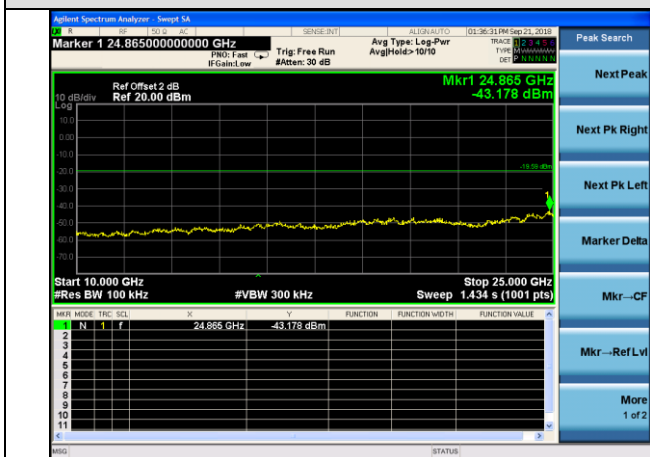

### $\pi/4$ DQPSK-HCH

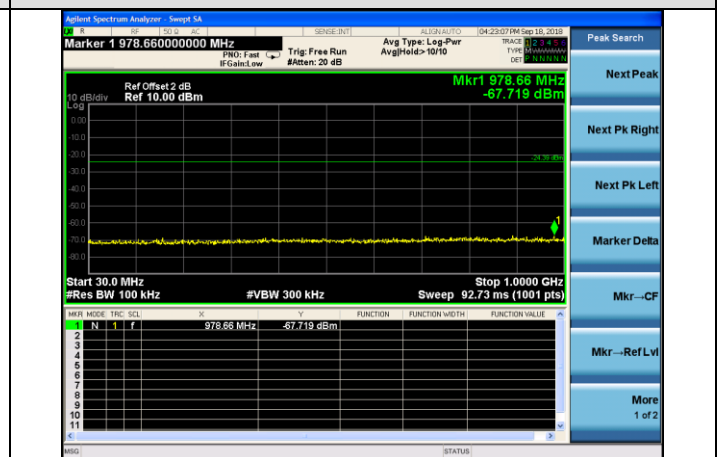

### $\pi/4$ DQPSK-HCH

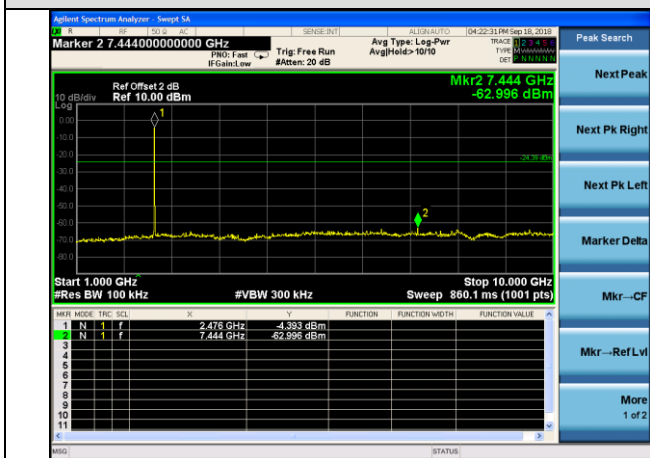

### $\pi/4$ DQPSK-HCH

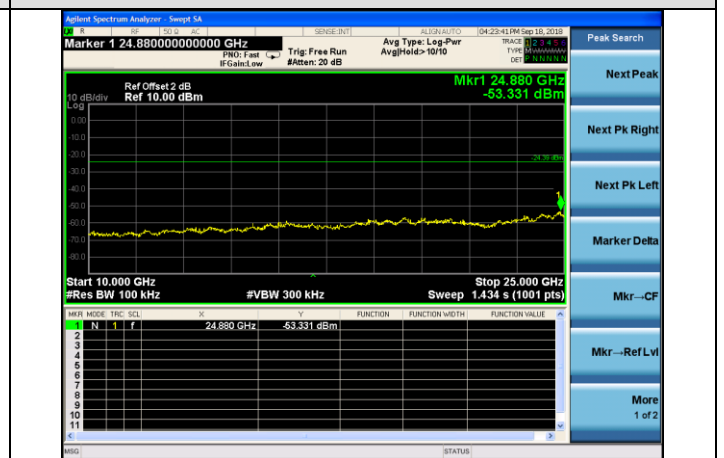



8DPSK-LCH

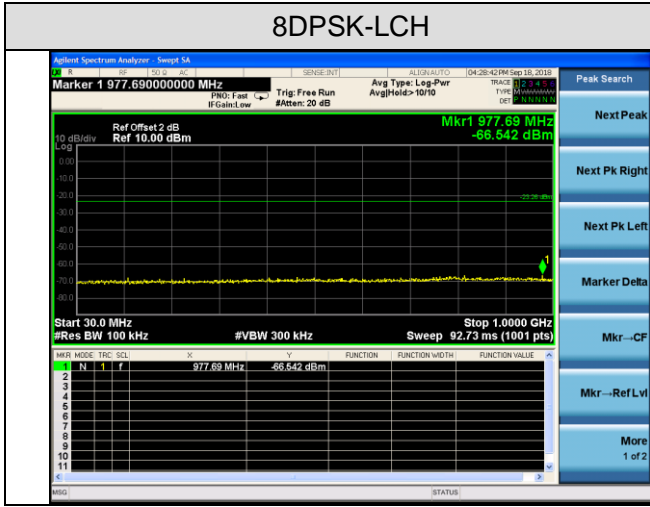

8DPSK-LCH

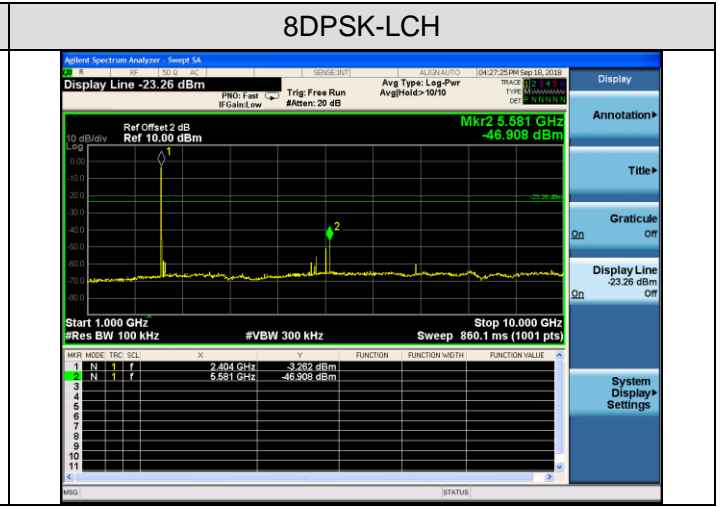

8DPSK-LCH

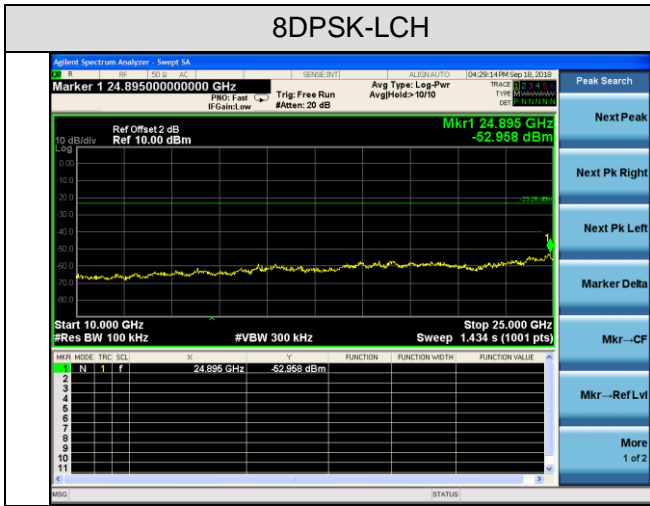

8DPSK-MCH

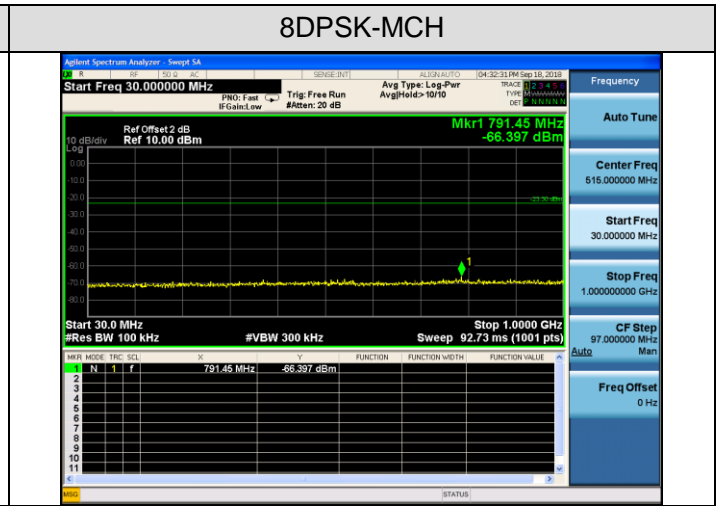

8DPSK-MCH

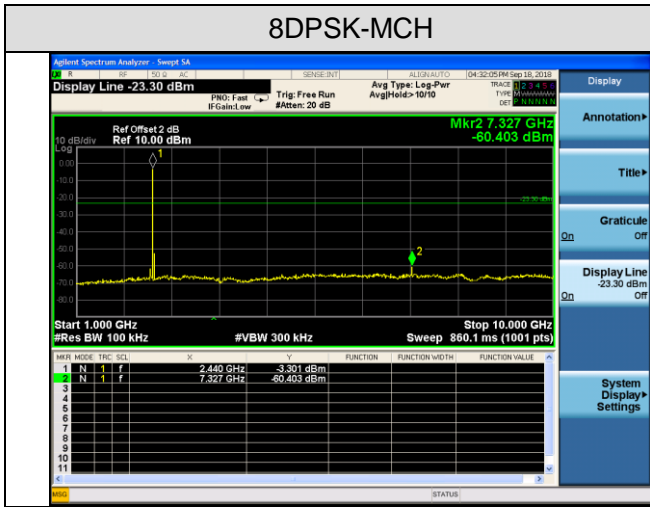

8DPSK-MCH

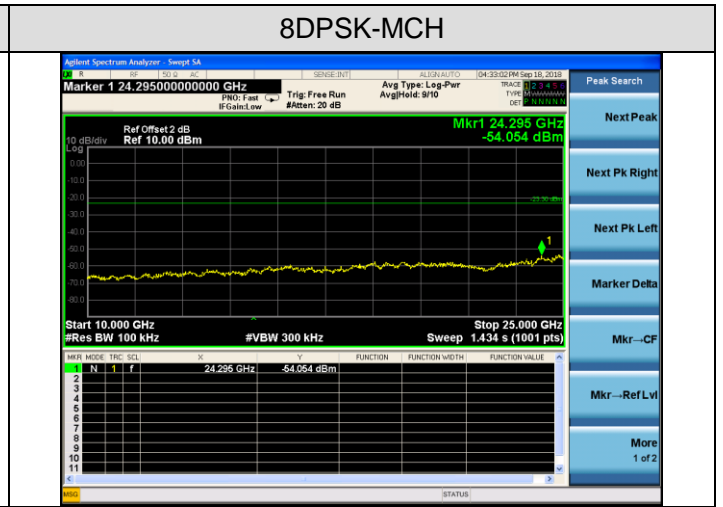



### 8DPSK-HCH

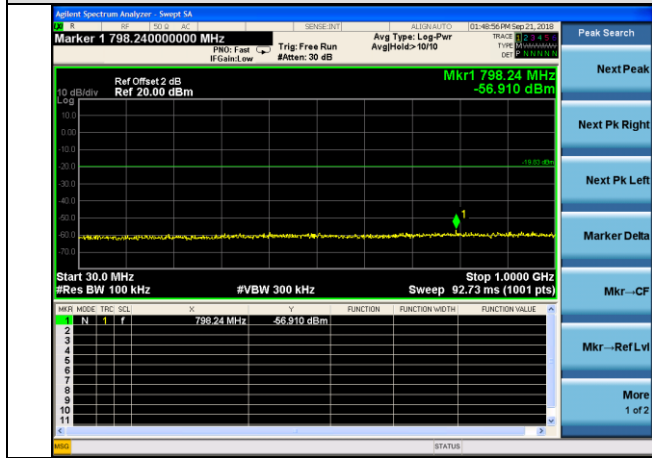

### 8DPSK-HCH

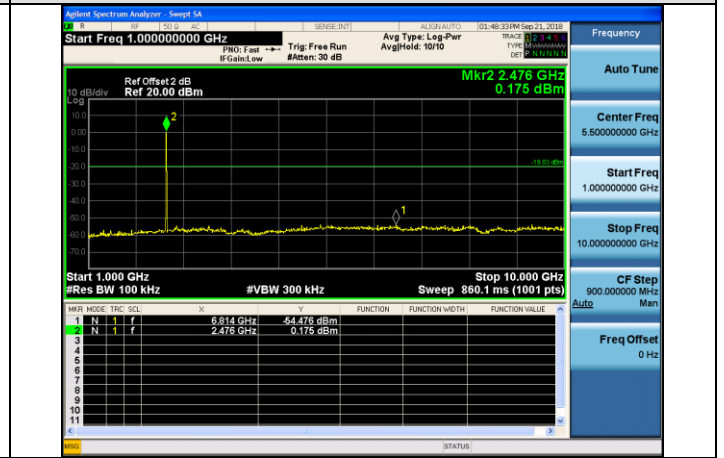

### 8DPSK-HCH

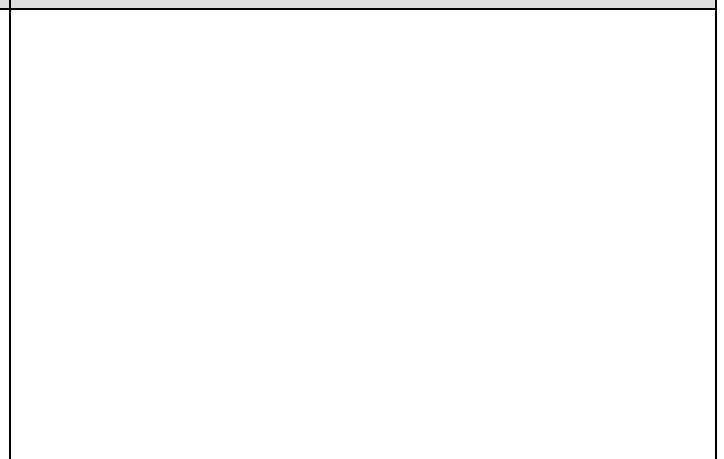
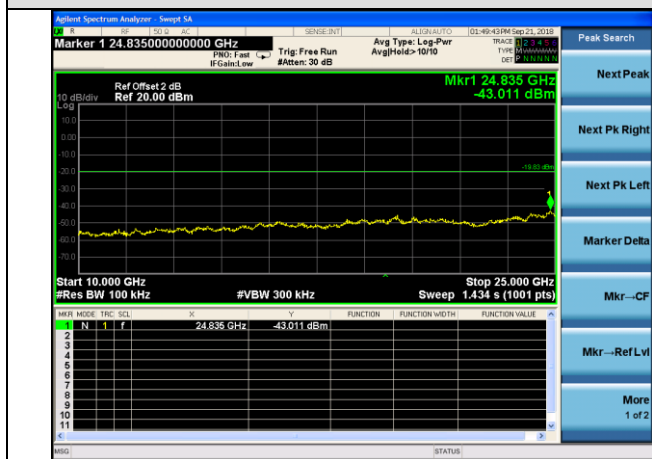



## 9. RADIATED EMISSION

### 9.1. MEASUREMENT PROCEDURE

1. The EUT was placed on the top of the turntable 0.8 or 1.5 meter above ground. The phase center of the receiving antenna mounted on the top of a height-variable antenna tower was placed 3 meters far away from the turntable.
2. Power on the EUT and all the supporting units. The turntable was rotated by 360 degrees to determine the position of the highest radiation.
3. The height of the broadband receiving antenna was varied between one meter and four meters above ground to find the maximum emissions field strength of both horizontal and vertical polarization.
4. For each suspected emissions, the antenna tower was scan (from 1 M to 4 M) and then the turntable was rotated (from 0 degree to 360 degrees) to find the maximum reading.
5. Set the test-receiver system to Peak or CISPR quasi-peak Detect Function with specified bandwidth under Maximum Hold Mode.
6. For emissions above 1GHz, use 1MHz VBW and RBW for peak reading. Then 1MHz RBW and 10Hz VBW for average reading in spectrum analyzer. Place the measurement antenna away from each area of the EUT determined to be a source of emissions at the specified measurement distance, while keeping the measurement antenna aimed at the source of emissions at each frequency of significant emissions, with polarization oriented for maximum response. The measurement antenna may have to be higher or lower than the EUT, depending on the radiation pattern of the emission and staying aimed at the emission source for receiving the maximum signal. The final measurement antenna elevation shall be that which maximizes the emissions. The measurement antenna elevation for maximum emissions shall be restricted to a range of heights of from 1 m to 4 m above the ground or reference ground plane.
7. When the radiated emissions limits are expressed in terms of the average value of the emissions, and pulsed operation is employed, the measurement field strength shall be determined by averaging over one complete pulse train, including blanking intervals, as long as the pulse train does not exceed 0.1 seconds. As an alternative (provided the transmitter operates for longer than 0.1 seconds) or in cases where the pulse train exceeds 0.1 seconds, the measured field strength shall be determined from the average absolute voltage during a 0.1 second interval during which the field strength is at its maximum values.
8. If the emissions level of the EUT in peak mode was 3 dB lower than the average limit specified, then testing will be stopped and peak values of EUT will be reported, otherwise, the emissions which do not have 3 dB margin will be repeated one by one using the quasi-peak method for below 1GHz.
9. For testing above 1GHz, the emissions level of the EUT in peak mode was lower than average limit (that means the emissions level in peak mode also complies with the limit in average mode), then testing will be stopped and peak values of EUT will be reported, otherwise, the emissions will be measured in average mode again and reported.
10. In case the emission is lower than 30MHz, loop antenna has to be used for measurement and the recorded data should be QP measured by receiver. High - Low scan is not required in this case.

### 9.2. TEST SETUP

#### RADIATED EMISSION TEST-SETUP FREQUENCY BELOW 30MHZ

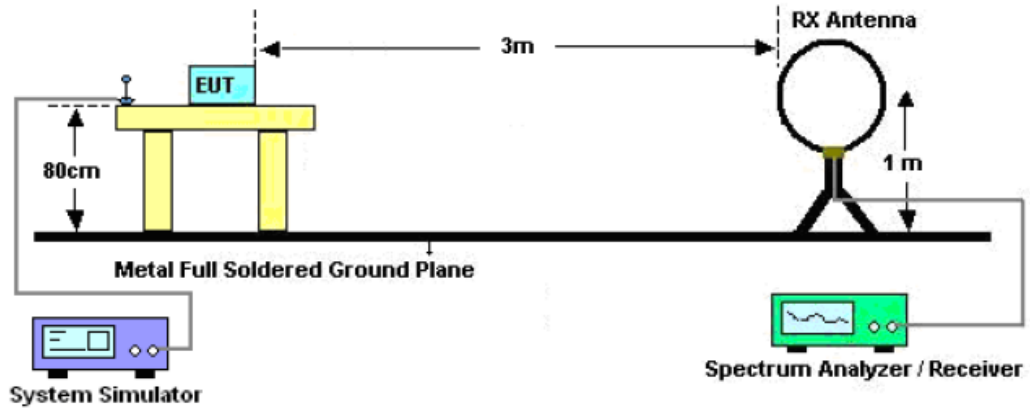

#### RADIATED EMISSION TEST SETUP 30MHz-1000MHz

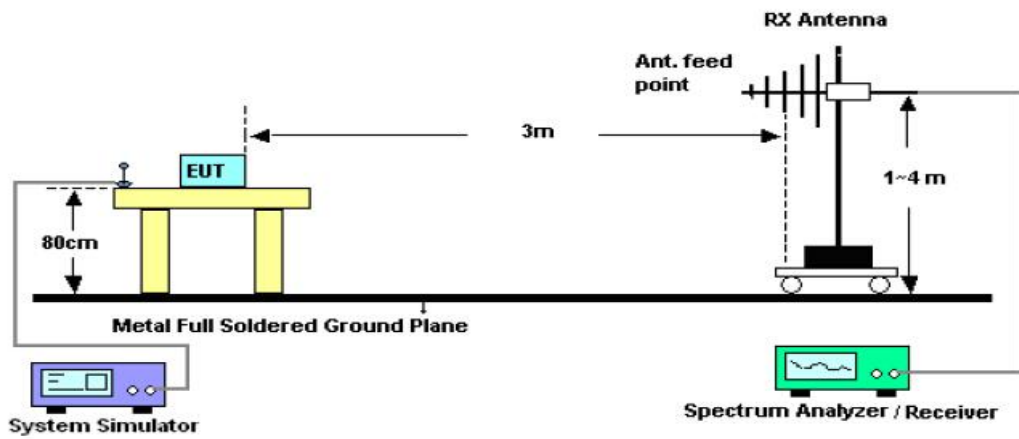

#### RADIATED EMISSION TEST SETUP ABOVE 1000MHz

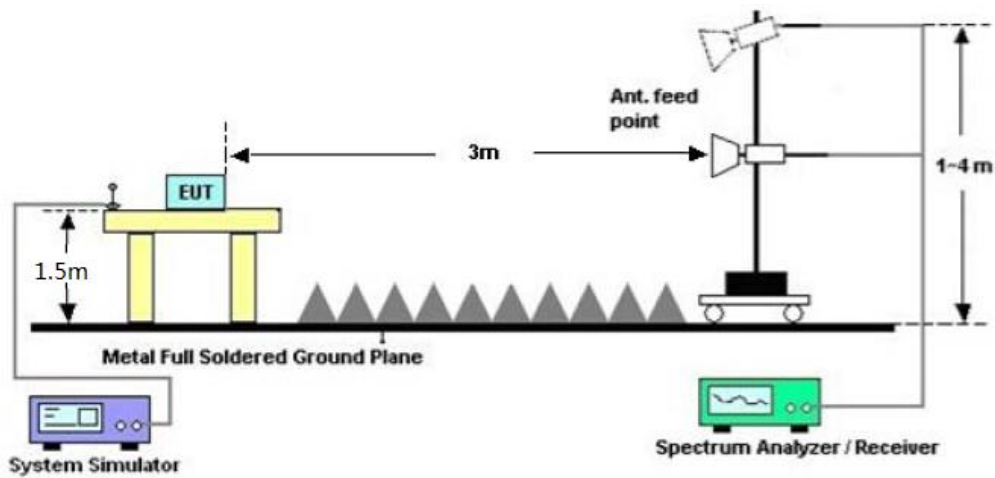



### 9.3. LIMITS AND MEASUREMENT RESULT

15.209(a) Limit in the below table has to be followed

Frequencies (MHz)	Field Strength (micorvolts/meter)	Measurement Distance (meters)
0.009~0.490	2400/F(KHz)	300
0.490~1.705	24000/F(KHz)	30
1.705~30.0	30	30
30~88	100	3
88~216	150	3
216~960	200	3
Above 960	500	3



9.4. TEST RESULT

RADIATED EMISSION BELOW 30MHZ

No emission found between lowest internal used/generated frequencies to 30MHz.

RADIATED EMISSION BELOW 1GHZ

RADIATED EMISSION TEST- (30MHZ-1GHZ) -HORIZONTAL

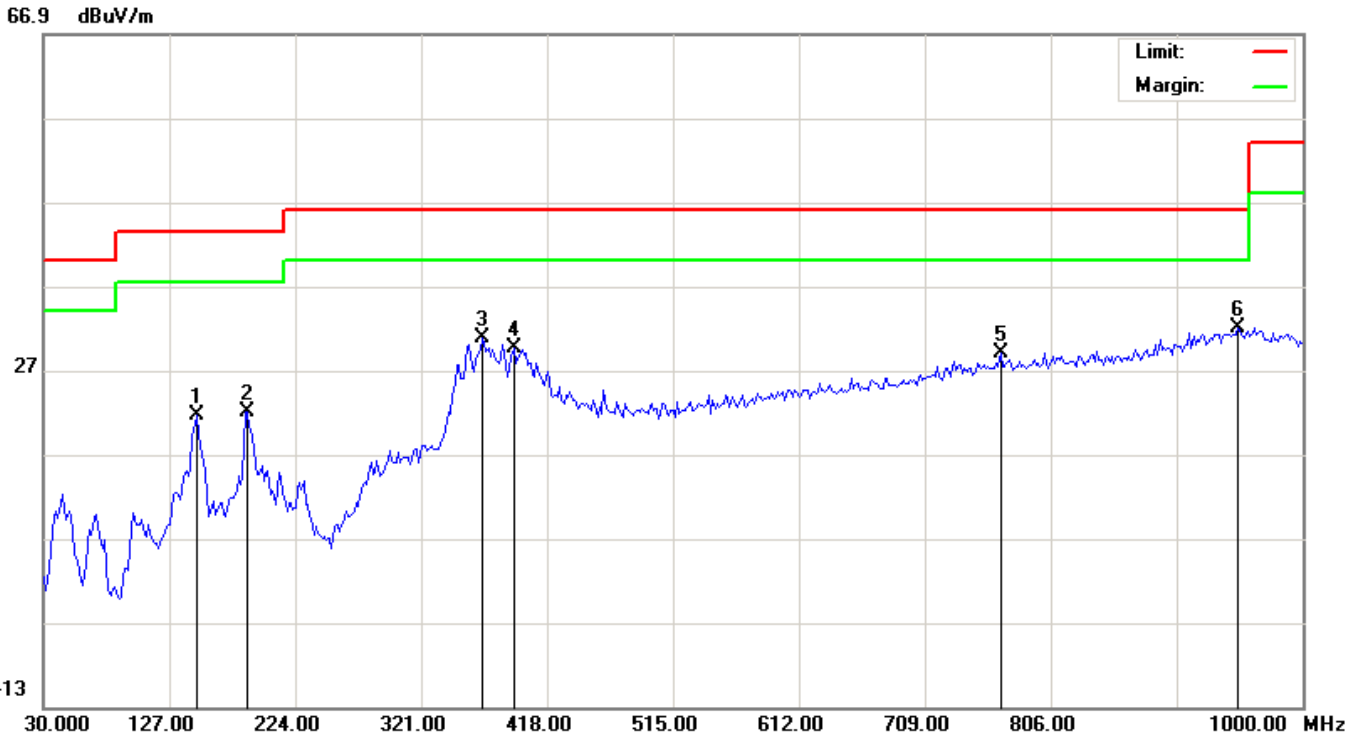

No.	Mk	Freq.	Reading	Factor	Measurement	Limit	Over	Detector	Antenna Height	Table Degree	Comment
		MHz	dBuV	dB/m	dBuV/m	dBuV/m	dB		cm	degree	
1		148.0167	8.28	13.25	21.53	43.50	-21.97	peak			
2		186.8167	10.58	11.39	21.97	43.50	-21.53	peak			
3		367.8833	11.85	18.86	30.71	46.00	-15.29	peak			
4		392.1333	10.64	19.02	29.66	46.00	-16.34	peak			
5		767.2000	2.08	26.87	28.95	46.00	-17.05	peak			
6	*	949.8833	2.01	30.00	32.01	46.00	-13.99	peak			

RESULT: PASS



RADIATED EMISSION TEST- (30MHZ-1GHZ) -VERTICAL

66.9 dBuV/m

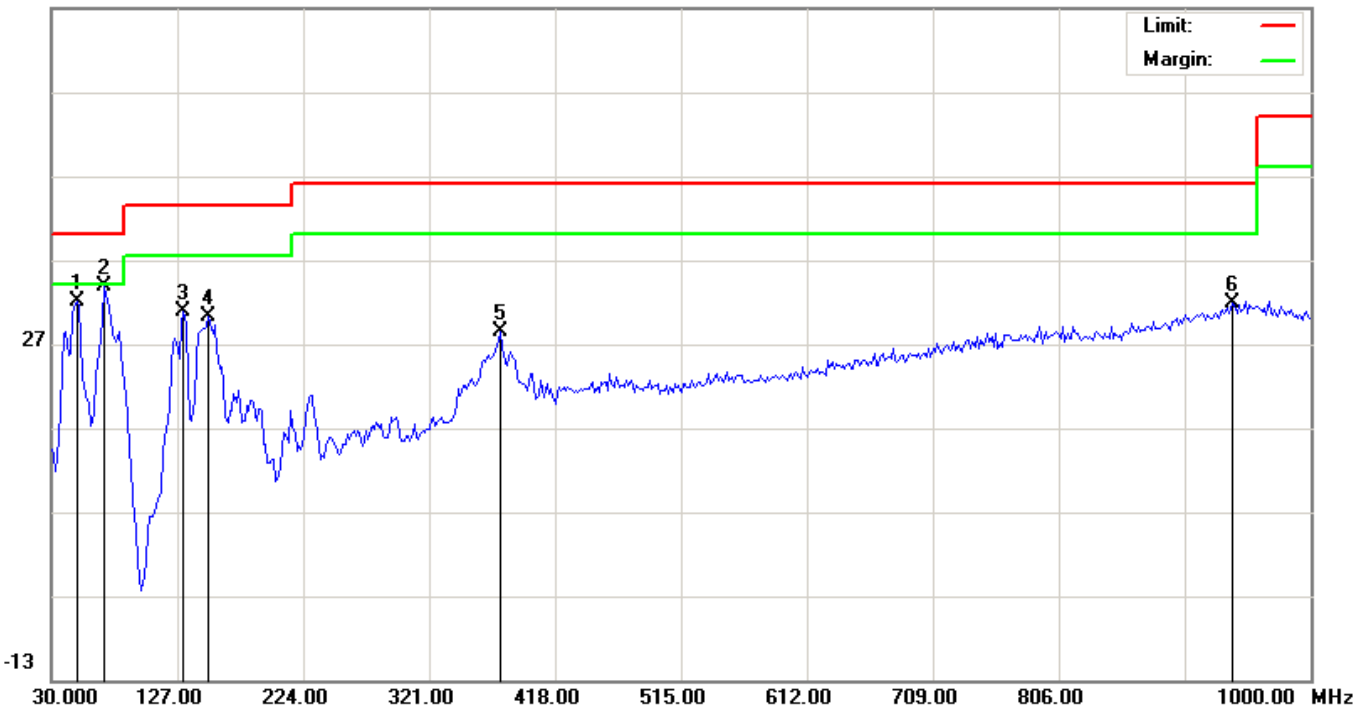

No.	Mk	Freq.	Reading	Factor	Measurement	Limit	Over	Detector	Antenna	Table	Comment
		MHz	dBuV	dB/m	dBuV/m	dBuV/m	dB		Height	Degree	
									cm	degree	
1		49.4000	23.70	8.28	31.98	40.00	-8.02	peak			
2	*	70.4167	29.72	4.16	33.88	40.00	-6.12	peak			
3		131.8500	18.95	11.80	30.75	43.50	-12.75	peak			
4		151.2500	15.01	15.27	30.28	43.50	-13.22	peak			
5		375.9667	9.44	18.91	28.35	46.00	-17.65	peak			
6		940.1833	2.14	29.73	31.87	46.00	-14.13	peak			

**RESULT: PASS**

**Note:** 1. Factor=Antenna Factor + Cable loss, Margin=Measurement-Limit.

2. The "Factor" value can be calculated automatically by software of measurement system.

3. All test modes for different EUT are pre-tested. The low channel for GFSK mode is the worst case and recorded in the report.





## RADIATED EMISSION TEST- (ABOVE 1GHZ)

Frequency (MHz)	Emission Level (dB $\mu$ V/m)	Limits (dB $\mu$ V/m)	Margin (dB)	Detector Type	Comment
Low Channel (2402 MHz)					
4804	51.47	74	-22.53	Pk	Vertical
4804	36.36	54	-17.64	AV	Vertical
4804	50.25	74	-23.75	Pk	Horizontal
4804	38.44	54	-15.56	AV	Horizontal
Mid Channel (2441 MHz)					
4882	52.42	74	-21.58	Pk	Vertical
4882	38.29	54	-15.71	AV	Vertical
4882	51.47	74	-22.53	Pk	Horizontal
4882	37.43	54	-16.57	AV	Horizontal
High Channel (2480 MHz)					
4960	50.39	74	-23.61	pk	Vertical
4960	35.74	54	-18.26	AV	Vertical
4960	50.29	74	-23.71	pk	Horizontal
4960	40.35	54	-13.65	AV	Horizontal

**RESULT: PASS****Note:**

1. 1GHz~25GHz:(Scan with GFSK,  $\pi/4$ -DQPSK,8DPSK, the worst case is GFSK Mode, No recording in the test report at least have 20dB margin)
2. Margin = Emission Level - Limit



## 10. BAND EDGE EMISSION

### 10.1. MEASUREMENT PROCEDURE

1. The transmitter output is connected to a spectrum analyzer. The resolution bandwidth is set to 100kHz. The video bandwidth is set to 300kHz.
2. Transmitter set to the normal hopping mode at 2.4 and 2.4835 GHz.

### 10.2. TEST SET-UP

Radiated same as 10.2

Conducted set up

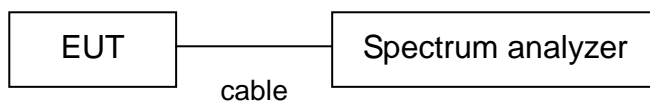

**10.3. RADIATED TEST RESULT**

Frequency	Emission Level	Limits	Margin	Detector	Comment
(MHz)	(dB $\mu$ V/m)	(dB $\mu$ V/m)	(dB)	Type	
GFSK					
2399.9	50.61	74	-23.39	peak	Vertical
2399.9	38.18	54	-15.82	AVG	Vertical
2399.9	49.66	74	-24.34	peak	Horizontal
2399.9	39.37	54	-14.63	AVG	Horizontal
2483.6	51.49	74	-22.51	peak	Vertical
2483.6	35.56	54	-18.44	AVG	Vertical
2483.6	51.12	74	-22.88	peak	Horizontal
2483.6	37.10	54	-16.90	AVG	Horizontal
$\pi/4$ -DQPSK					
2399.9	49.62	74	-24.38	peak	Vertical
2399.9	39.17	54	-14.83	AVG	Vertical
2399.9	50.65	74	-23.35	peak	Horizontal
2399.9	39.16	54	-14.84	AVG	Horizontal
2483.6	50.64	74	-23.36	peak	Vertical
2483.6	39.31	54	-14.69	AVG	Vertical
2483.6	49.18	74	-24.82	peak	Horizontal
2483.6	38.02	54	-15.98	AVG	Horizontal
8DPSK					
2399.9	50.74	74	-23.26	peak	Vertical
2399.9	37.28	54	-16.72	AVG	Vertical
2399.9	49.59	74	-24.41	peak	Horizontal
2399.9	39.06	54	-14.94	AVG	Horizontal
2483.6	49.44	74	-24.56	peak	Vertical
2483.6	38.64	54	-15.36	AVG	Vertical
2483.6	51.88	74	-22.12	peak	Horizontal
2483.6	39.17	54	-14.83	AVG	Horizontal

**RESULT: PASS**

**Note:** The other modes radiation emission have enough 20dB margin.

$$\text{Margin} = \text{Emission Level} - \text{Limit}$$



10.4 CONDUCTED TEST RESULT

Test Graph

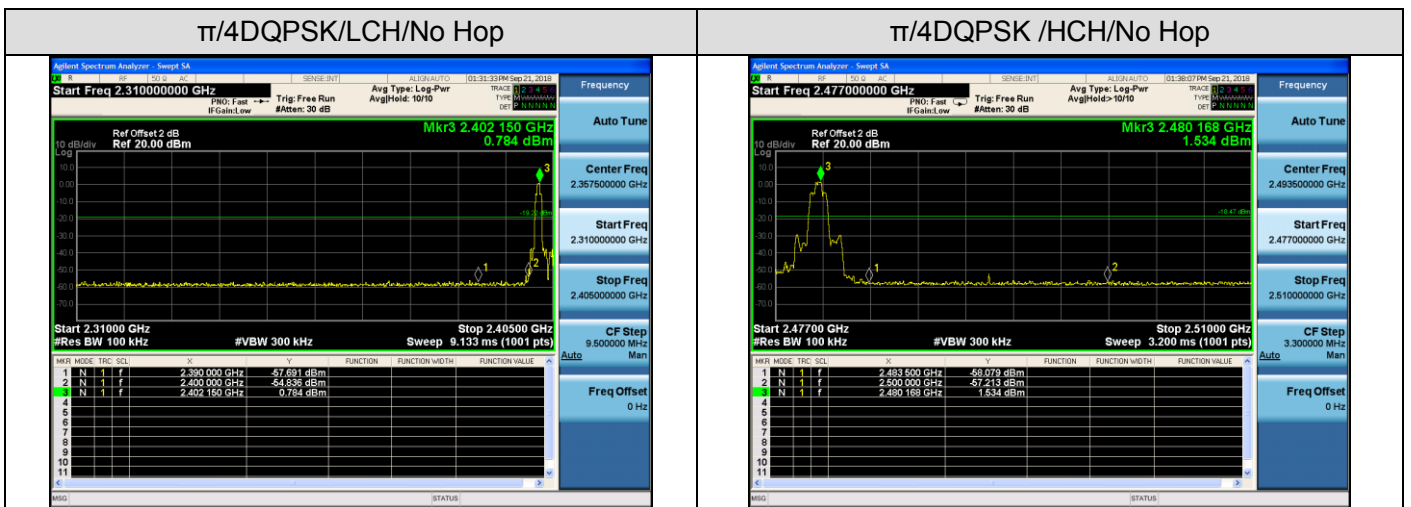
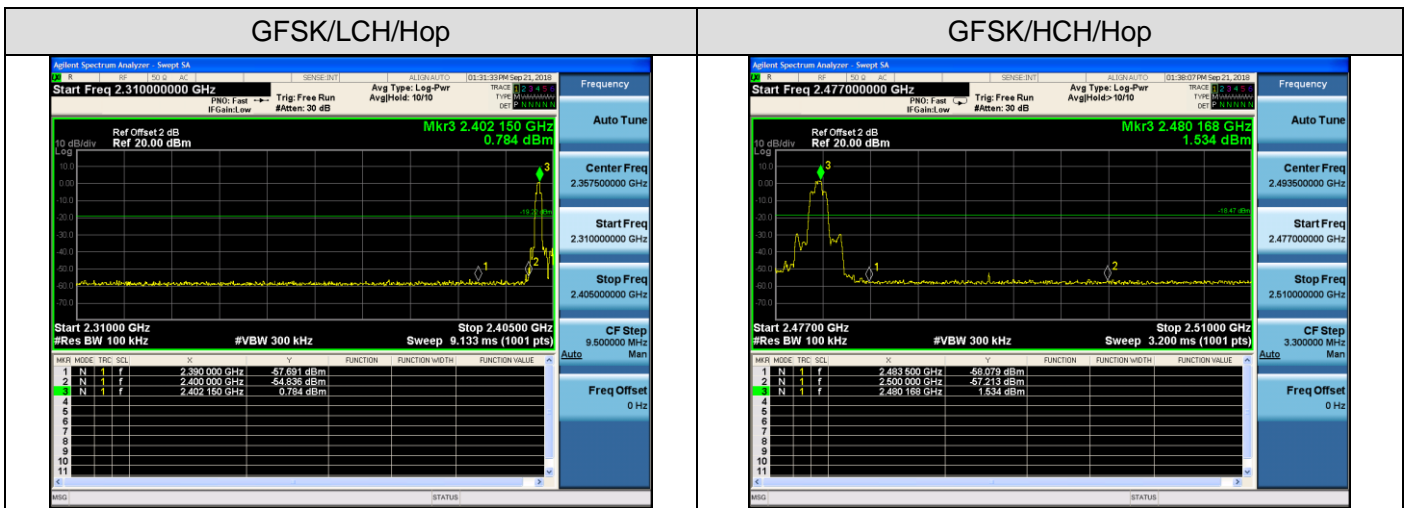
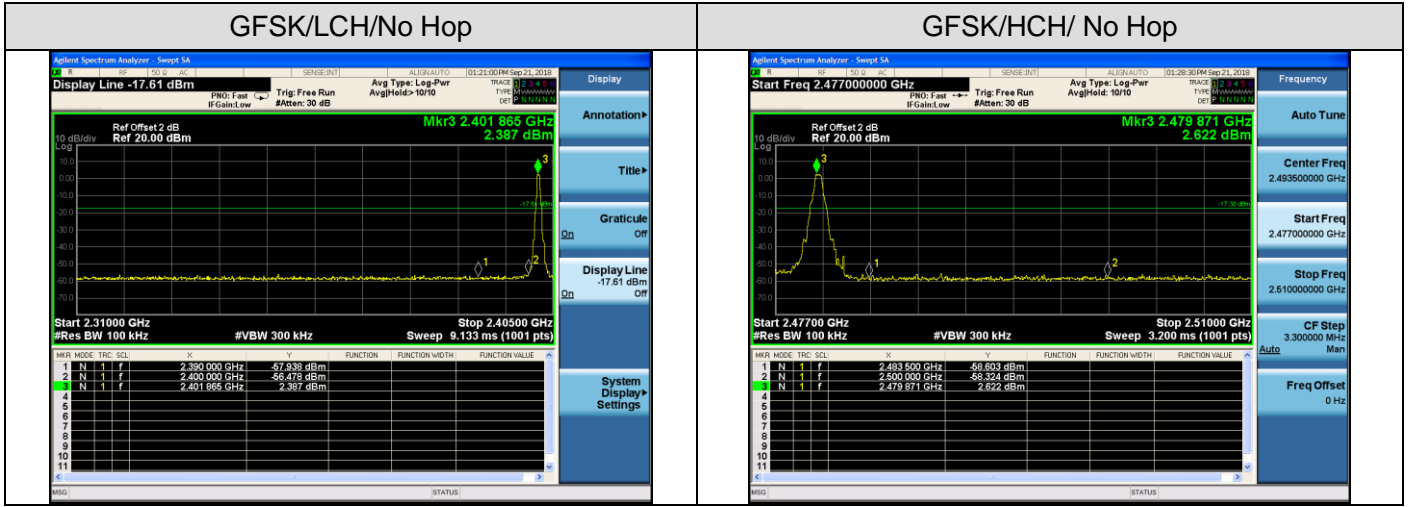

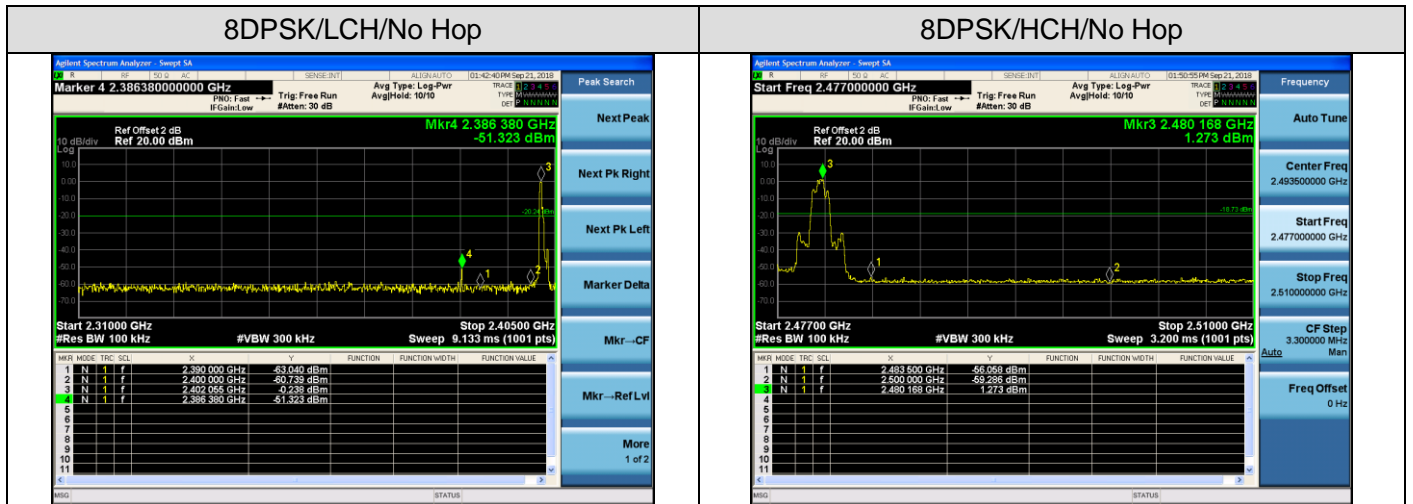

**Note:** All modes were tested, only the worst case record in the report.



## 11. NUMBER OF HOPPING FREQUENCY

### 11.1. MEASUREMENT PROCEDURE

1. Place the EUT on the table and set it in transmitting mode.
2. Remove the antenna from the EUT and then connect a low RF cable from the antenna port to the spectrum analyzer.
3. Set the spectrum analyzer Start = 2.4GHz Stop = 2.4835GHz
4. Set the Spectrum Analyzer as RBW>=1%span, VBW>=RBW.

### 11.2. TEST SETUP (BLOCK DIAGRAM OF CONFIGURATION)

Same as described in section 8.2

### 11.3. MEASUREMENT EQUIPMENT USED

The same as described in section 6

### 11.4. LIMITS AND MEASUREMENT RESULT

Mode	Channel.	Number of Hopping Channel	Verdict
GFSK	Hop	79	PASS

Note: All modes were tested, only the worst case record in the report.

### Test Graph

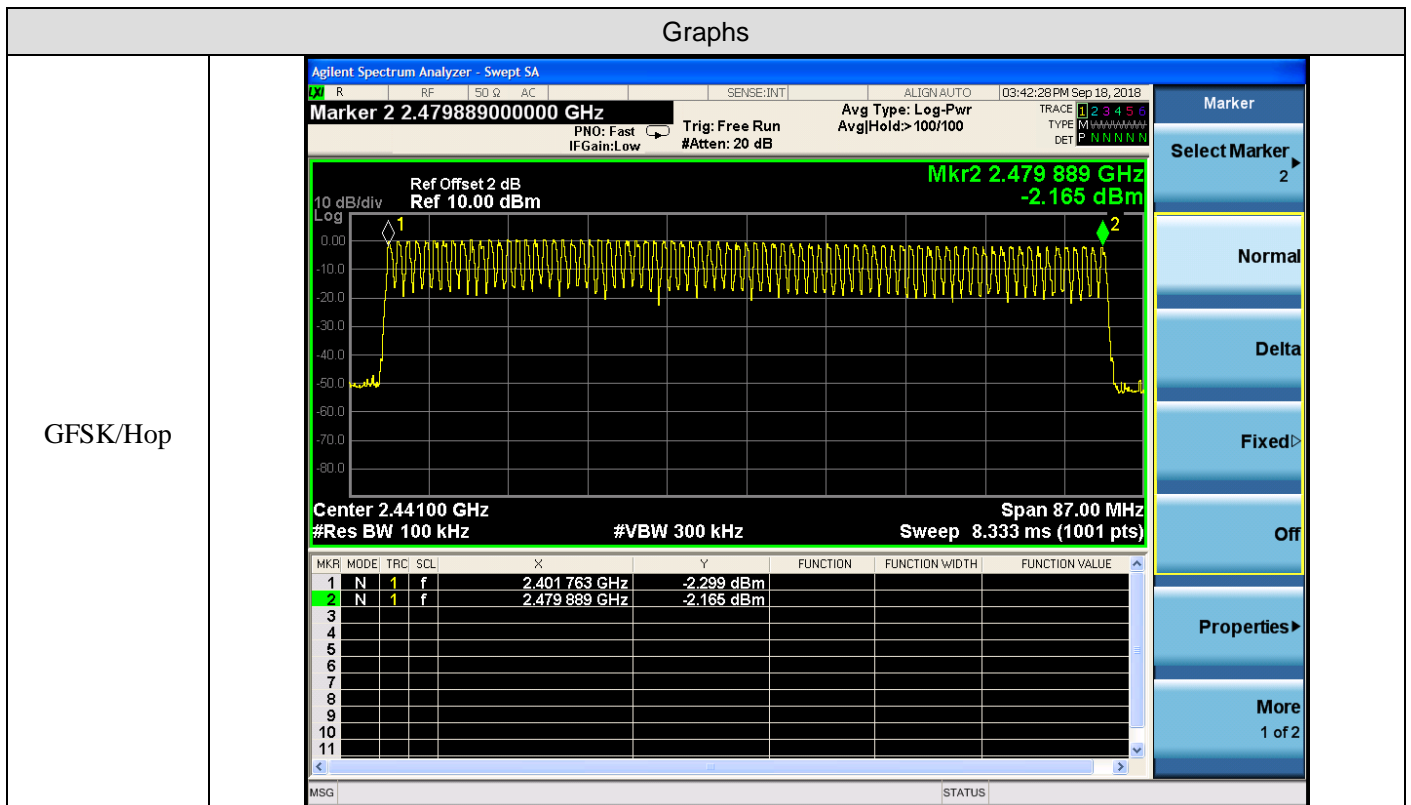



## 12. TIME OF OCCUPANCY (DWELL TIME)

### 12.1. MEASUREMENT PROCEDURE

The EUT shall have its hopping function enabled. Use the following spectrum analyzer settings:

1. Span: Zero span, centered on a hopping channel.
2. RBW shall be  $\leq$  channel spacing and where possible RBW should be set  $\gg 1 / T$ , where T is the expected dwell time per channel.
3. Sweep: As necessary to capture the entire dwell time per hopping channel; where possible use a video trigger and trigger delay so that the transmitted signal starts a little to the right of the start of the plot. The trigger level might need slight adjustment to prevent triggering when the system hops on an adjacent channel.
4. Detector function: Peak. Trace: Max hold.
5. Use the marker-delta function to determine the transmit time per hop.
6. Using the following equation:

The dwell time is calculated with the following formula:

$$\text{Dwell time} = t_{\text{pulse}} \times n_{\text{hops}} / \text{number of channels} \times 31.6 \text{ s}$$

Where:

$t_{\text{pulse}}$  is the measured pulse time (pls. refer the plots of the spectrum analyser above) [s],

$n_{\text{hops}}$  is the number of hops per second in the actual operating mode of the transmitter [1/s].

The hopping rate of the system is 1600 hops per second and the system uses 79 channels. For this reason one time slot has a length of 625  $\mu\text{s}$ .

With the used hopping mode (DH5) a packet need 5 timeslots for transmitting and the next timeslot for receiving. So the system makes in worst case 266,67 hops per second in transmit mode ( $n_{\text{hops}} = 266.667$  1/s)

### 12.2. TEST SETUP (BLOCK DIAGRAM OF CONFIGURATION)

Same as described in section 8.2

### 12.3. MEASUREMENT EQUIPMENT USED

The same as described in section 6



12.4. LIMITS AND MEASUREMENT RESULT

Channel.	Burst Width [ms/hop/ch]	Dwell Time[ms]	Verdict	Limit (ms)
LCH	3.075	328.0004	PASS	400
MCH	3.085	329.0671	PASS	400
HCH	3.070	327.4671	PASS	400

Note: The DH5 for GFSK modulation is the worst case and recorded in the report.

Test Graph

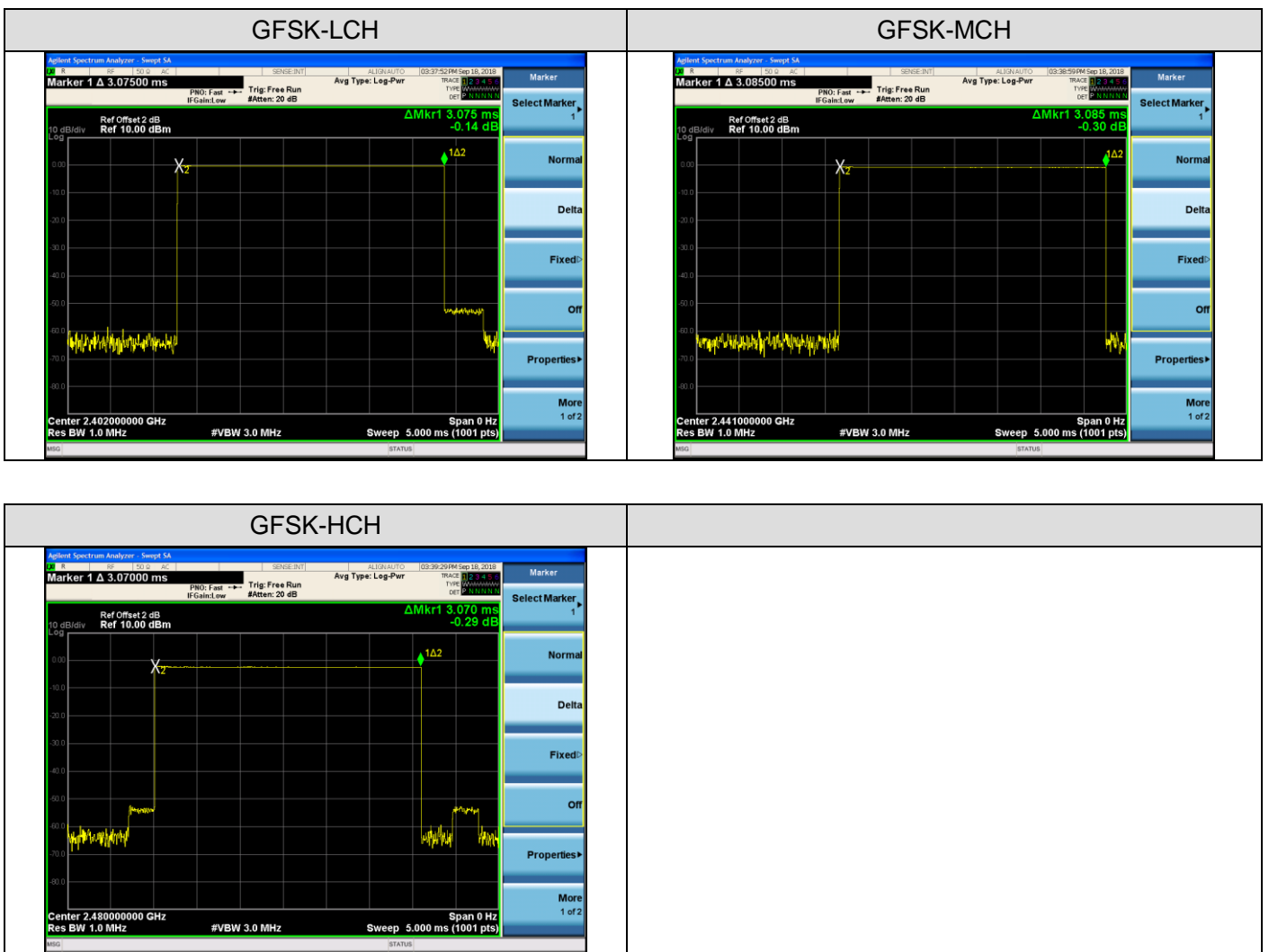





### 13. FREQUENCY SEPARATION

#### 13.1. MEASUREMENT PROCEDURE

1. Place the EUT on the table and set it in transmitting mode
2. Remove the antenna from the EUT and then connect a low RF cable from the antenna port to the spectrum analyzer
3. Set Span = wide enough to capture the peaks of two adjacent channels Resolution (or IF) Bandwidth (RBW)  $\geq$  1% of the span Video (or Average) Bandwidth (VBW)  $\geq$  RBW; Sweep = auto; Detector function = peak; Trace = max hold

#### 13.2. TEST SETUP (BLOCK DIAGRAM OF CONFIGURATION)

Same as described in section 6.2

#### 13.3. MEASUREMENT EQUIPMENT USED

The same as described in section 6.3

#### 13.4. LIMITS AND MEASUREMENT RESULT

Mode	Channel.	Carrier Frequency Separation [MHz]	Verdict
GFSK	Hop	0.999	PASS

Note: All modes were tested, only the worst case record in the report.

#### Test Graph

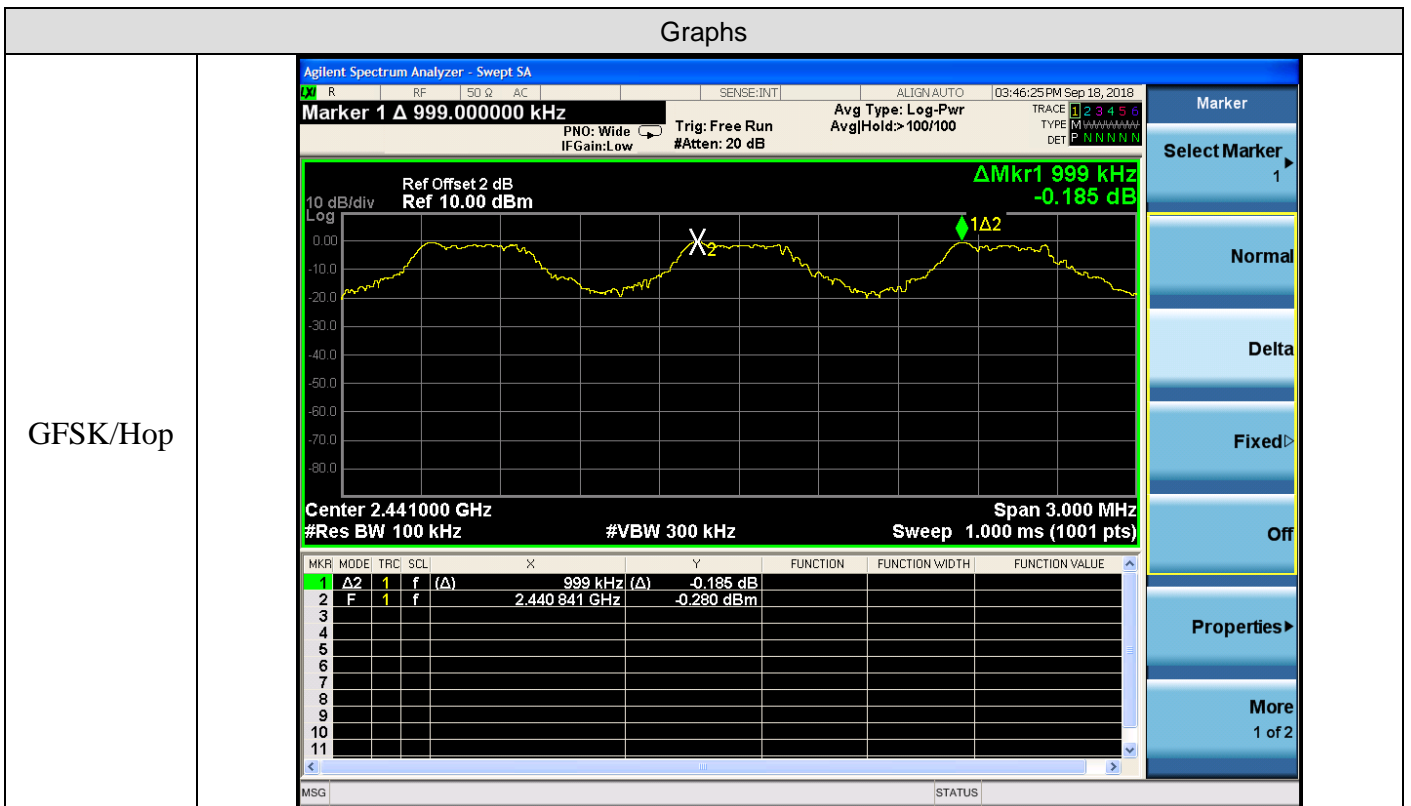

## 14. FCC LINE CONDUCTED EMISSION TEST

### 15.1. LIMITS OF LINE CONDUCTED EMISSION TEST

Frequency	Maximum RF Line Voltage	
	Q.P.( dBuV)	Average( dBuV)
150kHz~500kHz	66-56	56-46
500kHz~5MHz	56	46
5MHz~30MHz	60	50

Note:

1. The lower limit shall apply at the transition frequency.
2. The limit decreases linearly with the logarithm of the frequency in the range 0.15 MHz to 0.50 MHz.

### 14.2. BLOCK DIAGRAM OF LINE CONDUCTED EMISSION TEST

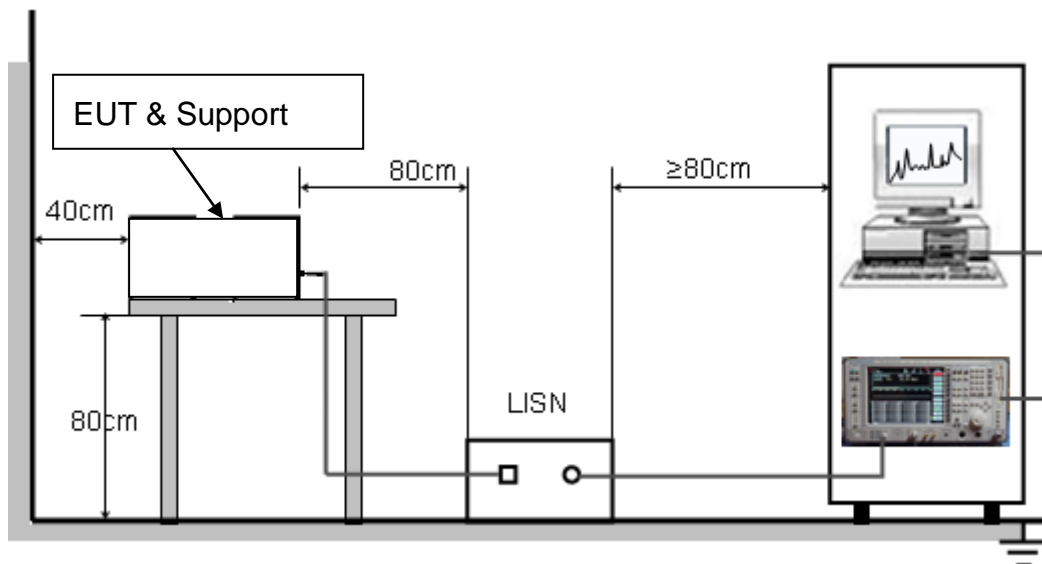



#### **14.3. PRELIMINARY PROCEDURE OF LINE CONDUCTED EMISSION TEST**

1. The equipment was set up as per the test configuration to simulate typical actual usage per the user's manual. When the EUT is a tabletop system, a wooden table with a height of 0.8 meters is used and is placed on the ground plane as per ANSI C63.10 (see Test Facility for the dimensions of the ground plane used). When the EUT is a floor-standing equipment, it is placed on the ground plane which has a 3-12 mm non-conductive covering to insulate the EUT from the ground plane.
2. Support equipment, if needed, was placed as per ANSI C63.10.
3. All I/O cables were positioned to simulate typical actual usage as per ANSI C63.10.
4. All support equipments received AC120V/60Hz power from a LISN, if any.
5. The EUT received DC charging voltage by adapter which received 120V/60Hz power by a LISN..
6. The test program was started. Emissions were measured on each current carrying line of the EUT using a spectrum Analyzer / Receiver connected to the LISN powering the EUT. The LISN has two monitoring points: Line 1 (Hot Side) and Line 2 (Neutral Side). Two scans were taken: one with Line 1 connected to Analyzer / Receiver and Line 2 connected to a 50 ohm load; the second scan had Line 1 connected to a 50 ohm load and Line 2 connected to the Analyzer / Receiver.
7. Analyzer / Receiver scanned from 150 kHz to 30MHz for emissions in each of the test modes.
8. During the above scans, the emissions were maximized by cable manipulation.
9. The test mode(s) were scanned during the preliminary test.

Then, the EUT configuration and cable configuration of the above highest emission level were recorded for reference of final testing.

#### **14.4. FINAL PROCEDURE OF LINE CONDUCTED EMISSION TEST**

1. EUT and support equipment was set up on the test bench as per step 2 of the preliminary test.
2. A scan was taken on both power lines, Line 1 and Line 2, recording at least the six highest emissions. Emission frequency and amplitude were recorded into a computer in which correction factors were used to calculate the emission level and compare reading to the applicable limit. If EUT emission level was less -2dB to the A.V. limit in Peak mode, then the emission signal was re-checked using Q.P and Average detector.
3. The test data of the worst case condition(s) was reported on the Summary Data page.



14.5. TEST RESULT OF LINE CONDUCTED EMISSION TEST

LINE CONDUCTED EMISSION TEST LINE 1-L

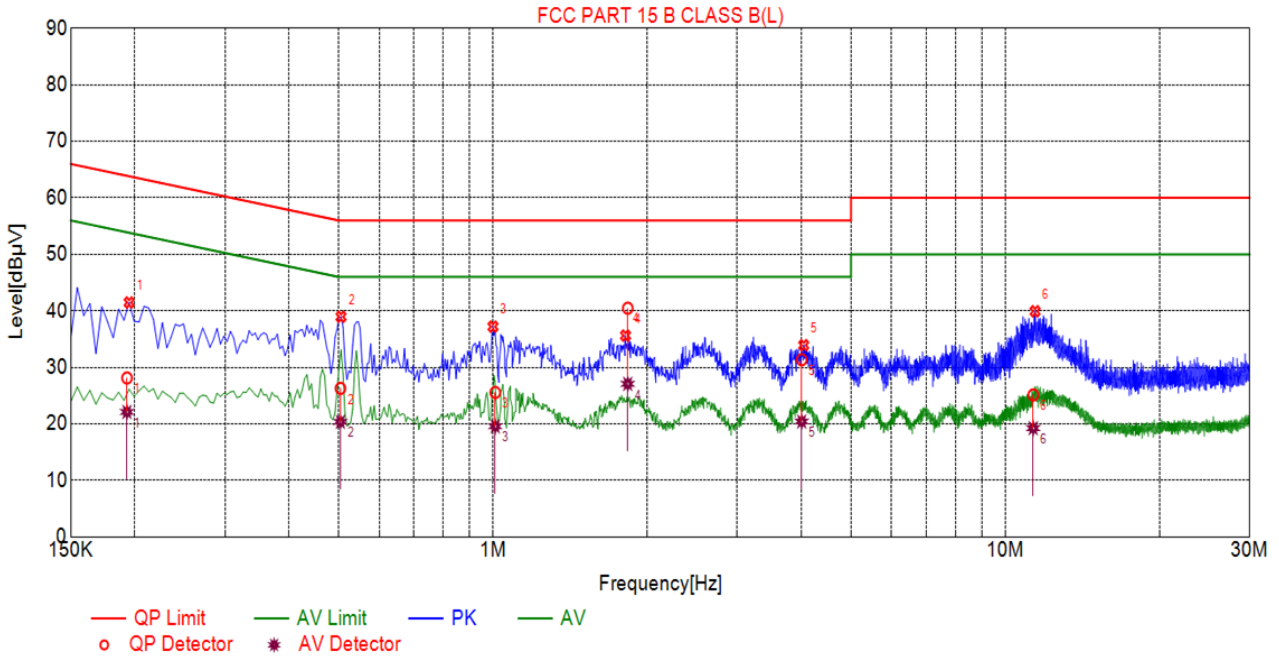

Suspected List						
NO.	Freq. [MHz]	Level [dBµV]	Factor [dB]	Limit [dBµV]	Margin [dB]	Detector
1	0.1950	41.48	10.03	63.82	22.34	PK
2	0.5055	38.95	10.04	56.00	17.05	PK
3	1.0005	37.20	10.06	56.00	18.80	PK
4	1.8150	35.62	10.14	56.00	20.38	PK
5	4.0425	33.91	10.25	56.00	22.09	PK
6	11.4360	39.92	10.00	60.00	20.08	PK

Final Data List								
NO.	Freq. [MHz]	Factor [dB]	QP Value [dBµV]	QP Limit [dBµV]	QP Margin [dB]	AV Value [dBµV]	AV Limit [dBµV]	AV Margin [dB]
1	0.1931	10.04	28.12	63.90	35.78	22.10	53.90	31.80
2	0.5040	10.04	26.27	56.00	29.73	20.35	46.00	25.65
3	1.0105	10.06	25.55	56.00	30.45	19.56	46.00	26.44
4	1.8331	10.14	40.47	56.00	15.53	27.07	46.00	18.93
5	4.0059	10.25	31.35	56.00	24.65	20.41	46.00	25.59
6	11.3370	10.00	25.12	60.00	34.88	19.23	50.00	30.77



LINE CONDUCTED EMISSION TEST LINE 2-N

FCC PART 15 B CLASS B(N)

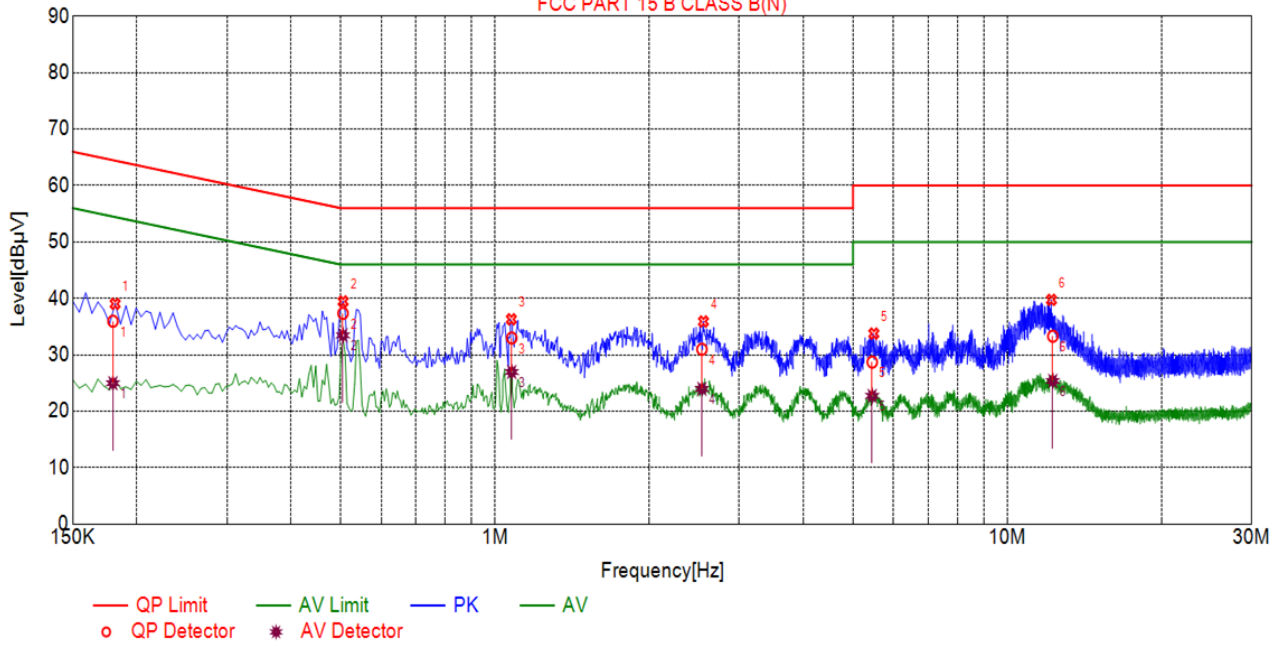

Suspected List						
NO.	Freq. [MHz]	Level [dBµV]	Factor [dB]	Limit [dBµV]	Margin [dB]	Detector
1	0.1815	39.03	10.06	64.42	25.39	PK
2	0.5055	39.45	10.04	56.00	16.55	PK
3	1.0770	36.29	10.07	56.00	19.71	PK
4	2.5530	35.90	10.20	56.00	20.10	PK
5	5.4915	33.75	10.26	60.00	26.25	PK
6	12.1965	39.74	9.99	60.00	20.26	PK

Final Data List								
NO.	Freq. [MHz]	Factor [dB]	QP Value [dBµV]	QP Limit [dBµV]	QP Margin [dB]	AV Value [dBµV]	AV Limit [dBµV]	AV Margin [dB]
1	0.1797	10.06	35.95	64.50	28.55	24.96	54.50	29.54
2	0.5053	10.04	37.35	56.00	18.65	33.45	46.00	12.55
3	1.0787	10.07	32.97	56.00	23.03	26.95	46.00	19.05
4	2.5353	10.20	30.98	56.00	25.02	23.96	46.00	22.04
5	5.4495	10.26	28.71	60.00	31.29	22.71	50.00	27.29
6	12.2692	9.98	33.29	60.00	26.71	25.37	50.00	24.63

## APPENDIX A: PHOTOGRAPHS OF TEST SETUP

### LINE CONDUCTED EMISSION TEST SETUP



### RADIATED EMISSION TEST SETUP





RADIATED EMISSION ABOVE 1G TEST SETUP



----END OF REPORT----