SAR Test Report

Report No.: AGC00552190704FH01

FCC ID : 2AHZ5CUBOTX19
APPLICATION PURPOSE : Original Equipment
PRODUCT DESIGNATION : Smart Phone
BRAND NAME : CUBOT
MODEL NAME : X19
APPLICANT : Shenzhen Huafurui Technology Co., Ltd.
DATE OF ISSUE : Sep. 12,2019
STANDARD(S) : IEEE Std. 1528:2013
: FCC 47 CFR Part 2§2.1093:2013
: IEEE C95.1TM:2005
REPORT VERSION : V1.1

Attestation of Global Compliance(Shenzhen) Co., Ltd.

CAUTION:

This report shall not be reproduced except in full without the written permission of the test laboratory and shall not be quoted out of context.



Attestation of Global Compliance(Shenzhen)Co.,Ltd.

Add: 2/F., Building 2, No.1-4, Chaxi Sanwei Technial Industrial Park, Gushu,
Xixiang, Bao'an District, Shenzhen, Guangdong, China

Tel: +86-755 2523 4088

E-mail: agc@agc-cert.com

Service Hotline:400 089 2118

Report Revise Record

Report Version	Revise Time	Issued Date	Valid Version	Notes
V1.0	/	Sep. 03,2019	Invalid	Initial Release
V1.1	1 st	Sep. 12,2019	Valid	Updated antenna gain



Attestation of Global Compliance(Shenzhen)Co.,Ltd.

Add: 2/F., Building 2, No.1-4, Chaxi Sanwei Technial Industrial Park, Gushu,
Xixiang, Bao'an District, Shenzhen, Guangdong, China

Tel: +86-755 2523 4088

E-mail: agc@agc-cert.com

Service Hotline:400 089 2118

Test Report

Applicant Name	Shenzhen Huafurui Technology Co., Ltd.
Applicant Address	Unit 1401 14/F, Jin qi zhi gu mansion Liu xian street, Xili, Nan shan district Shenzhen, China
Manufacturer Name	Shenzhen Huafurui Technology Co., Ltd.
Manufacturer Address	Unit 1401 14/F, Jin qi zhi gu mansion Liu xian street, Xili, Nan shan district Shenzhen, China
Factory Name	Shenzhen Huafurui Technology Co., Ltd.
Factory Address	Unit 1401 14/F, Jin qi zhi gu mansion Liu xian street, Xili, Nan shan district Shenzhen, China
Product Designation	Smart Phone
Brand Name	CUBOT
Model Name	X19
Different Description	N/A
EUT Voltage	DC3.8V by battery
Applicable Standard	IEEE Std. 1528:2013 FCC 47 CFR Part 2§2.1093:2013 IEEE C95.1TM:2005
Test Date	Aug. 01,2019 to Aug. 28,2019
Report Template	AGCRT-US-4G/SAR (2018-01-01)

Note: The results of testing in this report apply to the product/system which was tested only.

Eric Zhou

Prepared By _____

Eric Zhou(Project Engineer)

Aug. 28,2019

Jack Gui

Reviewed By _____

Jack Gui (Reviewer)

Sep. 12,2019

Forrest Lei

Approved By _____

Forrest Lei
(Authorized Officer)

Sep. 12,2019



Attestation of Global Compliance(Shenzhen)Co.,Ltd.

Add: 2/F., Building 2, No.1-4, Chaxi Sanwei Technial Industrial Park, Gushu, Xixiang, Bao'an District, Shenzhen, Guangdong, China

Tel: +86-755 2523 4088

E-mail: agc@agc-cert.com

Service Hotline:400 089 2118

TABLE OF CONTENTS

1. SUMMARY OF MAXIMUM SAR VALUE	5
2. GENERAL INFORMATION	6
2.1. EUT DESCRIPTION.....	6
3. SAR MEASUREMENT SYSTEM	9
3.1. THE SATIMO SYSTEM USED FOR PERFORMING COMPLIANCE TESTS CONSISTS OF FOLLOWING ITEMS.....	9
3.2. COMOSAR E-FIELD PROBE	10
3.3. ROBOT.....	11
3.4. VIDEO POSITIONING SYSTEM	11
3.5. DEVICE HOLDER	12
3.6. SAM TWIN PHANTOM.....	13
3.7. ELLI39 PHANTOM.....	13
4. SAR MEASUREMENT PROCEDURE	14
4.1. SPECIFIC ABSORPTION RATE (SAR)	14
4.2. SAR MEASUREMENT PROCEDURE	15
4.3. RF EXPOSURE CONDITIONS.....	17
5. TISSUE SIMULATING LIQUID	19
5.1. THE COMPOSITION OF THE TISSUE SIMULATING LIQUID.....	19
5.2. TISSUE DIELECTRIC PARAMETERS FOR HEAD AND BODY PHANTOMS.....	20
5.3. TISSUE CALIBRATION RESULT.....	21
6. SAR SYSTEM CHECK PROCEDURE	26
6.1. SAR SYSTEM CHECK PROCEDURES.....	26
6.2. SAR SYSTEM CHECK.....	27
7. EUT TEST POSITION	29
7.1. DEFINE TWO IMAGINARY LINES ON THE HANDSET.....	29
7.2. CHEEK POSITION	30
7.3. TILT POSITION.....	30
7.4. BODY WORN POSITION.....	31
8. SAR EXPOSURE LIMITS	32
9. TEST FACILITY	33
10. TEST EQUIPMENT LIST	34
11. MEASUREMENT UNCERTAINTY	35
12. CONDUCTED POWER MEASUREMENT	41
13. TEST RESULTS	67
13.1. SAR TEST RESULTS SUMMARY	67
APPENDIX A. SAR SYSTEM CHECK DATA	103
APPENDIX B. SAR MEASUREMENT DATA.....	139
APPENDIX C. TEST SETUP PHOTOGRAPHS	194
APPENDIX D. CALIBRATION DATA.....	203



1. SUMMARY OF MAXIMUM SAR VALUE

The maximum results of Specific Absorption Rate (SAR) found during testing for EUT are as follows:

Frequency Band	Highest Reported 1g-SAR(W/Kg)		SAR Test Limit (W/Kg)
	Head	Body-worn	
GSM 850	0.265	0.440	1.6
PCS 1900	0.145	0.504	
UMTS Band II	0.217	0.382	
UMTS Band V	0.139	0.187	
LTE Band 2	0.258	0.544	
LTE Band 4	0.203	0.486	
LTE Band 5	0.245	0.252	
LTE Band 7	0.334	1.332	
LTE Band 12	0.175	0.338	
LTE Band 17	0.215	0.476	
WIFI 2.4G	0.959	0.297	
WIFI 5.2G	0.123	0.079	
Simultaneous Reported SAR	1.293		
SAR Test Result	PASS		

This device is compliance with Specific Absorption Rate (SAR) for general population/uncontrolled exposure limits (1.6W/Kg) specified in IEEE Std. 1528:2013; FCC 47 CFR Part 2§2.1093:2013; IEEE/ANSI C95.1:2005 and the following specific FCC Test Procedures:

- KDB 447498 D01 General RF Exposure Guidance v06
- KDB 648474 D04 Handset SAR v01r03
- KDB 865664 D01 SAR Measurement 100MHz to 6GHz v01r04
- KDB 941225 D01 3G SAR Procedures v03r01
- KDB 941225 D06 Hotspot Mode v02r01
- KDB 248227 D01 802 11 Wi-Fi SAR v02r02
- KDB 941225 D05 SAR for LTE Devices v02r05



Attestation of Global Compliance(Shenzhen)Co.,Ltd.

Add: 2/F., Building 2, No.1-4, Chaxi Sanwei Technial Industrial Park, Gushu, Xixiang, Bao'an District, Shenzhen, Guangdong, China

Tel: +86-755 2523 4088

E-mail: agc@agc-cert.com

Service Hotline:400 089 2118

2. GENERAL INFORMATION

2.1. EUT Description

General Information	
Product Designation	Smart Phone
Test Model	X19
Hardware Version	Q593_MB_V1.0
Software Version	CUBOT_X19_9021C_2_V01_20190712
Device Category	Portable
RF Exposure Environment	Uncontrolled
Antenna Type	Internal
GSM and GPRS& EGPRS	
Support Band	<input checked="" type="checkbox"/> GSM 850 <input checked="" type="checkbox"/> PCS 1900 <input checked="" type="checkbox"/> GSM 900 <input checked="" type="checkbox"/> DCS 1800
GPRS & EGPRS Type	Class B
GPRS & EGPRS Class	Class 12(1Tx+4Rx, 2Tx+3Rx, 3Tx+2Rx, 4Tx+1Rx)
TX Frequency Range	GSM 850 : 820-850MHz; PCS 1900: 1850-1910MHz;
RX Frequency Range	GSM 850 : 869~894MHz; PCS 1900: 1930~1990MHz
Release Version	R99
Type of modulation	GMSK for GSM/GPRS; GMSK & 8-PSK for EGPRS
Antenna Gain	GSM850: -3.65dBi; PCS1900: -1.96dBi
Max. Average Power	GSM850: 31.47dBm; PCS1900: 29.73dBm
WCDMA	
Support Band	<input checked="" type="checkbox"/> UMTS FDD Band II <input checked="" type="checkbox"/> UMTS FDD Band V <input type="checkbox"/> UMTS FDD Band IV <input type="checkbox"/> UMTS FDD Band I <input type="checkbox"/> UMTS FDD Band III <input type="checkbox"/> UMTS FDD Band VIII
HS Type	HSPA(HSUPA/HSDPA)
TX Frequency Range	FDD Band II: 1850-1910MHz; FDD Band V: 820-850MHz
RX Frequency Range	FDD Band II: 1930-1990MHz; FDD Band V: 869-894MHz
Release Version	Rel-6
Type of modulation	HSDPA:QPSK/16QAM; HSUPA:BPSK; WCDMA:QPSK
Antenna Gain	Band II: -3.65dBii; Band V: -1.96dBi
Max. Average Power	Band II: 22.55dBm; Band V: 23.17dBm



Attestation of Global Compliance(Shenzhen)Co.,Ltd.

Add: 2/F., Building 2, No.1-4, Chaxi Sanwei Technial Industrial Park, Gushu,
Xixiang, Bao'an District, Shenzhen, Guangdong, China

Tel: +86-755 2523 4088

E-mail: agc@agc-cert.com

Service Hotline:400 089 2118

EUT Description(Continue)

LTE	
Support Band	<input checked="" type="checkbox"/> FDD Band 2 <input checked="" type="checkbox"/> FDD Band 4 <input checked="" type="checkbox"/> FDD Band 5 <input checked="" type="checkbox"/> FDD Band 7 <input checked="" type="checkbox"/> FDD Band 12 <input checked="" type="checkbox"/> FDD Band 17 <input type="checkbox"/> FDD Band 25 <input type="checkbox"/> FDD Band 26 <input type="checkbox"/> TDD Band 41 (U.S. Bands) <input type="checkbox"/> FDD Band 1 <input type="checkbox"/> FDD Band 3 <input type="checkbox"/> FDD Band 7 <input type="checkbox"/> FDD Band 8 <input type="checkbox"/> FDD Band 20 <input type="checkbox"/> TDD Band 28 <input type="checkbox"/> TDD Band 39 <input type="checkbox"/> FDD Band 40 <input type="checkbox"/> FDD Band 42 <input type="checkbox"/> FDD Band 43 (Non-U.S. Bands)
TX Frequency Range	Band 2:1850-1910MHz; Band 4:1710-1755MHz;Band 5:824-849MHz; Band 7:2500-2570MHz; Band 12:699-716MHz; Band 17: 704-716MHz;
RX Frequency Range	Band 2:1930-1990MHz; Band 4:2110-2155MHz; Band 5:869-894MHz; Band 7:2620-2690MHz; Band 12: 729-746 MHz; Band 17: 734-746 MHz;
Release Version	Rel-8
Type of modulation	QPSK, 16QAM
Antenna gain:	Band 2: -1.96dBi; Band 4: -2.39dBi; Band 5: -3.65dBi; Band 7: -1.76dBi; Band 12:-3.46dBi;Band 17:-3.28dBi
Diversity Antenna gain:	Band 2: -2.11dBi; Band 4: -2.65dBi; Band 5: -3.77dBi; Band 7: -1.91dBi; Band 12:-3.76dBi;Band 17:-3.84dBi
Max. Average Power	Band 2: 23.29dBm; Band 4: 23.86dBm; Band 5: 25.06dBm; Band 7:25.43dBm; Band 12: 25.09dBm; Band 17: 24.87dBm;
Bluetooth	
Bluetooth Version	<input type="checkbox"/> V2.0 <input type="checkbox"/> V2.1 <input type="checkbox"/> V2.1+EDR <input type="checkbox"/> V3.0 <input type="checkbox"/> V3.0+HS <input type="checkbox"/> V4.0 <input checked="" type="checkbox"/> V5.0
Operation Frequency	2402~2480MHz
Type of modulation	<input checked="" type="checkbox"/> GFSK <input checked="" type="checkbox"/> π/4-DQPSK <input checked="" type="checkbox"/> 8-DPSK
Peak Power	3.285dBm
Antenna Gain	-0.46dBi
WIFI	
WIFI Specification	<input type="checkbox"/> 802.11a <input checked="" type="checkbox"/> 802.11b <input checked="" type="checkbox"/> 802.11g <input checked="" type="checkbox"/> 802.11n(20) <input type="checkbox"/> 802.11n(40)
Operation Frequency	2412~2462MHz
Avg. Burst Power	11b: 14.18dBm,11g:10.53dBm,11n(20):10.11dBm,
Antenna Gain	-0.46dBi
5GHz WIFI	
WIFI Specification	<input checked="" type="checkbox"/> 802.11a <input checked="" type="checkbox"/> 802.11n20 <input type="checkbox"/> 802.11ac20 <input type="checkbox"/> 802.11n40 <input type="checkbox"/> 802.11ac40 <input type="checkbox"/> 802.11ac80
Operation Frequency	5.180GHz~5.825GHz
Type of modulation	BPSK, QPSK, 16QAM, 64QAM, 128QAM, 256QAM,OFDM
EIRP	5200:12.38 dBm;
Antenna Gain	-0.46dBi



Attestation of Global Compliance(Shenzhen)Co.,Ltd.

 Add: 2/F., Building 2, No.1-4, Chaxi Sanwei Technial Industrial Park, Gushu,
 Xixiang, Bao'an District, Shenzhen, Guangdong, China

Tel: +86-755 2523 4088

E-mail: agc@agc-cert.com

Service Hotline:400 089 2118

Accessories	
Battery	Brand name: CUBOT Model No. : X19 Voltage and Capacitance: 3.8 V & 4000mAh
Earphone	Brand name: N/A Model No. : N/A

Note:1.CMU200 can measure the average power and Peak power at the same time
2.The sample used for testing is end product.

Product	Type
	<input checked="" type="checkbox"/> Production unit <input type="checkbox"/> Identical Prototype



Attestation of Global Compliance(Shenzhen)Co.,Ltd.

Add: 2/F., Building 2, No.1-4, Chaxi Sanwei Technial Industrial Park, Gushu,
Xixiang, Bao'an District, Shenzhen, Guangdong, China

Tel: +86-755 2523 4088

E-mail: agc@agc-cert.com

Service Hotline:400 089 2118

3. SAR MEASUREMENT SYSTEM

3.1. The SATIMO system used for performing compliance tests consists of following items

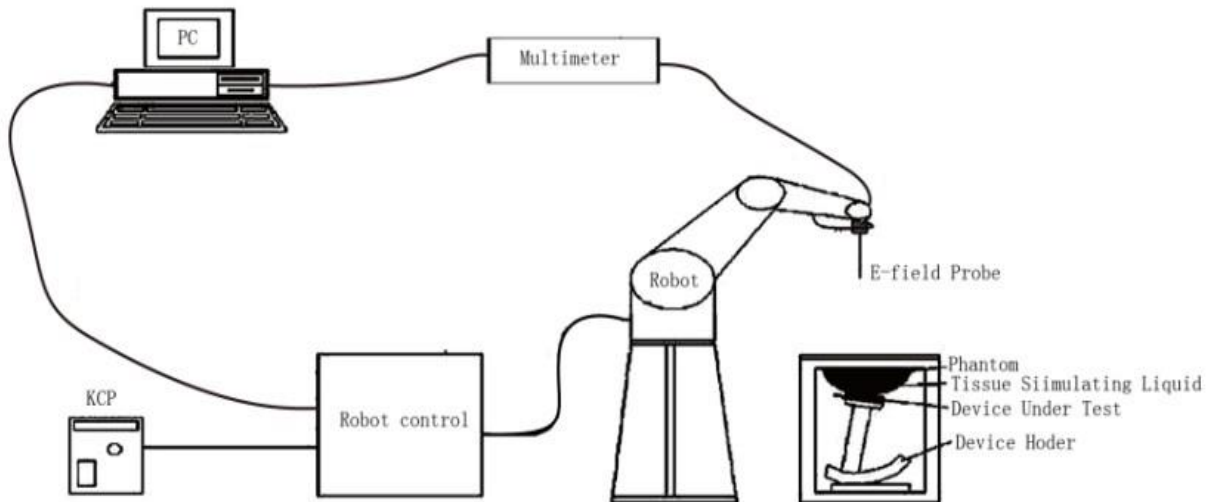

The COMOSAR system for performing compliance tests consists of the following items:

- The PC. It controls most of the bench devices and stores measurement data. A computer running WinXP and the Opensar software.
- The E-Field probe. The probe is a 3-axis system made of 3 distinct dipoles. Each dipole returns a voltage in function of the ambient electric field.
- The Keithley multimeter measures each probe dipole voltages.
- The SAM phantom simulates a human head. The measurement of the electric field is made inside the phantom.
- The liquids simulate the dielectric properties of the human head tissues.
- The network emulator controls the mobile phone under test.
- The validation dipoles are used to measure a reference SAR. They are used to periodically check the bench to make sure that there is no drift of the system characteristics over time.
- The phantom, the device holder and other accessories according to the targeted measurement.

3.2. COMOSAR E-Field Probe

The SAR measurement is conducted with the dosimetric probe manufactured by SATIMO. The probe is specially designed and calibrated for use in liquid with high permittivity. The dosimetric probe has special calibration in liquid at different frequency. SATIMO conducts the probe calibration in compliance with international and national standards (e.g. IEEE 1528 and relevant KDB files.) The calibration data are in Appendix D.

Isotropic E-Field Probe Specification

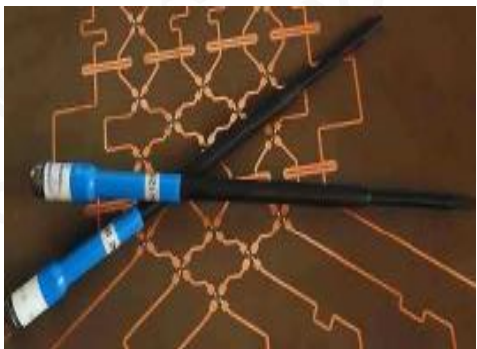
Model	SSE5	
Manufacture	MVG	
Identification No.	SN 22/12 EP159	
Frequency	0.45GHz-3GHz Linearity:±0.11dB(0.45GHz-3GHz)	
Dynamic Range	0.01W/Kg-100W/Kg Linearity:±0.11dB	
Dimensions	Overall length:330mm Length of individual dipoles:4.5mm Maximum external diameter:8mm Probe Tip external diameter:5mm Distance between dipoles/ probe extremity:2.7mm	
Application	High precision dosimetric measurements in any exposure scenario (e.g., very strong gradient fields). Only probe which enables compliance testing for frequencies up to 3 GHz with precisin of better 30%.	

Model	SSE2	
Manufacture	MVG	
Identification No.	SN 45/15 EPGO281	
Frequency	0.45GHz-6GHz Linearity:±0.11dB(0.45GHz-6GHz)	
Dynamic Range	0.01W/Kg-100W/Kg Linearity:±0.11dB	
Dimensions	Overall length:330mm Length of individual dipoles:2mm Maximum external diameter:8mm Probe Tip external diameter:2.5mm Distance between dipoles/ probe extremity:1mm	
Application	High precision dosimetric measurements in any exposure scenario (e.g., very strong gradient fields). Only probe which enables compliance testing for frequencies up to 6 GHz with precisin of better 30%.	



3.3. Robot

The COMOSAR system uses the KUKA robot from SATIMO SA (France). For the 6-axis controller COMOSAR system, the KUKA robot controller version from SATIMO is used.

The XL robot series have many features that are important for our application:

- High precision (repeatability 0.02 mm)
- High reliability (industrial design)
- Jerk-free straight movements
- Low ELF interference (the closed metallic construction shields against motor control fields)
- 6-axis controller



3.4. Video Positioning System

The video positioning system is used in OpenSAR to check the probe. Which is composed of a camera, LED, mirror and mechanical parts. The camera is piloted by the main computer with firewire link.

During the process, the actual position of the probe tip with respect to the robot arm is measured, as well as the probe length and the horizontal probe offset. The software then corrects all movements, such that the robot coordinates are valid for the probe tip.

The repeatability of this process is better than 0.1 mm. If a position has been taught with an aligned probe, the same position will be reached with another aligned probe within 0.1 mm, even if the other probe has different dimensions. During probe rotations, the probe tip will keep its actual position.

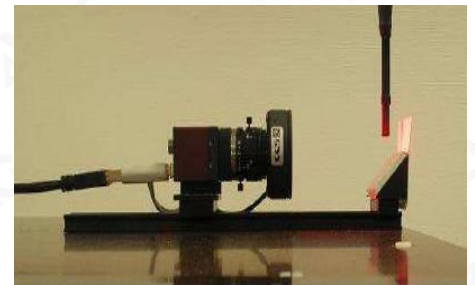

3.5. Device Holder

The COMOSAR device holder is designed to cope with different positions given in the standard. It has two scales for the device rotation (with respect to the body axis) and the device inclination (with respect to the line between the ear reference points). The rotation center for both scales is the ear reference point (EPR).

Thus the device needs no repositioning when changing the angles.

The COMOSAR device holder has been made out of low-loss POM material having the following dielectric parameters: relative permittivity

$\epsilon_r = 3$ and loss tangent $\delta = 0.02$. The amount of dielectric material has been reduced in the closest vicinity of the device, since measurements have suggested that the influence of the clamp on the test results could thus be lowered.

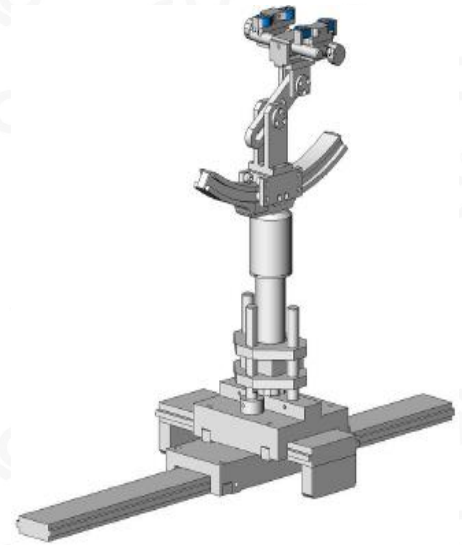

3.6. SAM Twin Phantom

The SAM twin phantom is a fiberglass shell phantom with 2mm shell thickness (except the ear region where shell thickness increases to 6mm). It has three measurement areas:

- Left head
- Right head
- Flat phantom



The bottom plate contains three pair of bolts for locking the device holder. The device holder positions are adjusted to the standard measurement positions in the three sections. A white cover is provided to tap the phantom during off-periods to prevent water evaporation and changes in the liquid parameters. On the phantom top, three reference markers are provided to identify the phantom position with respect to the robot.

3.7. ELLI39 Phantom

The Flat phantom is a fiberglass shell phantom with 2mm+/- 0.2 mm shell thickness. It has only one measurement area for Flat phantom



4. SAR MEASUREMENT PROCEDURE

4.1. Specific Absorption Rate (SAR)

SAR is related to the rate at which energy is absorbed per unit mass in object exposed to a radio field. The SAR distribution in a biological body is complicated and is usually carried out by experimental techniques or numerical modeling. The standard recommends limits for two tiers of groups, occupational/controlled and occupational/uncontrolled, based on a person's awareness and ability to exercise control over his or her exposure. In general, occupational/controlled exposure limits are higher than the limits for general population/uncontrolled.

The SAR definition is the time derivative (rate) of the incremental energy (dW) absorbed by (dissipated in) an incremental mass (dm) contained in a volume element(dv) of given mass density (ρ). The equation description is as below:

$$SAR = \frac{d}{dt} \left(\frac{dW}{dm} \right) = \frac{d}{dt} \left(\frac{dW}{\rho dV} \right)$$

SAR is expressed in units of Watts per kilogram (W/Kg)

SAR can be obtained using either of the following equations:

$$SAR = \frac{\sigma E^2}{\rho}$$

$$SAR = c_h \left. \frac{dT}{dt} \right|_{t=0}$$

Where

SAR	is the specific absorption rate in watts per kilogram;
E	is the r.m.s. value of the electric field strength in the tissue in volts per meter;
σ	is the conductivity of the tissue in siemens per metre;
ρ	is the density of the tissue in kilograms per cubic metre;
c _h	is the heat capacity of the tissue in joules per kilogram and Kelvin;
$\left. \frac{dT}{dt} \right _{t=0}$	is the initial time derivative of temperature in the tissue in kelvins per second



4.2. SAR Measurement Procedure

Step 1: Power Reference Measurement

The Power Reference Measurement and Power Drift Measurement are for monitoring the power drift of the device under test in the batch process. The minimum distance of probe sensors to surface is 2.7mm This distance cannot be smaller than the distance os sensor calibration points to probe tip as `defined in the probe properties,

Step 2: Area Scan

The Area Scan is used as a fast scan in two dimensions to find the area of high field values, before doing a fine measurement around the hot spot. The sophisticated interpolation routines implemented in SATIMO software can find the maximum locations even in relatively coarse grids. When an Area Scan has measured all reachable points, it computes the field maximal found in the scanned area, within a range of the global maximum. The range (in db) is specified in the standards for compliance testing. For example, a 2db range is required in IEEE Standard 1528 and IEC62209 standards, whereby 3db is a requirement when compliance is assessed in accordance with the ARIB standard (Japan) If one Zoom Scan follows the Area Scan, then only the absolute maximum will be taken as reference. For cases where multiple maximum are detected, the number of Zoom Scan has to be increased accordingly.

Area Scan Parameters extracted from KDB 865664 D01 SAR Measurement 100MHz to 6GHz

	≤ 3 GHz	> 3 GHz
Maximum distance from closest measurement point (geometric center of probe sensors) to phantom surface	5 ± 1 mm	$\frac{1}{2} \cdot \delta \cdot \ln(2) \pm 0.5$ mm
Maximum probe angle from probe axis to phantom surface normal at the measurement location	30° ± 1°	20° ± 1°
Maximum area scan spatial resolution: Δx_{Area} , Δy_{Area}	≤ 2 GHz: ≤ 15 mm 2 – 3 GHz: ≤ 12 mm	3 – 4 GHz: ≤ 12 mm 4 – 6 GHz: ≤ 10 mm
	When the x or y dimension of the test device, in the measurement plane orientation, is smaller than the above, the measurement resolution must be ≤ the corresponding x or y dimension of the test device with at least one measurement point on the test device.	

Step 3: Zoom Scan

Zoom Scan are used to assess the peak spatial SAR value within a cubic average volume containing 1g abd 10g of simulated tissue. The Zoom Scan measures points(refer to table below) within a cube whose base faces are centered on the maxima found in a preceding area scan job within the same procedure. When the measurement is done, the Zoom Scan evaluates the averaged SAR for 1g and 10g and displays these values next to the job's label.



Zoom Scan Parameters extracted from KDB865664 d01 SAR Measurement 100MHz to 6GHz

Maximum zoom scan spatial resolution: Δx_{Zoom} , Δy_{Zoom}		≤ 2 GHz: ≤ 8 mm 2 – 3 GHz: ≤ 5 mm*	3 – 4 GHz: ≤ 5 mm* 4 – 6 GHz: ≤ 4 mm*
Maximum zoom scan spatial resolution, normal to phantom surface	uniform grid: $\Delta z_{Zoom}(n)$	≤ 5 mm	3 – 4 GHz: ≤ 4 mm 4 – 5 GHz: ≤ 3 mm 5 – 6 GHz: ≤ 2 mm
	graded grid	$\Delta z_{Zoom}(1)$: between 1 st two points closest to phantom surface	≤ 4 mm
		$\Delta z_{Zoom}(n>1)$: between subsequent points	$\leq 1.5 \cdot \Delta z_{Zoom}(n-1)$
Minimum zoom scan volume	x, y, z	≥ 30 mm	3 – 4 GHz: ≥ 28 mm 4 – 5 GHz: ≥ 25 mm 5 – 6 GHz: ≥ 22 mm
<p>Note: δ is the penetration depth of a plane-wave at normal incidence to the tissue medium; see draft standard IEEE P1528-2011 for details.</p> <p>* When zoom scan is required and the <i>reported</i> SAR from the <i>area scan based 1-g SAR estimation</i> procedures of KDB 447498 is ≤ 1.4 W/kg, ≤ 8 mm, ≤ 7 mm and ≤ 5 mm zoom scan resolution may be applied, respectively, for 2 GHz to 3 GHz, 3 GHz to 4 GHz and 4 GHz to 6 GHz.</p>			

Step 4: Power Drift Measurement

The Power Drift Measurement measures the field at the same location as the most recent power reference measurement within the same procedure, and with the same settings. The Power Drift Measurement gives the field difference in dB from the reading conducted within the same settings. This allows a user to monitor the power drift of the device under test within a batch process. The measurement procedure is the same as Step 1.



Attestation of Global Compliance(Shenzhen)Co.,Ltd.

Add: 2/F., Building 2, No.1-4, Chaxi Sanwei Technial Industrial Park, Gushu, Xixiang, Bao'an District, Shenzhen, Guangdong, China

Tel: +86-755 2523 4088

E-mail: agc@agc-cert.com

Service Hotline:400 089 2118

4.3. RF Exposure Conditions

Test Configuration and setting:

The EUT is a model of GSM Portable Mobile Station (MS). It supports GSM/GPRS/EGPRS, WCDMA/HSPA, LTE, BT, WIFI, and support hot spot mode.

For WWAN SAR testing, the device was controlled by using a base station emulator. Communication between the device and the emulator were established by air link. The distance between the EUT and the antenna is larger than 50cm, and the output power radiated from the emulator antenna is at least 30db smaller than the output power of EUT.

For WLAN testing, the EUT is configured with the WLAN continuous TX tool through engineering command.

Antenna Location: (the back view)

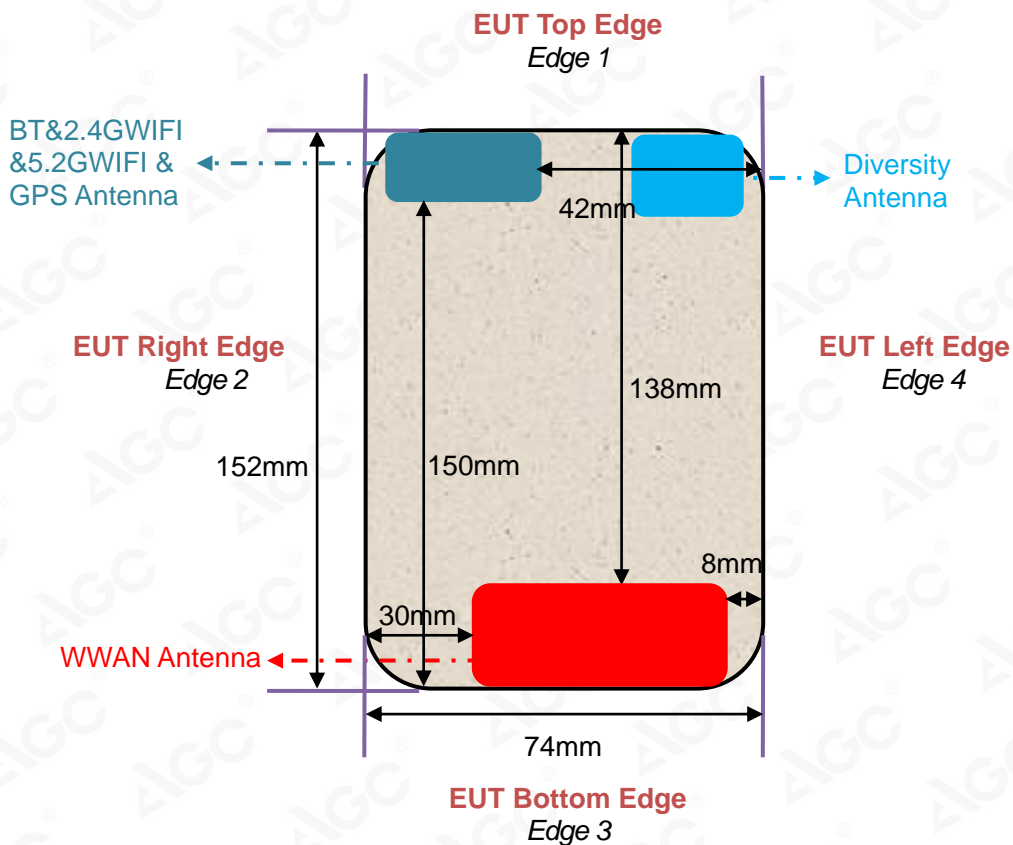

For WWAN mode:

Test Configurations	Antenna to edges/surface	SAR required	Note
Head			
Left Touch		Yes	--
Left Tilt		Yes	--
Right Touch		Yes	--
Right Tilt		Yes	--
Body			
Back	<25mm	Yes	--
Front	<25mm	Yes	--
Hotspot			
Back	<25mm	Yes	--
Front	<25mm	Yes	--
Edge 1 (Top)	138mm	No	SAR is not required for the distance between the antenna and the edge is >25mm as per KDB 941225 D06 Hotspot SAR
Edge 2 (Right)	30mm	No	SAR is not required for the distance between the antenna and the edge is >25mm as per KDB 941225 D06 Hotspot SAR
Edge 3 (Bottom)	0mm	Yes	--
Edge 4 (Left)	8mm	Yes	--

For WLAN mode:

Test Configurations	Antenna to edges/surface	SAR required	Note
Head			
Left Touch		Yes	--
Left Tilt		Yes	--
Right Touch		Yes	--
Right Tilt		Yes	--
Body			
Back	<25mm	Yes	--
Front	<25mm	Yes	--
Hotspot			
Back	<25mm	Yes	--
Front	<25mm	Yes	--
Edge 1 (Top)	0mm	Yes	--
Edge 2 (Right)	1mm	Yes	--
Edge 3 (Bottom)	150mm	No	SAR is not required for the distance between the antenna and the edge is >25mm as per KDB 941225 D06 Hotspot SAR
Edge 4 (Left)	42mm	No	SAR is not required for the distance between the antenna and the edge is >25mm as per KDB 941225 D06 Hotspot SAR



Attestation of Global Compliance(Shenzhen)Co.,Ltd.

Add: 2/F., Building 2, No.1-4, Chaxi Sanwei Technial Industrial Park, Gushu, Xixiang, Bao'an District, Shenzhen, Guangdong, China

Tel: +86-755 2523 4088

E-mail: agc@agc-cert.com

Service Hotline:400 089 2118

5. TISSUE SIMULATING LIQUID

For SAR measurement of the field distribution inside the phantom, the phantom must be filled with homogeneous tissue simulating liquid to a depth of at least 15cm. For head SAR testing the liquid height from the ear reference point (ERP) of the phantom to the liquid top surface is larger than 15cm For body SAR testing, the liquid height from the center of the flat phantom to the liquid top surface is larger than 15cm. The nominal dielectric values of the tissue simulating liquids in the phantom and the tolerance of 5% are listed in 5.2

5.1. The composition of the tissue simulating liquid

Frequency (MHz) \ Ingredient (% Weight)	Water	NaCl	Polysorbate 20	DGBE	1,2-Propanediol	Triton X-100	Diethylen glycol monohex ylether
750 Head	35	2	0.0	0.0	63	0.0	0.0
750 Body	55	1	0.0	0.0	44	0.0	0.0
835 Head	50.36	1.25	48.39	0.0	0.0	0.0	0.0
835 Body	54.00	1	0.0	15	0.0	30	0.0
1750 Head	52.64	0.36	0.0	47	0.0	0.0	0.0
1750 Body	70	1	0.0	9	0.0	20	0.0
1900 Head	54.9	0.18	0.0	44.92	0.0	0.0	0.0
1900 Body	70	1	0.0	9	0.0	20	0.0
2450 Head	71.88	0.16	0.0	7.99	0.0	19.97	0.0
2450 Body	70	1	0.0	9	0.0	20	0.0
2600 Head	55.242	0.306	0	44.452	0	0	0.0
2600 Body	70	1	0	9	0	20	0.0
5000 Head	65.52	0.0	0.0	0.0	0.0	17.24	17.24
5000 Body	80	0.0	0.0	10	0.0	10	0.0



Attestation of Global Compliance(Shenzhen)Co.,Ltd.

Add: 2/F., Building 2, No.1-4, Chaxi Sanwei Technial Industrial Park, Gushu, Xixiang, Bao'an District, Shenzhen, Guangdong, China

Tel: +86-755 2523 4088

E-mail: agc@agc-cert.com

Service Hotline:400 089 2118

5.2. Tissue Dielectric Parameters for Head and Body Phantoms

The head tissue dielectric parameters recommended by the IEEE 1528 have been incorporated in the following table. These head parameters are derived from planar layer models simulating the highest expected SAR for the dielectric properties and tissue thickness variations in a human head. Other head and body tissue parameters that have not been specified in IEEE 1528 are derived from the tissue dielectric parameters computed from the 4-Cole-Cole equations described in Reference [12] and extrapolated according to the head parameters specified in IEEE 1528.

Target Frequency (MHz)	head		body	
	ϵ_r	σ (S/m)	ϵ_r	σ (S/m)
300	45.3	0.87	58.2	0.92
450	43.5	0.87	56.7	0.94
750	41.9	0.89	55.5	0.96
835	41.5	0.90	55.2	0.97
900	41.5	0.97	55.0	1.05
915	41.5	1.01	55.0	1.06
1450	40.5	1.20	54.0	1.30
1610	40.3	1.29	53.8	1.40
1750	40.1	1.37	53.4	1.49
1800 – 2000	40.0	1.40	53.3	1.52
2450	39.2	1.80	52.7	1.95
2600	39.0	1.96	52.5	2.16
3000	38.5	2.40	52.0	2.73
5200	36.0	4.66	49.0	5.30

(ϵ_r = relative permittivity, σ = conductivity and $\rho = 1000$ kg/m³)



Attestation of Global Compliance(Shenzhen)Co.,Ltd.

Add: 2/F., Building 2, No.1-4, Chaxi Sanwei Technial Industrial Park, Gushu, Xixiang, Bao'an District, Shenzhen, Guangdong, China

Tel: +86-755 2523 4088

E-mail: agc@agc-cert.com

Service Hotline:400 089 2118

5.3. Tissue Calibration Result

The dielectric parameters of the liquids were verified prior to the SAR evaluation using SATIMO Dielectric Probe Kit and R&S Network Analyzer ZVL6.

Tissue Stimulant Measurement for 750MHz					
	Fr. (MHz)	Dielectric Parameters ($\pm 5\%$)		Tissue Temp [°C]	Test time
		ϵ_r 41.9 (39.805-43.995)	δ [s/m] 0.89(0.8455-0.9345)		
Head	704	41.45	0.86	20.8	Aug. 02,2019
	707.5	41.14	0.87		
	709	40.83	0.88		
	710	40.69	0.89		
	711	40.47	0.90		
	750	40.24	0.91		
	Fr. (MHz)	Dielectric Parameters ($\pm 5\%$)		Tissue Temp [°C]	Test time
		ϵ_r 55.5(52.725-58.275)	δ [s/m]0.96(0.912-1.008)		
Body	704	56.64	0.92	20.9	Aug. 02,2019
	707.5	56.39	0.93		
	709	56.02	0.93		
	710	55.71	0.94		
	711	55.45	0.94		
	750	55.20	0.95		

Tissue Stimulant Measurement for 835MHz					
	Fr. (MHz)	Dielectric Parameters ($\pm 5\%$)		Tissue Temp [°C]	Test time
		ϵ_r 41.5 (39.425-43.575)	δ [s/m] 0.90(0.855-0.945)		
Head	824.2	41.53	0.89	20.8	Aug. 04,2019
	826.4	41.21	0.90		
	835	40.98	0.91		
	836.6	40.74	0.92		
	846.6	40.56	0.93		
	848.8	40.35	0.94		
	Fr. (MHz)	Dielectric Parameters ($\pm 5\%$)		Tissue Temp [°C]	Test time
		ϵ_r 55.20(52.44-57.96)	δ [s/m]0.97(0.9215-1.0185)		
Body	824.2	54.89	0.93	20.9	Aug. 04,2019
	826.4	54.43	0.94		
	835	54.26	0.95		
	836.6	54.08	0.96		
	846.6	53.87	0.97		
	848.8	53.65	0.98		



Attestation of Global Compliance(Shenzhen)Co.,Ltd.

Add: 2/F., Building 2, No.1-4, Chaxi Sanwei Technial Industrial Park, Gushu, Xixiang, Bao'an District, Shenzhen, Guangdong, China

Tel: +86-755 2523 4088

E-mail: agc@agc-cert.com

Service Hotline:400 089 2118

Tissue Stimulant Measurement for 835MHz					
	Fr. (MHz)	Dielectric Parameters ($\pm 5\%$)		Tissue Temp [°C]	Test time
		ϵ_r 41.5 (39.425-43.575)	δ [s/m] 0.90(0.855-0.945)		
Head	829	41.54	0.88	20.3	Aug. 07,2019
	835	41.28	0.89		
	836.5	41.02	0.90		
	844	40.96	0.91		
	Fr. (MHz)	Dielectric Parameters ($\pm 5\%$)		Tissue Temp [°C]	Test time
		ϵ_r 55.20(52.44-57.96)	δ [s/m]0.97(0.9215-1.0185)		
Body	829	55.35	0.97	20.2	Aug. 07,2019
	835	55.16	0.98		
	836.5	55.01	0.99		
	844	54.96	1.00		

Tissue Stimulant Measurement for 1750MHz					
	Fr. (MHz)	Dielectric Parameters ($\pm 5\%$)		Tissue Temp [°C]	Test time
		ϵ_r 40.1 (38.095-42.105)	δ [s/m]1.37(1.3015-1.439)		
Head	1720	40.67	1.35	20.5	Aug. 03,2019
	1732.5	40.45	1.36		
	1745	40.12	1.37		
	1750	39.85	1.38		
	Fr. (MHz)	Dielectric Parameters ($\pm 5\%$)		Tissue Temp [°C]	Test time
		ϵ_r 53.4(50.73-56.07)	δ [s/m] 1.49(1.4155-1.5645)		
Body	1720	53.78	1.45	20.5	Aug. 03,2019
	1732.5	53.54	1.46		
	1745	53.39	1.47		
	1750	53.25	1.48		



Tissue Stimulant Measurement for 1900MHz					
	Fr. (MHz)	Dielectric Parameters ($\pm 5\%$)		Tissue Temp [°C]	Test time
		ϵ_r 40.00(38.00-42.00)	δ [s/m]1.40(1.33-1.47)		
Head	1850.2	40.96	1.38	20.8	Aug. 08,2019
	1852.4	40.71	1.39		
	1880	40.45	1.40		
	1900	40.28	1.41		
	1907.6	40.03	1.42		
	1909.8	39.87	1.43		
	Fr. (MHz)	Dielectric Parameters ($\pm 5\%$)		Tissue Temp [°C]	Test time
		ϵ_r 53.30(50.635-55.965)	δ [s/m]1.52(1.444-1.596)		
Body	1850.2	53.78	1.50	20.7	Aug. 08,2019
	1852.4	53.49	1.51		
	1880	53.26	1.52		
	1900	53.08	1.53		
	1907.6	52.85	1.54		
	1909.8	52.64	1.55		

Tissue Stimulant Measurement for 1900MHz					
	Fr. (MHz)	Dielectric Parameters ($\pm 5\%$)		Tissue Temp [°C]	Test time
		ϵ_r 40.00(38.00-42.00)	δ [s/m]1.40(1.33-1.47)		
Head	1860	39.65	1.40	20.9	Aug. 04,2019
	1880	39.41	1.41		
	1900	39.26	1.42		
	Fr. (MHz)	Dielectric Parameters ($\pm 5\%$)		Tissue Temp [°C]	Test time
		ϵ_r 53.30(50.635-55.965)	δ [s/m]1.52(1.444-1.596)		
Body	1860	51.84	1.45	20.8	Aug. 04,2019
	1880	51.69	1.46		
	1900	51.26	1.46		



Tissue Stimulant Measurement for 2450MHz					
	Fr. (MHz)	Dielectric Parameters ($\pm 5\%$)		Tissue Temp [°C]	Test time
		ϵ_r 39.2(37.24-41.16)	δ [s/m]1.80(1.71-1.89)		
Head	2412	40.27	1.78	20.8	Aug. 08,2019
	2437	39.81	1.79		
	2450	39.60	1.80		
	2462	39.45	1.81		
	Fr. (MHz)	Dielectric Parameters ($\pm 5\%$)		Tissue Temp [°C]	Test time
		ϵ_r 52.7(50.065-55.335)	δ [s/m]1.95(1.8525-2.0475)		
Body	2412	52.56	1.90	20.7	Aug. 08,2019
	2437	52.34	1.91		
	2450	52.10	1.92		
	2462	51.92	1.93		

Tissue Stimulant Measurement for 2600MHz					
	Fr. (MHz)	Dielectric Parameters ($\pm 5\%$)		Tissue Temp [°C]	Test time
		ϵ_r 39(37.05-40.95)	δ [s/m]1.96(1.86-2.06)		
Head	2510	39.47	1.92	20.5	Aug. 01,2019
	2535	39.14	1.93		
	2560	38.98	1.94		
	2600	38.62	1.95		
	Fr. (MHz)	Dielectric Parameters ($\pm 5\%$)		Tissue Temp [°C]	Test time
		ϵ_r 52.5(49.875-55.125)	δ [s/m]2.16(2.052-2.268)		
Body	2510	53.64	2.11	20.4	Aug. 01,2019
	2535	53.28	2.12		
	2560	52.86	2.13		
	2600	52.47	2.14		



Tissue Stimulant Measurement for 5200MHz					
	Fr. (MHz)	Dielectric Parameters ($\pm 5\%$)		Tissue Temp [°C]	Test time
		ϵ_r	δ [s/m]		
Head		36(34.2-37.8)	4.66(4.427-4.893)	20.3	Aug. 28,2019
	5180	35.75	4.60		
	5200	35.64	4.61		
	5220	35.21	4.62		
	5240	35.08	4.63		
Tissue Stimulant Measurement for 5200MHz					
	Fr. (MHz)	Dielectric Parameters ($\pm 5\%$)		Tissue Temp [°C]	Test time
		ϵ_r	δ [s/m]		
Body		49.0(46.55-51.450)	5.30(5.035 -5.565)	20.4	Aug. 28,2019
	5180	49.25	5.31		
	5200	48.90	5.32		
	5220	48.74	5.33		
	5240	48.36	5.34		



Attestation of Global Compliance(Shenzhen)Co.,Ltd.

Add: 2/F., Building 2, No.1-4, Chaxi Sanwei Technial Industrial Park, Gushu,
Xixiang, Bao'an District, Shenzhen, Guangdong, China

Tel: +86-755 2523 4088

E-mail: agc@agc-cert.com

Service Hotline:400 089 2118

6. SAR SYSTEM CHECK PROCEDURE

6.1. SAR System Check Procedures

SAR system check is required to confirm measurement accuracy, according to the tissue dielectric media, probe calibration points and other system operating parameters required for measuring the SAR of a test device. The system verification must be performed for each frequency band and within the valid range of each probe calibration point required for testing the device. The same SAR probe(s) and tissue-equivalent media combinations used with each specific SAR system for system verification must be used for device testing. When multiple probe calibration points are required to cover substantially large transmission bands, independent system verifications are required for each probe calibration point. A system verification must be performed before each series of SAR measurements using the same probe calibration point and tissue-equivalent medium. Additional system verification should be considered according to the conditions of the tissue-equivalent medium and measured tissue dielectric parameters, typically every three to four days when the liquid parameters are remeasured or sooner when marginal liquid parameters are used at the beginning of a series of measurements.

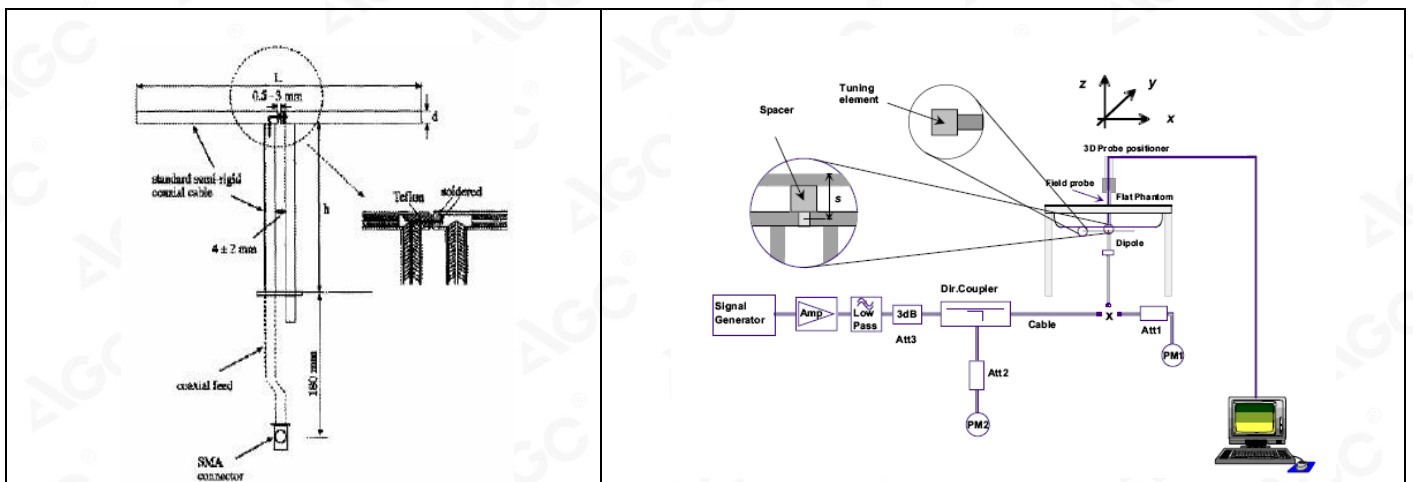

Each SATIMO system is equipped with one or more system check kits. These units, together with the predefined measurement procedures within the SATIMO software, enable the user to conduct the system check and system validation. System kit includes a dipole, and dipole device holder.

The system check verifies that the system operates within its specifications. It's performed daily or before every SAR measurement. The system check uses normal SAR measurement in the flat section of the phantom with a matched dipole at a specified distance. The system check setup is shown as below.

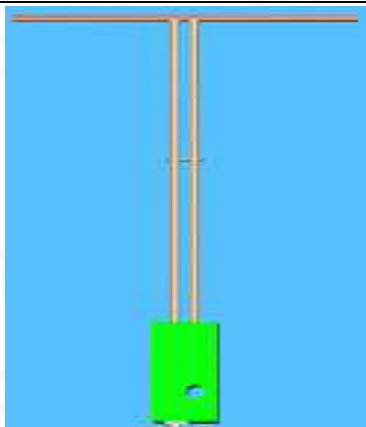

6.2. SAR System Check

6.2.1. Dipoles

	<p>The dipoles used are based on the IEEE-1528 standard, and is complied with mechanical and electrical specifications in line with the requirements of IEEE. the table below provides details for the mechanical and electrical Specifications for the dipoles.</p>
	<p>The wave guide used is based on the IEEE-1528 standard, and is complied with mechanical and electrical specifications in line with the requirements of IEEE. the table below provides details for the mechanical and electrical specifications for the wave guide.</p>

Frequency	L (mm)	h (mm)	d (mm)
750MHz	176	100	6.35
835MHz	161.0	89.8	3.6
1800MHz	71.6	41.7	3.6
1900MHz	68	39.5	3.6
2450MHz	51.5	30.4	3.6
2600MHz	48.5	28.8	3.6

Frequency	L (mm)	W (mm)	L _f (mm)	W _f (mm)
5000MHz	40.39	20.19	81.03	61.98



6.2.2. System Check Result

System Performance Check at 750MHz&835MHz &1800MHz &1900MHz&2450MHz&2600MHz &5000-6000MHz for Head								
Validation Kit: SN47/14 DIP 0G750-340& SN29/15 DIP 0G835-383& SN46/11 DIP 1G800-186& SN 46/11 DIP 1G900-187& SN46/11 DIP 2G450-189& SN 47/14 DIP 2G600-342&SN 15/15 WGA 36								
Frequency [MHz]	Target Value(W/Kg)		Reference Result ($\pm 10\%$)		Tested Value(W/Kg)		Tissue Temp. [°C]	Test time
	1g	10g	1g	10g	1g	10g		
750	8.31	5.45	7.479-9.141	4.905-5.995	8.33	5.25	20.8	Aug. 02,2019
835	9.85	6.27	8.865-10.835	5.643-6.897	9.90	6.66	20.8	Aug. 04,2019
835	9.85	6.27	8.865-10.835	5.643-6.897	9.17	5.91	20.3	Aug. 07,2019
1800	39.07	20.29	35.163-42.977	18.261-22.319	37.51	20.40	20.5	Aug. 03,2019
1900	40.25	20.50	36.225-44.275	18.45-22.55	40.00	21.43	20.8	Aug. 08,2019
1900	40.25	20.50	36.225-44.275	18.45-22.55	42.34	21.89	20.9	Aug. 04,2019
2450	53.97	24.01	48.573-59.367	21.609-26.411	51.09	23.65	20.8	Aug. 08,2019
2600	56.86	24.84	51.174-62.546	22.356-27.324	51.69	24.04	20.5	Aug. 01,2019
5200	161.18	55.04	145.062-177.298	49.536-60.544	159.78	55.11	20.5	Aug. 08,2019
System Performance Check at 750MHz & 835MHz &1800MHz &1900MHz &2450MHz &2600MHz &5000-6000MHz for Body								
Frequency [MHz]	Target Value(W/Kg)		Reference Result ($\pm 10\%$)		Tested Value(W/Kg)		Tissue Temp. [°C]	Test time
	1g	10g	1g	10g	1g	10g		
750	8.45	5.67	7.605-9.295	5.103-6.237	8.58	5.61	20.9	Aug. 02,2019
835	9.95	6.50	8.955-10.945	5.85-7.15	9.81	6.47	20.9	Aug. 04,2019
835	9.95	6.50	8.955-10.945	5.85-7.15	9.59	6.33	20.2	Aug. 07,2019
1800	39.23	20.56	35.307-43.153	18.504-22.616	38.84	20.31	20.5	Aug. 03,2019
1900	40.82	20.99	36.738-44.902	18.891-23.089	44.48	19.85	20.7	Aug. 08,2019
1900	40.82	20.99	36.738-44.902	18.891-23.089	41.58	20.64	20.8	Aug. 04,2019
2450	54.45	24.16	49.005-59.895	21.744-26.576	51.62	23.27	20.7	Aug. 08,2019
2600	56.51	24.25	50.859-62.161	21.825-26.675	54.25	23.82	20.4	Aug. 01,2019
5200	151.71	53.57	136.539-166.881	48.213-58.927	154.45	52.13	20.5	Aug. 04,2019

Note:

(1) We use a CW signal of 18dBm or 15dBm for system check, and then all SAR value are normalized to 1W forward power. The result must be within $\pm 10\%$ of target value.



Attestation of Global Compliance(Shenzhen)Co.,Ltd.

Add: 2/F., Building 2, No.1-4, Chaxi Sanwei Technial Industrial Park, Gushu, Xixiang, Bao'an District, Shenzhen, Guangdong, China

Tel: +86-755 2523 4088

E-mail: agc@agc-cert.com

Service Hotline:400 089 2118

7. EUT TEST POSITION

This EUT was tested in **Right Cheek, Right Tilted, Left Cheek, Left Tilted, Body back, Body front and 4 edges.**

7.1. Define Two Imaginary Lines on the Handset

- (1) The vertical centerline passes through two points on the front side of the handset: the midpoint of the width w_t of the handset at the level of the acoustic output, and the midpoint of the width w_b of the handset.
- (2) The horizontal line is perpendicular to the vertical centerline and passes through the center of the acoustic output. The horizontal line is also tangential to the face of the handset at point A.
- (3) The two lines intersect at point A. Note that for many handsets, point A coincides with the center of the acoustic output; however, the acoustic output may be located elsewhere on the horizontal line. Also note that the vertical centerline is not necessarily to the front face of the handset, especially for clamshell handsets, handsets with flip covers, and other irregularly shaped handsets.

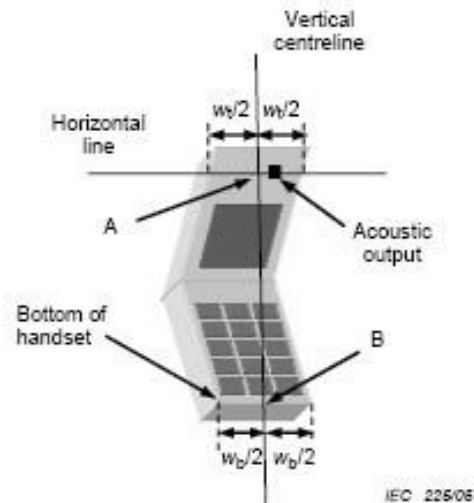
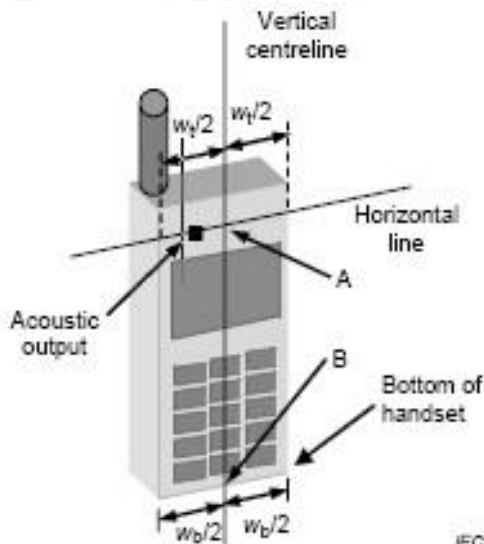

7.2. Cheek Position

- (1) To position the device with the vertical center line of the body of the device and the horizontal line crossing the center piece in a plane parallel to the sagittal plane of the phantom. While maintaining the device in this plane, align the vertical center line with the reference plane containing the ear and mouth reference point (M: Mouth, RE: Right Ear, and LE: Left Ear) and align the center of the ear piece with the line RE-LE.
- (2) To move the device towards the phantom with the ear piece aligned with the the line LE-RE until the phone touched the ear. While maintaining the device in the reference plane and maintaining the phone contact with ear, move the bottom of the phone until any point on the front side is in contact with the cheek of the phantom or until contact with the ear is lost



7.3. Tilt Position

- (1) To position the device in the “cheek” position described above.
- (2) While maintaining the device in the reference plane described above and pivoting against the ear, moves it outward away from the mouth by an angle of 15 degrees or until with the ear is lost.



7.4. Body Worn Position

- (1) To position the EUT parallel to the phantom surface.
- (2) To adjust the EUT parallel to the flat phantom.
- (3) To adjust the distance between the EUT surface and the flat phantom to **10mm**.

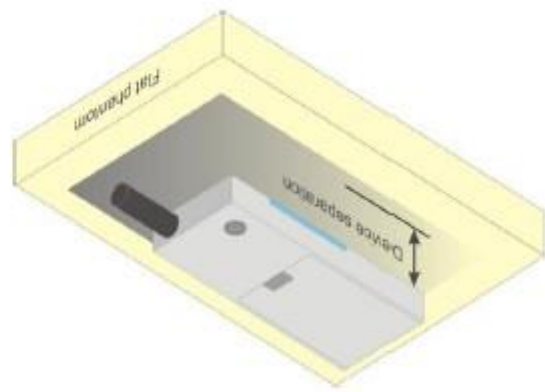
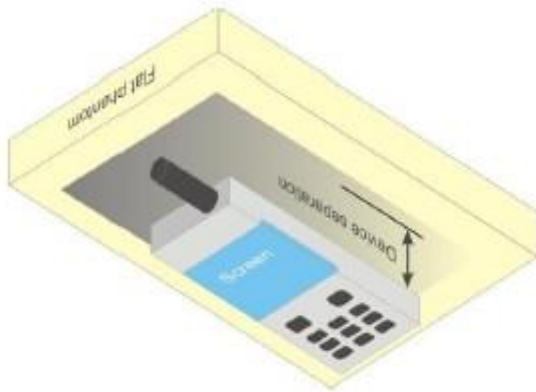

8. SAR EXPOSURE LIMITS

Limits for General Population/Uncontrolled Exposure (W/kg)

Type Exposure	Uncontrolled Environment Limit (W/kg)
Spatial Peak SAR (1g cube tissue for brain or body)	1.60
Spatial Average SAR (Whole body)	0.08
Spatial Peak SAR (Limbs)	4.0



Attestation of Global Compliance(Shenzhen)Co.,Ltd.

Add: 2/F., Building 2, No.1-4, Chaxi Sanwei Technial Industrial Park, Gushu,
Xixiang, Bao'an District, Shenzhen, Guangdong, China

Tel: +86-755 2523 4088

E-mail: agc@agc-cert.com

Service Hotline:400 089 2118

9. TEST FACILITY

Test Site	Attestation of Global Compliance (Shenzhen) Co., Ltd
Location	1-2/F, Building 19, Junfeng Industrial Park, Chongqing Road, Heping Community, Fuhai Street, Bao'an District, Shenzhen, Guangdong, China
Designation Number	CN1259
FCC Test Firm Registration Number	975832
A2LA Cert. No.	5054.02
Description	Attestation of Global Compliance(Shenzhen) Co., Ltd is accredited by A2LA



Attestation of Global Compliance(Shenzhen)Co.,Ltd.

Add: 2/F., Building 2, No.1-4, Chaxi Sanwei Technial Industrial Park, Gushu, Xixiang, Bao'an District, Shenzhen, Guangdong, China

Tel: +86-755 2523 4088

E-mail: agc@agc-cert.com

Service Hotline:400 089 2118

10. TEST EQUIPMENT LIST

Equipment description	Manufacturer/ Model	Identification No.	Current calibration date	Next calibration date
SAR Probe	MVG	SN 22/12 EP159	Aug. 08,2018	Aug. 07,2019
SAR Probe	MVG	SN 45/15 EPGO281	Mar. 25,2019	Mar. 24,2020
Phantom	SATIMO	SN_4511_SAM90	Validated. No cal required.	Validated. No cal required.
Phantom	SATIMO	ELLI39	Validated. No cal required.	Validated. No cal required.
Liquid	SATIMO	-	Validated. No cal required.	Validated. No cal required.
Comm Tester	Agilent-8960	GB46310822	Feb. 27,2019	Feb. 26,2020
Comm Tester	R&S- CMW500	S/N120909	Jul. 02,2019	Jul. 01,2020
Multimeter	Keithley 2000	4114939	Sep. 20,2018	Sep. 19,2019
Dipole	SATIMO SID750	SN47/14 DIP 0G750-340	Apr. 26,2019	Apr. 25,2022
Dipole	SATIMO SID835	SN29/15 DIP 0G835-383	Apr. 26,2019	Apr. 25,2022
Dipole	SATIMO SID1800	SN46/11 DIP 1G800-186	Apr. 26,2019	Apr. 25,2022
Dipole	SATIMO SID1900	SN 46/11 DIP 1G900-187	Apr. 26,2019	Apr. 25,2022
Dipole	SATIMO SID2450	SN46/11 DIP 2G450-189	Apr. 26,2019	Apr. 25,2022
Dipole	SATIMO SID2600	SN 47/14 DIP 2G600-342	Apr. 26,2019	Apr. 25,2022
Dipole	SATIMO SWG5500	SN 15/15 WGA36	Apr. 26,2019	Apr. 25,2022
Signal Generator	Agilent-E4438C	US41461365	Nov. 01,2018	Oct. 31,2019
Vector Analyzer	Agilent / E4440A	US41421290	Feb. 27,2019	Feb. 26,2020
Network Analyzer	Rhode & Schwarz ZVL6	SN101443	Nov. 01,2018	Oct. 31,2019
Attenuator	Warison /WATT-6SR1211	S/N:WRJ34AYM2F1	June 11,2019	June 10, 2020
Attenuator	Mini-circuits / VAT-10+	31405	June 11,2019	June 10, 2020
Amplifier	EM30180	SN060552	Feb. 27,2019	Feb. 26,2020
Directional Couple	Werlatone/ C5571-10	SN99463	June 12,2019	June 11,2020
Directional Couple	Werlatone/ C6026-10	SN99482	June 12,2019	June 11,2020
Power Sensor	NRP-Z21	1137.6000.02	Sep. 20,2018	Sep. 19,2019
Power Sensor	NRP-Z23	US38261498	Feb. 19,2019	Feb. 18,2020
Power Viewer	R&S	V2.3.1.0	N/A	N/A

Note: Per KDB 865664 Dipole SAR Validation, AGC Lab has adopted 3 years calibration intervals. On annual basis, every measurement dipole has been evaluated and is in compliance with the following criteria:

1. There is no physical damage on the dipole;
2. System validation with specific dipole is within 10% of calibrated value;
3. Return-loss is within 20% of calibrated measurement;
4. Impedance is within 5Ω of calibrated measurement.



Attestation of Global Compliance(Shenzhen)Co.,Ltd.

Add: 2/F., Building 2, No.1-4, Chaxi Sanwei Technial Industrial Park, Gushu,
Xixiang, Bao'an District, Shenzhen, Guangdong, China

Tel: +86-755 2523 4088

E-mail: agc@agc-cert.com

Service Hotline:400 089 2118

11. MEASUREMENT UNCERTAINTY

Measurement uncertainty for Dipole averaged over 1 gram / 10 gram.									
a	b	c	d	e f(d,k)	f	g	h cx _f /e	i cx _g /e	k
Uncertainty Component	Sec.	Tol (± %)	Prob. Dist.	Div.	Ci (1g)	Ci (10g)	1g U _i (±%)	10g U _i (±%)	vi
Measurement System									
Probe calibration	E.2.1	5.831	N	1	1	1	5.83	5.83	∞
Axial Isotropy	E.2.2	0.695	R	$\sqrt{3}$	$\sqrt{0.5}$	$\sqrt{0.5}$	0.28	0.28	∞
Hemispherical Isotropy	E.2.2	1.045	R	$\sqrt{3}$	$\sqrt{0.5}$	$\sqrt{0.5}$	0.43	0.43	∞
Boundary effect	E.2.3	1.0	R	$\sqrt{3}$	1	1	0.58	0.58	∞
Linearity	E.2.4	0.685	R	$\sqrt{3}$	1	1	0.40	0.40	∞
System detection limits	E.2.4	1.0	R	$\sqrt{3}$	1	1	0.58	0.58	∞
Modulation response	E.2.5	3.0	R	$\sqrt{3}$	1	1	1.73	1.73	∞
Readout Electronics	E.2.6	0.021	N	1	1	1	0.021	0.021	∞
Response Time	E.2.7	0	R	$\sqrt{3}$	1	1	0	0	∞
Integration Time	E.2.8	1.4	R	$\sqrt{3}$	1	1	0.81	0.81	∞
RF ambient conditions-Noise	E.6.1	3.0	R	$\sqrt{3}$	1	1	1.73	1.73	∞
RF ambient conditions-reflections	E.6.1	3.0	R	$\sqrt{3}$	1	1	1.73	1.73	∞
Probe positioner mechanical tolerance	E.6.2	1.4	R	$\sqrt{3}$	1	1	0.81	0.81	∞
Probe positioning with respect to phantom shell	E.6.3	1.4	R	$\sqrt{3}$	1	1	0.81	0.81	∞
Extrapolation, interpolation, and integrations algorithms for max. SAR evaluation	E.5	2.3	R	$\sqrt{3}$	1	1	1.33	1.33	∞
Test sample Related									
Test sample positioning	E.4.2	2.6	N	1	1	1	2.6	2.6	∞
Device holder uncertainty	E.4.1	3	N	1	1	1	3	3	∞
Output power variation—SAR drift measurement	E.2.9	5	R	$\sqrt{3}$	1	1	2.89	2.89	∞
SAR scaling	E.6.5	5	R	$\sqrt{3}$	1	1	2.89	2.89	∞
Phantom and tissue parameters									
Phantom shell uncertainty—shape, thickness, and permittivity	E.3.1	4	R	$\sqrt{3}$	1	1	2.31	2.31	∞
Uncertainty in SAR correction for deviations in permittivity and conductivity	E.3.2	1.9	N	1	1	0.84	1.90	1.60	∞
Liquid conductivity measurement	E.3.3	4	N	1	0.78	0.71	3.12	2.84	M
Liquid permittivity measurement	E.3.3	5	N	1	0.23	0.26	1.15	1.30	M
Liquid conductivity—temperature uncertainty	E.3.4	2.5	R	$\sqrt{3}$	0.78	0.71	1.13	1.02	∞
Liquid permittivity—temperature uncertainty	E.3.4	2.5	R	$\sqrt{3}$	0.23	0.26	0.33	0.38	∞
Combined Standard Uncertainty			RSS				9.79	9.59	
Expanded Uncertainty (95% Confidence interval)			K=2				19.58	19.18	



Attestation of Global Compliance(Shenzhen)Co.,Ltd.

Add: 2/F., Building 2, No.1-4, Chaxi Sanwei Technial Industrial Park, Gushu, Xixiang, Bao'an District, Shenzhen, Guangdong, China

Tel: +86-755 2523 4088

E-mail: agc@agc-cert.com

Service Hotline:400 089 2118

System check uncertainty for Dipole averaged over 1 gram / 10 gram.									
a	b	c	d	e f(d,k)	f	g	h cx _f /e	i cx _g /e	k
Uncertainty Component	Sec.	Tol (± %)	Prob. Dist.	Div.	Ci (1g)	Ci (10g)	1g U _i (±%)	10g U _i (±%)	v _i
Measurement System									
Probe calibration drift	E.2.1.3	0.5	N	1	1	1	0.50	0.50	∞
Axial Isotropy	E.2.2	0.695	R	$\sqrt{3}$	0	0	0.00	0.00	∞
Hemispherical Isotropy	E.2.2	1.045	R	$\sqrt{3}$	0	0	0.00	0.00	∞
Boundary effect	E.2.3	1.0	R	$\sqrt{3}$	0	0	0.00	0.00	∞
Linearity	E.2.4	0.685	R	$\sqrt{3}$	0	0	0.00	0.00	∞
System detection limits	E.2.4	1.0	R	$\sqrt{3}$	0	0	0.00	0.00	∞
Modulation response	E.2.5	3.0	R	$\sqrt{3}$	0	0	0.00	0.00	∞
Readout Electronics	E.2.6	0.021	N	1	0	0	0.00	0.00	∞
Response Time	E.2.7	0	R	$\sqrt{3}$	0	0	0.00	0.00	∞
Integration Time	E.2.8	1.4	R	$\sqrt{3}$	0	0	0.00	0.00	∞
RF ambient conditions-Noise	E.6.1	3.0	R	$\sqrt{3}$	0	0	0.00	0.00	∞
RF ambient conditions-reflections	E.6.1	3.0	R	$\sqrt{3}$	0	0	0.00	0.00	∞
Probe positioner mechanical tolerance	E.6.2	1.4	R	$\sqrt{3}$	1	1	0.81	0.81	∞
Probe positioning with respect to phantom shell	E.6.3	1.4	R	$\sqrt{3}$	1	1	0.81	0.81	∞
Extrapolation, interpolation, and integrations algorithms for max. SAR evaluation	E.5	2.3	R	$\sqrt{3}$	0	0	0.00	0.00	∞
System check source (dipole)									
Deviation of experimental dipoles	E.6.4	2	N	1	1	1	2	2	∞
Input power and SAR drift measurement	8,6.6.4	5	R	$\sqrt{3}$	1	1	2.89	2.89	∞
Dipole axis to liquid distance	8,E.6.6	2	R	$\sqrt{3}$	1	1	1.15	1.15	∞
Phantom and tissue parameters									
Phantom shell uncertainty—shape, thickness, and permittivity	E.3.1	4	R	$\sqrt{3}$	1	1	2.31	2.31	∞
Uncertainty in SAR correction for deviations in permittivity and conductivity	E.3.2	1.9	N	1	1	0.84	1.90	1.60	∞
Liquid conductivity measurement	E.3.3	4	N	1	0.78	0.71	3.12	2.84	M
Liquid permittivity measurement	E.3.3	5	N	1	0.23	0.26	1.15	1.30	M
Liquid conductivity—temperature uncertainty	E.3.4	2.5	R	$\sqrt{3}$	0.78	0.71	1.13	1.02	∞
Liquid permittivity—temperature uncertainty	E.3.4	2.5	R	$\sqrt{3}$	0.23	0.26	0.33	0.38	∞
Combined Standard Uncertainty			RSS				5.564	5.205	
Expanded Uncertainty (95% Confidence interval)			K=2				11.128	10.410	



Attestation of Global Compliance(Shenzhen)Co.,Ltd.

Add: 2/F., Building 2, No.1-4, Chaxi Sanwei Technial Industrial Park, Gushu, Xixiang, Bao'an District, Shenzhen, Guangdong, China

Tel: +86-755 2523 4088

E-mail: agc@agc-cert.com

Service Hotline:400 089 2118

System Validation uncertainty for Dipole averaged over 1 gram / 10 gram.									
a	b	c	d	e f(d,k)	f	g	h cx _f /e	i cx _g /e	k
Uncertainty Component	Sec.	Tol (±%)	Prob. Dist.	Div.	Ci (1g)	Ci (10g)	1g Ui (±%)	10g Ui (±%)	vi
Measurement System									
Probe calibration	E.2.1	5.831	N	1	1	1	5.83	5.83	∞
Axial Isotropy	E.2.2	0.695	R	$\sqrt{3}$	1	1	0.40	0.40	∞
Hemispherical Isotropy	E.2.2	1.045	R	$\sqrt{3}$	0	0	0.00	0.00	∞
Boundary effect	E.2.3	1.0	R	$\sqrt{3}$	1	1	0.58	0.58	∞
Linearity	E.2.4	0.685	R	$\sqrt{3}$	1	1	0.40	0.40	∞
System detection limits	E.2.4	1.0	R	$\sqrt{3}$	1	1	0.58	0.58	∞
Modulation response	E.2.5	3.0	R	$\sqrt{3}$	0	0	0.00	0.00	∞
Readout Electronics	E.2.6	0.021	N	1	1	1	0.021	0.021	∞
Response Time	E.2.7	0.0	R	$\sqrt{3}$	0	0	0.00	0.00	∞
Integration Time	E.2.8	1.4	R	$\sqrt{3}$	0	0	0.00	0.00	∞
RF ambient conditions-Noise	E.6.1	3.0	R	$\sqrt{3}$	1	1	1.73	1.73	∞
RF ambient conditions-reflections	E.6.1	3.0	R	$\sqrt{3}$	1	1	1.73	1.73	∞
Probe positioner mechanical tolerance	E.6.2	1.4	R	$\sqrt{3}$	1	1	0.81	0.81	∞
Probe positioning with respect to phantom shell	E.6.3	1.4	R	$\sqrt{3}$	1	1	0.81	0.81	∞
Extrapolation, interpolation, and integrations algorithms for max. SAR evaluation	E.5	2.3	R	$\sqrt{3}$	1	1	1.33	1.33	∞
System check source (dipole)									
Deviation of experimental dipole from numerical dipole	E.6.4	5.0	N	1	1	1	5.00	5.00	∞
Input power and SAR drift measurement	8,6.6.4	5.0	R	$\sqrt{3}$	1	1	2.89	2.89	∞
Dipole axis to liquid distance	8,E.6.6	2.0	R	$\sqrt{3}$	1	1	1.15	1.15	∞
Phantom and tissue parameters									
Phantom shell uncertainty—shape, thickness, and permittivity	E.3.1	4.0	R	$\sqrt{3}$	1	1	2.31	2.31	∞
Uncertainty in SAR correction for deviations in permittivity and conductivity	E.3.2	1.9	N	1	1	0.84	1.90	1.60	∞
Liquid conductivity measurement	E.3.3	4.0	N	1	0.78	0.71	3.12	2.84	M
Liquid permittivity measurement	E.3.3	5.0	N	1	0.23	0.26	1.15	1.30	M
Liquid conductivity—temperature uncertainty	E.3.4	2.5	R	$\sqrt{3}$	0.78	0.71	1.13	1.02	∞
Liquid permittivity—temperature uncertainty	E.3.4	2.5	R	$\sqrt{3}$	0.23	0.26	0.33	0.38	∞
Combined Standard Uncertainty				RSS			9.718	9.517	
Expanded Uncertainty (95% Confidence interval)				K=2			19.437	19.035	



Attestation of Global Compliance(Shenzhen)Co.,Ltd.

Add: 2/F., Building 2, No.1-4, Chaxi Sanwei Technial Industrial Park, Gushu, Xixiang, Bao'an District, Shenzhen, Guangdong, China

Tel: +86-755 2523 4088

E-mail: agc@agc-cert.com

Service Hotline:400 089 2118

SATIMO Uncertainty- SN 45/15 EP281									
Measurement uncertainty for DUT averaged over 1 gram / 10 gram.									
Uncertainty Component	Sec.	Tol (+-%)	Prob. Dist.	Div.	Ci (1g)	Ci (10g)	1g Ui (+-%)	10g Ui (+-%)	vi
Measurement System									
Probe calibration	E.2.1	5.831	N	1	1	1	5.83	5.83	∞
Axial Isotropy	E.2.2	0.685	R	$\sqrt{3}$	$\sqrt{0.5}$	$\sqrt{0.5}$	0.28	0.28	∞
Hemispherical Isotropy	E.2.2	0.915	R	$\sqrt{3}$	$\sqrt{0.5}$	$\sqrt{0.5}$	0.37	0.37	∞
Boundary effect	E.2.3	1	R	$\sqrt{3}$	1	1	0.58	0.58	∞
Linearity	E.2.4	1.3	R	$\sqrt{3}$	1	1	0.75	0.75	∞
System detection limits	E.2.4	1.000	R	$\sqrt{3}$	1	1	0.577	0.577	∞
Modulation response	E.2.5	3.000	R	$\sqrt{3}$	1	1	1.732	1.732	∞
Readout Electronics	E.2.6	0.021	N	1	1	1	0.021	0.021	∞
Response Time	E.2.7	0.000	R	$\sqrt{3}$	1	1	0.000	0.000	∞
Integration Time	E.2.8	1.400	R	$\sqrt{3}$	1	1	0.808	0.808	∞
RF ambient conditions-Noise	E.6.1	3.000	R	$\sqrt{3}$	1	1	1.732	1.732	∞
RF ambient conditions-reflections	E.6.1	3.000	R	$\sqrt{3}$	1	1	1.732	1.732	∞
Probe positioner mechanical tolerance	E.6.2	1.400	R	$\sqrt{3}$	1	1	0.808	0.808	∞
Probe positioning with respect to phantom shell	E.6.3	1.400	R	$\sqrt{3}$	1	1	0.808	0.808	∞
Post-processing	E.5	2.300	R	$\sqrt{3}$	1	1	1.328	1.328	∞
Test sample Related									
Test sample positioning	E.4.2	2.6	N	1	1	1	2.600	2.600	∞
Device holder uncertainty	E.4.1	3	N	1	1	1	3.000	3.000	∞
SAR drift measurement	E.2.9	5	R	$\sqrt{3}$	1	1	2.887	2.887	∞
SAR scaling	E.6.5	5	R	$\sqrt{3}$	1	1	2.887	2.887	∞
Phantom and tissue parameters									
Phantom uncertainty (shape and thickness uncertainty)	E.3.1	4	R	$\sqrt{3}$	1	1	2.309	2.309	∞
Uncertainty in SAR correction for deviations in permittivity and conductivity	E.3.2	1.9	N	1	1	0.84	1.900	1.596	∞
Liquid conductivity (temperature uncertainty)	E.3.3	2.5	R	$\sqrt{3}$	0.78	0.71	1.126	1.025	∞
Liquid conductivity (measured)	E.3.3	4	N	1	0.78	0.71	3.120	2.840	M
Liquid permittivity (temperature uncertainty)	E.3.4	2.5	R	$\sqrt{3}$	0.23	0.26	0.332	0.375	∞
Liquid permittivity (measured)	E.3.4	5	N	1	0.23	0.26	1.150	1.300	M
Combined Standard Uncertainty			RSS				9.808	9.609	
Expanded Uncertainty (95% Confidence interval)			K=2				19.617	19.219	



Attestation of Global Compliance(Shenzhen)Co.,Ltd.

Add: 2/F., Building 2, No.1-4, Chaxi Sanwei Technial Industrial Park, Gushu, Xixiang, Bao'an District, Shenzhen, Guangdong, China

Tel: +86-755 2523 4088

E-mail: agc@agc-cert.com

Service Hotline:400 089 2118

SATIMO Uncertainty- SN 45/15 EP281									
System Validation uncertainty for DUT averaged over 1 gram / 10 gram.									
Uncertainty Component	Sec.	Tol (+-%)	Prob. Dist.	Div.	Ci (1g)	Ci (10g)	1g Ui (+-%)	10g Ui (+-%)	vi
Measurement System									
Probe calibration	E.2.1	5.831	N	1	1	1	5.831	5.831	∞
Axial Isotropy	E.2.2	0.685	R	$\sqrt{3}$	1	1	0.395	0.395	∞
Hemispherical Isotropy	E.2.2	0.915	R	$\sqrt{3}$	0	0	0.000	0.000	∞
Boundary effect	E.2.3	1	R	$\sqrt{3}$	1	1	0.577	0.577	∞
Linearity	E.2.4	1.3	R	$\sqrt{3}$	1	1	0.751	0.751	∞
System detection limits	E.2.4	1.0	R	$\sqrt{3}$	1	1	0.58	0.58	∞
Modulation response	E.2.5	3.0	R	$\sqrt{3}$	0	0	0.00	0.00	∞
Readout Electronics	E.2.6	0.021	N	1	1	1	0.021	0.021	∞
Response Time	E.2.7	0.0	R	$\sqrt{3}$	0	0	0.00	0.00	∞
Integration Time	E.2.8	1.4	R	$\sqrt{3}$	0	0	0.00	0.00	∞
RF ambient conditions-Noise	E.6.1	3.0	R	$\sqrt{3}$	1	1	1.73	1.73	∞
RF ambient conditions-reflections	E.6.1	3.0	R	$\sqrt{3}$	1	1	1.73	1.73	∞
Probe positioner mechanical tolerance	E.6.2	1.4	R	$\sqrt{3}$	1	1	0.81	0.81	∞
Probe positioning with respect to phantom shell	E.6.3	1.4	R	$\sqrt{3}$	1	1	0.81	0.81	∞
Post-Processing	E.5	2.3	R	$\sqrt{3}$	1	1	1.33	1.33	∞
System validation source									
Deviation of experimental dipole from numerical dipole	E.6.4	5.0	N	1	1	1	5.00	5.00	∞
Input power and SAR drift measurement	8,6.6.4	5.0	R	$\sqrt{3}$	1	1	2.89	2.89	∞
Other source contribution Uncertainty	8,E.6.6	2.0	R	$\sqrt{3}$	1	1	1.15	1.15	∞
Phantom and set-up									
Phantom uncertainty (shape and thickness uncertainty)	E.3.1	4.0	R	$\sqrt{3}$	1	1	2.31	2.31	∞
Uncertainty in SAR correction for deviations in permittivity and conductivity	E.3.2	1.9	N	1	1	0.84	1.90	1.60	∞
Liquid conductivity (temperature uncertainty)	E.3.3	2.5	R	$\sqrt{3}$	0.78	0.71	1.13	1.02	∞
Liquid conductivity (measured)	E.3.3	4	N	1	0.78	0.71	3.12	2.84	M
Liquid permittivity (temperature uncertainty)	E.3.4	2.5	R	$\sqrt{3}$	0.23	0.26	0.33	0.38	∞
Liquid permittivity (measured)	E.3.4	5	N	1	0.23	0.26	1.15	1.30	M
Combined Standard Uncertainty			RSS				9.738	9.538	
Expanded Uncertainty (95% Confidence interval)			K=2				19.477	19.076	



SATIMO Uncertainty- SN 45/15 EP281									
System Check uncertainty for DUT averaged over 1 gram / 10 gram.									
Uncertainty Component	Sec.	Tol (+-%)	Prob. Dist.	Div.	Ci (1g)	Ci (10g)	1g Ui (+-%)	10g Ui (+-%)	vi
Measurement System									
Probe calibration drift	E.2.1.3	0.5	N	1	1	1	0.50	0.50	∞
Axial Isotropy	E.2.2	0.685	R	$\sqrt{3}$	0	0	0.00	0.00	∞
Hemispherical Isotropy	E.2.2	0.915	R	$\sqrt{3}$	0	0	0.00	0.00	∞
Boundary effect	E.2.3	1	R	$\sqrt{3}$	0	0	0.00	0.00	∞
Linearity	E.2.4	1.3	R	$\sqrt{3}$	0	0	0.00	0.00	∞
System detection limits	E.2.4	1.0	R	$\sqrt{3}$	0	0	0.00	0.00	∞
Modulation response	E.2.5	3.0	R	$\sqrt{3}$	0	0	0.00	0.00	∞
Readout Electronics	E.2.6	0.021	N	1	0	0	0.00	0.00	∞
Response Time	E.2.7	0	R	$\sqrt{3}$	0	0	0.00	0.00	∞
Integration Time	E.2.8	1.4	R	$\sqrt{3}$	0	0	0.00	0.00	∞
RF ambient conditions-Noise	E.6.1	3.0	R	$\sqrt{3}$	0	0	0.00	0.00	∞
RF ambient conditions-reflections	E.6.1	3.0	R	$\sqrt{3}$	0	0	0.00	0.00	∞
Probe positioner mechanical tolerance	E.6.2	1.4	R	$\sqrt{3}$	1	1	0.81	0.81	∞
Probe positioning with respect to phantom shell	E.6.3	1.4	R	$\sqrt{3}$	1	1	0.81	0.81	∞
Post-processing	E.5	2.3	R	$\sqrt{3}$	0	0	0.00	0.00	∞
System check source									
Deviation between experimental dipoles	E.6.4	2.0	N	1	1	1	2.00	2.00	∞
Input power and SAR drift measurement	8,6.6.4	5.0	R	$\sqrt{3}$	1	1	2.89	2.89	∞
Other source contribution Uncertainty	8,E.6.6	2.0	R	$\sqrt{3}$	1	1	1.15	1.15	∞
Phantom and set-up									
Phantom uncertainty (shape and thickness uncertainty)	E.3.1	4	R	$\sqrt{3}$	1	1	2.31	2.31	∞
Uncertainty in SAR correction for deviations in permittivity and conductivity	E.3.2	1.9	N	1	1	0.84	1.90	1.60	∞
Liquid conductivity (temperature uncertainty)	E.3.3	2.5	R	$\sqrt{3}$	0.78	0.71	1.13	1.02	∞
Liquid conductivity (measured)	E.3.3	4	N	1	0.78	0.71	3.12	2.84	M
Liquid permittivity (temperature uncertainty)	E.3.4	2.5	R	$\sqrt{3}$	0.23	0.26	0.33	0.38	∞
Liquid permittivity (measured)	E.3.4	5	N	1	0.23	0.26	1.15	1.30	M
Combined Standard Uncertainty			RSS				5.562	5.203	



Attestation of Global Compliance(Shenzhen)Co.,Ltd.

Add: 2/F., Building 2, No.1-4, Chaxi Sanwei Technial Industrial Park, Gushu, Xixiang, Bao'an District, Shenzhen, Guangdong, China

Tel: +86-755 2523 4088

E-mail: agc@agc-cert.com

Service Hotline:400 089 2118

12. CONDUCTED POWER MEASUREMENT

GSM BAND

Mode	Frequency(MHz)	Avg. Burst Power(dBm)	Duty cycle Factor(dBm)	Frame Power(dBm)
Maximum Power <1>				
GSM 850	824.2	31.47	-9	22.47
	836.6	31.11	-9	22.11
	848.8	31.03	-9	22.03
GPRS 850 (1 Slot)	824.2	31.25	-9	22.25
	836.6	31.44	-9	22.44
	848.8	31.43	-9	22.43
GPRS 850 (2 Slot)	824.2	28.85	-6	22.85
	836.6	28.55	-6	22.55
	848.8	28.96	-6	22.96
GPRS 850 (3 Slot)	824.2	26.74	-4.26	22.48
	836.6	26.69	-4.26	22.43
	848.8	26.58	-4.26	22.32
GPRS 850 (4 Slot)	824.2	25.52	-3	22.52
	836.6	25.88	-3	22.88
	848.8	25.74	-3	22.74
EGPRS 850 (1 Slot)	824.2	27.51	-9	18.51
	836.6	27.01	-9	18.01
	848.8	27.77	-9	18.77
EGPRS 850 (2 Slot)	824.2	22.58	-6	16.58
	836.6	22.47	-6	16.47
	848.8	22.64	-6	16.64
EGPRS 850 (3 Slot)	824.2	21.55	-4.26	17.29
	836.6	21.48	-4.26	17.22
	848.8	21.46	-4.26	17.20
EGPRS 850 (4 Slot)	824.2	19.52	-3	16.52
	836.6	19.81	-3	16.81
	848.8	19.66	-3	16.66



Attestation of Global Compliance(Shenzhen)Co.,Ltd.

Add: 2/F., Building 2, No.1-4, Chaxi Sanwei Technial Industrial Park, Gushu,
Xixiang, Bao'an District, Shenzhen, Guangdong, China

Tel: +86-755 2523 4088

E-mail: agc@agc-cert.com

Service Hotline:400 089 2118

Mode	Frequency(MHz)	Avg. Burst Power(dBm)	Duty cycle Factor(dBm)	Frame Power(dBm)
Maximum Power <2>				
GSM 850	824.2	31.36	-9	22.36
	836.6	30.99	-9	21.99
	848.8	30.94	-9	21.94
GPRS 850 (1 Slot)	824.2	31.13	-9	22.13
	836.6	31.35	-9	22.35
	848.8	31.31	-9	22.31
GPRS 850 (2 Slot)	824.2	28.76	-6	22.76
	836.6	28.43	-6	22.43
	848.8	28.87	-6	22.87
GPRS 850 (3 Slot)	824.2	26.62	-4.26	22.36
	836.6	26.58	-4.26	22.32
	848.8	26.46	-4.26	22.20
GPRS 850 (4 Slot)	824.2	25.42	-3	22.42
	836.6	25.74	-3	22.74
	848.8	25.62	-3	22.62



Attestation of Global Compliance(Shenzhen)Co.,Ltd.

Add: 2/F., Building 2, No.1-4, Chaxi Sanwei Technial Industrial Park, Gushu,
Xixiang, Bao'an District, Shenzhen, Guangdong, China

Tel: +86-755 2523 4088

E-mail: agc@agc-cert.com

Service Hotline:400 089 2118

GSM BAND CONTINUE

Mode	Frequency(MHz)	Avg. Burst Power(dBm)	Duty cycle Factor(dBm)	Frame Power(dBm)
Maximum Power <1>				
PCS1900	1850.2	29.73	-9	20.73
	1880	29.48	-9	20.48
	1909.8	29.22	-9	20.22
GPRS1900 (1 Slot)	1850.2	28.80	-9	19.80
	1880	28.58	-9	19.58
	1909.8	28.25	-9	19.25
GPRS1900 (2 Slot)	1850.2	26.69	-6	20.69
	1880	26.48	-6	20.48
	1909.8	26.76	-6	20.76
GPRS1900 (3 Slot)	1850.2	25.35	-4.26	21.09
	1880	25.49	-4.26	21.23
	1909.8	25.47	-4.26	21.21
GPRS1900 (4 Slot)	1850.2	23.58	-3	20.58
	1880	23.79	-3	20.79
	1909.8	23.66	-3	20.66
EGPRS1900 (1 Slot)	1850.2	24.64	-9	15.64
	1880	24.62	-9	15.62
	1909.8	24.99	-9	15.99
EGPRS1900 (2 Slot)	1850.2	21.85	-6	15.85
	1880	21.49	-6	15.49
	1909.8	21.66	-6	15.66
EGPRS1900 (3 Slot)	1850.2	21.46	-4.26	17.20
	1880	21.51	-4.26	17.25
	1909.8	21.38	-4.26	17.12
EGPRS1900 (4 Slot)	1850.2	20.46	-3	17.46
	1880	20.69	-3	17.69
	1909.8	20.51	-3	17.51



Attestation of Global Compliance(Shenzhen)Co.,Ltd.

Add: 2/F., Building 2, No.1-4, Chaxi Sanwei Technial Industrial Park, Gushu,
Xixiang, Bao'an District, Shenzhen, Guangdong, China

Tel: +86-755 2523 4088

E-mail: agc@agc-cert.com

Service Hotline:400 089 2118

Mode	Frequency(MHz)	Avg. Burst Power(dBm)	Duty cycle Factor(dBm)	Frame Power(dBm)
Maximum Power <2>				
PCS1900	1850.2	29.61	-9	20.61
	1880	29.36	-9	20.36
	1909.8	29.13	-9	20.13
GPRS1900 (1 Slot)	1850.2	28.68	-9	19.68
	1880	28.45	-9	19.45
	1909.8	28.13	-9	19.13
GPRS1900 (2 Slot)	1850.2	26.57	-6	20.57
	1880	26.36	-6	20.36
	1909.8	26.64	-6	20.64
GPRS1900 (3 Slot)	1850.2	25.22	-4.26	20.96
	1880	25.39	-4.26	21.13
	1909.8	25.35	-4.26	21.09
GPRS1900 (4 Slot)	1850.2	23.43	-3	20.43
	1880	23.67	-3	20.67
	1909.8	23.54	-3	20.54

Note 1:

The Frame Power (Source-based time-averaged Power) is scaled the maximum burst average power based on time slots. The calculated methods are show as following:

Frame Power = Max burst power (1 Up Slot) – 9 dB

Frame Power = Max burst power (2 Up Slot) – 6 dB

Frame Power = Max burst power (3 Up Slot) – 4.26 dB

Frame Power = Max burst power (4 Up Slot) – 3 dB

Note 2:

SAR is not required for GPRS (1 Slot) Mode because its output power is less than of Voice Mode



Attestation of Global Compliance(Shenzhen)Co.,Ltd.

Add: 2/F., Building 2, No.1-4, Chaxi Sanwei Technial Industrial Park, Gushu,
Xixiang, Bao'an District, Shenzhen, Guangdong, China

Tel: +86-755 2523 4088

E-mail: agc@agc-cert.com

Service Hotline:400 089 2118

**UMTS BAND
HSDPA Setup Configuration:**

- The EUT was connected to Base Station Agilent E5515C referred to the Setup Configuration.
- The RF path losses were compensated into the measurements.
- A call was established between EUT and Based Station with following setting:
 - (1) Set Gain Factors(β_c and β_d) parameters set according to each
 - (2) Set RMC 12.2Kbps+HSDPA mode.
 - (3) Set Cell Power=-86dBm
 - (4) Set HS-DSCH Configuration Type to FRC (H-set 1, QPSK)
 - (5) Select HSDPA Uplink Parameters
 - (6) Set Delta ACK, Delta NACK and Delta CQI=8
 - (7) Set Ack - Nack Repetition Factor to 3
 - (8) Set CQI Feedback Cycle (k) to 4ms
 - (9) Set CQI Repetition Factor to 2
 - (10) Power Ctrl Mode=All Up bits
- The transmitted maximum output power was recorded.

Table C.10.2.4: β values for transmitter characteristics tests with HS-DPCCH

Sub-test	β_c (Note5)	β_d	β_d (SF)	β_c/β_d	β_{HS} (Note1, Note 2)	CM (dB) (Note 3)	MPR (dB) (Note 3)
1	2/15	15/15	64	2/15	4/15	0.0	0.0
2	12/15(Note 4)	15/15(Note 4)	64	12/15(Note 4)	24/15	1.0	0.0
3	15/15	8/15	64	15/8	30/15	1.5	0.5
4	15/15	4/15	64	15/4	30/15	1.5	0.5

Note 1: $\Delta ACK, \Delta NACK$ and $\Delta CQI = 30/15$ with $\beta_{hs} = 30/15 * \beta_c$.

Note 2: For the HS-DPCCH power mask requirement test in clause 5.2C, 5.7A, and the Error Vector Magnitude (EVM) with HS-DPCCH test in clause 5.13.1A, and HSDPA EVM with phase discontinuity in clause 5.13.1AA, ΔACK and $\Delta NACK = 30/15$ with $\beta_{hs} = 30/15 * \beta_c$, and $\Delta CQI = 24/15$ with $\beta_{hs} = 24/15 * \beta_c$.

Note 3: CM = 1 for $\beta_c/\beta_d = 12/15, hs/ c=24/15$. For all other combinations of DPDCH, DPCCH and HS-DPCCH the MPR is based on the relative CM difference. This is applicable for only UEs that support HSDPA in release 6 and later releases.

Note 4: For substest 2 the c/ d ratio of 12/15 for the TFC during the measurement period (TF1, TF0) is achieved by setting the signalled gain factors for the reference TFC (TF1, TF1) to $c = 11/15$ and $d = 15/15$.



HSUPA Setup Configuration:

- The EUT was connected to Base Station Agilent E5515C referred to the Setup Configuration.
- The RF path losses were compensated into the measurements.
- A call was established between EUT and Base Station with following setting * :
 - (1) Call Configs = 5.2B, 5.9B, 5.10B, and 5.13.2B with QPSK
 - (2) Set the Gain Factors (β_c and β_d) and parameters (AG Index) were set according to each specific sub-test in the following table, C11.1.3, quoted from the TS 34.121
 - (3) Set Cell Power = -86 dBm
 - (4) Set Channel Type = 12.2k + HSPA
 - (5) Set UE Target Power
 - (6) Power Ctrl Mode= Alternating bits
 - (7) Set and observe the E-TFCI
 - (8) Confirm that E-TFCI is equal to the target E-TFCI of 75 for sub-test 1, and other subtest's E-TFCI
- The transmitted maximum output power was recorded.

Table C.11.1.3: β values for transmitter characteristics tests with HS-DPCCH and E-DCH

Sub-test	β_c	β_d	β_d (SF)	β_c/β_d	β_{HS} (Note 1)	β_{ec}	β_{ed} (Note 4) (Note 5)	β_{ed} (SF)	β_{ed} (Codes)	CM (dB) (Note 2)	MPR (dB) (Note 2) (Note 6)	AG Index (Note 5)	E-TF CI
1	11/15 (Note 3)	15/15 (Note 3)	64	11/15 (Note 3)	22/15	209/225	1309/225	4	1	1.0	0.0	20	75
2	6/15	15/15	64	6/15	12/15	12/15	94/75	4	1	3.0	2.0	12	67
3	15/15	9/15	64	15/9	30/15	30/15	β_{ed1} : 47/15 β_{ed2} : 47/15	4 4	2	2.0	1.0	15	92
4	2/15	15/15	64	2/15	4/15	2/15	56/75	4	1	3.0	2.0	17	71
5	15/15	0	-	-	5/15	5/15	47/15	4	1	1.0	0.0	12	67

Note 1: For sub-test 1 to 4, ΔACK , $\Delta NACK$ and $\Delta CQI = 30/15$ with $\beta_{hs} = 30/15 * \beta_c$. For sub-test 5, ΔACK , $\Delta NACK$ and $\Delta CQI = 5/15$ with $\beta_{hs} = 5/15 * \beta_c$.

Note 2: CM = 1 for $\beta_c/\beta_d = 12/15$, $hs/c = 24/15$. For all other combinations of DPDCH, DPCCH, HS-DPCCH, E-DPDCH and E-DPCCH the MPR is based on the relative CM difference.

Note 3: For subtest 1 the c/d ratio of 11/15 for the TFC during the measurement period (TF1, TF0) is achieved by setting the signalled gain factors for the reference TFC (TF1, TF1) to $c = 10/15$ and $d = 15/15$.

Note 4: In case of testing by UE using E-DPDCH Physical Layer category 1, Sub-test 3 is omitted according to TS25.306 Table 5.1g.

Note 5: β_{ed} cannot be set directly; it is set by Absolute Grant Value.

Note 6: For subtests 2, 3 and 4, UE may perform E-DPDCH power scaling at max power which could results in slightly smaller MPR values.



UMTS BAND II

Mode	Frequency (MHz)	Avg. Burst Power (dBm)
WCDMA 1900 RMC	1852.4	22.05
	1880	22.11
	1907.6	22.55
WCDMA 1900 AMR	1852.4	22.23
	1880	22.41
	1907.6	22.10
HSDPA Subtest 1	1852.4	21.36
	1880	21.44
	1907.6	21.51
HSDPA Subtest 2	1852.4	20.50
	1880	20.57
	1907.6	20.68
HSDPA Subtest 3	1852.4	20.39
	1880	20.45
	1907.6	20.55
HSDPA Subtest 4	1852.4	20.39
	1880	20.40
	1907.6	20.47
HSUPA Subtest 1	1852.4	19.10
	1880	19.18
	1907.6	19.24
HSUPA Subtest 2	1852.4	19.22
	1880	19.32
	1907.6	19.43
HSUPA Subtest 3	1852.4	20.15
	1880	20.25
	1907.6	20.33
HSUPA Subtest 4	1852.4	18.82
	1880	18.87
	1907.6	18.97
HSUPA Subtest 5	1852.4	18.23
	1880	18.03
	1907.6	18.40



Attestation of Global Compliance(Shenzhen)Co.,Ltd.

Add: 2/F., Building 2, No.1-4, Chaxi Sanwei Technial Industrial Park, Gushu, Xixiang, Bao'an District, Shenzhen, Guangdong, China

Tel: +86-755 2523 4088

E-mail: agc@agc-cert.com

Service Hotline:400 089 2118

UMTS BAND V

Mode	Frequency (MHz)	Avg. Burst Power (dBm)
WCDMA 850 RMC	826.4	23.05
	836.6	23.06
	846.6	23.17
WCDMA 850 AMR	826.4	22.85
	836.6	22.57
	846.6	22.66
HSDPA Subtest 1	826.4	22.12
	836.6	22.19
	846.6	22.23
HSDPA Subtest 2	826.4	21.32
	836.6	21.30
	846.6	22.44
HSDPA Subtest 3	826.4	21.27
	836.6	21.23
	846.6	22.37
HSDPA Subtest 4	826.4	21.20
	836.6	21.29
	846.6	22.33
HSUPA Subtest 1	826.4	20.06
	836.6	20.06
	846.6	21.15
HSUPA Subtest 2	826.4	20.16
	836.6	20.14
	846.6	21.24
HSUPA Subtest 3	826.4	21.13
	836.6	21.08
	846.6	22.17
HSUPA Subtest 4	826.4	19.71
	836.6	19.66
	846.6	20.70
HSUPA Subtest 5	826.4	19.17
	836.6	19.09
	846.6	20.04



Attestation of Global Compliance(Shenzhen)Co.,Ltd.

Add: 2/F., Building 2, No.1-4, Chaxi Sanwei Technial Industrial Park, Gushu, Xixiang, Bao'an District, Shenzhen, Guangdong, China

Tel: +86-755 2523 4088

E-mail: agc@agc-cert.com

Service Hotline:400 089 2118

According to 3GPP 25.101 sub-clause 6.2.2 , the maximum output power is allowed to be reduced by following the table.

Table 6.1aA: UE maximum output power with HS-DPCCH and E-DCH

UE Transmit Channel Configuration	CM(db)	MPR(db)
For all combinations of ,DPDCH,DPCCH HS-DPDCH,E-DPDCH and E-DPCCH	$0 \leq CM \leq 3.5$	MAX(CM-1,0)

Note: CM=1 for $\beta_c/\beta_d=12/15$, $\beta_{hs}/\beta_c=24/15$. For all other combinations of DPDCH, DPCCH, HS-DPCCH, E-DPDCH and E-DPCCH the MPR is based on the relative CM difference.

The device supports MPR to solve linearity issues (ACLR or SEM) due to the higher peak-to average ratios (PAR) of the HSUPA signal. This prevents saturating the full range of the TX DAC inside of device and provides a reduced power output to the RF transceiver chip according to the Cubic Metric (a function of the combinations of DPDCH, DPCCH, HS-DPCCH, E-DPDCH and E-DPCCH).

When E-DPDCH channels are present the beta gains on those channels are reduced firsts to try to get the power under the allowed limit. If the beta gains are lowered as far as possible, then a hard limiting is applied at the maximum allowed level.

The SW currently recalculates the cubic metric every time the beta gains on the E-DPDCH are reduced. The cubic metric will likely get lower each time this is done .However, there is no reported reduction of maximum output power in the HSUPA mode since the device also provides a compensation for the power back-off by increasing the gain of TX_AGCC in the transceiver (PA) device.

The end effect is that the DUT output power is identical to the case where there is no MPR in the device.



LTE Band

Conducted Power of LTE Band 2(dBm)								
Bandwidth	Modulation	RB size	RB offset	Target MPR	Channel	Channel	Channel	
					18607	18900	19193	
1.4MHz	QPSK	1	0	0	23.06	22.93	22.10	
			2	0	23.21	22.66	22.22	
			5	0	23.11	22.55	22.09	
		3	0	0	22.97	22.49	22.96	
			1	0	22.96	22.50	22.80	
			2	0	22.84	22.50	22.75	
	6	0	1	22.10	21.75	21.05		
	16QAM	1	0	1	23.10	22.01	21.43	
			2	1	23.29	22.20	21.59	
			5	1	23.06	22.03	21.43	
		3	0	1	23.04	22.67	22.50	
			1	1	22.94	22.64	22.49	
			2	1	23.04	22.53	22.52	
		6	0	2	22.19	21.11	20.60	
		Bandwidth	Modulation	RB size	RB offset	Target MPR	Channel	Channel
						18615	18900	19185
3MHz	QPSK	1	0	0	22.63	22.60	21.82	
			8	0	22.72	22.66	21.71	
			14	0	22.67	22.66	21.67	
		8	0	1	21.74	21.67	21.70	
			4	1	21.75	21.68	21.68	
			8	1	21.76	21.67	21.70	
	15	0	1	21.72	21.65	20.54		
	16QAM	1	0	1	22.71	21.76	21.53	
			8	1	22.71	21.82	21.57	
			14	1	22.65	21.77	21.60	
		8	0	2	21.71	21.75	21.67	
			4	2	21.69	21.72	21.68	
			8	2	21.72	21.74	21.65	
		15	0	2	21.70	20.63	20.50	



Attestation of Global Compliance(Shenzhen)Co.,Ltd.

Add: 2/F., Building 2, No.1-4, Chaxi Sanwei Technial Industrial Park, Gushu, Xixiang, Bao'an District, Shenzhen, Guangdong, China

Tel: +86-755 2523 4088

E-mail: agc@agc-cert.com

Service Hotline:400 089 2118

Conducted Power of LTE Band 2(dBm)								
Bandwidth	Modulation	RB size	RB offset	Target MPR	Channel	Channel	Channel	
					18625	18900	19175	
5MHz	QPSK	1	0	0	22.55	22.43	21.74	
			12	0	22.68	22.62	21.79	
			24	0	22.53	22.53	21.61	
		12	0	1	21.64	21.55	21.67	
			6	1	21.63	21.53	21.69	
			13	1	21.61	21.54	21.52	
	25	1	21.64	21.54	20.52			
	16QAM	1	0	1	22.58	21.46	21.41	
			12	1	22.66	21.64	21.58	
			24	1	22.48	21.57	21.51	
		12	0	2	21.66	21.63	21.54	
			6	2	21.68	21.62	21.55	
			13	2	21.50	21.60	21.52	
		25	2	21.60	20.56	20.52		
		Bandwidth	Modulation	RB size	RB offset	Target MPR	Channel	Channel
						18650	18900	19150
10MHz	QPSK	1	0	0	22.54	22.24	21.81	
			25	0	22.80	22.65	21.83	
			49	0	22.60	22.50	21.54	
		25	0	1	21.75	21.55	21.83	
			12	1	21.80	21.57	21.86	
			25	1	21.80	21.58	21.58	
	50	1	21.75	21.51	20.61			
	16QAM	1	0	1	22.68	21.69	21.24	
			25	1	22.75	21.96	21.53	
			49	1	22.43	21.84	21.45	
		25	0	2	21.82	21.76	21.53	
			12	2	21.81	21.80	21.56	
			25	2	21.61	21.81	21.54	
		50	2	21.66	20.69	20.46		



Attestation of Global Compliance(Shenzhen)Co.,Ltd.

Add: 2/F., Building 2, No.1-4, Chaxi Sanwei Technial Industrial Park, Gushu, Xixiang, Bao'an District, Shenzhen, Guangdong, China

Tel: +86-755 2523 4088

E-mail: agc@agc-cert.com

Service Hotline:400 089 2118

Conducted Power of LTE Band 2(dBm)								
Bandwidth	Modulation	RB size	RB offset	Target MPR	Channel	Channel	Channel	
					18675	18900	19125	
15MHz	QPSK	1	0	0	22.45	22.13	21.96	
			38	0	22.63	22.41	21.85	
			74	0	22.57	22.44	21.49	
		36	0	1	21.84	21.49	21.79	
			18	1	21.84	21.48	21.84	
			39	1	21.83	21.49	21.81	
		75	0	1	21.85	21.49	20.64	
		16QAM	1	0	1	22.70	21.58	21.14
				38	1	22.70	21.85	21.34
	74			1	22.28	21.81	21.35	
	36		0	2	21.81	21.83	21.48	
			18	2	21.82	21.82	21.50	
			39	2	21.81	21.82	21.47	
	75	0	2	21.82	20.72	20.40		
	Bandwidth	Modulation	RB size	RB offset	Target MPR	Channel	Channel	Channel
					18700	18900	19100	
20MHz	QPSK	1	0	0	22.48	21.95	21.86	
			49	0	22.87	22.30	21.84	
			99	0	22.69	22.25	21.30	
		50	0	1	21.68	21.27	21.87	
			25	1	21.63	21.28	21.90	
			49	1	21.89	21.28	21.39	
		100	0	1	21.76	21.23	20.57	
		16QAM	1	0	1	22.74	21.44	21.15
				49	1	22.93	21.92	21.46
	99			1	22.18	21.74	21.34	
	50		0	2	21.91	21.65	21.27	
			25	2	21.90	21.65	21.29	
			49	2	21.39	21.87	21.28	
	100		0	2	21.66	20.74	20.24	



Attestation of Global Compliance(Shenzhen)Co.,Ltd.

Add: 2/F., Building 2, No.1-4, Chaxi Sanwei Technial Industrial Park, Gushu, Xixiang, Bao'an District, Shenzhen, Guangdong, China

Tel: +86-755 2523 4088

E-mail: agc@agc-cert.com

Service Hotline:400 089 2118

Conducted Power of LTE Band 4(dBm)								
Bandwidth	Modulation	RB size	RB offset	Target MPR	Channel	Channel	Channel	
					19957	20175	20393	
1.4MHz	QPSK	1	0	0	23.50	23.51	22.36	
			2	0	23.60	23.72	22.54	
			5	0	23.53	23.54	22.37	
		3	0	0	23.68	23.63	23.51	
			1	0	23.70	23.64	23.47	
			2	0	23.75	23.66	23.53	
		6	0	1	22.70	22.70	21.49	
		16QAM	1	0	1	23.40	22.86	22.72
				2	1	23.55	23.02	22.98
	5			1	23.42	22.79	22.72	
	3		0	1	23.47	23.68	23.63	
			1	1	23.45	23.68	23.63	
			2	1	23.52	23.75	23.66	
	6	0	2	22.47	21.62	21.70		
	Bandwidth	Modulation	RB size	RB offset	Target MPR	Channel	Channel	Channel
					19965	20175	20385	
3MHz	QPSK	1	0	0	23.67	23.73	22.76	
			7	0	23.74	23.71	22.72	
			14	0	23.70	23.76	22.70	
		8	0	1	22.78	22.73	22.55	
			4	1	22.80	22.73	22.55	
			7	1	22.78	22.71	22.56	
		15	0	1	22.83	22.72	21.51	
		16QAM	1	0	1	23.47	23.00	22.62
				7	1	23.47	23.03	22.68
	14			1	23.47	23.02	22.73	
	8		0	2	22.54	22.82	22.72	
			4	2	22.57	22.79	22.71	
			7	2	22.54	22.77	22.73	
	15		0	2	22.54	21.85	21.63	



Attestation of Global Compliance(Shenzhen)Co.,Ltd.

Add: 2/F., Building 2, No.1-4, Chaxi Sanwei Technial Industrial Park, Gushu, Xixiang, Bao'an District, Shenzhen, Guangdong, China

Tel: +86-755 2523 4088

E-mail: agc@agc-cert.com

Service Hotline:400 089 2118

Conducted Power of LTE Band 4(dBm)								
Bandwidth	Modulation	RB size	RB offset	Target MPR	Channel	Channel	Channel	
					19975	20175	20375	
5MHz	QPSK	1	0	0	23.57	23.51	22.66	
			12	0	23.66	23.68	22.81	
			24	0	23.55	23.59	22.70	
		12	0	1	22.74	22.67	22.45	
			6	1	22.64	22.61	22.43	
			11	1	22.65	22.59	22.47	
	25	0	1	22.75	22.64	21.49		
	16QAM	1	0	1	23.30	22.68	22.60	
			12	1	23.48	22.81	22.77	
			24	1	23.40	22.71	22.69	
		12	0	2	22.44	22.71	22.62	
			6	2	22.45	22.68	22.65	
			11	2	22.47	22.69	22.64	
		25	0	2	22.49	21.79	21.65	
		Bandwidth	Modulation	RB size	RB offset	Target MPR	Channel	Channel
						20000	20175	20350
10MHz	QPSK	1	0	0	23.51	23.33	22.53	
			24	0	23.86	23.70	22.85	
			49	0	23.42	23.60	22.62	
		25	0	1	22.80	22.60	22.56	
			12	1	22.83	22.60	22.52	
			25	1	22.72	22.66	22.59	
	50	0	1	22.80	22.66	21.58		
	16QAM	1	0	1	23.27	22.89	22.27	
			24	1	23.57	23.04	22.61	
			49	1	23.36	22.75	22.57	
		25	0	2	22.54	22.85	22.56	
			12	2	22.54	22.84	22.58	
			25	2	22.60	22.69	22.68	
		50	0	2	22.59	21.80	21.61	



Attestation of Global Compliance(Shenzhen)Co.,Ltd.

Add: 2/F., Building 2, No.1-4, Chaxi Sanwei Technial Industrial Park, Gushu, Xixiang, Bao'an District, Shenzhen, Guangdong, China

Tel: +86-755 2523 4088

E-mail: agc@agc-cert.com

Service Hotline:400 089 2118

Conducted Power of LTE Band 4(dBm)								
Bandwidth	Modulation	RB size	RB offset	Target MPR	Channel	Channel	Channel	
					20025	20175	20325	
15MHz	QPSK	1	0	0	23.45	23.24	22.51	
			37	0	23.54	23.48	22.81	
			74	0	23.16	23.49	22.58	
		36	0	1	22.58	22.51	22.44	
			16	1	22.59	22.49	22.41	
			35	1	22.60	22.48	22.41	
		75	0	1	22.61	22.47	21.45	
		16QAM	1	0	1	23.07	22.80	22.21
				37	1	23.35	22.90	22.45
	74			1	23.16	22.52	22.45	
	36		0	2	22.44	22.61	22.52	
			16	2	22.42	22.62	22.49	
			35	2	22.44	22.61	22.47	
	75	0	2	22.44	21.55	21.43		
	Bandwidth	Modulation	RB size	RB offset	Target MPR	Channel	Channel	Channel
					20050	20175	20300	
20MHz	QPSK	1	0	0	23.39	23.10	22.44	
			49	0	23.60	23.40	22.86	
			99	0	23.17	23.31	22.42	
		50	0	1	22.73	22.43	22.45	
			25	1	22.75	22.42	22.43	
			49	1	22.44	22.51	22.48	
		100	0	1	22.54	22.47	21.46	
		16QAM	1	0	1	23.11	22.56	22.28
				49	1	23.53	22.72	22.62
	99			1	23.16	22.29	22.49	
	50		0	2	22.44	22.72	22.44	
			25	2	22.44	22.71	22.43	
			49	2	22.49	22.43	22.52	
	100		0	2	22.48	21.55	21.39	



Attestation of Global Compliance(Shenzhen)Co.,Ltd.

Add: 2/F., Building 2, No.1-4, Chaxi Sanwei Technial Industrial Park, Gushu, Xixiang, Bao'an District, Shenzhen, Guangdong, China

Tel: +86-755 2523 4088

E-mail: agc@agc-cert.com

Service Hotline:400 089 2118

Conducted Power of LTE Band 5(dBm)							
Bandwidth	Modulation	RB size	RB offset	Target MPR	Channel	Channel	Channel
					20407	20525	20643
1.4MHz	QPSK	1	0	0	23.95	24.20	22.38
			2	0	24.02	24.31	22.62
			5	0	23.85	24.17	22.53
		3	0	0	24.03	24.34	23.39
			1	0	24.02	24.35	23.39
			2	0	23.97	24.30	23.50
	6	0	1	22.93	23.24	21.22	
	16QAM	1	0	1	23.26	23.09	23.37
			2	1	23.41	23.18	23.41
			5	1	23.39	22.98	23.38
		3	0	1	23.37	24.04	24.32
			1	1	23.38	24.06	24.35
			2	1	23.52	23.96	24.32
	6	0	2	22.36	21.97	22.28	
	Bandwidth	Modulation	RB size	RB offset	Target MPR	Channel	Channel
					20415	20525	20635
3MHz	QPSK	1	0	0	24.14	24.89	22.49
			7	0	23.83	24.41	22.60
			14	0	23.67	24.29	22.72
		8	0	1	22.85	23.38	22.43
			4	1	22.85	23.39	22.43
			7	1	22.84	23.37	22.47
	15	0	1	22.81	23.44	21.32	
	16QAM	1	0	1	23.29	23.25	23.59
			7	1	23.47	22.99	23.46
			14	1	23.60	22.81	23.44
		8	0	2	22.44	22.83	23.40
			4	2	22.45	22.85	23.34
			7	2	22.45	22.83	23.34
	15	0	2	22.42	21.85	22.46	



Attestation of Global Compliance(Shenzhen)Co.,Ltd.

Add: 2/F., Building 2, No.1-4, Chaxi Sanwei Technial Industrial Park, Gushu, Xixiang, Bao'an District, Shenzhen, Guangdong, China

Tel: +86-755 2523 4088

E-mail: agc@agc-cert.com

Service Hotline:400 089 2118

Conducted Power of LTE Band 5(dBm)								
Bandwidth	Modulation	RB size	RB offset	Target MPR	Channel	Channel	Channel	
					20425	20525	20625	
5MHz	QPSK	1	0	0	24.38	24.91	22.20	
			12	0	23.69	24.81	22.68	
			24	0	23.23	24.30	22.78	
		12	0	1	22.75	23.45	22.15	
			6	1	22.72	23.42	22.14	
			11	1	22.41	23.30	22.49	
	25	1	22.70	23.41	21.43			
	16QAM	1	0	1	23.25	22.92	23.46	
			12	1	23.43	22.67	23.39	
			24	1	23.60	22.22	23.29	
		12	0	2	22.12	22.80	23.40	
			6	2	22.19	22.73	23.33	
			11	2	22.47	22.39	23.28	
		25	2	22.38	21.98	22.41		
		Bandwidth	Modulation	RB size	RB offset	Target MPR	Channel	Channel
						20450	20525	20600
10MHz	QPSK	1	0	0	24.37	24.79	22.00	
			24	0	23.56	25.06	22.76	
			49	0	22.90	24.26	22.91	
		25	0	1	22.66	23.64	22.16	
			12	1	22.74	23.71	22.15	
			25	1	22.05	23.62	22.70	
	50	1	22.43	23.47	21.55			
	16QAM	1	0	1	23.09	23.08	23.58	
			24	1	23.50	22.63	23.95	
			49	1	23.78	22.04	23.45	
		25	0	2	22.15	22.69	23.64	
			12	2	22.16	22.66	23.55	
			25	2	22.67	22.02	23.39	
		50	2	22.42	21.61	22.85		



Attestation of Global Compliance(Shenzhen)Co.,Ltd.

Add: 2/F., Building 2, No.1-4, Chaxi Sanwei Technial Industrial Park, Gushu, Xixiang, Bao'an District, Shenzhen, Guangdong, China

Tel: +86-755 2523 4088

E-mail: agc@agc-cert.com

Service Hotline:400 089 2118

Conducted Power of LTE Band 7 (dBm)									
Bandwidth	Modulation	RB size	RB offset	Target MPR	Channel	Channel	Channel		
					20775	21100	21425		
5MHz	QPSK	1	0	0	25.07	25.17	22.57		
			12	0	25.19	25.43	22.56		
			24	0	25.02	25.34	22.46		
		12	0	1	24.12	24.36	22.32		
			6	1	24.15	24.39	22.34		
			13	1	24.12	24.38	22.31		
		25	0	1	24.15	24.43	21.31		
		16QAM	1	0	1	23.25	24.18	24.27	
				12	1	23.32	24.23	24.49	
	24			1	23.23	24.11	24.42		
	12		0	2	22.32	24.16	24.38		
			6	2	22.31	24.12	24.36		
			13	2	22.30	24.15	24.39		
	25		0	2	22.37	23.22	23.47		
	Bandwidth		Modulation	RB size	RB offset	Target MPR	Channel	Channel	Channel
							20800	21100	21400
	10MHz	QPSK	1	0	0	25.07	24.53	22.60	
				24	0	25.15	25.37	22.72	
49				0	24.71	25.38	22.43		
25			0	1	24.17	24.04	22.48		
			12	1	24.22	24.02	22.48		
			25	1	24.06	24.44	22.44		
50			0	1	24.15	24.24	21.47		
16QAM			1	0	1	23.33	24.38	23.50	
				24	1	23.39	24.49	24.31	
		49		1	23.22	24.00	24.34		
		25	0	2	22.46	24.19	24.06		
			12	2	22.46	24.22	24.07		
			25	2	22.43	24.07	24.45		
		50	0	2	22.46	23.17	23.14		



Attestation of Global Compliance(Shenzhen)Co.,Ltd.

Add: 2/F., Building 2, No.1-4, Chaxi Sanwei Technial Industrial Park, Gushu, Xixiang, Bao'an District, Shenzhen, Guangdong, China

Tel: +86-755 2523 4088

E-mail: agc@agc-cert.com

Service Hotline:400 089 2118

Conducted Power of LTE Band 7 (dBm)

Bandwidth	Modulation	RB size	RB offset	Target MPR	Channel	Channel	Channel
					20825	21100	21375
15MHz	QPSK	1	0	0	24.96	23.79	22.60
			37	0	24.90	24.91	22.62
			74	0	24.17	25.27	22.43
		37	0	1	23.85	23.87	22.37
			16	1	23.85	23.81	22.37
			35	1	23.85	23.82	22.37
	75	0	1	23.87	23.80	21.37	
	16QAM	1	0	1	23.22	24.24	22.76
			37	1	23.24	24.19	23.87
			74	1	23.06	23.47	24.22
		37	0	2	22.39	23.87	23.80
			16	2	22.35	23.87	23.81
			35	2	22.35	23.87	23.81
	75	0	2	22.36	22.84	22.80	
Bandwidth	Modulation	RB size	RB offset	Target MPR	Channel	Channel	Channel
					20850	21100	21350
20MHz	QPSK	1	0	0	24.93	23.29	22.60
			49	0	24.87	24.46	22.75
			99	0	23.80	25.08	22.38
		50	0	1	24.01	23.12	22.47
			25	1	23.98	23.10	22.50
			49	1	23.34	23.98	22.31
	100	0	1	23.69	23.56	21.36	
	16QAM	1	0	1	23.33	24.06	22.49
			49	1	23.43	23.99	23.66
			99	1	23.12	22.91	24.27
		50	0	2	22.45	24.00	23.12
			25	2	22.48	23.96	23.12
			49	2	22.30	23.33	23.99
	100	0	2	22.38	22.64	22.51	



Attestation of Global Compliance(Shenzhen)Co.,Ltd.

Add: 2/F., Building 2, No.1-4, Chaxi Sanwei Technial Industrial Park, Gushu, Xixiang, Bao'an District, Shenzhen, Guangdong, China

Tel: +86-755 2523 4088

E-mail: agc@agc-cert.com

Service Hotline:400 089 2118

Conducted Power of LTE Band 12(dBm)								
Bandwidth	Modulation	RB size	RB offset	Target MPR	Channel	Channel	Channel	
					23017	23095	23173	
1.4MHz	QPSK	1	0	0	24.68	24.36	24.07	
			2	0	24.68	24.54	24.20	
			5	0	24.66	24.40	24.06	
		3	0	0	24.76	24.48	25.00	
			1	0	24.80	24.42	24.97	
			2	0	24.79	24.32	25.03	
	6	0	1	23.71	23.30	22.94		
	16QAM	1	0	1	24.91	23.78	23.29	
			2	1	25.04	23.96	23.43	
			5	1	24.94	23.83	23.26	
		3	0	1	24.97	24.80	24.08	
			1	1	24.99	24.75	23.97	
			2	1	25.01	24.83	24.06	
		6	0	2	23.97	22.82	22.50	
		Bandwidth	Modulation	RB size	RB offset	Target MPR	Channel	Channel
						23025	23095	23165
3MHz	QPSK	1	0	0	24.75	24.68	24.22	
			7	0	24.87	24.56	24.17	
			14	0	24.90	24.54	24.12	
		8	0	1	23.83	23.54	24.07	
			4	1	23.85	23.55	24.06	
			7	1	23.85	23.54	24.08	
	15	0	1	23.85	23.54	23.09		
	16QAM	1	0	1	25.01	24.02	23.53	
			7	1	25.03	24.00	23.44	
			14	1	25.03	24.05	23.44	
		8	0	2	24.07	23.84	23.53	
			4	2	24.07	23.84	23.55	
			7	2	24.06	23.87	23.55	
		15	0	2	24.07	22.91	22.49	



Attestation of Global Compliance(Shenzhen)Co.,Ltd.

Add: 2/F., Building 2, No.1-4, Chaxi Sanwei Technial Industrial Park, Gushu, Xixiang, Bao'an District, Shenzhen, Guangdong, China

Tel: +86-755 2523 4088

E-mail: agc@agc-cert.com

Service Hotline:400 089 2118

Conducted Power of LTE Band 12(dBm)								
Bandwidth	Modulation	RB size	RB offset	Target MPR	Channel	Channel	Channel	
					23035	23095	23155	
5MHz	QPSK	1	0	0	24.75	24.69	24.14	
			12	0	24.92	24.63	24.23	
			24	0	24.87	24.41	24.05	
		12	0	1	23.78	23.72	23.95	
			6	1	23.76	23.68	23.95	
			13	1	23.70	23.36	24.02	
	25	0	1	23.78	23.58	23.06		
	16QAM	1	0	1	24.92	23.70	23.66	
			12	1	25.04	23.89	23.57	
			24	1	24.89	23.82	23.40	
		12	0	2	23.95	23.75	23.68	
			6	2	23.99	23.79	23.69	
			13	2	24.02	23.70	23.34	
		25	0	2	24.09	22.85	22.64	
		Bandwidth	Modulation	RB size	RB offset	Target MPR	Channel	Channel
						23060	23095	23130
10MHz	QPSK	1	0	0	24.65	24.95	23.95	
			24	0	25.04	24.82	24.24	
			49	0	24.96	24.41	23.78	
		25	0	1	24.10	23.77	24.04	
			12	1	24.07	23.79	24.04	
			25	1	24.04	23.46	24.13	
	50	0	1	24.03	23.62	23.17		
	16QAM	1	0	1	24.79	23.86	23.83	
			24	1	25.09	24.16	23.72	
			49	1	24.62	24.08	23.32	
		25	0	2	24.02	24.09	23.77	
			12	2	24.04	24.06	23.76	
			25	2	24.09	24.07	23.37	
		50	0	2	24.03	23.08	22.66	



Attestation of Global Compliance(Shenzhen)Co.,Ltd.

Add: 2/F., Building 2, No.1-4, Chaxi Sanwei Technial Industrial Park, Gushu, Xixiang, Bao'an District, Shenzhen, Guangdong, China

Tel: +86-755 2523 4088

E-mail: agc@agc-cert.com

Service Hotline:400 089 2118

Conducted Power of LTE Band 17(dBm)							
Bandwidth	Modulation	RB size	RB offset	Target MPR	Channel	Channel	Channel
					23755	23790	23825
5MHz	QPSK	1	0	0	24.85	24.22	23.59
			13	0	24.87	24.14	23.60
			24	0	24.39	23.94	23.33
		12	0	1	23.39	23.21	23.21
			6	1	23.38	23.23	23.22
			13	1	23.51	22.89	23.18
	25	0	1	23.48	23.11	22.28	
	16QAM	1	0	1	24.39	23.35	23.19
			13	1	24.42	23.55	23.09
			24	1	24.16	23.39	22.92
		12	0	2	23.23	23.41	23.27
			6	2	23.22	23.37	23.23
			13	2	23.16	23.50	22.85
	25	0	2	23.23	22.55	22.16	
Bandwidth	Modulation	RB size	RB offset	Target MPR	Channel	Channel	Channel
					23780	23790	23800
10MHz	QPSK	1	0	0	24.46	24.49	23.52
			25	0	24.56	24.42	23.68
			49	0	23.99	23.93	23.10
		25	0	1	23.44	23.25	23.36
			13	1	23.46	23.26	23.34
			25	1	23.28	22.96	23.08
	50	0	1	23.34	23.13	22.26	
	16QAM	1	0	1	24.37	23.53	23.34
			25	1	24.49	23.67	23.38
			49	1	23.96	23.14	22.83
		25	0	2	23.32	23.44	23.25
			13	2	23.35	23.48	23.25
			25	2	23.10	23.26	22.97
	50	0	2	23.19	22.39	22.15	



Attestation of Global Compliance(Shenzhen)Co.,Ltd.

Add: 2/F., Building 2, No.1-4, Chaxi Sanwei Technial Industrial Park, Gushu, Xixiang, Bao'an District, Shenzhen, Guangdong, China

Tel: +86-755 2523 4088

E-mail: agc@agc-cert.com

Service Hotline:400 089 2118

The following tests were conducted according to the test requirements outlined in section 6.2 of the 3GPP TS36.101 specification.

UE Power Class: 3 (23 +/- 2dBm). The allowed Maximum Power Reduction (MPR) for the maximum output power due to higher order modulation and transmit bandwidth configuration (resource blocks) is specified in Table 6.2.3.3-1 of the 3GPP TS36.101.

Table 6.2.3.3-1 Maximum Power Reduction (MPR) for Power class3

Modulation	Maximum Power Reduction (MPR) for Power[RB]						MPR(dB)
	1.4MHz	3MHz	5MHz	10MHz	15MHz	20MHz	
QPSK	>5	>4	>8	>12	>16	>18	≤1
16QAM	≤5	≤4	≤8	≤12	≤16	≤18	≤1
16QAM	>5	>4	>8	>12	>16	>18	≤2

The allowed A-MPR values specified below in Table 6.2.4.3-1 of 3GPP TS36.101 are in addition to the allowed MPR requirements. All the measurements below were performed with A-MPR disabled, by using Network Signaling Value of "NS_01".3



Table 6.2.4.3-1: Additional Maximum Power Reduction (A-MPR) / Spectrum Emission requirements

Network Signaling value	Requirements (sub-clause)	E-UTRA Band	Channel bandwidth (MHz)	Resources Blocks (N_{RB})	A-MPR (dB)
NS_01	6.6.2.1.1	Table 5.2-1	1.4,3,5,10,15,20	Table 5.4.2-1	N/A
NS_03	6.6.2.2.3.1	2,4,10, 23, 25,35,36	3	>5	≤ 1
			5	>6	≤ 1
			10	>6	≤ 1
			15	>8	≤ 1
			20	>10	≤ 1
NS_04	6.6.2.2.3.2	41	5	>6	≤ 1
			10, 15, 20	Table 6.2.4.3-4	
NS_05	6.6.3.3.3.1	1	10,15,20	≥ 50	≤ 1
NS_06	6.6.2.2.3.3	12, 13, 14, 17	1.4, 3, 5, 10	Table 5.4.2-1	N/A
NS_07	6.6.2.2.3.3 6.6.3.3.3.2	13	10	Table 6.2.4.3-2	Table 6.2.4.3-2
NS_08	6.6.3.3.3.3	19	10, 15	> 44	≤ 3
NS_09	6.6.3.3.3.4	21	10, 15	> 40	≤ 1
				> 55	≤ 2
				Table 6.2.4.3-3	
NS_10		20	15, 20	Table 6.2.4.3-3	Table 6.2.4.3-3
NS_11	6.6.2.2.1 6.6.3.3.13	231	1.4, 3, 5, 10,15,20	Table 6.2.4.3-5	Table 6.2.4.3-5
NS_12	6.6.3.3.5	26	1.4, 3, 5	Table 6.2.4.3-6	Table 6.2.4.3-6
NS_13	6.6.3.3.6	26	5	Table 6.2.4.3-7	Table 6.2.4.3-7
NS_14	6.6.3.3.7	26	10, 15	Table 6.2.4.3-8	Table 6.2.4.3-8
NS_15	6.6.3.3.8	26	1.4, 3, 5, 10, 15	Table 6.2.4.3-9 Table 6.2.4.3-10	Table 6.2.4.3-9, Table 6.2.4.3-10
NS_16	6.6.3.3.9	27	3, 5, 10	Table 6.2.4.3-11, Table 6.2.4.3-12, Table 6.2.4.3-13	
NS_17	6.6.3.3.10	28	5, 10	Table 5.4.2-1	N/A
	6.6.3.3.11	28	5	≥ 2	≤ 1
NS_18			10, 15, 20	≥ 1	≤ 4
NS_19			10, 15, 20	Table 6.2.4.3-15	Table 6.2.4.3-15
NS_20			5, 10, 15, 20	Table 6.2.4.3-14	Table 6.2.4.3-14
...					
NS_20	-	-	-	-	-



WIFI

Mode	Data Rate (Mbps)	Channel	Frequency(MHz)	Avg. Burst Power(dBm)
802.11b	1	01	2412	14.18
		06	2437	11.49
		11	2462	12.63
802.11g	6	01	2412	9.34
		06	2437	9.77
		11	2462	10.53
802.11n(20)	6.5	01	2412	9.39
		06	2437	10.11
		11	2462	10.07

5G WIFI

Mode	channel	Frequency	Power(dBm)							
			Data Rate(bps)							
			6M	9M	12M	18M	24M	36M	48M	54M
802.11a	36	5180	12.38	12.25	12.13	12.04	11.88	11.81	11.74	11.65
	40	5200	12.35	12.23	12.10	11.99	11.86	11.77	11.69	11.62
	44	5220	12.23	12.11	11.98	11.87	11.74	11.65	11.57	11.48
	48	5240	12.16	12.06	11.91	11.83	11.65	11.58	11.56	11.41
			MCS0	MCS1	MCS2	MCS3	MCS4	MCS5	MCS6	MCS7
802.11n (20)	36	5180	10.95	10.83	10.74	10.59	10.46	10.37	10.29	10.25
	40	5200	10.08	9.96	9.81	9.72	9.58	9.55	9.42	9.34
	44	5220	10.01	9.89	9.76	9.65	9.52	9.43	9.35	9.26
	48	5240	9.92	9.83	9.69	9.56	9.45	9.34	9.26	9.17



Attestation of Global Compliance(Shenzhen)Co.,Ltd.

Add: 2/F., Building 2, No.1-4, Chaxi Sanwei Technial Industrial Park, Gushu, Xixiang, Bao'an District, Shenzhen, Guangdong, China

Tel: +86-755 2523 4088

E-mail: agc@agc-cert.com

Service Hotline:400 089 2118

Bluetooth_V3.0

Modulation	Channel	Frequency(MHz)	Peak Power (dBm)
GFSK	0	2402	3.285
	39	2441	-0.161
	78	2480	1.611
π /4-DQPSK	0	2402	2.388
	39	2441	-0.857
	78	2480	0.890
8-DPSK	0	2402	2.439
	39	2441	-0.769
	78	2480	0.988

Bluetooth_V4.0

Modulation	Channel	Frequency(MHz)	Peak Power (dBm)
GFSK	0	2402	3.236
	19	2440	-0.314
	39	2480	1.589



Attestation of Global Compliance(Shenzhen)Co.,Ltd.

Add: 2/F., Building 2, No.1-4, Chaxi Sanwei Technial Industrial Park, Gushu,
Xixiang, Bao'an District, Shenzhen, Guangdong, China

Tel: +86-755 2523 4088

E-mail: agc@agc-cert.com

Service Hotline:400 089 2118