



FCC TEST REPORT

**Test report
On Behalf of
PEAG, LLC dba JLab Audio
For
TRUE WIRELESS SPORT EARBUDS
Model No.: EPIC AIR ELITE

FCC ID: 2AHYVEPICELITEL**

Prepared for : PEAG,LLC dba JLab Audio
2281 Las Palmas Dr, Suite 101, Carlsbad, CA 92011, USA

Prepared By : Shenzhen HUAKE Testing Technology Co., Ltd.
1F, B2 Building, Junfeng Zhongcheng Zhizao Innovation Park, Fuhai Street,
Bao'an District, Shenzhen City, China

Date of Test: Jul. 25, 2018 ~ Aug. 08, 2018
Date of Report: Aug. 10, 2018
Report Number: HUAKE180803692E



TEST RESULT CERTIFICATION

Applicant's name : PEAG, LLC dba JLab Audio
 Address : 2281 Las Palmas Dr, Suite 101, Carlsbad, CA 92011, USA
Manufacturer's Name : Cosonic Intelligent Technologies Co.,Ltd.
 Address : 5th Floor, 1st Building, No.6, South Industry Road, Songshan Lake
 Address : National High-tech Industrial Development Zone, Dongguan City,
 Guangdong, China 523808

Product description

Trade Mark: JLAB
 Product Name : TRUE WIRELESS SPORT EARBUDS
 Model and/or type reference .. : EPIC AIR ELITE

Standards : FCC Rules and Regulations Part 15 Subpart C Section 15.247
 ANSI C63.10: 2013

This publication may be reproduced in whole or in part for non-commercial purposes as long as the Shenzhen HUAKE Testing Technology Co., Ltd. is acknowledged as copyright owner and source of the material. Shenzhen HUAKE Testing Technology Co., Ltd. takes no responsibility for and will not assume liability for damages resulting from the reader's interpretation of the reproduced material due to its placement and context.

Date of Test :
 Date (s) of performance of tests : Jul. 25, 2018 ~ Aug. 08, 2018
 Date of Issue : Aug. 10, 2018
 Test Result : **Pass**

Testing Engineer : Gary Qian
 (Gary Qian)

Technical Manager : Eden Hu
 (Eden Hu)

Authorized Signatory : Jason Zhou
 (Jason Zhou)



Table of Contents	Page
1 . TEST SUMMARY	5
2 . GENERAL INFORMATION	6
2.1 . GENERAL DESCRIPTION OF EUT	6
2.2 . CARRIER FREQUENCY OF CHANNELS	7
2.3 . OPERATION OF EUT DURING TESTING	7
2.4 . DESCRIPTION OF TEST SETUP	8
2.5. EQUIPMENT USED IN EUT SYSTEM	8
2.6. MEASUREMENT INSTRUMENTS LIST	9
3. PEAK OUTPUT POWER	10
3.1. MEASUREMENT PROCEDURE	10
3.2. TEST SET-UP (BLOCK DIAGRAM OF CONFIGURATION)	10
3.3. LIMITS AND MEASUREMENT RESULT	11
4. BANDWIDTH	17
4.1. MEASUREMENT PROCEDURE	17
4.2. TEST SET-UP (BLOCK DIAGRAM OF CONFIGURATION)	17
4.3. LIMITS AND MEASUREMENT RESULTS	17
5. CONDUCTED SPURIOUS EMISSION	24
5.1. MEASUREMENT PROCEDURE	24
5.2. TEST SET-UP (BLOCK DIAGRAM OF CONFIGURATION)	24
5.3. LIMITS AND MEASUREMENT RESULT	24
6. RADIATED EMISSION	28
6.1. TEST LIMIT	28
6.2. MEASUREMENT PROCEDURE	28
6.3. TEST SETUP	30
6.4. TEST RESULT	32
7. BAND EDGE EMISSION	45
7.1. MEASUREMENT PROCEDURE	45
7.2. TEST SET-UP	45
7.3. TEST RESULT	46
8. NUMBER OF HOPPING FREQUENCY	50
8.1. MEASUREMENT PROCEDURE	50
8.2. TEST SETUP (BLOCK DIAGRAM OF CONFIGURATION)	50
8.3. LIMITS AND MEASUREMENT RESULT	50
9. TIME OF OCCUPANCY (DWELL TIME)	52



Table of Contents	Page
9.1. MEASUREMENT PROCEDURE	52
9.2. TEST SETUP (BLOCK DIAGRAM OF CONFIGURATION)	52
9.3. LIMITS AND MEASUREMENT RESULT	52
10. FREQUENCY SEPARATION	55
10.1. MEASUREMENT PROCEDURE	55
10.2. TEST SETUP (BLOCK DIAGRAM OF CONFIGURATION)	55
10.3. LIMITS AND MEASUREMENT RESULT	55
11. LINE CONDUCTED EMISSION TEST	57
11.1. LIMITS OF LINE CONDUCTED EMISSION TEST	57
11.2. BLOCK DIAGRAM OF LINE CONDUCTED EMISSION TEST	57
11.3. PRELIMINARY PROCEDURE OF LINE CONDUCTED EMISSION TEST	58
11.4. FINAL PROCEDURE OF LINE CONDUCTED EMISSION TEST	58
11.5. TEST RESULT OF LINE CONDUCTED EMISSION TEST	58
12. ANTENNA REQUIREMENT	59
13. PHOTOGRAPH OF TEST	60
14. PHOTOGRAPHS OF EUT	62



1. TEST SUMMARY

1.1. TEST PROCEDURES AND RESULTS

DESCRIPTION OF TEST	RESULT
PEAK OUTPUT POWER	COMPLIANT
20 DB BANDWIDTH	COMPLIANT
CONDUCTED SPURIOUS EMISSION	COMPLIANT
RADIATED EMISSION	COMPLIANT
BAND EDGES	COMPLIANT
NUMBER OF HOPPING FREQUENCY	COMPLIANT
TIME OF OCCUPANCY	COMPLIANT
FREQUENCY SEPARATION	COMPLIANT
LINE CONDUCTION EMISSION	N/A

Note: N/A means it's not applicable to this item.

1.2. TEST FACILITY

Test Firm : Shenzhen HUAK Testing Technology Co., Ltd.

Address : 1F, B2 Building, Junfeng Zhongcheng Zhizao Innovation Park,
Fuhai Street, Bao'an District, Shenzhen City, China

Designation Number: : CN1229

Test Firm Registration Number : 616276

1.3. MEASUREMENT UNCERTAINTY

Measurement Uncertainty

Conducted Emission Expanded Uncertainty = 2.23dB, k=2

Radiated emission expanded uncertainty(9kHz-30MHz) = 3.08dB, k=2

Radiated emission expanded uncertainty(30MHz-1000MHz) = 4.42dB, k=2

Radiated emission expanded uncertainty(Above 1GHz) = 4.06dB, k=2



2. GENERAL INFORMATION

2.1. GENERAL DESCRIPTION OF EUT

Operation Frequency	2.402 GHz to 2.480GHz
RF Output Power	8.38dBm(Max)
Bluetooth Version	V5.0
Modulation	BR <input checked="" type="checkbox"/> GFSK, EDR <input checked="" type="checkbox"/> π /4-DQPSK, <input checked="" type="checkbox"/> 8DPSK BLE <input type="checkbox"/> GFSK
Number of channels	79 for BR/EDR
Hardware Version	V1.2
Software Version	V0.1
Antenna Designation	Fixed Antenna
Antenna Gain	2.79dBi
Power Supply	DC 3.7V by battery
Note: The EUT comprises left and right channel earphone and both have been tested. This report is only applicable for left earphone.	



2.2. CARRIER FREQUENCY OF CHANNELS

BR/EDR Channel List

Frequency Band	Channel Number	Frequency
2400~2483.5MHz	0	2402MHz
	1	2403MHz
	:	:
	38	2440 MHz
	39	2441 MHz
	40	2442 MHz
	:	:
	77	2479 MHz
	78	2480 MHz

2.3. OPERATION OF EUT DURING TESTING

NO.	TEST MODE DESCRIPTION
1	Low channel GFSK
2	Middle channel GFSK
3	High channel GFSK
4	Low channel $\pi/4$ -DQPSK
5	Middle channel $\pi/4$ -DQPSK
6	High channel $\pi/4$ -DQPSK
7	Low channel 8DPSK
8	Middle channel 8DPSK
9	High channel 8DPSK
11	BT Link(Hopping mode)

Note:

1. All the test modes can be supply by battery, only the result of the worst case was recorded in the report, if no other cases.
2. For Radiated Emission, 3axis were chosen for testing for each applicable mode.
3. The EUT used fully-charged battery when tested.

2.4. DESCRIPTION OF TEST SETUP

Configure 1: (Normal hopping)



Configure 2: (Control continuous TX)

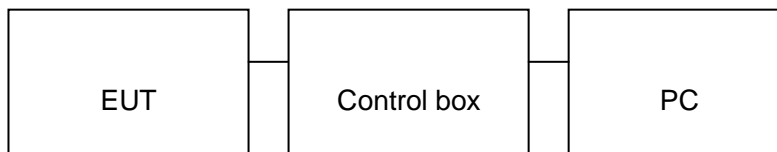

2.5. EQUIPMENT USED IN EUT SYSTEM

Item	Equipment	Mfr/Brand	Model/Type No.	Remark
1	TRUE WIRELESS	JLAB	EPIC AIR ELITE	EUT
2	Battery	LIR	ZJ1654C	Accessory
3	PC	APPLE	A1465	A.E
4	Control box	AIROHA	N/A	A.E
5	USB Cable	N/A	1m unshielded	A.E
6	IPOD	APPLE	A1367	A.E
7	Temporary Antenna Connector	T10	N/A	A.E

Note: The temporary antenna connector is a RF SMA connector with fifty ohm resistor, which is welded to the PCB board or module.

**2.6. MEASUREMENT INSTRUMENTS LIST****TEST EQUIPMENT OF RADIATED EMISSION TEST**

Item	Equipment	Manufacturer	Model No.	Serial No.	Last Cal.	Cal. Interval
1.	Spectrum analyzer	Agilent	N9020A	HKE-048	Dec. 28, 2017	1 Year
2.	Preamplifier	Schwarzbeck	BBV 9743	HKE-006	Dec. 28, 2017	1 Year
3.	EMI Test Receiver	Rohde & Schwarz	ESCI 7	HKE-010	Dec. 28, 2017	1 Year
4.	Bilog Broadband Antenna	Schwarzbeck	VULB9163	HKE-012	Dec. 28, 2017	1 Year
5.	Loop Antenna	Schwarzbeck	FMZB 1519 B	HKE-014	Dec. 28, 2017	1 Year
6.	Horn Antenna	Schwarzbeck	9120D	HKE-013	Dec. 28, 2017	1 Year
7.	Pre-amplifier	EMCI	EMC051845S E	HKE-015	Dec. 28, 2017	1 Year
8.	Pre-amplifier	Agilent	83051A	HKE-016	Dec. 28, 2017	1 Year
9.	Filter (2.4-2.483GHz)	Micro-tronics	087	--	Dec. 28, 2017	1 Year
10.	Radiation Cable 1	MXT	HK1	R05	N/A	N/A
11.	Radiation Cable 2	MXT	HK1	R06	N/A	N/A



3. PEAK OUTPUT POWER

3.1. MEASUREMENT PROCEDURE

For peak power test:

1. Connect EUT RF output port to the Spectrum Analyzer through an RF attenuator
2. Set the EUT Work on the top, middle and the bottom operation frequency individually.
3. $RBW >$ the 20 dB bandwidth of the emission being measured, $VBW \geq RBW$.
4. Record the maximum power from the Spectrum Analyzer.
5. The maximum peak power shall be less 21dBm.

3.2. TEST SET-UP (BLOCK DIAGRAM OF CONFIGURATION)

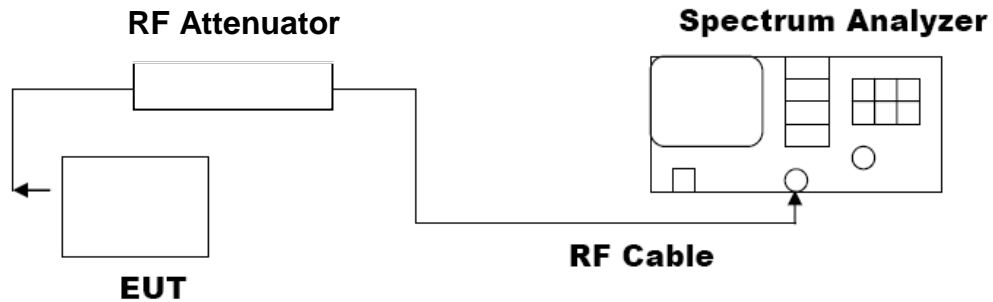



3.3. LIMITS AND MEASUREMENT RESULT

PEAK OUTPUT POWER MEASUREMENT RESULT FOR GFSK MOUDULATION			
Frequency (GHz)	Peak Power (dBm)	Applicable Limits (dBm)	Pass or Fail
2.402	7.49	21	Pass
2.441	8.09	21	Pass
2.480	8.38	21	Pass

CH0

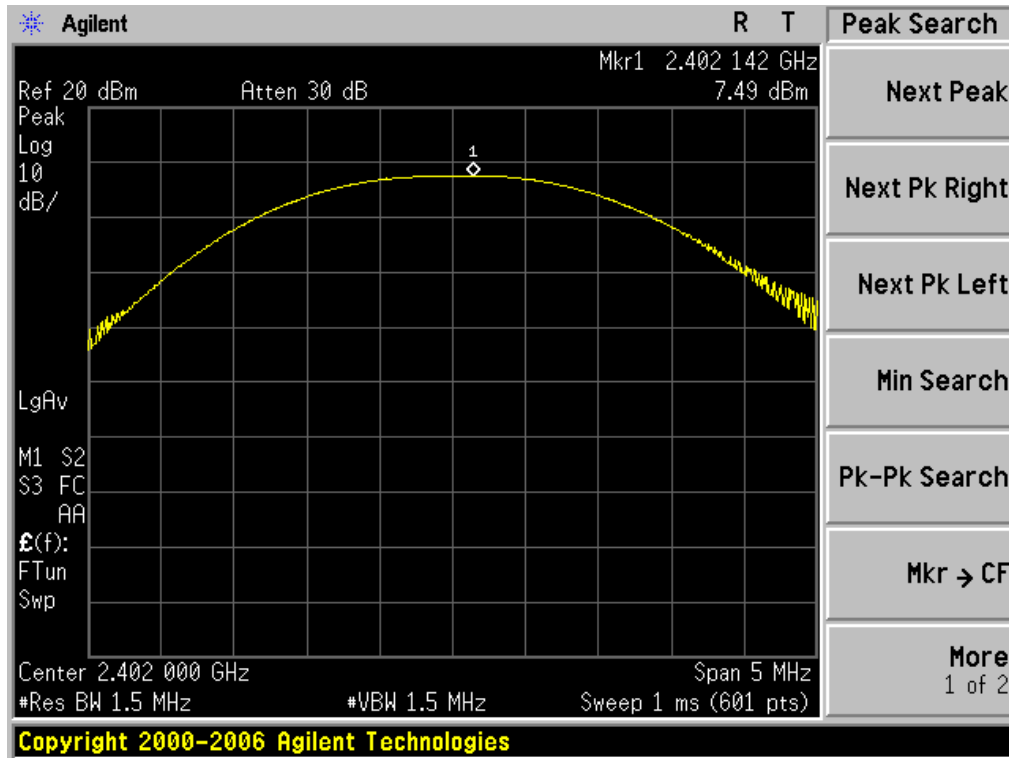



CH39

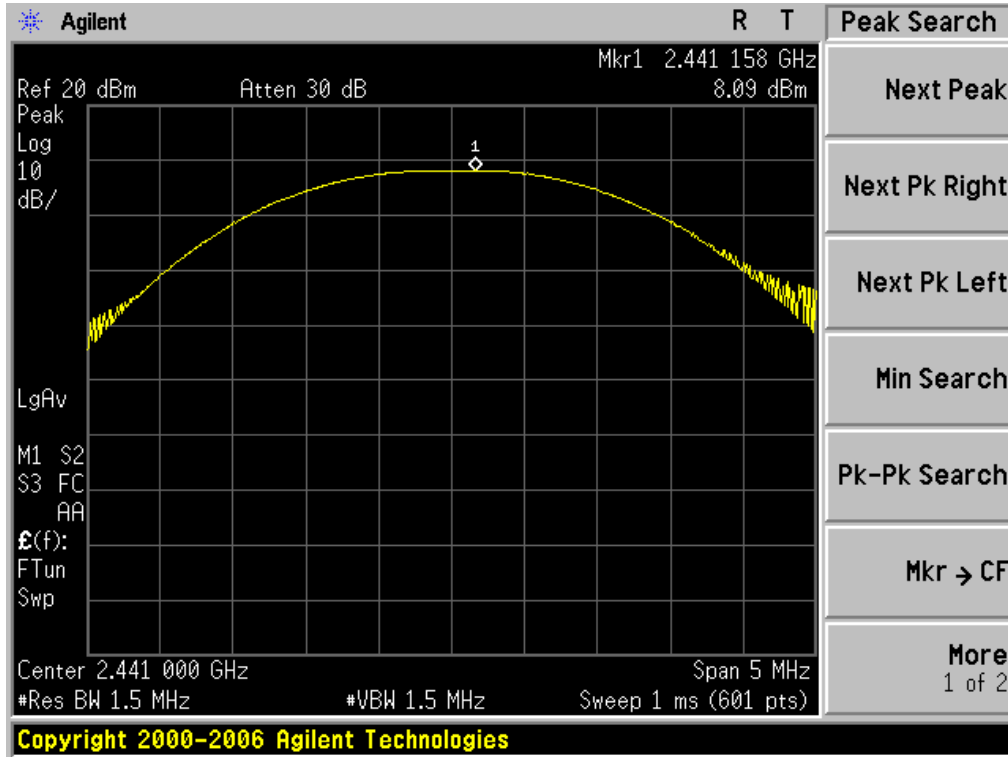

CH78

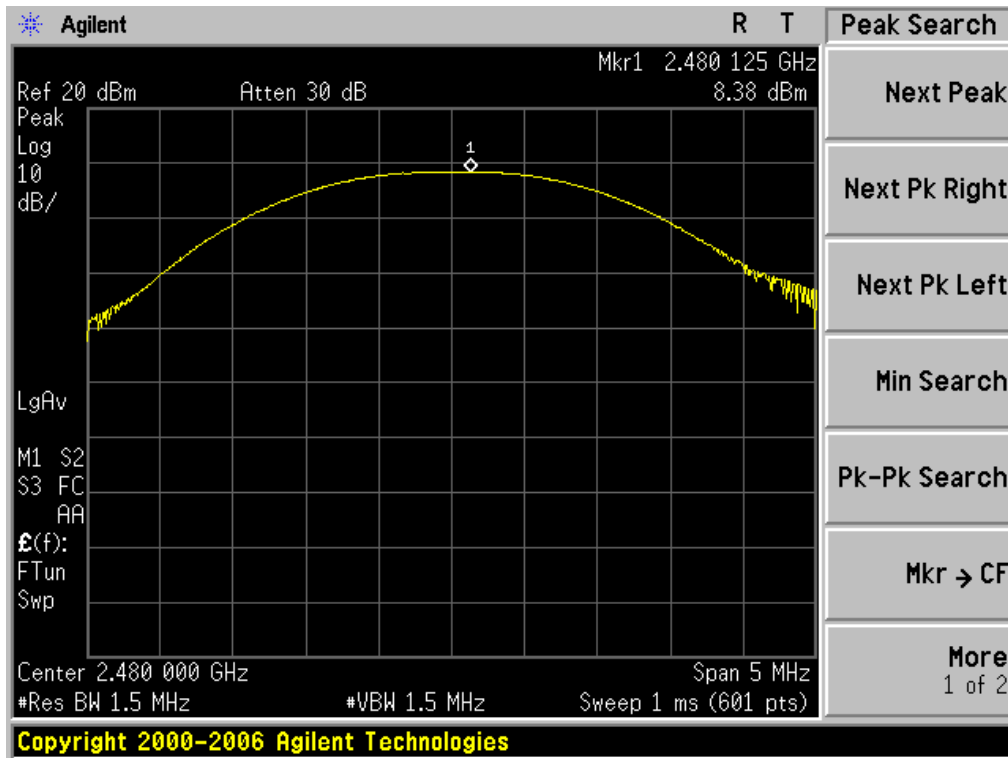



PEAK OUTPUT POWER MEASUREMENT RESULT FOR Π /4-DQPSK MODULATION			
Frequency (GHz)	Peak Power (dBm)	Applicable Limits (dBm)	Pass or Fail
2.402	7.19	21	Pass
2.441	7.84	21	Pass
2.480	7.98	21	Pass

CH0

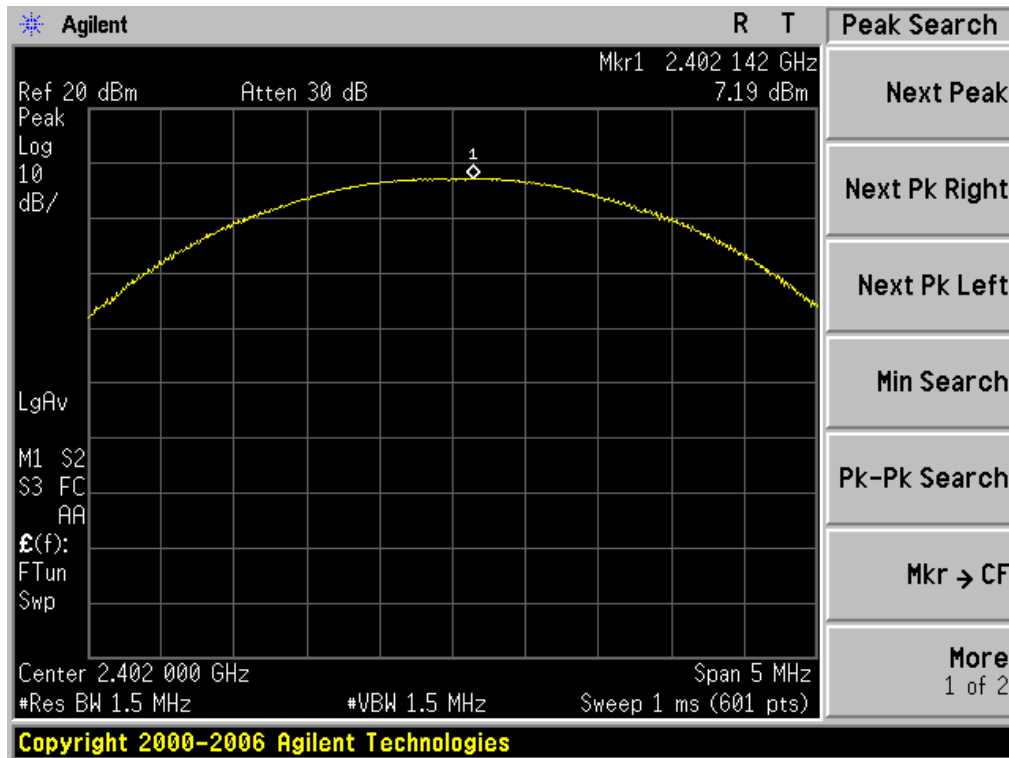



CH39

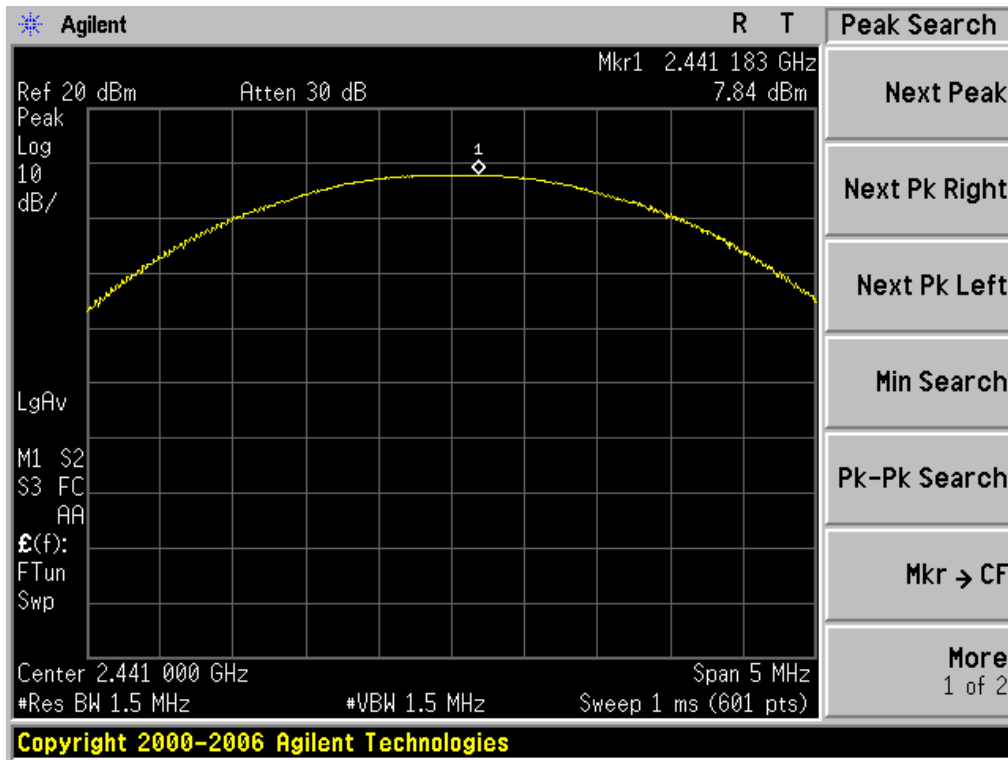

CH78

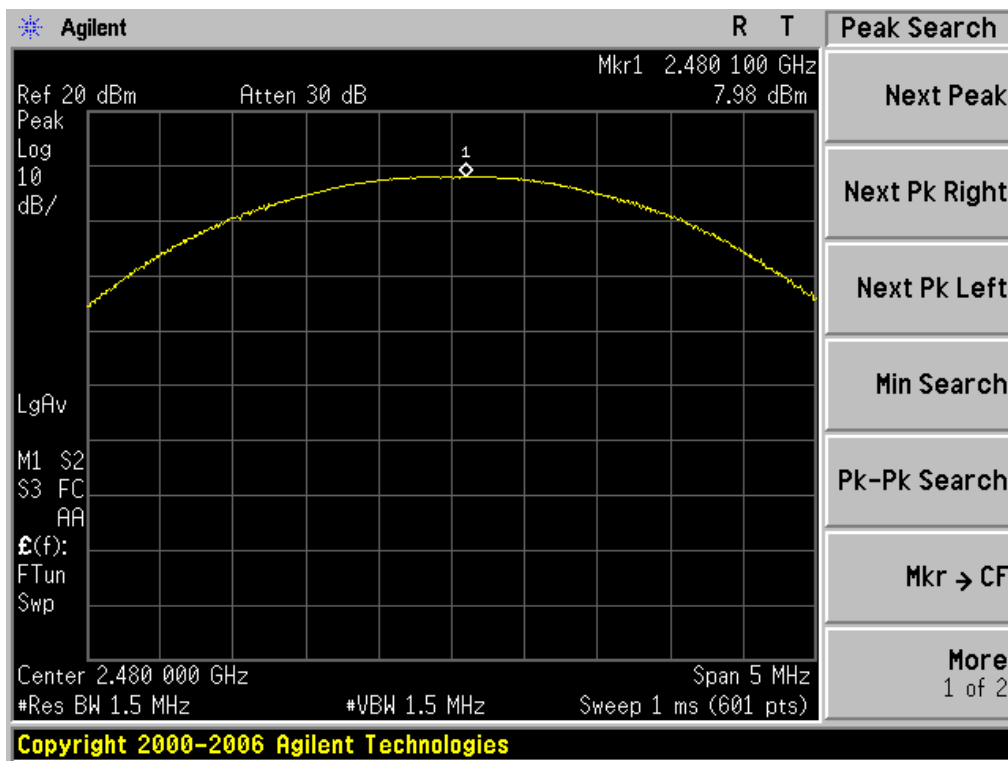



PEAK OUTPUT POWER MEASUREMENT RESULT FOR 8DPSK MODULATION			
Frequency (GHz)	Peak Power (dBm)	Applicable Limits (dBm)	Pass or Fail
2.402	7.28	21	Pass
2.441	7.93	21	Pass
2.480	8.13	21	Pass

CH0

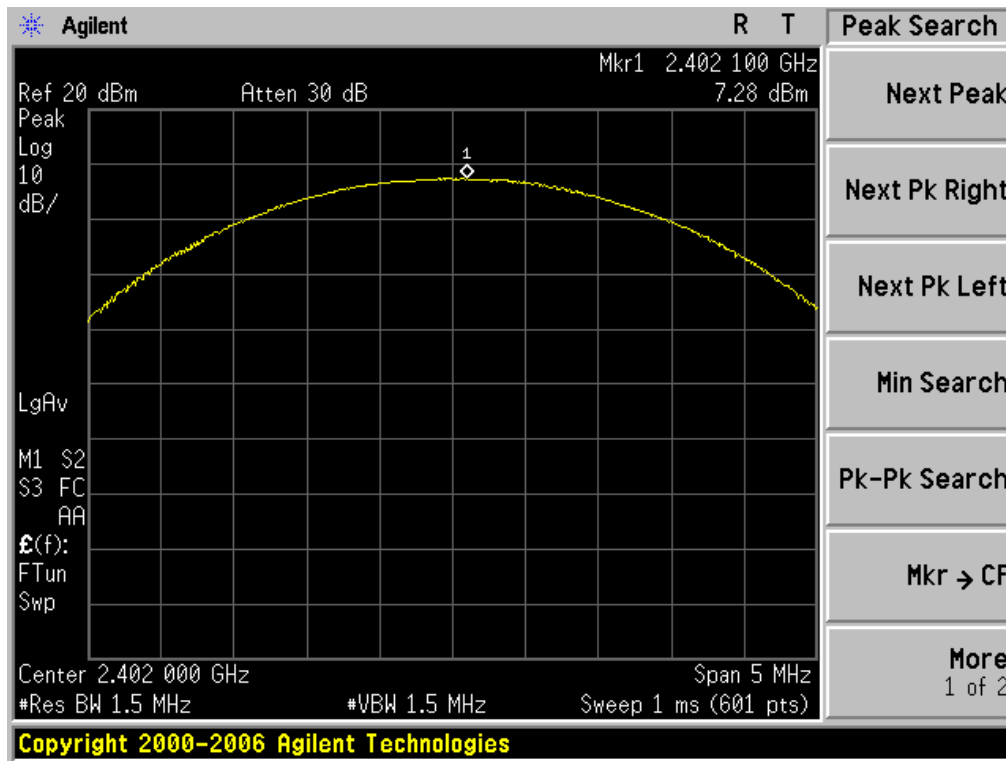



CH39

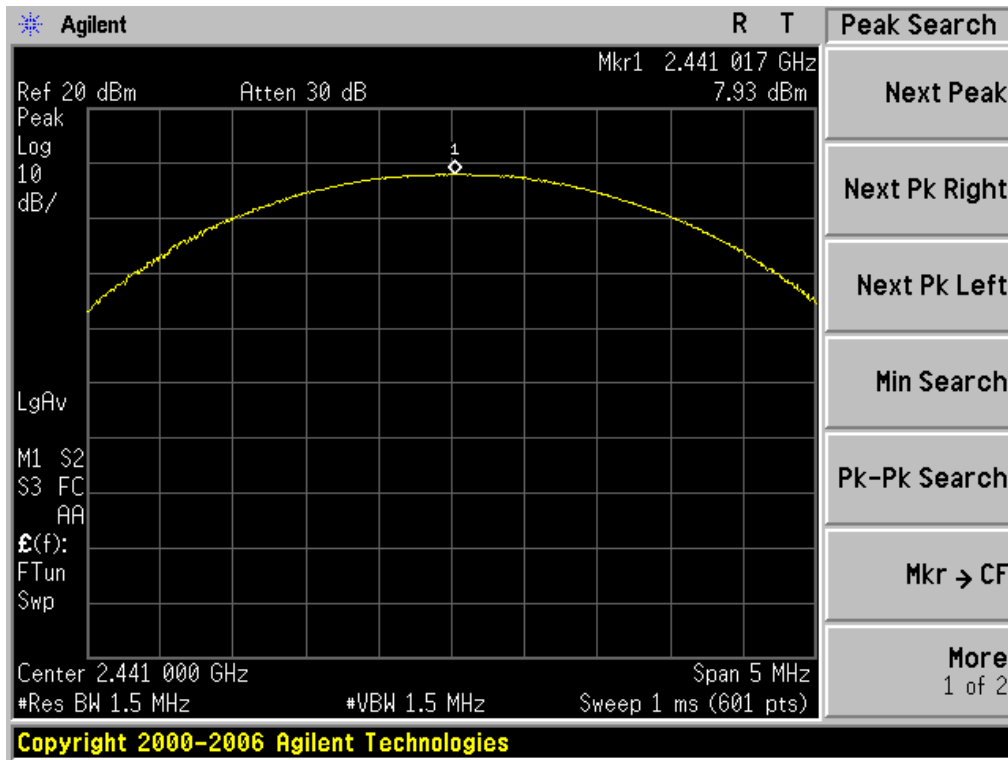

CH78

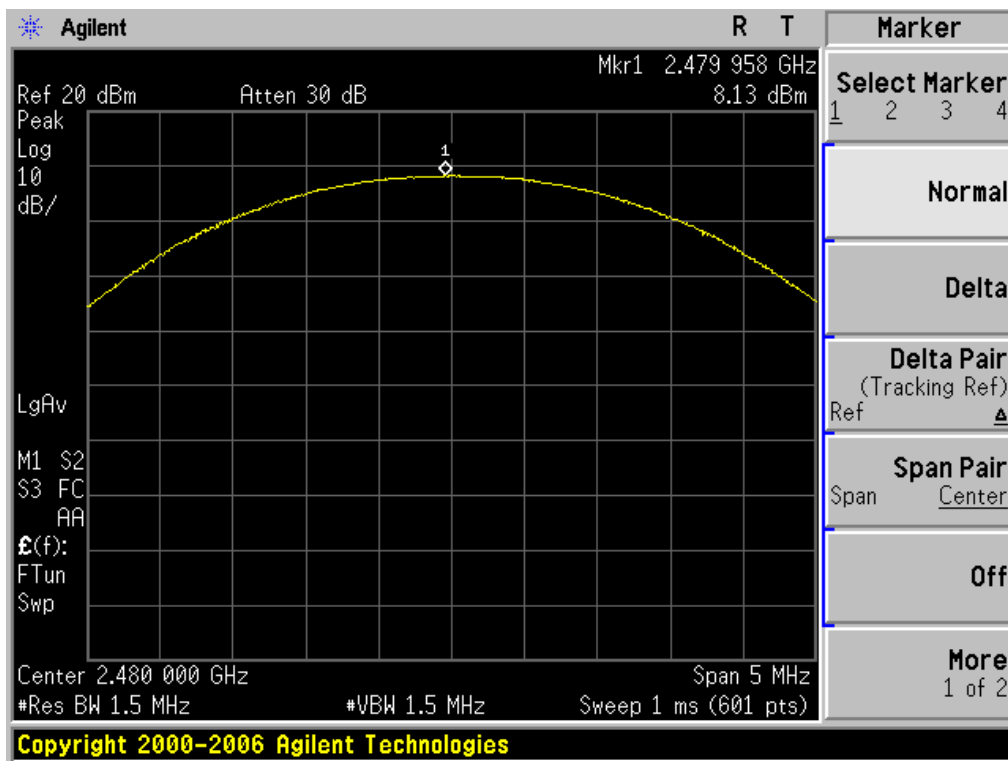

4. BANDWIDTH

4.1. MEASUREMENT PROCEDURE

1. Connect EUT RF output port to the Spectrum Analyzer through an RF attenuator
2. Set the EUT Work on the top, the middle and the bottom operation frequency individually.
3. Set Span = approximately 2 to 3 times the 20 dB bandwidth, centered on a hopping channel
 RBW \geq 1% of the 20 dB bandwidth, VBW \geq 3RBW; Sweep = auto; Detector function = peak
4. Set SPA Trace 1 Max hold, then View.

4.2. TEST SET-UP (BLOCK DIAGRAM OF CONFIGURATION)

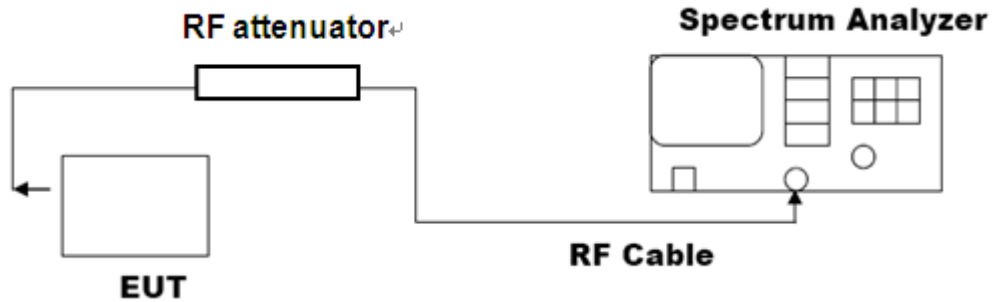

Note: The EUT has been used temporary antenna connector for testing.

4.3. LIMITS AND MEASUREMENT RESULTS

BLUETOOTH 1MBPS LIMITS AND MEASUREMENT RESULT				
Applicable Limits	Measurement Result			
	Test Data (MHz)			Result
		99%OBW (MHz)	-20dB BW(MHz)	
N/A	Low Channel	0.946	1.094	PASS
	Middle Channel	0.949	1.093	PASS
	High Channel	0.949	1.102	PASS



TEST PLOT OF BANDWIDTH FOR LOW CHANNEL

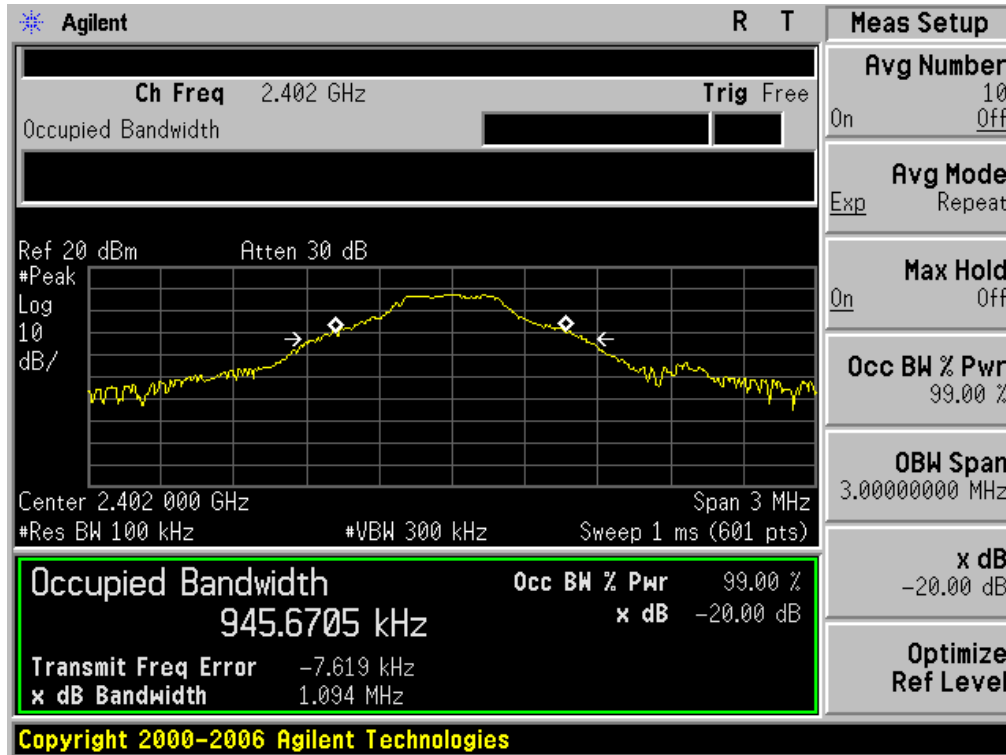

TEST PLOT OF BANDWIDTH FOR MIDDLE CHANNEL

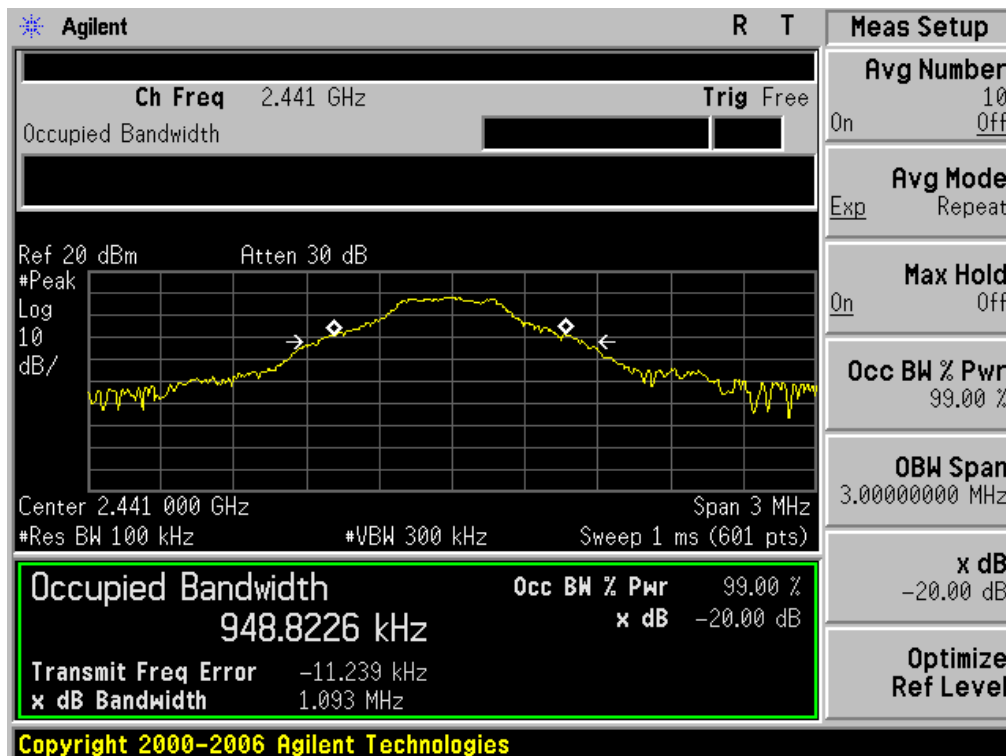



TEST PLOT OF BANDWIDTH FOR HIGH CHANNEL

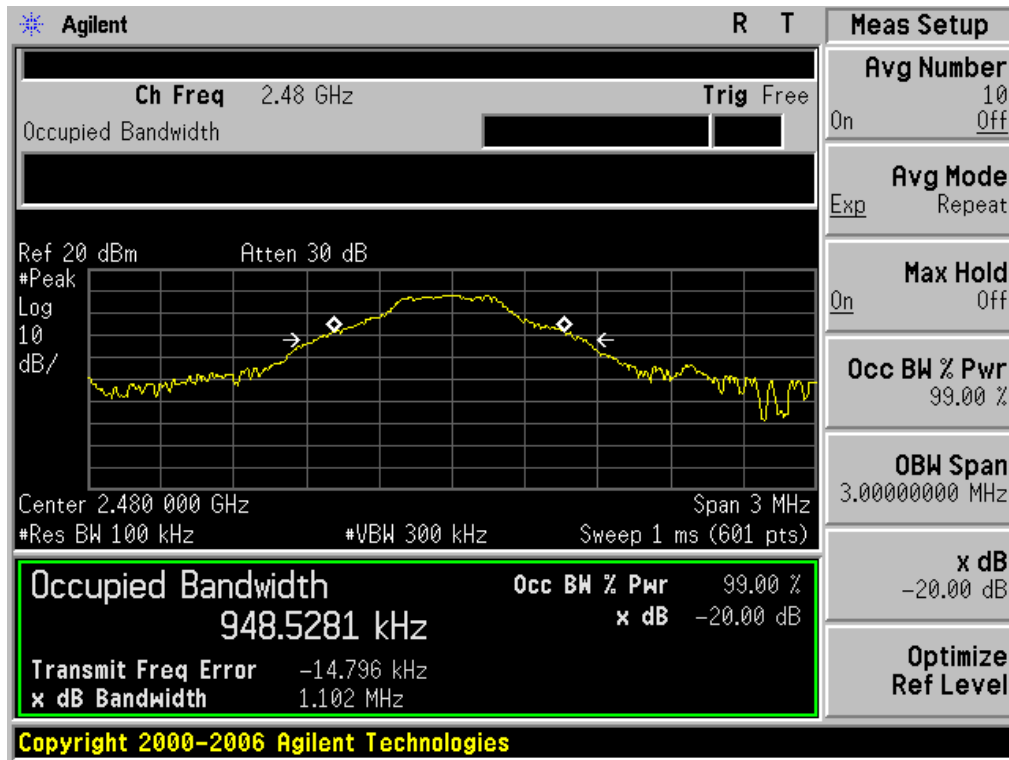



BLUETOOTH 2MBPS LIMITS AND MEASUREMENT RESULT				
Applicable Limits	Measurement Result			
	Test Data (MHz)			Result
		99%OBW (MHz)	-20dB BW(MHz)	
N/A	Low Channel	1.236	1.373	PASS
	Middle Channel	1.244	1.381	PASS
	High Channel	1.263	1.389	PASS

TEST PLOT OF BANDWIDTH FOR LOW CHANNEL

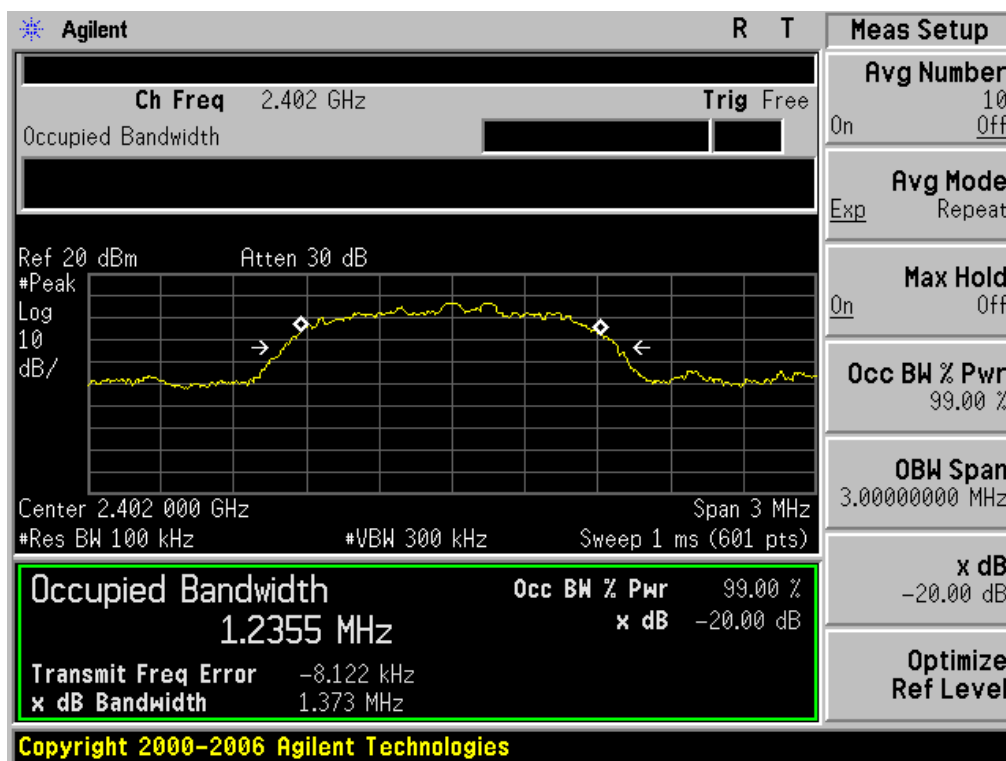



TEST PLOT OF BANDWIDTH FOR MIDDLE CHANNEL

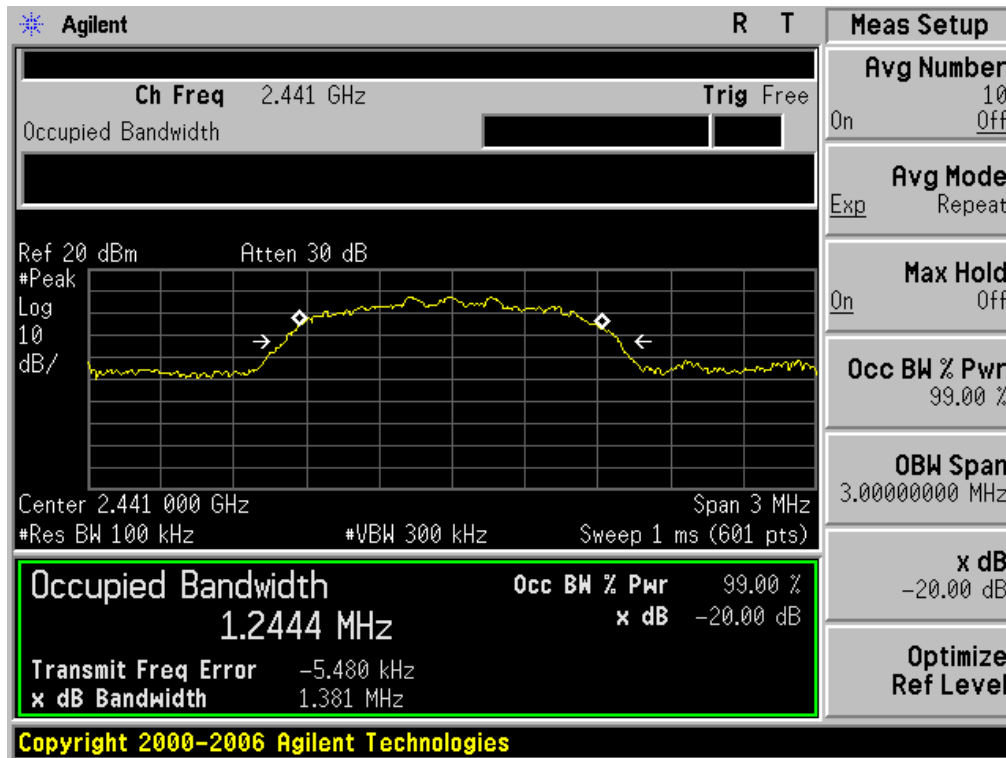

TEST PLOT OF BANDWIDTH FOR HIGH CHANNEL

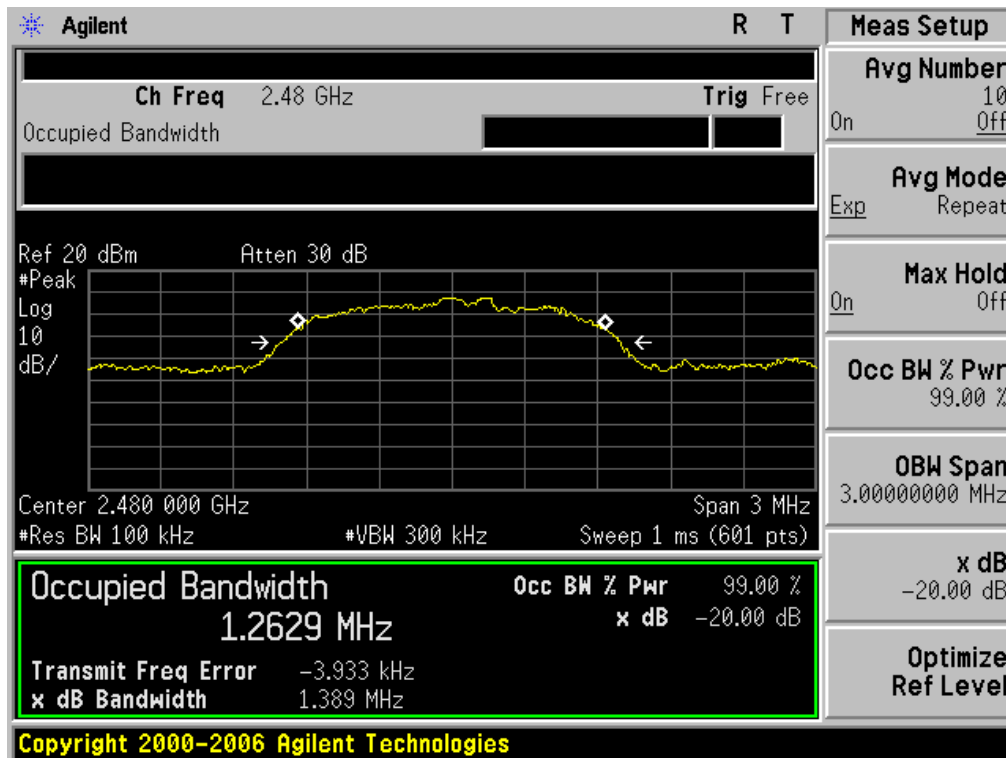



BLUETOOTH 3MBPS LIMITS AND MEASUREMENT RESULT				
Applicable Limits	Measurement Result			
	Test Data (MHz)			Result
		99%OBW (MHz)	-20dB BW(MHz)	
N/A	Low Channel	1.233	1.374	PASS
	Middle Channel	1.258	1.377	PASS
	High Channel	1.258	1.383	PASS

TEST PLOT OF BANDWIDTH FOR LOW CHANNEL

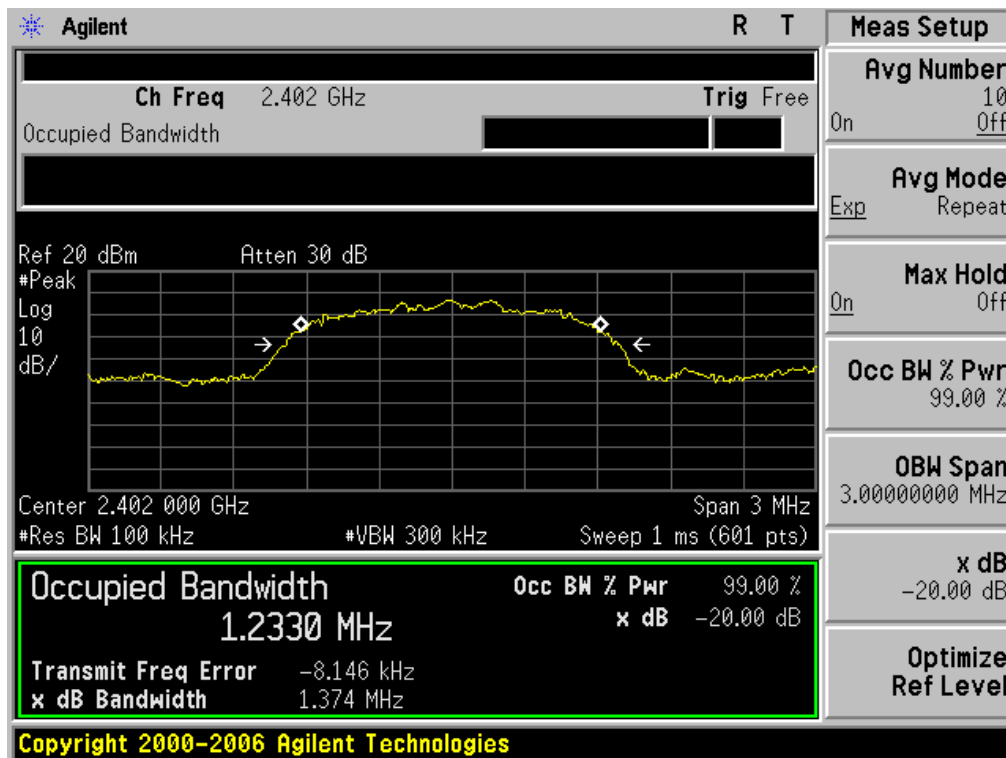



TEST PLOT OF BANDWIDTH FOR MIDDLE CHANNEL

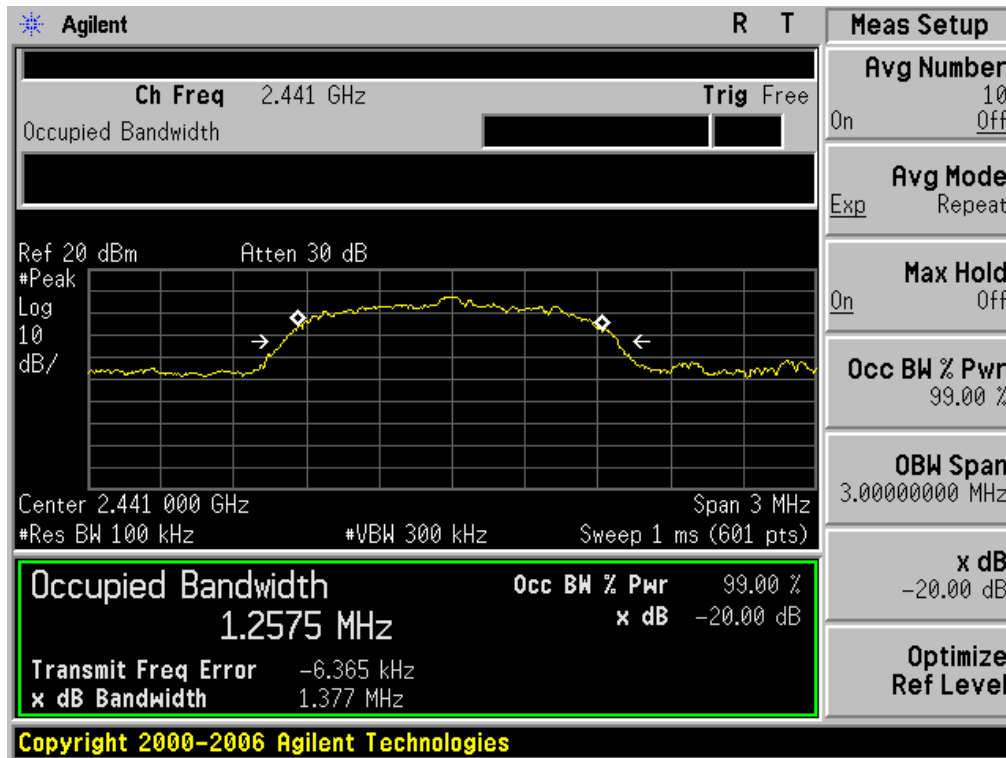

TEST PLOT OF BANDWIDTH FOR HIGH CHANNEL

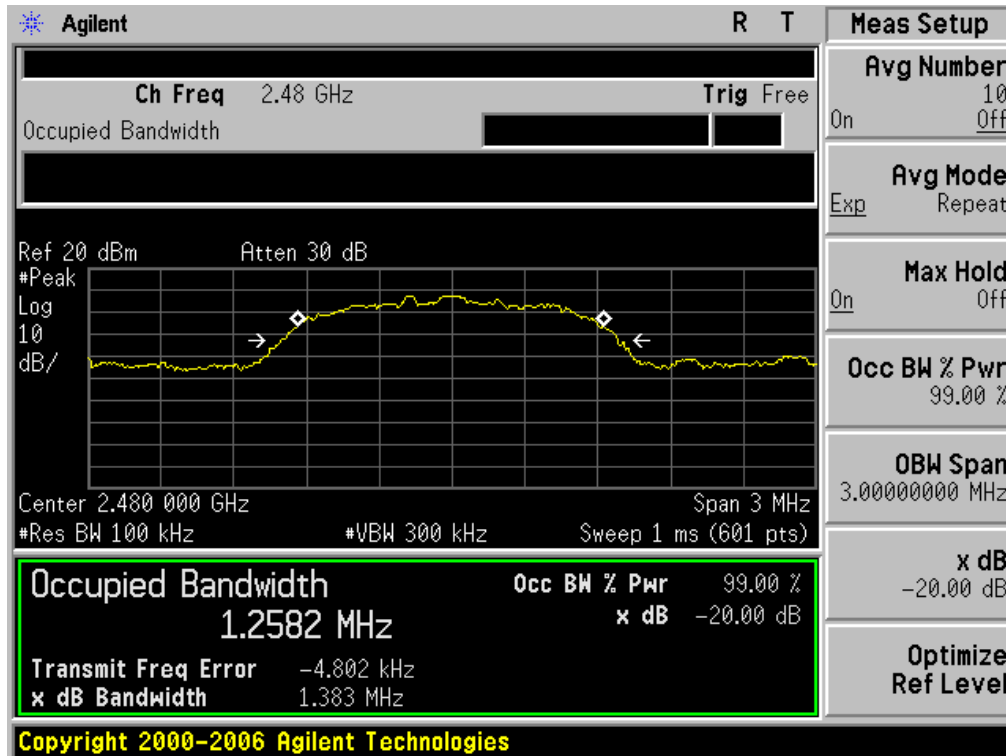

5. CONDUCTED SPURIOUS EMISSION

5.1. MEASUREMENT PROCEDURE

1. Connect EUT RF output port to the Spectrum Analyzer through an RF attenuator
2. Set the EUT Work on the top, the Middle and the bottom operation frequency individually.
3. Set the Span = wide enough to capture the peak level of the in-band emission and all spurious emissions from the lowest frequency generated in the EUT up through the 10th harmonic.
RBW = 100 kHz; VBW = 300kHz; Sweep = auto; Detector function = peak.
4. Set SPA Trace 1 Max hold, then View.

5.2. TEST SET-UP (BLOCK DIAGRAM OF CONFIGURATION)

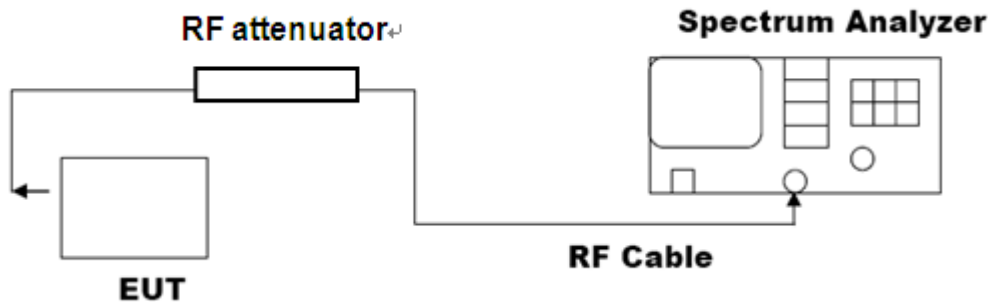

5.3. LIMITS AND MEASUREMENT RESULT

LIMITS AND MEASUREMENT RESULT		
Applicable Limits	Measurement Result	
	Test Data	Result
In any 100 KHz Bandwidth Outside the frequency band in which the spread spectrum intentional radiator is operating, the radio frequency power that is produce by the intentional radiator shall be at least 20 dB below that in 100KHz bandwidth within the band that contains the highest level of the desired power. In addition, radiation emissions which fall in the restricted bands, as defined in §15.205(a), must also comply with the radiated emission limits specified in§15.209(a))	At least -20dBc than the limit Specified on the BOTTOM Channel	PASS
	At least -20dBc than the limit Specified on the TOP Channel	PASS



TEST PLOT OF OUT OF BAND EMISSIONS WITH THE WORST CASE OF GFSK MODULATION IN LOW CHANNEL

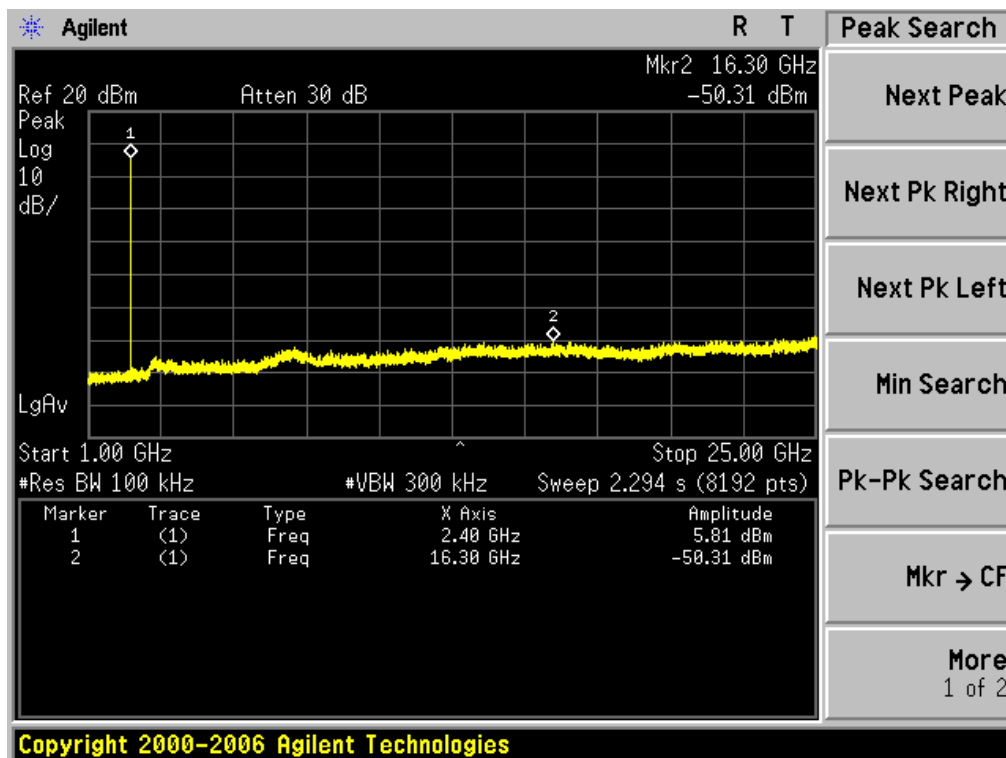
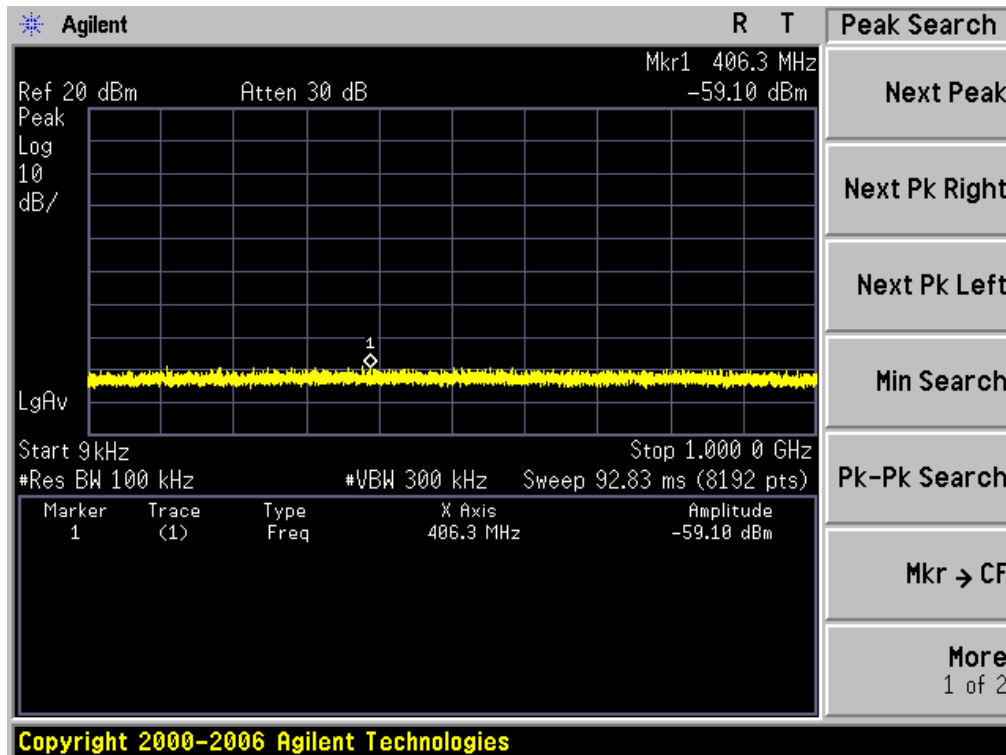



TEST PLOT OF OUT OF BAND EMISSIONS OF GFSK MODULATION IN MIDDLE CHANNEL

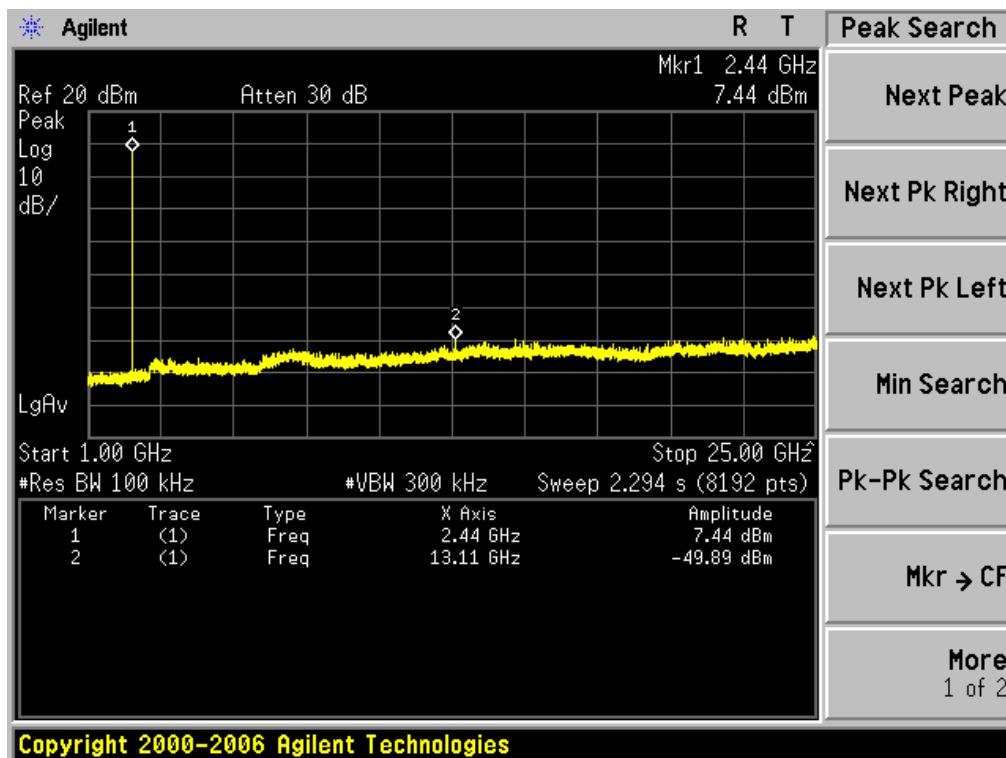
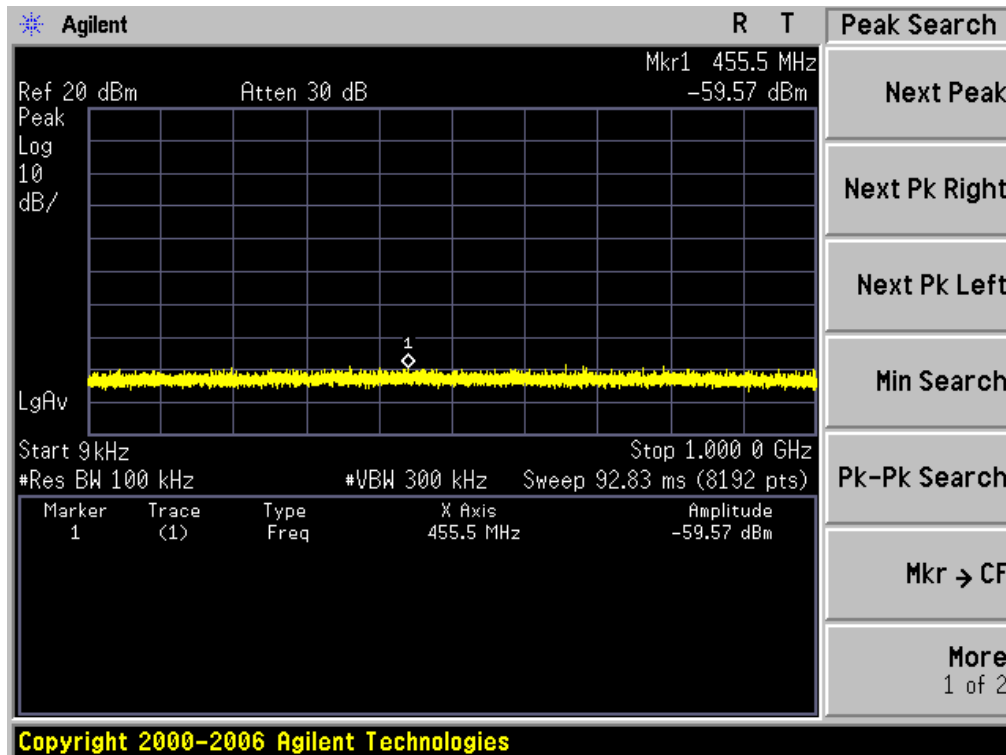



TEST PLOT OF OUT OF BAND EMISSIONS OF GFSK MODULATION IN HIGH CHANNEL

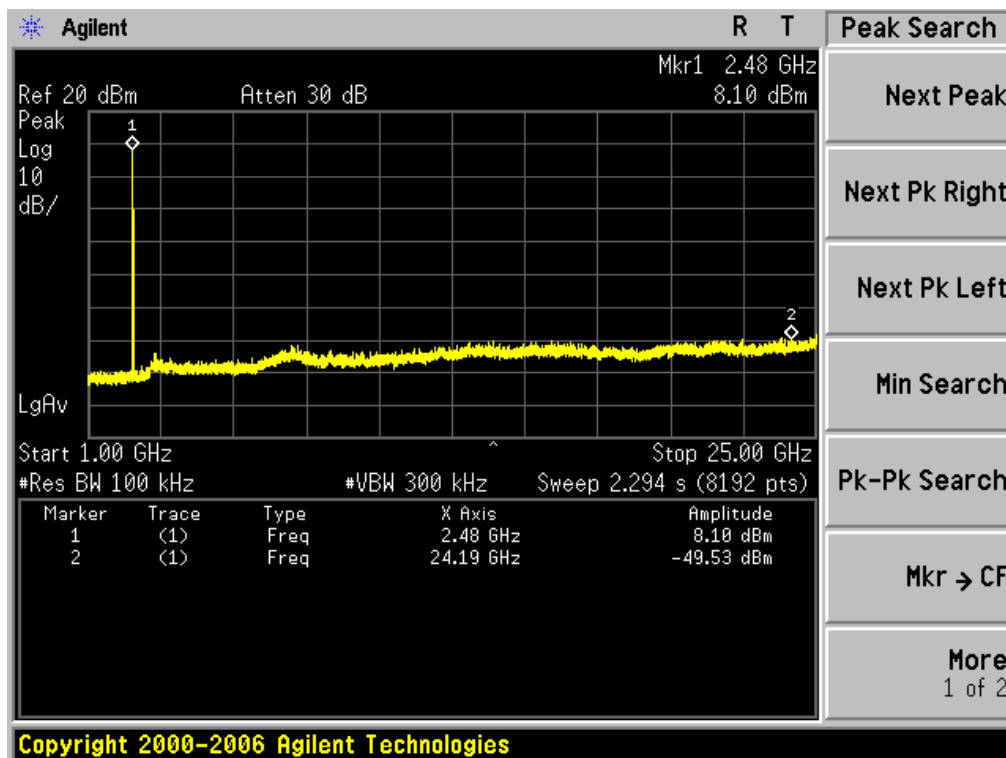
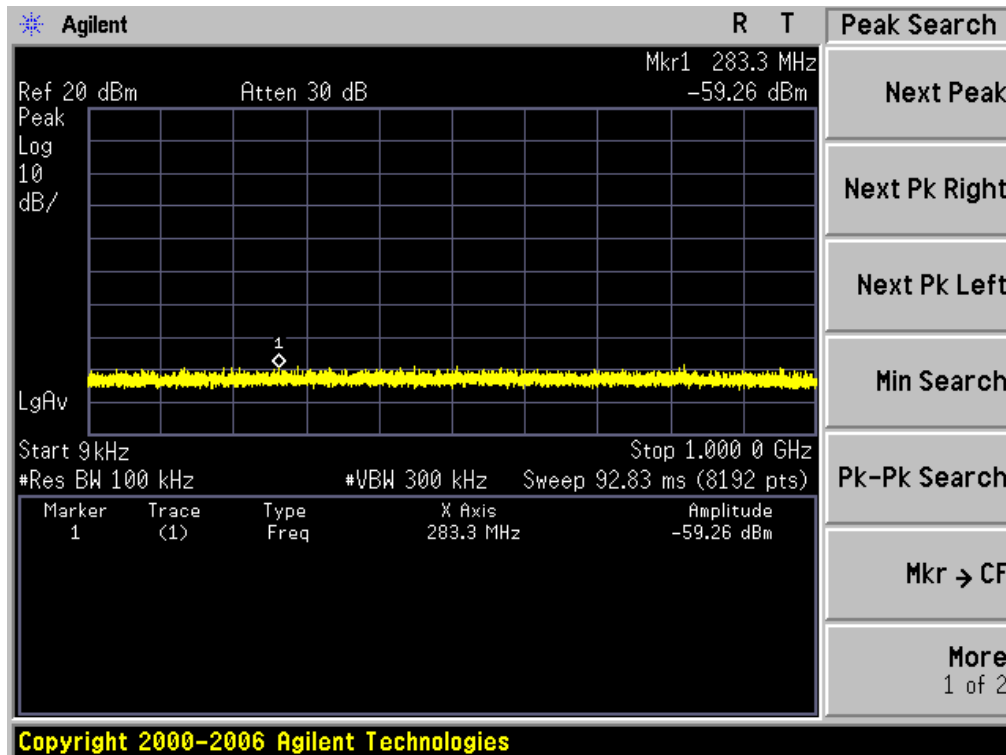



6. RADIATED EMISSION

6.1. TEST LIMIT

Frequency (MHz)	Distance Meters	Field Strengths Limit	
		μ V/m	dB(μ V)/m
0.009 ~ 0.490	300	2400/F(kHz)	---
0.490 ~ 1.705	30	24000/F(kHz)	---
1.705 ~ 30	30	30	---
30 ~ 88	3	100	40.0
88 ~ 216	3	150	43.5
216 ~ 960	3	200	46.0
960 ~ 1000	3	500	54.0
Above 1000	3	Other:74.0 dB(μ V)/m (Peak) 54.0 dB(μ V)/m (Average)	

Remark: (1) Emission level dB μ V = 20 log Emission level μ V/m
(2) The smaller limit shall apply at the cross point between two frequency bands.
(3) Distance is the distance in meters between the measuring instrument, antenna and the closest point of any part of the device or system.

6.2. MEASUREMENT PROCEDURE

1. The measuring distance of 3m shall be used for measurements. The EUT was placed on the top of a rotating table 0.8 meter above the ground at a 3 meter semi-anechoic chamber. The table was rotated 360 degrees to determine the position of the highest radiation(Below 1GHz)
2. The measuring distance of 3m shall used for measurements. The EUT was placed on the top of a rotating table 1.5 meter above the ground at a 3 meter semi-anechoic chamber. The table was rotated 360 degrees to determine the position of the highest radiation(Above 1GHz)
3. The height of the test antenna shall vary between 1m to 4m.Both horizontal and vertical polarization Of the antenna are set to make the measurement.
4. The initial step in collecting radiated emission data is a receive peak detector mode. Pre-scanning the measurement frequency range. Significant peaks are then marked and then Quasi Peak detector mode re-measured.
5. All readings are peak unless otherwise stated QP in column of Note. Peak denoted that the Peak reading compliance with the QP limits and then QP Mode measurement didn't perform(Below 1GHz)
6. All readings are Peak mode value unless otherwise stated AVG in column of Note. If the Peak mode measured value compliance with the Peak limits and lower than AVG Limits, the EUT shall be deemed to meet Peak&AVG limits and then only Peak mode was measured, but AVG mode didn't perform.(Above 1GHz)



The following table is the setting of spectrum analyzer and receiver.

Spectrum Parameter	Setting
Start ~Stop Frequency	9KHz~150KHz/RB 200Hz for QP
Start ~Stop Frequency	150KHz~30MHz/RB 9KHz for QP
Start ~Stop Frequency	30MHz~1000MHz/RB 120KHz for QP
Start ~Stop Frequency	1GHz~26.5GHz RBW 1MHz/ VBW 3MHz for Peak, RBW 1MHz/ VBW 10Hz for Average

Receiver Parameter	Setting
Start ~Stop Frequency	9KHz~150KHz/RB 200Hz for QP
Start ~Stop Frequency	150KHz~30MHz/RB 9KHz for QP
Start ~Stop Frequency	30MHz~1000MHz/RB 120KHz for QP

6.3. TEST SETUP

RADIATED EMISSION TEST SETUP BELOW 30MHz

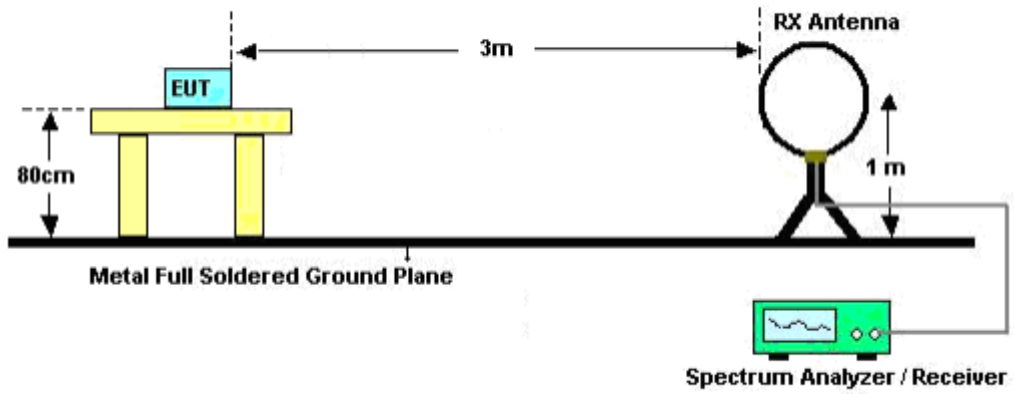

RADIATED EMISSION TEST SETUP 30MHz-1000MHz

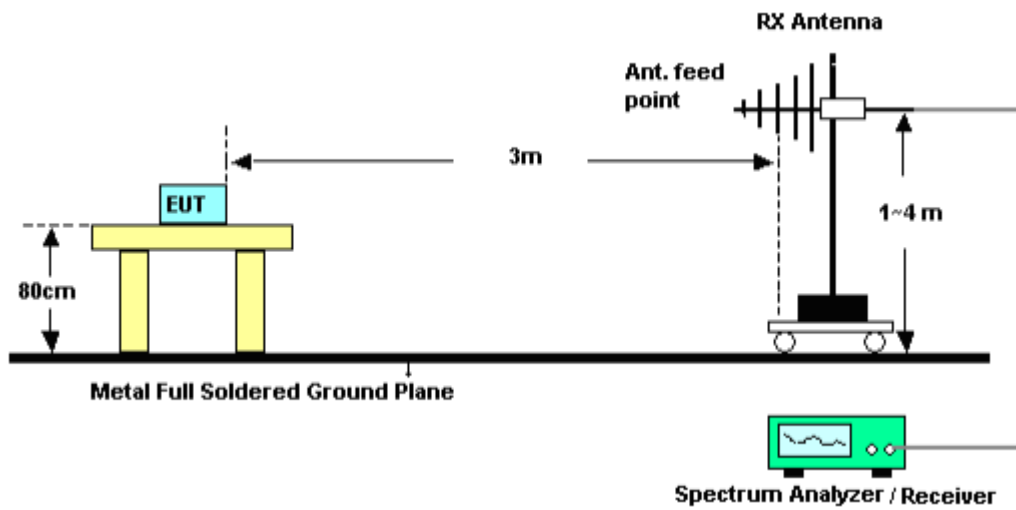

RADIATED EMISSION TEST SETUP ABOVE 1000MHz

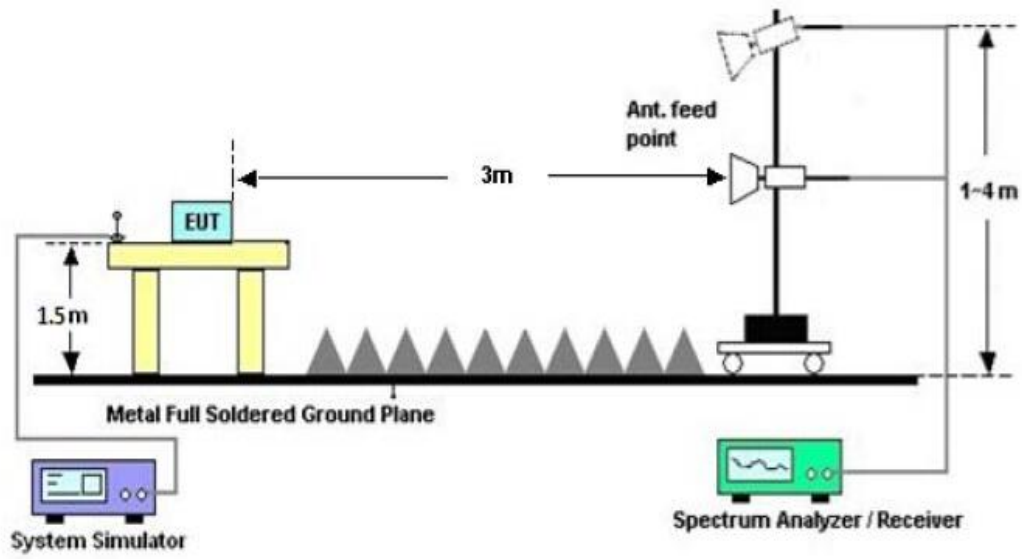



6.4. TEST RESULT

(Worst Modulation: GFSK)

RADIATED EMISSION BELOW 30MHz

No emission found between lowest internal used/generated frequencies to 30MHz.



RADIATED EMISSION BELOW 1GHz

RADIATED EMISSION TEST- (30MHz-1GHz)-LOW CHANNEL-HORIZONTAL

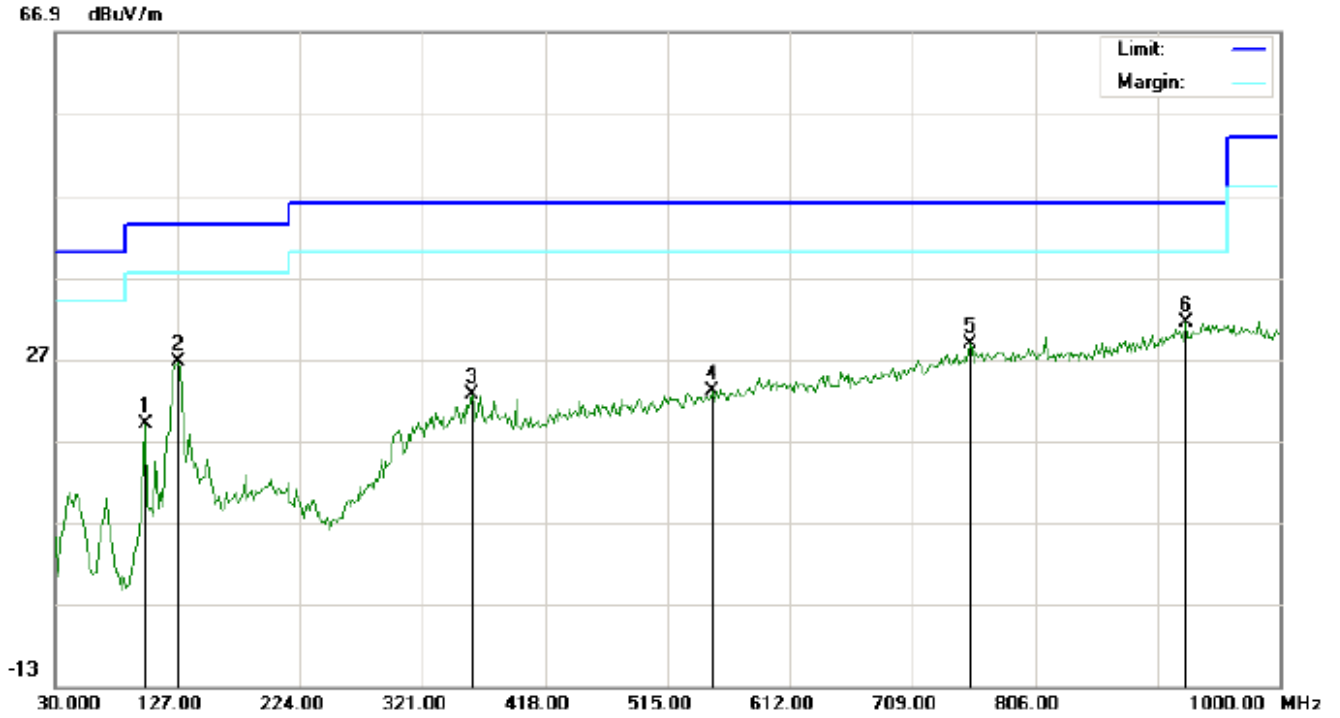

No.	Mk	Freq.	Reading	Factor	Measurement	Limit	Over	Detector	Antenna Height	Table Degree	Comment
		MHz	dBuV	dB/m	dBuV/m	dBuV/m	dB		cm	degree	
1		101.1333	8.74	10.22	18.96	43.50	-24.54	peak			
2		127.0000	17.41	9.13	26.54	43.50	-16.96	peak			
3		359.8000	3.81	18.80	22.61	46.00	-23.39	peak			
4		550.5667	0.43	22.49	22.92	46.00	-23.08	peak			
5		754.2667	2.16	26.69	28.85	46.00	-17.15	peak			
6	*	925.6333	2.02	29.32	31.34	46.00	-14.66	peak			

RESULT: PASS



RADIATED EMISSION TEST- (30MHz-1GHz)-LOW CHANNEL -VERTICAL

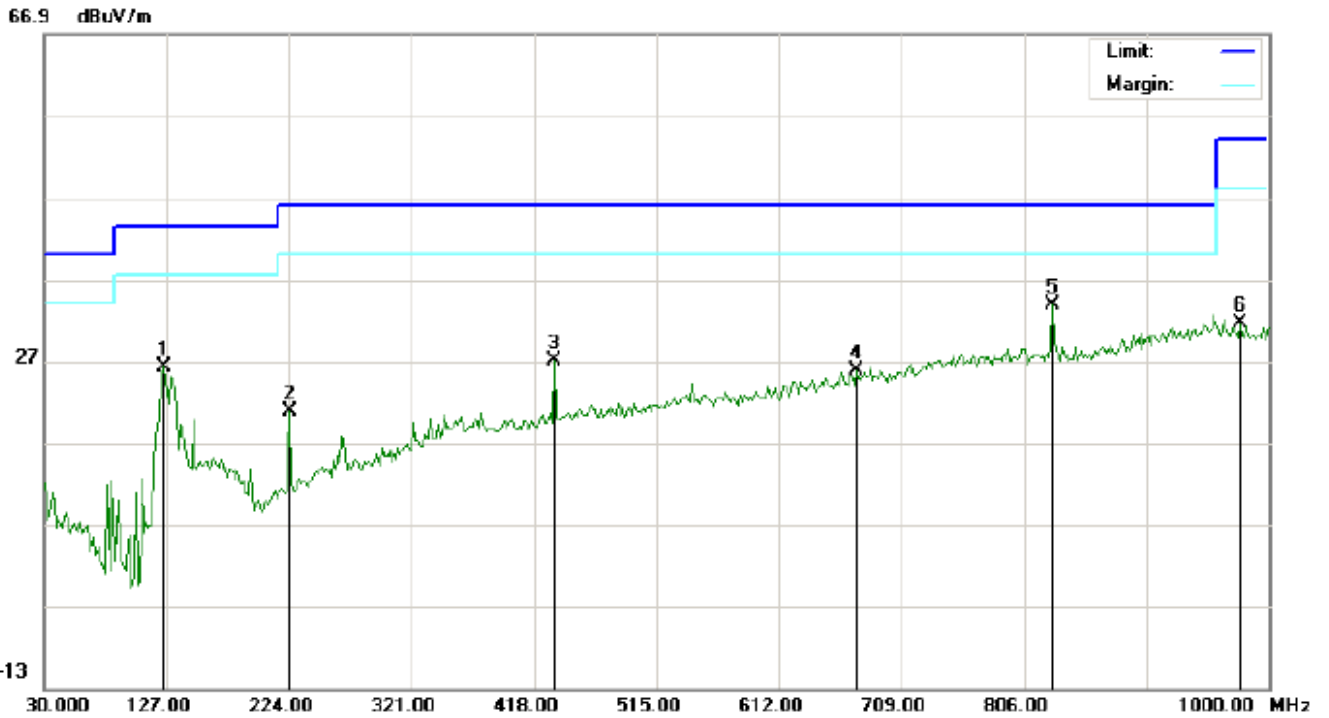

No.	Mk	Freq.	Reading	Factor	Measurement	Limit	Over	Detector	Antenna Height	Table Degree	Comment
		MHz	dBuV	dB/m	dBuV/m	dBuV/m	dB		cm	degree	
1		125.3833	17.20	9.10	26.30	43.50	-17.20	peak			
2		224.0000	9.55	11.35	20.90	46.00	-25.10	peak			
3		434.1667	6.84	20.11	26.95	46.00	-19.05	peak			
4		673.4333	1.27	24.48	25.75	46.00	-20.25	peak			
5	*	828.6332	6.59	27.31	33.90	46.00	-12.10	peak			
6		977.3667	1.92	29.74	31.66	54.00	-22.34	peak			

RESULT: PASS

Note: 1. Factor=Antenna Factor + Cable loss, Margin=Measurement-Limit.

2. The "Factor" value can be calculated automatically by software of measurement system.



RADIATED EMISSION TEST- (30MHz-1GHz)-MIDDLE CHANNEL-HORIZONTAL

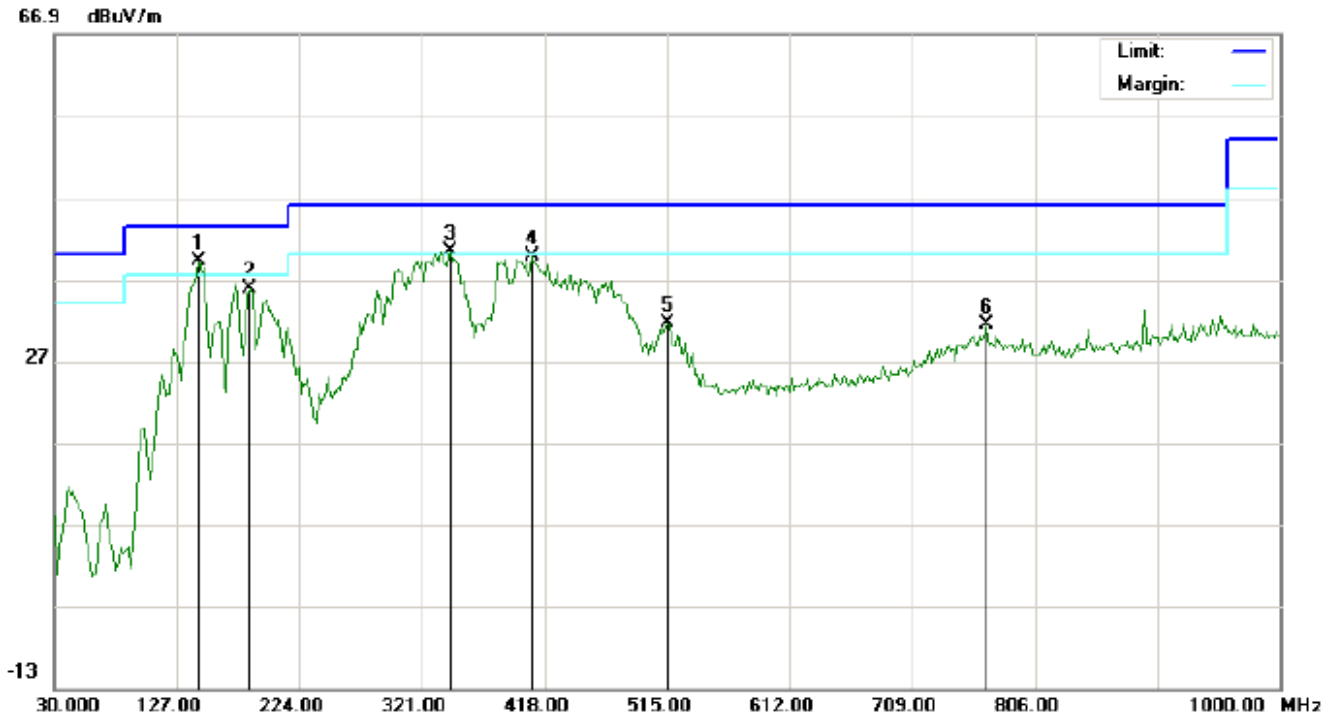

No.	Mk	Freq.	Reading	Factor	Measurement	Limit	Over	Detector	Antenna Height	Table Degree	Comment
		MHz	dBuV	dB/m	dBuV/m	dBuV/m	dB		cm	degree	
1	*	144.7831	25.13	14.04	39.17	43.50	-4.33	peak			
2		185.1999	24.51	11.31	35.82	43.50	-7.68	peak			
3	!	343.6333	22.12	18.32	40.44	46.00	-5.56	peak			
4		408.3000	20.40	19.32	39.72	46.00	-6.28	peak			
5		515.0000	9.99	21.53	31.52	46.00	-14.48	peak			
6		767.2000	4.46	26.87	31.33	46.00	-14.67	peak			

RESULT: PASS



RADIATED EMISSION TEST- (30MHz-1GHz)- MIDDLE CHANNEL -VERTICAL

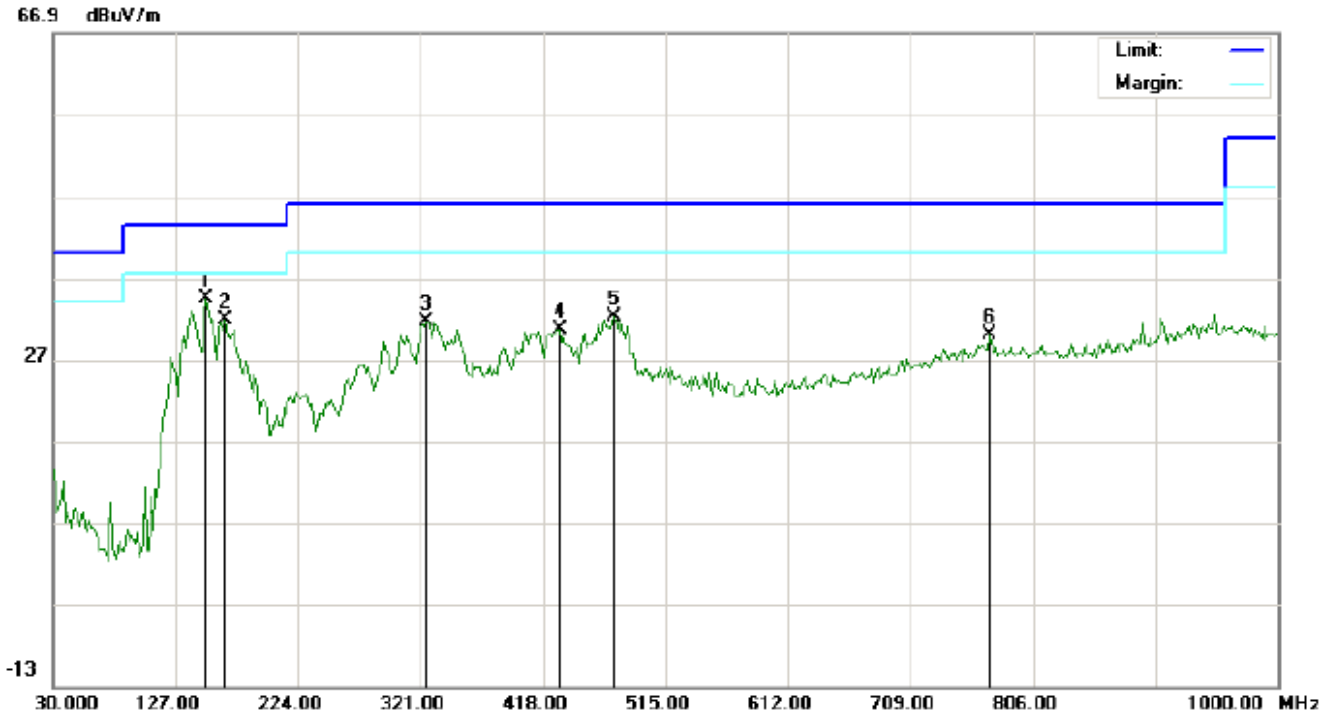

No.	Mk	Freq.	Reading	Factor	Measurement	Limit	Over	Detector	Antenna	Table	Comment
		MHz	dBuV	dB/m	dBuV/m	dBuV/m	dB		Height	Degree	
									cm	degree	
1	*	151.2500	19.14	15.27	34.41	43.50	-9.09	peak			
2		165.8000	16.93	14.96	31.89	43.50	-11.61	peak			
3		325.8500	14.41	17.13	31.54	46.00	-14.46	peak			
4		430.9333	10.68	20.01	30.69	46.00	-15.31	peak			
5		474.5833	11.33	20.86	32.19	46.00	-13.81	peak			
6		772.0500	3.07	26.93	30.00	46.00	-16.00	peak			

RESULT: PASS

Note: 1. Factor=Antenna Factor + Cable loss, Margin=Measurement-Limit.

2. The "Factor" value can be calculated automatically by software of measurement system.



RADIATED EMISSION TEST- (30MHz-1GHz)-HIGH CHANNEL-HORIZONTAL

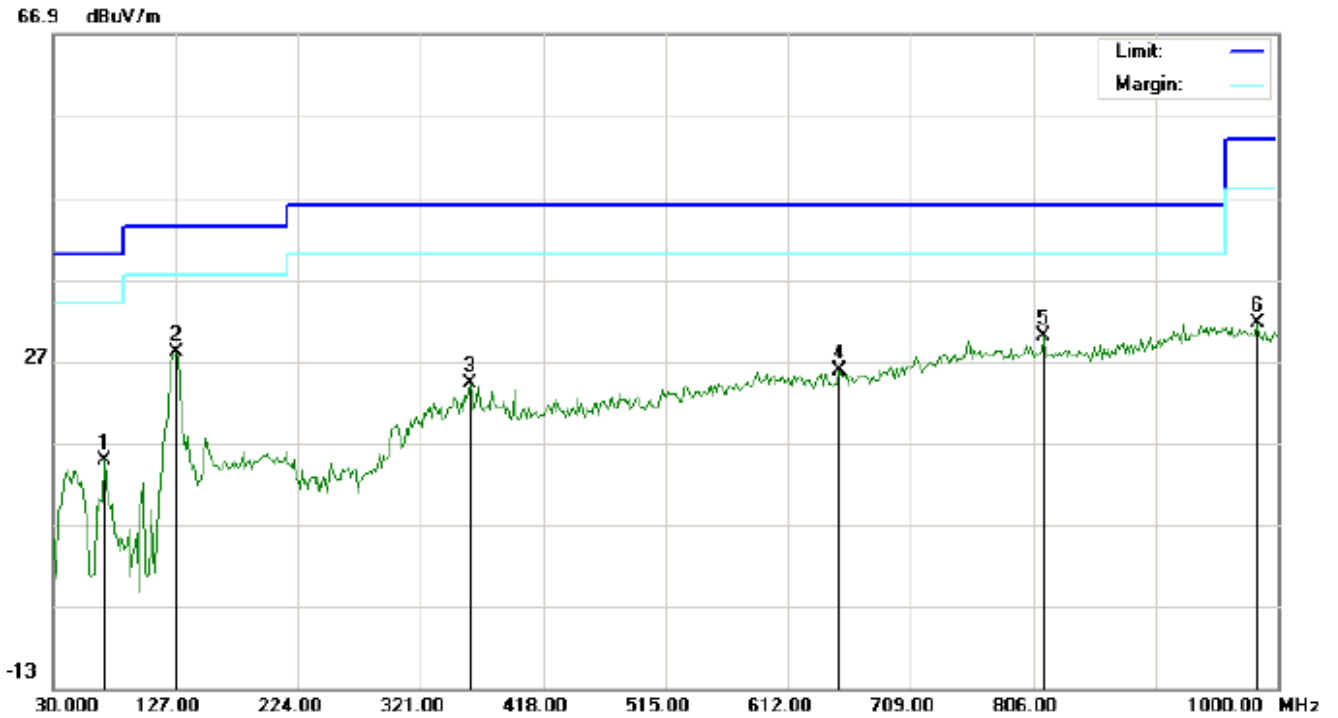

No.	Mk	Freq.	Reading	Factor	Measurement	Limit	Over	Detector	Antenna	Table	Comment
		MHz	dBuV	dB/m	dBuV/m	dBuV/m	dB		Height	Degree	
									cm	degree	
1		70.4167	5.05	9.85	14.90	40.00	-25.10	peak			
2	*	127.0000	18.91	9.13	28.04	43.50	-15.46	peak			
3		359.8000	5.31	18.80	24.11	46.00	-21.89	peak			
4		652.4166	1.96	23.92	25.88	46.00	-20.12	peak			
5		814.0833	2.77	27.32	30.09	46.00	-15.91	peak			
6		983.8333	1.86	29.68	31.54	54.00	-22.46	peak			

RESULT: PASS



RADIATED EMISSION TEST- (30MHz-1GHz)-HIGH CHANNEL -VERTICAL

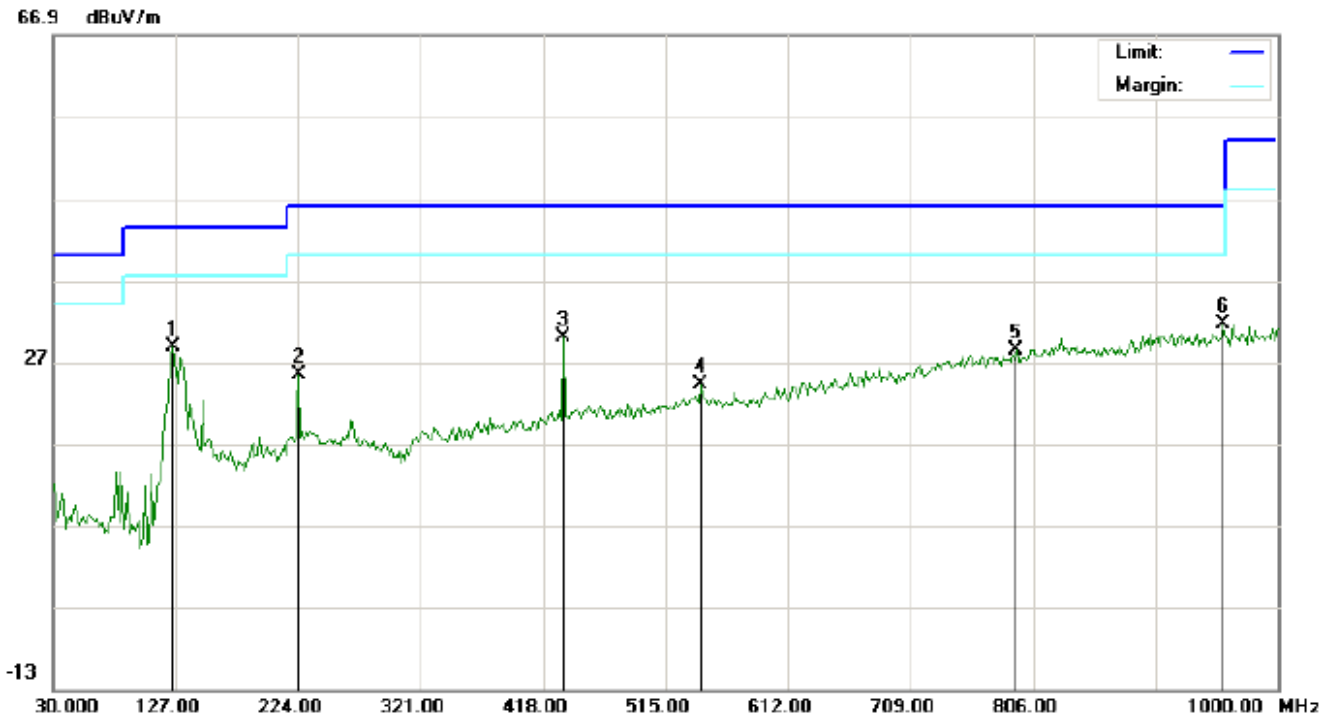

No.	Mk	Freq.	Reading	Factor	Measurement	Limit	Over	Detector	Antenna Height	Table Degree	Comment
		MHz	dBuV	dB/m	dBuV/m	dBuV/m	dB		cm	degree	
1		125.3833	19.70	9.10	28.80	43.50	-14.70	peak			
2		224.0000	14.05	11.35	25.40	46.00	-20.60	peak			
3		434.1666	9.84	20.11	29.95	46.00	-16.05	peak			
4		542.4832	1.86	22.28	24.14	46.00	-21.86	peak			
5		793.0665	1.10	27.22	28.32	46.00	-17.68	peak			
6	*	956.3500	1.60	29.94	31.54	46.00	-14.46	peak			

RESULT: PASS

Note: 1. Factor=Antenna Factor + Cable loss, Margin=Measurement-Limit.

2. The "Factor" value can be calculated automatically by software of measurement system.



RADIATED EMISSION ABOVE 1GHz

RADIATED EMISSION ABOVE 1GHz (1-10th Harmonics)-LOW CHANNEL-HORIZONTAL

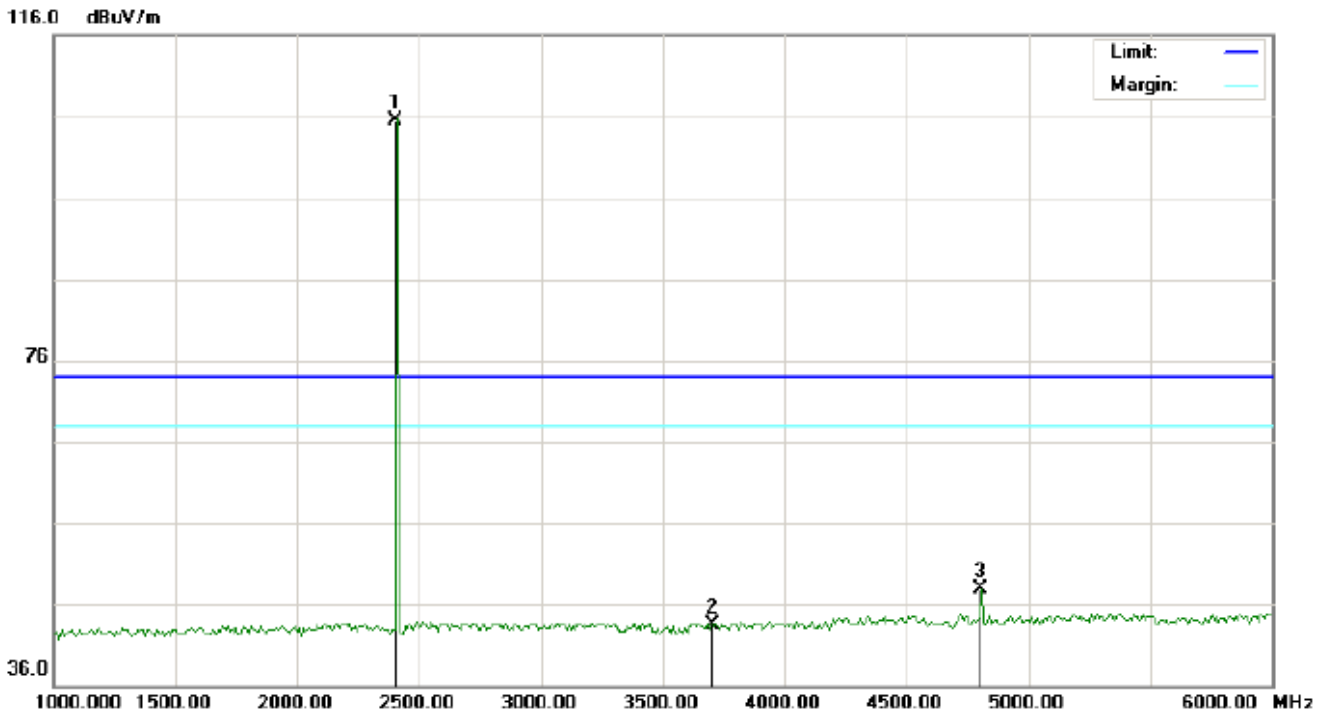

No.	Mk	Freq.	Reading	Factor	Measurement	Limit	Over	Detector	Antenna Height	Table Degree	Comment
		MHz	dBuV	dB/m	dBuV/m	dBuV/m	dB		cm	degree	
1	*	2402.000	92.03	13.46	105.49	74.00	31.49	peak			
2		3700.000	30.24	13.34	43.58	74.00	-30.42	peak			
3		4804.000	40.21	7.69	47.90	74.00	-26.10	peak			

RESULT: PASS



RADIATED EMISSION ABOVE 1GHz (1-10th Harmonics)-LOW CHANNEL –VERTICAL

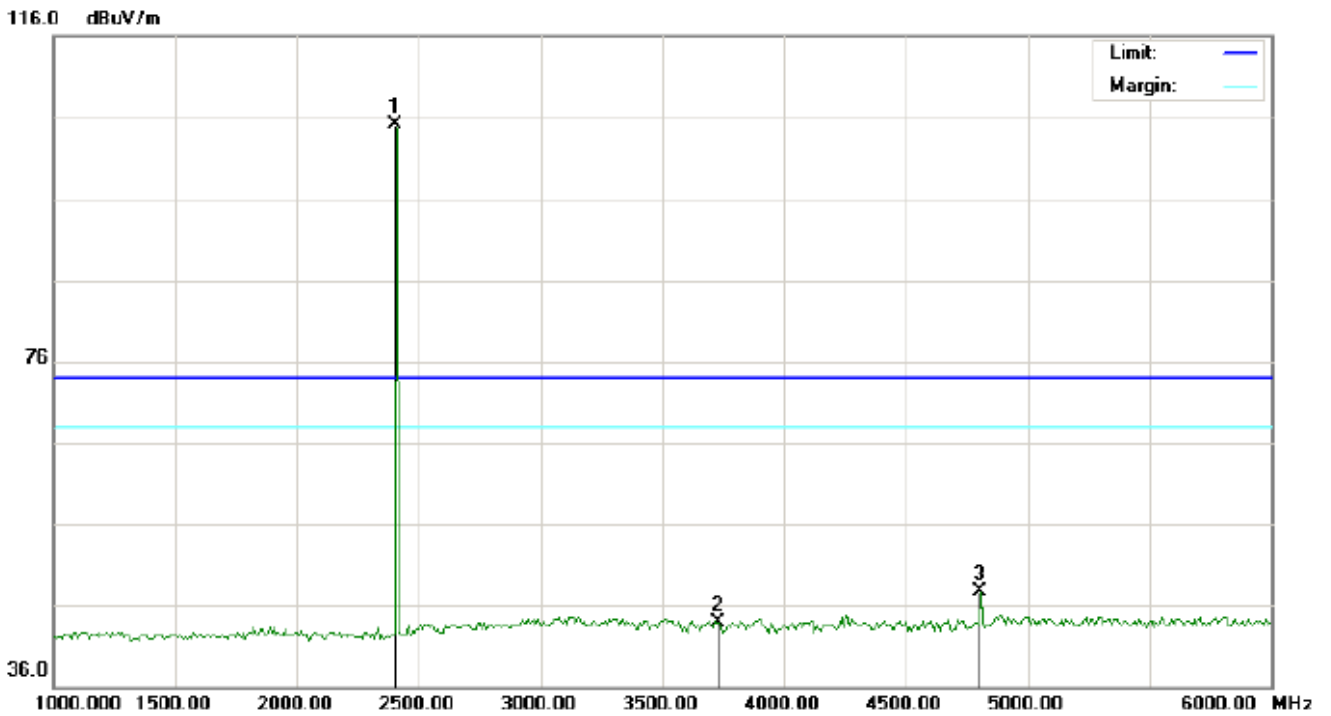

No.	Mk	Freq.	Reading	Factor	Measurement	Limit	Over	Detector	Antenna Height	Table Degree	Comment
		MHz	dBuV	dB/m	dBuV/m	dBuV/m	dB		cm	degree	
1	*	2402.000	91.55	13.46	105.01	74.00	31.01	peak			
2		3733.333	30.34	13.55	43.89	74.00	-30.11	peak			
3		4804.000	40.05	7.69	47.74	74.00	-26.26	peak			

RESULT: PASS



RADIATED EMISSION ABOVE 1GHz (1-10th Harmonics)-MIDDLE CHANNEL-HORIZONTAL

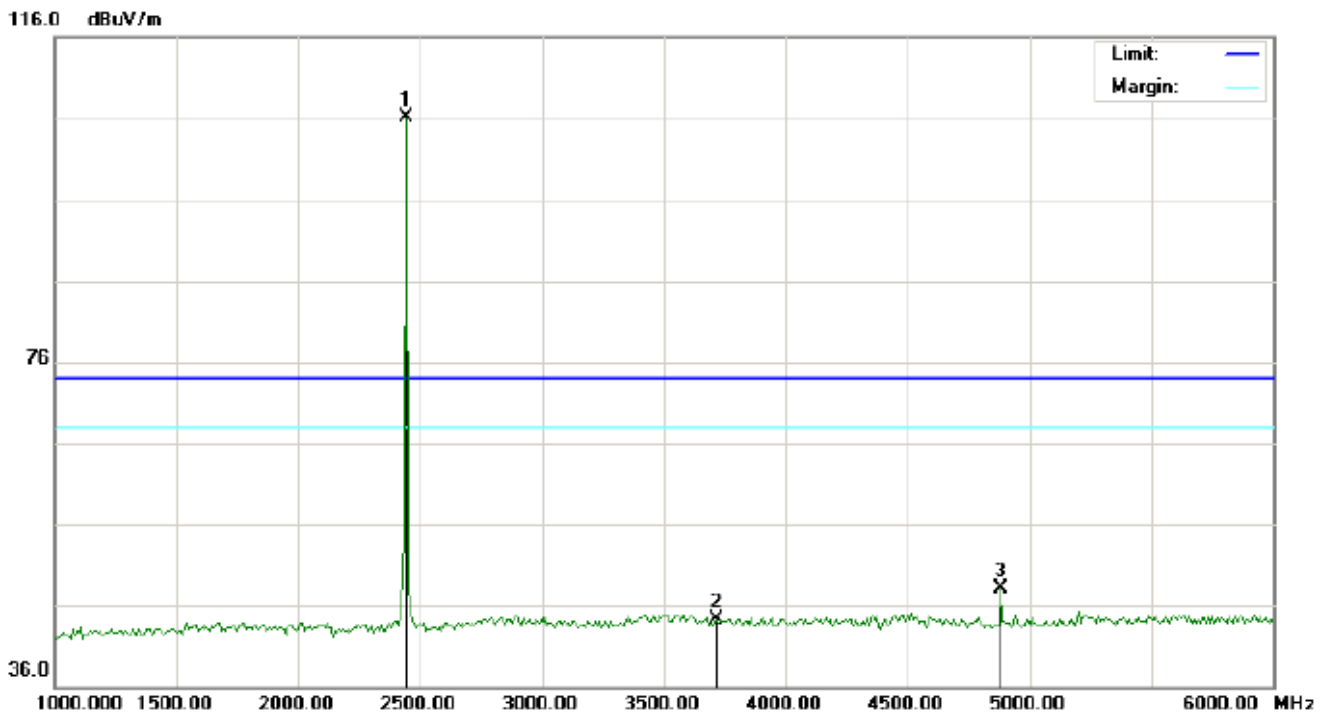

No.	Mk	Freq.	Reading	Factor	Measurement	Limit	Over	Detector	Antenna Height	Table Degree	Comment
		MHz	dBuV	dB/m	dBuV/m	dBuV/m	dB		cm	degree	
1	*	2441.000	92.18	13.88	106.06	74.00	32.06	peak			
2		3716.667	30.92	13.44	44.36	74.00	-29.64	peak			
3		4882.000	40.16	7.89	48.05	74.00	-25.95	peak			

RESULT: PASS



RADIATED EMISSION ABOVE 1GHz (1-10th Harmonics) - MIDDLE CHANNEL –VERTICAL

116.0 dBuV/m

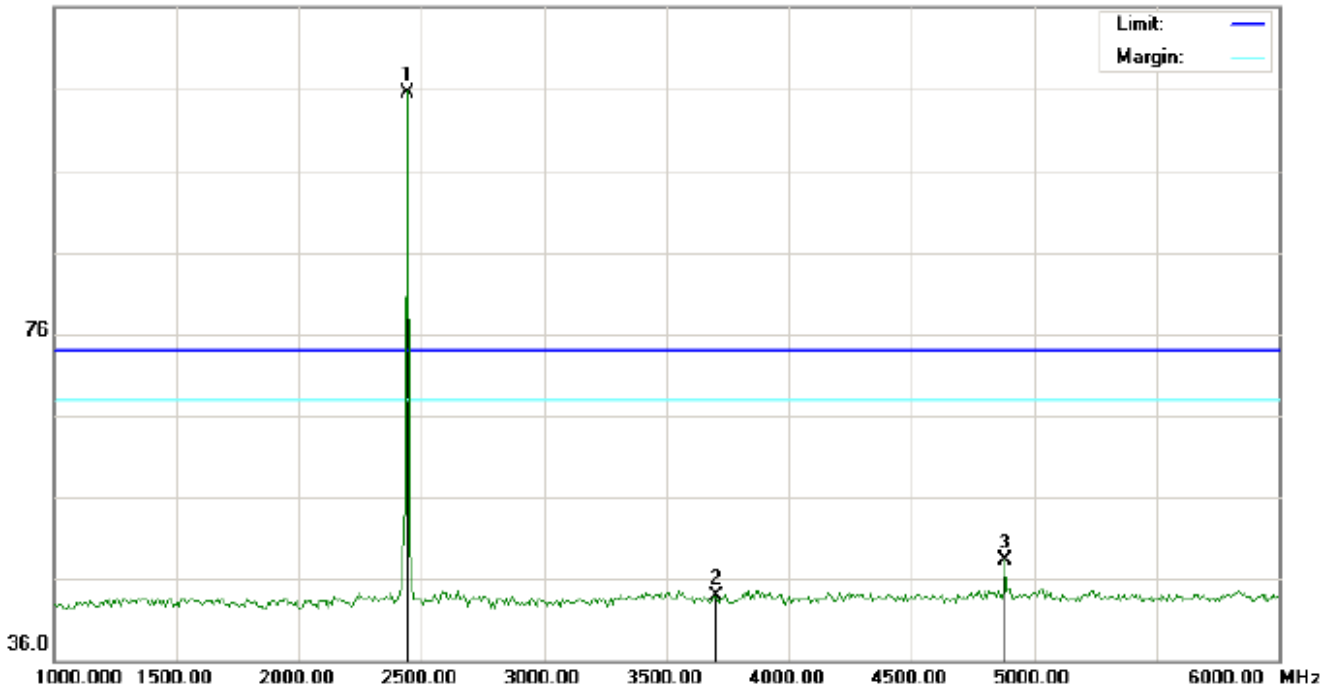

No.	Mk	Freq.	Reading	Factor	Measurement	Limit	Over	Detector	Antenna Height	Table Degree	Comment
		MHz	dBuV	dB/m	dBuV/m	dBuV/m	dB		cm	degree	
1	*	2441.000	91.69	13.88	105.57	74.00	31.57	peak			
2		3700.000	30.66	13.34	44.00	74.00	-30.00	peak			
3		4882.000	40.39	7.89	48.28	74.00	-25.72	peak			

RESULT: PASS



RADIATED EMISSION ABOVE 1GHz (1-10th Harmonics)-HIGH CHANNEL-HORIZONTAL

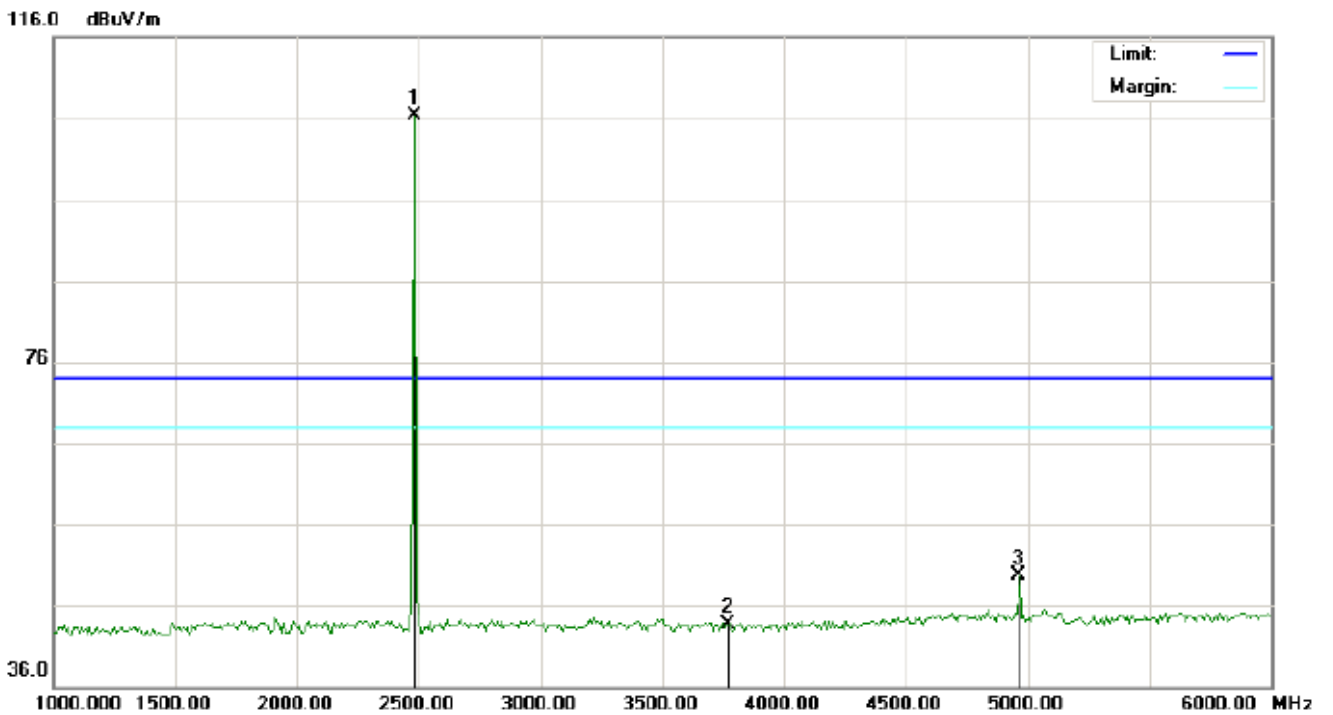

No.	Mk	Freq.	Reading	Factor	Measurement	Limit	Over	Detector	Antenna Height	Table Degree	Comment
		MHz	dBuV	dB/m	dBuV/m	dBuV/m	dB		cm	degree	
1	*	2480.000	92.24	14.11	106.35	74.00	32.35	peak			
2		3766.667	29.94	13.75	43.69	74.00	-30.31	peak			
3		4960.000	41.60	8.09	49.69	74.00	-24.31	peak			

RESULT: PASS



RADIATED EMISSION ABOVE 1GHz (1-10th Harmonics)-HIGH CHANNEL –VERTICAL

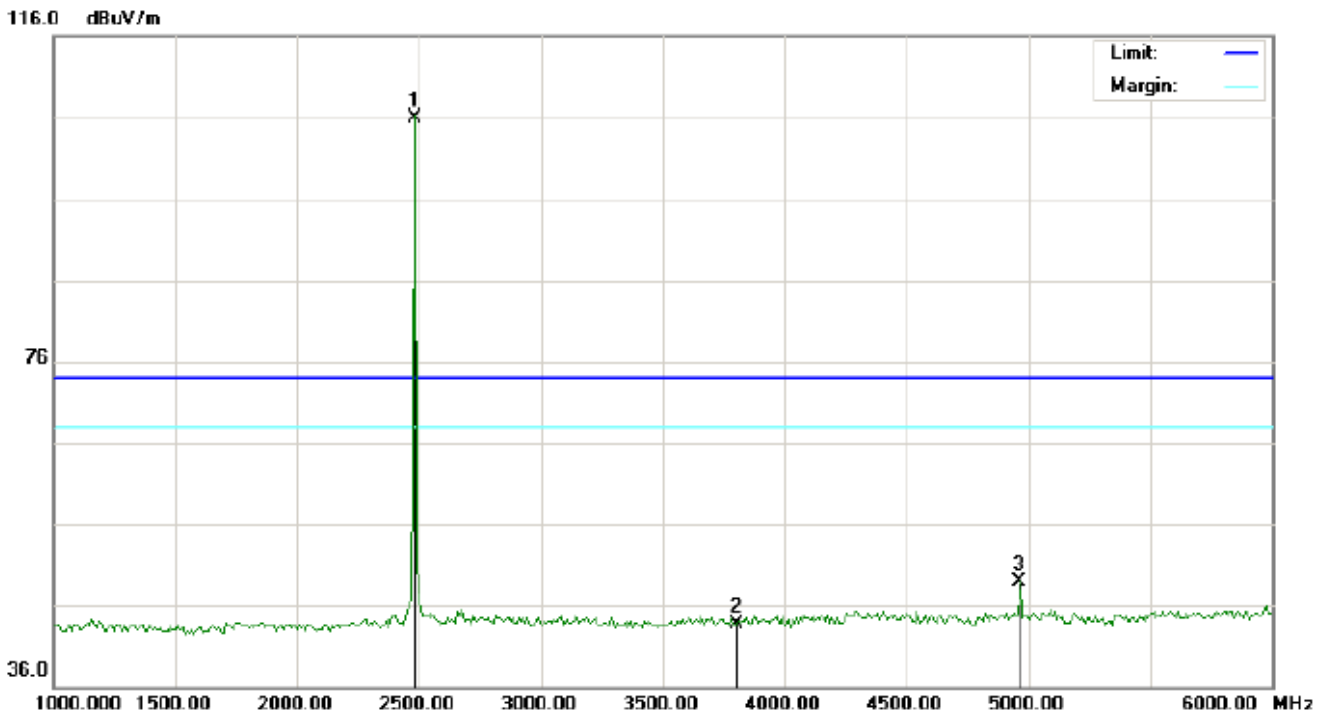

No.	Mk	Freq.	Reading	Factor	Measurement	Limit	Over	Detector	Antenna	Table	Comment
		MHz	dBuV	dB/m	dBuV/m	dBuV/m	dB		Height	Degree	
									cm	degree	
1	*	2480.000	91.76	14.11	105.87	74.00	31.87	peak			
2		3800.000	29.81	13.96	43.77	74.00	-30.23	peak			
3		4960.000	40.91	8.09	49.00	74.00	-25.00	peak			

RESULT: PASS

Note: 6~25GHz at least have 20dB margin. No recording in the test report.

Factor=Antenna Factor+ Cable loss-Amplifier gain, Margin=Measurement-Limit.

The “Factor” value can be calculated automatically by software of measurement system.

7. BAND EDGE EMISSION

7.1. MEASUREMENT PROCEDURE

1. Set the EUT Work on the top, the bottom operation frequency individually.
2. Set SPA Start or Stop Frequency=Operation Frequency,
For unrestricted band: RBW=100kHz, VBW=300kHz
For restricted band: RBW=1MHz, VBW=3*RBW
Center frequency =Operation frequency
3. The band edges was measured and recorded.

7.2. TEST SET-UP

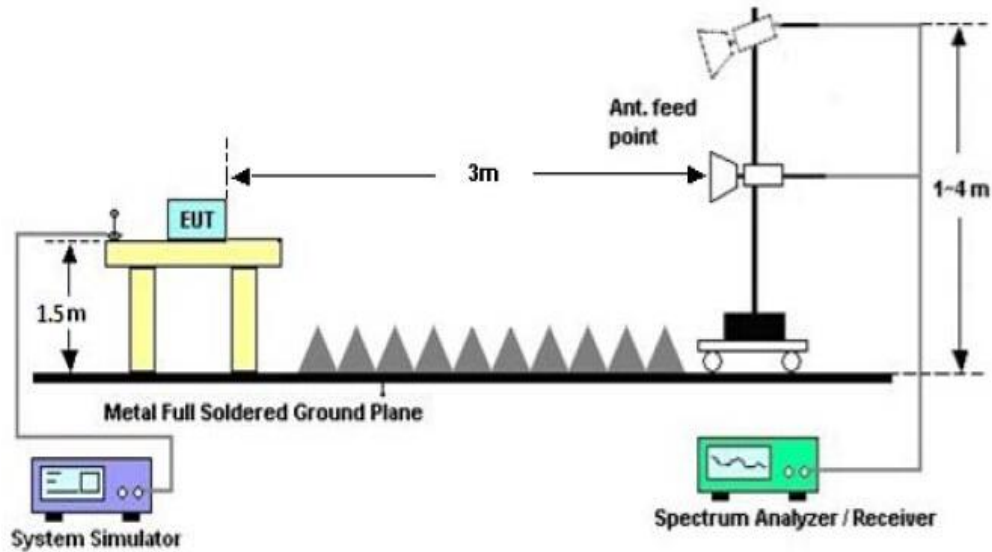



7.3. TEST RESULT

(Worst Modulation: GFSK)

TEST PLOT OF BAND EDGE FOR LOW CHANNEL (1Mbps)-Horizontal

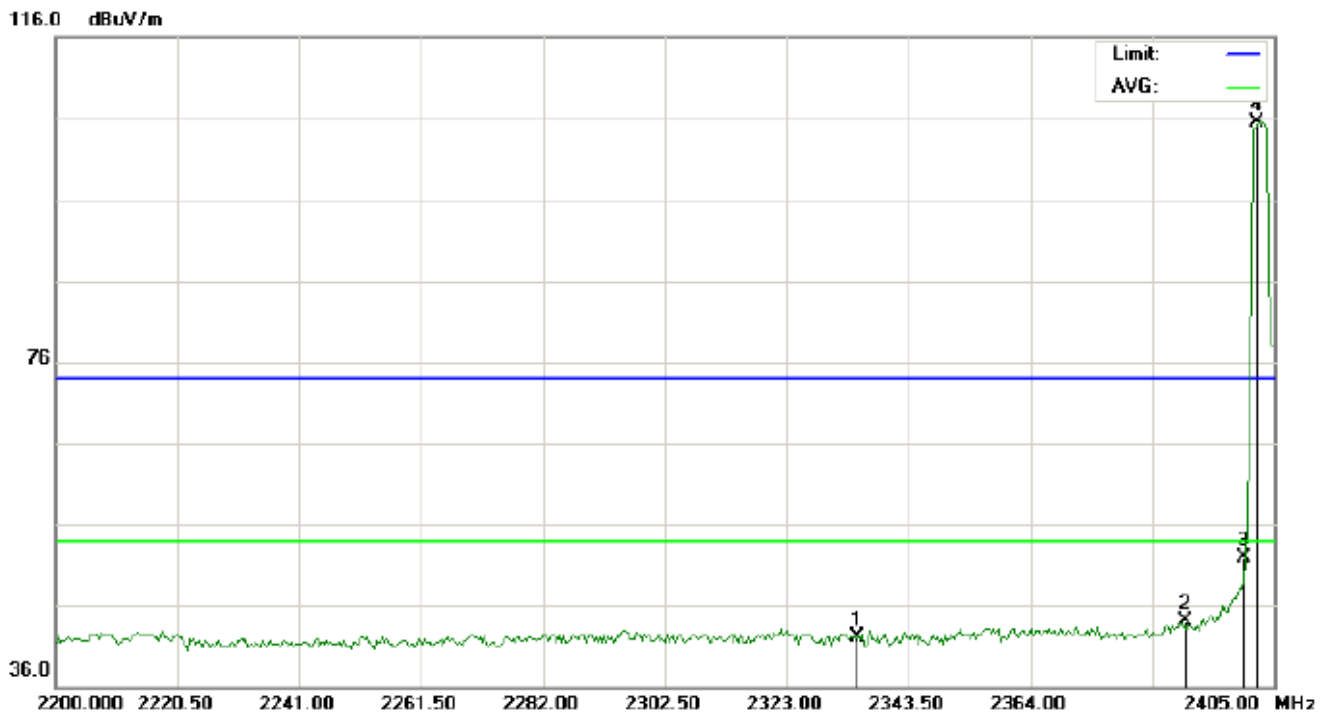

No.	Mk	Freq.	Reading	Factor	Measurement	Limit	Over	Detector	Antenna	Table	Comment
		MHz	dBuV	dB/m	dBuV/m	dBuV/m	dB		Height	Degree	
									cm	degree	
1		2334.958	28.60	13.42	42.02	74.00	-31.98	peak			
2		2390.000	30.68	13.45	44.13	74.00	-29.87	peak			
3		2400.000	38.44	13.46	51.90	74.00	-22.10	peak			
4	*	2402.000	92.04	13.46	105.55	74.00	31.50	peak			



TEST PLOT OF BAND EDGE FOR LOW CHANNEL (1Mbps)-Vertical

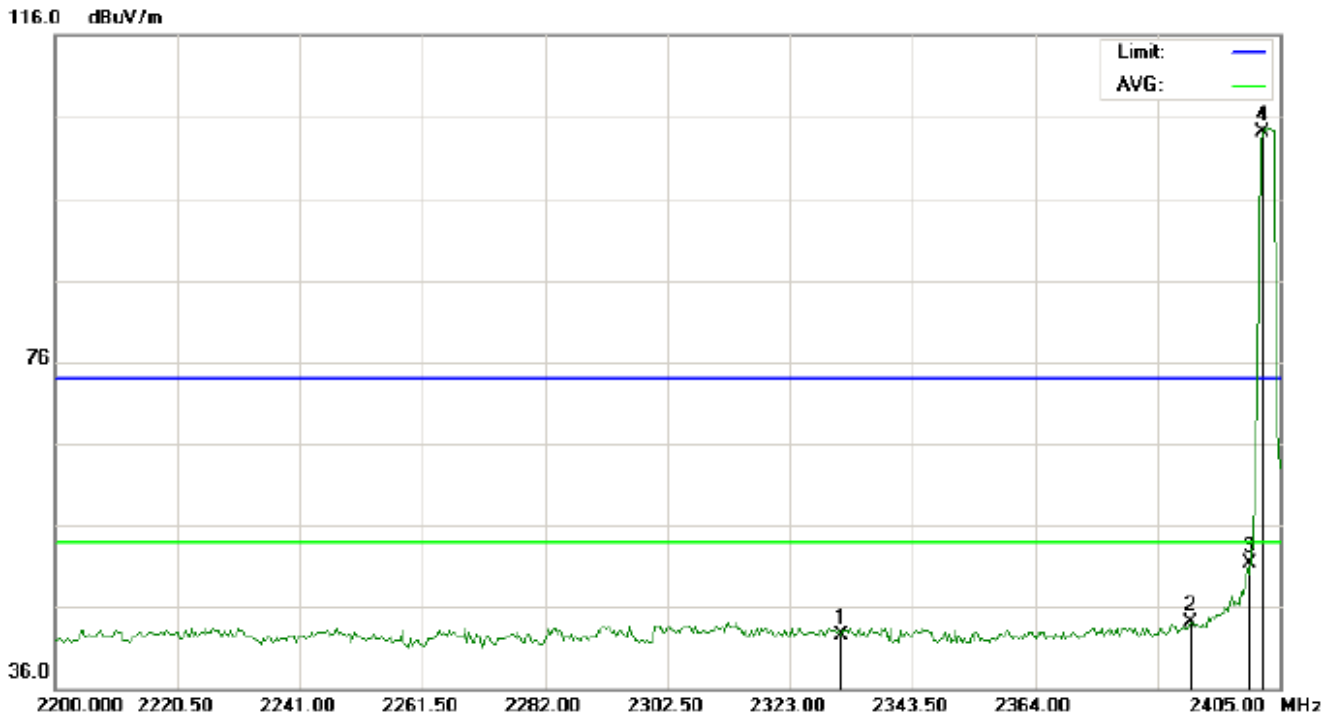

No.	Mk	Freq.	Reading	Factor	Measurement	Limit	Over	Detector	Antenna	Table	Comment
		MHz	dBuV	dB/m	dBuV/m	dBuV/m	dB		Height	Degree	
									cm	degree	
1		2331.542	29.03	13.42	42.45	74.00	-31.55	peak			
2		2390.000	30.68	13.45	44.13	74.00	-29.87	peak			
3		2400.000	37.94	13.46	51.40	74.00	-22.60	peak			
4	*	2402.000	90.61	13.46	104.07	74.00	30.07	peak			



TEST PLOT OF BAND EDGE FOR HIGH CHANNEL (1Mbps)-Horizontal

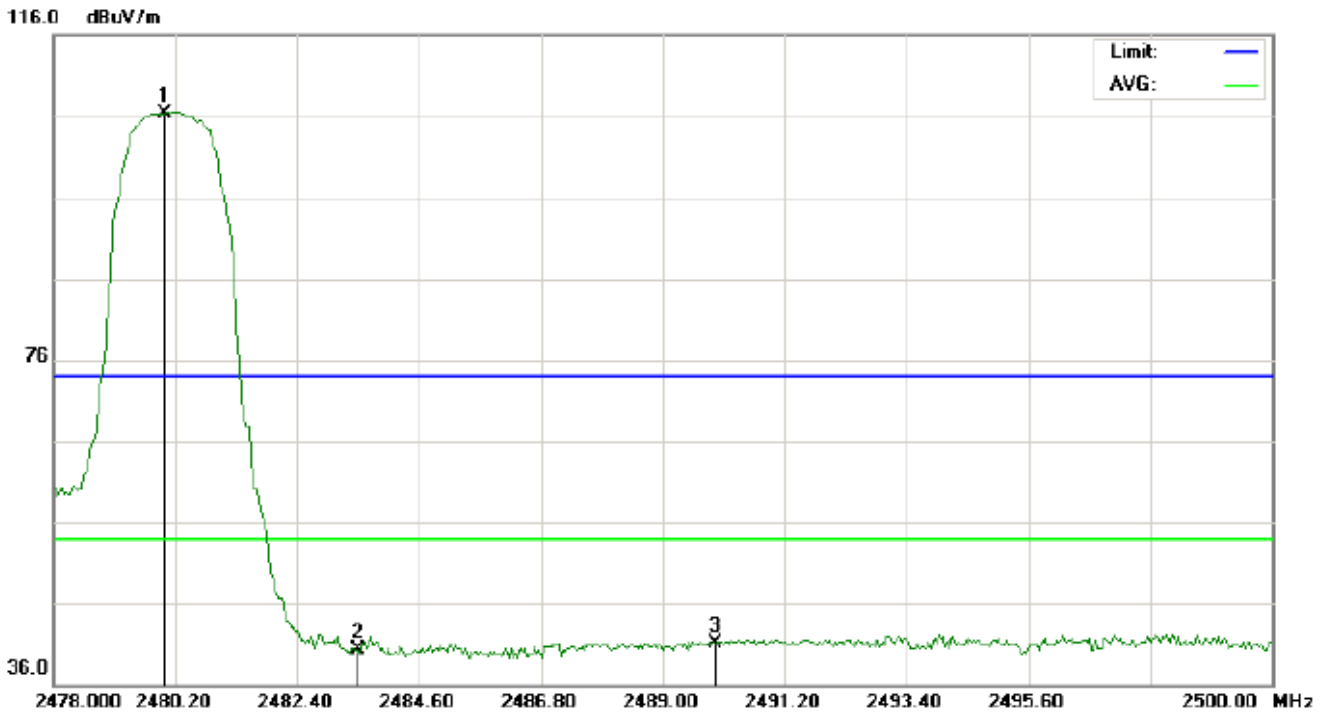

No.	Mk	Freq.	Reading	Factor	Measurement	Limit	Over	Detector	Antenna	Table	Comment
		MHz	dBuV	dB/m	dBuV/m	dBuV/m	dB		Height	Degree	
1	*	2480.000	92.19	14.11	106.30	74.00	32.30	peak			
2		2483.500	26.16	14.13	40.29	74.00	-33.71	peak			
3		2489.953	26.88	14.17	41.05	74.00	-32.95	peak			



TEST PLOT OF BAND EDGE FOR HIGH CHANNEL (1Mbps)-Vertical

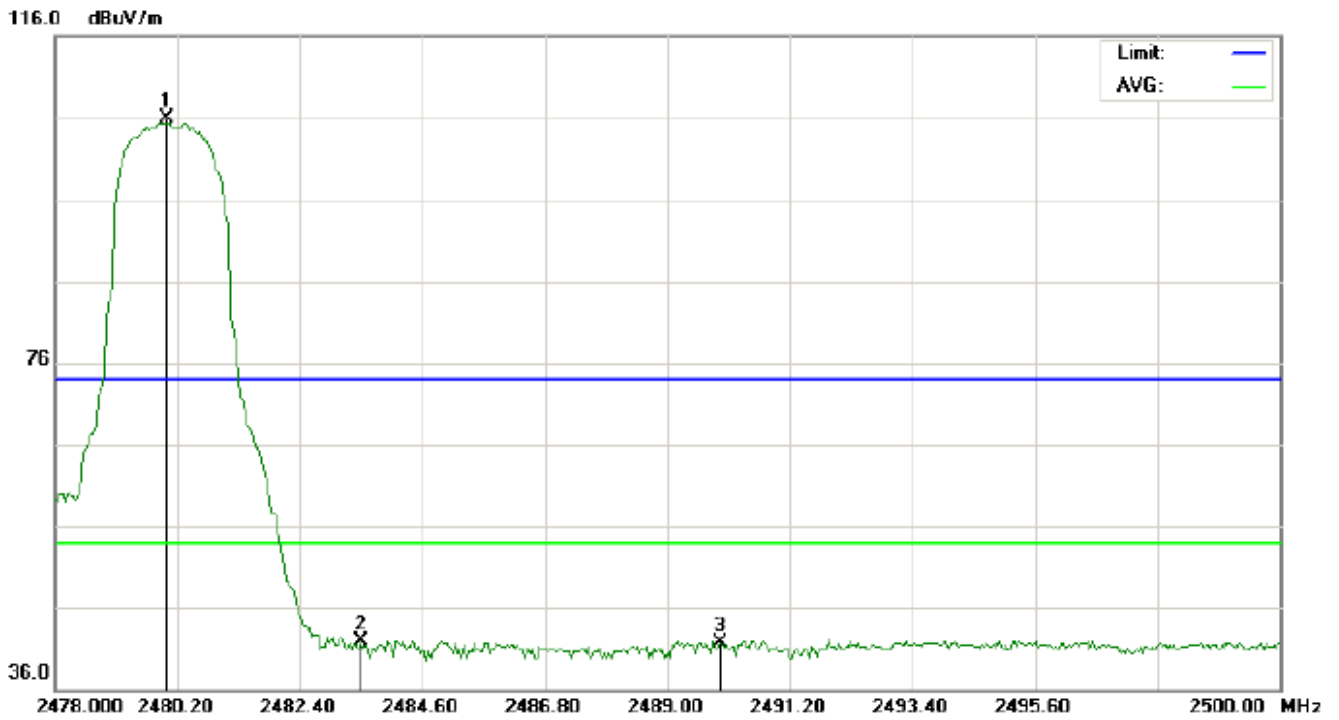

No.	Mk	Freq.	Reading	Factor	Measurement	Limit	Over	Detector	Antenna	Table	Comment
		MHz	dBuV	dB/m	dBuV/m	dBuV/m	dB		Height	Degree	
									cm	degree	
1	*	2480.000	91.70	14.11	105.81	74.00	31.81	peak			
2		2483.500	27.72	14.13	41.85	74.00	-32.15	peak			
3		2489.953	27.47	14.17	41.64	74.00	-32.36	peak			

RESULT: PASS

Note: 1. Factor=Antenna Factor + Cable loss, Margin=Measurement-Limit.

2. The "Factor" value can be calculated automatically by software of measurement system.
3. Hopping off and Hopping on have been tested and only worst case recorded

8. NUMBER OF HOPPING FREQUENCY

8.1. MEASUREMENT PROCEDURE

1. Place the EUT on the table and set it in transmitting mode.
2. Remove the antenna from the EUT and then connect a low RF cable from the antenna port to the spectrum analyzer.
3. Set the spectrum analyzer Start = 2.4GHz Stop = 2.4835GHz
4. Set the Spectrum Analyzer as RBW \geq 1%span, VBW \geq 3RBW.

8.2. TEST SETUP (BLOCK DIAGRAM OF CONFIGURATION)

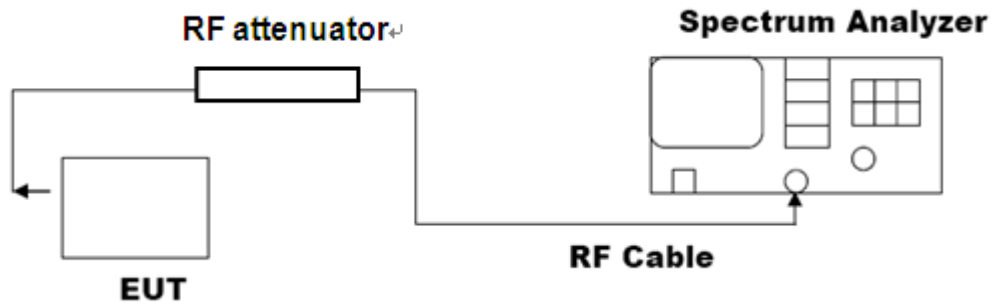

8.3. LIMITS AND MEASUREMENT RESULT

TOTAL NO. OF HOPPING CHANNEL	LIMIT (NO. OF CH)	MEASUREMENT (NO. OF CH)	RESULT
	≥ 15	79	PASS



TEST PLOT FOR NO. OF TOTAL CHANNELS

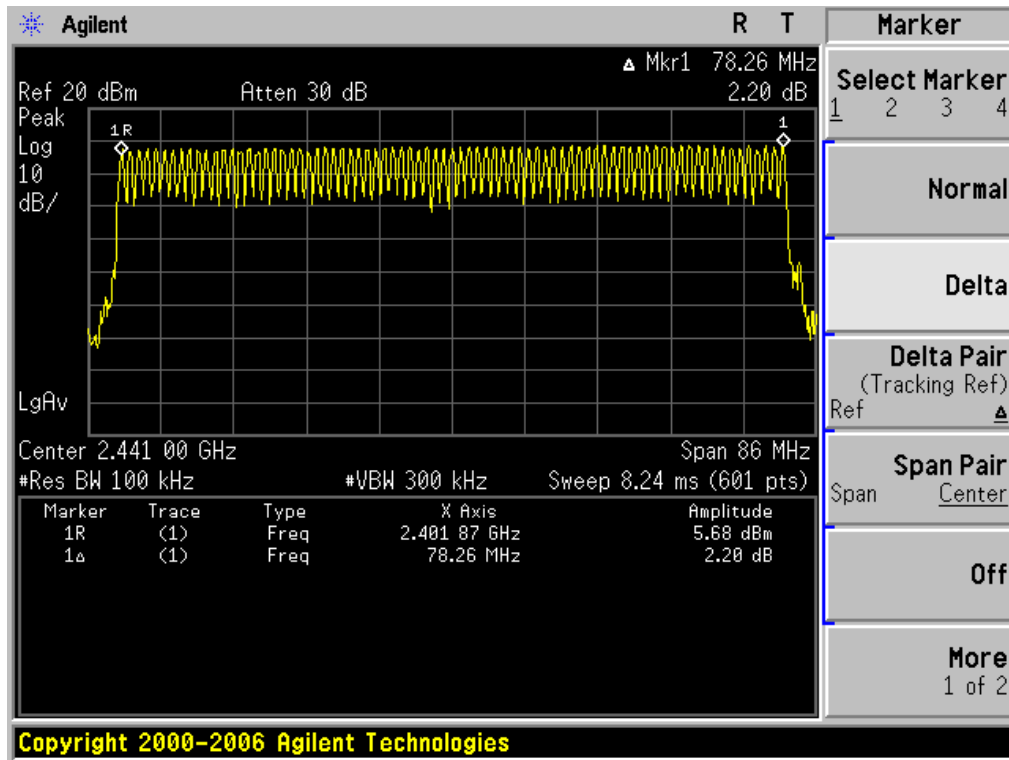

9. TIME OF OCCUPANCY (DWELL TIME)

9.1. MEASUREMENT PROCEDURE

1. Place the EUT on the table and set it in transmitting mode
2. Remove the antenna from the EUT and then connect a low RF cable from the antenna port to the spectrum analyzer.
3. Set Span = zero span, centered on a hopping channel
4. Set the spectrum analyzer as RBW=1MHz, VBW>=RBW, Span = 0 Hz

9.2. TEST SETUP (BLOCK DIAGRAM OF CONFIGURATION)

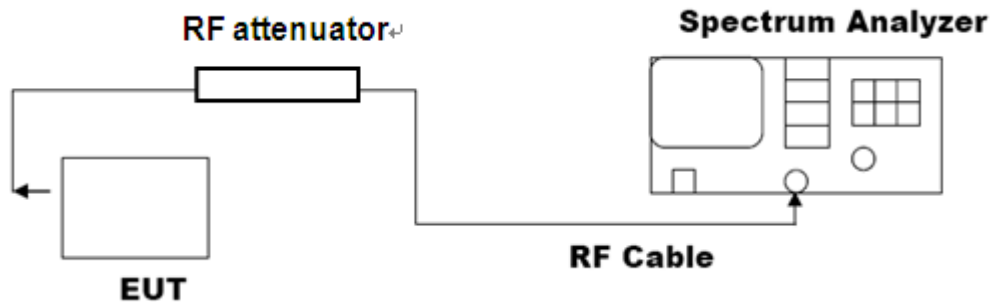

9.3. LIMITS AND MEASUREMENT RESULT

The Worst Case (3Mbps)

Channel	Time of Pulse for DH5 (ms)	Period Time (s)	Sweep Time (ms)	Limit (ms)
Low	2.926	31.6	312.11	400
Middle	2.912	31.6	310.61	400
High	2.926	31.6	312.11	400

Low Channel Time

$$2.926 * (1600/6) / 79 * 31.6 = 312.11 \text{ms}$$

Middle Channel Time

$$2.912 * (1600/6) / 79 * 31.6 = 310.61 \text{ms}$$

High Channel Time

$$2.926 * (1600/6) / 79 * 31.6 = 312.11 \text{ms}$$



TEST PLOT OF LOW CHANNEL

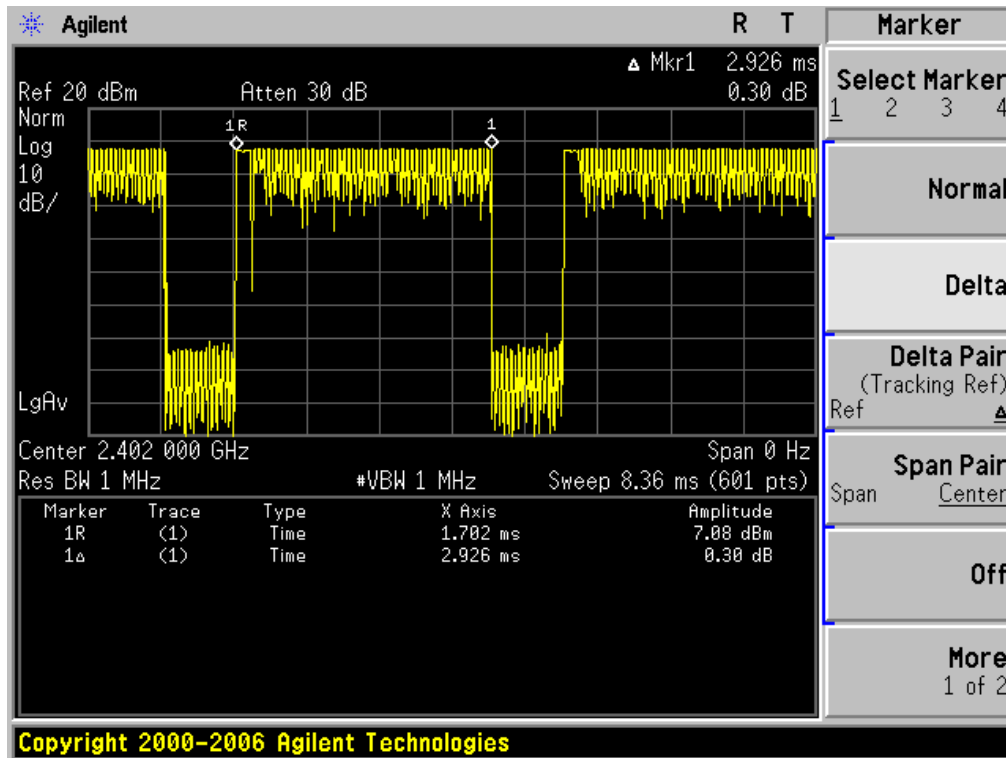

TEST PLOT OF MIDDLE CHANNEL

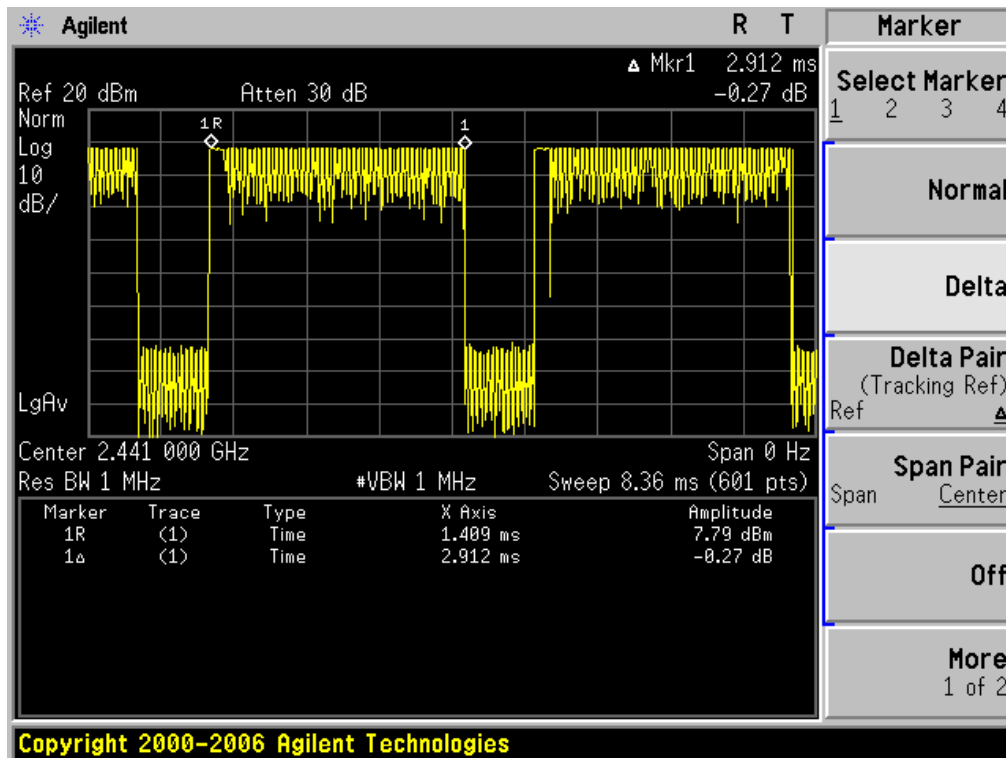



TEST PLOT OF HIGH CHANNEL

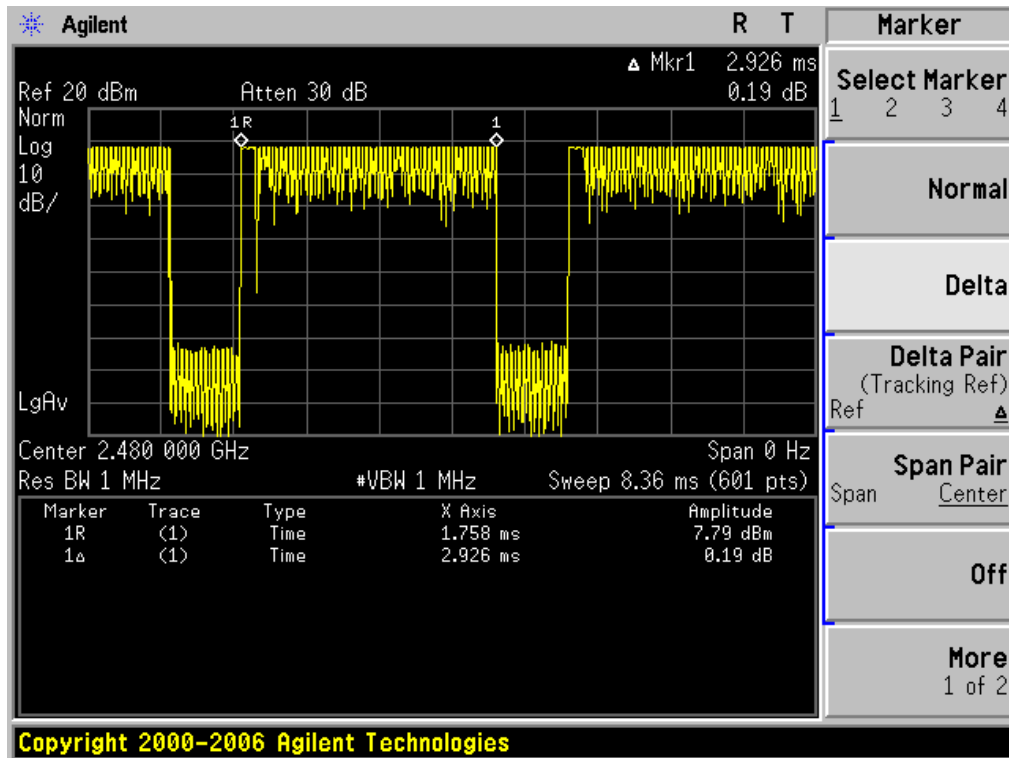

10. FREQUENCY SEPARATION

10.1. MEASUREMENT PROCEDURE

1. Place the EUT on the table and set it in transmitting mode
2. Remove the antenna from the EUT and then connect a low RF cable from the antenna port to the spectrum analyzer
3. Set Span = wide enough to capture the peaks of two adjacent channels Resolution (or IF) Bandwidth (RBW) \geq 1% of the span Video (or Average) Bandwidth (VBW) \geq RBW; Sweep = auto; Detector function = peak; Trace = max hold

10.2. TEST SETUP (BLOCK DIAGRAM OF CONFIGURATION)

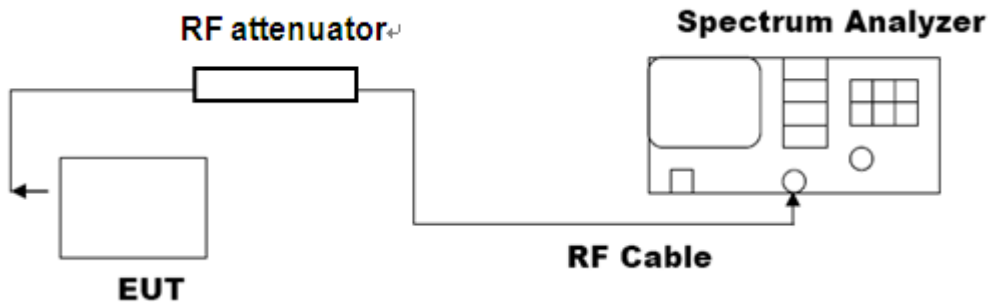

10.3. LIMITS AND MEASUREMENT RESULT

CHANNEL	CHANNEL SEPARATION	LIMIT	RESULT
	KHz	KHz	
CH00-CH01	1000	≥ 25 KHz or 2/3 20 dB BW	Pass



TEST PLOT FOR FREQUENCY SEPARATION (3Mbps)

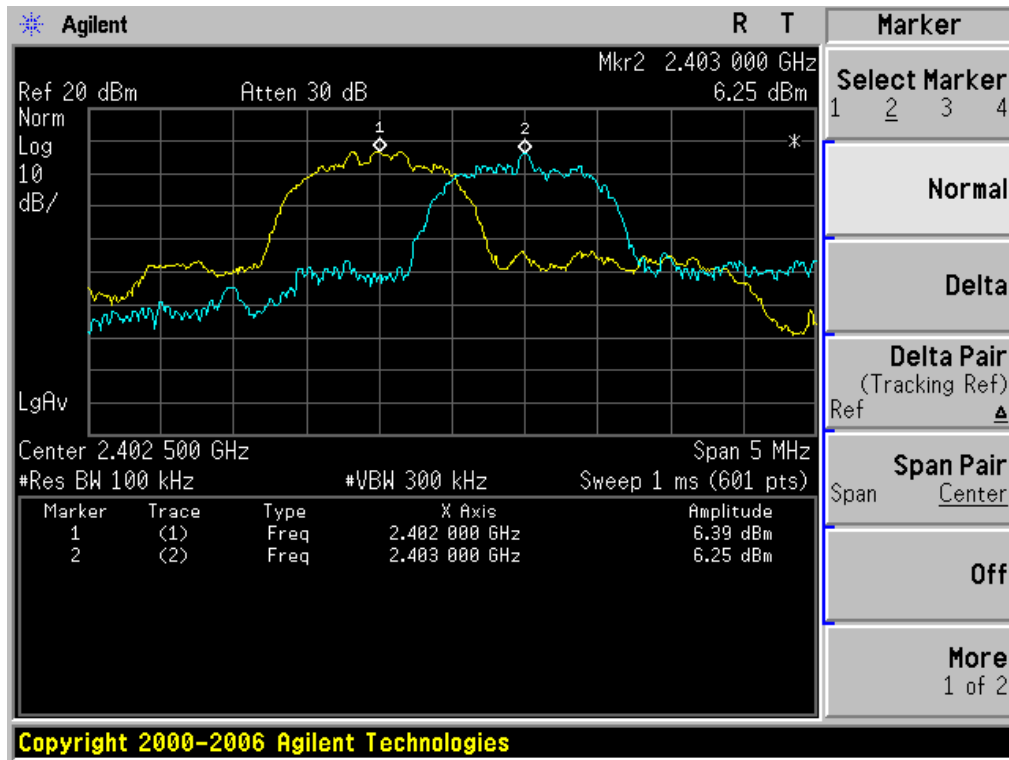

11. LINE CONDUCTED EMISSION TEST

11.1. LIMITS OF LINE CONDUCTED EMISSION TEST

Frequency	Maximum RF Line Voltage	
	Q.P.(dBuV)	Average(dBuV)
150kHz~500kHz	66-56	56-46
500kHz~5MHz	56	46
5MHz~30MHz	60	50

Note:

1. The lower limit shall apply at the transition frequency.
2. The limit decreases linearly with the logarithm of the frequency in the range 0.15 MHz to 0.50 MHz.

11.2. BLOCK DIAGRAM OF LINE CONDUCTED EMISSION TEST

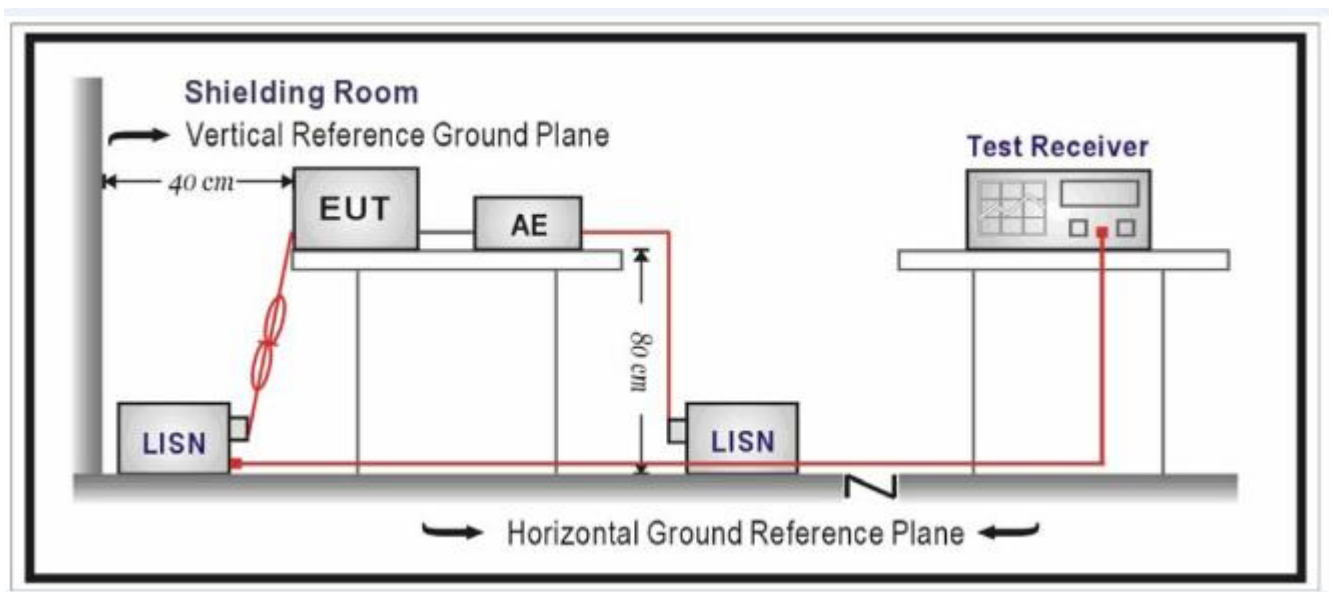



11.3. PRELIMINARY PROCEDURE OF LINE CONDUCTED EMISSION TEST

1. The equipment was set up as per the test configuration to simulate typical actual usage per the user's manual. When the EUT is a tabletop system, a wooden table with a height of 0.8 meters is used and is placed on the ground plane as per ANSI C63.10 (see Test Facility for the dimensions of the ground plane used). When the EUT is a floor-standing equipment, it is placed on the ground plane which has a 3-12 mm non-conductive covering to insulate the EUT from the ground plane.
2. Support equipment, if needed, was placed as per ANSI C63.10.
3. All I/O cables were positioned to simulate typical actual usage as per ANSI C63.10.
4. All support equipments received AC120V/60Hz power from a LISN, if any.
5. The EUT received DC charging voltage by adapter which received 120V/60Hz power by a LISN.
6. The test program was started. Emissions were measured on each current carrying line of the EUT using a spectrum Analyzer / Receiver connected to the LISN powering the EUT. The LISN has two monitoring points: Line 1 (Hot Side) and Line 2 (Neutral Side). Two scans were taken: one with Line 1 connected to Analyzer / Receiver and Line 2 connected to a 50 ohm load; the second scan had Line 1 connected to a 50 ohm load and Line 2 connected to the Analyzer / Receiver.
7. Analyzer / Receiver scanned from 150 kHz to 30MHz for emissions in each of the test modes.
8. During the above scans, the emissions were maximized by cable manipulation.
9. The test mode(s) were scanned during the preliminary test.

Then, the EUT configuration and cable configuration of the above highest emission level were recorded for reference of final testing.

11.4. FINAL PROCEDURE OF LINE CONDUCTED EMISSION TEST

1. EUT and support equipment was set up on the test bench as per step 2 of the preliminary test.
2. A scan was taken on both power lines, Line 1 and Line 2, recording at least the six highest emissions. Emission frequency and amplitude were recorded into a computer in which correction factors were used to calculate the emission level and compare reading to the applicable limit. If EUT emission level was less -2dB to the A.V. limit in Peak mode, then the emission signal was re-checked using Q.P and Average detector.
3. The test data of the worst case condition(s) was reported on the Summary Data page.

11.5. TEST RESULT OF LINE CONDUCTED EMISSION TEST

N/A

Note: The BT function of EUT didn't work when charging.

12. ANTENNA REQUIREMENT

Standard Applicable

For intentional device, according to FCC 47 CFR Section 15.203, an intentional radiator shall be designed to ensure that no antenna other than that furnished by the responsible party shall be used with the device. And according to FCC 47 CFR Section 15.249, if transmitting antennas of directional gain greater than 6dBi are used, the power shall be reduced by the amount in dB that the directional gain of the antenna exceeds 6dBi.

Refer to statement below for compliance.

The manufacturer may design the unit so that the user can replace a broken antenna, but the use of a standard antenna jack or electrical connector is prohibited. Further, this requirement does not apply to intentional radiators that must be professionally installed.

ANTENNA

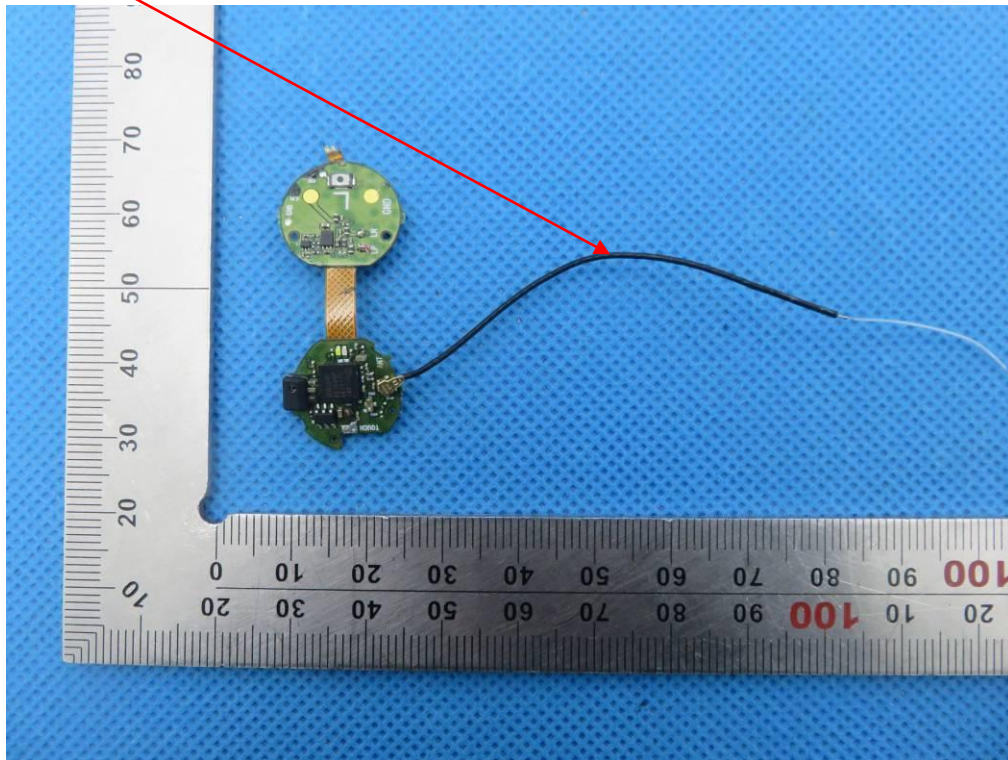

13. PHOTOGRAPH OF TEST

FCC RADIATED EMISSION TEST SETUP

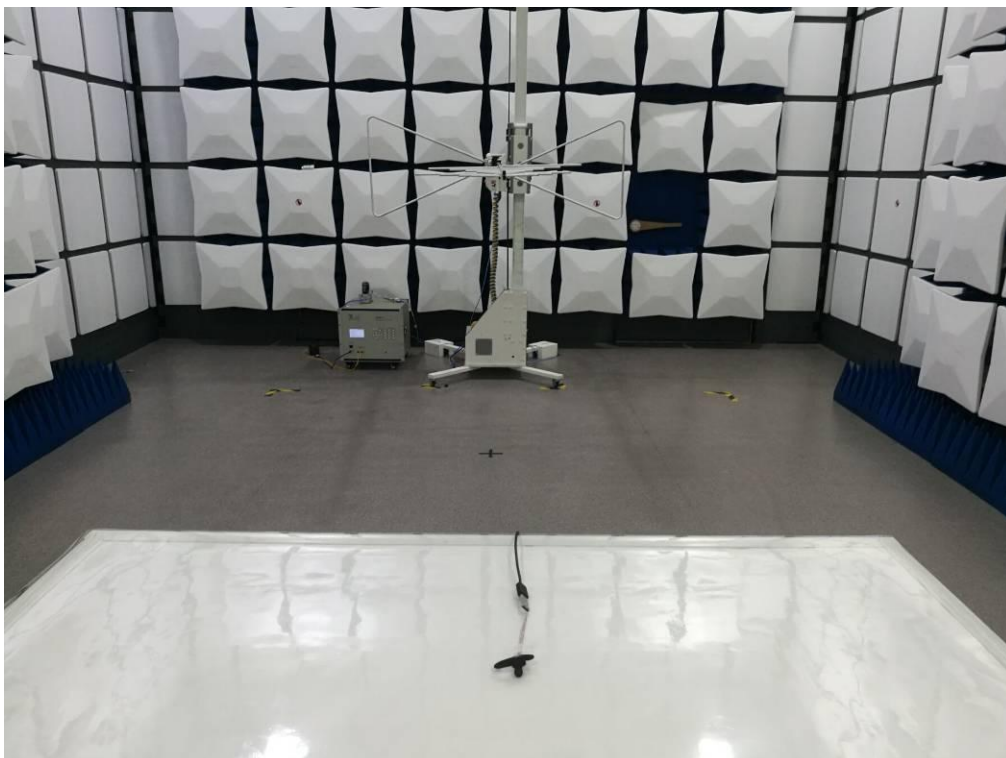



14. PHOTOGRAPHS OF EUT

TOTAL VIEW OF EUT



TOP VIEW OF EUT



BOTTOM VIEW OF EUT



FRONT VIEW OF EUT



BACK VIEW OF EUT



LEFT VIEW OF EUT



RIGHT VIEW OF EUT



VIEW OF EUT (PORT)



OPEN VIEW OF EUT



VIEW OF BATTERY



INTERNAL VIEW OF EUT-1

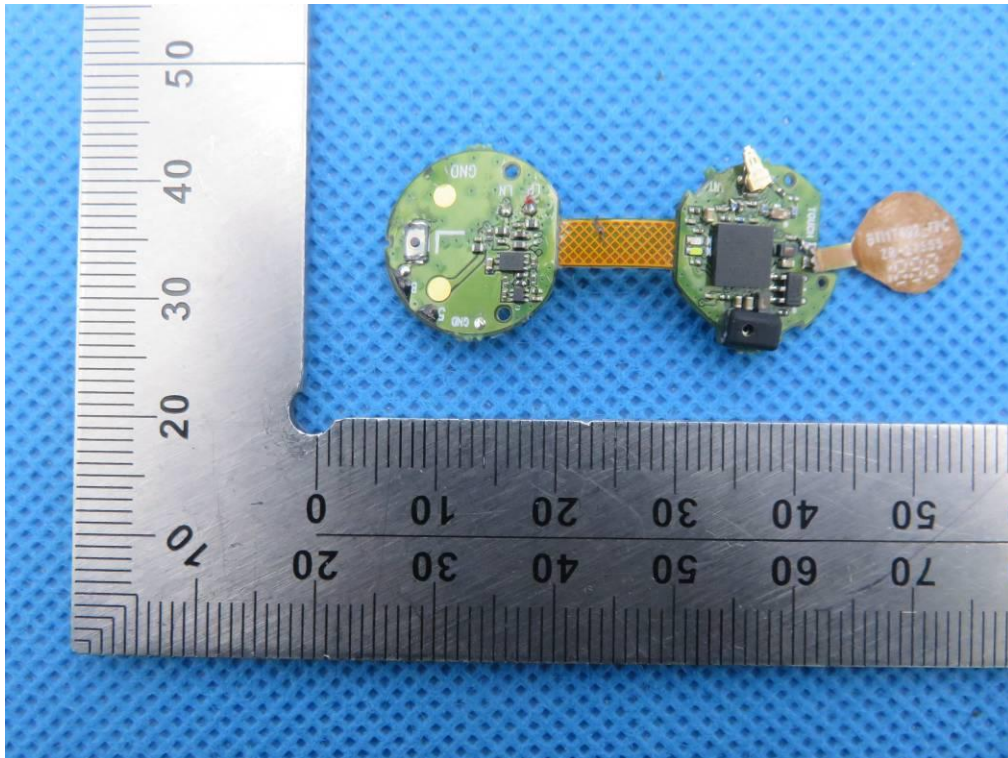

INTERNAL VIEW OF EUT-2

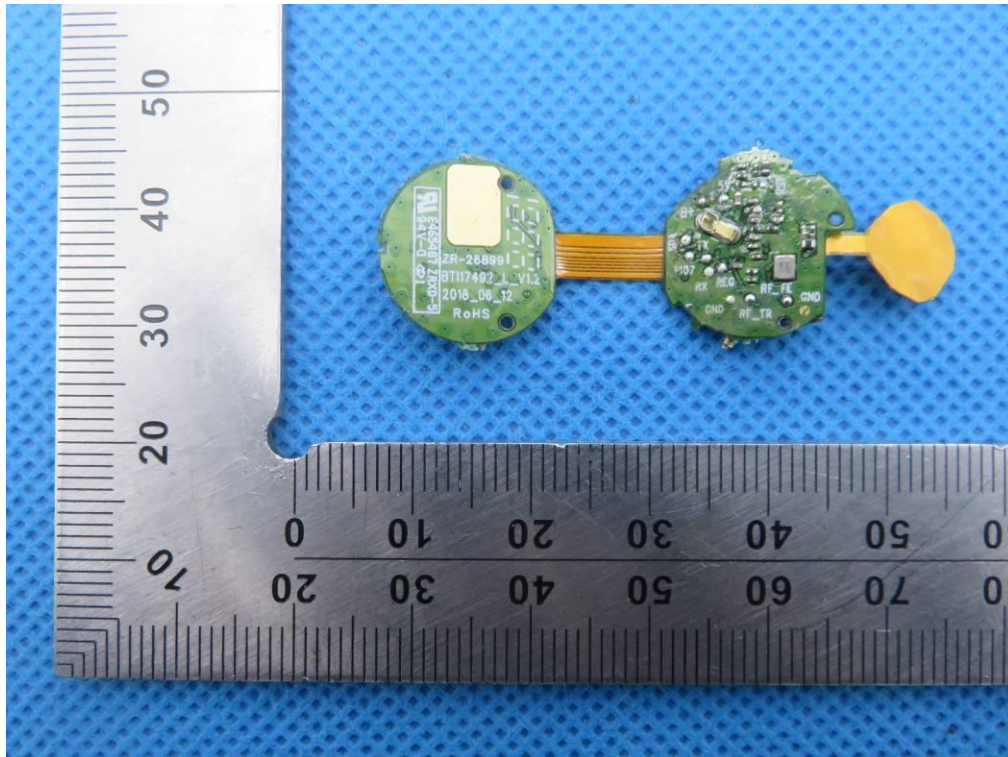

INTERNAL VIEW OF EUT-3

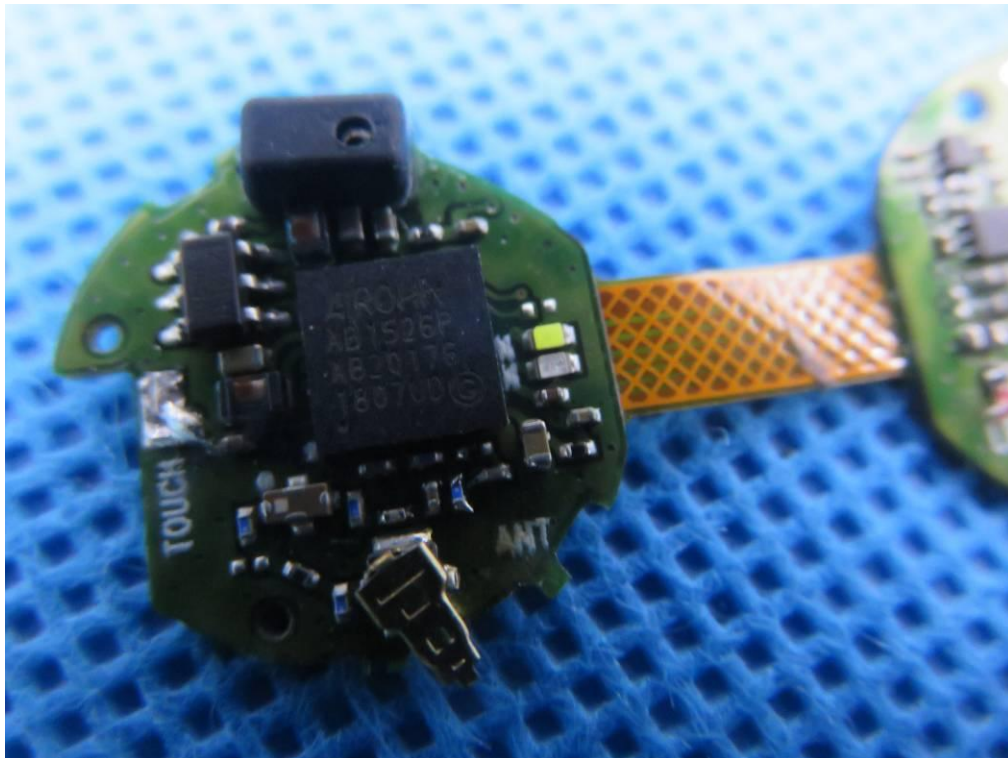



CHARGING BASE
VIEW OF EUT (PORT)-1



VIEW OF EUT (PORT)-2



---END OF REPORT---