



TEST REPORT

FCC PART 15 SUBPART C 15.247

**Test report
On Behalf of
PEAG, LLC dba JLab Audio
For
Wearing Bluetooth Headset**

Model No.: JBuds Band

FCC ID: 2AHYVBAND

Prepared for : PEAG, LLC dba JLab Audio
2281 Las Palmas Drive, Suite 101, Carlsbad, CA 92011, United States

Prepared By : Shenzhen HUAKE Testing Technology Co., Ltd.
1F, B2 Building, Junfeng Zhongcheng Zhizao Innovation Park, Fuhai Street,
Bao'an District, Shenzhen City, China

Date of Test: Oct. 30, 2018 ~ Nov. 06, 2018

Date of Report: Nov. 06, 2018

Report Number: HK1811061459E



TEST RESULT CERTIFICATION

Applicant's name..... PEAG, LLC dba JLab Audio

Address 2281 Las Palmas Drive, Suite 101, Carlsbad, CA 92011, United States

Manufacture's Name Dongguan Kailai Electronic Co.,Ltd

Address No 36# Industrial Main Road 2nd District (Shahukou),Eastern Industrial Park Changping Town, Dongguan City Guangdong Province, China.

Product description

Trade Mark: JLAB

Product name Wearing Bluetooth Headset

Model and/or type reference ... JBuds Band

Standards..... **47 CFR FCC Part 15 Subpart C 15.247**

This publication may be reproduced in whole or in part for non-commercial purposes as long as the Shenzhen HUAK Testing Technology Co., Ltd. is acknowledged as copyright owner and source of the material. Shenzhen HUAK Testing Technology Co., Ltd. takes no responsibility for and will not assume liability for damages resulting from the reader's interpretation of the reproduced material due to its placement and context.

Date of Test..... :

Date (s) of performance of tests : Oct. 30, 2018 ~ Nov. 06, 2018

Date of Issue : Nov. 06, 2018

Test Result : **Pass**

Testing Engineer : 

(Gary Qian)

Technical Manager : 

(Eden Hu)

Authorized Signatory : 

(Jason Zhou)

**Table of Contents****Page**

1. SUMMARY	4
1.1. TEST STANDARDS	4
1.2. TEST DESCRIPTION.....	4
1.3. TEST FACILITY	5
1.4. STATEMENT OF THE MEASUREMENT UNCERTAINTY.....	5
2. GENERAL INFORMATION	6
2.1. ENVIRONMENTAL CONDITIONS	6
2.2. GENERAL DESCRIPTION OF EUT	6
2.3. DESCRIPTION OF TEST MODES AND TEST FREQUENCY.....	6
2.4. RELATED SUBMITTAL(S) / GRANT (S)	8
2.5. MODIFICATIONS.....	8
2.6. RECEIVER INPUT BANDWIDTH	8
2.7. EXAMPLE OF A HOPPING SEQUENCE IN DATA MODE	8
2.8. EQUALLY AVERAGE USE OF FREQUENCIES AND BEHAVIOUR.....	8
2.9. EQUIPMENT USED	9
3. PEAK OUTPUT POWER.....	10
3.1. MEASUREMENT PROCEDURE	10
3.2. TEST SET-UP (BLOCK DIAGRAM OF CONFIGURATION).....	10
3.3. LIMITS AND MEASUREMENT RESULT	11
4. 20DB BANDWIDTH	17
4.1. MEASUREMENT PROCEDURE	17
4.2. TEST SET-UP (BLOCK DIAGRAM OF CONFIGURATION).....	17
4.3. LIMITS AND MEASUREMENT RESULTS.....	18
5. CONDUCTED SPURIOUS EMISSION	24
5.1. MEASUREMENT PROCEDURE	24
5.2. TEST SET-UP (BLOCK DIAGRAM OF CONFIGURATION).....	24
5.3. LIMITS AND MEASUREMENT RESULT	24
6. RADIATED EMISSION	34
6.1. MEASUREMENT PROCEDURE	34
6.2. TEST SETUP.....	36
6.3. LIMITS AND MEASUREMENT RESULT	37
7. NUMBER OF HOPPING FREQUENCY.....	47
7.1. MEASUREMENT PROCEDURE	47
7.2. TEST SETUP (BLOCK DIAGRAM OF CONFIGURATION)	47
7.3. LIMITS AND MEASUREMENT RESULT	47
8. TIME OF OCCUPANCY (DWELL TIME)	48
8.1. MEASUREMENT PROCEDURE	48
8.2. TEST SETUP (BLOCK DIAGRAM OF CONFIGURATION)	48
8.3. LIMITS AND MEASUREMENT RESULT	48
9. FREQUENCY SEPARATION	52
9.1. MEASUREMENT PROCEDURE	52
9.2. TEST SETUP (BLOCK DIAGRAM OF CONFIGURATION)	52
9.3. LIMITS AND MEASUREMENT RESULT	52
10. TEST SETUP PHOTOS OF THE EUT	53



1. SUMMARY

1.1. TEST STANDARDS

The tests were performed according to following standards:

FCC Rules Part 15.247: Frequency Hopping, Direct Spread Spectrum and Hybrid Systems that are in operation within the bands of 902-928 MHz, 2400-2483.5 MHz, and 5725-5850 MHz

ANSI C63.10:2013 : American National Standard for Testing Unlicensed Wireless Devices

1.2. Test Description

FCC PART 15.247		
FCC Part 15.207	AC Power Conducted Emission	N/A
FCC Part 15.247(a)(1)(i)	20dB Bandwidth	PASS
FCC Part 15.247(d)	Spurious RF Conducted Emission	PASS
FCC Part 15.247(b)	Maximum Peak Output Power	PASS
FCC Part 15.247(b)	Pseudorandom Frequency Hopping Sequence	PASS
FCC Part 15.247(a)(1)(iii)	Number of hopping frequency& Time of Occupancy	PASS
FCC Part 15.247(a)(1)	Frequency Separation	PASS
FCC Part 15.205/15.209	Radiated Emissions	PASS
FCC Part 15.247(d)	Band Edge Compliance of RF Emission	PASS

NOTE: N/A stands for not applicable. The device can not use the BT function in charging mode.



Test Facility

1.3.1 Address of the test laboratory

Shenzhen HUAKE Testing Technology Co., Ltd.
Add.:1F, B2 Building, Junfeng Zhongcheng Zhizao Innovation Park,Heping Community, Fuhai Street, Bao'an District, Shenzhen, China

There is one 3m semi-anechoic chamber and two line conducted labs for final test. The Test Sites meet the requirements in documents ANSI C63.4 and CISPR 32/EN 55032 requirements.

1.3.2 Laboratory accreditation

The test facility is recognized, certified, or accredited by the following organizations:

IC Registration No.: 21210

The 3m alternate test site of Shenzhen HUAKE Testing Technology Co., Ltd. EMC Laboratory has been registered by Certification and Engineer Bureau of Industry Canada for the performance of with Registration No.: 21210 on May 24, 2016.

FCC Registration No.: CN1229

Test Firm Registration Number : 616276

1.3. Statement of the measurement uncertainty

The data and results referenced in this document are true and accurate. The reader is cautioned that there may be errors within the calibration limits of the equipment and facilities. The measurement uncertainty was calculated for all measurements listed in this test report acc. to CISPR 16 - 4 "Specification for radio disturbance and immunity measuring apparatus and methods – Part 4: Uncertainty in EMC Measurements" and is documented in the Shenzhen HUAKE Testing Technology Co., Ltd. quality system acc. to DIN EN ISO/IEC 17025. Furthermore, component and process variability of devices similar to that tested may result in additional deviation. The manufacturer has the sole responsibility of continued compliance of the device.

Hereafter the best measurement capability for HUAKE laboratory is reported:

Test	Measurement Uncertainty	Notes
Transmitter power conducted	±0.57 dB	(1)
Transmitter power Radiated	±2.20 dB	(1)
Conducted spurious emission 9KHz-40 GHz	±2.20 dB	(1)
Occupied Bandwidth	±0.01ppm	(1)
Radiated Emission 30~1000MHz	±4.10dB	(1)
Radiated Emission Above 1GHz	±4.32dB	(1)
Conducted Disturbance0.15~30MHz	±3.20dB	(1)

(1) This uncertainty represents an expanded uncertainty expressed at approximately the 95% confidence level using a coverage factor of k=2.



2. GENERAL INFORMATION

2.1. Environmental conditions

During the measurement the environmental conditions were within the listed ranges:

Normal Temperature:	25°C
Relative Humidity:	55 %
Air Pressure:	101 kPa

2.2. General Description of EUT

Product Name:	Wearing Bluetooth Headset
Model/Type reference:	JBuds Band
Power supply:	DC 3.7V by Battery
Version:	Supported BT5.0
Modulation:	GFSK, $\pi/4$ DQPSK, 8DPSK
Operation frequency:	2402MHz~2480MHz
Channel number:	79
Channel separation:	1MHz
Antenna type:	PCB Antenna
Antenna gain:	2.5dBi
Hardware Version:	V5.0
Software Version:	V1.8

Note: For more details, refer to the user's manual of the EUT.

2.3. Description of Test Modes and Test Frequency

The Applicant provides communication tools software to control the EUT for staying in continuous transmitting and receiving mode for testing.

There are 79 channels provided to the EUT and Channel 00/39/78 was selected for testing.

Operation Frequency :

Channel	Frequency (MHz)
00	2402
01	2403
⋮	⋮
38	2440
39	2441
40	2442
⋮	⋮
77	2479
78	2480

Note: The line display in grey were the channel selected for testing



NO.	TEST MODE DESCRIPTION
1	Low channel TX
2	Middle channel TX
3	High channel TX
4	Normal Operating (BT)

Note:

1. Only the result of the worst case was recorded in the report, if no other cases.
2. For Radiated Emission, 3axis were chosen for testing for each applicable mode.



2.4. Related Submittal(s) / Grant (s)

This submittal(s) (test report) is intended to comply with Section 15.247 of the FCC Part 15, Subpart C Rules.

2.5. Modifications

No modifications were implemented to meet testing criteria.

2.6. Receiver Input Bandwidth

The input bandwidth of the receiver is 1.3MHz. In every connection one Bluetooth device is the master and the other one is slave. The master determines the hopping sequence. The slave follows this sequence. Both devices shift between RX and TX time slot according to the clock of the master. Additionally the type of connection (e.g. single or multislotted packet) is set up at the beginning of the connection. The master adapts its hopping frequency and its TX/RX timing according to the packet type of the connection. Also the slave of the connection will use these settings.

Repeating of a packet has no influence on the hopping sequence. The hopping sequence generated by the master of the connection will be followed in any case. That means, a repeated packet will not be sent on the same frequency, it is sent on the next frequency of the hopping sequence.

2.7. Example of a Hopping Sequence in Data Mode

Example of a 79 hopping sequence in data mode:

40,21,44,23,42,53,46,55,48,33,52,35,50,65,54,67
56,37,60,39,58,69,62,71,64,25,68,27,66,57,70,59
72,29,76,31,74,61,78,63,01,41,05,43,03,73,07,75
09,45,13,47,11,77,15,00,64,49,66,53,68,02,70,06
01, 51, 03, 55, 05, 04

2.8. Equally Average Use of Frequencies and Behaviour

The generation of the hopping sequence in connection mode depends essentially on two input values:

1. LAP/UAP of the master of the connection.
2. Internal master clock

The LAP (lower address part) are the 24 LSB's of the 48 BD_ADDRESS. The BD_ADDRESS is an unambiguous number of every Bluetooth unit. The UAP (upper address part) are the 24 MSB's of the 48 BD_ADDRESS.

The internal clock of a Bluetooth unit is derived from a free running clock which is never adjusted and is never turned off. For synchronization with other units only offsets are used. It has no relation to the time of the day. Its resolution is at least half the RX/TX slot length of 312.5us. The clock has a cycle of about one day (23h30). In most cases it is implemented as a 28-bit counter. For the deriving of the hopping sequence the entire LAP (24 bits), 4 LSB's (4 bits) (Input 1) and the 27 MSB's of the clock (Input 2) are used. With these input values different mathematical procedures (permutations, additions, XOR-operations) are performed to generate the sequence. This will be done at the beginning of every new transmission.

Regarding short transmissions the Bluetooth system has the following behavior:

The first connection between the two devices is established, a hopping sequence was generated. For transmitting the wanted data the complete hopping sequence was not used. The connection ended.

The second connection will be established. A new hopping sequence is generated. Due to the fact the Bluetooth clock has a different value, because the period between the two transmissions is longer (and it cannot be shorter) than the minimum resolution of the clock (312.5us). The hopping sequence will always differ from the first one.



2.9. Equipment Used

Item	Equipment	Manufacturer	Model No.	Serial No.	Last Cal.	Cal. Interval
1.	L.I.S.N. Artificial Mains Network	R&S	ENV216	HKE-002	Dec. 28, 2017	1 Year
2.	Receiver	R&S	ESCI 7	HKE-010	Dec. 28, 2017	1 Year
3.	RF automatic control unit	Tonscend	JS0806-2	HKE-060	Dec. 28, 2017	1 Year
4.	Spectrum analyzer	R&S	FSP40	HKE-025	Dec. 28, 2017	1 Year
5.	Spectrum analyzer	Agilent	N9020A	HKE-048	Dec. 28, 2017	1 Year
6.	Preamplifier	Schwarzbeck	BBV 9743	HKE-006	Dec. 28, 2017	1 Year
7.	EMI Test Receiver	Rohde & Schwarz	ESCI 7	HKE-010	Dec. 28, 2017	1 Year
8.	Bilog Broadband Antenna	Schwarzbeck	VULB9163	HKE-012	Dec. 28, 2017	1 Year
9.	Loop Antenna	Schwarzbeck	FMZB 1519 B	HKE-014	Dec. 28, 2017	1 Year
10.	Horn Antenna	Schwarzbeck	9120D	HKE-013	Dec. 28, 2017	1 Year
11.	Pre-amplifier	EMCI	EMC051845 SE	HKE-015	Dec. 28, 2017	1 Year
12.	Pre-amplifier	Agilent	83051A	HKE-016	Dec. 28, 2017	1 Year
13.	EMI Test Software EZ-EMC	Tonscend	JS1120-B Version	HKE-083	Dec. 28, 2017	N/A
14.	Power Sensor	Agilent	E9300A	HKE-086	Dec. 28, 2017	1 Year
15.	Spectrum analyzer	Agilent	N9020A	HKE-048	Dec. 28, 2017	1 Year
16.	Signal generator	Agilent	N5182A	HKE-029	Dec. 28, 2017	1 Year
17.	Signal Generator	Agilent	83630A	HKE-028	Dec. 28, 2017	1 Year
18.	Shielded room	Shiel Hong	4*3*3	HKE-039	Dec. 28, 2017	3 Year

The calibration interval was one year



3. Peak Output Power

3.1. Measurement Procedure

For peak power test:

1. Connect EUT RF output port to the Spectrum Analyzer through an RF attenuator
2. Span: Approximately five times the 20 dB bandwidth, centered on a hopping channel.
3. RBW > 20 dB bandwidth of the emission being measured.
4. VBW \geq RBW.
5. Sweep: Auto.
6. Detector function: Peak.
7. Trace: Max hold.

Allow trace to stabilize. Use the marker-to-peak function to set the marker to the peak of the emission. The indicated level is the peak output power, after any corrections for external attenuators and cables.

3.2. Test Set-Up (Block Diagram of Configuration)

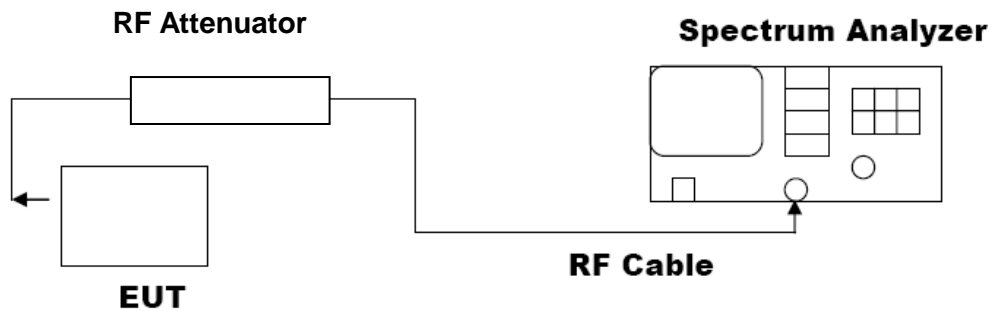



3.3. Limits and Measurement Result

PEAK OUTPUT POWER MEASUREMENT RESULT FOR GFSK MOUDULATION			
Frequency (GHz)	Peak Power (dBm)	Applicable Limits (dBm)	Pass or Fail
2.402	4.179	30	Pass
2.441	3.776	30	Pass
2.480	3.593	30	Pass

CH0





CH39



CH78

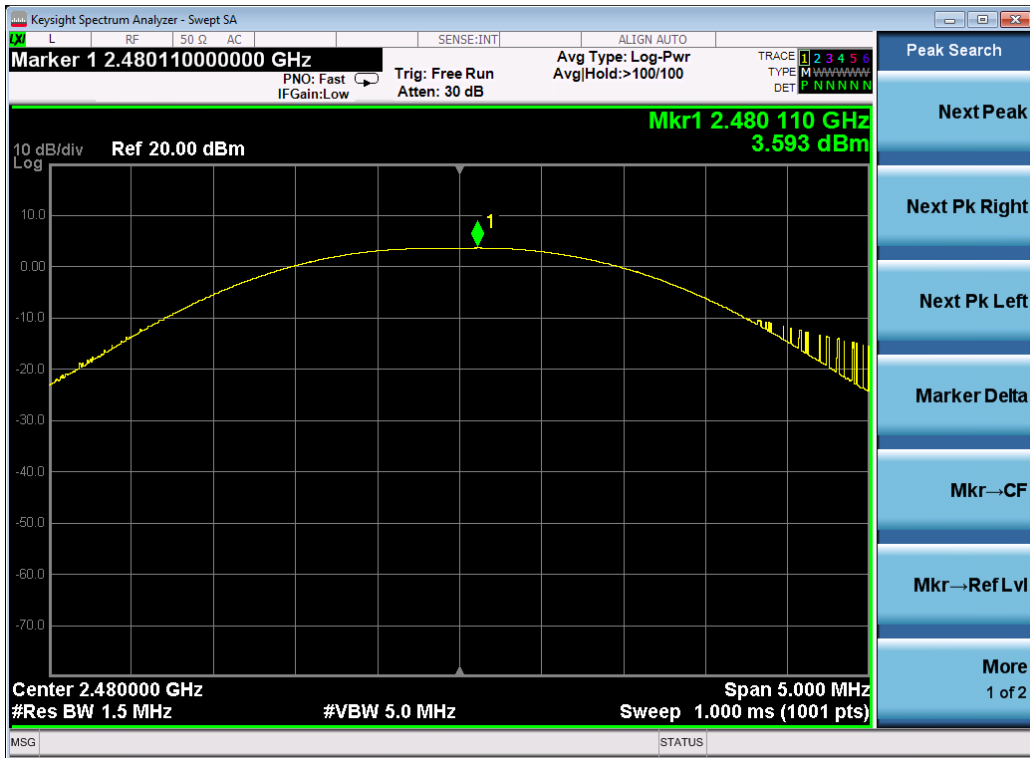



PEAK OUTPUT POWER MEASUREMENT RESULT FOR Π /4-DQPSK MODULATION			
Frequency (GHz)	Peak Power (dBm)	Applicable Limits (dBm)	Pass or Fail
2.402	4.122	30	Pass
2.441	3.741	30	Pass
2.480	3.560	30	Pass

CH0

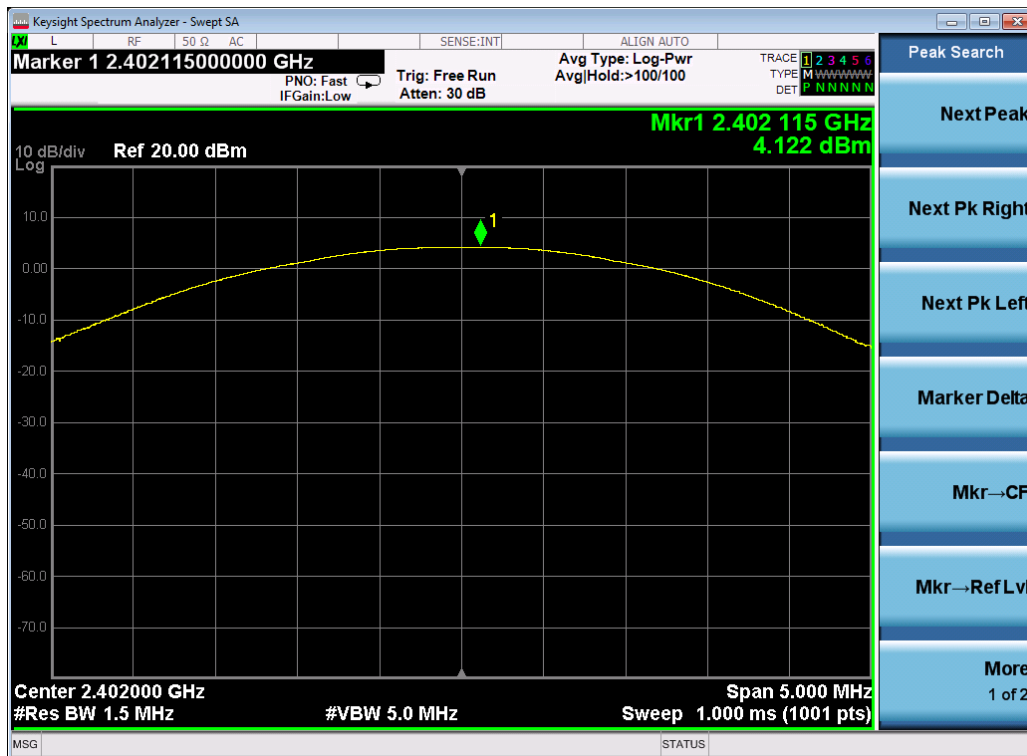



CH39

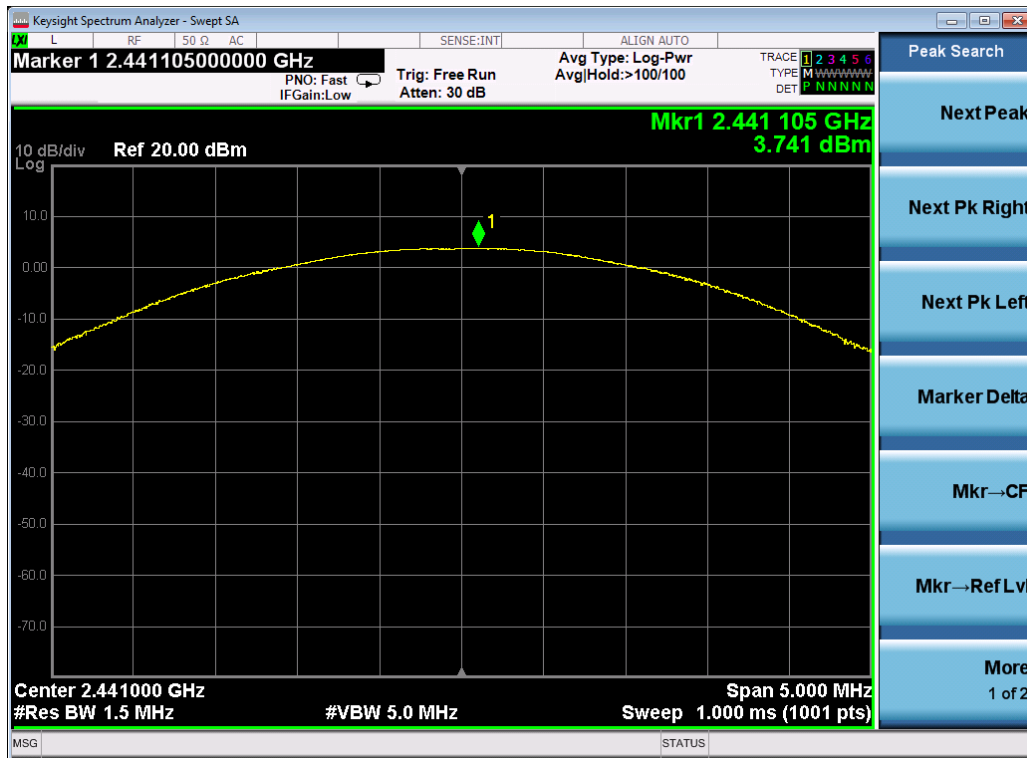

CH78





PEAK OUTPUT POWER MEASUREMENT RESULT FOR 8-DPSK MODULATION			
Frequency (GHz)	Peak Power (dBm)	Applicable Limits (dBm)	Pass or Fail
2.402	4.110	30	Pass
2.441	3.717	30	Pass
2.480	3.543	30	Pass

CH0

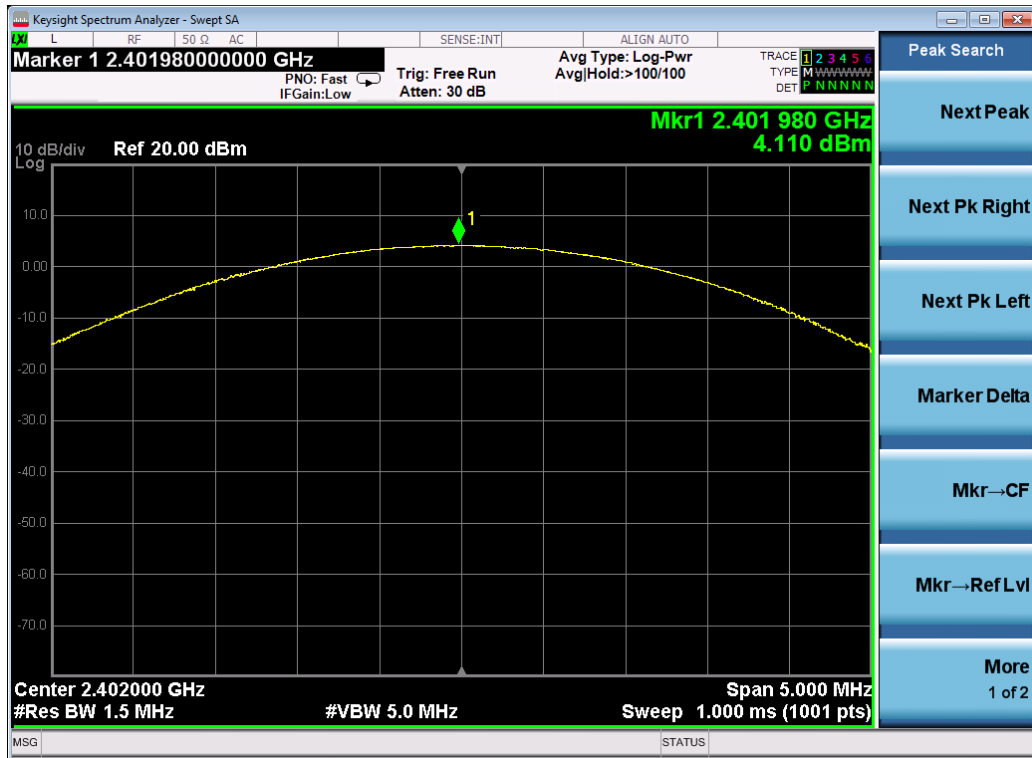



CH39

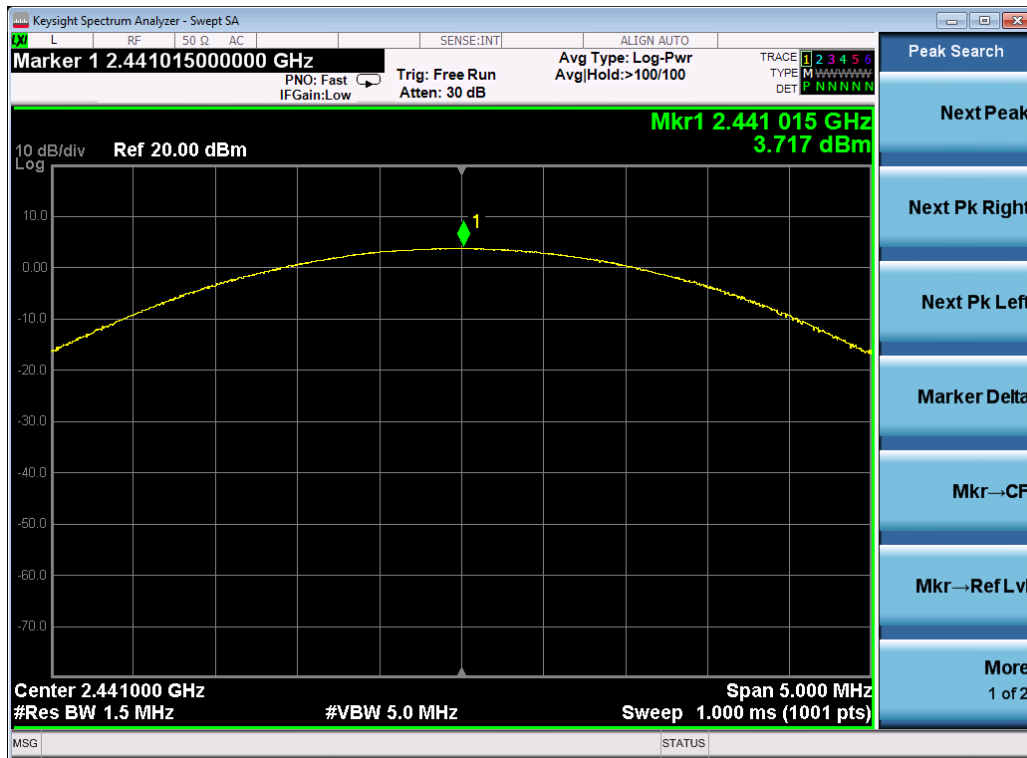

CH78



4. 20dB Bandwidth

4.1. Measurement Procedure

1. Connect EUT RF output port to the Spectrum Analyzer through an RF attenuator
2. Set the EUT Work on the top, the middle and the bottom operation frequency individually.
3. Set Span = approximately 2 to 5 times the 20 dB bandwidth, centered on a hopping channel
The nominal IF filter bandwidth (3 dB RBW) shall be in the range of 1% to 5% of the OBW and video bandwidth (VBW) shall be approximately three times RBW; Sweep = auto; Detector function = peak
4. Set SPA Trace 1 Max hold, then View.

4.2. Test Set-Up (Block Diagram of Configuration)

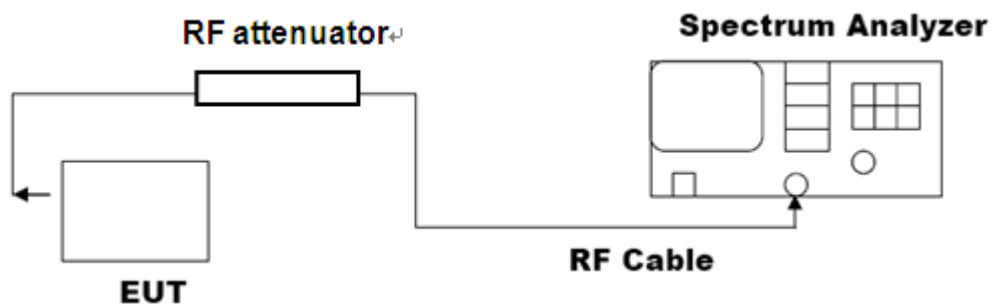



4.3. Limits and Measurement Results

MEASUREMENT RESULT FOR GFSK MODULATION			
Applicable Limits	Measurement Result		
	Test Data (MHz)		Criteria
N/A	Low Channel	0.9214	PASS
	Middle Channel	0.9192	PASS
	High Channel	0.9152	PASS

TEST PLOT OF BANDWIDTH FOR LOW CHANNEL

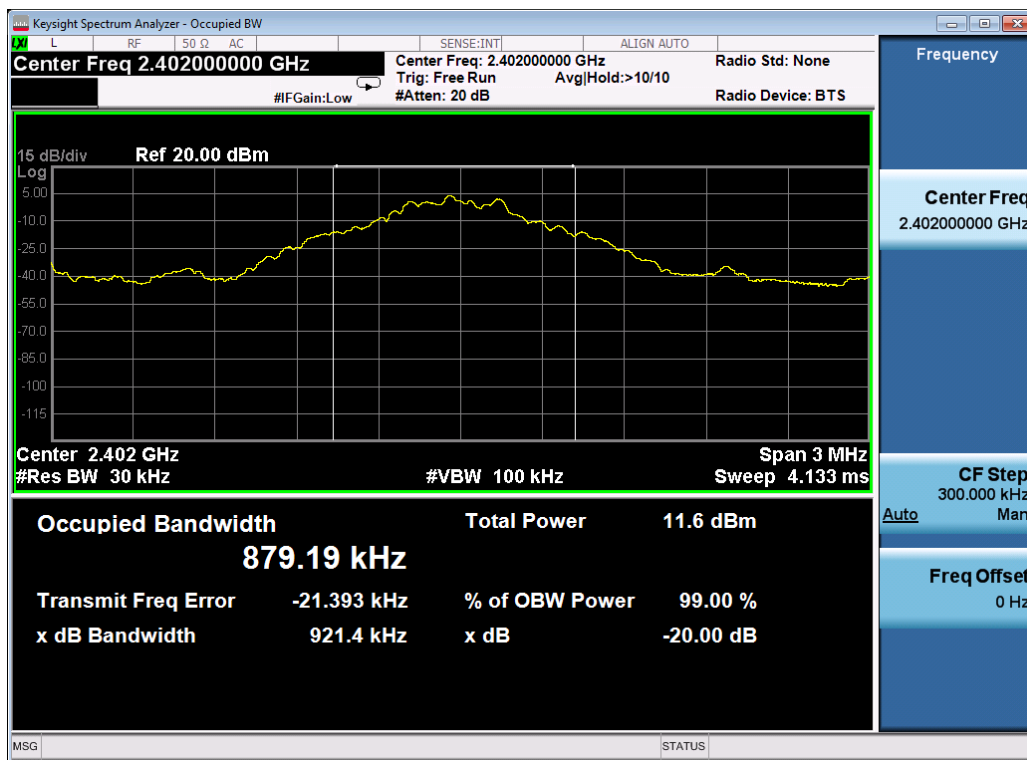



TEST PLOT OF BANDWIDTH FOR MIDDLE CHANNEL

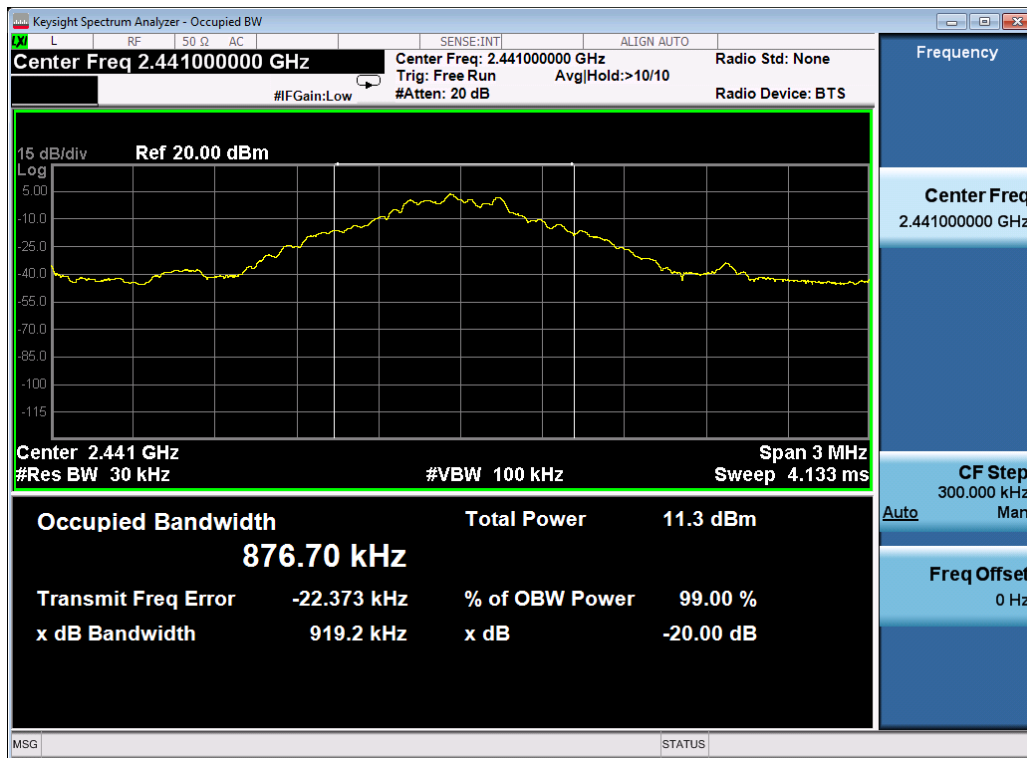

TEST PLOT OF BANDWIDTH FOR HIGH CHANNEL

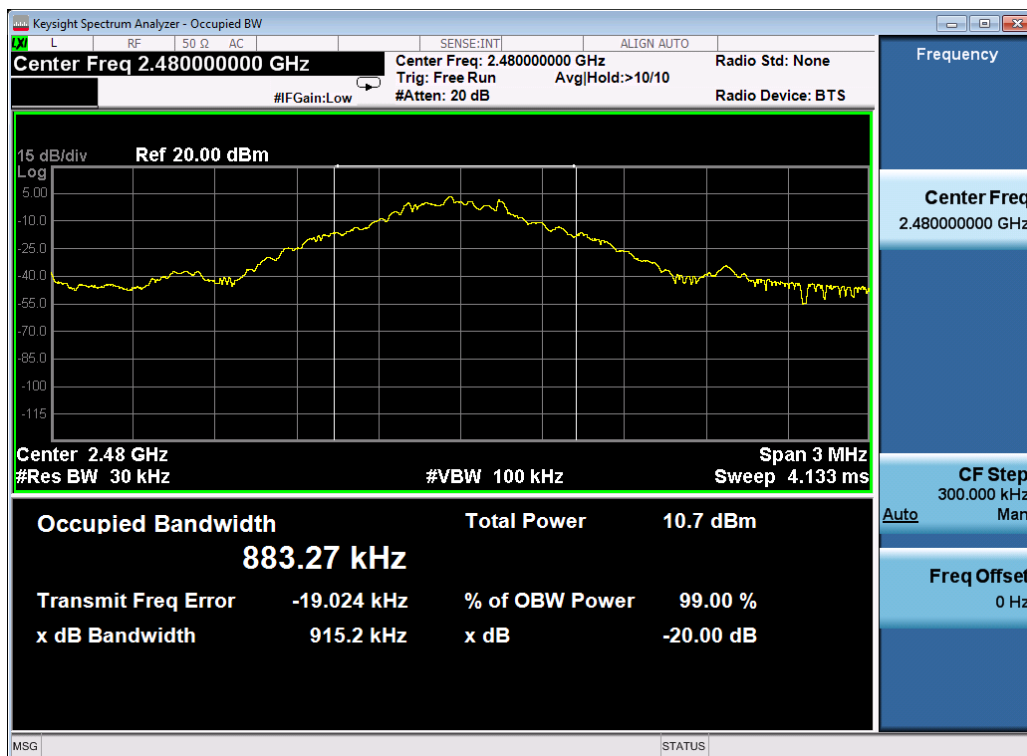



MEASUREMENT RESULT FOR II /4-DQPSK MODULATION			
Applicable Limits	Measurement Result		
	Test Data (MHz)		Criteria
N/A	Low Channel	1.251	PASS
	Middle Channel	1.271	PASS
	High Channel	1.252	PASS

TEST PLOT OF BANDWIDTH FOR LOW CHANNEL

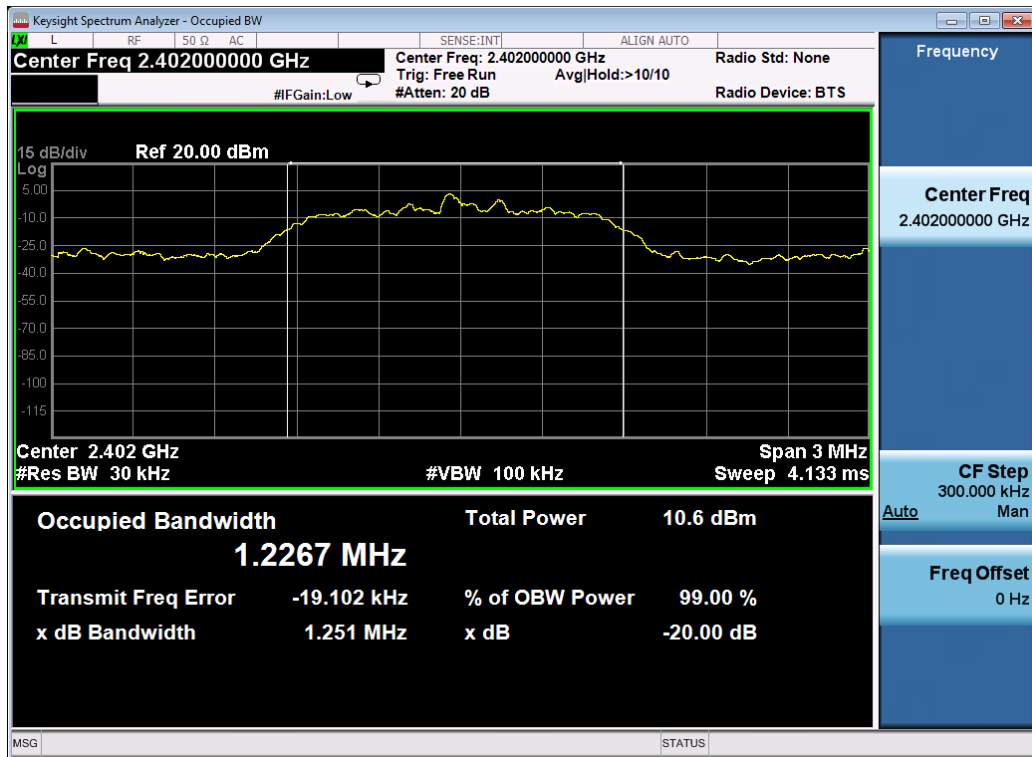



TEST PLOT OF BANDWIDTH FOR MIDDLE CHANNEL

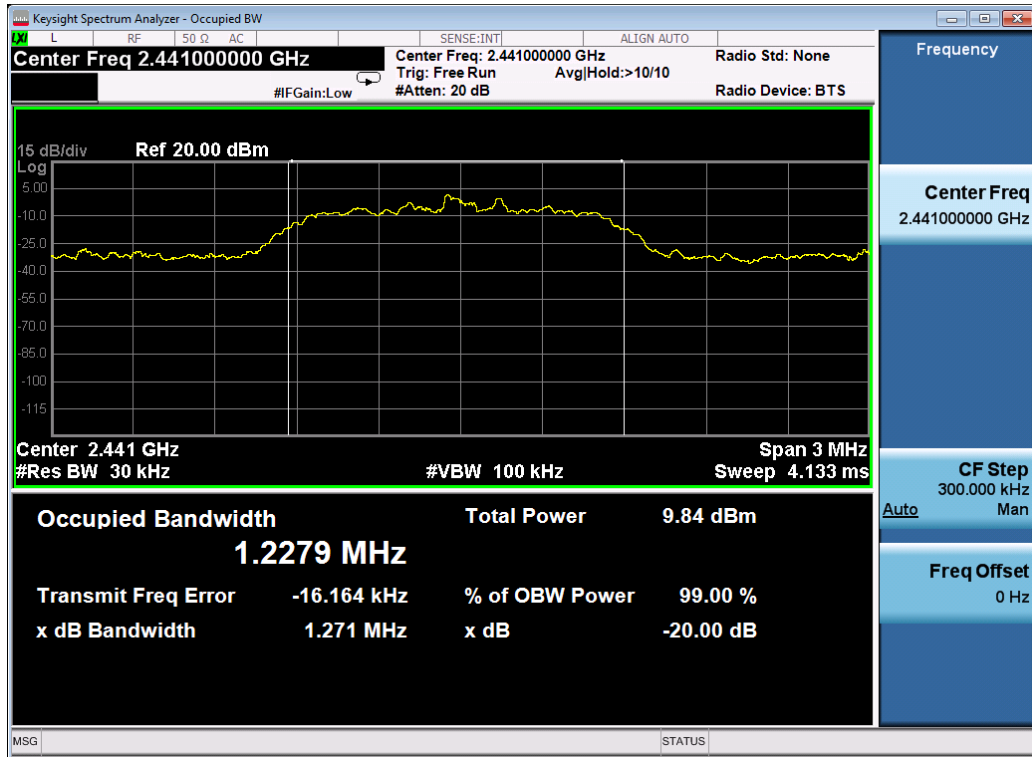

TEST PLOT OF BANDWIDTH FOR HIGH CHANNEL

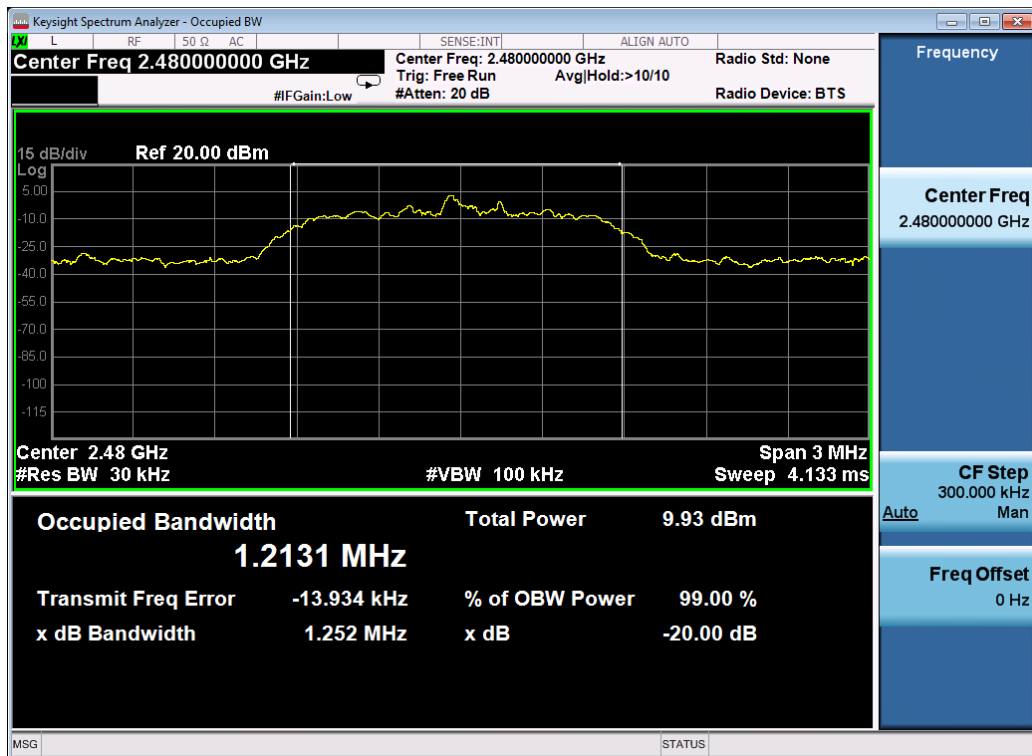



MEASUREMENT RESULT FOR 8-DPSK MODULATION			
Applicable Limits	Measurement Result		
	Test Data (MHz)		Criteria
N/A	Low Channel	1.296	PASS
	Middle Channel	1.284	PASS
	High Channel	1.293	PASS

TEST PLOT OF BANDWIDTH FOR LOW CHANNEL

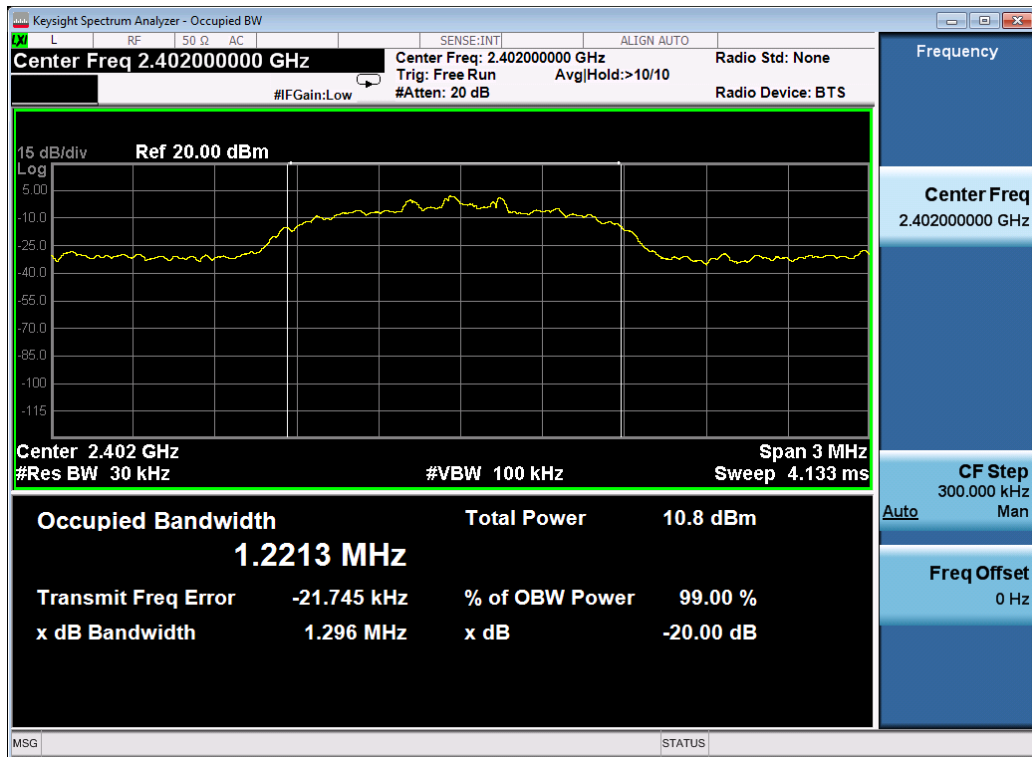



TEST PLOT OF BANDWIDTH FOR MIDDLE CHANNEL

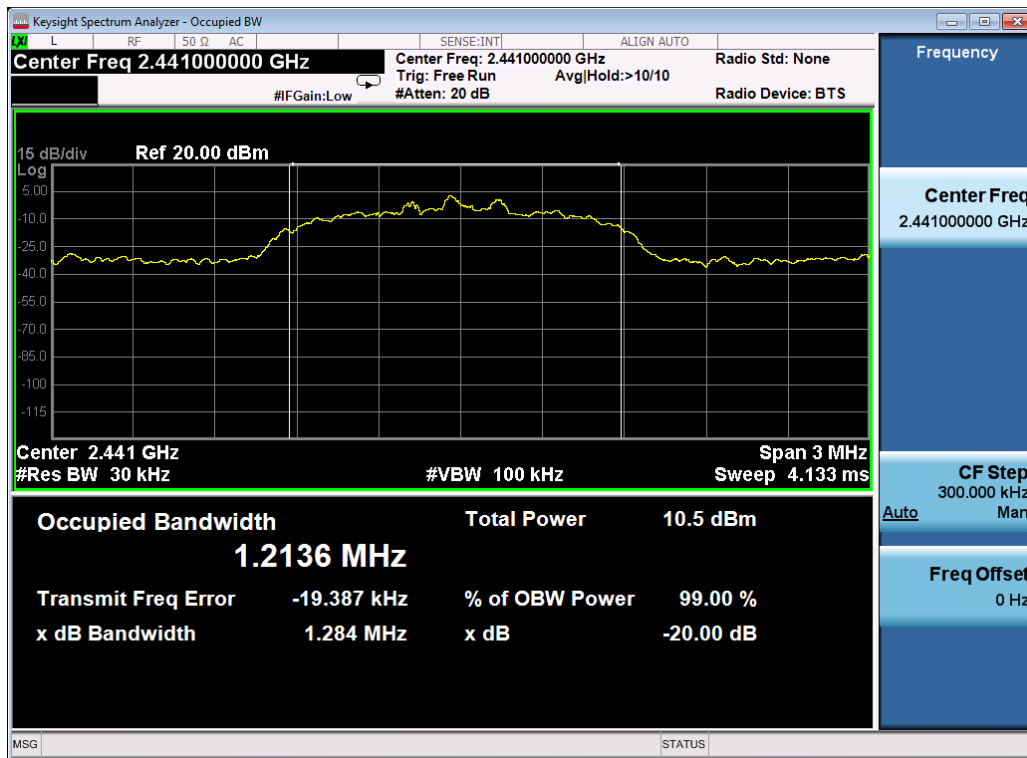

TEST PLOT OF BANDWIDTH FOR HIGH CHANNEL

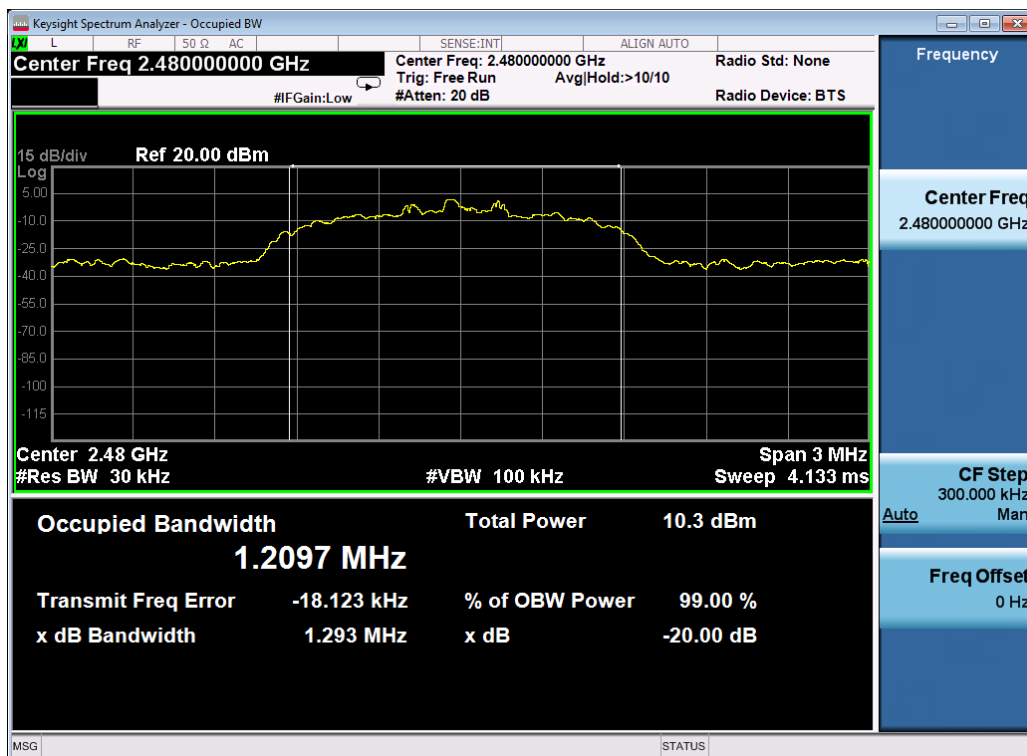



5. Conducted Spurious Emission

5.1. Measurement Procedure

1. Connect EUT RF output port to the Spectrum Analyzer through an RF attenuator
2. Set the EUT Work on the top, the Middle and the bottom operation frequency individually.
3. Set the Span = wide enough to capture the peak level of the in-band emission and all spurious emissions from the lowest frequency generated in the EUT up through the 10th harmonic.
RBW = 100 kHz; VBW= 300 kHz; Sweep = auto; Detector function = peak.
4. Set SPA Trace 1 Max hold, then View.

5.2. Test Set-Up (Block Diagram of Configuration)

The same as described in section 4.2

5.3. Limits and Measurement Result

LIMITS AND MEASUREMENT RESULT		
Applicable Limits	Measurement Result	
	Test Data	Criteria
In any 100 KHz Bandwidth Outside the frequency band in which the spread spectrum intentional radiator is operating, the radio frequency power that is produce by the intentional radiator shall be at least 20 dB below that in 100KHz bandwidth within the band that contains the highest level of the desired power. In addition, radiation emissions which fall in the restricted bands, as defined in §15.205(a), must also comply with the radiated emission limits specified in§15.209(a)	At least -20dBc than the limit Specified on the BOTTOM Channel	PASS
	At least -20dBc than the limit Specified on the TOP Channel	PASS



TEST PLOT OF OUT OF BAND EMISSIONS OF GFSK MODULATION IN MIDDLE CHANNEL

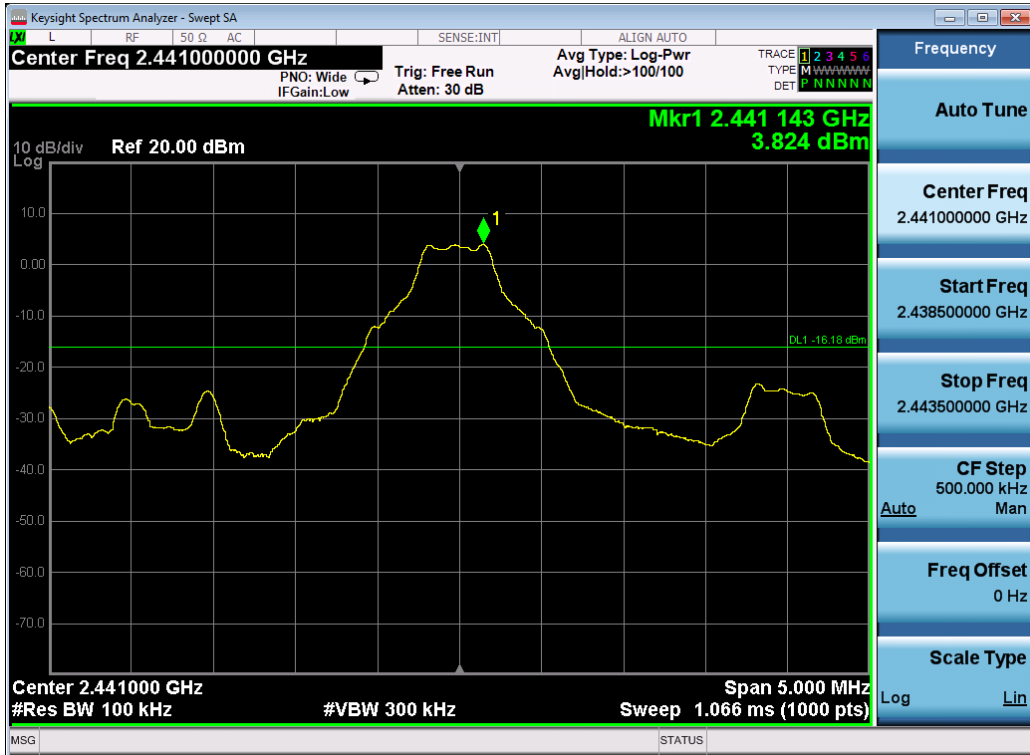

Frequency

Auto Tune

Center Freq
2.441000000 GHz

Start Freq
2.438500000 GHz

Stop Freq
2.443500000 GHz

CF Step
500.000 kHz
Auto Man

Freq Offset
0 Hz

Scale Type
Log Lin

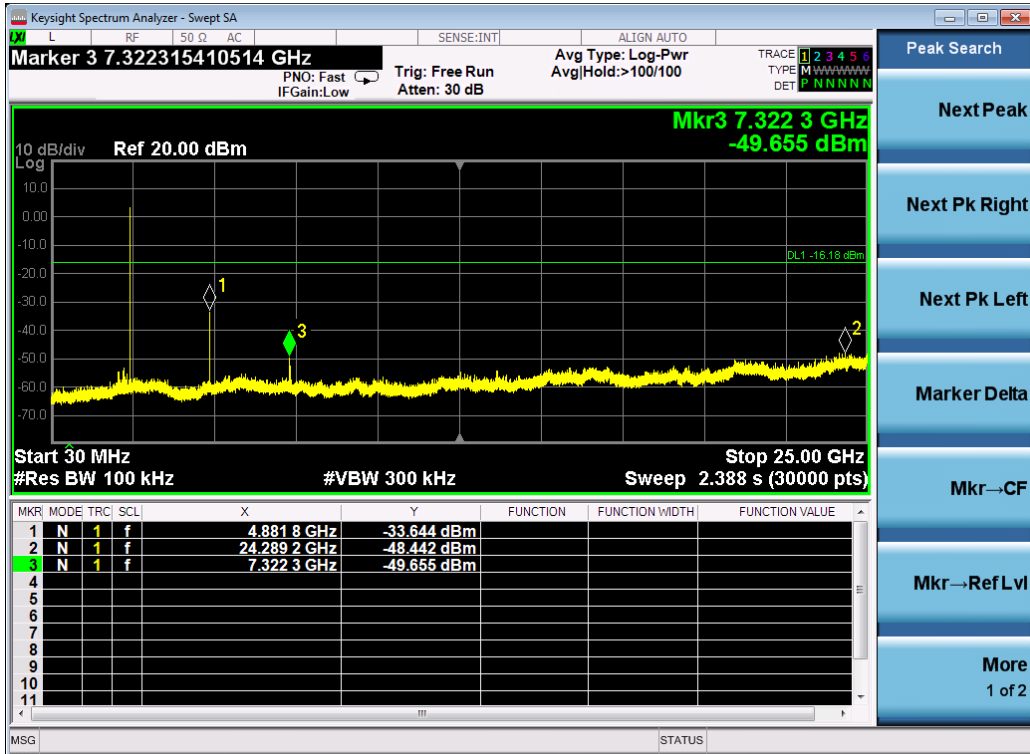

Peak Search

Next Peak

Next Pk Right

Next Pk Left

Marker Delta

Mkr→CF

Mkr→Ref Lvl

More
1 of 2



TEST PLOT OF OUT OF BAND EMISSIONS OF GFSK MODULATION IN HIGH CHANNEL

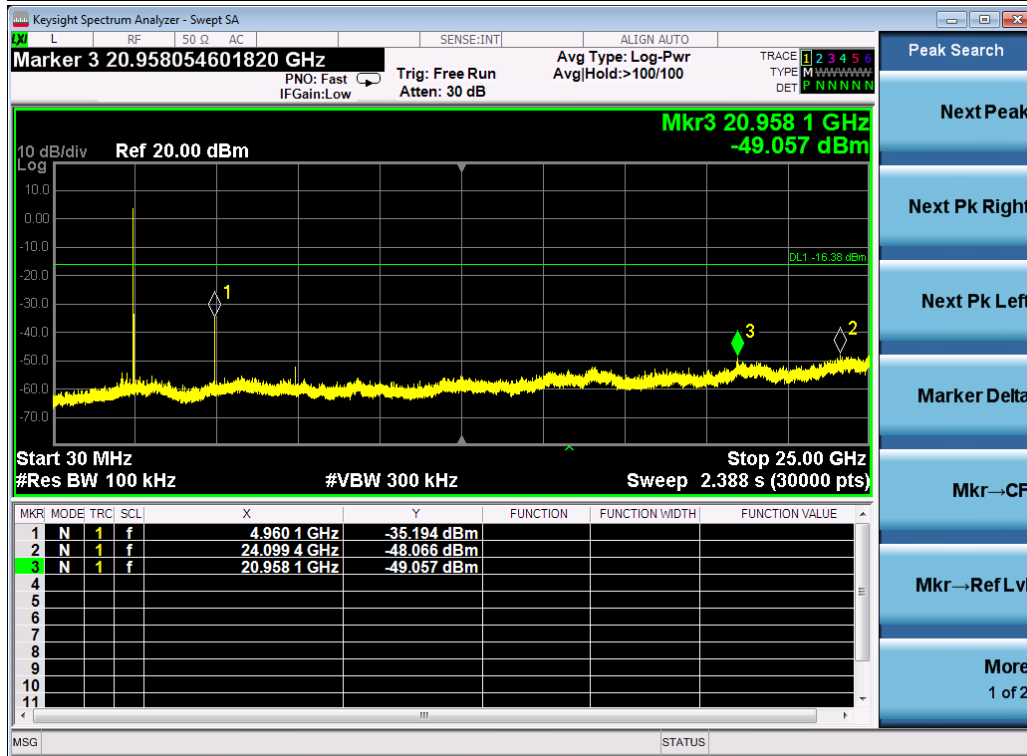

Note: The peak emissions without marker on the above plots are fundamental wave and need not to compare with the limit. The GFSK modulation is the worst case and only those data recorded in the report.



GFSK MODULATION IN HIGH CHANNEL Hopping off



Hopping on





π /4-DQPSK MODULATION IN LOW CHANNEL Hopping off



Hopping on





π /4-DQPSK MODULATION IN HIGH CHANNEL Hopping off

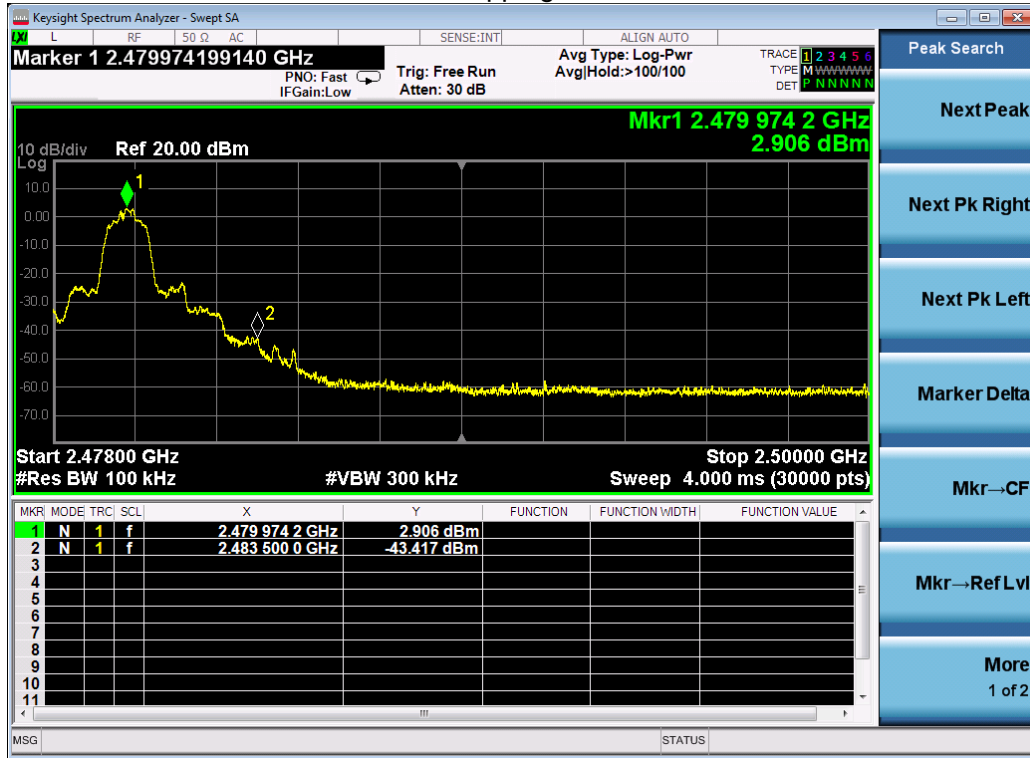

Hopping on

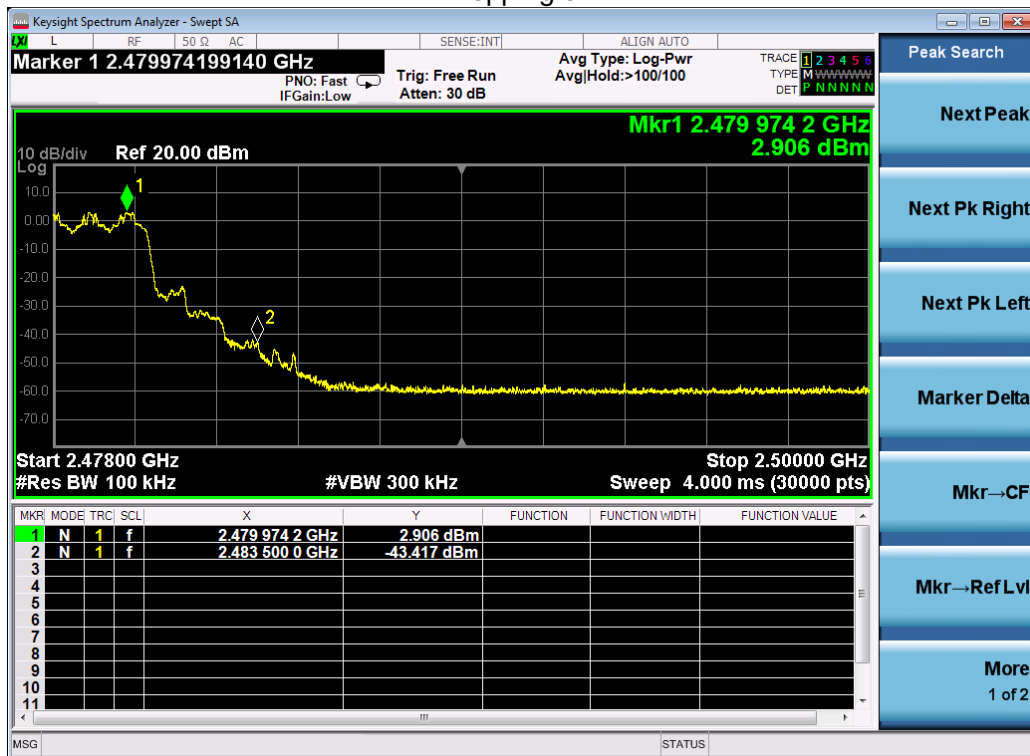



8-DPSK MODULATION IN LOW CHANNEL

Hopping off

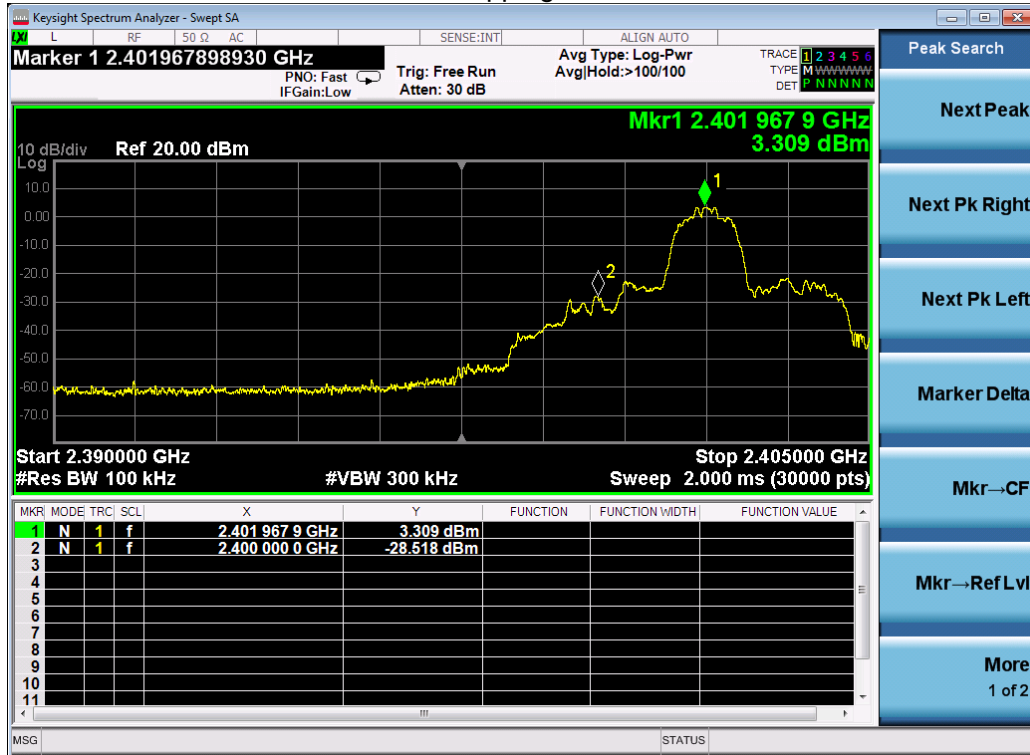

Hopping on





6. Radiated Emission

6.1. Measurement Procedure

1. The EUT was placed on the top of the turntable 0.8 or 1.5 meter above ground. The phase center of the receiving antenna mounted on the top of a height-variable antenna tower was placed 3 meters far away from the turntable.
2. Power on the EUT and all the supporting units. The turntable was rotated by 360 degrees to determine the position of the highest radiation.
3. The height of the broadband receiving antenna was varied between one meter and four meters above ground to find the maximum emissions field strength of both horizontal and vertical polarization.
4. For each suspected emissions, the antenna tower was scan (from 1 M to 4 M) and then the turntable was rotated (from 0 degree to 360 degrees) to find the maximum reading.
5. Set the test-receiver system to Peak or CISPR quasi-peak Detect Function with specified bandwidth under Maximum Hold Mode.
6. For emissions above 1GHz, use 1MHz RBW and 3MHz VBW for peak reading. Place the measurement antenna away from each area of the EUT determined to be a source of emissions at the specified measurement distance, while keeping the measurement antenna aimed at the source of emissions at each frequency of significant emissions, with polarization oriented for maximum response. The measurement antenna may have to be higher or lower than the EUT, depending on the radiation pattern of the emission and staying aimed at the emission source for receiving the maximum signal. The final measurement antenna elevation shall be that which maximizes the emissions. The measurement antenna elevation for maximum emissions shall be restricted to a range of heights of from 1 m to 4 m above the ground or reference ground plane.
7. When the radiated emissions limits are expressed in terms of the average value of the emissions, and pulsed operation is employed, the measurement field strength shall be determined by averaging over one complete pulse train, including blanking intervals, as long as the pulse train does not exceed 0.1 seconds. As an alternative (provided the transmitter operates for longer than 0.1 seconds) or in cases where the pulse train exceeds 0.1 seconds, the measured field strength shall be determined from the average absolute voltage during a 0.1 second interval during which the field strength is at its maximum values.
8. If the emissions level of the EUT in peak mode was 3 dB lower than the average limit specified, then testing will be stopped and peak values of EUT will be reported, otherwise, the emissions which do not have 3 dB margin will be repeated one by one using the quasi-peak method for below 1GHz.
9. For testing above 1GHz, the emissions level of the EUT in peak mode was lower than average limit (that means the emissions level in peak mode also complies with the limit in average mode), then testing will be stopped and peak values of EUT will be reported, otherwise, the emissions will be measured in average mode again and reported.
10. In case the emission is lower than 30MHz, loop antenna has to be used for measurement and the recorded data should be QP measured by receiver. High - Low scan is not required in this case.



The following table is the setting of spectrum analyzer and receiver.

Spectrum Parameter	Setting
Start ~Stop Frequency	9KHz~150KHz/RB 200Hz for QP
Start ~Stop Frequency	150KHz~30MHz/RB 9KHz for QP
Start ~Stop Frequency	30MHz~1000MHz/RB 120KHz for QP
Start ~Stop Frequency	1GHz~26.5GHz 1MHz/3MHz for Peak, 1MHz/10Hz for Average

Receiver Parameter	Setting
Start ~Stop Frequency	9KHz~150KHz/RB 200Hz for QP
Start ~Stop Frequency	150KHz~30MHz/RB 9KHz for QP
Start ~Stop Frequency	30MHz~1000MHz/RB 120KHz for QP