



FCC CERTIFICATION TEST REPORT

FOR

Applicant	:	PEAG, LLC dba JLab Audio
Address	:	5927 Landau Ct. Carlsbad, CA 92008, USA
Equipment under Test	:	True Wireless Earbuds
Model No.	:	JBuds ANC
Trade Mark	:	JLAB
FCC ID	:	2AHYV-JBANC
Manufacturer	:	GuangDong Simpreal Intelligent Technology Co., Ltd
Address	:	Room 2408, JiaHong ZhenXing DaSha, DongGuan Avenue #13, DongCheng District, DongGuan City, GuangDong Province, P.R. China

Issued By: Dongguan Dongdian Testing Service Co., Ltd.

Add.: No. 17, Zongbu Road 2, Songshan Lake Sci&Tech, Industry Park,
Dongguan City, Guangdong Province, China, 523808

Tel.: +86-0769-38826678, **E-mail:** ddt@dgddt.com, <http://www.dgddt.com>

REPORT

Table of Contents

	Test report declares.....	4
1.	Summary of Test Results.....	6
2.	General Test Information	7
2.1.	Description of EUT	7
2.2.	Accessories of EUT.....	7
2.3.	Assistant equipment used for test.....	8
2.4.	Block diagram of EUT configuration for test	8
2.5.	Test environment conditions	8
2.6.	Deviations of test standard.....	8
2.7.	Test laboratory	9
2.8.	Measurement uncertainty.....	9
3.	Equipment Used During Test.....	10
4.	6 dB Bandwidth	12
4.1.	Block diagram of test setup.....	12
4.2.	Limits	12
4.3.	Test procedure	12
4.4.	Test result.....	12
4.5.	Test graphs	13
5.	99% Bandwidth	15
5.1.	Block diagram of test setup.....	15
5.2.	Limits	15
5.3.	Test procedure	15
5.4.	Test Result	15
5.5.	Test Graphs.....	16
6.	Maximum Peak Output Power	18
6.1.	Block diagram of test setup.....	18
6.2.	Limits	18
6.3.	Test procedure	18
6.4.	Test result.....	18
6.5.	Test graphs	19
7.	Power Spectral Density.....	21
7.1.	Block diagram of test setup.....	21
7.2.	Limits	21
7.3.	Test procedure	21
7.4.	Test result.....	21
7.5.	Test graphs	22
8.	Band Edge Compliance (Conducted Method)	24

8.1.	Block diagram of test setup.....	24
8.2.	Limits	24
8.3.	Test procedure	24
8.4.	Test result.....	24
8.5.	Test graphs	25
9.	RF Conducted Spurious Emissions	27
9.1.	Block diagram of test setup.....	27
9.2.	Limits	27
9.3.	Test procedure	27
9.4.	Test result.....	28
9.5.	Test graphs	28
10.	Duty Cycle	35
10.1.	Block diagram of test setup.....	35
10.2.	Limit.....	35
10.3.	Test procedure	35
10.4.	Test result.....	35
10.5.	Test graphs	36
11.	Radiated Emission	38
11.1.	Block diagram of test setup.....	38
11.2.	Limit.....	39
11.3.	Test Procedure.....	40
11.4.	Test result.....	42
12.	Emissions in Restricted Frequency Bands	57
12.1.	Block diagram of test setup.....	57
12.2.	Limit.....	57
12.3.	Test procedure	57
12.4.	Test result.....	57
13.	Power Line Conducted Emission	66
13.1.	Block diagram of test setup.....	66
13.2.	Power line conducted emission limits	66
13.3.	Test procedure	66
13.4.	Test result.....	67
14.	Antenna Requirements	70
14.1.	Limit.....	70
14.2.	Result	70
15.	Test Setup Photograph	71
16.	Photos of the EUT	73

Test Report Declare

Applicant	:	PEAG, LLC dba JLab Audio
Address	:	5927 Landau Ct. Carlsbad, CA 92008, USA
Equipment under Test	:	True Wireless Earbuds
Model No.	:	JBuds ANC
Trade Mark	:	JLAB
Manufacturer	:	GuangDong Simpreal Intelligent Technology Co., Ltd
Address	:	Room 2408, JiaHong ZhenXing DaSha, DongGuan Avenue #13, DongCheng District, DongGuan City, Guangdong Province, P.R. China

Test Standard Used:

FCC Rules and Regulations Part 15 Subpart C.

Test Procedure Used:

ANSI C63.10:2013.

We Declare:

The equipment described above is tested by Dongguan Dongdian Testing Service Co., Ltd. and in the configuration tested the equipment complied with the standards specified above. The test results are contained in this test report and Dongguan Dongdian Testing Service Co., Ltd. is assumed of full responsibility for the accuracy and completeness of these tests.

After test and evaluation, our opinion is that the equipment provided for test compliance with the requirement of the above FCC standards.

Report No.:	DDT-RE23071126-2E02		
Date of Receipt:	Aug. 10, 2023	Date of Test:	Aug. 10, 2023 ~ Aug. 23, 2023

Prepared By:

Johnny Wang

Johnny Wang/Engineer

Approved By:

Damon Hu

Damon Hu/EMC Manager

Note: This report applies to above tested sample only. This report shall not be reproduced in parts without written approval of Dongguan Dongdian Testing Service Co., Ltd.

Revision History

Rev.	Revisions	Issue Date	Revised By
---	Initial issue	Aug. 23, 2023	

1. Summary of Test Results

The EUT have been tested according to the applicable standards as referenced below.		
Description of Test Item	Standard	Verdict
6dB Bandwidth and 99% Bandwidth	FCC Part 15: 15.247(a)(2)	Pass
Peak Output Power	FCC Part 15: 15.247(b)(3)	Pass
Power Spectral Density	FCC Part 15:15.247(e)	Pass
Band Edge Compliance (conducted method)	FCC Part 15: 15.247(d)	Pass
RF Conducted Spurious Emissions	FCC Part 15: 15.247(d)	Pass
Radiation Emission	FCC Part 15: 15.205 FCC Part 15: 15.209 FCC Part 15: 15.247(d)	Pass
Emission in Restricted Frequency Bands	FCC Part 15: 15.205 FCC Part 15: 15.209 FCC Part 15: 15.247(d)	Pass
Power Line Conducted Emission	FCC Part 15: 15.207(a)	Pass
Antenna Requirement	FCC Part 15: 15.203	Pass

2. General Test Information

2.1. Description of EUT

EUT Name	: True Wireless Earbuds
Model Number	: JBuds ANC
EUT Function Description	: Please reference user manual of this device
Power Supply	: Charging case: DC 5V by an external adapter or a 3.7V built-in lithium battery. Wireless headphones: DC 3.7V built-in lithium battery.
Radio Specification	: Bluetooth V5.3
Operation Frequency	: 2402 MHz - 2480 MHz
Modulation	: GFSK
Data Rate	: 1 Mbps, 2 Mbps
Antenna	: Left side: -0.26 dBi Right side: -1.05 dBi
Sample Number	: S23071126-02 for conductive, S23071126-03 for radiation

Note 1: EUT is the ab. of equipment under test.

Note 2: The PCB of the both side earphones are symmetrical, only one side to be tested, so choose the left side to test and reported it.

Channel information					
Channel	Frequency (MHz)	Channel	Frequency (MHz)	Channel	Frequency (MHz)
0	2402	14	2430	28	2458
1	2404	15	2432	29	2460
2	2406	16	2434	30	2462
3	2408	17	2436	31	2464
4	2410	18	2438	32	2466
5	2412	19	2440	33	2468
6	2414	20	2442	34	2470
7	2416	21	2444	35	2472
8	2418	22	2446	36	2474
9	2420	23	2448	37	2476
10	2422	24	2450	38	2478
11	2424	25	2452	39	2480
12	2426	26	2454		
13	2428	27	2456		

2.2. Accessories of EUT

Description of Accessories	Manufacturer	Model number	Description	Remark
N/A	N/A	N/A	N/A	N/A

2.3. Assistant equipment used for test

Assistant equipment	Manufacturer	Model number	EMC Compliance	SN
Adapter	HUAWEI	HW-050450C00	N/A	Input: 100-240V~50/60Hz, Output: 5V/2A or 4.5V/5A or 5V/4.5A
NoteBook	Dell	i7-1255U MX550	N/A	7849D18D-16BE-45F6-A37B-9B25917D48B2

2.4. Block diagram of EUT configuration for test

EUT

Test software: WQ_BQB.exe

The test software was used to control EUT work in Continuous Tx mode, and select test channel, wireless mode as below table:

The pathloss of external cable: 0.5dB (According to the manufacturer's claims)

Tested mode, channel, information			
Mode	Setting Tx Power	Channel	Frequency (MHz)
GFSK 1M	Default	CH0	2402
	Default	CH19	2440
	Default	CH39	2480
GFSK 2M	Default	CH0	2402
	Default	CH19	2440
	Default	CH39	2480

2.5. Test environment conditions

Temperature range:	+15°C to +35 °C
Humidity range:	20% to 75%
Pressure range:	86 kPa to106 kPa

2.6. Deviations of test standard

No deviation.

2.7. Test laboratory

Dongguan Dongdian Testing Service Co., Ltd.

Add.: No. 17, Zongbu Road 2, Songshan Lake Sci&Tech, Industry Park, Dongguan City, Guangdong Province, China, 523808.

Tel.: +86-0769-38826678, <http://www.dgddt.com>, Email: ddt@dgddt.com.

CNAS Accreditation No. L6451; A2LA Accreditation Number: 3870.01

FCC Designation Number: CN1182, Test Firm Registration Number: 540522

Innovation, Science and Economic Development Canada Site Registration Number: 10288A

Conformity Assessment Body identifier: CN0048

VCCI facility registration number: C-20087, T-20088, R-20123, R-20155, G-20118

2.8. Measurement uncertainty

Test Item	Uncertainty
Bandwidth	1.1%
Peak Output Power (Conducted) (Spectrum analyzer)	0.86 dB (10 MHz ≤ f < 3.6 GHz);
	1.38 dB (3.6 GHz ≤ f < 8 GHz)
Peak Output Power (Conducted) (Power Sensor)	0.74 dB
Power Spectral Density	0.74 dB (10 MHz ≤ f < 3.6 GHz);
	1.38 dB (3.6 GHz ≤ f < 8 GHz)
Frequencies Stability	6.7 x 10 ⁻⁸ (Antenna couple method)
	5.5 x 10 ⁻⁸ (Conducted method)
Conducted spurious emissions	0.86 dB (10 MHz ≤ f < 3.6 GHz);
	1.40 dB (3.6 GHz ≤ f < 8 GHz)
	1.66 dB (8 GHz ≤ f < 26.5 GHz)
Uncertainty for radio frequency (RBW < 20 kHz)	3x10 ⁻⁸
Temperature	0.4 °C
Humidity	2 %
Uncertainty for Radiation Emission test (9 kHz – 30 MHz)	3.44 dB
Uncertainty for Radiation Emission test (30 MHz - 1 GHz)	4.70 dB (Antenna Polarize: V)
	4.84 dB (Antenna Polarize: H)
Uncertainty for Radiation Emission test (1 GHz - 40 GHz)	4.10 dB (1 - 6 GHz)
	4.40 dB (6 GHz - 18 GHz)
	3.54 dB (18 GHz - 26 GHz)
	4.30 dB (26 GHz - 40 GHz)
Uncertainty for Power line conduction emission test	3.34dB (150KHz-30MHz)
	3.72dB (9KHz-150KHz)

Note: This uncertainty represents an expanded uncertainty expressed at approximately the 95% confidence level using a coverage factor of k=2.

3. Equipment Used During Test

Equipment	Manufacturer	Model No.	Serial No.	Last Cal.	Cal. Interval
☑RF Connected Test (Tonscend RF Measurement System 4#)					
Signal & Spectrum analyzer	R&S	FSV3044	101173	Apr. 23, 2023	1 Year
Wideband Radio Communication tester	R&S	CMW500	168801	Apr. 27, 2023	1 Year
Vector Signal Generator	Agilent	N5182A	MY48180737	Apr. 27, 2023	1 Year
Vector Signal Generator	Agilent	E8267D	US49060192	Sep. 28, 2022	1 Year
RF Control Unit	Tonsend	JS0806-2	2118060485	Apr. 27, 2023	1 Year
Temp&Humi Programmable	ZHIXIANG	ZXGDJS-150L	ZX170110-A	May 15, 2023	1 Year
Test Software	JS Tonscend	JS1120-3	Ver.3.2.22	N/A	N/A
☑Radiation 3#chamber					
EMI Test Receiver	R&S	ESU26	100472	Apr. 23, 2023	1 Year
Spectrum analyzer	Agilent	E4447A	MY50180031	Apr. 23, 2023	1 Year
Active Loop antenna	Schwarzbeck	FMZB-1519	1519-038	Sep. 29, 2022	1 Year
Trilog Broadband Antenna	Schwarzbeck	VULB 9163	01429	Jul. 12, 2023	2 Year
Double Ridged Horn Antenna	Schwarzbeck	BBHA9120 D	02468	Sep. 29, 2022	1 Year
Broad Band Horn Antenna	Schwarzbeck	BBHA 9170	790	Apr. 26, 2023	1 Year
Pre-amplifier	COM-POWER	PAM-118A	18040084	Jul. 15, 2023	1 Year
Pre-amplifier	COM-POWER	PAM-840A	461369	Apr. 27, 2023	1 Year
RE Cable	N/A	W23.02 CP1-X2 + W23.09 AP1-X8+ JCT26S-NJ-NJ-1.5M	4.5M+8M+1.5M	Apr. 21, 2023	1 Year
RF Cable	Yuhu Technology	JCTB810-NJ-NJ-9M+ ZT26S-SMAJ-SMAJ-1M	21123964	Apr. 23, 2023	1 Year
Micro-Tronics filters	REBES	BRM50702	G555	N/A	N/A
Micro-Tronics filters	REBES	BRM50716	G392	N/A	N/A
High Pass filter	XB	XBLBQ-GTA67	210820-2-3	N/A	N/A
Test software	Tonscend	JS32-RE	V 5.0.0.1	N/A	N/A
☑Power Line Conducted Emissions Test 1#					
Test Receiver	R&S	ESCI	100551	Aug. 26, 2022	1 Year
LISN 1	R&S	ENV216	101109	Aug. 26, 2022	1 Year
LISN 2	R&S	ESH2-Z5	100309	Aug. 26, 2022	1 Year

Pulse Limiter	R&S	ESH3-Z2	101242	Aug. 26, 2022	1 Year
CE Cable 1	HUBSER	N/A	W10.01	Aug. 26, 2022	1 Year
Test software	Audix	E3	V 6.11111b	N/A	N/A
Test Receiver	R&S	ESCI	100551	Aug. 26, 2022	1 Year

4. 6 dB Bandwidth

4.1. Block diagram of test setup



4.2. Limits

For direct sequence systems, the minimum 6 dB bandwidth shall be at least 500 kHz

4.3. Test procedure

- (1) The test according to ANSI C63.10-2013 clause 11.8.
- (2) Connect EUT's antenna output to spectrum analyzer by RF cable, the path loss was compensated to the results
- (3) Set the EUT as maximum power setting and enable the EUT transmit continuously
- (4) Use the following spectrum analyzer settings for 6 dB Bandwidth:

RBW:	100 kHz
VBW:	$\geq [3 \times \text{RBW}]$
Detector Mode:	Peak
Sweep time:	Auto
Trace mode	Max hold
- (5) Allow the trace to stabilize, measure the 6 dB bandwidth of signal, and record the results in the report.

4.4. Test result

Test Mode	Antenna	Frequency [MHz]	DTS BW [MHz]	FL[MHz]	FH[MHz]	Limit [MHz]	Verdict
BLE_1M	Ant1	2402	0.70	2401.64	2402.34	0.5	PASS
		2440	0.72	2439.62	2440.34	0.5	PASS
		2480	0.70	2479.64	2480.34	0.5	PASS
BLE_2M	Ant1	2402	1.18	2401.40	2402.59	0.5	PASS
		2440	1.18	2439.40	2440.58	0.5	PASS
		2480	1.19	2479.40	2480.59	0.5	PASS

4.5. Test graphs

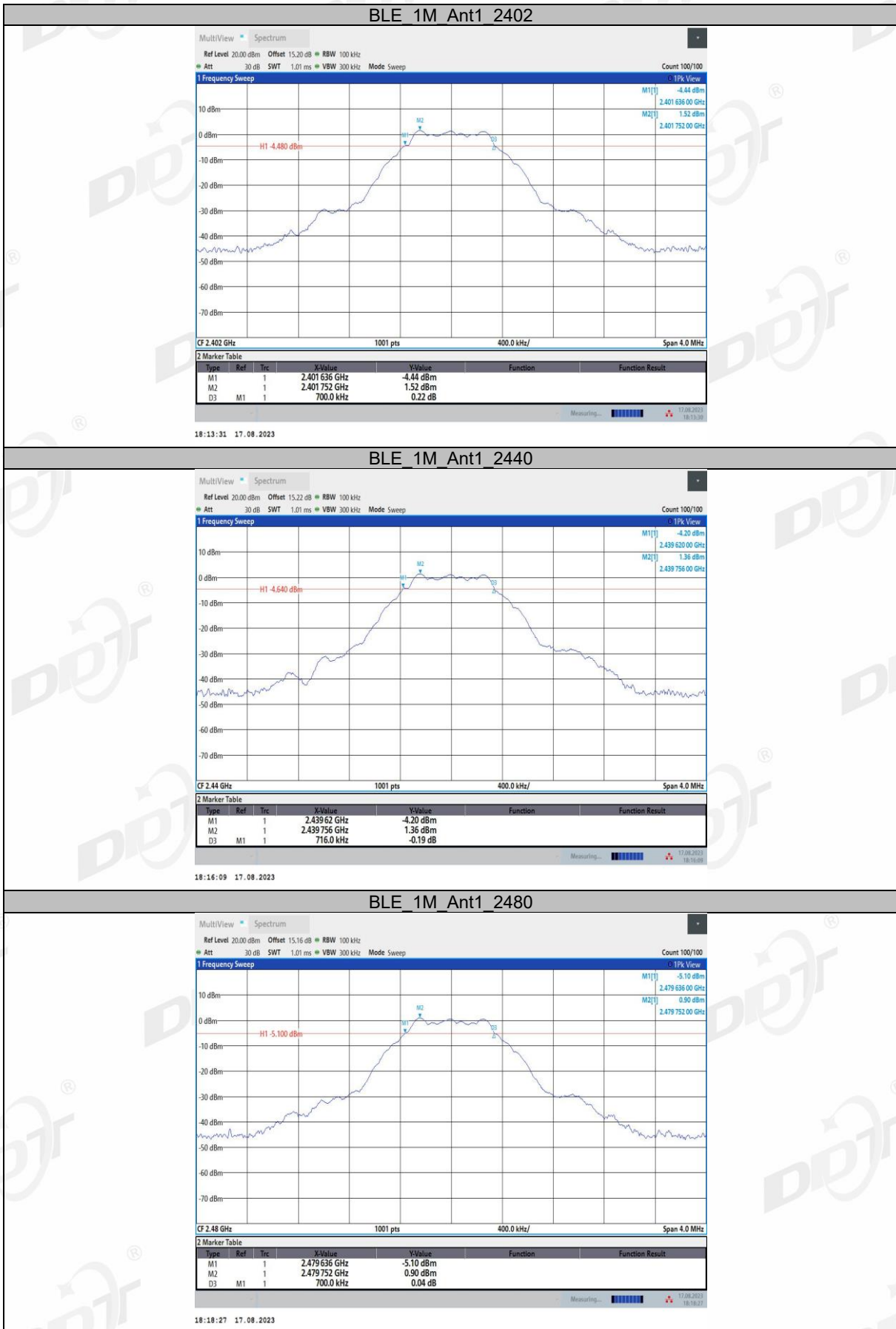

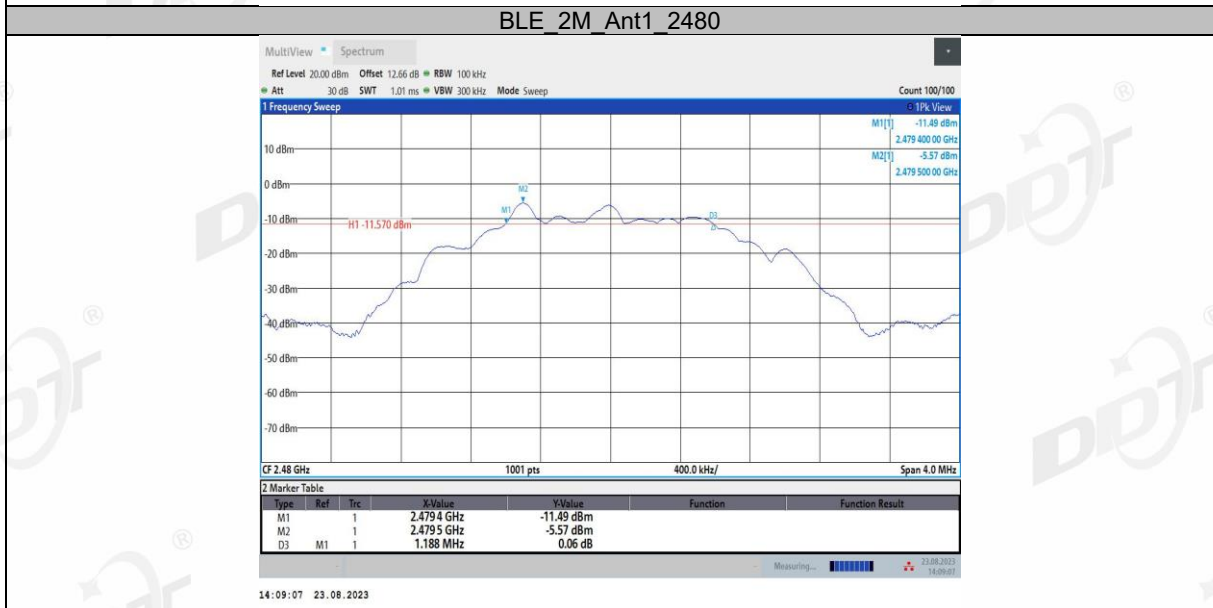

5. 99% Bandwidth

5.1. Block diagram of test setup

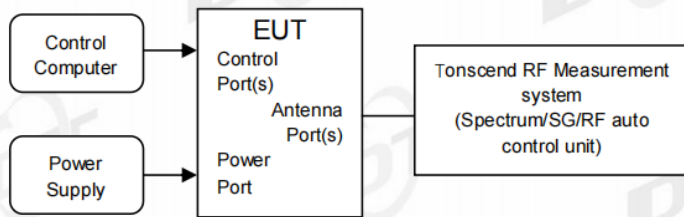

5.2. Limits

Just for Report.

5.3. Test procedure

- (1) The test according to ANSI C63.10-2013 clause 6.9.3.
- (2) Connect EUT's antenna output to spectrum analyzer by RF cable, the path loss was compensated to the results
- (3) Set the EUT as maximum power setting and enable the EUT transmit continuously
- (4) Use the following spectrum analyzer settings for the 99% Bandwidth:

RBW:	1% to 5% of the OBW
VBW:	approximately three times RBW
Span:	between 1.5 times and 5.0 times the OBW
Detector Mode:	Peak
Sweep time:	Auto
Trace mode	Max hold
- (5) Allow the trace to stabilize, measure the 99% bandwidth of signal, and record the results in the report.

5.4. Test Result

Test Mode	Antenna	Frequency [MHz]	OCB [MHz]	FL[MHz]	FH[MHz]
BLE_1M	Ant1	2402	1.022	2401.5016	2402.5239
		2440	1.029	2439.4952	2440.5245
		2480	1.034	2479.4915	2480.5254
BLE_2M	Ant1	2402	1.978	2401.0210	2402.9988
		2440	1.977	2439.0232	2440.9997
		2480	2.043	2478.9932	2481.0362

5.5. Test Graphs

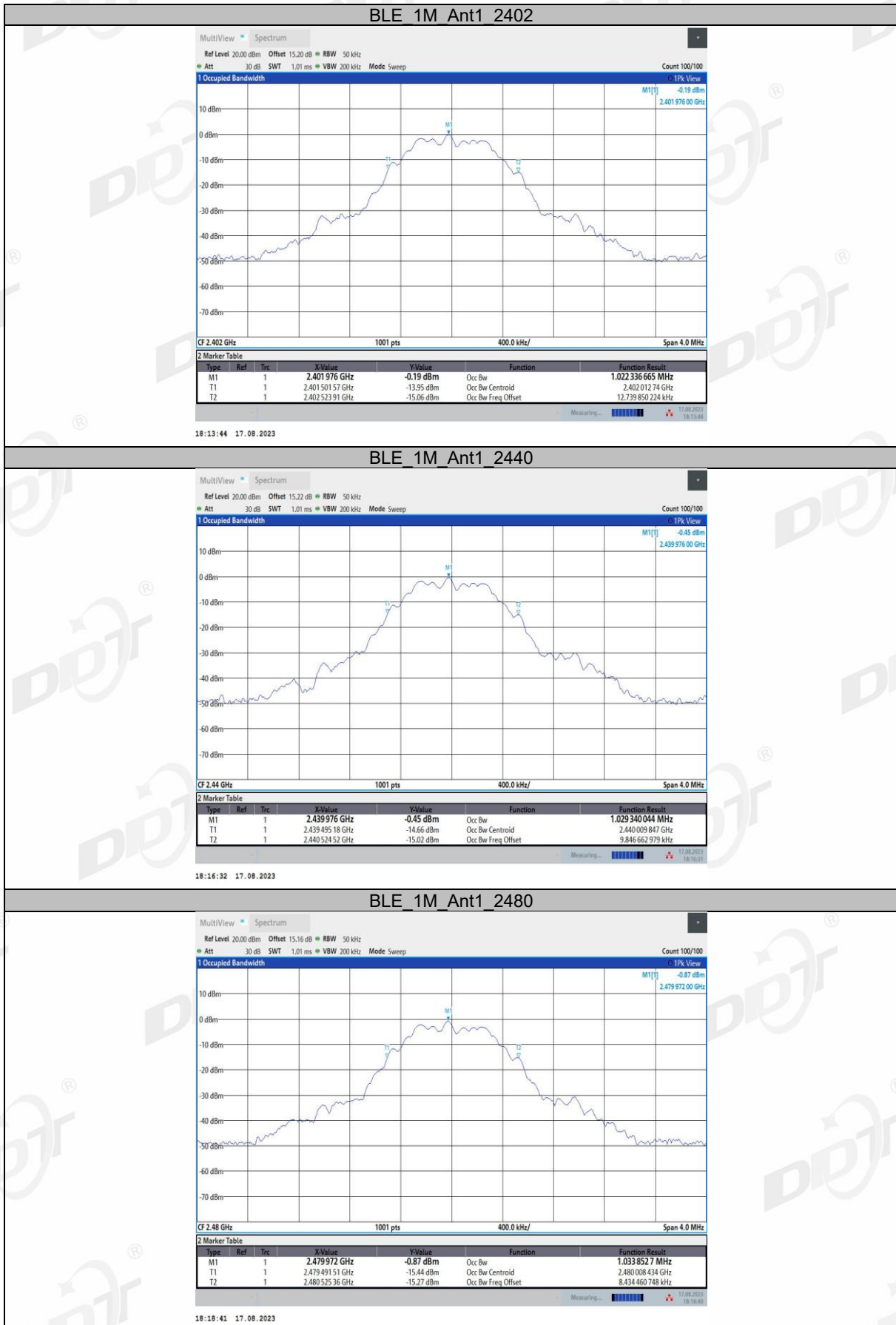

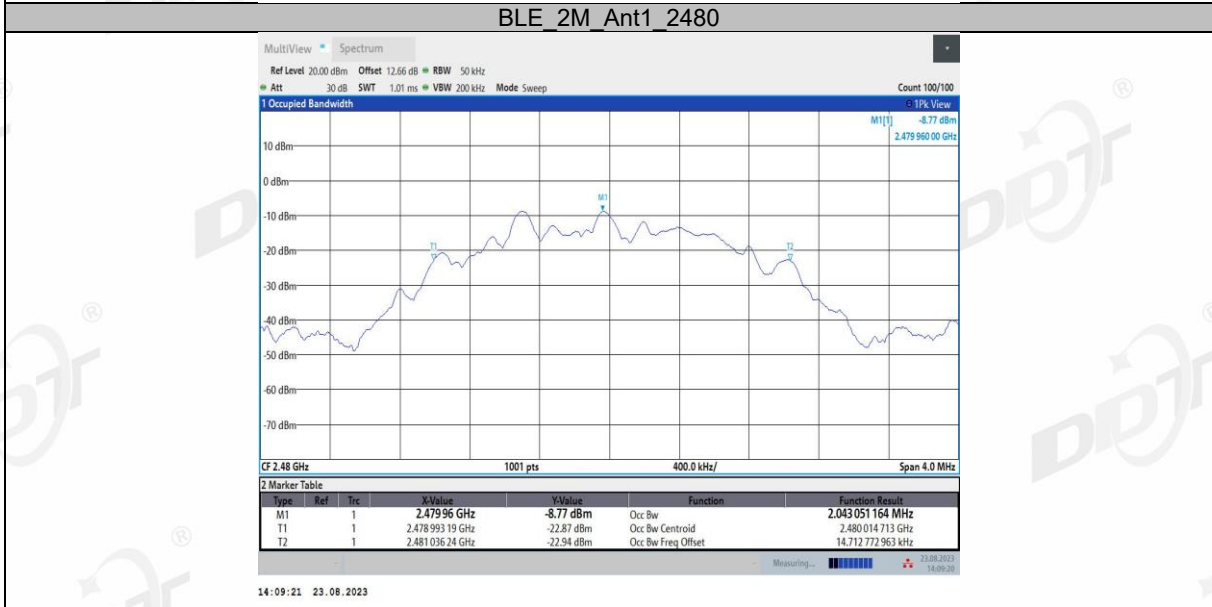
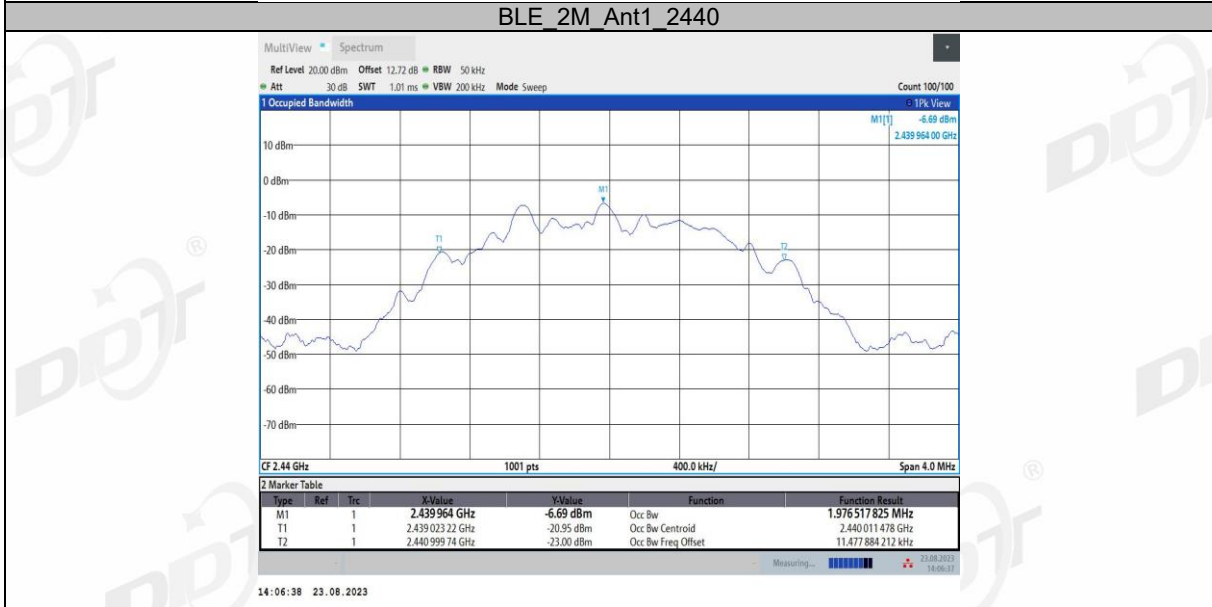

6. Maximum Peak Output Power

6.1. Block diagram of test setup

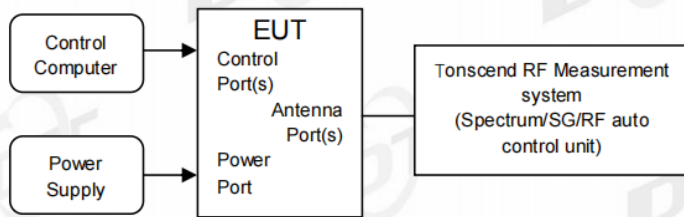

6.2. Limits

For systems using digital modulation in the 902-928 MHz, 2400-2483.5 MHz, and 5725-5850 MHz bands: 1 Watt. If transmitting antennas of directional gain greater than 6dBi are used, the conducted output power from the intentional radiator shall be reduced below the stated values as appropriate, by the amount in dB that the directional gain of the antenna exceeds 6 dBi, the e.i.r.p shall not exceed 4W.

6.3. Test procedure

- (1) The test according to ANSI C63.10-2013 clause 11.9.1.1.
- (2) Connect EUT's antenna output to spectrum analyzer by RF cable, the path loss was compensated to the results.
- (3) Set the EUT as maximum power setting and enable the EUT transmit continuously.
- (4) Use the following spectrum analyzer settings for the maximum peak output power measurement:

RBW:	≥DTS bandwidth
VBW:	≥3 x RBW
Span	≥3 x RBW
Detector Mode:	Peak
Sweep time:	Auto
Trace mode	Max hold

- (5) Allow the trace to stabilize, use peak marker function to determine the peak amplitude level.

6.4. Test result

Test Mode	Antenna	Frequency [MHz]	Conducted Peak Power[dBm]	Conducted Limit[dBm]	EIRP[dBm]	EIRP Limit[dBm]	Verdict
BLE_1M	Ant1	2402	2.22	≤30	1.96	≤36	PASS
		2440	1.99	≤30	1.73	≤36	PASS
		2480	1.56	≤30	1.30	≤36	PASS
BLE_2M	Ant1	2402	-3.29	≤30	-3.55	≤36	PASS
		2440	-2.95	≤30	-3.21	≤36	PASS
		2480	-4.69	≤30	-4.95	≤36	PASS

6.5. Test graphs

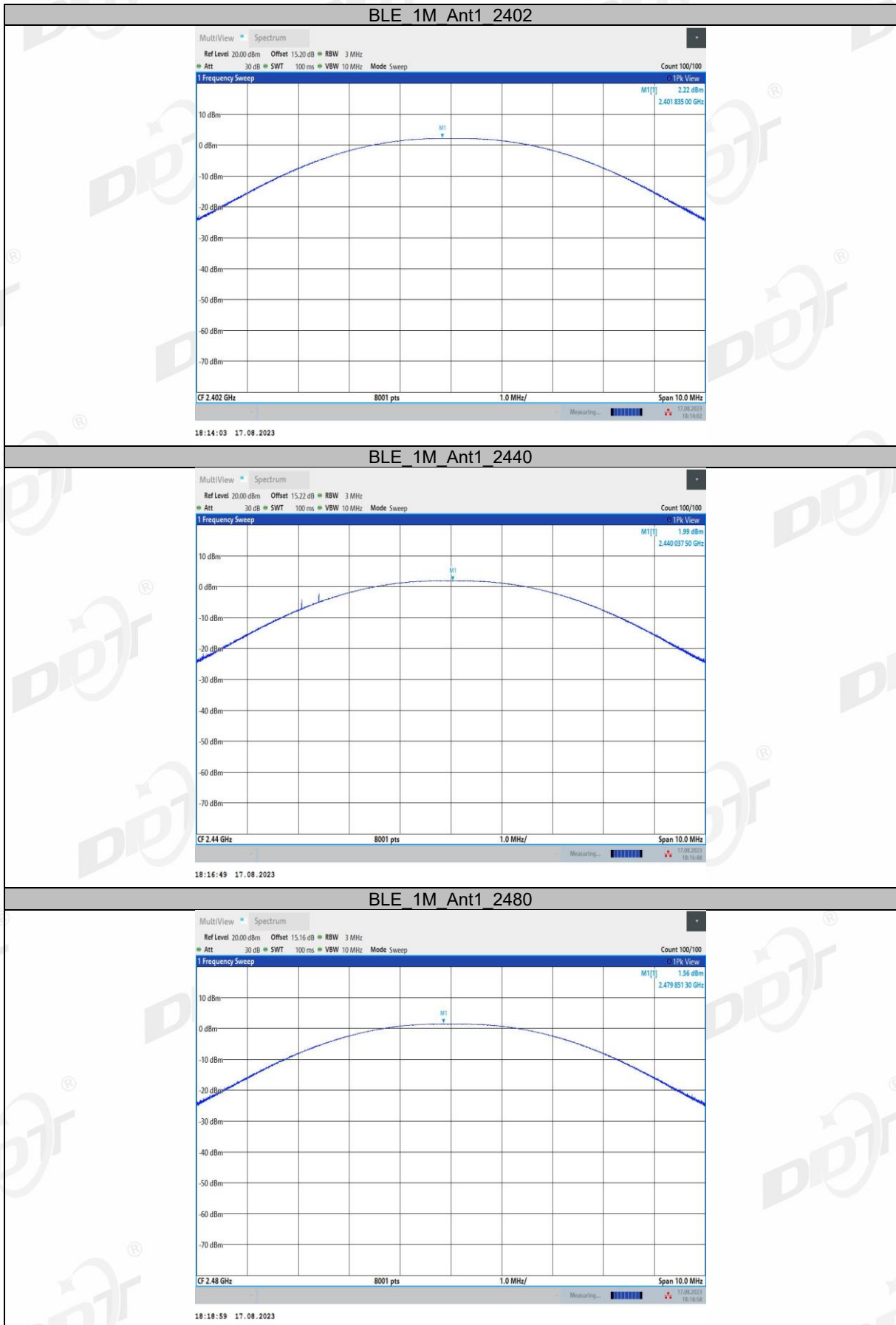

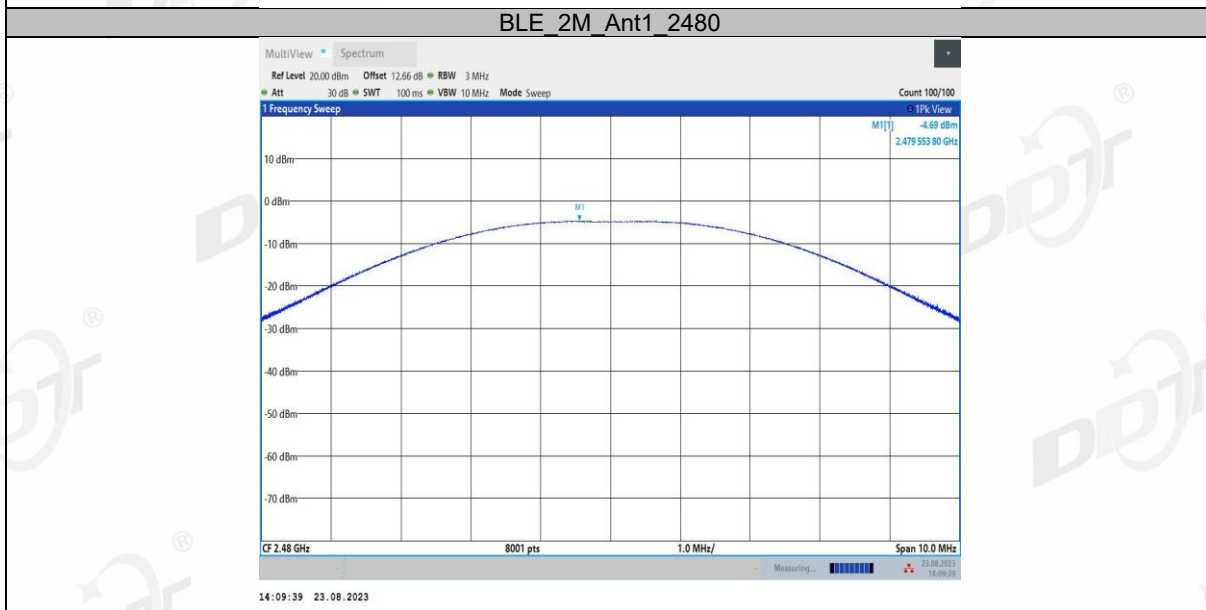
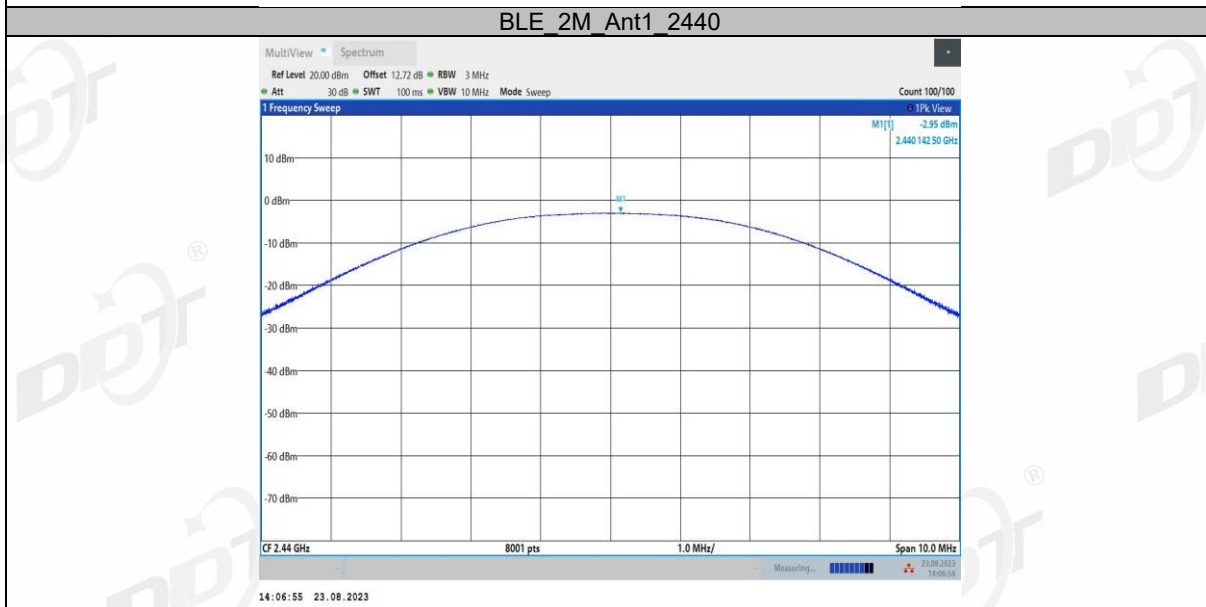

7. Power Spectral Density

7.1. Block diagram of test setup

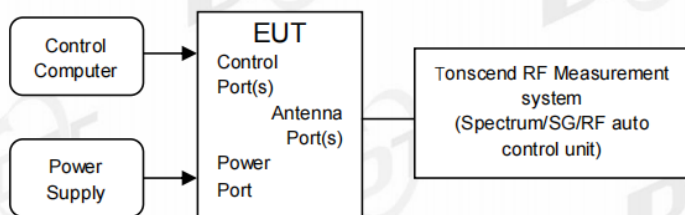

7.2. Limits

For digitally modulated systems, the power spectral density conducted from the intentional radiator to the antenna shall not be greater than 8 dBm in any 3 kHz band during any time interval of continuous transmission.

7.3. Test procedure

- (1) The test according to ANSI C63.10-2013 clause 11.10.2.
- (2) Connect EUT's antenna output to spectrum analyzer by RF cable, the path loss was compensated to the results.
- (3) Set the EUT as maximum power setting and enable the EUT transmit continuously.
- (4) Use the following spectrum analyzer settings for Power Spectral Density measurement:

Center frequency	DTS Channel center frequency
RBW:	$3 \text{ kHz} \leq \text{RBW} \leq 100 \text{ kHz}$
VBW:	$\geq 3\text{RBW}$
Span	1.5 times the DTS bandwidth
Detector Mode:	Peak
Sweep time:	Auto
Trace mode	Max hold
- (5) Allow the trace to stabilize, use the peak marker function to determine the maximum amplitude level within the RBW.

If measured value exceeds limit, reduce RBW (no less than 3 kHz) and repeat.

7.4. Test result

Test Mode	Antenna	Frequency [MHz]	Result [dBm/3kHz]	Limit [dBm/3kHz]	Verdict
BLE_1M	Ant1	2402	-14.58	≤ 8.00	PASS
		2440	-14.84	≤ 8.00	PASS
		2480	-15.76	≤ 8.00	PASS
BLE_2M	Ant1	2402	-25.49	≤ 8.00	PASS
		2440	-25.10	≤ 8.00	PASS
		2480	-27.05	≤ 8.00	PASS

7.5. Test graphs

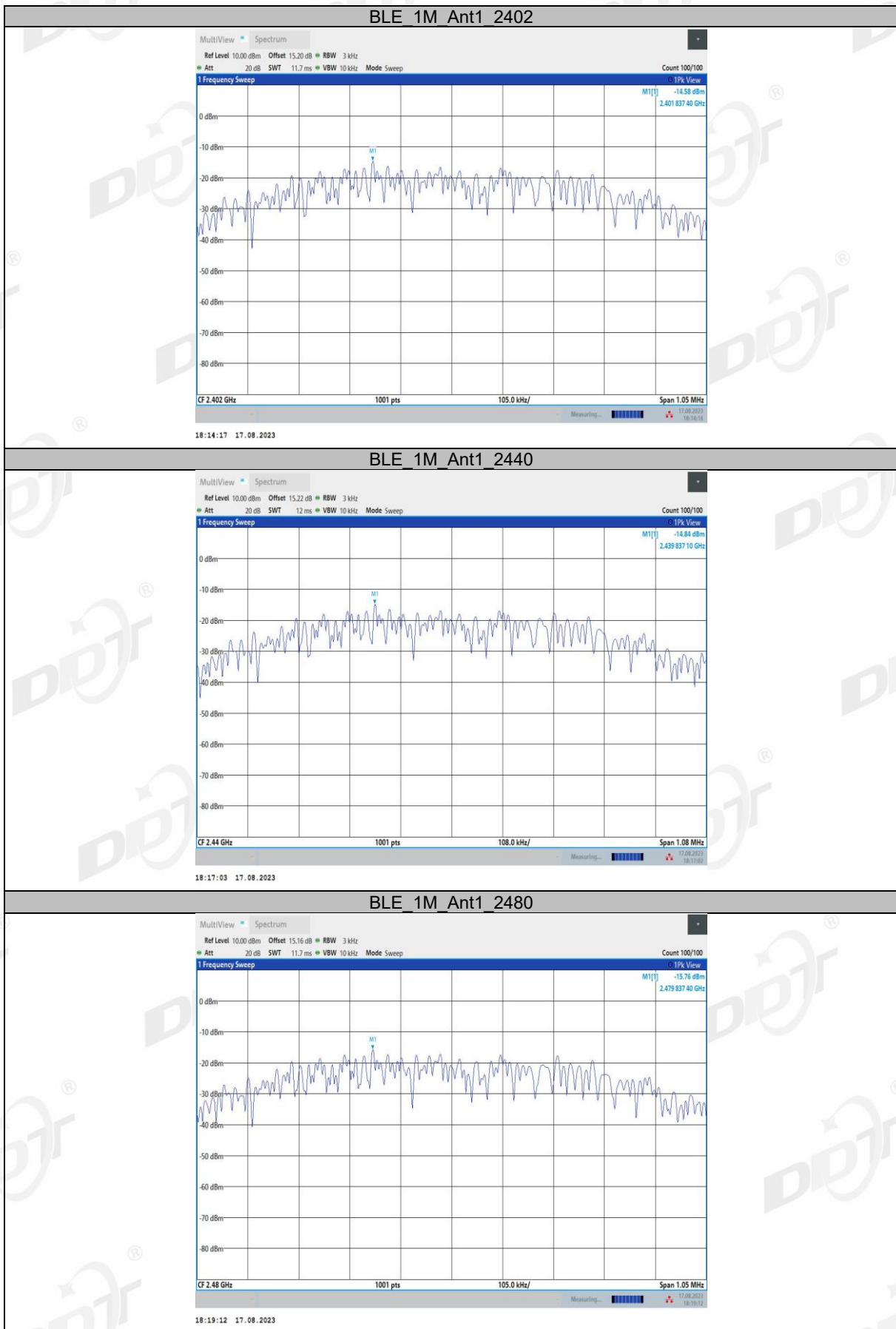

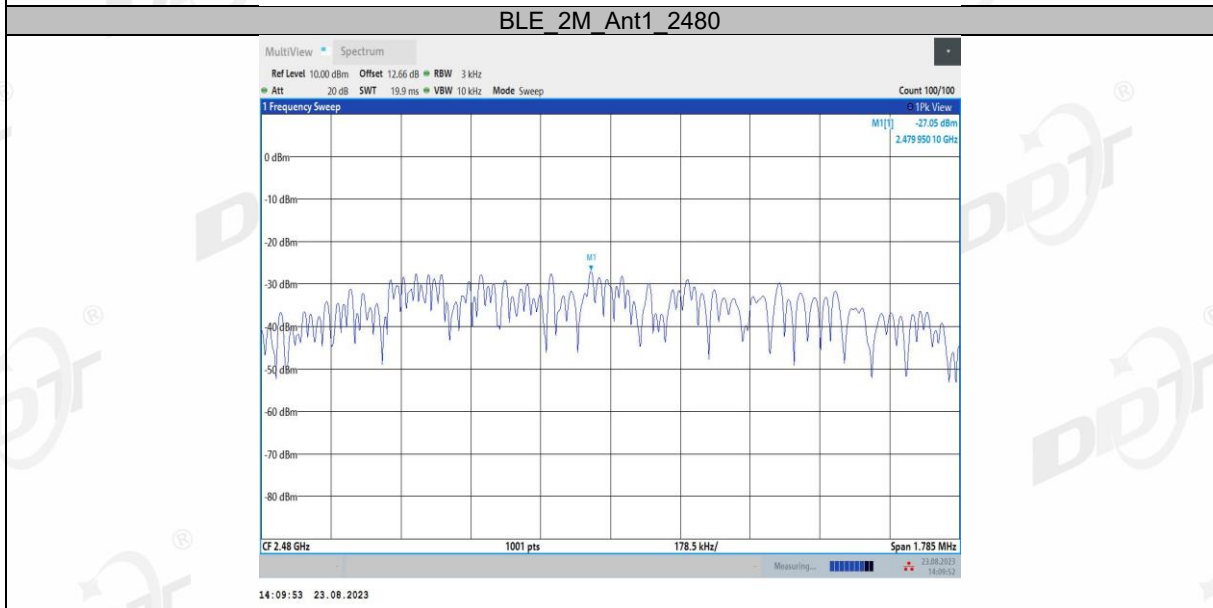
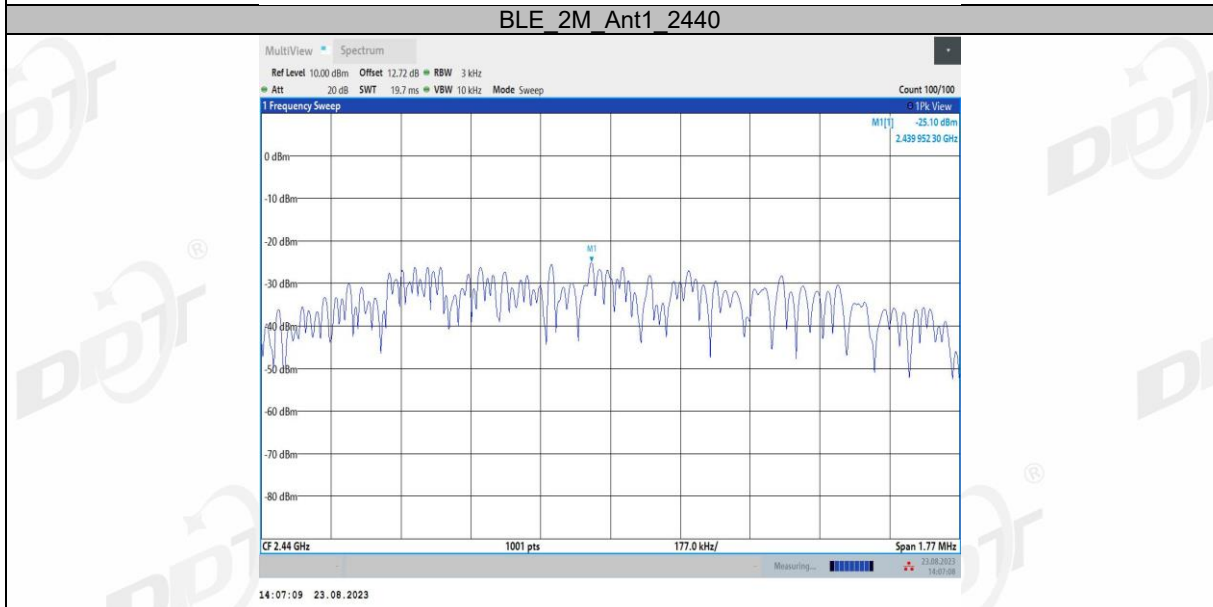
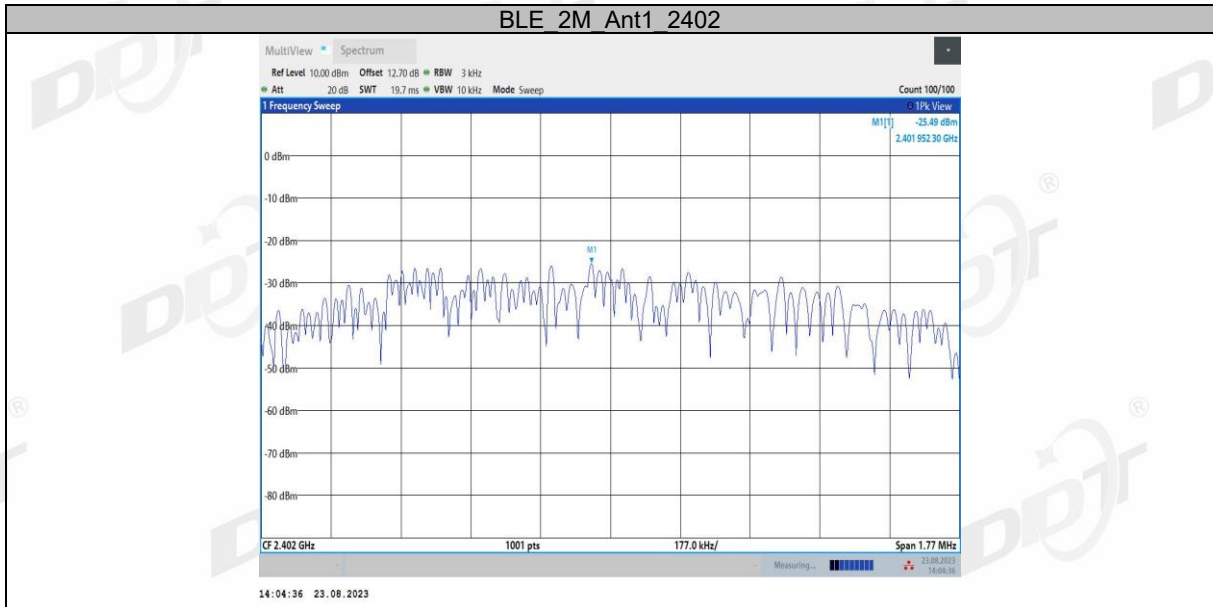

8. Band Edge Compliance (Conducted Method)

8.1. Block diagram of test setup

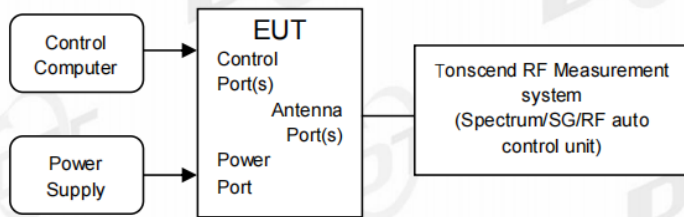

8.2. Limits

In any 100 kHz bandwidth outside the frequency bands in which the spread spectrum intentional radiator is operating, the radio frequency power that is produced by the intentional radiator shall be at least 20 dB below that in the 100 kHz bandwidth within the band that contains the highest level of the desired power.

8.3. Test procedure

(1) Connect EUT's antenna output to spectrum analyzer by RF cable.

(2) Establish a reference level by using the following procedure:

RBW:	100 kHz
VBW:	300 kHz
Span	Encompass frequency range to be measured
Detector Mode:	Peak
Sweep time:	Auto
Trace mode	Max hold

(3) Allow the trace to stabilize, use the peak marker function to determine the maximum peak power level to establish the reference level.

(4) Then mark the maximum amplitude of all unwanted emissions outside of the authorized frequency band.

8.4. Test result

EUT Set Mode	CH or Frequency	Measured Range	Verdict
GFSK 1M	CH0	2.310 GHz - 2.410 GHz	Pass
	CH39	2.470 GHz - 2.500 GHz	Pass
GFSK 2M	CH0	2.310 GHz - 2.410 GHz	Pass
	CH39	2.470 GHz - 2.500 GHz	Pass

8.5. Test graphs

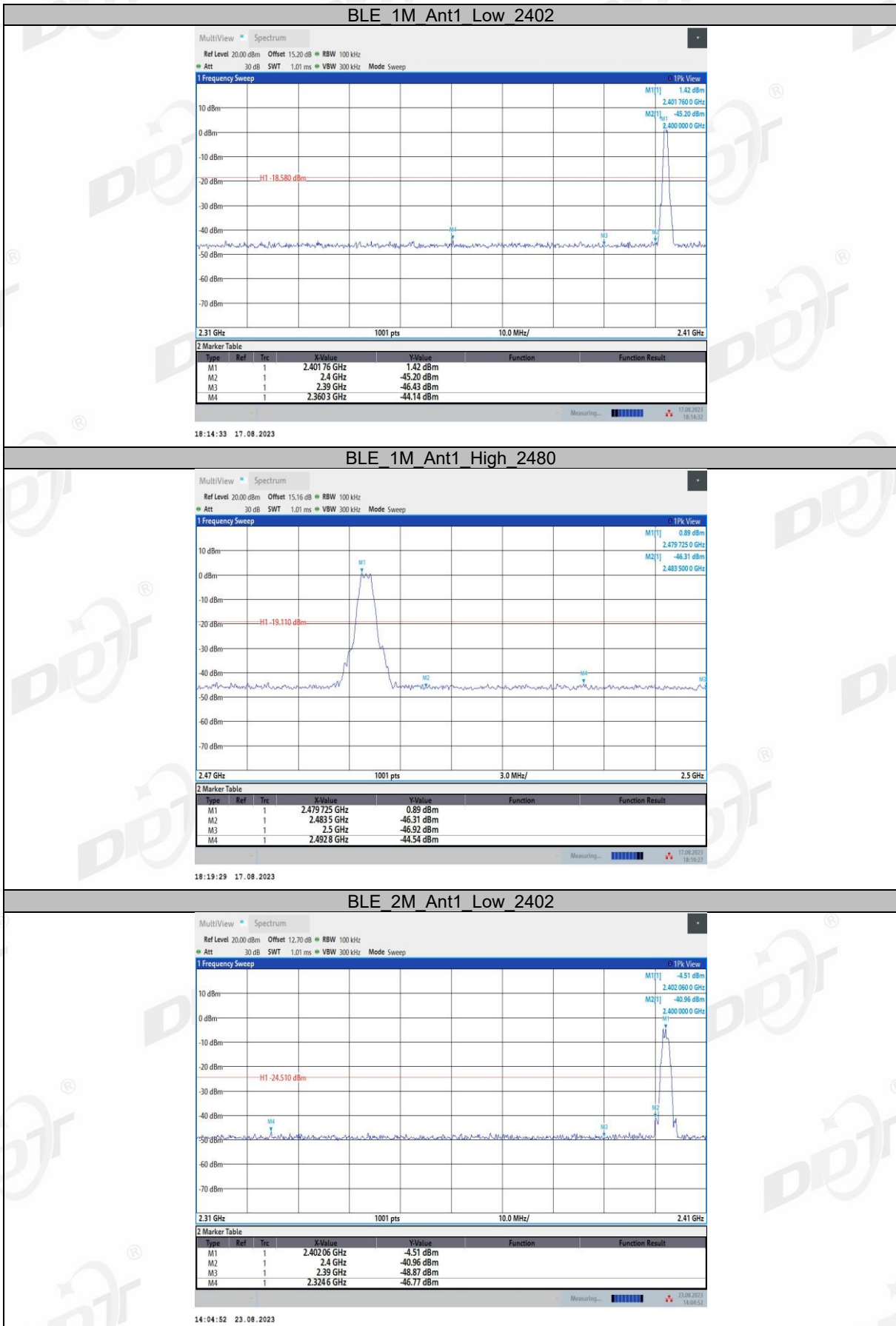



9. RF Conducted Spurious Emissions

9.1. Block diagram of test setup

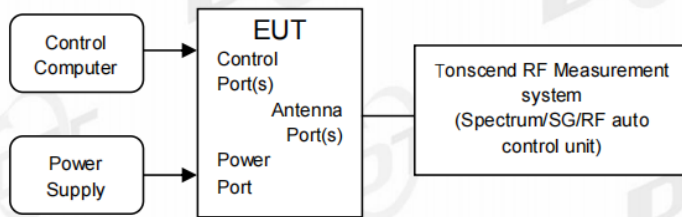

9.2. Limits

In any 100 kHz bandwidth outside the frequency bands in which the spread spectrum intentional radiator is operating, the radio frequency power that is produced by the intentional radiator shall be at least 20 dB below that in the 100 kHz bandwidth within the band that contains the highest level of the desired power.

9.3. Test procedure

- (1) Connect EUT's antenna output to spectrum analyzer by RF cable.
- (2) Establish a reference level by using the following procedure:

Center frequency	Test frequency
RBW:	100 kHz
VBW:	300 kHz
Span	Wide enough to capture the peak level of the in-band emission
Detector Mode:	Peak
Sweep time:	Auto
Trace mode	Max hold

- (3) Allow the trace to stabilize, use the peak marker function to determine the maximum peak power level to establish the reference level.

- (4) Set the spectrum analyzer as follows:

RBW:	100 kHz
VBW:	300 kHz
Span	Encompass frequency range to be measured
Number of measurement points	$\geq \text{Span}/\text{RBW}$
Detector Mode:	Peak
Sweep time:	Auto
Trace mode	Max hold

Allow the trace to stabilize, use the peak marker function to determine the maximum amplitude of all unwanted emissions outside of the authorized frequency band

9.4. Test result

Mode	Freq. (MHz)	Verdict
GFSK 1M	2402	Pass
	2440	Pass
	2480	Pass
GFSK 2M	2402	Pass
	2440	Pass
	2480	Pass

9.5. Test graphs



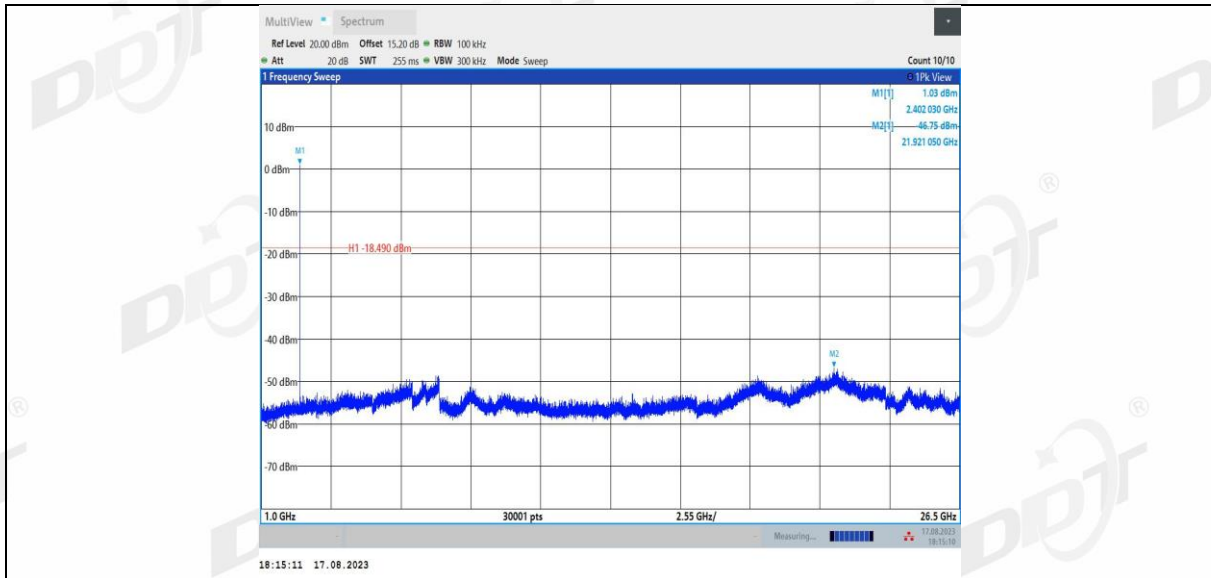

BLE 1M Ant1 2440 0~Reference

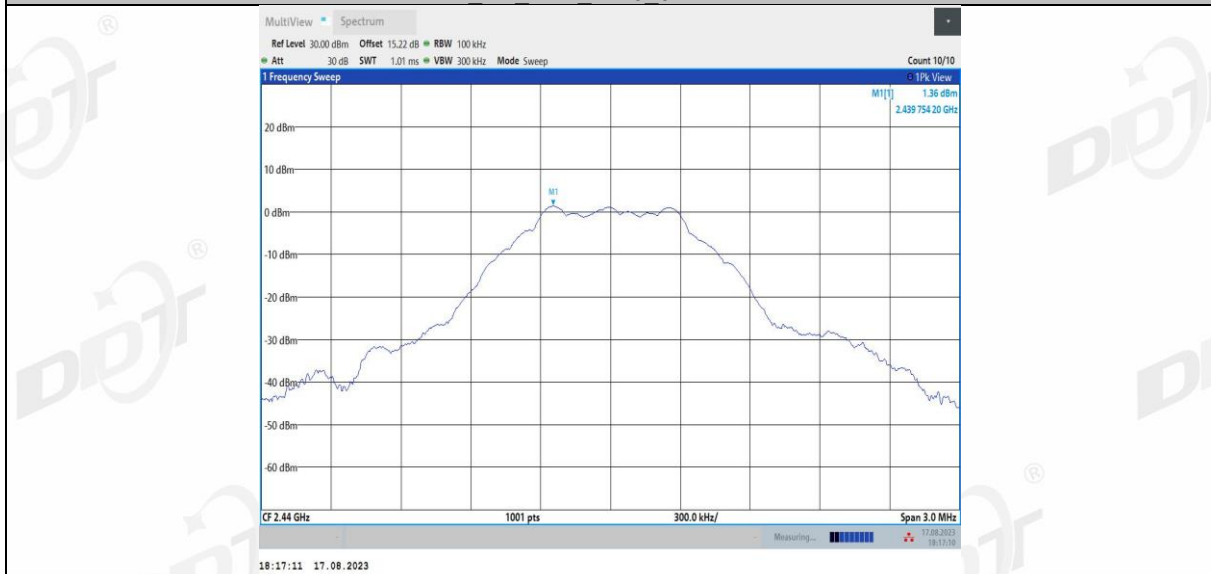

BLE 1M Ant1 2440 30~1000

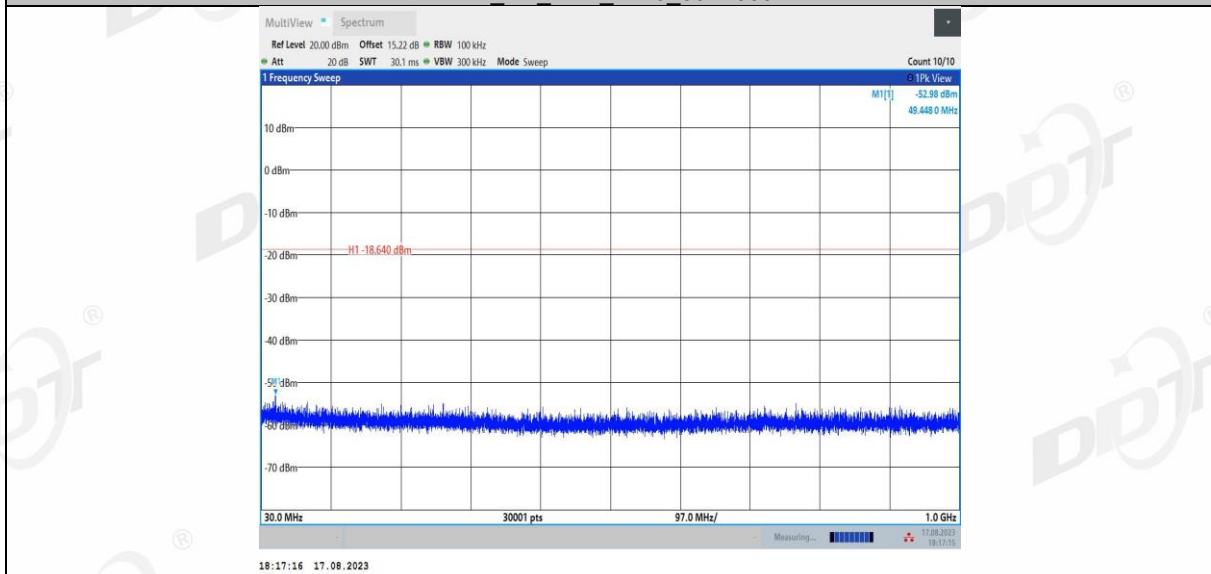

BLE 1M Ant1 2440 1000~26500

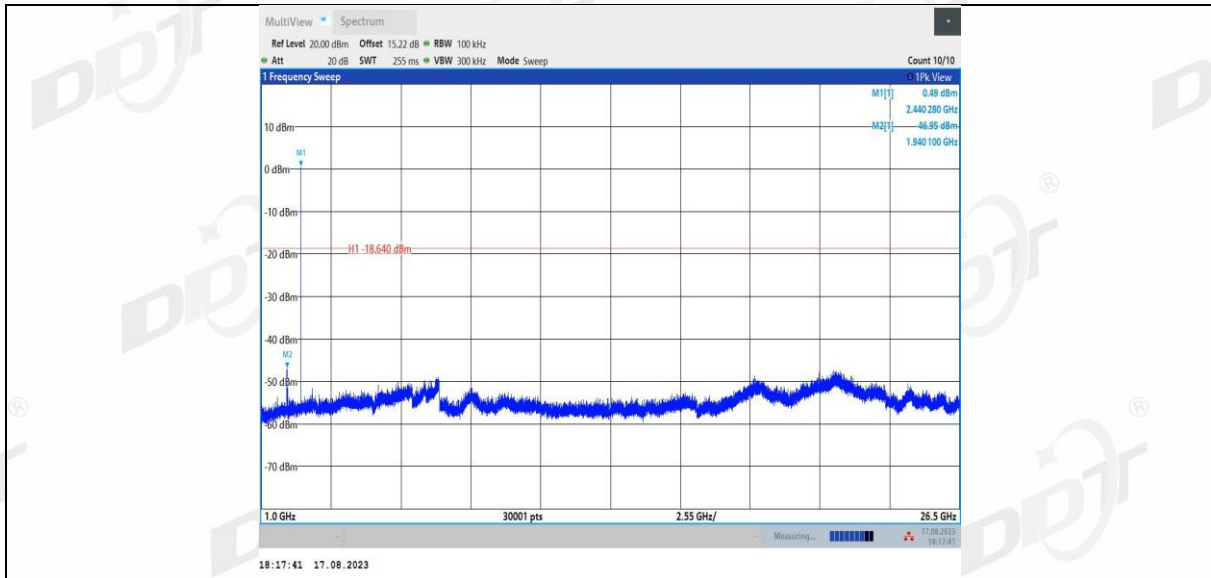

BLE 1M Ant1 2480 0~Reference

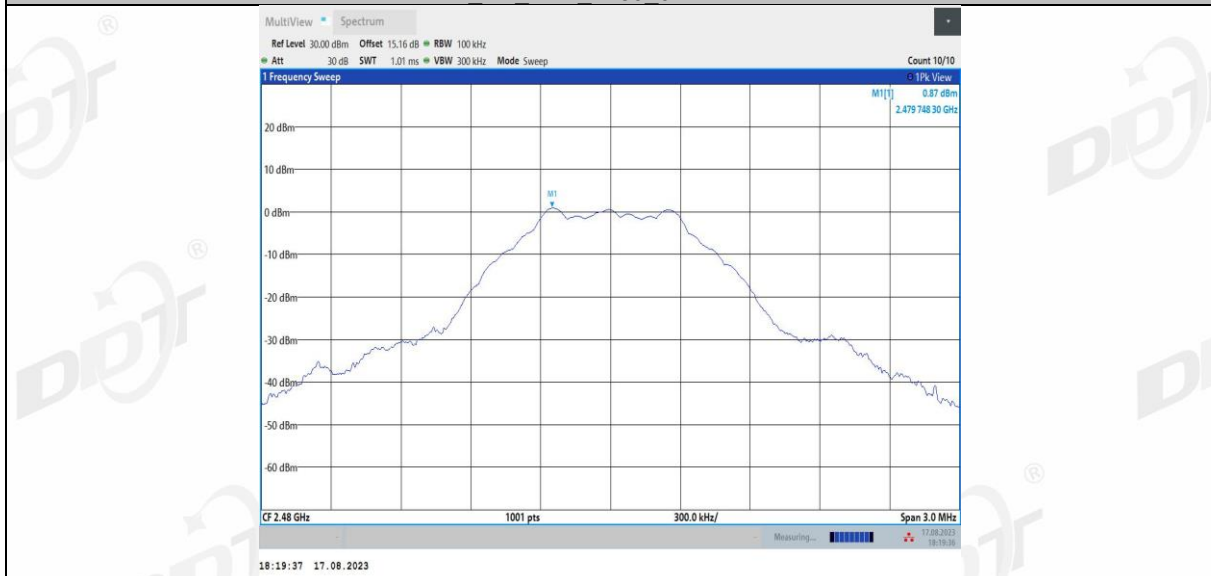

BLE 1M Ant1 2480 30~1000

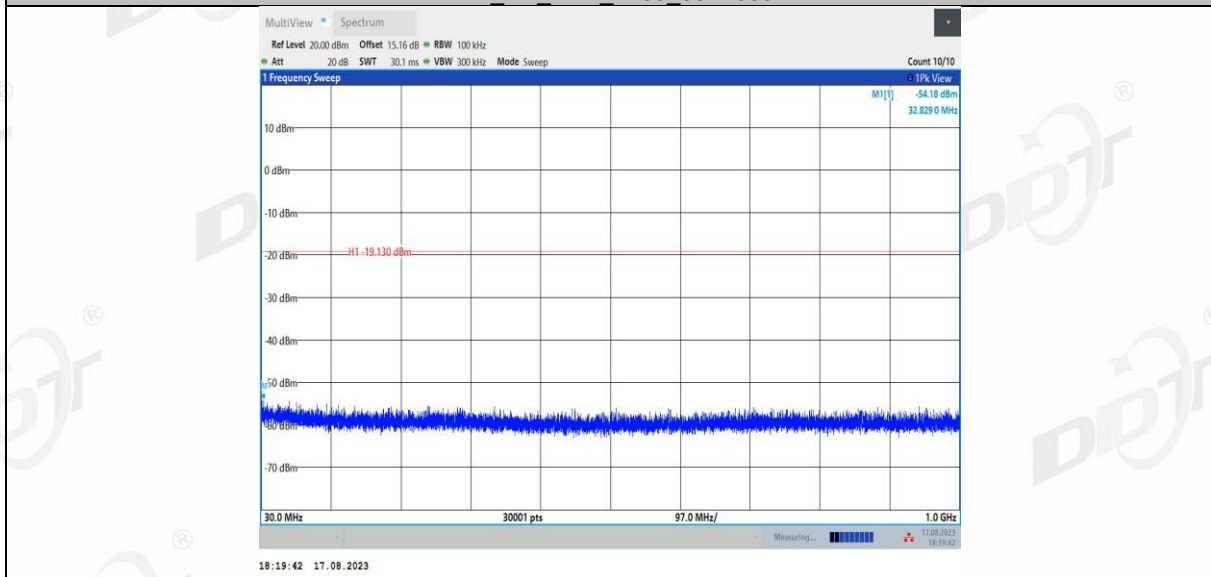

BLE 1M Ant1 2480 1000~26500

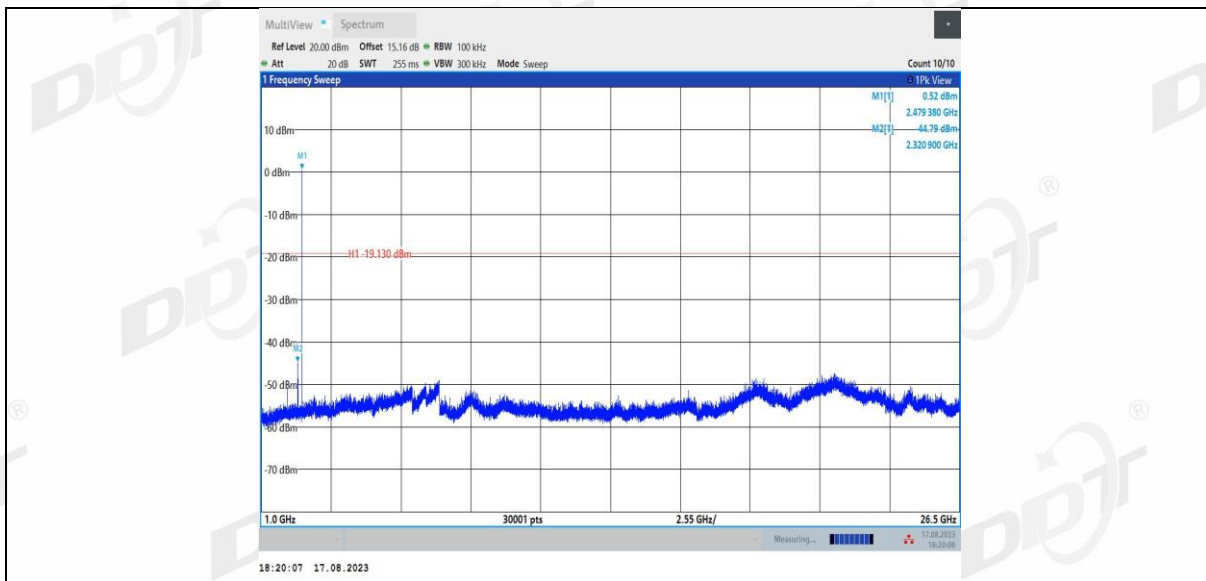

BLE 2M Ant1 2402 0~Reference

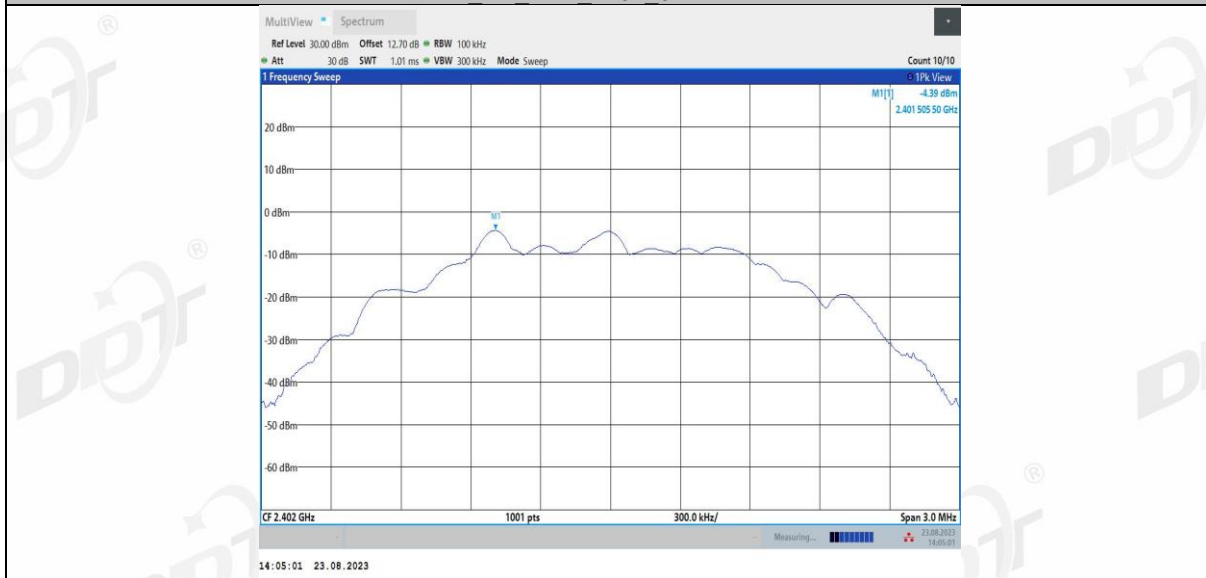

BLE 2M Ant1 2402 30~1000

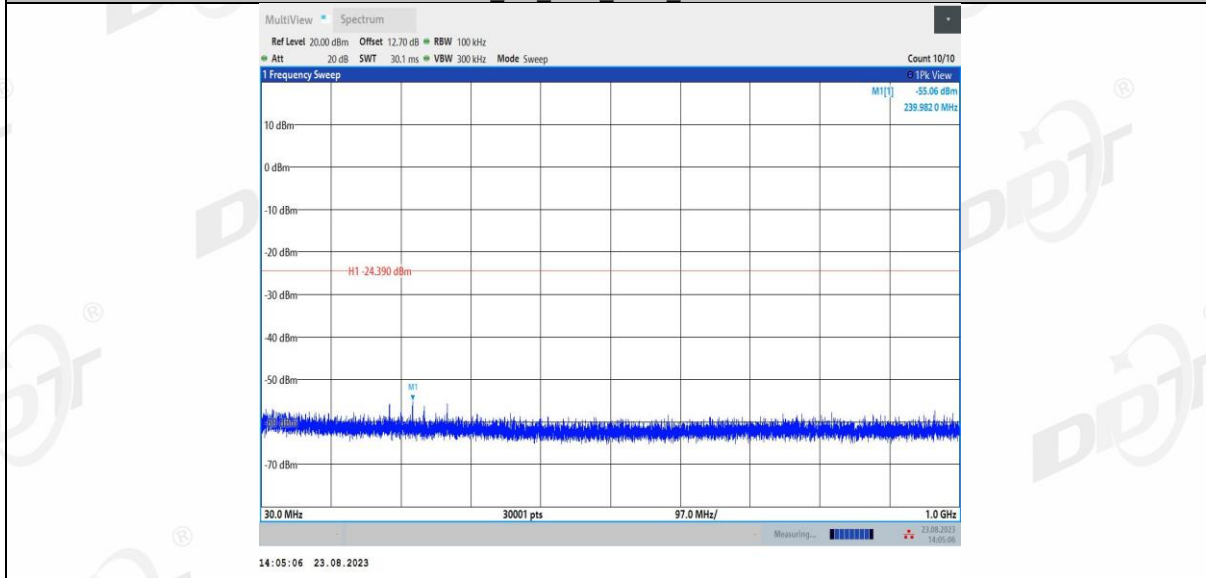

BLE 2M Ant1 2402 1000~26500

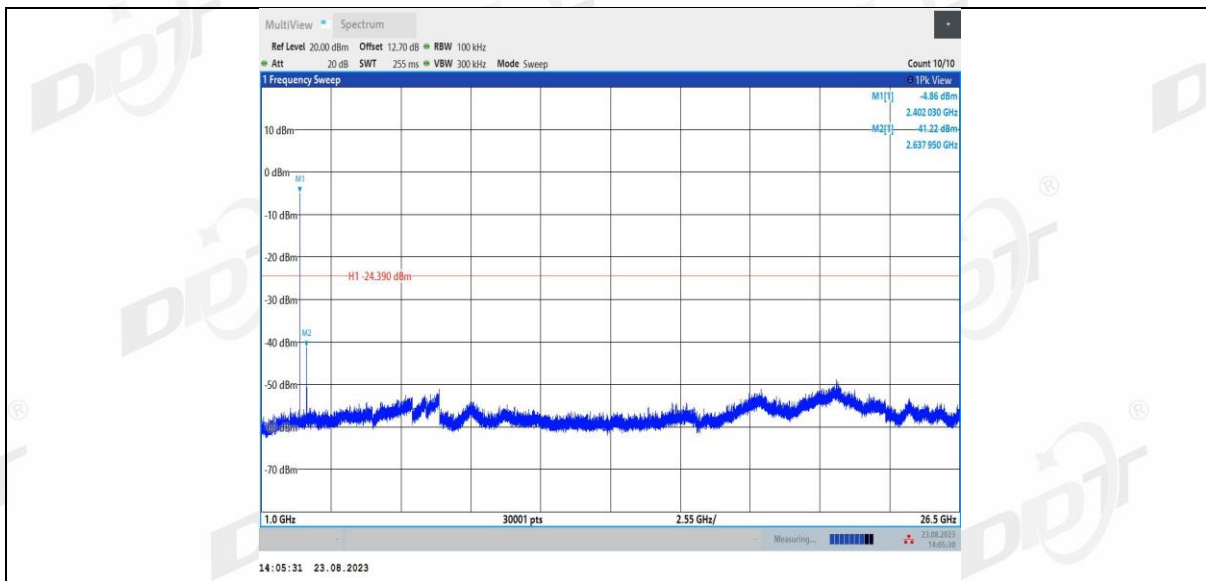

BLE 2M Ant1 2440 0~Reference

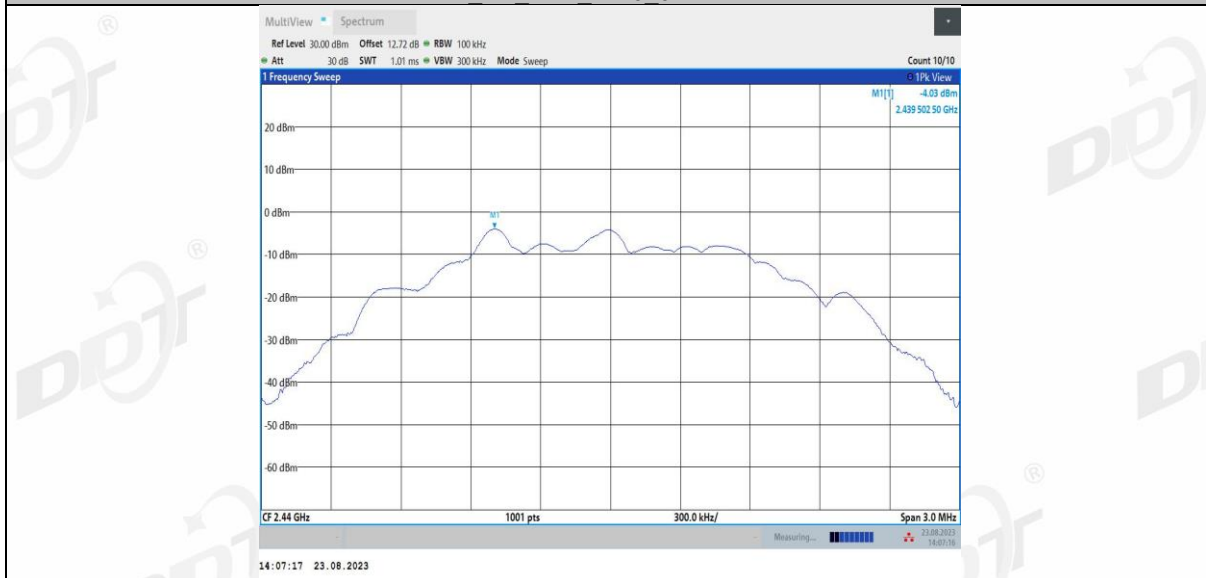

BLE 2M Ant1 2440 30~1000

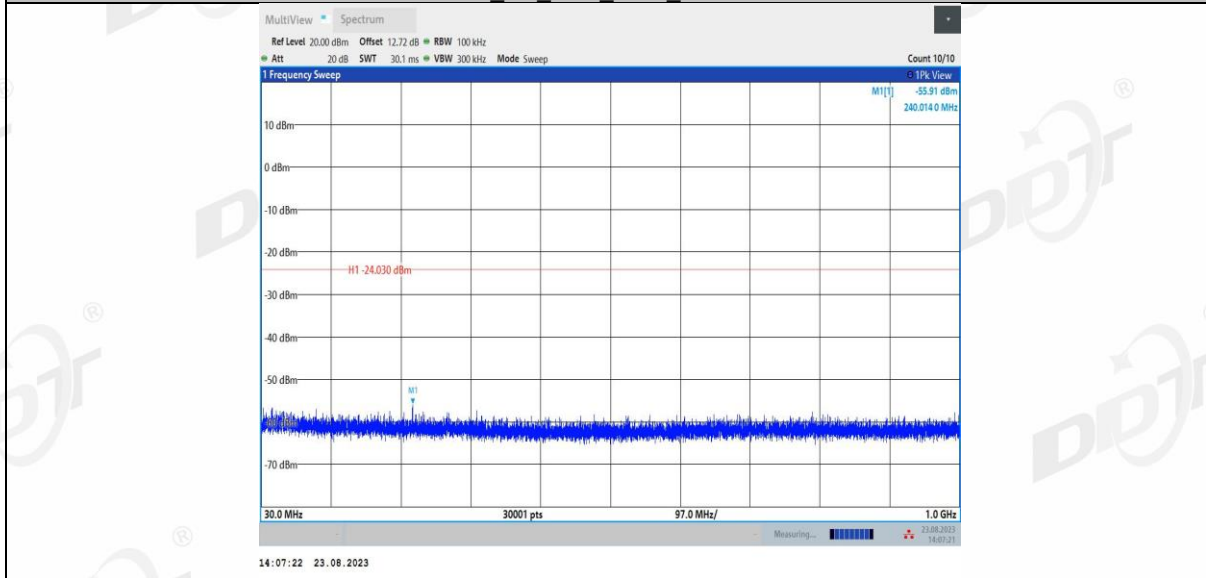

BLE 2M Ant1 2440 1000~26500

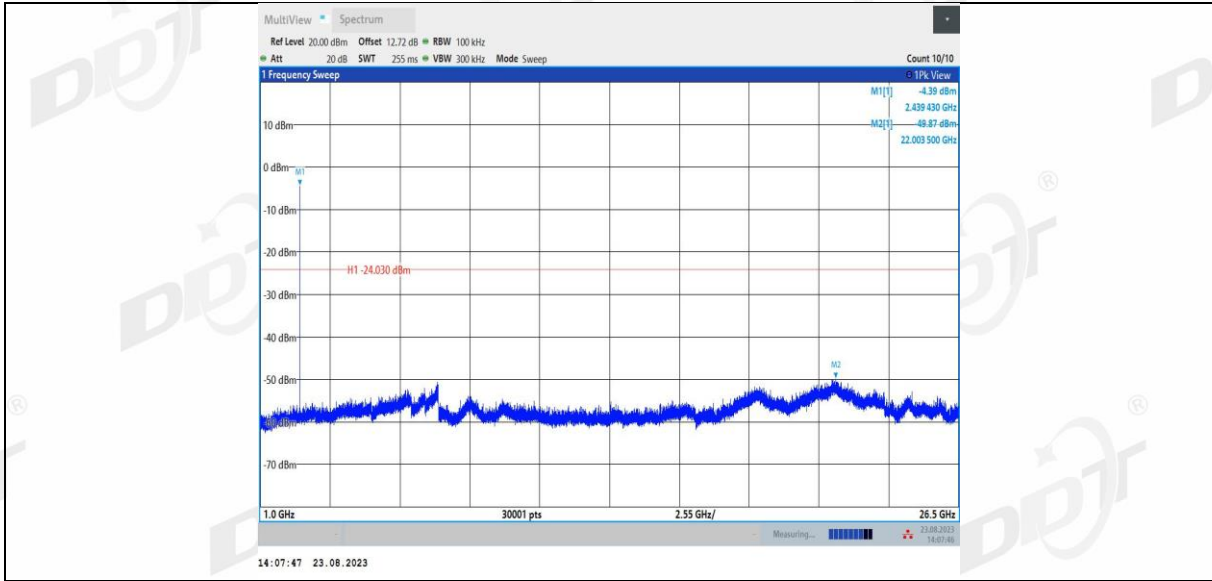

BLE 2M Ant1 2480 0~Reference

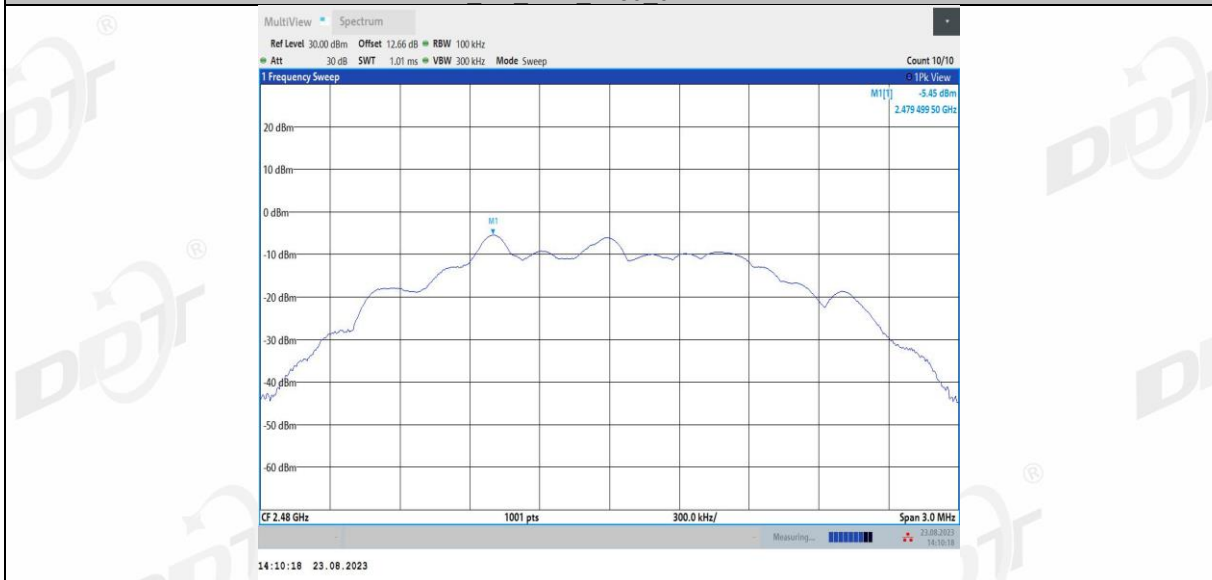

BLE 2M Ant1 2480 30~1000

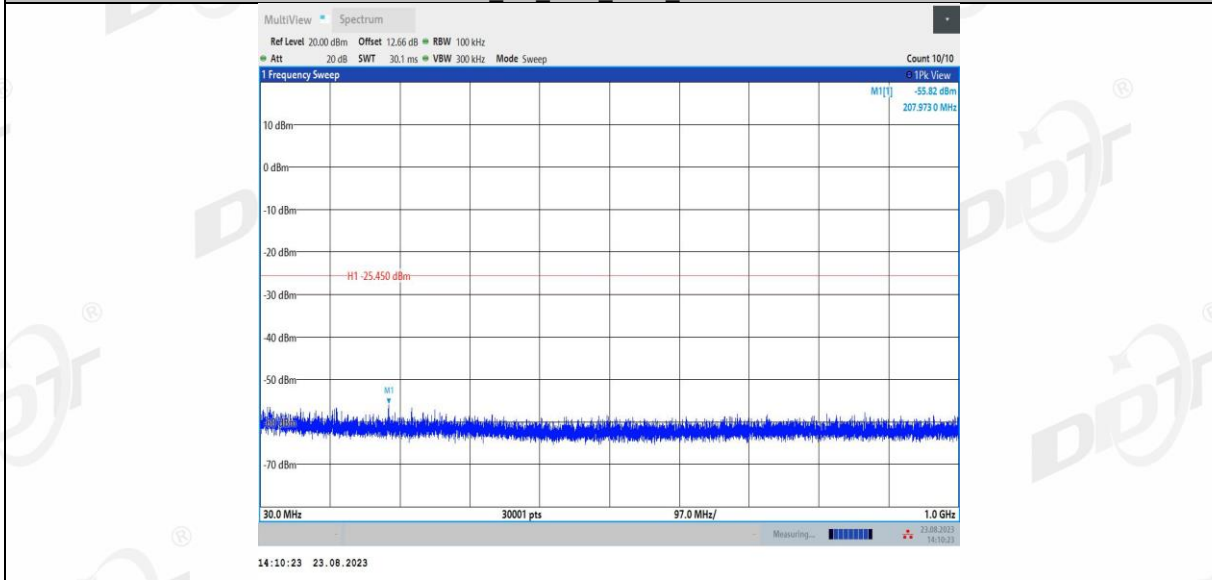

BLE 2M Ant1 2480 1000~26500

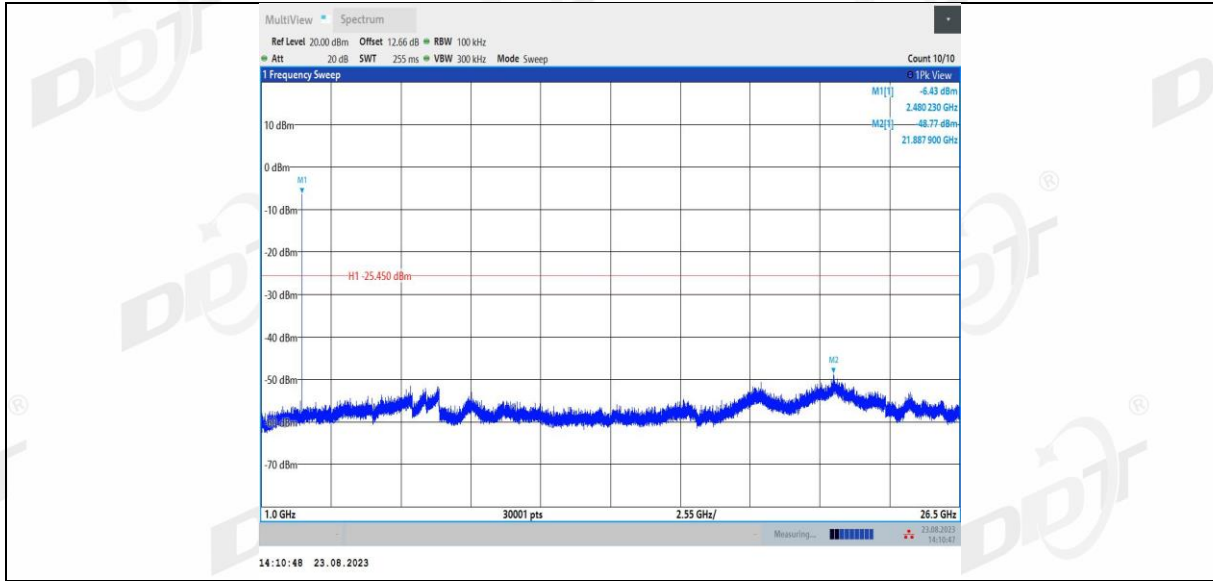

10. Duty Cycle

10.1. Block diagram of test setup

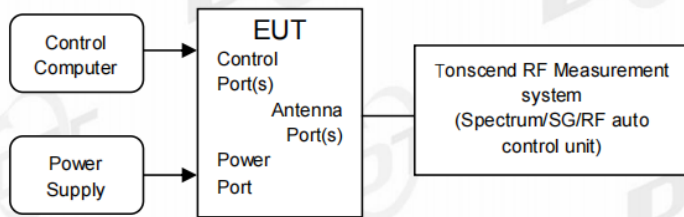

10.2. Limit

Just for Report.

10.3. Test procedure

- (1) Connected the EUT's antenna port to the Spectrum Analyzer by suitable attenuator, The cable loss and attenuator loss have been put into spectrum analyzer as amplitude offset.

set the Spectrum Analyzer as below:

Centre Frequency: The centre frequency of the middle hopping channel.

Resolution BW: 10 MHz.

Video BW: 10 MHz.

Span: Zero span.

Detector: Peak.

Trace Mode: Clear Write.

Sweep: Video Trigger

- (2) When the trace is complete, measure the sending time of 1 burst and the duty cycle of 1 burst cycle.

- (3) Calculate dwell time follow below formula:

$$\text{Duty cycle} = \text{Pulse's on time} / \text{Burst cycle}$$

10.4. Test result

Test Mode	Antenna	Frequency [MHz]	ON Time [ms]	Period [ms]	Duty Cycle [%]	Duty Cycle Factor[dB]
BLE_1M	Ant1	2402	0.17	0.62	27.42	5.62
		2440	0.18	0.63	28.57	5.44
		2480	0.18	0.63	28.57	5.44
BLE_2M	Ant1	2402	0.10	0.63	15.87	7.99
		2440	0.10	0.63	15.87	7.99
		2480	0.17	0.62	27.42	5.62

10.5. Test graphs



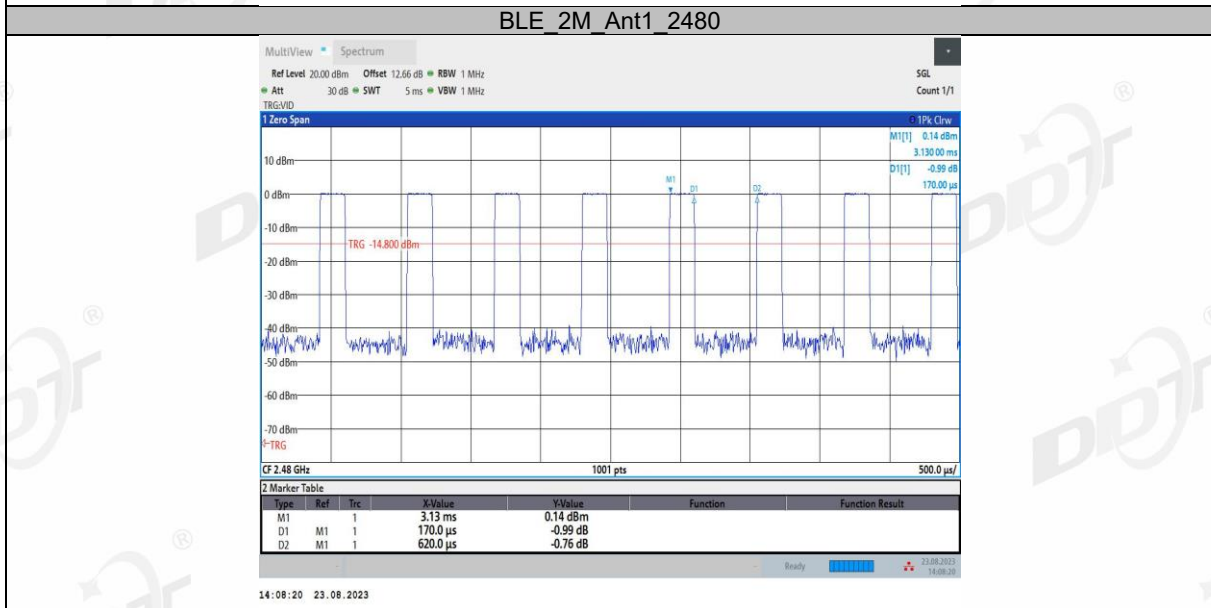
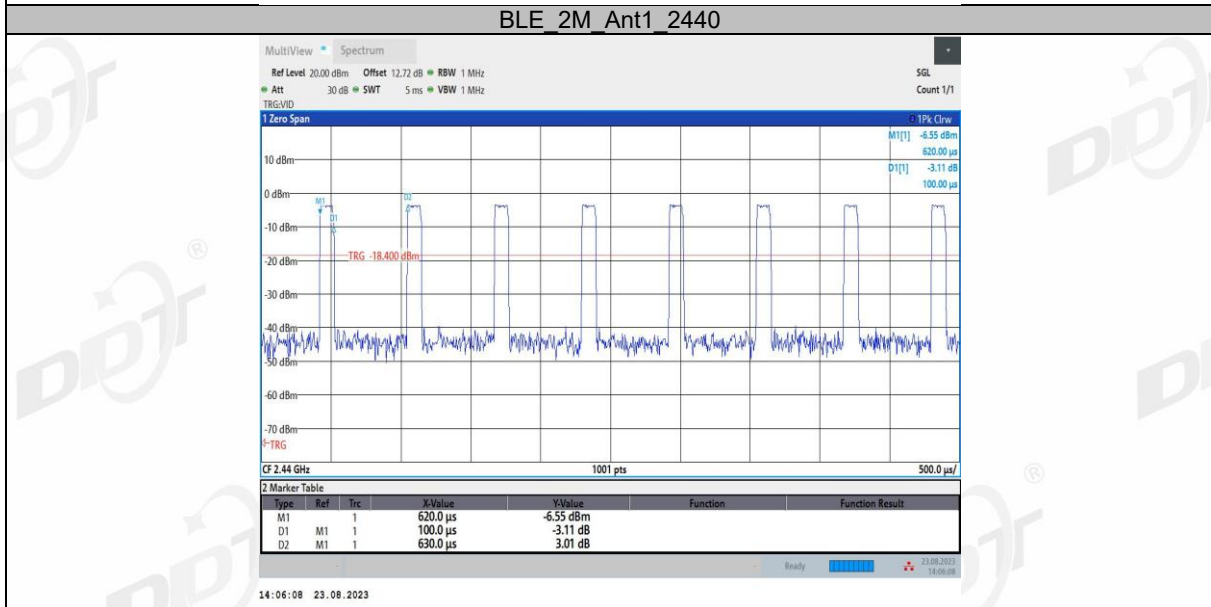
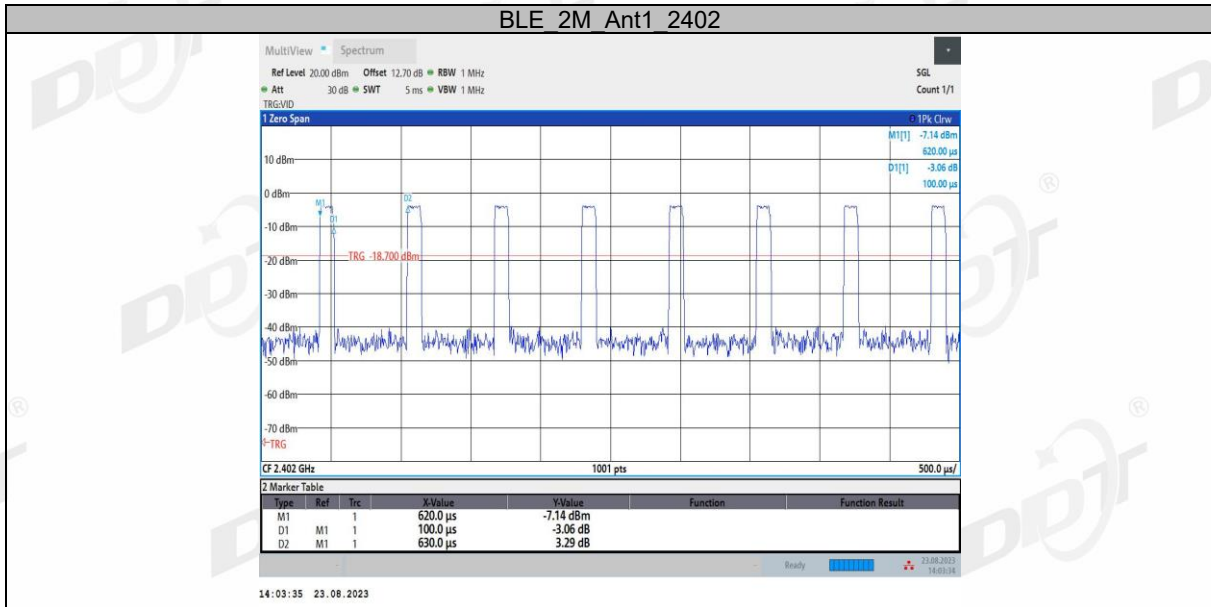

11. Radiated Emission

11.1. Block diagram of test setup

In 3 m Anechoic Chamber, test setup diagram for 9 kHz - 30 MHz:

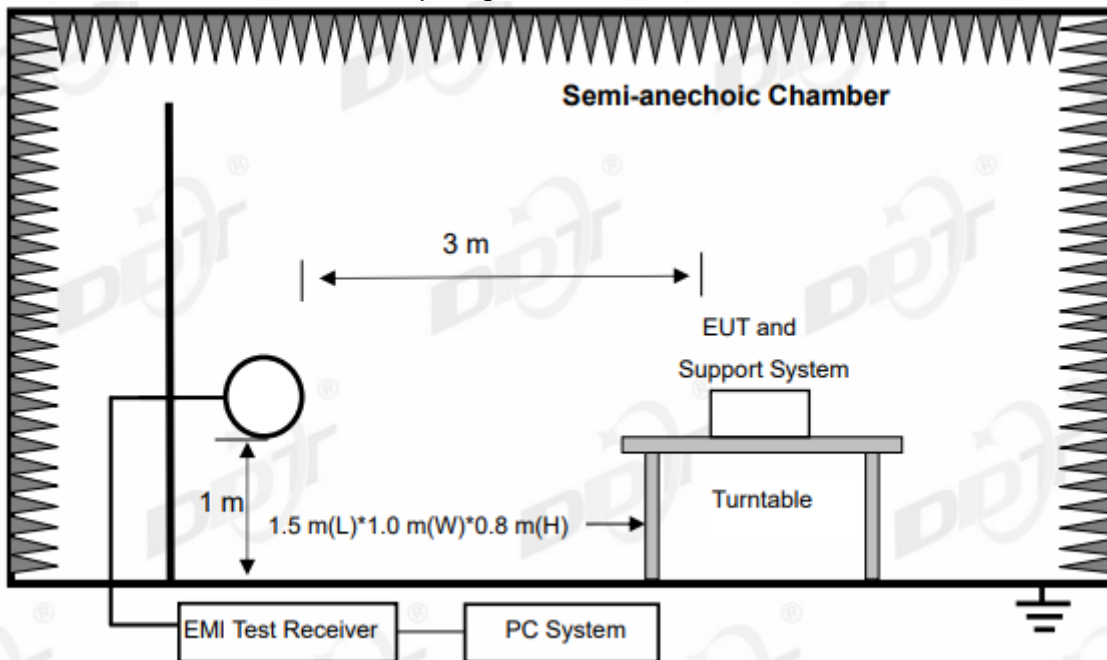

In 3 m Anechoic Chamber, test setup diagram for 30 MHz - 1 GHz:

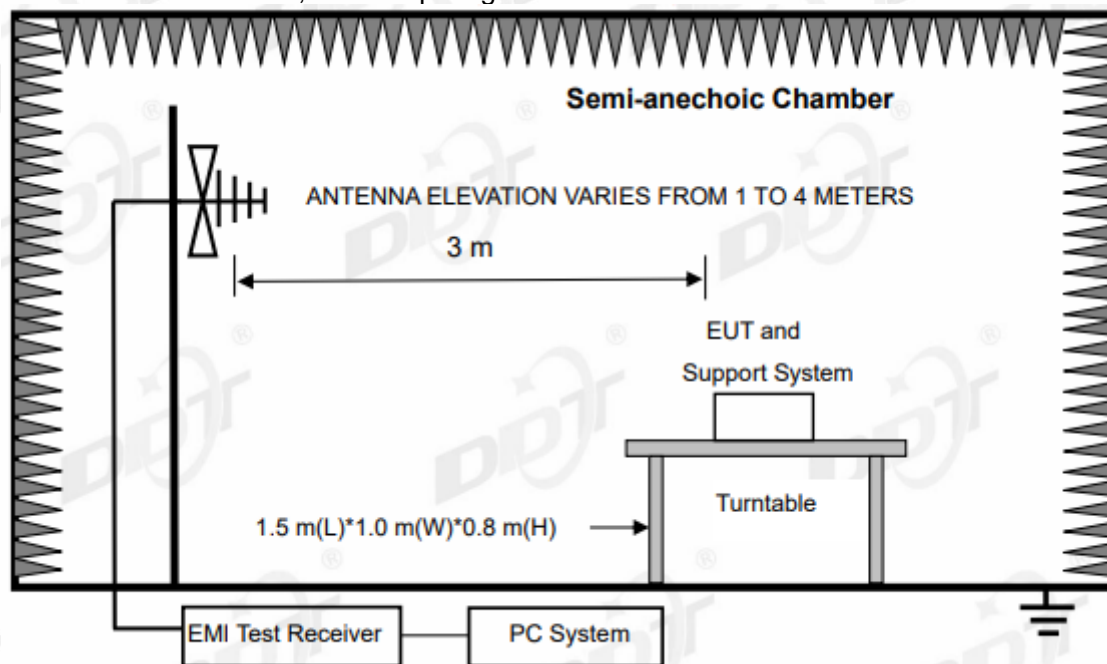

In 3 m Anechoic Chamber, test setup diagram for frequency above 1 GHz:

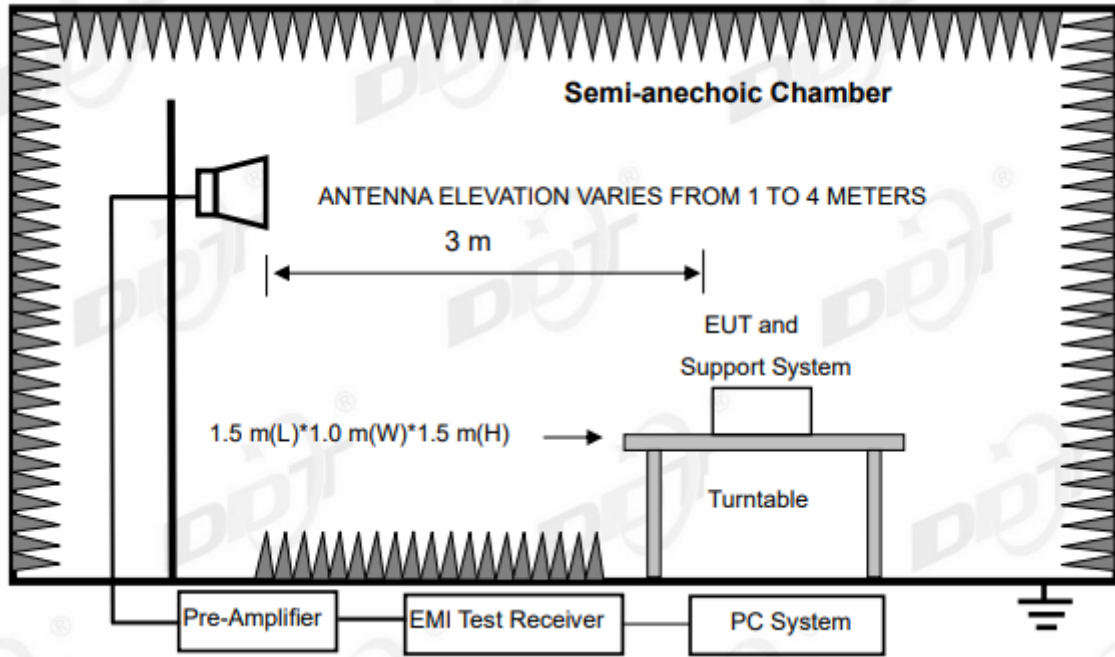

Note: For harmonic emissions test an appropriate high pass filter was inserted in the input port of AMP.

11.2. Limit

(1) FCC 15.205 Restricted frequency band

MHz	MHz	MHz	GHz
0.090-0.110	16.42-16.423	399.9-410	4.5-5.15
¹ 0.495-0.505	16.69475-16.69525	608-614	5.35-5.46
2.1735-2.1905	16.80425-16.80475	960-1240	7.25-7.75
4.125-4.128	25.5-25.67	1300-1427	8.025-8.5
4.1772&4.17775	37.5-38.25	1435-1626.5	9.0-9.2
4.2072&4.20775	73-74.6	1645.5-1646.5	9.3-9.5
6.215-6.218	74.8-75.2	1660-1710	10.6-12.7
6.26775-6.26825	108-121.94	1718.8-1722.2	13.25-13.4
6.31175-6.31225	123-138	2200-2300	14.47-14.5
8.291-8.294	149.9-150.05	2310-2390	15.35-16.2
8.362-8.366	156.52475-156.52525	2483.5-2500	17.7-21.4
8.37625-8.38675	156.7-156.9	2690-2900	22.01-23.12
8.41425-8.41475	162.0125-167.17	3260-3267	23.6-24.0
12.29-12.293	167.72-173.2	3332-3339	31.2-31.8
12.51975-12.52025	240-285	3345.8-3358	36.43-36.5
12.57675-12.57725	322-335.4	3600-4400	(²)
13.36-13.41			

¹Until February 1, 1999, this restricted band shall be 0.490-0.510 MHz.

²Above 38.6

(2) FCC 15.209 Limit

FREQUENCY MHz	DISTANCE Meters	FIELD STRENGTHS LIMIT	
		$\mu\text{V}/\text{m}$	$\text{dB}(\mu\text{V})/\text{m}$
0.009 ~ 0.490	300	2400/F(kHz)	67.6-20log(F)
0.490 ~ 1.705	30	24000/F(kHz)	87.6-20log(F)
1.705 ~ 30.0	30	30	29.54
30 ~ 88	3	100	40.0
88 ~ 216	3	150	43.5
216 ~ 960	3	200	46.0
960 ~ 1000	3	500	54.0
Above 1000	3	74.0 dB(μV)/m (Peak) 54.0 dB(μV)/m (Average)	

Note: (1) The emission limits shown in the above table are based on measurements employing a CISPR QP detector except for the frequency bands 9 - 90 kHz, 110 - 490 kHz and above 1000 MHz. Radiated emissions limits in these three bands are based on measurements employing an average detector.

(2) At frequencies below 30 MHz, measurement may be performed at a distance closer than that specified, and the limit at closer measurement distance can be extrapolated by below formula:

$$\text{Limit}_{3\text{m}}(\text{dB}\mu\text{V}/\text{m}) = \text{Limit}_{30\text{m}}(\text{dB}\mu\text{V}/\text{m}) + 40\text{Log}(30\text{m}/3\text{m})$$

(3) Limit for this EUT

The emissions appearing within 15.205 restricted frequency bands shall not exceed the limits shown in 15.209, all the other emissions shall be at least 20 dB below the fundamental emissions or comply with 15.209 limits.

11.3. Test Procedure

(1) EUT was placed on a non-metallic table, 80 cm above the ground plane inside a semi-anechoic chamber for below 1 G and 150 cm above the ground plane inside a semi-anechoic chamber for above 1 G.

(2) Test antenna was located 3 m from the EUT on an adjustable mast, and the antenna used as below table.

Test frequency range	Test antenna used	Test antenna distance
9 kHz - 30 MHz	Active Loop antenna	3 m
30 MHz - 1 GHz	Trilog Broadband Antenna	3 m
1 GHz - 18 GHz	Double Ridged Horn Antenna (1 GHz - 18 GHz)	3 m
18 GHz - 40 GHz	Horn Antenna (18 GHz - 40 GHz)	1 m

According ANSI C63.10:2013 clause 6.4.6 and 6.5.3, for measurements below 30 MHz, Antenna was located 3 m from EUT, the loop antenna was positioned in three antenna orientations (parallel, perpendicular, and round-parallel), for each measurement antenna alignment, the EUT shall be rotated through 0° to 360° on a turntable, and the lowest height of the magnetic

antenna shall be 1 m above the ground. For measurement above 30 MHz, the Trilog Broadband Antenna or Horn Antenna was located 3 m from EUT, Measurements were made with the antenna positioned in both the horizontal and vertical planes of Polarization, and the measurement antenna was varied from 1 m to 4 m. in height above the reference ground plane to obtain the maximum signal strength.

(3) Below pre-scan procedure was first performed in order to find prominent frequency spectrum radiated emissions from 9 kHz to 25 GHz:

(a) Scanning the peak frequency spectrum with the antenna specified in step (3), and the EUT was rotated 360 degree, the antenna height was varied from 1 m to 4 m (Except loop antenna, it's fixed 1 m above ground.)

(b) Change work frequency or channel of device if practicable.

(c) Change modulation type of device if practicable.

(d) Change power supply range from 85% to 115% of the rated supply voltage

(e) Rotated EUT though three orthogonal axes to determine the attitude of EUT arrangement produces highest emissions.

Spectrum frequency from 9 kHz to 25 GHz (tenth harmonic of fundamental frequency) was investigated, and no any obvious emission were detected from 9 kHz to 30 MHz and 18 GHz to 25 GHz, so below final test was performed with frequency range from 30 MHz to 18 GHz.

(4) For final emissions measurements at each frequency of interest, the EUT was rotated and the antenna height was varied between 1 m and 4 m in order to maximize the emission. Measurements in both horizontal and vertical polarities were made and the data was recorded. In order to find the maximum emission, the relative positions of equipments and all of the interface cables were changed according to ANSI C63.10:2013 on Radiated Emission test.

(5) The emissions from 9 kHz to 1 GHz were measured based on CISPR QP detector except for the frequency bands 9 - 90 kHz, 110 - 490 kHz, for emissions from 9 kHz - 90 kHz, 110 kHz - 490 kHz and above 1 GHz were measured based on average detector, for emissions above 1 GHz, peak emissions also be measured and need comply with Peak limit.

(6) The emissions from 9 kHz to 1 GHz, QP or average values were measured with EMI receiver with below RBW

Frequency band	RBW
9 kHz - 150 kHz	200 Hz
150 kHz - 30 MHz	9 kHz
30 MHz - 1 GHz	120 kHz

For emissions above 1 GHz, both Peak and Average level were measured with Spectrum Analyzer, and the RBW is set at 1 MHz, VBW is set at 3 MHz for Peak measure; According ANSI C63.10:2013 clause 4.1.4.2.2 procedure for average measure.

11.4. Test result

Pass. (See below detailed test result)

All the emissions except fundamental emission from 9 kHz to 25 GHz were comply with 15.209 limits.

Note1: According exploratory test, the emission levels are 20 dB below the limit detected from 9 kHz to 30 MHz and 18 GHz to 25 GHz, so the final test was performed with frequency range from 30 MHz to 18 GHz and recorded in below.

Note2: 30 MHz ~ 25 GHz: (Scan with GFSK 1M, GFSK 2M, the worst case is reported)

Note3: For emissions below 1 GHz, according exploratory explorer test, when change Tx mode and channel, have no distinct influence on emissions level, so for emissions below 1 GHz, the final test was only performed with EUT working in GFSK 1M Tx 2402 MHz mode.

Note4: For emissions above 1 GHz. If peak results comply with AV limit, AV Result is deemed to comply with AV limit.

Radiated Emission test (below 1 GHz)

TR-4-E-009 Radiated Emission Test Result

Test Date: 2023-08-15 **Tested By:** Bairong
EUT: True Wireless Earbuds **Model Number:** JBuds ANC
Test Mode: TX mode **Power Supply:** Battery
Condition: Temp:21.8°C;Humi:68.5% **Test Site:** DDT 3# Chamber
File Path: d:\ts\2023 report data\Q23071126-2E JBuds ANC\FCC BELOW 1G\20230815-013924_H
Memo: BLE 1M

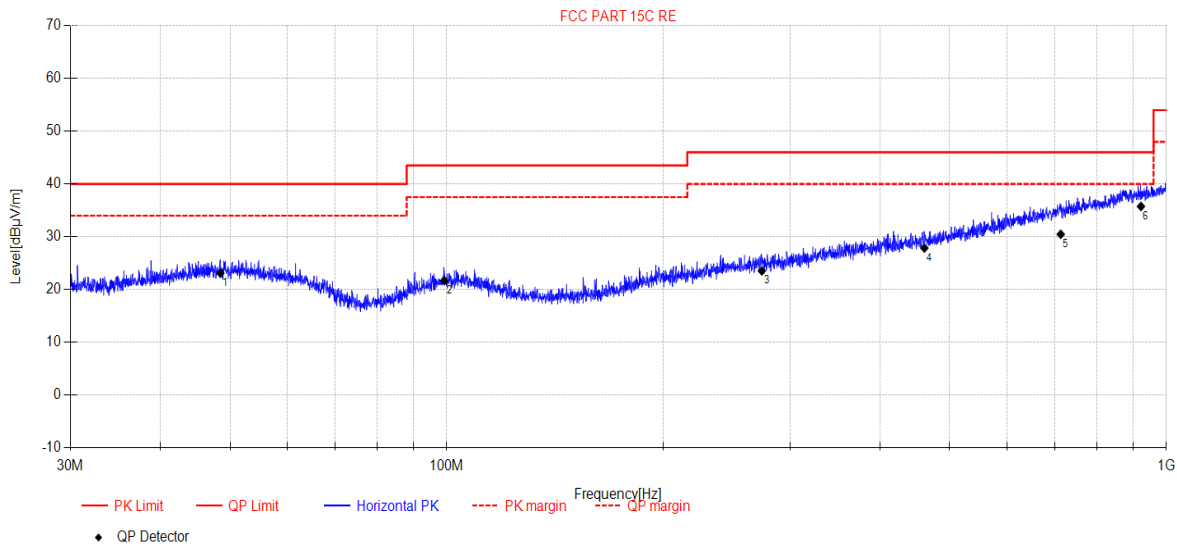

Final Data List										
NO.	Freq. [MHz]	Reading [dBµV/m]	Antenna Factor [dB]	Cable Loss [dB]	AMP [dB]	Result [dBµV/m]	Limit [dBµV/m]	Margin [dB]	Detector	Polarity
1	48.46	5.19	13.20	4.71	0.00	23.10	40.00	16.90	QP	Horizontal
2	99.30	5.77	10.83	5.06	0.00	21.66	43.50	21.84	QP	Horizontal
3	274.07	4.7	12.78	6.04	0.00	23.52	46.00	22.48	QP	Horizontal
4	461.12	4.7	16.30	6.84	0.00	27.84	46.00	18.16	QP	Horizontal
5	713.22	2.47	20.20	7.79	0.00	30.46	46.00	15.54	QP	Horizontal
6	921.88	4.82	22.50	8.42	0.00	35.74	46.00	10.26	QP	Horizontal

Note:

1. Result Level = Reading + Cable loss + Antenna Factor + AMP
2. If Peak Result complies with QP limit, QP Result is deemed to comply with QP limit.
3. Test setup: RBW: 120 kHz, VBW: 300 kHz, Sweep time: auto.

TR-4-E-009 Radiated Emission Test Result

Test Date: 2023-08-15 **Tested By:** Bairong
EUT: True Wireless Earbuds **Model Number:** JBuds ANC
Test Mode: TX mode **Power Supply:** Battery
Condition: Temp:21.8°C;Humi:68.5% **Test Site:** DDT 3# Chamber
File Path: d:\ts\2023 report data\Q23071126-2E JBuds ANC\FCC BELOW 1G\20230815-014005_V
Memo: BLE 1M

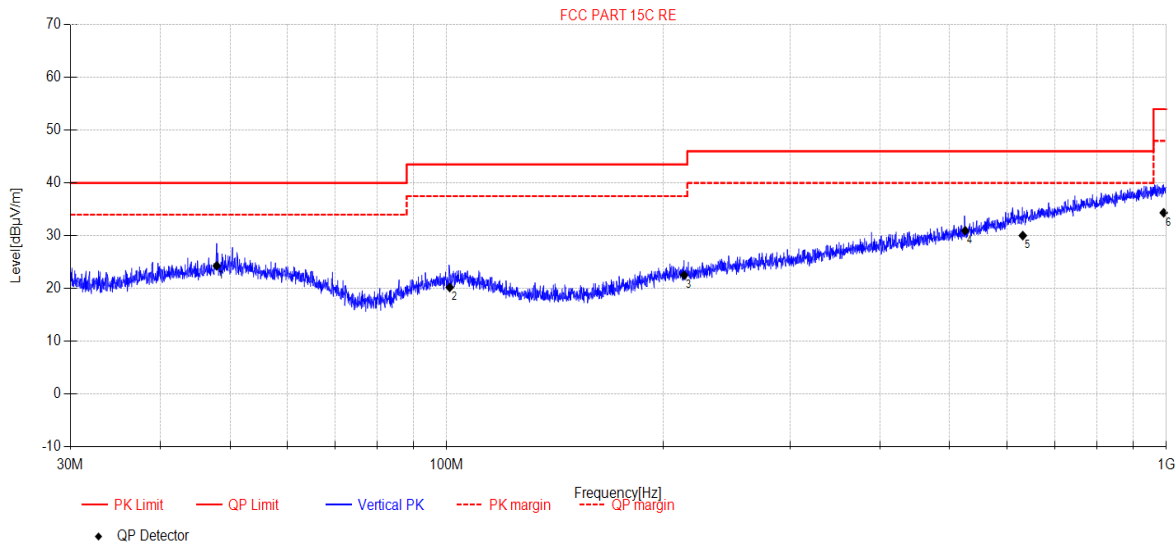

Final Data List										
NO.	Freq. [MHz]	Reading [dBµV/m]	Antenna Factor [dB]	Cable Loss [dB]	AMP [dB]	Result [dBµV/m]	Limit [dBµV/m]	Margin [dB]	Detector	Polarity
1	47.92	6.39	13.20	4.70	0.00	24.29	40.00	15.71	QP	Vertical
2	100.98	4.13	11.00	5.07	0.00	20.20	43.50	23.30	QP	Vertical
3	213.83	5.76	10.98	5.79	0.00	22.53	43.50	20.97	QP	Vertical
4	525.36	6.52	17.40	7.03	0.00	30.95	46.00	15.05	QP	Vertical
5	631.75	3.53	19.03	7.47	0.00	30.03	46.00	15.97	QP	Vertical
6	991.62	2.69	23.00	8.66	0.00	34.35	54.00	19.65	QP	Vertical

Note:

1. Result Level = Reading + Cable loss + Antenna Factor + AMP
2. If Peak Result complies with QP limit, QP Result is deemed to comply with QP limit.
3. Test setup: RBW: 120 kHz, VBW: 300 kHz, Sweep time: auto.

Radiated Emission test (above 1 GHz)

TR-4-E-009 Radiated Emission Test Result

Test Date: 2023-08-15 **Tested By:** Bairong
EUT: True Wireless Earbuds **Model Number:** JBuds ANC
Test Mode: TX mode **Power Supply:** Battery
Condition: Temp:21.8°C;Humi:68.5% **Test Site:** DDT 3# Chamber
File Path: d:\ts\2023 report data\Q23071126-2E JBuds ANC\FCC ABOVE 1G\19
Memo: BLE 1M 2402

Test Graph

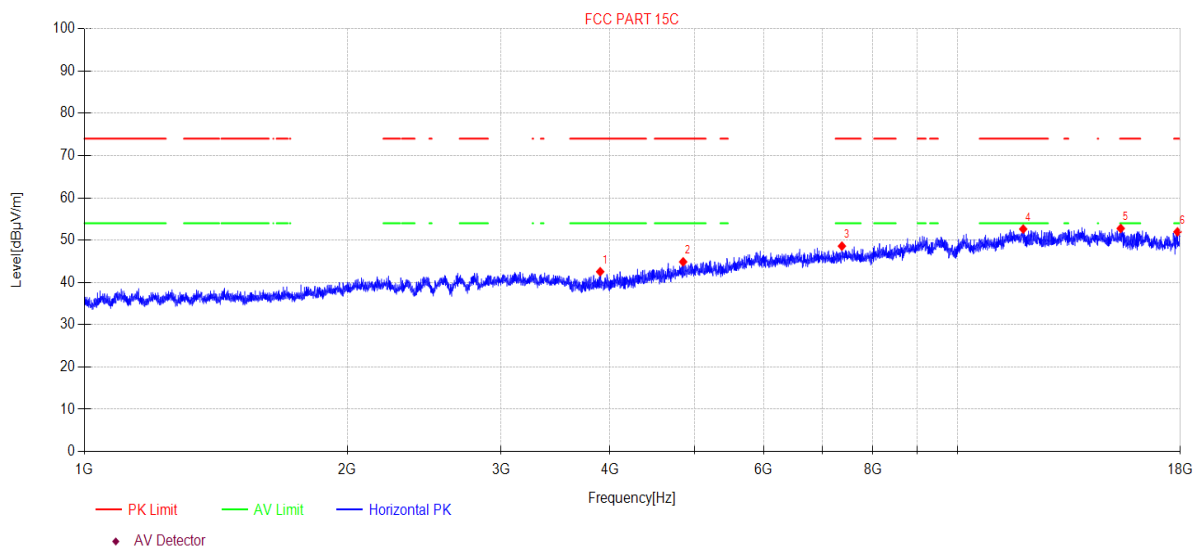

Suspected Data List

N O.	Freq. [MHz]	Reading [dBµV/m]	Cable loss [dB]	Antenna Factor [dB]	AMP [dB]	Level [dBµV/m]	Limit [dBµV/m]	Margin [dB]	Detector	Polarity
1	3897.60	47.55	5.83	30.50	-41.34	42.54	74.00	31.46	PK	Horizontal
2	4850.79	45.94	7.57	32.50	-41.14	44.87	74.00	29.13	PK	Horizontal
3	7373.66	45.45	7.64	36.50	-41.00	48.59	74.00	25.41	PK	Horizontal
4	11892.81	42.46	10.44	38.80	-39.07	52.63	74.00	21.37	PK	Horizontal
5	15381.28	40.94	13.08	38.72	-39.97	52.77	74.00	21.23	PK	Horizontal
6	17865.25	38.68	12.97	40.96	-40.65	51.96	74.00	22.04	PK	Horizontal

Note:

- Level = Reading + Cable loss + Antenna Factor + AMP
- If Peak Result complies with AV limit, AV Result is deemed to comply with AV limit.
- Test setup: RBW: 1 MHz, VBW: 3 MHz, Sweep time: auto.

TR-4-E-009 Radiated Emission Test Result

Test Date: 2023-08-15 **Tested By:** Bairong
EUT: True Wireless Earbuds **Model Number:** JBuds ANC
Test Mode: TX mode **Power Supply:** Battery
Condition: Temp:21.8°C;Humi:68.5% **Test Site:** DDT 3# Chamber
File Path: d:\ts\2023 report data\Q23071126-2E JBuds ANCFCC ABOVE 1G\20
Memo: BLE 1M 2402

Test Graph

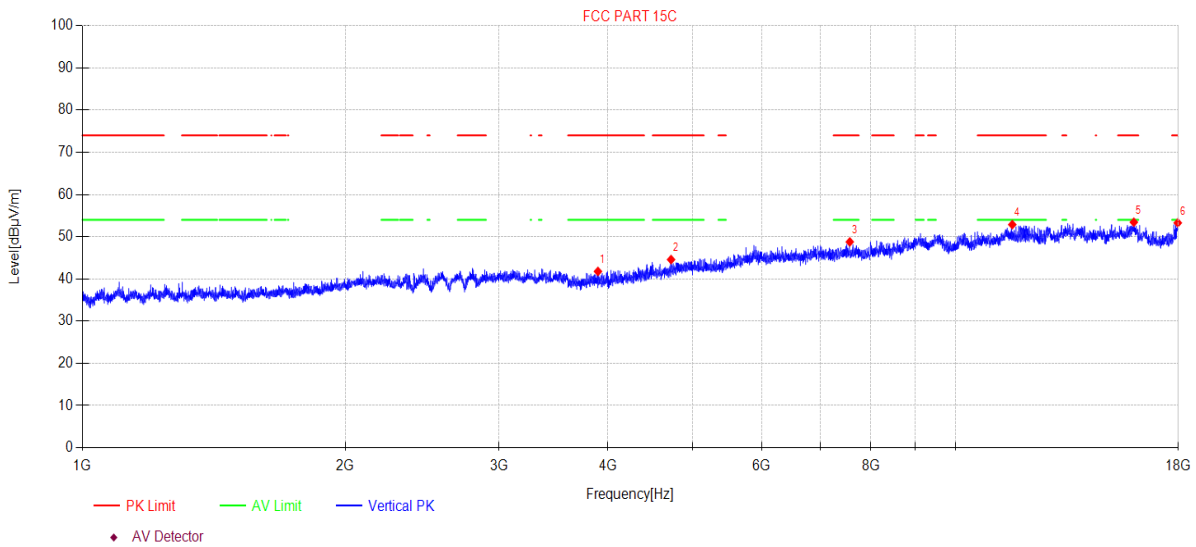

Suspected Data List										
N O.	Freq. [MHz]	Reading [dBµV/m]	Cable loss [dB]	Antenna Factor [dB]	AMP [dB]	Level [dBµV/m]	Limit [dBµV/m]	Margin [dB]	Detector	Polarity
1	3895.35	46.80	5.83	30.49	-41.34	41.78	74.00	32.22	PK	Vertical
2	4723.51	46.41	7.31	32.05	-41.18	44.59	74.00	29.41	PK	Vertical
3	7567.97	45.73	7.65	36.40	-41.00	48.78	74.00	25.22	PK	Vertical
4	11617.64	43.30	10.20	38.88	-39.51	52.87	74.00	21.13	PK	Vertical
5	16007.13	40.11	15.85	37.89	-40.40	53.45	74.00	20.55	PK	Vertical
6	17974.01	39.23	13.10	41.64	-40.69	53.28	74.00	20.72	PK	Vertical

Note:

1. Level = Reading + Cable loss + Antenna Factor + AMP
2. If Peak Result complies with AV limit, AV Result is deemed to comply with AV limit.
3. Test setup: RBW: 1 MHz, VBW: 3 MHz, Sweep time: auto.

TR-4-E-009 Radiated Emission Test Result

Test Date: 2023-08-15 **Tested By:** Bairong
EUT: True Wireless Earbuds **Model Number:** JBuds ANC
Test Mode: TX mode **Power Supply:** Battery
Condition: Temp:21.8°C;Humi:68.5% **Test Site:** DDT 3# Chamber
File Path: d:\ts\2023 report data\Q23071126-2E JBuds ANCFCC ABOVE 1G\21
Memo: BLE 1M 2440

Test Graph

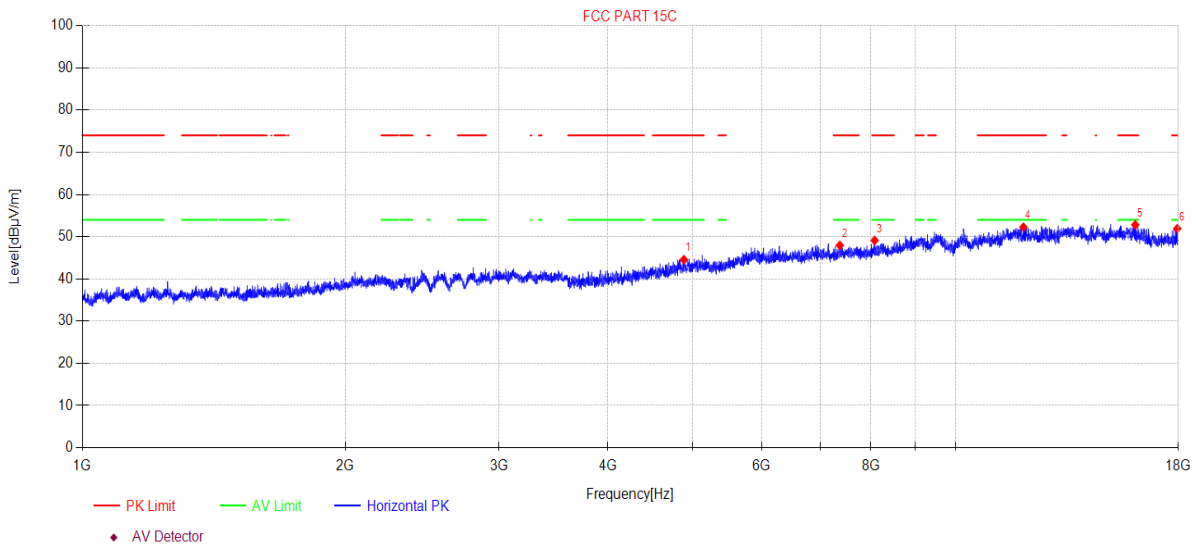

Suspected Data List										
N O.	Freq. [MHz]	Reading [dBµV/m]	Cable loss [dB]	Antenna Factor [dB]	AMP [dB]	Level [dBµV/m]	Limit [dBµV/m]	Margin [dB]	Detector	Polarity
1	4885.96	45.50	7.64	32.57	-41.13	44.58	74.00	29.42	PK	Horizontal
2	7371.53	44.84	7.64	36.50	-41.00	47.98	74.00	26.02	PK	Horizontal
3	8081.11	45.23	7.77	37.00	-40.87	49.13	74.00	24.87	PK	Horizontal
4	11961.75	41.86	10.51	38.86	-38.96	52.27	74.00	21.73	PK	Horizontal
5	16067.39	39.78	15.61	37.83	-40.39	52.83	74.00	21.17	PK	Horizontal
6	17948.05	38.04	13.07	41.49	-40.68	51.92	74.00	22.08	PK	Horizontal

Note:

1. Level = Reading + Cable loss + Antenna Factor + AMP
2. If Peak Result complies with AV limit, AV Result is deemed to comply with AV limit.
3. Test setup: RBW: 1 MHz, VBW: 3 MHz, Sweep time: auto.

TR-4-E-009 Radiated Emission Test Result

Test Date: 2023-08-15 **Tested By:** Bairong
EUT: True Wireless Earbuds **Model Number:** JBuds ANC
Test Mode: TX mode **Power Supply:** Battery
Condition: Temp:21.8°C;Humi:68.5% **Test Site:** DDT 3# Chamber
File Path: d:\ts\2023 report data\Q23071126-2E JBuds ANCFCC ABOVE 1G\22
Memo: BLE 1M 2440

Test Graph

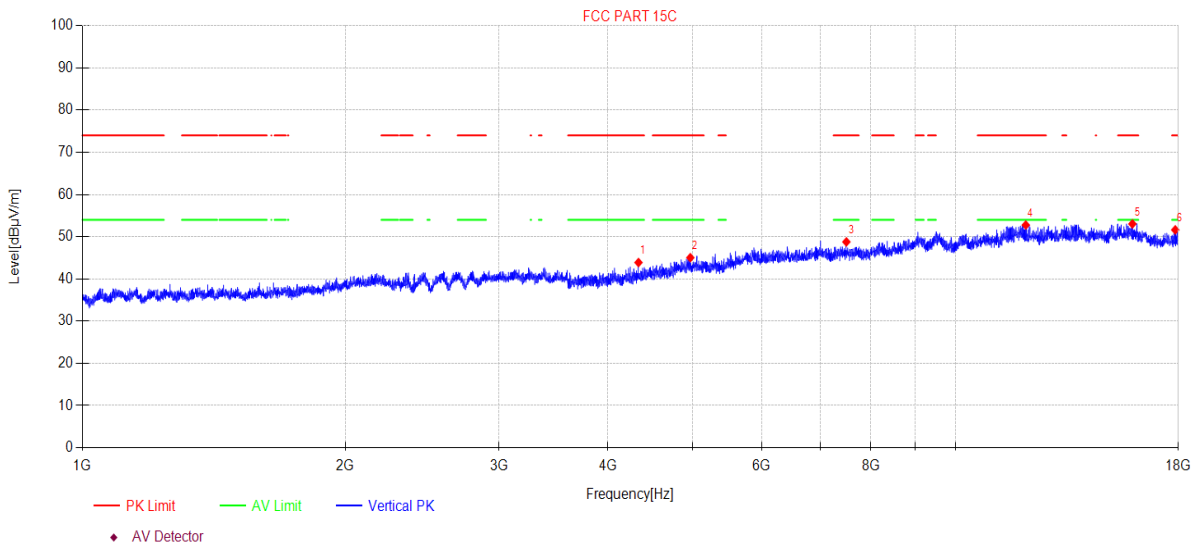

Suspected Data List										
N O.	Freq. [MHz]	Reading [dBµV/m]	Cable loss [dB]	Antenna Factor [dB]	AMP [dB]	Level [dBµV/m]	Limit [dBµV/m]	Margin [dB]	Detector	Polarity
1	4334.98	47.29	6.53	31.37	-41.30	43.89	74.00	30.11	PK	Vertical
2	4969.99	45.54	7.81	32.80	-41.11	45.04	74.00	28.96	PK	Vertical
3	7500.47	45.73	7.65	36.40	-41.00	48.78	74.00	25.22	PK	Vertical
4	12038.05	42.19	10.54	38.98	-38.94	52.77	74.00	21.23	PK	Vertical
5	15947.10	39.75	15.64	38.01	-40.36	53.04	74.00	20.96	PK	Vertical
6	17854.93	38.42	12.96	40.88	-40.64	51.62	74.00	22.38	PK	Vertical

Note:

1. Level = Reading + Cable loss + Antenna Factor + AMP
2. If Peak Result complies with AV limit, AV Result is deemed to comply with AV limit.
3. Test setup: RBW: 1 MHz, VBW: 3 MHz, Sweep time: auto.

TR-4-E-009 Radiated Emission Test Result

Test Date: 2023-08-15 **Tested By:** Bairong
EUT: True Wireless Earbuds **Model Number:** JBuds ANC
Test Mode: TX mode **Power Supply:** Battery
Condition: Temp:21.8°C;Humi:68.5% **Test Site:** DDT 3# Chamber
File Path: d:\ts\2023 report data\Q23071126-2E JBuds ANCFCC ABOVE 1G\23
Memo: BLE 1M 2480

Test Graph

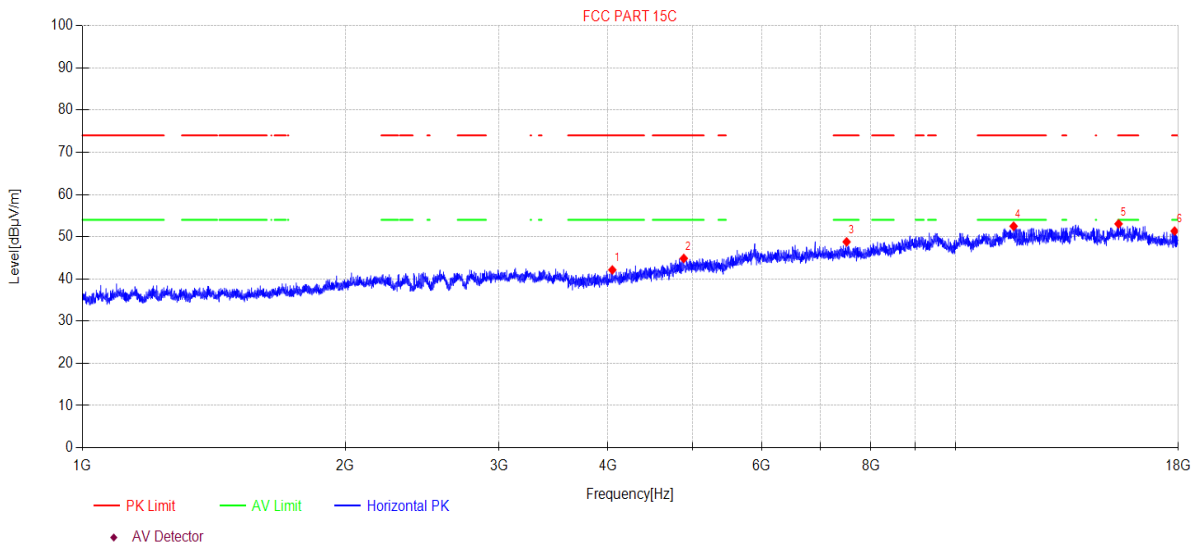

Suspected Data List										
N O.	Freq. [MHz]	Reading [dBµV/m]	Cable loss [dB]	Antenna Factor [dB]	AMP [dB]	Level [dBµV/m]	Limit [dBµV/m]	Margin [dB]	Detector	Polarity
1	4045.66	46.80	5.94	30.79	-41.39	42.14	74.00	31.86	PK	Horizontal
2	4884.55	45.78	7.64	32.57	-41.13	44.86	74.00	29.14	PK	Horizontal
3	7504.81	45.73	7.65	36.40	-41.00	48.78	74.00	25.22	PK	Horizontal
4	11658.00	42.86	10.24	38.84	-39.45	52.49	74.00	21.51	PK	Horizontal
5	15376.84	41.23	13.06	38.72	-39.96	53.05	74.00	20.95	PK	Horizontal
6	17823.99	38.38	12.92	40.67	-40.63	51.34	74.00	22.66	PK	Horizontal

Note:

1. Level = Reading + Cable loss + Antenna Factor + AMP
2. If Peak Result complies with AV limit, AV Result is deemed to comply with AV limit.
3. Test setup: RBW: 1 MHz, VBW: 3 MHz, Sweep time: auto.

TR-4-E-009 Radiated Emission Test Result

Test Date: 2023-08-15 **Tested By:** Bairong
EUT: True Wireless Earbuds **Model Number:** JBuds ANC
Test Mode: TX mode **Power Supply:** Battery
Condition: Temp:21.8°C;Humi:68.5% **Test Site:** DDT 3# Chamber
File Path: d:\ts\2023 report data\Q23071126-2E JBuds ANCFCC ABOVE 1G\24
Memo: BLE 1M 2480

Test Graph

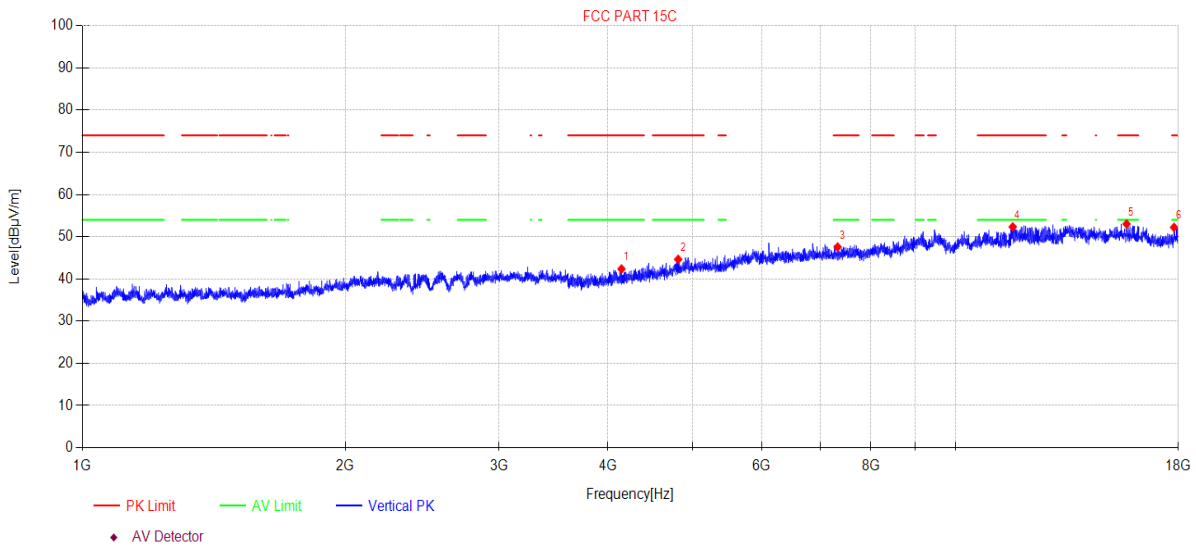

Suspected Data List										
N O.	Freq. [MHz]	Reading [dBµV/m]	Cable loss [dB]	Antenna Factor [dB]	AMP [dB]	Level [dBµV/m]	Limit [dBµV/m]	Margin [dB]	Detector	Polarity
1	4145.07	46.59	6.14	30.99	-41.36	42.36	74.00	31.64	PK	Vertical
2	4813.08	45.97	7.49	32.35	-41.16	44.65	74.00	29.35	PK	Vertical
3	7329.04	44.44	7.63	36.50	-41.00	47.57	74.00	26.43	PK	Vertical
4	11631.07	42.74	10.21	38.87	-39.49	52.33	74.00	21.67	PK	Vertical
5	15704.70	40.38	14.54	38.30	-40.19	53.03	74.00	20.97	PK	Vertical
6	17798.26	39.46	12.89	40.49	-40.62	52.22	74.00	21.78	PK	Vertical

Note:

1. Level = Reading + Cable loss + Antenna Factor + AMP
2. If Peak Result complies with AV limit, AV Result is deemed to comply with AV limit.
3. Test setup: RBW: 1 MHz, VBW: 3 MHz, Sweep time: auto.

TR-4-E-009 Radiated Emission Test Result

Test Date: 2023-08-21 **Tested By:** Bairong
EUT: True Wireless Earbuds **Model Number:** JBuds ANC
Test Mode: TX mode **Power Supply:** Battery
Condition: Temp:21.8°C;Humi:68.5% **Test Site:** DDT 3# Chamber
File Path: d:\ts\2023 report data\Q23071126-2E JBuds ANCFCC ABOVE 1G\53
Memo: BLE 2M 2402

Test Graph

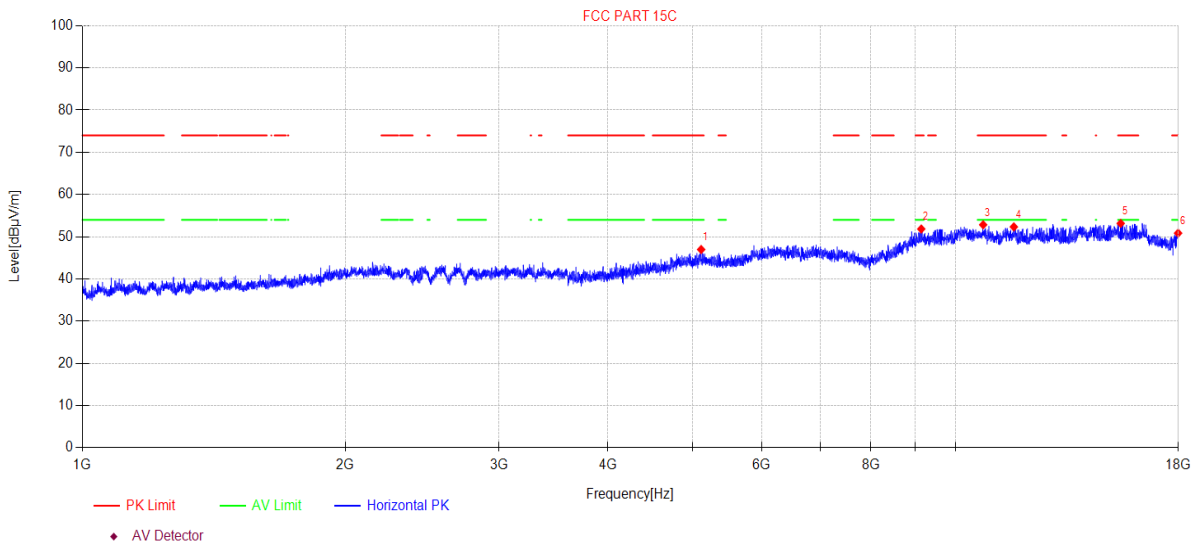

Suspected Data List										
N O.	Freq. [MHz]	Reading [dBµV/m]	Cable loss [dB]	Antenna Factor [dB]	AMP [dB]	Level [dBµV/m]	Limit [dBµV/m]	Margin [dB]	Detector	Polarity
1	5114.24	46.11	8.03	32.90	-40.07	46.97	74.00	27.03	PK	Horizontal
2	9137.24	43.58	8.76	38.27	-38.78	51.83	74.00	22.17	PK	Horizontal
3	10757.98	43.25	9.48	39.10	-39.00	52.83	74.00	21.17	PK	Horizontal
4	11664.74	42.65	10.24	38.84	-39.40	52.33	74.00	21.67	PK	Horizontal
5	15461.51	40.12	13.44	38.64	-39.04	53.16	74.00	20.84	PK	Horizontal
6	17989.60	38.37	13.12	41.74	-42.38	50.85	74.00	23.15	PK	Horizontal

Note:

1. Level = Reading + Cable loss + Antenna Factor + AMP
2. If Peak Result complies with AV limit, AV Result is deemed to comply with AV limit.
3. Test setup: RBW: 1 MHz, VBW: 3 MHz, Sweep time: auto.

TR-4-E-009 Radiated Emission Test Result

Test Date: 2023-08-21 **Tested By:** Bairong
EUT: True Wireless Earbuds **Model Number:** JBuds ANC
Test Mode: TX mode **Power Supply:** Battery
Condition: Temp:21.8°C;Humi:68.5% **Test Site:** DDT 3# Chamber
File Path: d:\ts\2023 report data\Q23071126-2E JBuds ANCFCC ABOVE 1G\54
Memo: BLE 2M 2402

Test Graph

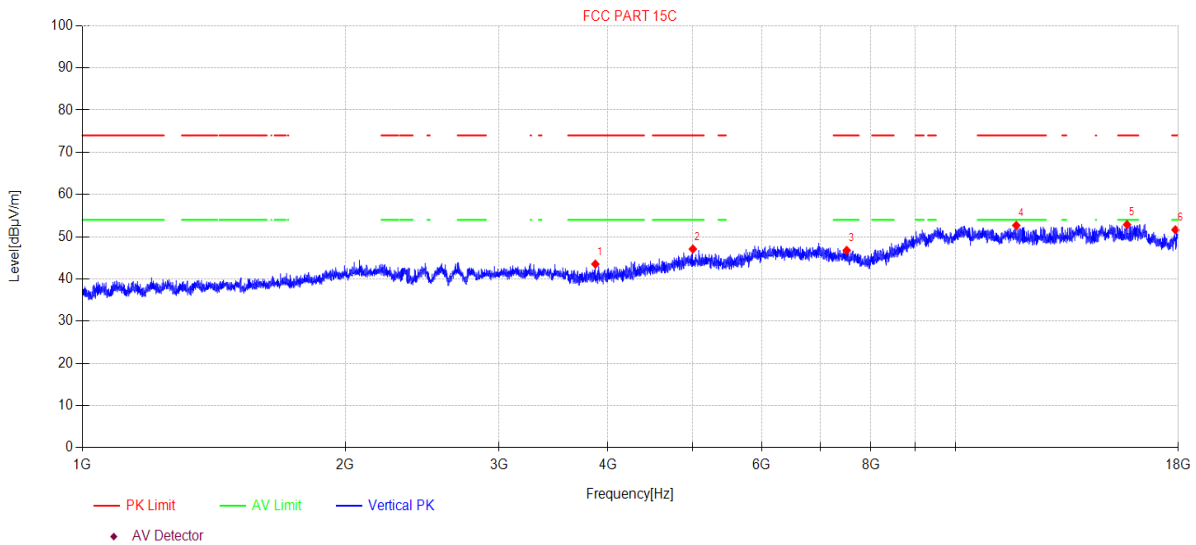

Suspected Data List										
N O.	Freq. [MHz]	Reading [dBµV/m]	Cable loss [dB]	Antenna Factor [dB]	AMP [dB]	Level [dBµV/m]	Limit [dBµV/m]	Margin [dB]	Detector	Polarity
1	3868.43	47.63	5.82	30.44	-40.37	43.52	74.00	30.48	PK	Vertical
2	5003.14	46.49	7.87	32.81	-40.08	47.09	74.00	26.91	PK	Vertical
3	7506.98	44.69	7.65	36.40	-41.97	46.77	74.00	27.23	PK	Vertical
4	11739.14	43.01	10.31	38.80	-39.44	52.68	74.00	21.32	PK	Vertical
5	15722.86	39.17	14.62	38.28	-39.19	52.88	74.00	21.12	PK	Vertical
6	17860.09	39.85	12.96	40.92	-42.09	51.64	74.00	22.36	PK	Vertical

Note:

1. Level = Reading + Cable loss + Antenna Factor + AMP
2. If Peak Result complies with AV limit, AV Result is deemed to comply with AV limit.
3. Test setup: RBW: 1 MHz, VBW: 3 MHz, Sweep time: auto.

TR-4-E-009 Radiated Emission Test Result

Test Date: 2023-08-21 **Tested By:** Bairong
EUT: True Wireless Earbuds **Model Number:** JBuds ANC
Test Mode: TX mode **Power Supply:** Battery
Condition: Temp:21.8°C;Humi:68.5% **Test Site:** DDT 3# Chamber
File Path: d:\ts\2023 report data\Q23071126-2E JBuds ANCFCC ABOVE 1G\55
Memo: BLE 2M 2440

Test Graph

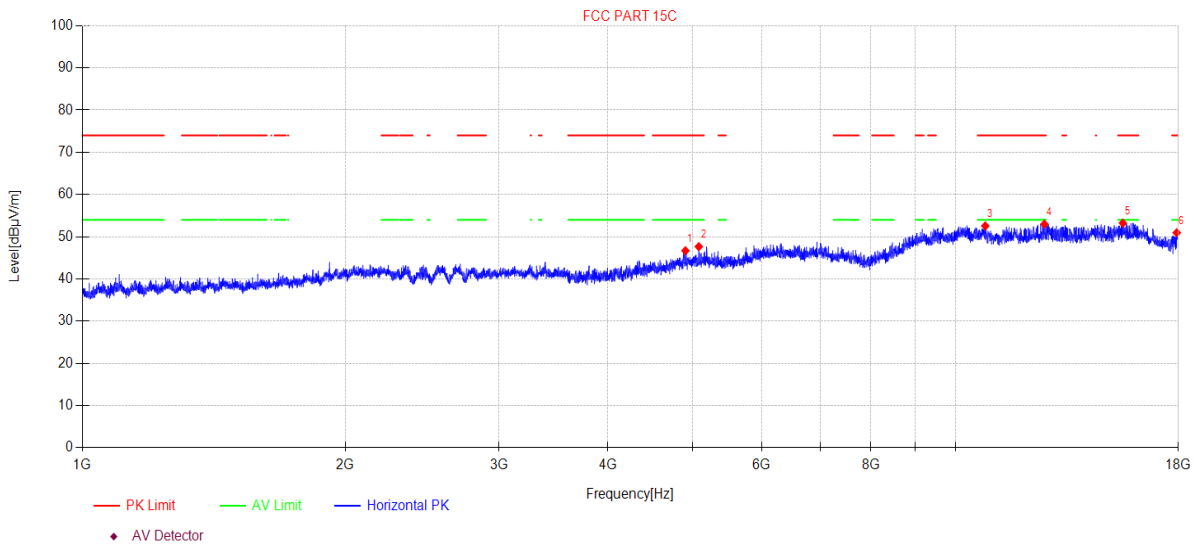

Suspected Data List										
N O.	Freq. [MHz]	Reading [dBµV/m]	Cable loss [dB]	Antenna Factor [dB]	AMP [dB]	Level [dBµV/m]	Limit [dBµV/m]	Margin [dB]	Detector	Polarity
1	4905.77	46.50	7.68	32.62	-40.11	46.69	74.00	27.31	PK	Horizontal
2	5081.83	46.83	7.99	32.90	-40.07	47.65	74.00	26.35	PK	Horizontal
3	10817.22	42.96	9.52	39.10	-39.02	52.56	74.00	21.44	PK	Horizontal
4	12644.26	42.96	10.54	39.29	-39.81	52.98	74.00	21.02	PK	Horizontal
5	15551.13	39.97	13.85	38.50	-39.09	53.23	74.00	20.77	PK	Horizontal
6	17922.14	38.80	13.04	41.33	-42.23	50.94	74.00	23.06	PK	Horizontal

Note:

1. Level = Reading + Cable loss + Antenna Factor + AMP
2. If Peak Result complies with AV limit, AV Result is deemed to comply with AV limit.
3. Test setup: RBW: 1 MHz, VBW: 3 MHz, Sweep time: auto.

TR-4-E-009 Radiated Emission Test Result

Test Date: 2023-08-21 **Tested By:** Bairong
EUT: True Wireless Earbuds **Model Number:** JBuds ANC
Test Mode: TX mode **Power Supply:** Battery
Condition: Temp:21.8°C;Humi:68.5% **Test Site:** DDT 3# Chamber
File Path: d:\ts\2023 report data\Q23071126-2E JBuds ANCFCC ABOVE 1G\56
Memo: BLE 2M 2440

Test Graph

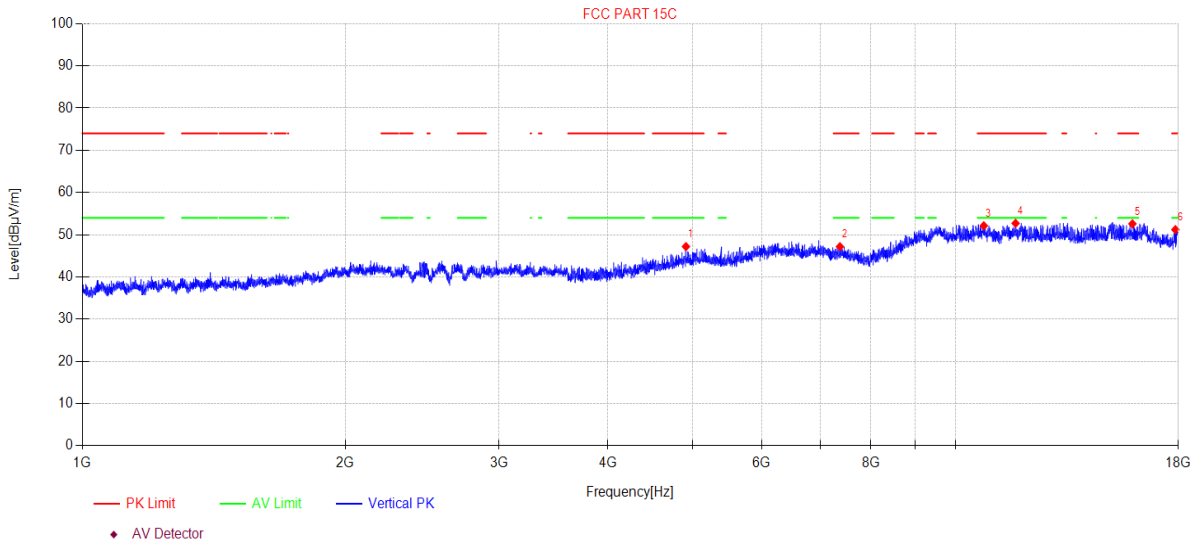

Suspected Data List										
N O.	Freq. [MHz]	Reading [dBµV/m]	Cable loss [dB]	Antenna Factor [dB]	AMP [dB]	Level [dBµV/m]	Limit [dBµV/m]	Margin [dB]	Detector	Polarity
1	4912.87	46.96	7.69	32.65	-40.11	47.19	74.00	26.81	PK	Vertical
2	7373.66	44.67	7.64	36.50	-41.63	47.18	74.00	26.82	PK	Vertical
3	10776.65	42.55	9.49	39.10	-39.01	52.13	74.00	21.87	PK	Vertical
4	11718.80	43.04	10.29	38.80	-39.43	52.70	74.00	21.30	PK	Vertical
5	15947.10	38.27	15.64	38.01	-39.33	52.59	74.00	21.41	PK	Vertical
6	17860.09	39.41	12.96	40.92	-42.09	51.20	74.00	22.80	PK	Vertical

Note:

1. Level = Reading + Cable loss + Antenna Factor + AMP
2. If Peak Result complies with AV limit, AV Result is deemed to comply with AV limit.
3. Test setup: RBW: 1 MHz, VBW: 3 MHz, Sweep time: auto.

TR-4-E-009 Radiated Emission Test Result

Test Date: 2023-08-21 **Tested By:** Bairong
EUT: True Wireless Earbuds **Model Number:** JBuds ANC
Test Mode: TX mode **Power Supply:** Battery
Condition: Temp:21.8°C;Humi:68.5% **Test Site:** DDT 3# Chamber
File Path: d:\ts\2023 report data\Q23071126-2E JBuds ANCFCC ABOVE 1G\57
Memo: BLE 2M 2480

Test Graph

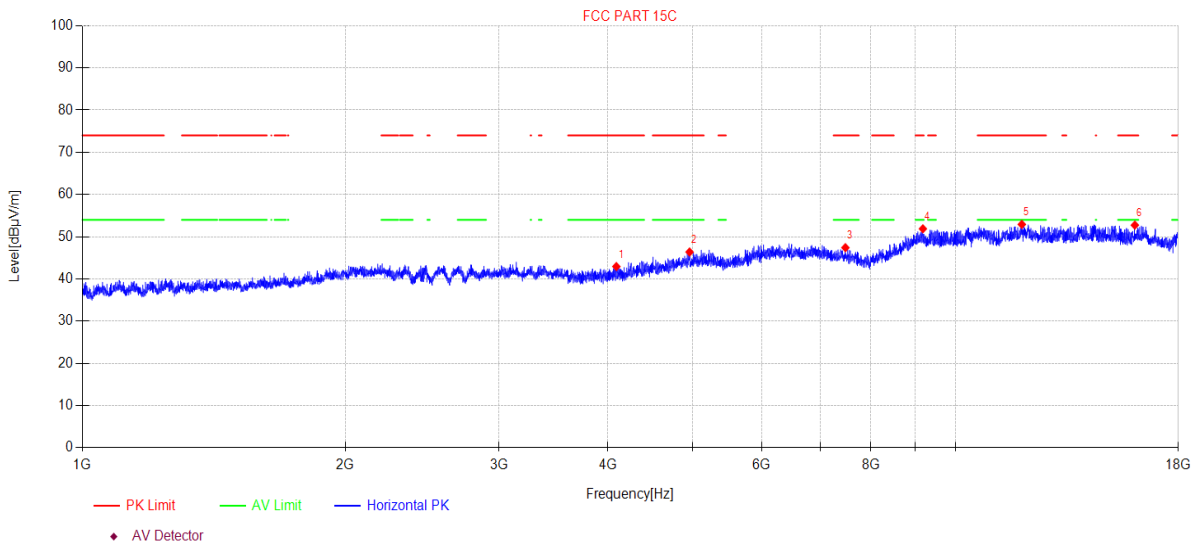

Suspected Data List										
N O.	Freq. [MHz]	Reading [dBµV/m]	Cable loss [dB]	Antenna Factor [dB]	AMP [dB]	Level [dBµV/m]	Limit [dBµV/m]	Margin [dB]	Detector	Polarity
1	4089.15	46.45	6.03	30.88	-40.42	42.94	74.00	31.06	PK	Horizontal
2	4959.95	45.88	7.79	32.80	-40.09	46.38	74.00	27.62	PK	Horizontal
3	7480.99	45.23	7.64	36.44	-41.90	47.41	74.00	26.59	PK	Horizontal
4	9176.94	43.59	8.77	38.30	-38.78	51.88	74.00	22.12	PK	Horizontal
5	11913.45	43.17	10.46	38.81	-39.52	52.92	74.00	21.08	PK	Horizontal
6	16048.82	38.60	15.69	37.85	-39.40	52.74	74.00	21.26	PK	Horizontal

Note:

1. Level = Reading + Cable loss + Antenna Factor + AMP
2. If Peak Result complies with AV limit, AV Result is deemed to comply with AV limit.
3. Test setup: RBW: 1 MHz, VBW: 3 MHz, Sweep time: auto.

TR-4-E-009 Radiated Emission Test Result

Test Date: 2023-08-21 **Tested By:** Bairong
EUT: True Wireless Earbuds **Model Number:** JBuds ANC
Test Mode: TX mode **Power Supply:** Battery
Condition: Temp:21.8°C;Humi:68.5% **Test Site:** DDT 3# Chamber
File Path: d:\ts\2023 report data\Q23071126-2E JBuds ANCFCC ABOVE 1G\58
Memo: BLE 2M 2480

Test Graph

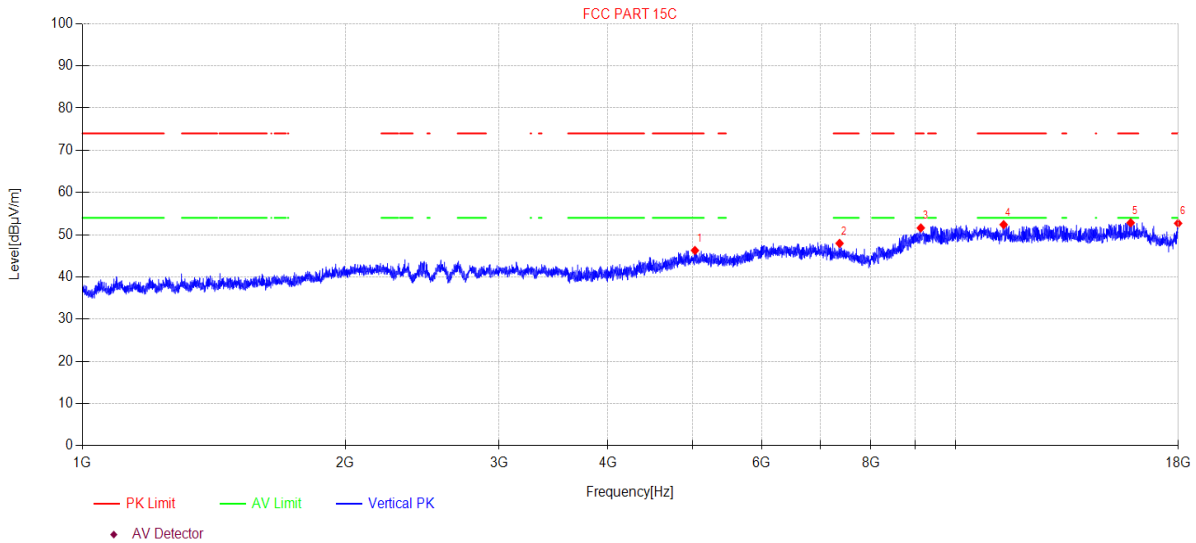

Suspected Data List										
N O.	Freq. [MHz]	Reading [dBµV/m]	Cable loss [dB]	Antenna Factor [dB]	AMP [dB]	Level [dBµV/m]	Limit [dBµV/m]	Margin [dB]	Detector	Polarity
1	5030.69	45.59	7.91	32.86	-40.08	46.28	74.00	27.72	PK	Vertical
2	7367.27	45.43	7.64	36.50	-41.62	47.95	74.00	26.05	PK	Vertical
3	9126.68	43.38	8.76	38.25	-38.78	51.61	74.00	22.39	PK	Vertical
4	11355.39	42.58	9.97	39.10	-39.26	52.39	74.00	21.61	PK	Vertical
5	15873.53	38.67	15.31	38.13	-39.28	52.83	74.00	21.17	PK	Vertical
6	17989.60	40.22	13.12	41.74	-42.38	52.70	74.00	21.30	PK	Vertical

Note:

1. Level = Reading + Cable loss + Antenna Factor + AMP
2. If Peak Result complies with AV limit, AV Result is deemed to comply with AV limit.
3. Test setup: RBW: 1 MHz, VBW: 3 MHz, Sweep time: auto.

12. Emissions in Restricted Frequency Bands

12.1. Block diagram of test setup

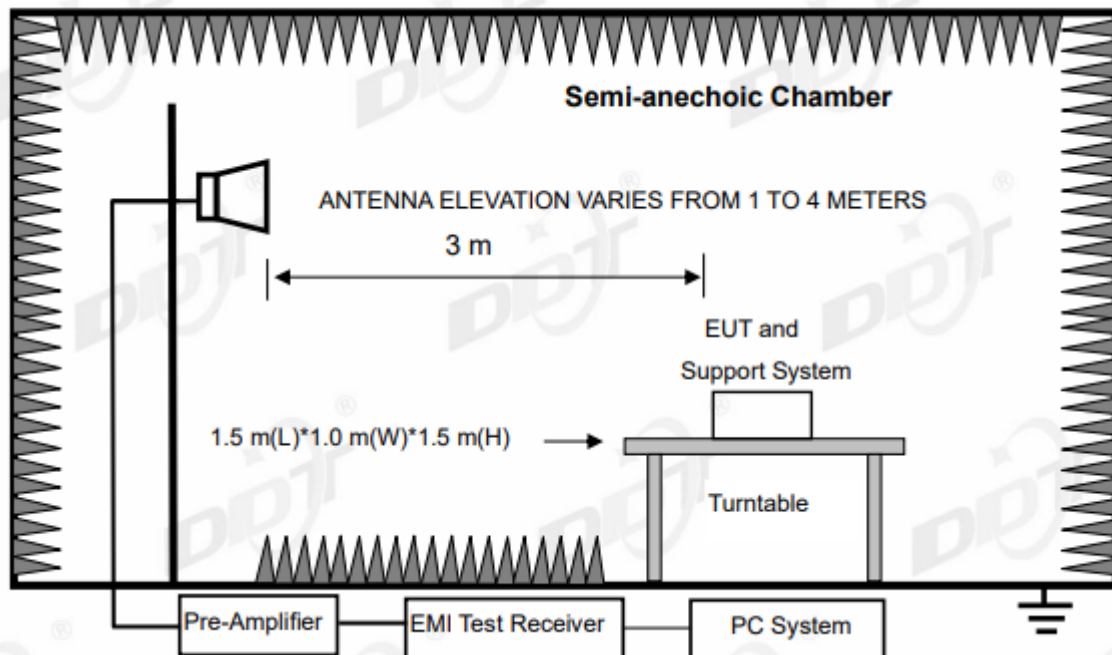

12.2. Limit

All restriction band should comply with 15.209 limits, other emission should be at least 20 dB below the fundamental.

12.3. Test procedure

Same with Radiated Emission except change investigated frequency range from 2310 MHz to 2410 MHz and 2475 MHz to 2500 MHz.

Remark: All restriction band have been tested, and only the worst case GFSK 1M is shown in report.

12.4. Test result

Pass. (See below detailed test result)

TR-4-E-009 Radiated Emission Test Result

Test Date: 2023-08-19 **Tested By:** Bairong
EUT: True Wireless Earbuds **Model Number:** JBuds ANC
Test Mode: TX mode **Power Supply:** Battery
Condition: Temp:21.8°C;Humi:68.5% **Test Site:** DDT 3# Chamber
File Path: d:\ts\2023 report data\Q23071126-2E JBuds ANCFCC ABOVE 1G\43
Memo: BLE 1M 2402

Test Graph

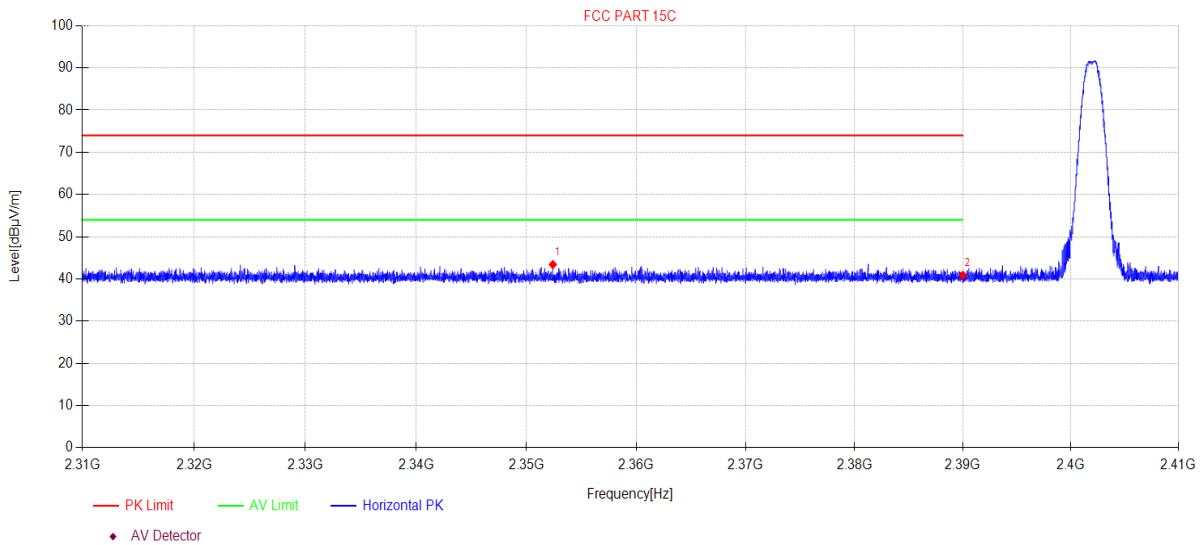

Suspected Data List										
NO	Freq. [MHz]	Reading [dBµV/m]	Cable loss [dB]	Antenna Factor [dB]	AMP [dB]	Level [dBµV/m]	Limit [dBµV/m]	Margin [dB]	Detector	Polarity
1	2352.41	50.19	3.84	27.40	-38.01	43.42	74.00	30.58	PK	Horizontal
2	2390.00	47.65	3.87	27.48	-38.11	40.89	74.00	33.11	PK	Horizontal

Note:

1. Level = Reading + Cable loss + Antenna Factor + AMP
2. If Peak Result complies with AV limit, AV Result is deemed to comply with AV limit.
3. Test setup: RBW: 1 MHz, VBW: 3 MHz, Sweep time: auto.

TR-4-E-009 Radiated Emission Test Result

Test Date: 2023-08-19 **Tested By:** Bairong
EUT: True Wireless Earbuds **Model Number:** JBuds ANC
Test Mode: TX mode **Power Supply:** Battery
Condition: Temp:21.8°C;Humi:68.5% **Test Site:** DDT 3# Chamber
File Path: d:\ts\2023 report data\Q23071126-2E JBuds ANCFCC ABOVE 1G\44
Memo: BLE 1M 2402

Test Graph

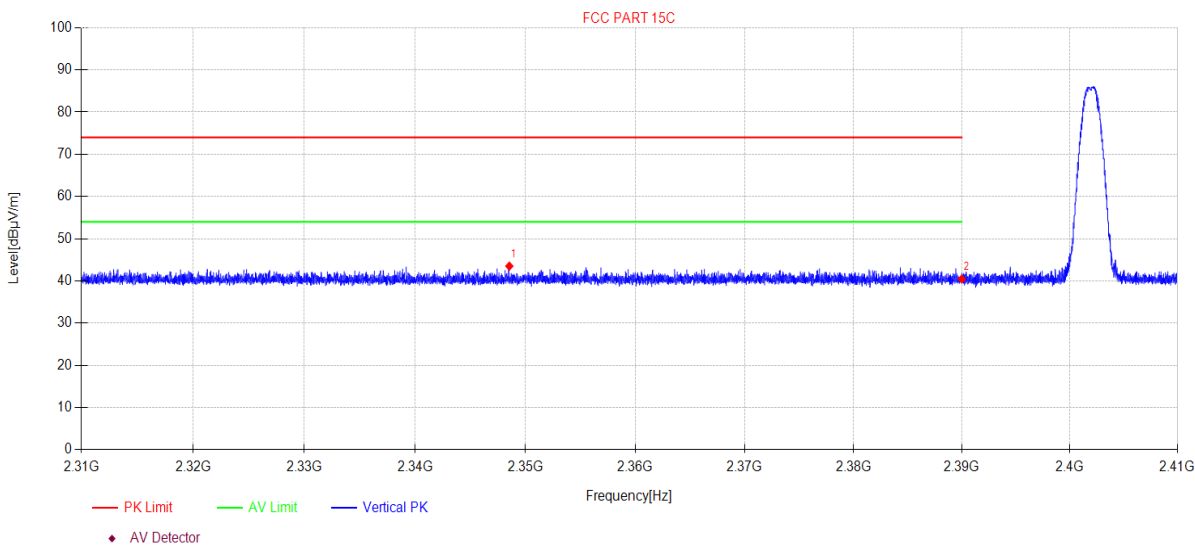

Suspected Data List										
NO	Freq. [MHz]	Reading [dBµV/m]	Cable loss [dB]	Antenna Factor [dB]	AMP [dB]	Level [dBµV/m]	Limit [dBµV/m]	Margin [dB]	Detector	Polarity
1	2348.55	50.28	3.83	27.40	-38.00	43.51	74.00	30.49	PK	Vertical
2	2390.00	47.23	3.87	27.48	-38.11	40.47	74.00	33.53	PK	Vertical

Note:

1. Level = Reading + Cable loss + Antenna Factor + AMP
2. If Peak Result complies with AV limit, AV Result is deemed to comply with AV limit.
3. Test setup: RBW: 1 MHz, VBW: 3 MHz, Sweep time: auto.

TR-4-E-009 Radiated Emission Test Result

Test Date: 2023-08-19 **Tested By:** Bairong
EUT: True Wireless Earbuds **Model Number:** JBuds ANC
Test Mode: TX mode **Power Supply:** Battery
Condition: Temp:21.8°C;Humi:68.5% **Test Site:** DDT 3# Chamber
File Path: d:\ts\2023 report data\Q23071126-2E JBuds ANCFCC ABOVE 1G\45
Memo: BLE 1M 2480

Test Graph

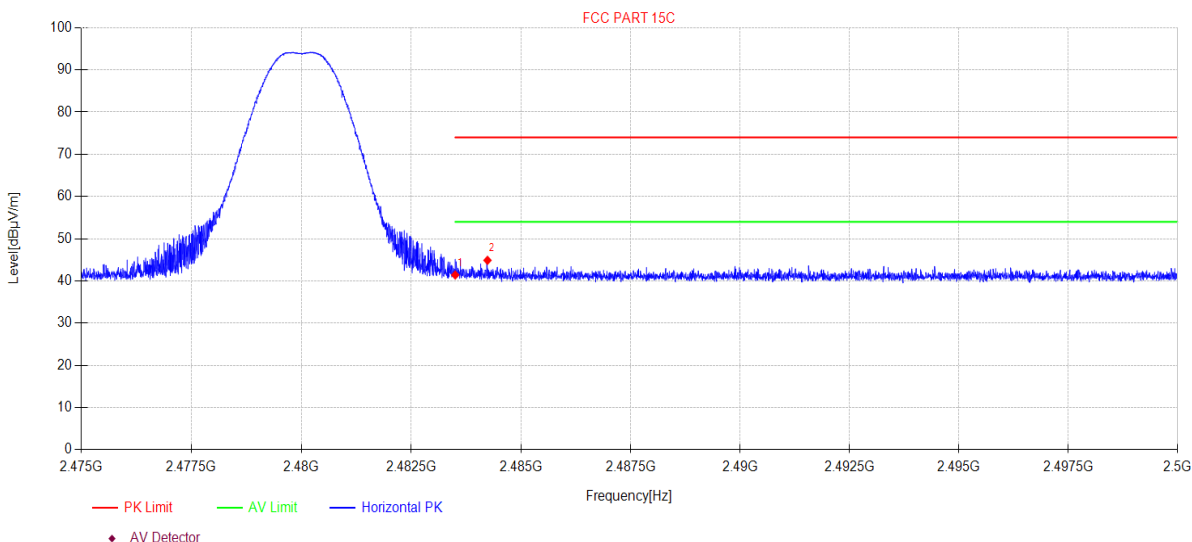

Suspected Data List										
NO	Freq. [MHz]	Reading [dBµV/m]	Cable loss [dB]	Antenna Factor [dB]	AMP [dB]	Level [dBµV/m]	Limit [dBµV/m]	Margin [dB]	Detector	Polarity
1	2483.50	48.13	3.94	27.73	-38.38	41.42	74.00	32.58	PK	Horizontal
2	2484.24	51.58	3.94	27.74	-38.38	44.88	74.00	29.12	PK	Horizontal

Note:

1. Level = Reading + Cable loss + Antenna Factor + AMP
2. If Peak Result complies with AV limit, AV Result is deemed to comply with AV limit.
3. Test setup: RBW: 1 MHz, VBW: 3 MHz, Sweep time: auto.

TR-4-E-009 Radiated Emission Test Result

Test Date: 2023-08-19 **Tested By:** Bairong
EUT: True Wireless Earbuds **Model Number:** JBuds ANC
Test Mode: TX mode **Power Supply:** Battery
Condition: Temp:21.8°C;Humi:68.5% **Test Site:** DDT 3# Chamber
File Path: d:\ts\2023 report data\Q23071126-2E JBuds ANCFCC ABOVE 1G\46
Memo: BLE 1M 2480

Test Graph

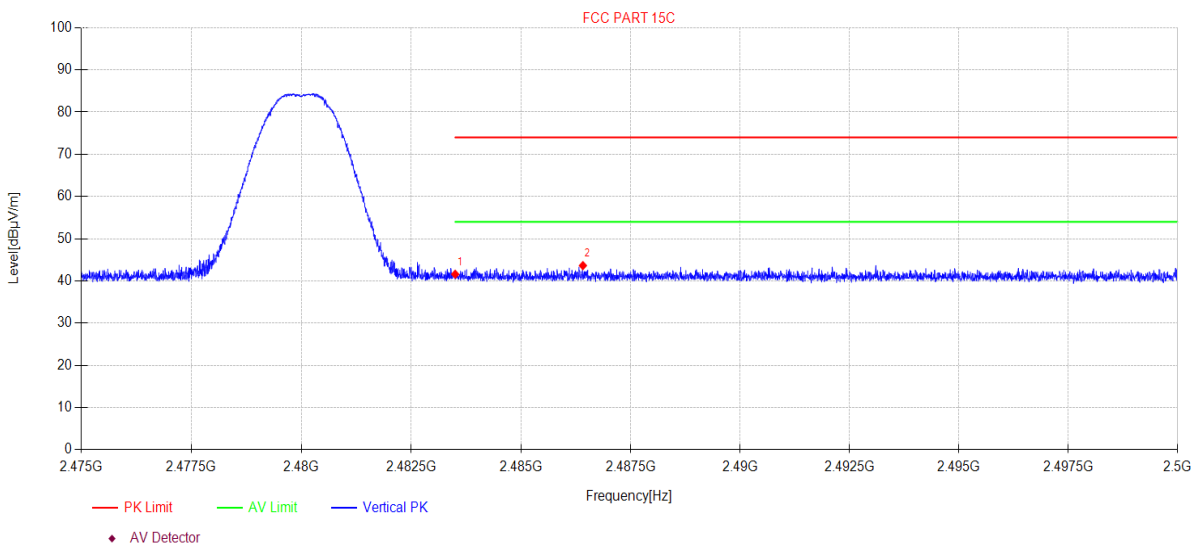

Suspected Data List										
NO	Freq. [MHz]	Reading [dBµV/m]	Cable loss [dB]	Antenna Factor [dB]	AMP [dB]	Level [dBµV/m]	Limit [dBµV/m]	Margin [dB]	Detector	Polarity
1	2483.50	48.30	3.94	27.73	-38.38	41.59	74.00	32.41	PK	Vertical
2	2486.41	50.34	3.94	27.75	-38.39	43.64	74.00	30.36	PK	Vertical

Note:

1. Level = Reading + Cable loss + Antenna Factor + AMP
2. If Peak Result complies with AV limit, AV Result is deemed to comply with AV limit.
3. Test setup: RBW: 1 MHz, VBW: 3 MHz, Sweep time: auto.

TR-4-E-009 Radiated Emission Test Result

Test Date: 2023-08-21 **Tested By:** Bairong
EUT: True Wireless Earbuds **Model Number:** JBuds ANC
Test Mode: TX mode **Power Supply:** Battery
Condition: Temp:21.8°C;Humi:68.5% **Test Site:** DDT 3# Chamber
File Path: d:\ts\2023 report data\Q23071126-2E JBuds ANCFCC ABOVE 1G\59
Memo: BLE 2M 2402

Test Graph

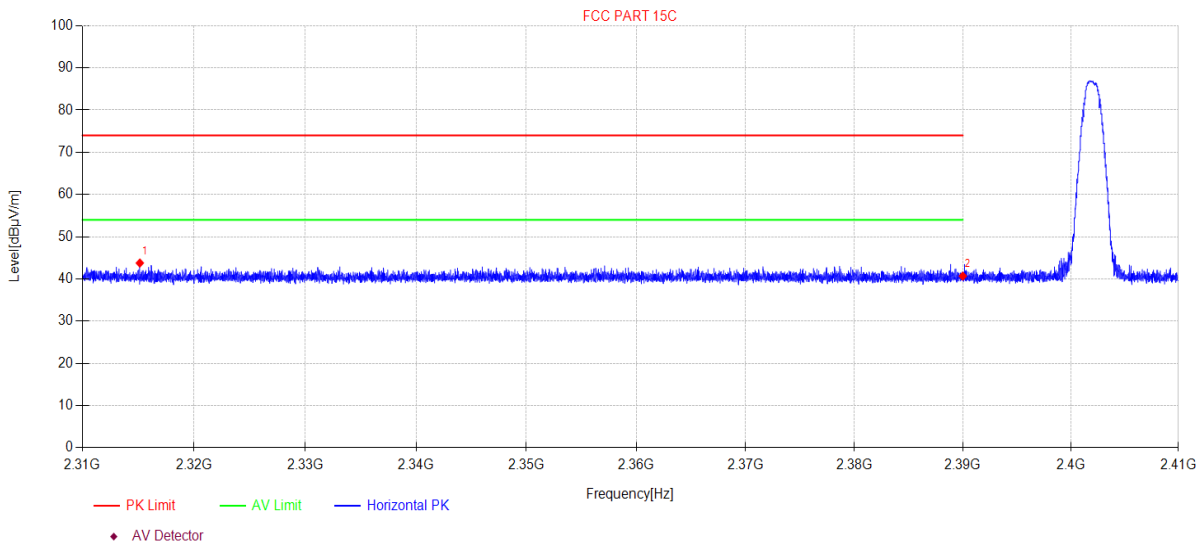

Suspected Data List										
NO	Freq. [MHz]	Reading [dBµV/m]	Cable loss [dB]	Antenna Factor [dB]	AMP [dB]	Level [dBµV/m]	Limit [dBµV/m]	Margin [dB]	Detector	Polarity
1	2315.14	50.53	3.81	27.33	-37.90	43.77	74.00	30.23	PK	Horizontal
2	2390.00	47.44	3.87	27.48	-38.11	40.68	74.00	33.32	PK	Horizontal

Note:

1. Level = Reading + Cable loss + Antenna Factor + AMP
2. If Peak Result complies with AV limit, AV Result is deemed to comply with AV limit.
3. Test setup: RBW: 1 MHz, VBW: 3 MHz, Sweep time: auto.

TR-4-E-009 Radiated Emission Test Result

Test Date: 2023-08-21 **Tested By:** Bairong
EUT: True Wireless Earbuds **Model Number:** JBuds ANC
Test Mode: TX mode **Power Supply:** Battery
Condition: Temp:21.8°C;Humi:68.5% **Test Site:** DDT 3# Chamber
File Path: d:\ts\2023 report data\Q23071126-2E JBuds ANCFCC ABOVE 1G\60
Memo: BLE 2M 2402

Test Graph

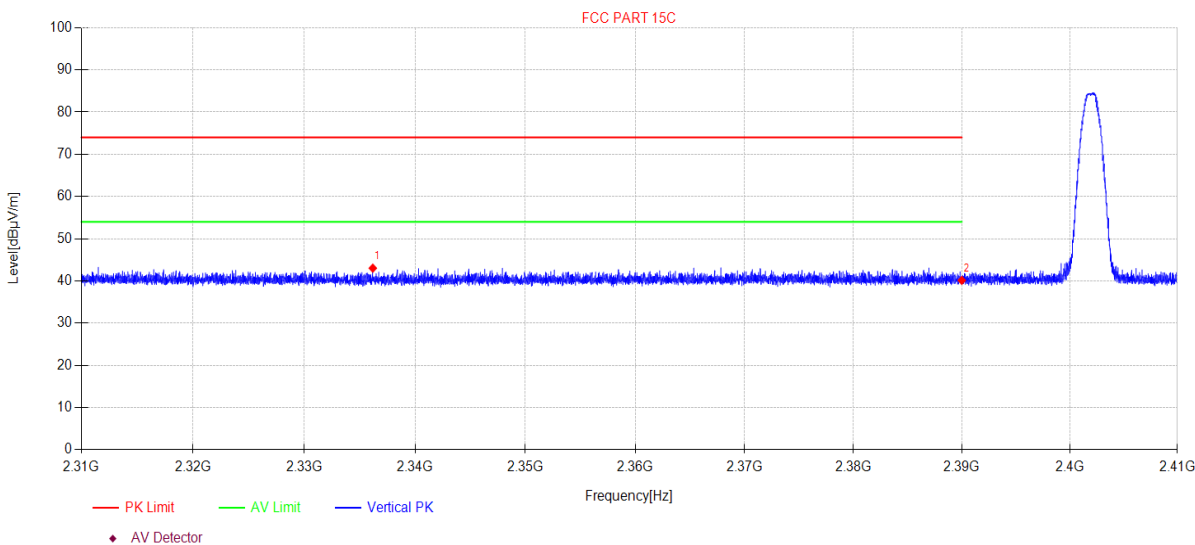

Suspected Data List										
NO	Freq. [MHz]	Reading [dBµV/m]	Cable loss [dB]	Antenna Factor [dB]	AMP [dB]	Level [dBµV/m]	Limit [dBµV/m]	Margin [dB]	Detector	Polarity
1	2336.18	49.79	3.83	27.37	-37.96	43.03	74.00	30.97	PK	Vertical
2	2390.00	46.90	3.87	27.48	-38.11	40.14	74.00	33.86	PK	Vertical

Note:

1. Level = Reading + Cable loss + Antenna Factor + AMP
2. If Peak Result complies with AV limit, AV Result is deemed to comply with AV limit.
3. Test setup: RBW: 1 MHz, VBW: 3 MHz, Sweep time: auto.

TR-4-E-009 Radiated Emission Test Result

Test Date: 2023-08-21 **Tested By:** Bairong
EUT: True Wireless Earbuds **Model Number:** JBuds ANC
Test Mode: TX mode **Power Supply:** Battery
Condition: Temp:21.8°C;Humi:68.5% **Test Site:** DDT 3# Chamber
File Path: d:\ts\2023 report data\Q23071126-2E JBuds ANCFCC ABOVE 1G\61
Memo: BLE 2M 2480

Test Graph

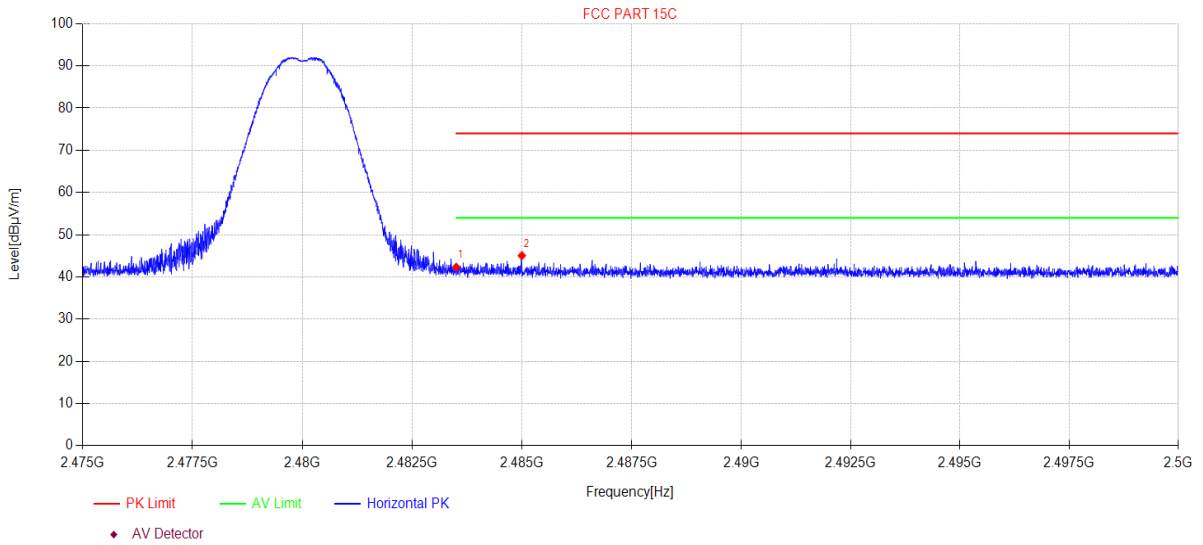

Suspected Data List										
NO	Freq. [MHz]	Reading [dBµV/m]	Cable loss [dB]	Antenna Factor [dB]	AMP [dB]	Level [dBµV/m]	Limit [dBµV/m]	Margin [dB]	Detector	Polarity
1	2483.50	49.03	3.94	27.73	-38.38	42.32	74.00	31.68	PK	Horizontal
2	2485.00	51.74	3.94	27.74	-38.38	45.04	74.00	28.96	PK	Horizontal

Note:

1. Level = Reading + Cable loss + Antenna Factor + AMP
2. If Peak Result complies with AV limit, AV Result is deemed to comply with AV limit.
3. Test setup: RBW: 1 MHz, VBW: 3 MHz, Sweep time: auto.

TR-4-E-009 Radiated Emission Test Result

Test Date: 2023-08-21 **Tested By:** Bairong
EUT: True Wireless Earbuds **Model Number:** JBuds ANC
Test Mode: TX mode **Power Supply:** Battery
Condition: Temp:21.8°C;Humi:68.5% **Test Site:** DDT 3# Chamber
File Path: d:\ts\2023 report data\Q23071126-2E JBuds ANCFCC ABOVE 1G\62
Memo: BLE 2M 2480

Test Graph

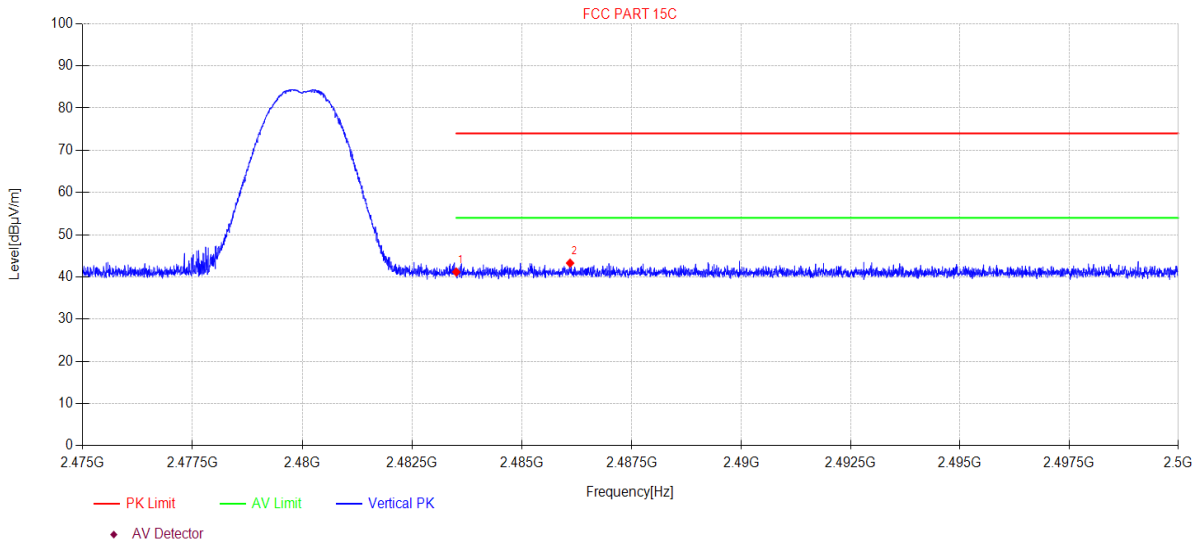

Suspected Data List										
NO	Freq. [MHz]	Reading [dBµV/m]	Cable loss [dB]	Antenna Factor [dB]	AMP [dB]	Level [dBµV/m]	Limit [dBµV/m]	Margin [dB]	Detector	Polarity
1	2483.50	47.89	3.94	27.73	-38.38	41.18	74.00	32.82	PK	Vertical
2	2486.10	49.99	3.94	27.74	-38.39	43.28	74.00	30.72	PK	Vertical

Note:

1. Level = Reading + Cable loss + Antenna Factor + AMP
2. If Peak Result complies with AV limit, AV Result is deemed to comply with AV limit.
3. Test setup: RBW: 1 MHz, VBW: 3 MHz, Sweep time: auto.

13. Power Line Conducted Emission

13.1. Block diagram of test setup

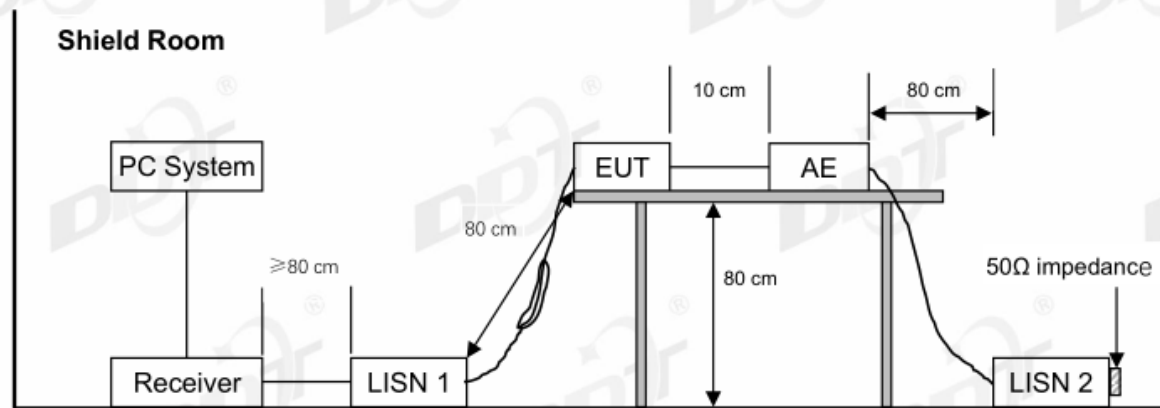

13.2. Power line conducted emission limits

Frequency	Quasi-Peak Level dB(μ V)	Average Level dB(μ V)
150 kHz ~ 500 kHz	66 ~ 56*	56 ~ 46*
500 kHz ~ 5 MHz	56	46
5 MHz ~ 30 MHz	60	50

Note 1: * Decreasing linearly with logarithm of frequency.

Note 2: The lower limit shall apply at the transition frequencies.

13.3. Test procedure

The EUT and Support equipment, if needed, were put placed on a non-metallic table, 80 cm above the ground plane.

All support equipment power received from a second LISN.

Emissions were measured on each current carrying line of the EUT using an EMI Test Receiver connected to the LISN powering the EUT.

The Receiver scanned from 150 kHz to 30 MHz for emissions in each of the test modes.

During the above scans, the emissions were maximized by cable manipulation.

The test mode(s) described in clause 2.4 were scanned during the preliminary test.

After the preliminary scan, we found the test mode producing the highest emission level.

The EUT configuration and worse cable configuration of the above highest emission levels were recorded for reference of the final test.

EUT and support equipment were set up on the test bench as per the configuration with highest emission level in the preliminary test.

A scan was taken on both power lines, Neutral and Line, recording at least the six highest emissions.

Emission frequency and amplitude were recorded into a computer in which correction factors were used to calculate the emission level and compare reading to the applicable limit.

The test data of the worst-case condition(s) was recorded.

The bandwidth of test receiver is set at 9 kHz.

13.4. Test result

Pass. (See below detailed test result)

Note1: All emissions not reported below are too low against the prescribed limits.

Note2: "----" means Peak detection; "-----" means Average detection.

Note3: Pre-test AC conducted emission at both voltage AC 120V/60Hz and AC 240V/50Hz, recorded worse case.

TR-4-E-010 Conducted Emission Test Result

Test Site : DDT 1# Shield Room
Test Date : 2023-08-16
EUT : True Wireless Earbuds
Power Supply : AC 120V/60Hz
Condition : TEMP:23.2°C, RH:53.1%, BP:101.1kPa
Memo : BLE

D:\2023 CE report data\Q23071126-2E JBuds ANC\FCC.EM6
Tested By : Johnson Huang
Model Number : JBuds ANC
Test Mode : TX mode
LISN : 2022 1# ENV216/NEUTRAL

Data: 6

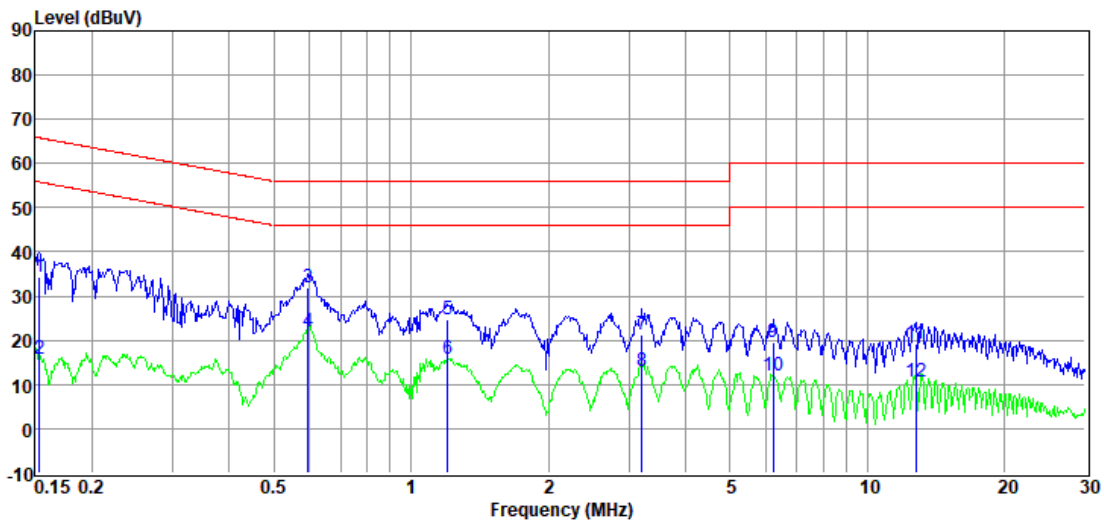

Item (Mark)	Freq. (MHz)	Read Level (dBuV)	LISN Factor (dB)	Cable Loss (dB)	Pulse Limiter Factor (dB)	Result Level (dBuV)	Limit Line (dBuV)	Over Limit (dB)	Detector	Phase
1	0.15	14.61	9.81	0.01	9.94	34.37	65.82	-31.45	QP	NEUTRAL
2	0.15	-4.11	9.81	0.01	9.94	15.65	55.82	-40.17	Average	NEUTRAL
3	0.59	12.13	9.70	0.01	9.92	31.76	56.00	-24.24	QP	NEUTRAL
4	0.59	2.44	9.70	0.01	9.92	22.07	46.00	-23.93	Average	NEUTRAL
5	1.20	4.93	9.70	0.02	9.91	24.56	56.00	-31.44	QP	NEUTRAL
6	1.20	-4.01	9.70	0.02	9.91	15.62	46.00	-30.38	Average	NEUTRAL
7	3.21	1.65	9.70	0.04	9.91	21.30	56.00	-34.70	QP	NEUTRAL
8	3.21	-6.47	9.70	0.04	9.91	13.18	46.00	-32.82	Average	NEUTRAL
9	6.22	0.04	9.62	0.06	9.92	19.64	60.00	-40.36	QP	NEUTRAL
10	6.22	-7.64	9.62	0.06	9.92	11.96	50.00	-38.04	Average	NEUTRAL
11	12.78	-0.76	9.74	0.11	9.95	19.04	60.00	-40.96	QP	NEUTRAL
12	12.78	-9.14	9.74	0.11	9.95	10.66	50.00	-39.34	Average	NEUTRAL

Note:

1. Result Level = Read Level + LISN Factor + Pulse Limiter Factor + Cable loss.
2. If QP Result complies with AV limit, AV Result is deemed to comply with AV limit.
3. Test setup: RBW: 200 Hz (9 kHz—150 kHz), 9 kHz (150 kHz—30 MHz).
4. Step size: 80Hz (0.009MHz-0.15MHz), 4 kHz (0.15MHz-30MHz), Scan time: auto.

TR-4-E-010 Conducted Emission Test Result

Test Site : DDT 1# Shield Room D:\2023 CE report data\Q23071126-2E JBuds ANC\FCC.EM6
Test Date : 2023-08-16 **Tested By** : Johnson Huang
EUT : True Wireless Earbuds **Model Number** : JBuds ANC
Power Supply : AC 120V/60Hz **Test Mode** : TX mode
Condition : TEMP:23.2°C, RH:53.1%, BP:101.1kPa **LISN** : 2022 1# ENV216/LINE
Memo : BLE

Data: 8

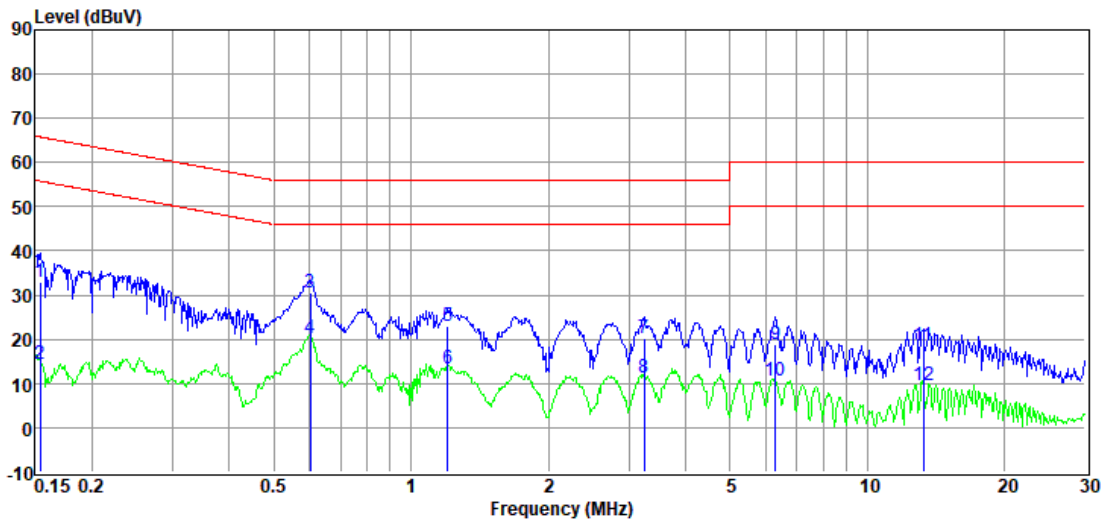

Item (Mark)	Freq. (MHz)	Read Level (dBuV)	LISN Factor (dB)	Cable Loss (dB)	Pulse Limiter Factor (dB)	Result Level (dBuV)	Limit Line (dBuV)	Over Limit (dB)	Detector	Phase
1	0.15	13.32	9.62	0.01	9.94	32.89	65.78	-32.89	QP	LINE
2	0.15	-5.16	9.62	0.01	9.94	14.41	55.78	-41.37	Average	LINE
3	0.60	10.94	9.65	0.01	9.92	30.52	56.00	-25.48	QP	LINE
4	0.60	0.67	9.65	0.01	9.92	20.25	46.00	-25.75	Average	LINE
5	1.20	3.55	9.53	0.02	9.91	23.01	56.00	-32.99	QP	LINE
6	1.20	-6.19	9.53	0.02	9.91	13.27	46.00	-32.73	Average	LINE
7	3.24	0.68	9.53	0.04	9.91	20.16	56.00	-35.84	QP	LINE
8	3.24	-8.34	9.53	0.04	9.91	11.14	46.00	-34.86	Average	LINE
9	6.29	-0.69	9.58	0.06	9.92	18.87	60.00	-41.13	QP	LINE
10	6.29	-8.87	9.58	0.06	9.92	10.69	50.00	-39.31	Average	LINE
11	13.27	-1.24	9.71	0.11	9.95	18.53	60.00	-41.47	QP	LINE
12	13.27	-10.30	9.71	0.11	9.95	9.47	50.00	-40.53	Average	LINE

Note:

1. Result Level = Read Level + LISN Factor + Pulse Limiter Factor + Cable loss.
2. If QP Result complies with AV limit, AV Result is deemed to comply with AV limit.
3. Test setup: RBW: 200 Hz (9 kHz—150 kHz), 9 kHz (150 kHz—30 MHz).
4. Step size: 80Hz (0.009MHz-0.15MHz), 4 kHz (0.15MHz-30MHz), Scan time: auto.

14. Antenna Requirements

14.1. Limit

For intentional device, according to FCC 47 CFR Section 15.203, an intentional radiator shall be designed to ensure that no antenna other than that furnished by the responsible party shall be used with the device. And according to FCC 47 CFR Section 15.247 (b), if transmitting antennas of directional gain greater than 6 dBi are used, the power shall be reduced by the amount in dB that the directional gain of the antenna exceeds 6 dBi.

14.2. Result

The antenna used for this product is FPC antenna and that no antenna other than that furnished by the responsible party shall be used with the device, the maximum peak gain of the left side transmit antenna is -0.26 dBi and right side is -1.05 dBi.

15. Test Setup Photograph





16. Photos of the EUT

Please refer to appendix I.

END OF REPORT