

2DH5 Left side 2480_30~1000

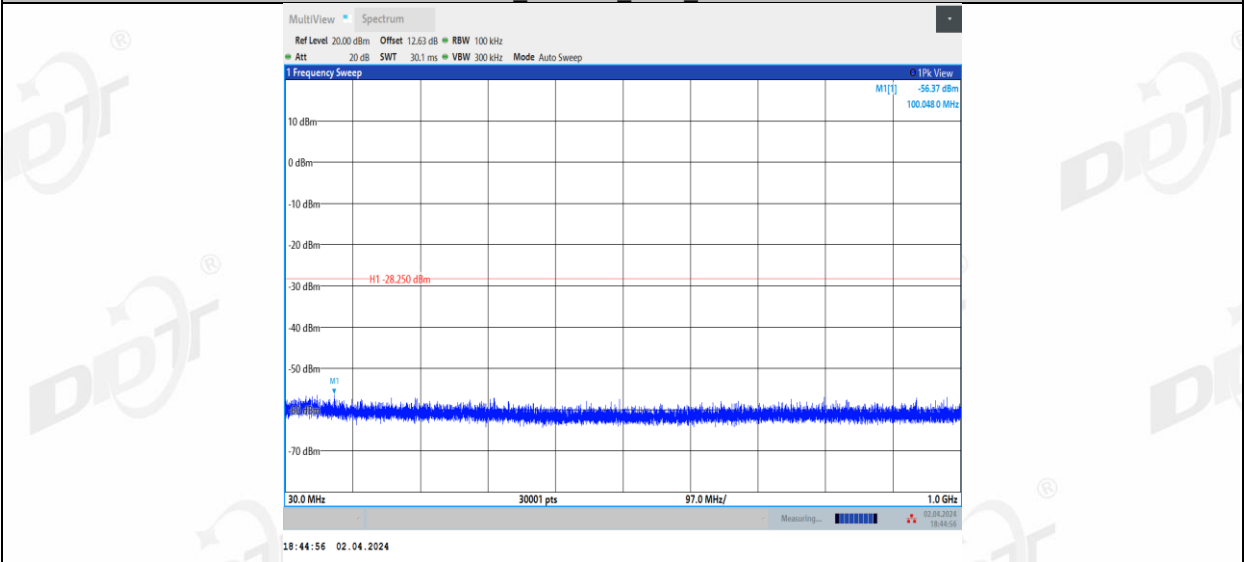

2DH5 Left side 2480_1000~26500

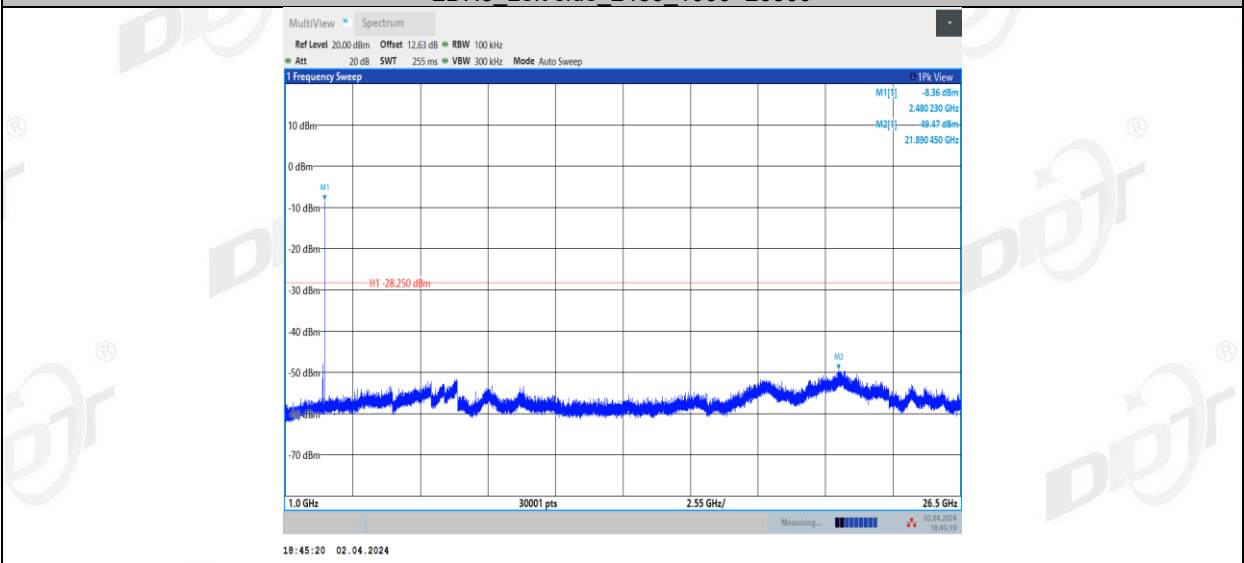

2DH5 Right side 2480_0~Reference

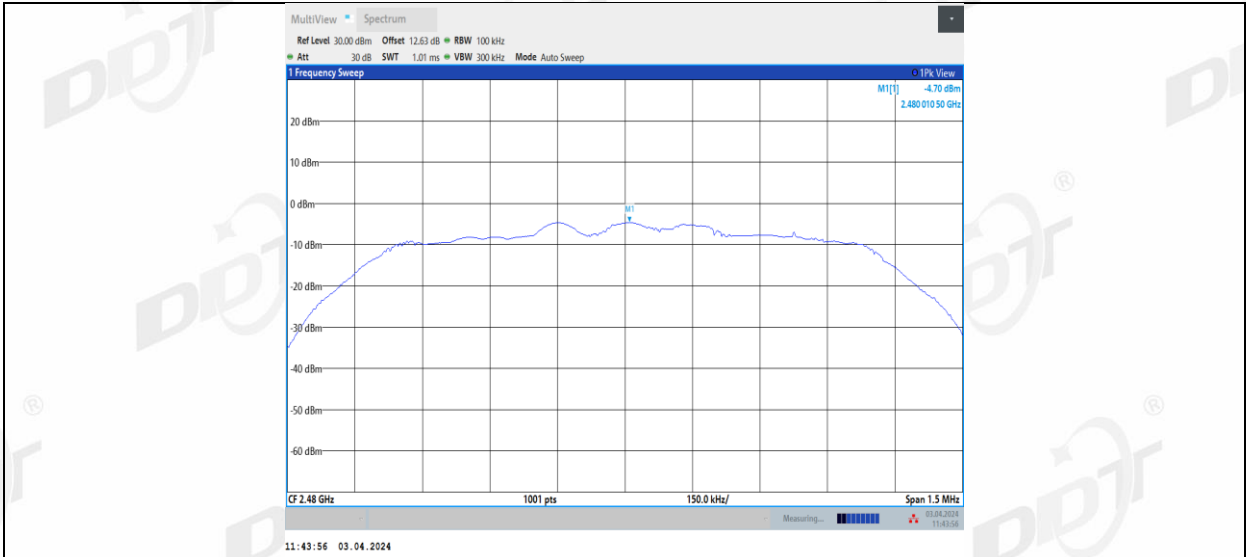

2DH5 Right side 2480 30~1000

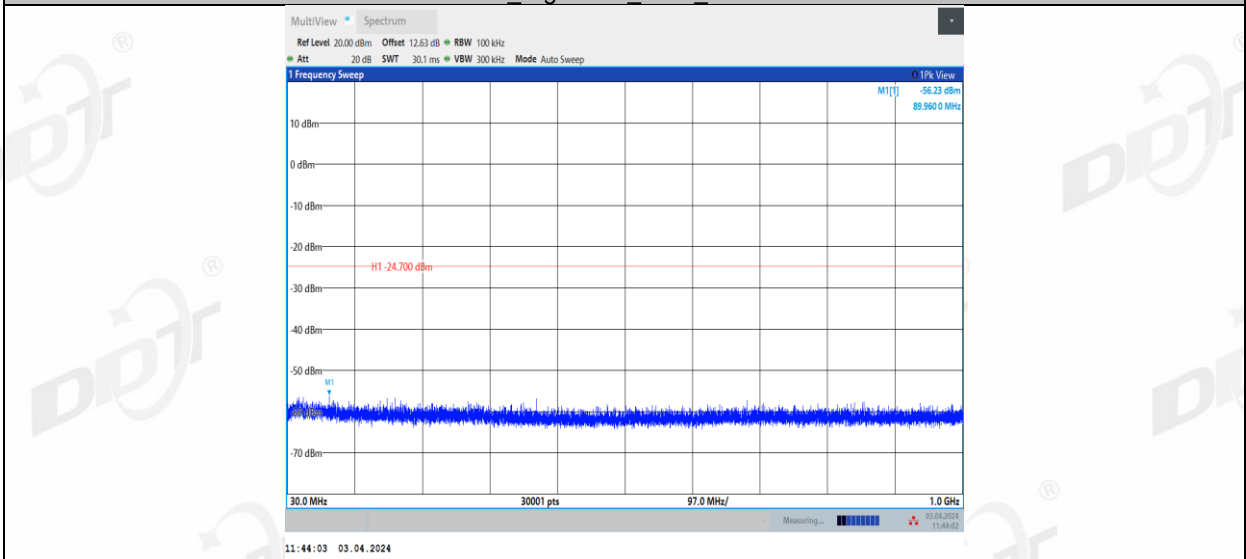

2DH5 Right side 2480 1000~26500

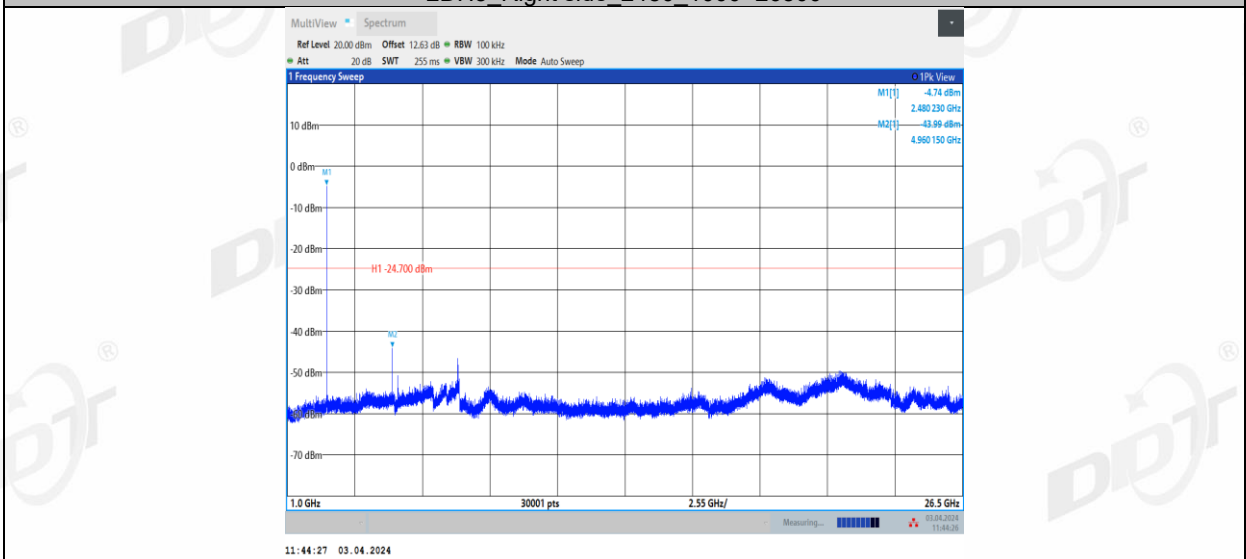

3DH5 Left side 2402 0~Reference

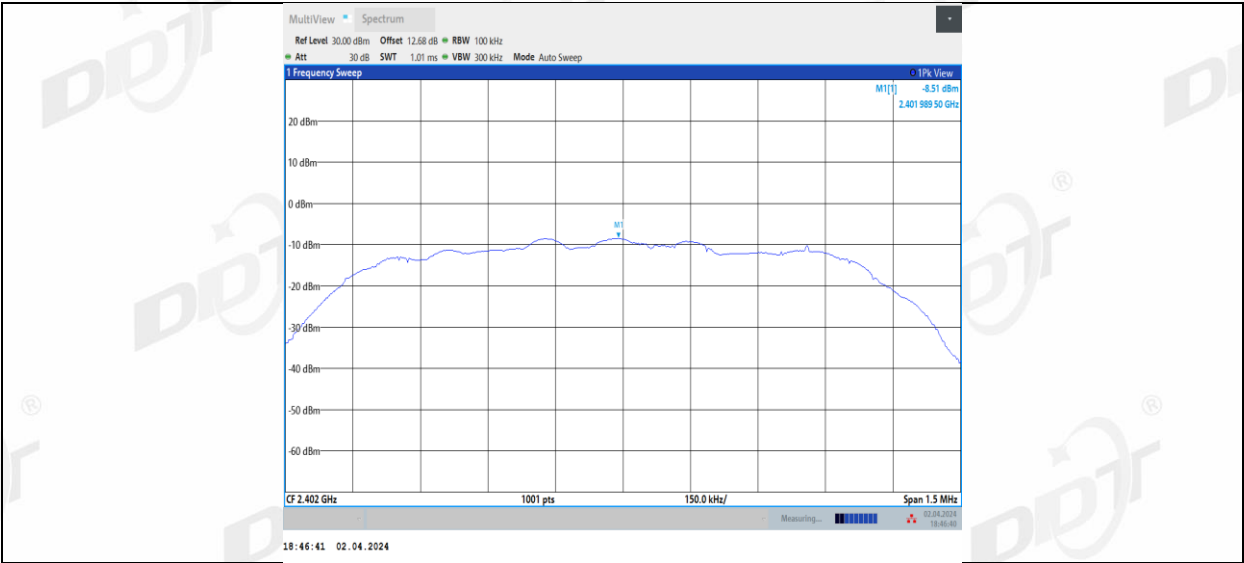

3DH5 Left side 2402 30~1000

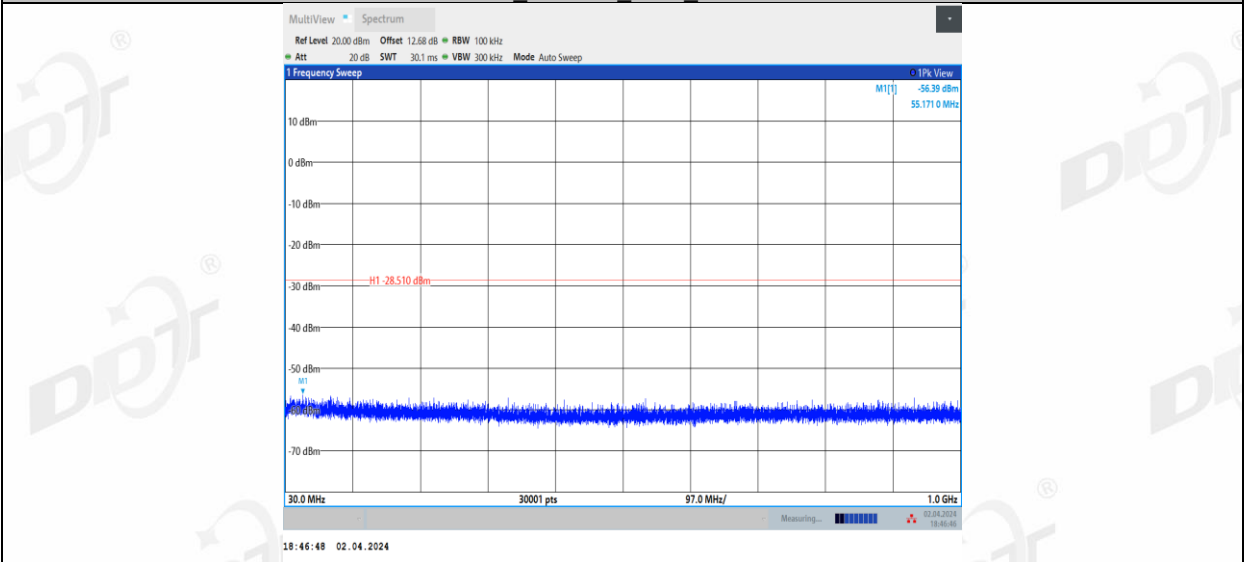

3DH5 Left side 2402 1000~26500

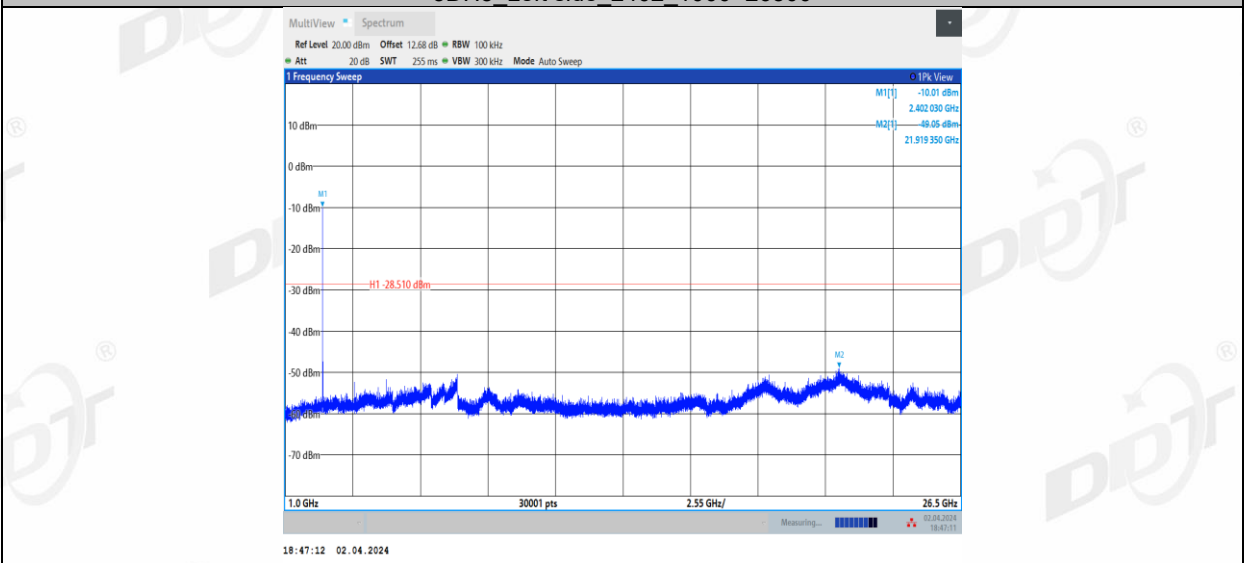

3DH5 Right side 2402 0~Reference

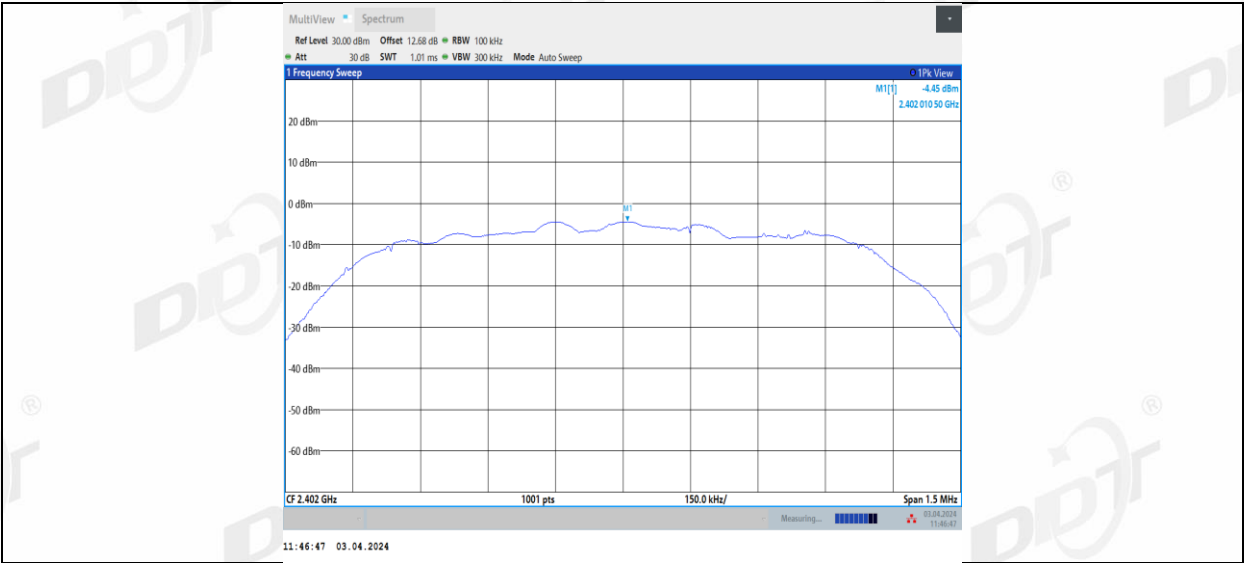

3DH5_Right side_2402_30~1000

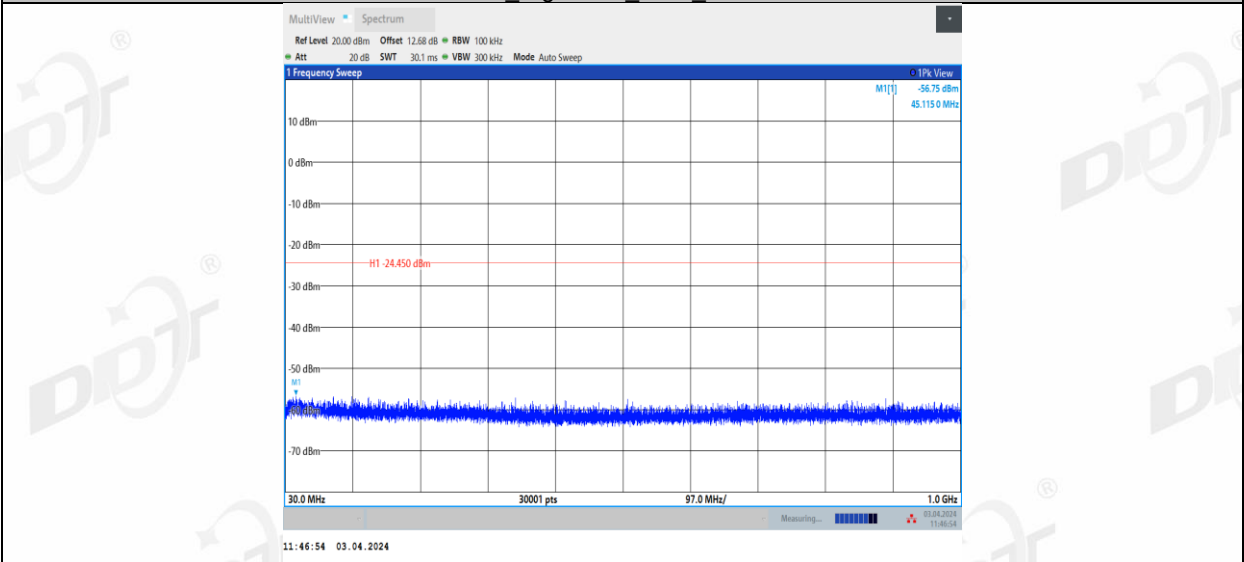

3DH5_Right side_2402_1000~26500

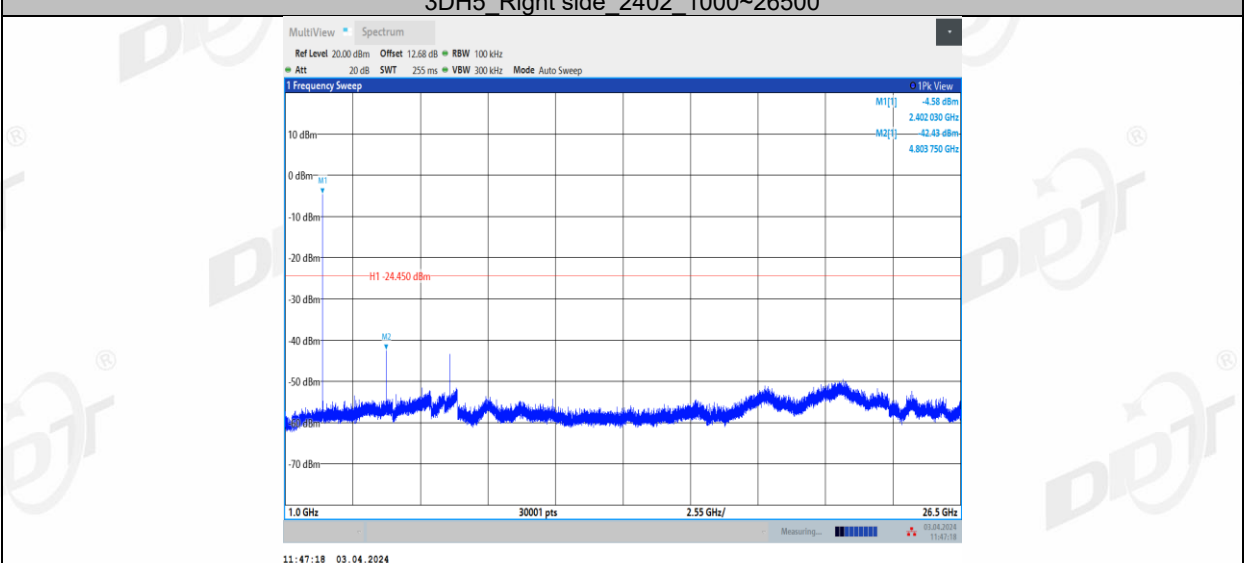

3DH5_Left side_2441_0~Reference

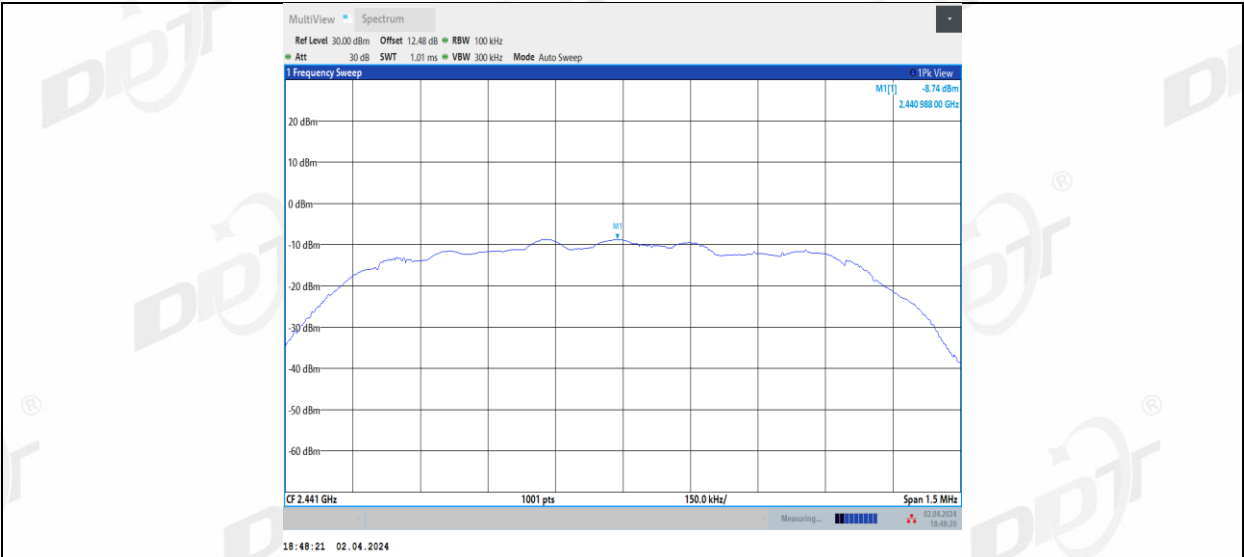

3DH5 Left side 2441 30~1000

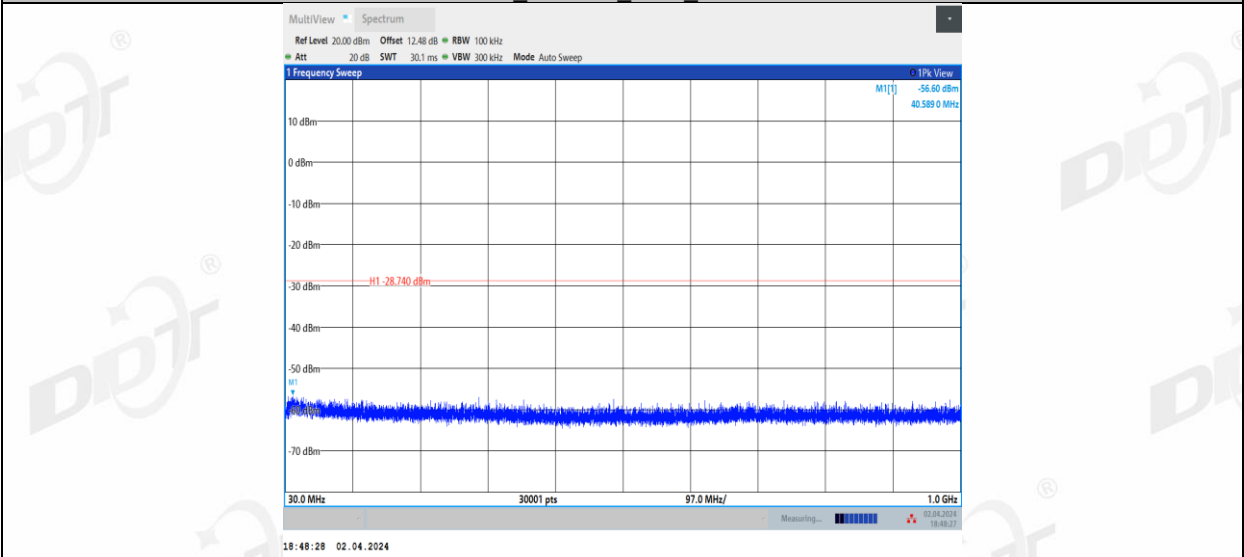

3DH5 Left side 2441 1000~26500

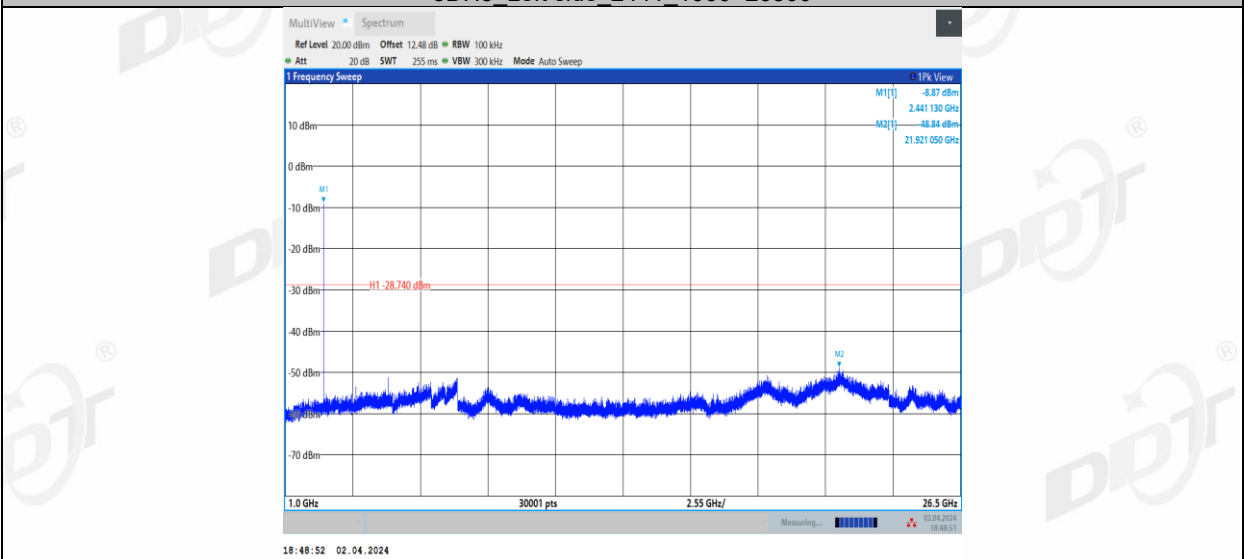

3DH5 Right side 2441 0~Reference

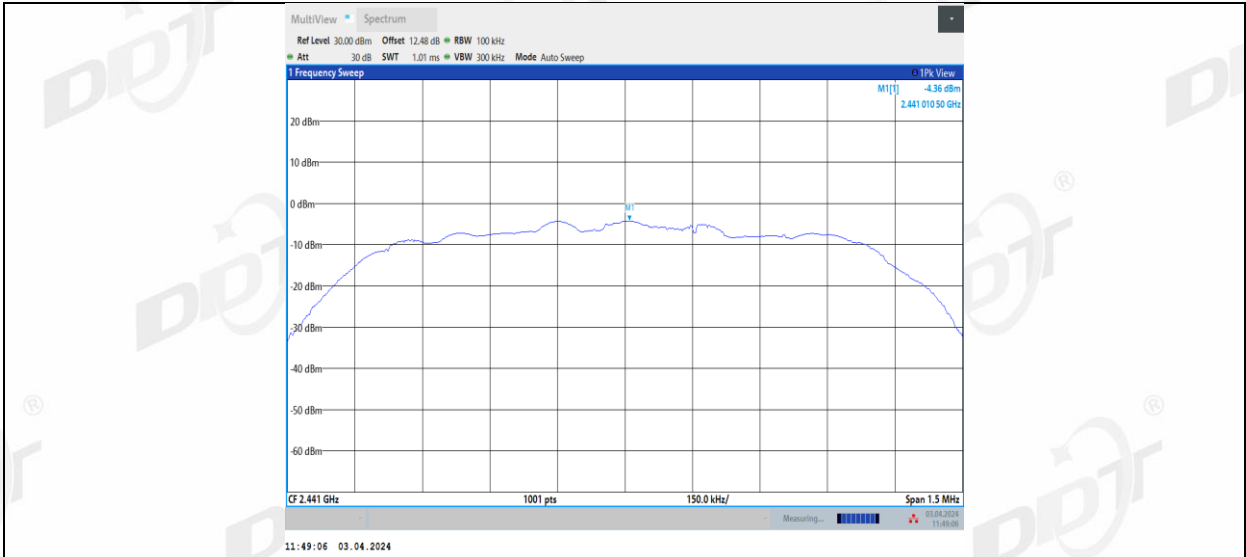

3DH5 Right side 2441 30~1000

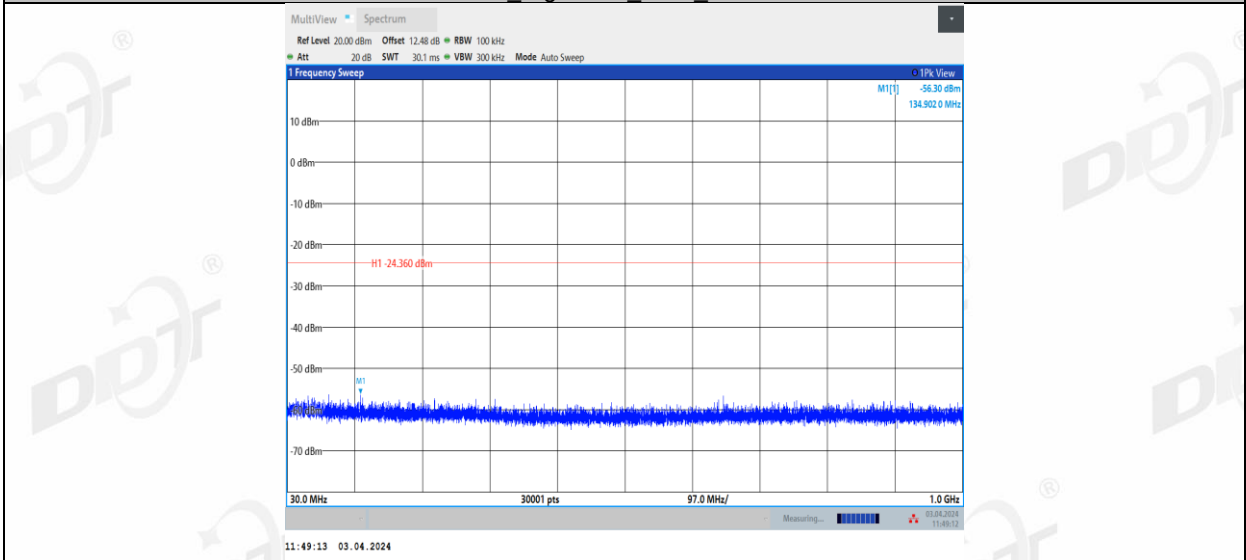

3DH5 Right side 2441 1000~26500

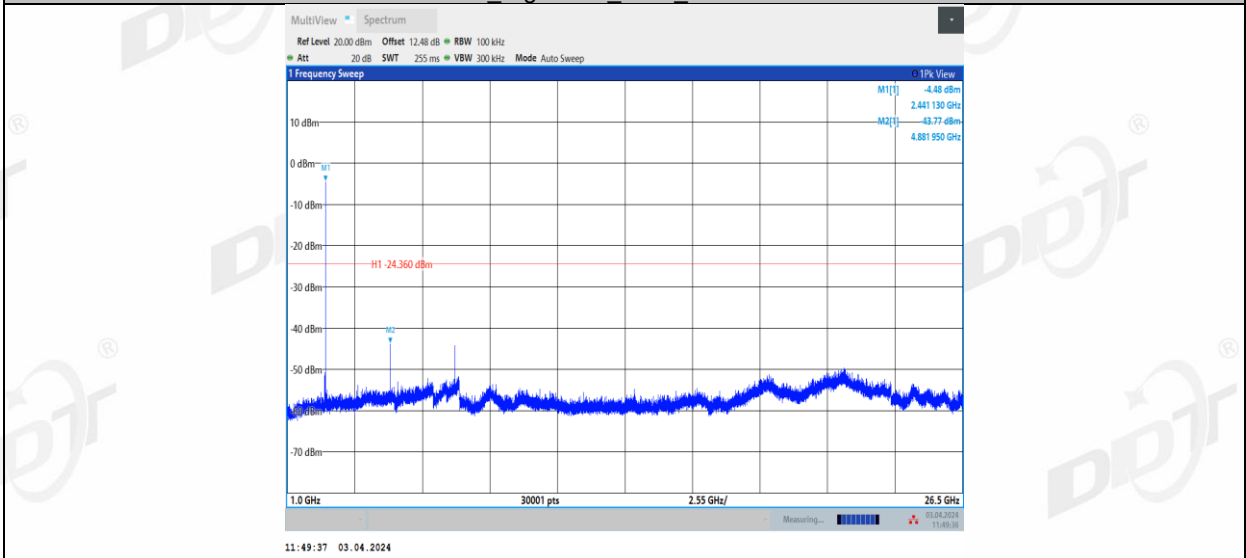

3DH5 Left side 2480 0~Reference

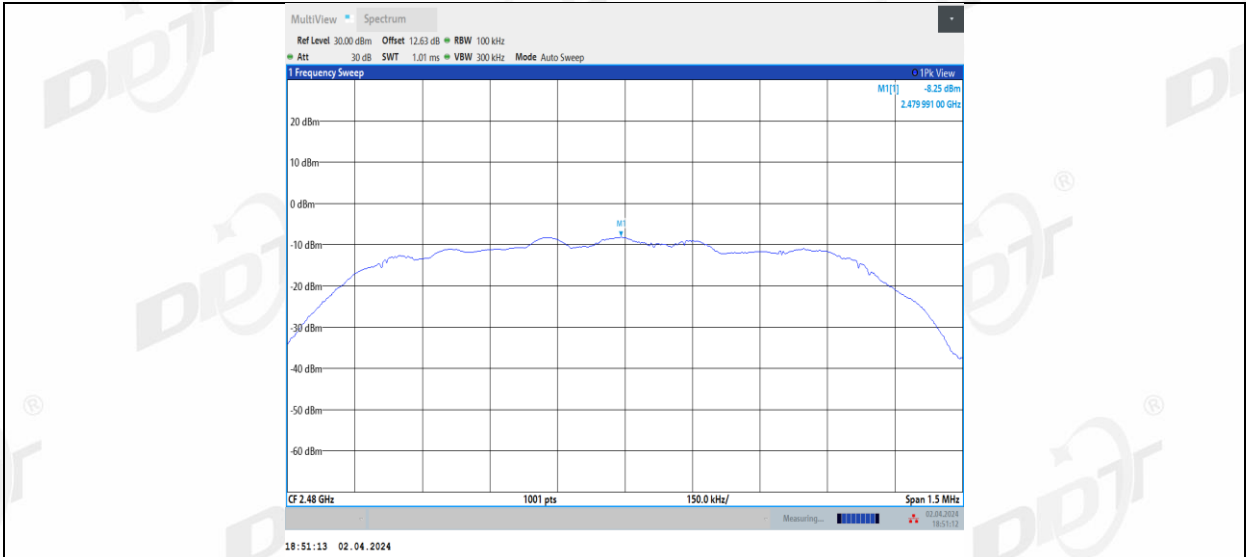

3DH5 Left side 2480_30~1000

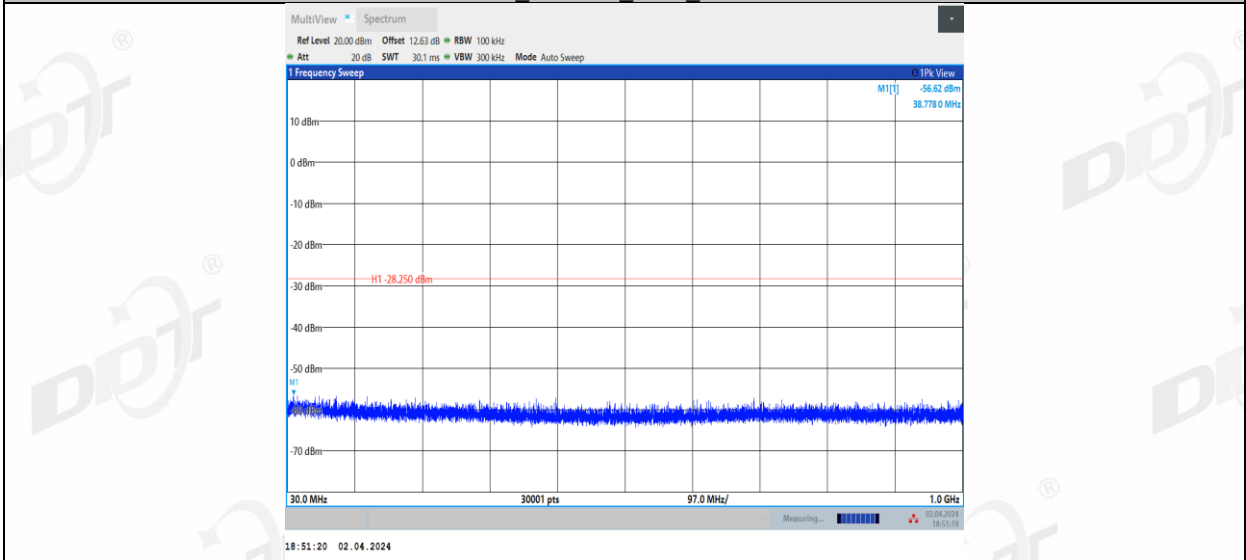

3DH5 Left side 2480_1000~26500

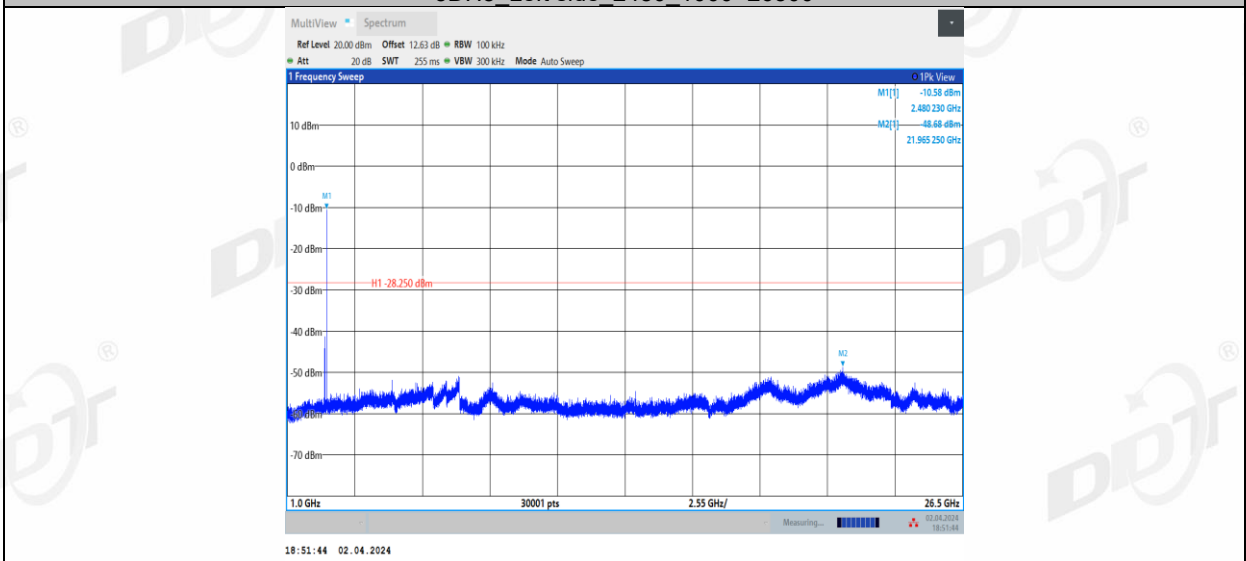

3DH5 Right side 2480_0~Reference

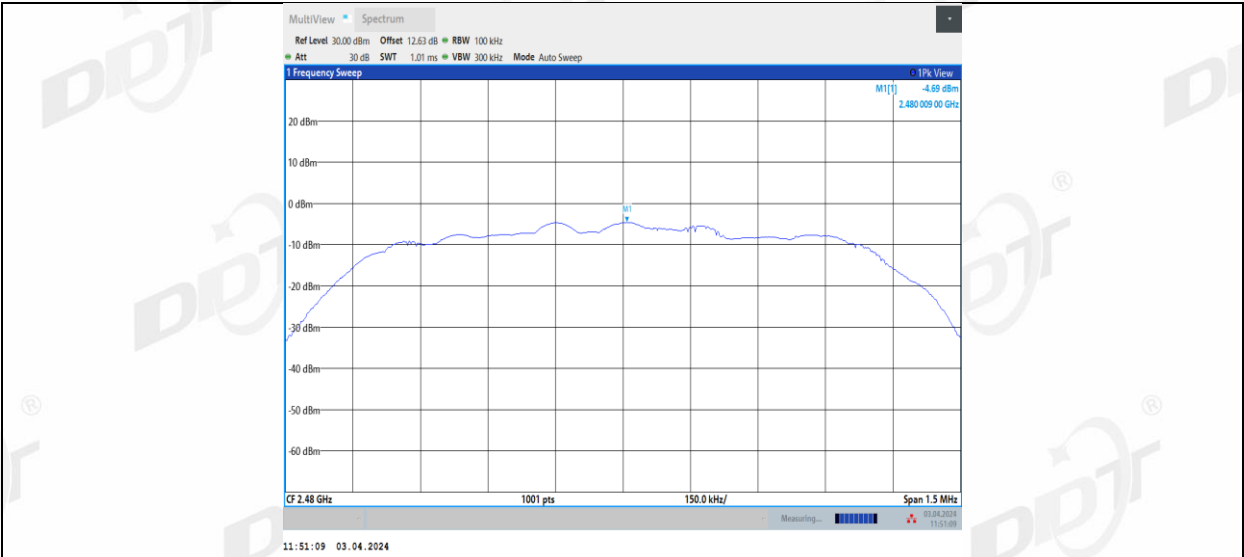

3DH5_Right side_2480_30~1000

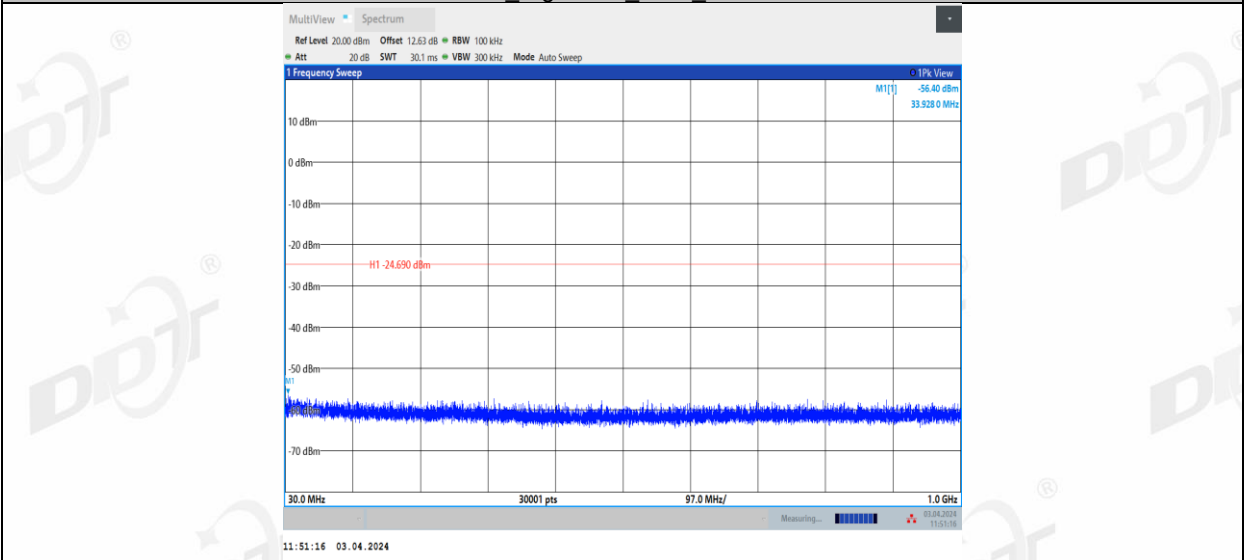

3DH5_Right side_2480_1000~26500

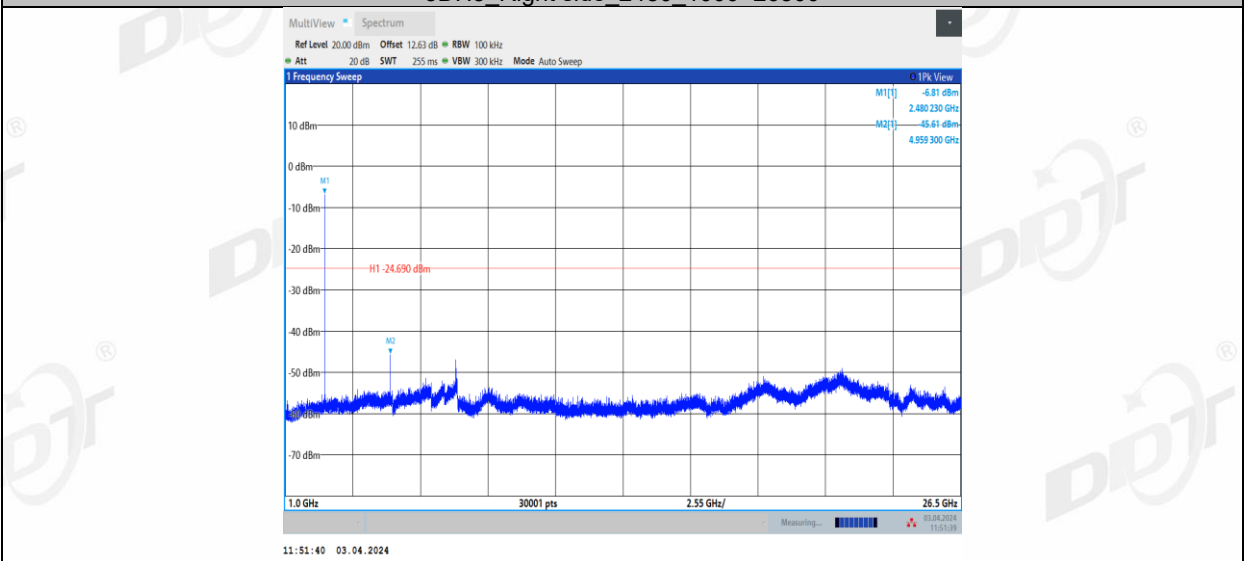

12. Duty cycle

12.1. Block diagram of test setup

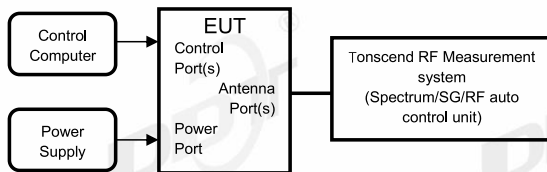

12.2. Limit

Just for Report.

12.3. Test procedure

- (1) Connected the EUT's antenna port to the Spectrum Analyzer by suitable attenuator, The cable loss and attenuator loss have been put into spectrum analyzer as amplitude offset. set the Spectrum Analyzer as below:
 - Centre Frequency: The centre frequency of the middle hopping channel.
 - Resolution BW: 10 MHz.
 - Video BW: 10 MHz.
 - Span: Zero span.
 - Detector: Peak.
 - Trace Mode: Clear Write.
 - Sweep: Video Trigger
- (2) When the trace is complete, measure the sending time of 1 burst and the duty cycle of 1 burst cycle.
- (3) Calculate dwell time follow below formula:
Duty cycle= Pulse's on time / Burst cycle

12.4. Test result

Test Engineer:	Zora Zhang	Test Site:	RF Measurement System 4#
Ambient Condition:	25°C,49.8%RH	Test Date:	2024.03.14-2024.04.03
Test Power Supply:	Battery	Sample Number:	S23122824-01

Test Mode	Antenna	Frequency [MHz]	ON Time [ms]	Period [ms]	Duty Cycle [%]	Duty Cycle Factor[dB]
DH5	Left side	2402	2.98	4.08	73.04	1.36
	Right side	2402	2.98	4.09	72.86	1.38
	Left side	2441	2.98	4.09	72.86	1.38
	Right side	2441	2.97	4.08	72.79	1.38
	Left side	2480	2.98	4.08	73.04	1.36
	Right side	2480	2.97	4.08	72.79	1.38
2DH5	Left side	2402	2.99	4.10	72.93	1.37
	Right side	2402	2.98	4.10	72.68	1.39
	Left side	2441	2.99	4.10	72.93	1.37
	Right side	2441	2.99	4.10	72.93	1.37
	Left side	2480	2.98	4.10	72.68	1.39
	Right side	2480	2.99	4.09	73.11	1.36
3DH5	Left side	2402	2.99	4.11	72.75	1.38
	Right side	2402	2.98	4.10	72.68	1.39
	Left side	2441	2.98	4.10	72.68	1.39
	Right side	2441	2.99	4.11	72.75	1.38
	Left side	2480	2.99	4.09	73.11	1.36
	Right side	2480	2.99	4.10	72.93	1.37

12.5. Test graphs

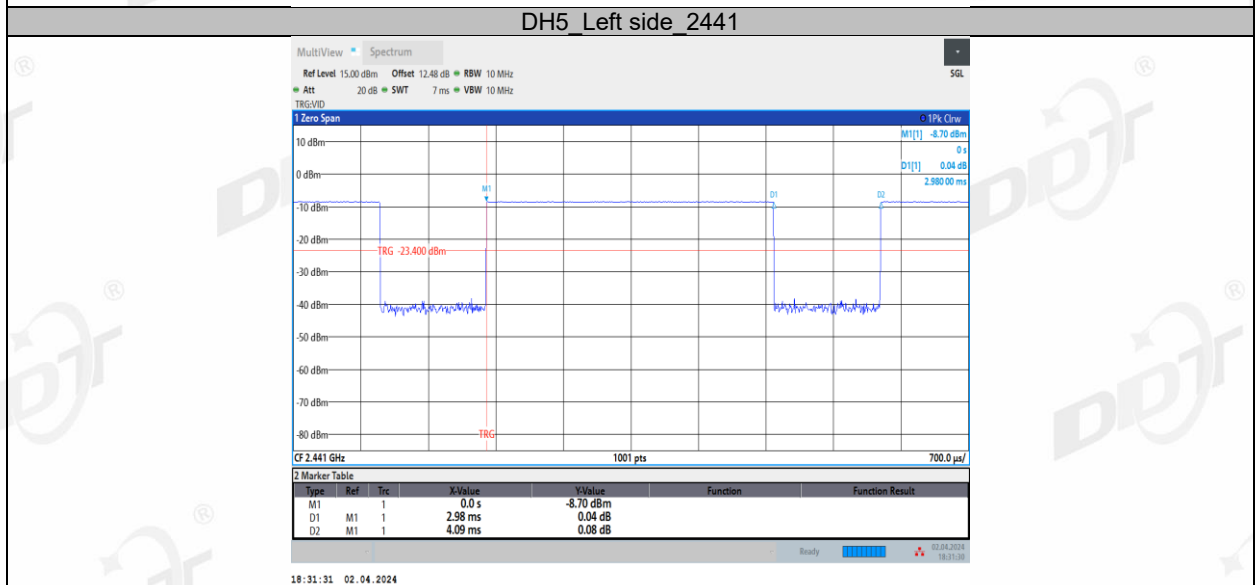
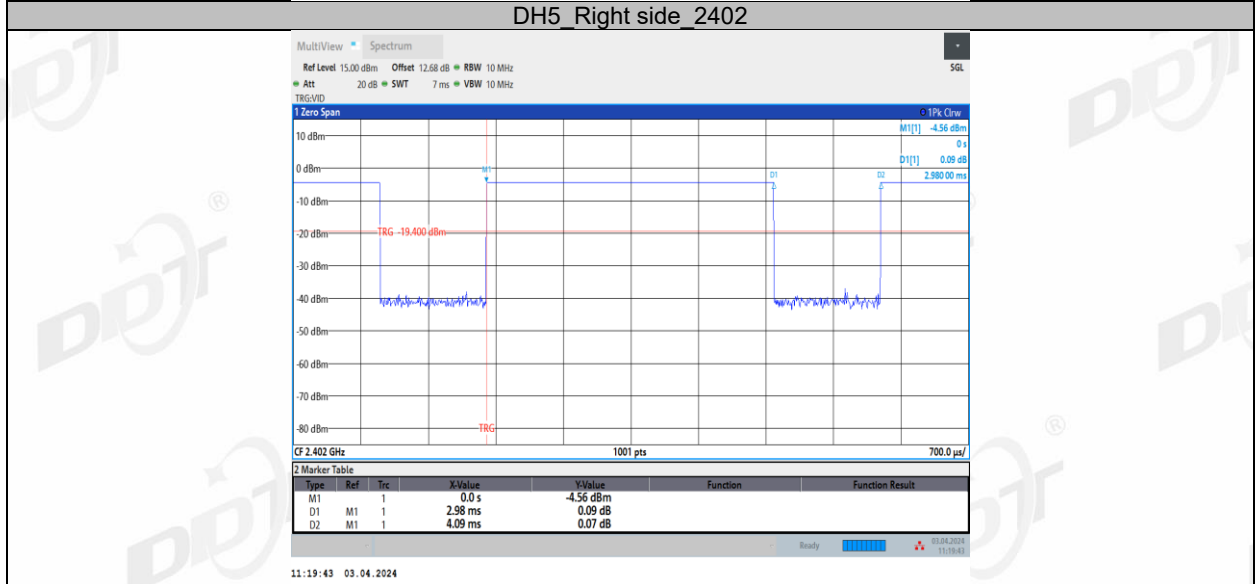
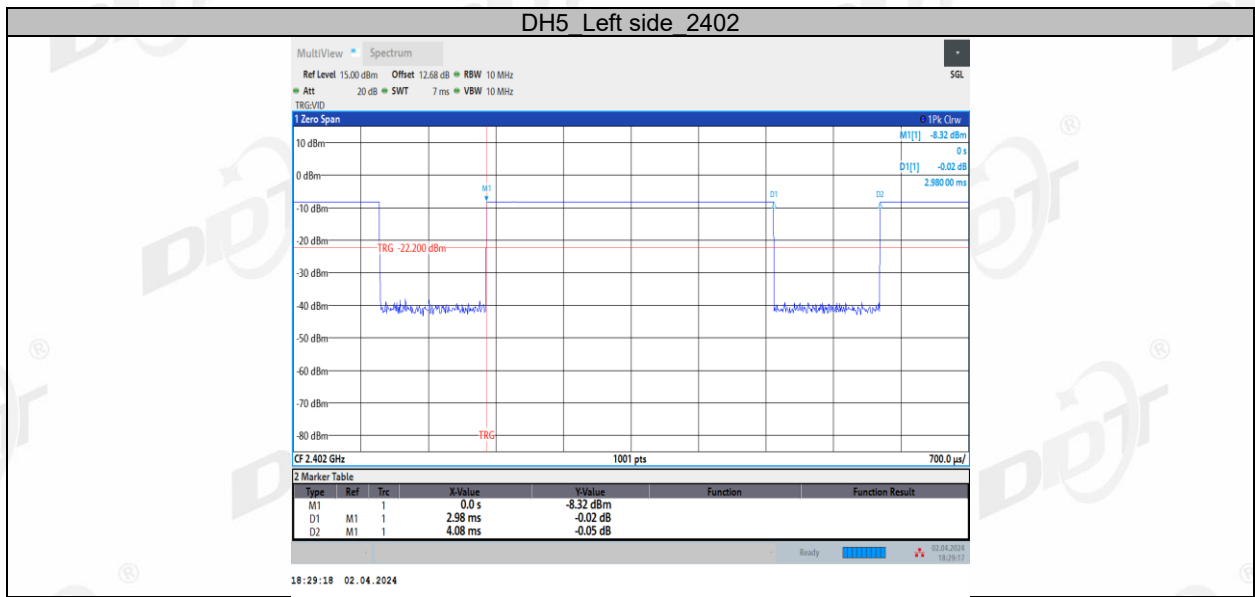

DH5 Right side 2441

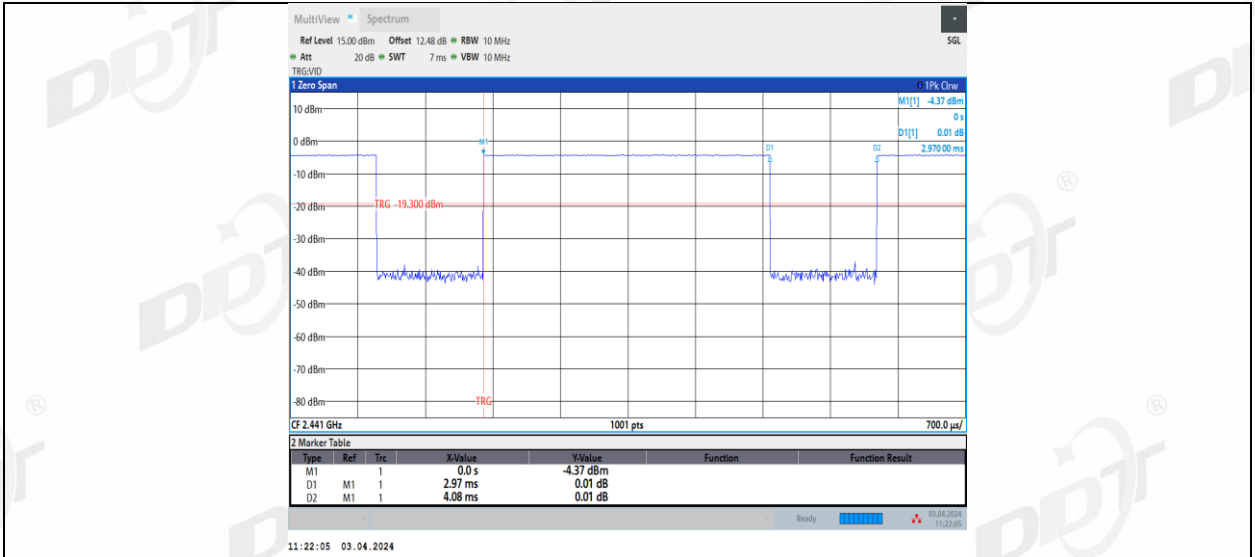

DH5 Left side 2480

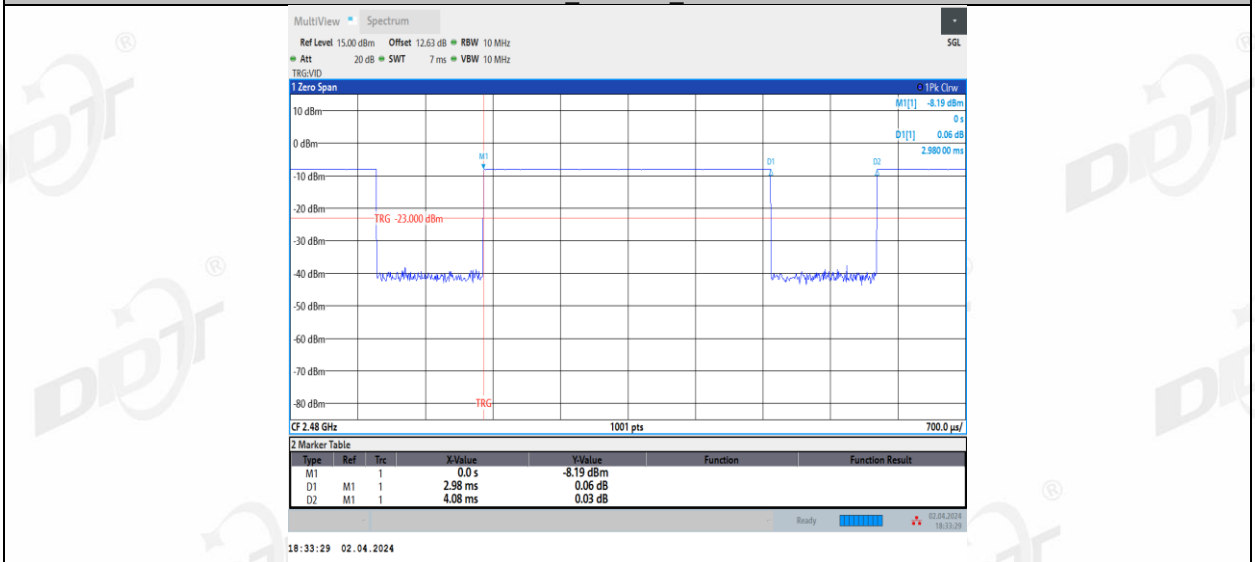

DH5 Right side 2480

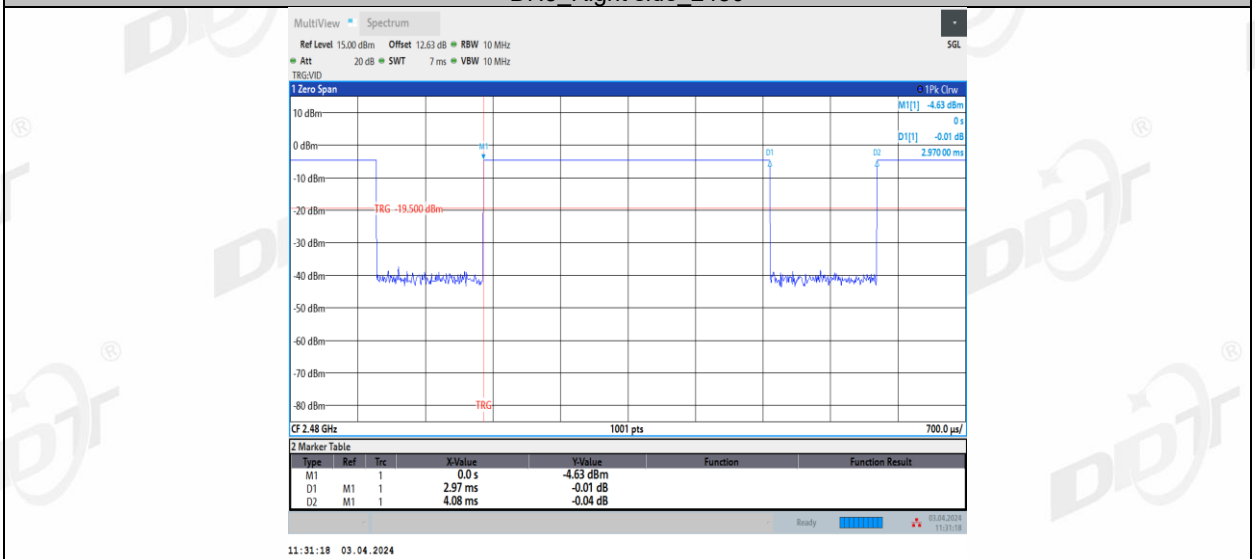

2DH5 Left side 2402

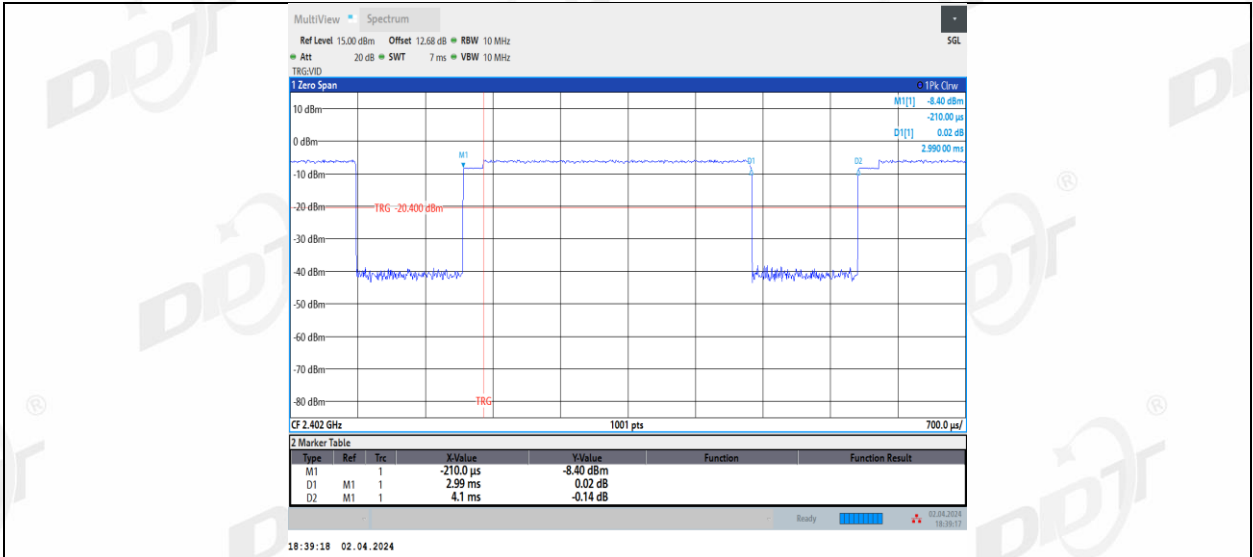

2DH5_Right side_2402

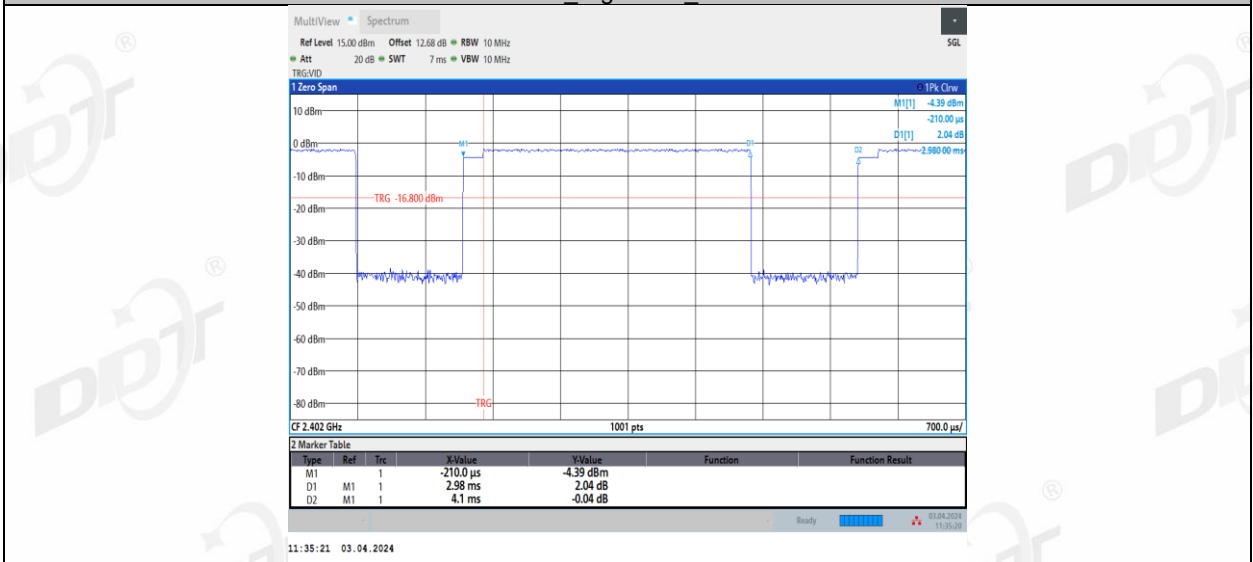

2DH5_Left side_2441

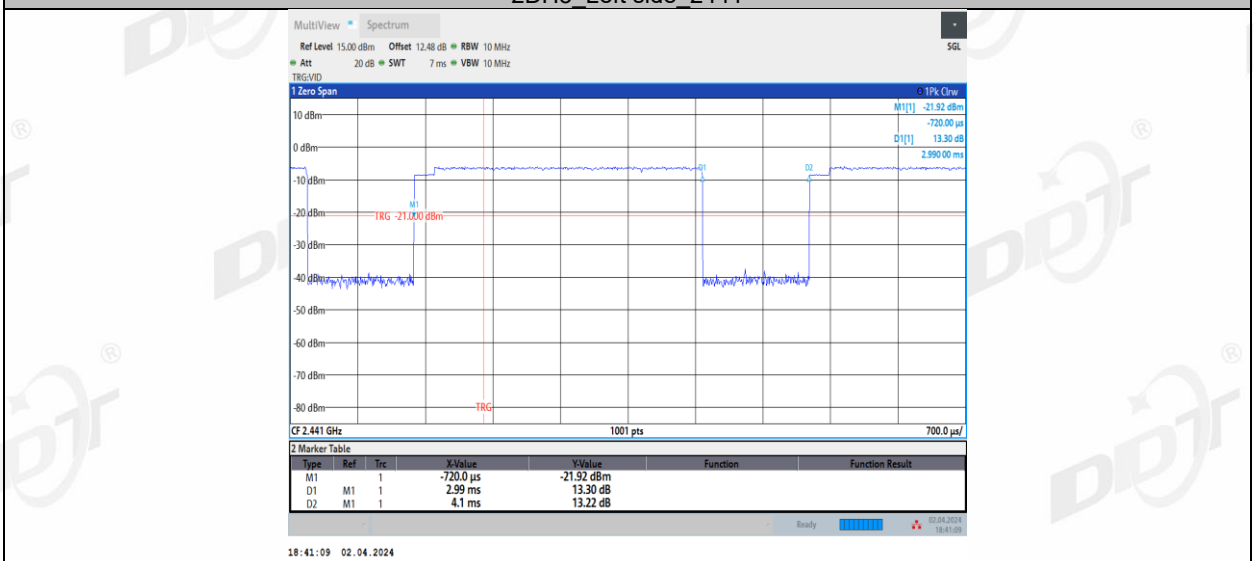

2DH5_Right side_2441

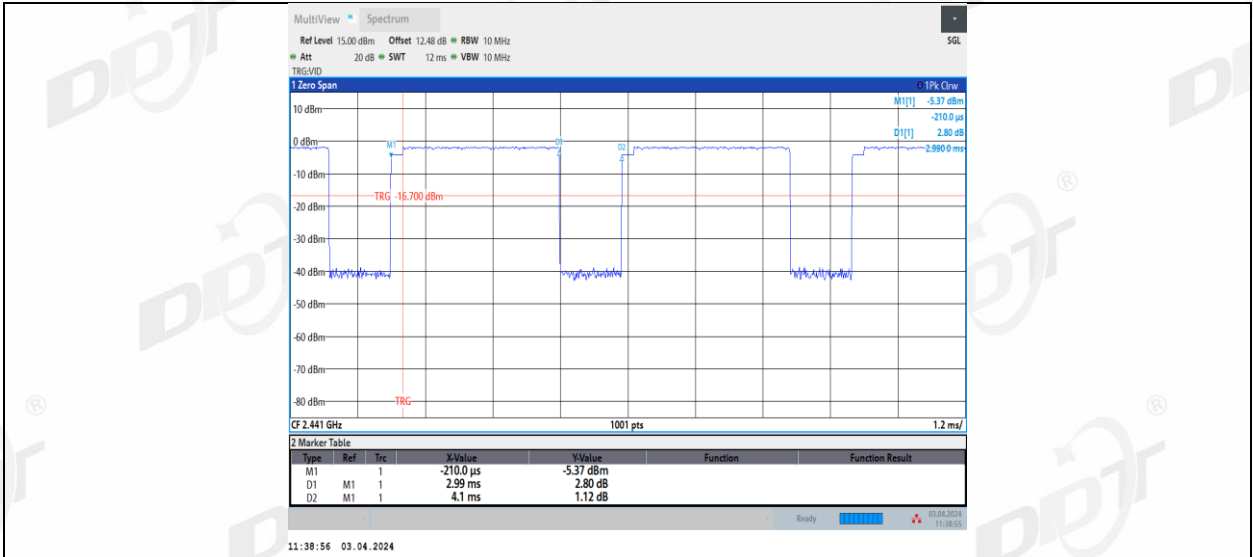

2DH5 Left side 2480

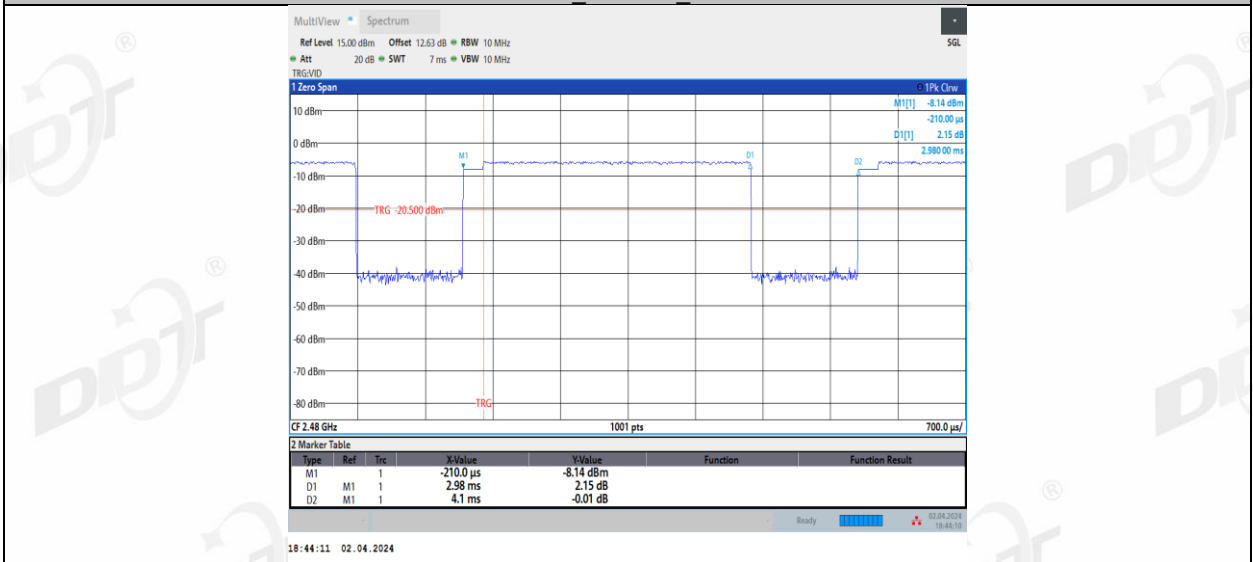

2DH5 Right side 2480

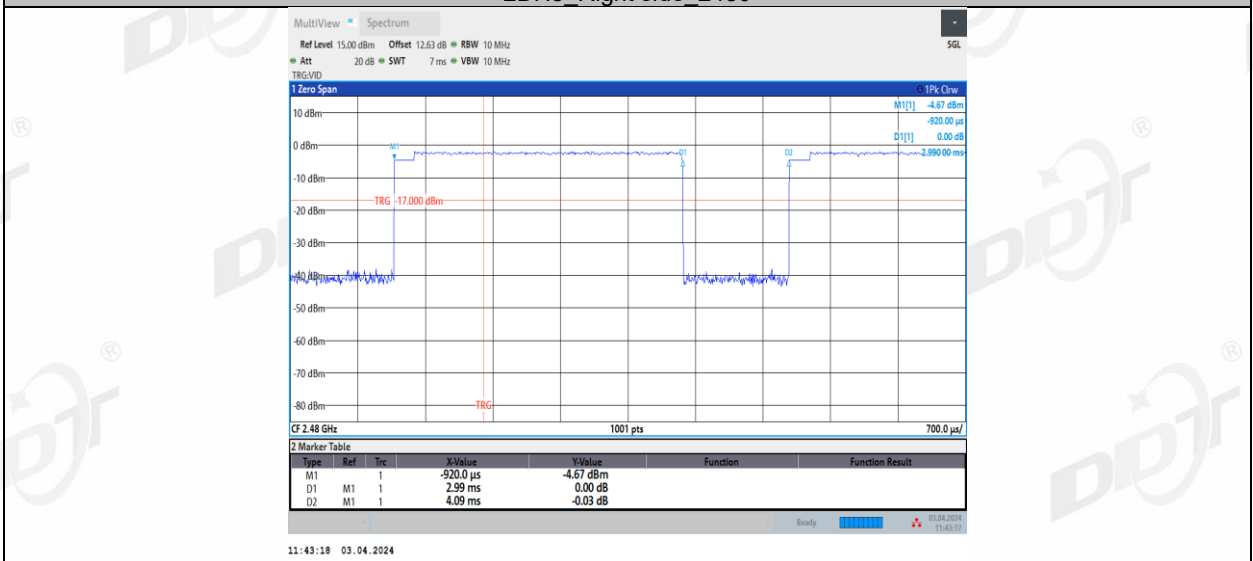

3DH5 Left side 2402

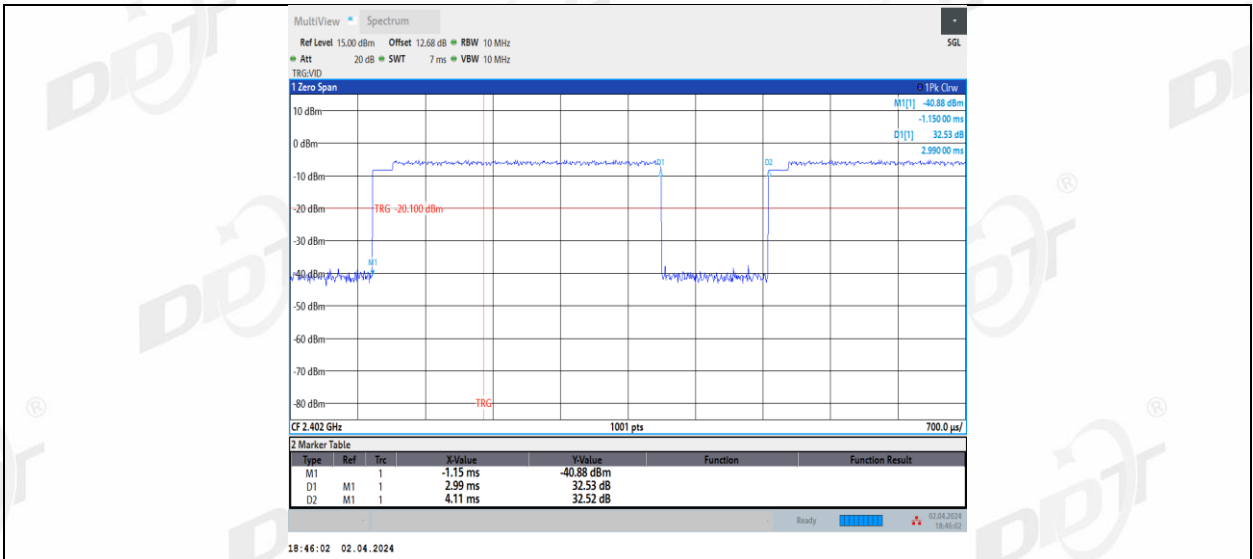

3DH5_Right side_2402

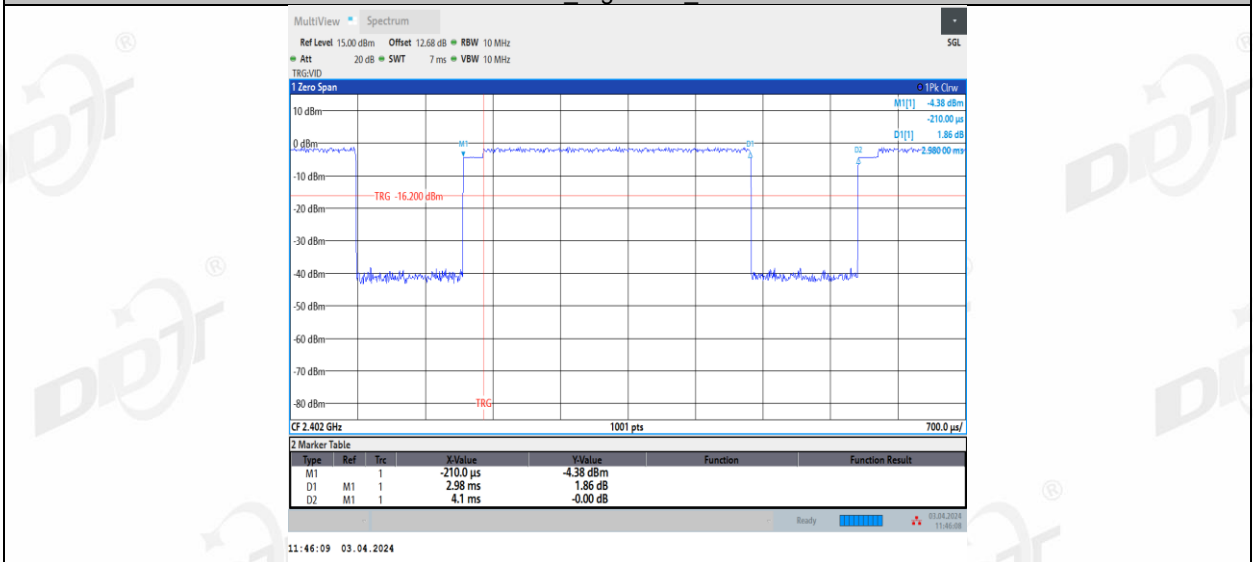

3DH5_Left side_2441

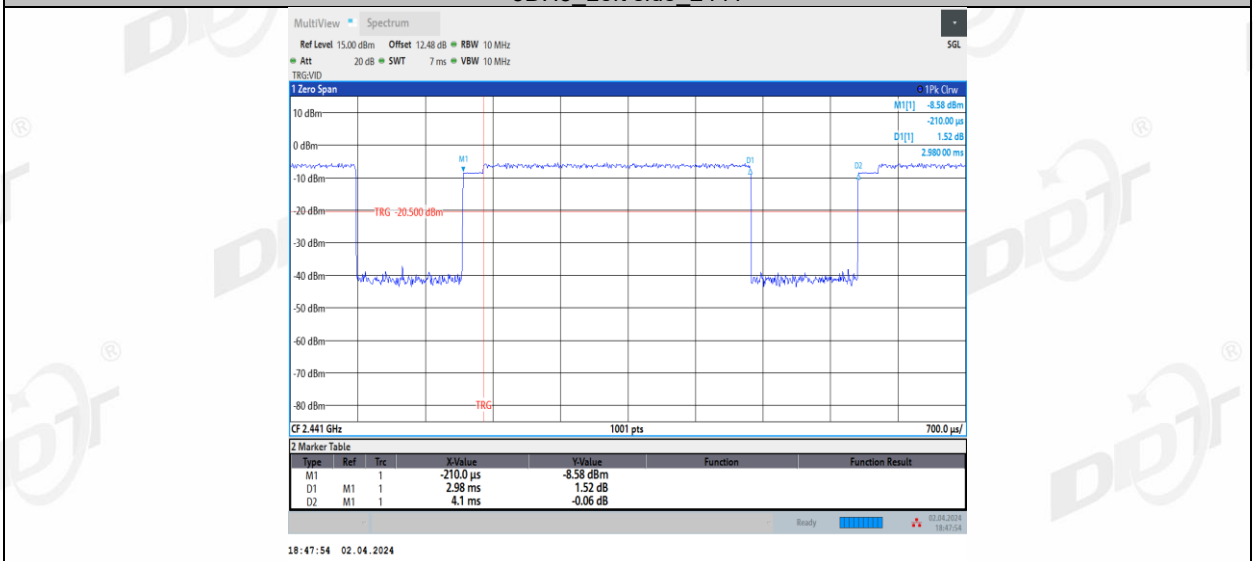

3DH5_Right side_2441

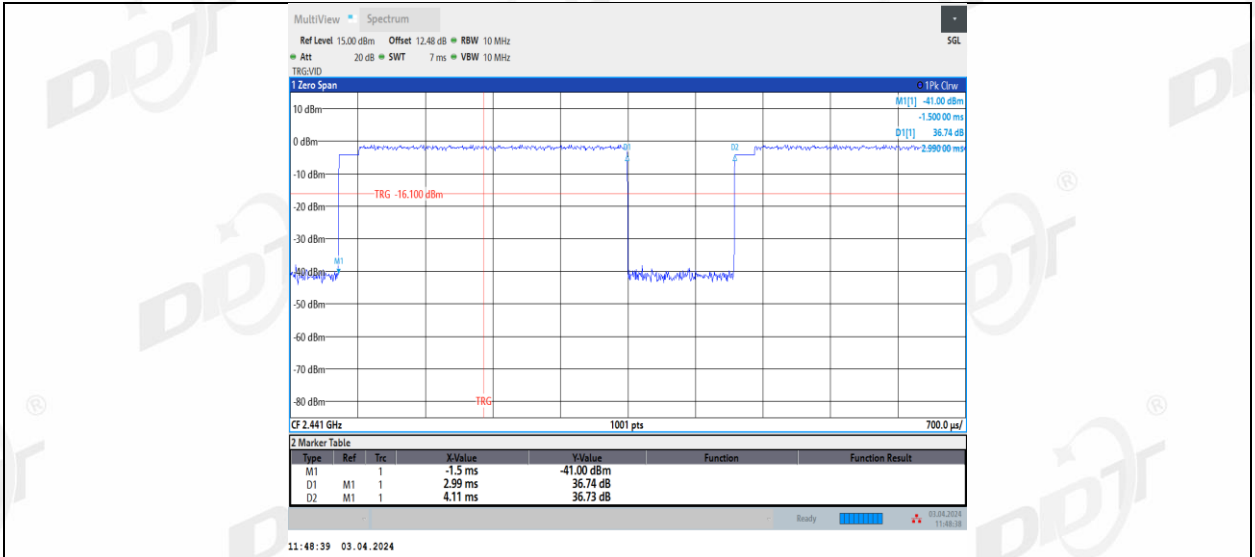

3DH5 Left side_2480

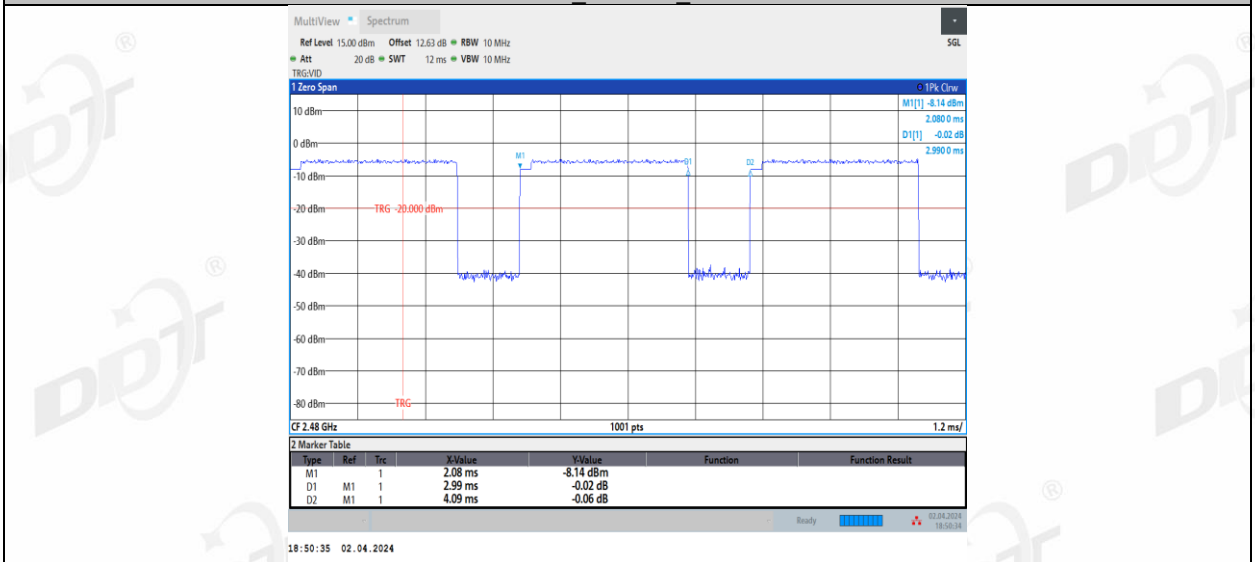

3DH5 Right side_2480

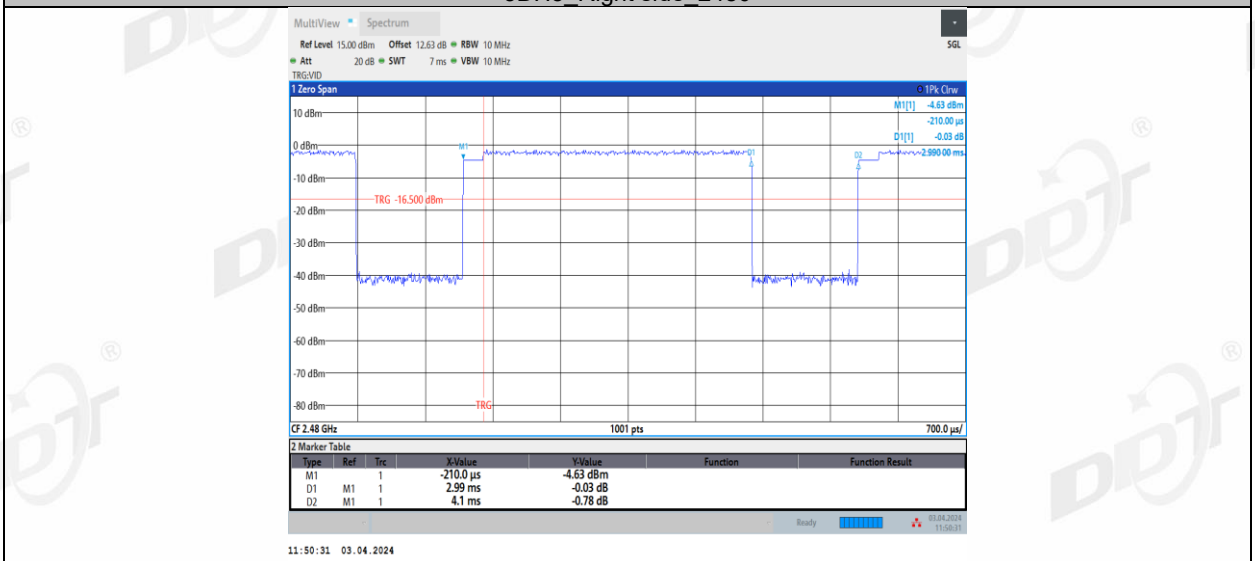

13. Antenna Requirements

13.1. Limit

For intentional device, according to FCC 47 CFR Section 15.203, an intentional radiator shall be designed to ensure that no antenna other than that furnished by the responsible party shall be used with the device. And according to FCC 47 CFR Section 15.247 (b), if transmitting antennas of directional gain greater than 6 dBi are used, the power shall be reduced by the amount in dB that the directional gain of the antenna exceeds 6 dBi.

13.2. Result

The antenna used for this product as Antenna information described in section 2.1 of the report, and there is no other antenna than that furnished by the responsible party shall be used with the device.

14.Radiated Emission

14.1. Test equipment

Equipment	Manufacturer	Model No.	Serial No.	Cal Due To
High pass filter	Micro-Tronics	HPM50108	DDT-ZC00560	2024/05/14
RF Cable	N/A	W24.02 HL-562	DDT-ZC04022	2024/04/20
RF Cable	N/A	W13.02 AP1-X2	DDT-ZC04023	2024/04/20
RF cable	Zhongke Junchuang	JCT26S-NJ-NJ-1.5M	DDT-ZC02762	2024/04/20
Pre-amplifier	COM-POWER	PAM-118A	DDT-ZC01293	2024/07/14
ELECTRIC AND MAGNETIC FIELD ANALYZER	Narda	EHP-200A	DDT-ZC01401	2024/09/20
Broad-Band Horn Antenna	Schwarzbeck	BBHA 9170	DDT-ZC00506	2024/04/25
Hochgewinn-Hornantenne	Schwarzbeck Mess-Elektronik	BBHA 9120 D	DDT-ZC02129	2025/09/17
Micro-Tronics filters	REBES	BRM50716	DDT-ZC03240	/
Micro-Tronics filters	REBES	BRM50702	DDT-ZC03242	/
EMI TEST RECEIVER	R&S	ESU26	DDT-ZC01909	2024/04/22
Trilog Broadband Antenna	Schwarzbeck	VULB 9163	DDT-ZC02050	2024/07/11
Pre-amplifier	COM-POWER	PAM-840A	DDT-ZC01693	2024/04/26
RF cable	Yuhu Technology	JCTB810-NJ-NJ-9M	DDT-ZC02538	2024/04/22
High pass filter	Micro-Tronics	HPM50102	DDT-ZC00561	2024/05/14
RF cable	Yuhu Technology	ZT26S-SMAJ-SMAJ-1M	DDT-ZC02037	2024/04/22
High Pass filter	XIANXINGBO	XBLBQ-GTA67	DDT-ZC02179	2024/05/14
PSA Series Spectrum Analyzer	Agilent	E4447A	DDT-ZC00517	2024/04/22
Active Loop Antenna	Schwarzbeck	FMZB1519	DDT-ZC00524	2025/09/10

14.2. Block diagram of test setup

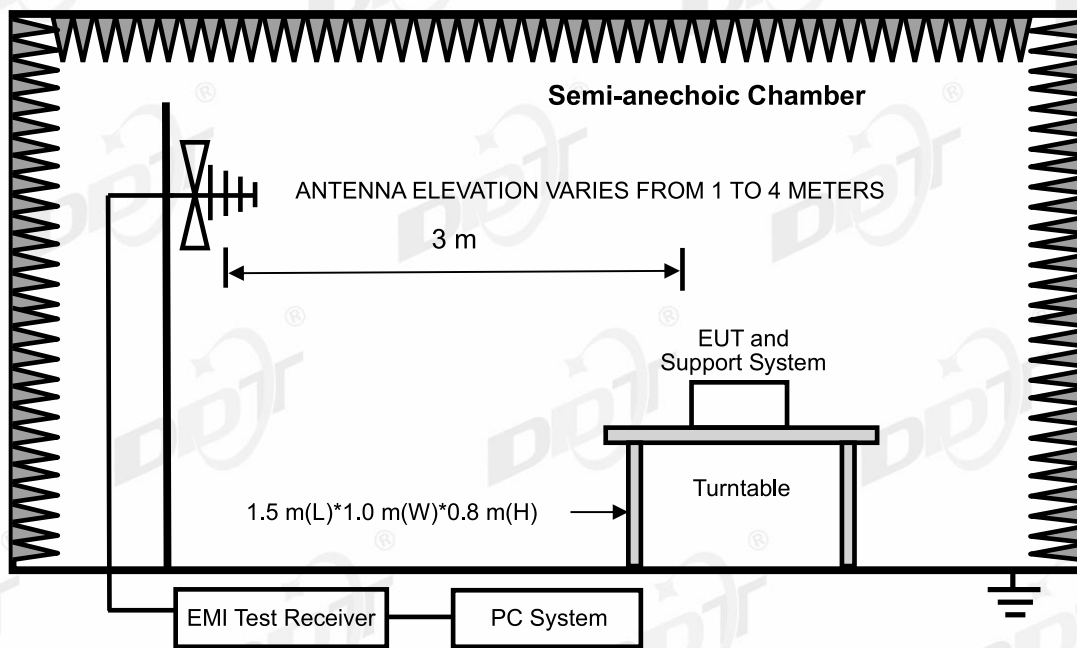
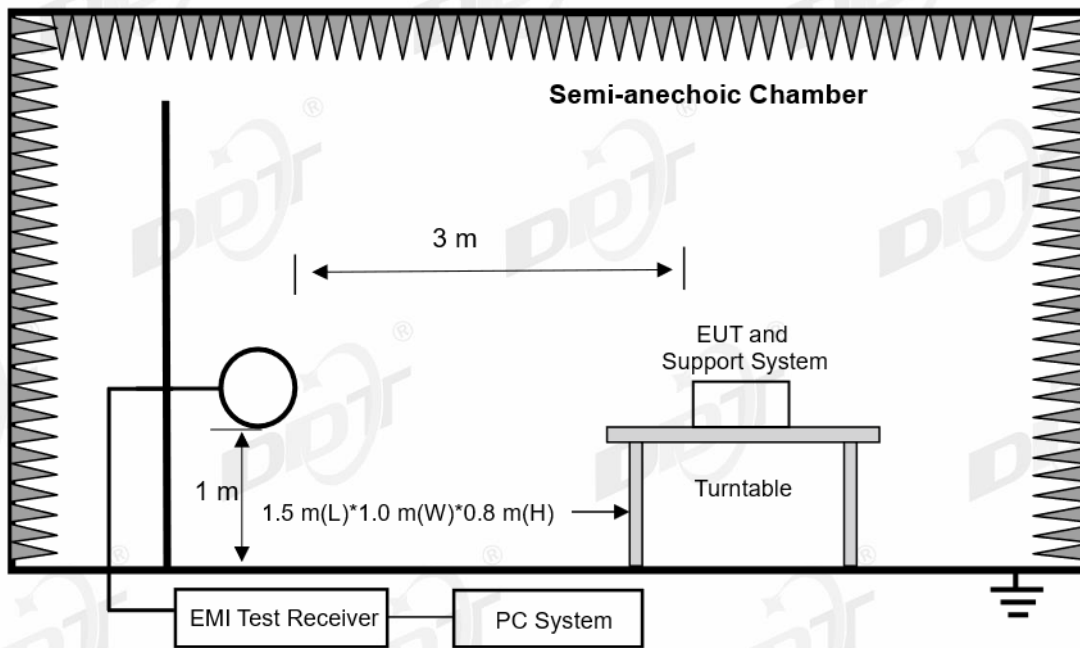

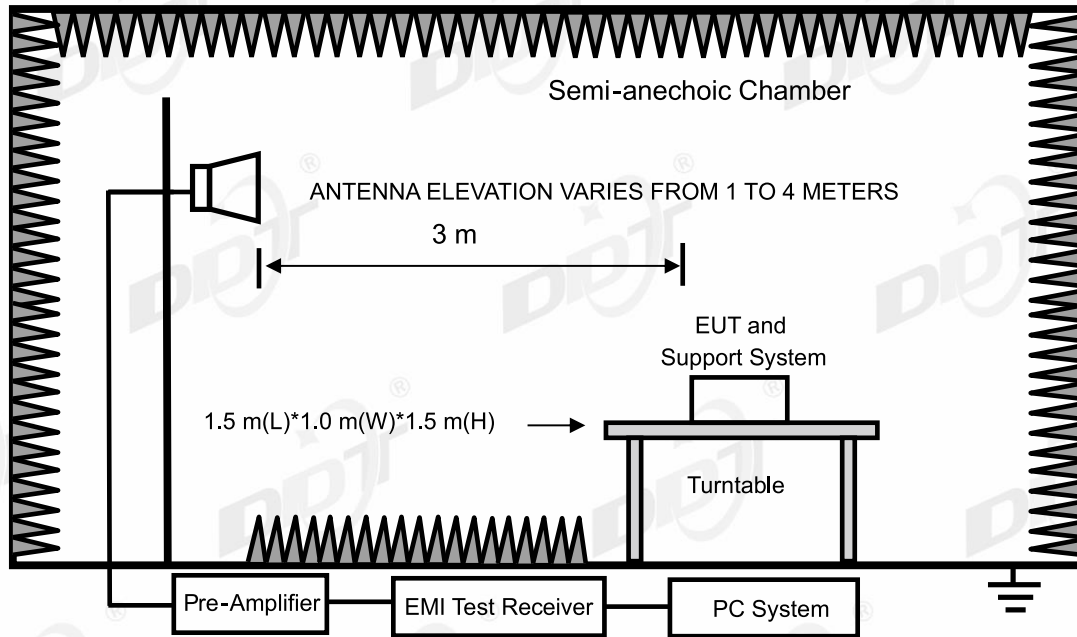

14.3. Limits

(1) FCC 15.205 Restricted frequency band

MHz	MHz	MHz	GHz
0.090-0.110	16.42-16.423	399.9-410	4.5-5.15
0.495-0.505	16.69475-16.69525	608-614	5.35-5.46
2.1735-2.1905	16.80425-16.80475	960-1240	7.25-7.75
4.125-4.128	25.5-25.67	1300-1427	8.025-8.5
4.1772&4.17775	37.5-38.25	1435-1626.5	9.0-9.2
4.2072&4.20775	73-74.6	1645.5-1646.5	9.3-9.5
6.215-6.218	74.8-75.2	1660-1710	10.6-12.7
6.26775-6.26825	108-121.94	1718.8-1722.2	13.25-13.4
6.31175-6.31225	123-138	2200-2300	14.47-14.5
8.291-8.294	149.9-150.05	2310-2390	15.35-16.2
8.362-8.366	156.52475-156.52525	2483.5-2500	17.7-21.4
8.37625-8.38675	156.7-156.9	2690-2900	22.01-23.12
8.41425-8.41475	162.0125-167.17	3260-3267	23.6-24.0
12.29-12.293	167.72-173.2	3332-3339	31.2-31.8
12.51975-12.52025	240-285	3345.8-3358	36.43-36.5
12.57675-12.57725	322-335.4	3600-4400	(²)
13.36-13.41			

1Until February 1, 1999, this restricted band shall be 0.490-0.510 MHz

2Above 38.6

(2) FCC 15.209 Limit

FREQUENCY MHz	DISTANCE Meters	FIELD STRENGTHS LIMIT	
		mV/m	dB(mV)/m
0.009 ~ 0.490	300	2400/F(kHz)	67.6-20log(F)
0.490 ~ 1.705	30	24000/F(kHz)	87.6-20log(F)
1.705 ~ 30.0	30	30	29.54
30 ~ 88	3	100	40.0
88 ~ 216	3	150	43.5
216 ~ 960	3	200	46.0
960 ~ 1000	3	500	54.0
Above 1000	3	74.0 dB(mV)/m (Peak) 54.0 dB(mV)/m (Average)	

Note:

(1) The emission limits shown in the above table are based on measurements employing a CISPR QP detector except for the frequency bands 9 - 90 kHz, 110 - 490 kHz and above 1000 MHz, radiated emissions limits in these three bands are based on measurements employing an average detector.

(2) At frequencies below 30 MHz, measurement may be performed at a distance closer than that specified, and the limit at closer measurement distance can be extrapolated by below formula:

$$\text{Limit}_{3\text{m}}(\text{dBuV/m}) = \text{Limit}_{30\text{m}}(\text{dBuV/m}) + 40\text{Log}(30\text{m}/3\text{m})$$

(3) Limit for this EUT

The emissions appearing within 15.205 restricted frequency bands shall not exceed the limits shown in 15.209, all the other emissions shall be at least 20 dB below the fundamental emissions or comply with 15.209 limits.

14.4. Assistant equipment used for test

Assistant equipment	Manufacturer	Model number	Description	other
Laptop	Lenovo	00425-00000-00002-AA135	Fixed frequency computer	N/A

14.5. Test procedure

(1) EUT was placed on a non-metallic table, 80 cm above the ground plane inside a semi-anechoic chamber for below 1G and 150 cm above the ground plane inside a fully-anechoic chamber for above 1G.

(2) Test antenna was located 3 m from the EUT on an adjustable mast, and the antenna used as below table.

Test frequency range	Test antenna used	Test antenna distance
9 kHz - 30 MHz	Active Loop antenna	3 m
30 MHz - 1 GHz	Trilog Broadband Antenna	3 m

1 GHz - 18 GHz	Double Ridged Horn Antenna(1 GHz-18 GHz)	3 m
18 GHz - 40 GHz	Horn Antenna(18 GHz-40 GHz)	1 m

According ANSI C63.10:2013 clause 6.4.6 and 6.5.3, for measurements below 30 MHz, Antenna was located 3 m from EUT, the loop antenna was positioned in three antenna orientations (parallel, perpendicular, and round-parallel), for each measurement antenna alignment, the EUT shall be rotated through 0° to 360° on a turntable, and the lowest height of the magnetic antenna shall be 1 m above the ground. For measurement above 30MHz, the trilob Broadband Antenna or Horn Antenna was located 3m from EUT, Measurements were made with the antenna positioned in both the horizontal and vertical planes of Polarization, and the measurement antenna was varied from 1 m to 4 m. in height above the reference ground plane to obtain the maximum signal strength.

(3) Below pre-scan procedure was first performed in order to find prominent frequency spectrum radiated emissions from 9 kHz to 25 GHz:

(a) Scanning the peak frequency spectrum with the antenna specified in step (3), and the EUT was rotated 360 degree, the antenna height was varied from 1 m to 4 m (Except loop antenna, it's fixed 1 m above ground.)

(b) Change work frequency or channel of device if practicable.

(c) Change modulation type of device if practicable.

(d) Change power supply range from 85% to 115% of the rated supply voltage

(e) Rotated EUT though three orthogonal axes to determine the attitude of EUT arrangement produces highest emissions.

Spectrum frequency from 9 kHz to 25 GHz (tenth harmonic of fundamental frequency) was investigated, and no any obvious emission were detected from 18 GHz to 25 GHz, so below final test was performed with frequency range from 9 kHz to 18 GHz.

(4) For final emissions measurements at each frequency of interest, the EUT was rotated and the antenna height was varied between 1 m and 4 m in order to maximize the emission. Measurements in both horizontal and vertical polarities were made and the data was recorded. In order to find the maximum emission, the relative positions of equipment and all of the interface cables were changed according to ANSI C63.10:2013 on Radiated Emission test.

(5) The emissions from 9 kHz to 1 GHz were measured based on CISPR QP detector except for the frequency bands 9 - 90 kHz, 110 - 490 kHz, for emissions from 9 kHz - 90 kHz, 110 kHz - 490 kHz and above 1 GHz were measured based on average detector, for emissions above 1 GHz, peak emissions also be measured and need comply with Peak limit.

(6) The emissions from 9 kHz to 1 GHz, QP or average values were measured with EMI receiver with below RBW.

Frequency band	RBW
9 kHz - 150 kHz	200 Hz
150 kHz - 30 MHz	9 kHz
30 MHz - 1 GHz	120 kHz

(7) For emissions above 1GHz, both Peak and Average level were measured with Spectrum Analyzer, and the RBW is set at 1 MHz, VBW is set at 3 MHz for Peak measure; According ANSI C63.10:2013 clause 4.1.4.2.2 procedure for average measure.

(8) For portable device, X axis, Y axis, Z axis are tested, and worse setup is reported.

14.6. Test result

PASS. (See below detailed test result)

All the emissions except fundamental emission from 9 kHz to 25 GHz were comply with 15.209 limits.

Note1: According exploratory test, the emission levels are 20 dB below the limit detected from 9 kHz to 30 MHz and 18 GHz to 25 GHz, so the final test was performed with frequency range from 30 MHz to 18 GHz and recorded in below.

Note2: 30 MHz ~ 25 GHz: (Scan with GFSK, $\pi/4$ -DQPSK and 8DPSK, the worst case is 8DPSK Mode)

Note3: For emissions below 1 GHz, according exploratory explorer test, when change Tx mode and channel, have no distinct influence on emissions level, so for emissions below 1 GHz, the final test was only performed with EUT working in 8DPSK, Tx 2441 MHz mode.

Note4: For emissions above 1 GHz. If peak results comply with AV limit, AV Result is deemed to comply with AV limit.

14.7. Test data

TR-4-E-009 Radiated Emission Test Result

Test Date: 2024-04-01 **Tested By:** Junchang Du
EUT: Wireless Hearing Aid **Model Number:** JLH1
Test Mode: BT TX **Power Supply:** Battery
Condition: Temp:24.2°C;Humi:62.2% **Test Site:** DDT 3# Chamber
File Path: d:\ts\2024 report data\Q23122824-2E JLH1\FCC BELOW 1G\20240401-171228_H
Memo: Sample Number:S23122824-03 Power Setting:NA

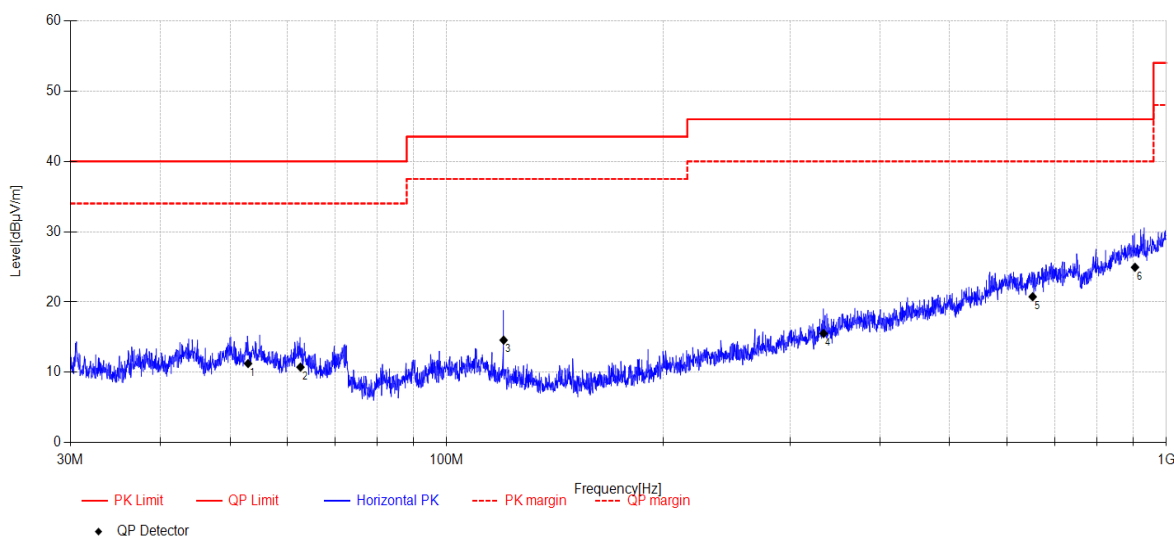

Data List										
NO.	Freq. [MHz]	Reading [dBµV/m]	Antenna Factor [dB]	Cable Loss [dB]	AMP [dB]	Result [dBµV/m]	Limit [dBµV/m]	Margin [dB]	Detector	Polarity
1	52.976	23.62	13.58	4.74	-30.68	11.26	40.00	28.74	QP	Horizontal
2	62.641	24.06	12.54	4.77	-30.62	10.75	40.00	29.25	QP	Horizontal
3	119.991	30.26	10.00	5.17	-30.84	14.59	43.50	28.91	QP	Horizontal
4	333.994	24.89	14.54	6.34	-30.23	15.54	46.00	30.46	QP	Horizontal
5	651.998	24.07	19.04	7.55	-29.90	20.76	46.00	25.24	QP	Horizontal
6	904.595	23.65	21.90	8.36	-28.96	24.95	46.00	21.05	QP	Horizontal

Note:

1. Result Level = Reading + Cable loss + Antenna Factor + AMP
2. If Peak Result complies with QP limit, QP Result is deemed to comply with QP limit.
3. Test setup: RBW: 120 kHz, VBW: 300 kHz, Sweep time: auto.

TR-4-E-009 Radiated Emission Test Result

Test Date: 2024-04-01 **Tested By:** Junchang Du
EUT: Wireless Hearing Aid **Model Number:** JLH1
Test Mode: BT TX **Power Supply:** Battery
Condition: Temp:24.2°C;Humi:62.2% **Test Site:** DDT 3# Chamber
File Path: d:\ts\2024 report data\Q23122824-2E JLH1\FCC BELOW 1G\20240401-171310_V
Memo: Sample Number:S23122824-03 Power Setting:NA

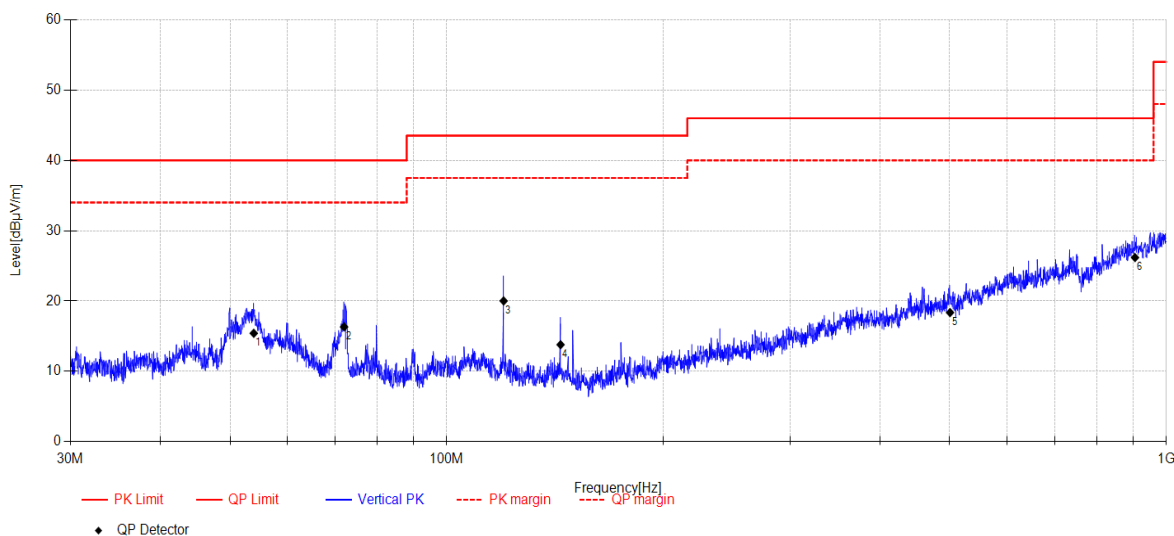

Data List										
NO.	Freq. [MHz]	Reading [dBµV/m]	Antenna Factor [dB]	Cable Loss [dB]	AMP [dB]	Result [dBµV/m]	Limit [dBµV/m]	Margin [dB]	Detector	Polarity
1	53.951	28.99	12.36	4.74	-30.67	15.42	40.00	24.58	QP	Vertical
2	72.021	32.49	9.59	4.80	-30.55	16.33	40.00	23.67	QP	Vertical
3	119.991	35.69	10.00	5.17	-30.84	20.02	43.50	23.48	QP	Vertical
4	143.986	29.98	9.30	5.29	-30.77	13.80	43.50	29.70	QP	Vertical
5	500.546	24.28	17.06	6.93	-29.90	18.37	46.00	27.63	QP	Vertical
6	904.595	24.89	21.90	8.36	-28.96	26.19	46.00	19.81	QP	Vertical

Note:

1. Result Level = Reading + Cable loss + Antenna Factor + AMP
2. If Peak Result complies with QP limit, QP Result is deemed to comply with QP limit.
3. Test setup: RBW: 120 kHz, VBW: 300 kHz, Sweep time: auto.

TR-4-E-009 Radiated Emission Test Result

Test Date: 2024-03-26 **Tested By:** Junchang Du
EUT: Wireless Hearing Aid **Model Number:** JLH1
Test Mode: DH5 TX 2402MHz **Power Supply:** Battery
Condition: Temp:24.2°C;Humi:62.2% **Test Site:** DDT 3# Chamber
File Path: d:\ts\2024 report data\Q23122824-2E JLH1\FCC ABOVE 1G\69
Memo: L Sample Number:S23122824-03 Power Setting:0X08

Test Graph

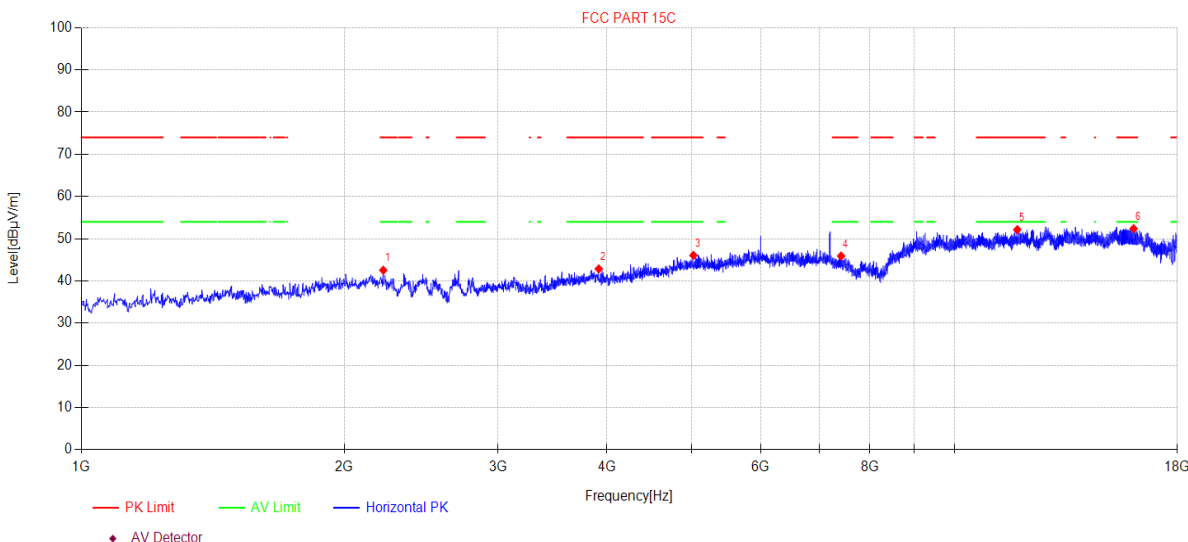

Data List										
NO	Freq. [MHz]	Reading [dBµV/m]	Antenna Factor [dB]	Cable loss [dB]	AMP [dB]	Level [dBµV/m]	Limit [dBµV/m]	Margin [dB]	Detector	Polarity
1	2217.200	46.56	27.63	5.97	-37.62	42.54	74.00	31.46	PK	Horizontal
2	3913.800	46.25	31.17	5.83	-40.40	42.85	74.00	31.15	PK	Horizontal
3	5023.900	44.99	33.25	7.90	-40.08	46.06	74.00	27.94	PK	Horizontal
4	7415.800	43.33	36.67	7.64	-41.74	45.90	74.00	28.10	PK	Horizontal
5	11800.100	42.36	38.90	10.36	-39.47	52.15	74.00	21.85	PK	Horizontal
6	16038.200	38.08	37.96	15.73	-39.39	52.38	74.00	21.62	PK	Horizontal

Note:

1. Level = Reading + Cable loss + Antenna Factor + AMP
2. If Peak Result complies with AV limit, AV Result is deemed to comply with AV limit.
3. Test setup: RBW: 1 MHz, VBW: 3 MHz, Sweep time: auto.

TR-4-E-009 Radiated Emission Test Result

Test Date: 2024-03-26 **Tested By:** Junchang Du
EUT: Wireless Hearing Aid **Model Number:** JLH1
Test Mode: DH5 TX 2402MHz **Power Supply:** Battery
Condition: Temp:24.2°C;Humi:62.2% **Test Site:** DDT 3# Chamber
File Path: d:\ts\2024 report data\Q23122824-2E JLH1\FCC ABOVE 1G\70
Memo: L Sample Number:S23122824-03 Power Setting:0X08

Test Graph

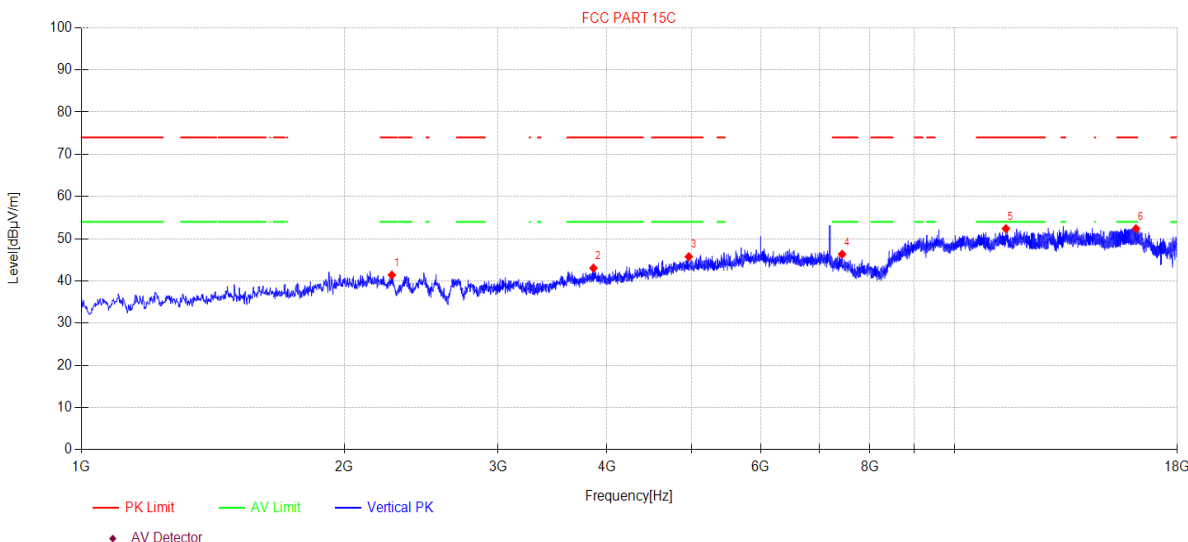

Data List										
NO	Freq. [MHz]	Reading [dBµV/m]	Antenna Factor [dB]	Cable loss [dB]	AMP [dB]	Level [dBµV/m]	Limit [dBµV/m]	Margin [dB]	Detector	Polarity
1	2268.200	46.09	27.12	5.95	-37.77	41.39	74.00	32.61	PK	Vertical
2	3859.400	46.62	30.96	5.82	-40.36	43.04	74.00	30.96	PK	Vertical
3	4962.700	44.91	33.13	7.79	-40.09	45.74	74.00	28.26	PK	Vertical
4	7434.500	43.84	36.63	7.64	-41.79	46.32	74.00	27.68	PK	Vertical
5	11453.300	42.39	39.25	10.05	-39.30	52.39	74.00	21.61	PK	Vertical
6	16138.500	38.65	37.86	15.33	-39.47	52.37	74.00	21.63	PK	Vertical

Note:

1. Level = Reading + Cable loss + Antenna Factor + AMP
2. If Peak Result complies with AV limit, AV Result is deemed to comply with AV limit.
3. Test setup: RBW: 1 MHz, VBW: 3 MHz, Sweep time: auto.

TR-4-E-009 Radiated Emission Test Result

Test Date: 2024-03-26 **Tested By:** Junchang Du
EUT: Wireless Hearing Aid **Model Number:** JLH1
Test Mode: DH5 TX 2441MHz **Power Supply:** Battery
Condition: Temp:24.2°C;Humi:62.2% **Test Site:** DDT 3# Chamber
File Path: d:\ts\2024 report data\Q23122824-2E JLH1\FCC ABOVE 1G\71
Memo: L Sample Number:S23122824-03 Power Setting:0X08

Test Graph

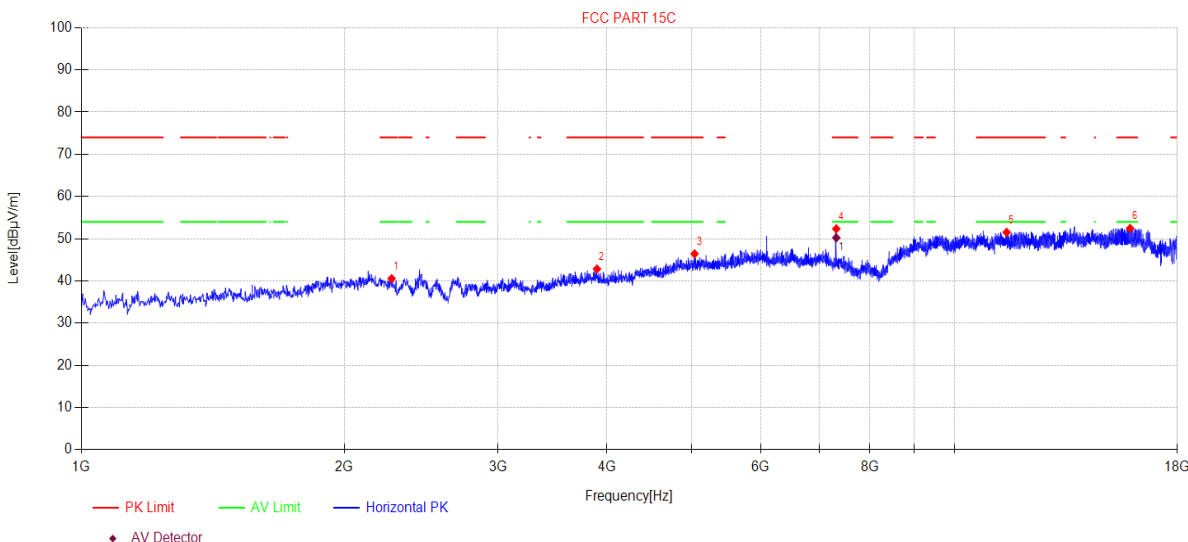

Data List										
NO	Freq. [MHz]	Reading [dBµV/m]	Antenna Factor [dB]	Cable loss [dB]	AMP [dB]	Level [dBµV/m]	Limit [dBµV/m]	Margin [dB]	Detector	Polarity
1	2266.500	45.22	27.14	5.95	-37.76	40.55	74.00	33.45	PK	Horizontal
2	3895.100	46.23	31.17	5.83	-40.39	42.84	74.00	31.16	PK	Horizontal
3	5039.200	45.27	33.28	7.93	-40.07	46.41	74.00	27.59	PK	Horizontal
4	7322.300	49.38	36.86	7.63	-41.51	52.36	74.00	21.64	PK	Horizontal
5	11473.700	41.53	39.23	10.07	-39.31	51.52	74.00	22.48	PK	Horizontal
6	15890.300	38.25	38.12	15.38	-39.29	52.46	74.00	21.54	PK	Horizontal

Data List										
NO	Freq. [MHz]	Reading [dBµV/m]	Antenna Factor [dB]	Cable loss [dB]	AMP [dB]	Level [dBµV/m]	Limit [dBµV/m]	Margin [dB]	Detector	Polarity
1	7322.300	47.23	36.86	7.63	-41.51	50.21	54.0	3.79	AV	Horizontal

Note:

- Level = Reading + Cable loss + Antenna Factor + AMP
- If Peak Result complies with AV limit, AV Result is deemed to comply with AV limit.
- Test setup: RBW: 1 MHz, VBW: 3 MHz, Sweep time: auto.

TR-4-E-009 Radiated Emission Test Result

Test Date: 2024-03-26 **Tested By:** Junchang Du
EUT: Wireless Hearing Aid **Model Number:** JLH1
Test Mode: DH5 TX 2441MHz **Power Supply:** Battery
Condition: Temp:24.2°C;Humi:62.2% **Test Site:** DDT 3# Chamber
File Path: d:\ts\2024 report data\Q23122824-2E JLH1\FCC ABOVE 1G\72
Memo: L Sample Number:S23122824-03 Power Setting:0X08

Test Graph

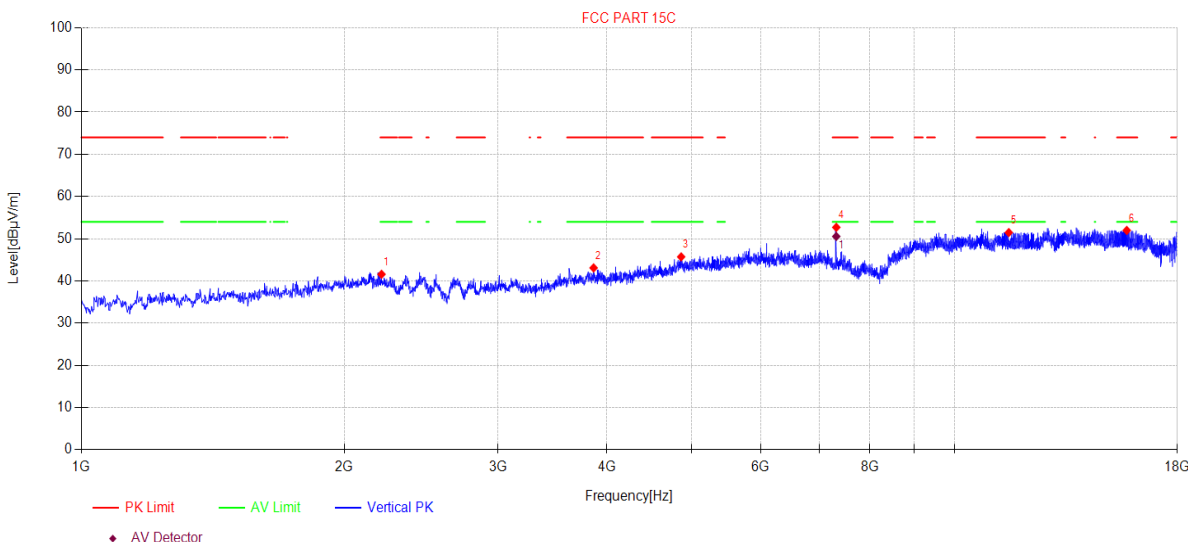

Data List										
NO	Freq. [MHz]	Reading [dBµV/m]	Antenna Factor [dB]	Cable loss [dB]	AMP [dB]	Level [dBµV/m]	Limit [dBµV/m]	Margin [dB]	Detector	Polarity
1	2207.000	45.47	27.73	5.98	-37.60	41.58	74.00	32.42	PK	Vertical
2	3861.100	46.67	30.97	5.82	-40.37	43.09	74.00	30.91	PK	Vertical
3	4864.100	44.67	33.57	7.60	-40.13	45.71	74.00	28.29	PK	Vertical
4	7322.300	49.72	36.86	7.63	-41.51	52.70	74.00	21.30	PK	Vertical
5	11540.000	41.55	39.12	10.13	-39.34	51.46	74.00	22.54	PK	Vertical
6	15750.900	38.03	38.40	14.75	-39.21	51.97	74.00	22.03	PK	Vertical

Data List										
NO	Freq. [MHz]	Reading [dBµV/m]	Antenna Factor [dB]	Cable loss [dB]	AMP [dB]	Level [dBµV/m]	Limit [dBµV/m]	Margin [dB]	Detector	Polarity
1	7322.300	47.56	36.86	7.63	-41.51	50.54	54.0	3.46	AV	Vertical

Note:

1. Level = Reading + Cable loss + Antenna Factor + AMP
2. If Peak Result complies with AV limit, AV Result is deemed to comply with AV limit.
3. Test setup: RBW: 1 MHz, VBW: 3 MHz, Sweep time: auto.

TR-4-E-009 Radiated Emission Test Result

Test Date: 2024-03-26 **Tested By:** Junchang Du
EUT: Wireless Hearing Aid **Model Number:** JLH1
Test Mode: DH5 TX 2480MHz **Power Supply:** Battery
Condition: Temp:24.2°C;Humi:62.2% **Test Site:** DDT 3# Chamber
File Path: d:\ts\2024 report data\Q23122824-2E JLH1\FCC ABOVE 1G\73
Memo: L Sample Number:S23122824-03 Power Setting:0X08

Test Graph

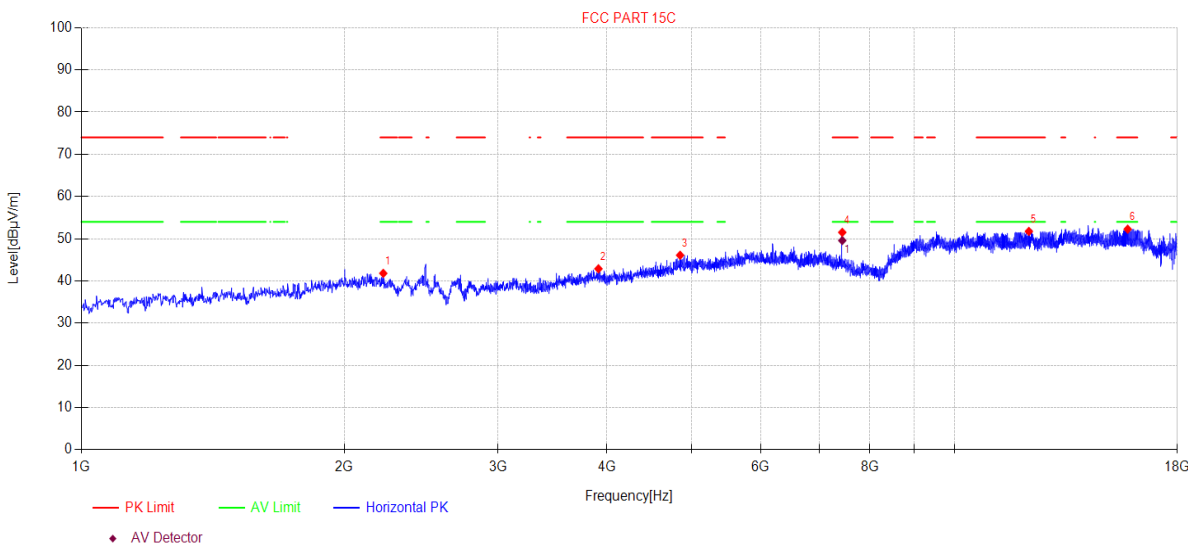

Data List										
NO	Freq. [MHz]	Reading [dBµV/m]	Antenna Factor [dB]	Cable loss [dB]	AMP [dB]	Level [dBµV/m]	Limit [dBµV/m]	Margin [dB]	Detector	Polarity
1	2217.200	45.82	27.63	5.97	-37.62	41.80	74.00	32.20	PK	Horizontal
2	3910.400	46.27	31.18	5.83	-40.40	42.88	74.00	31.12	PK	Horizontal
3	4850.500	44.87	33.79	7.57	-40.14	46.09	74.00	27.91	PK	Horizontal
4	7439.600	49.05	36.62	7.64	-41.80	51.51	74.00	22.49	PK	Horizontal
5	12169.000	41.53	39.30	10.54	-39.63	51.74	74.00	22.26	PK	Horizontal
6	15791.700	38.25	38.32	14.94	-39.24	52.27	74.00	21.73	PK	Horizontal

Data List										
NO	Freq. [MHz]	Reading [dBµV/m]	Antenna Factor [dB]	Cable loss [dB]	AMP [dB]	Level [dBµV/m]	Limit [dBµV/m]	Margin [dB]	Detector	Polarity
1	7439.600	47.12	36.62	7.64	-41.80	49.58	54.0	4.42	AV	Horizontal

Note:

- Level = Reading + Cable loss + Antenna Factor + AMP
- If Peak Result complies with AV limit, AV Result is deemed to comply with AV limit.
- Test setup: RBW: 1 MHz, VBW: 3 MHz, Sweep time: auto.

TR-4-E-009 Radiated Emission Test Result

Test Date: 2024-03-26 **Tested By:** Junchang Du
EUT: Wireless Hearing Aid **Model Number:** JLH1
Test Mode: DH5 TX 2480MHz **Power Supply:** Battery
Condition: Temp:24.2°C;Humi:62.2% **Test Site:** DDT 3# Chamber
File Path: d:\ts\2024 report data\Q23122824-2E JLH1\FCC ABOVE 1G\74
Memo: L Sample Number:S23122824-03 Power Setting:0X08

Test Graph

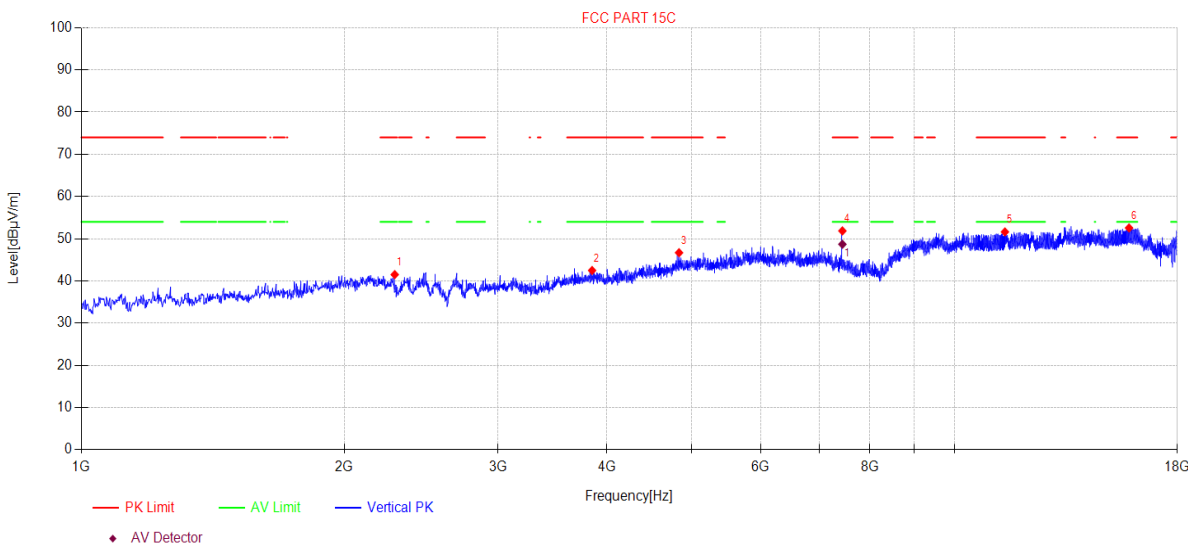

Data List										
NO	Freq. [MHz]	Reading [dBµV/m]	Antenna Factor [dB]	Cable loss [dB]	AMP [dB]	Level [dBµV/m]	Limit [dBµV/m]	Margin [dB]	Detector	Polarity
1	2285.200	46.43	26.95	5.94	-37.82	41.50	74.00	32.50	PK	Vertical
2	3845.800	46.14	30.88	5.82	-40.36	42.48	74.00	31.52	PK	Vertical
3	4836.900	45.83	33.46	7.54	-40.14	46.69	74.00	27.31	PK	Vertical
4	7441.300	49.40	36.62	7.64	-41.80	51.86	74.00	22.14	PK	Vertical
5	11424.400	41.60	39.28	10.03	-39.29	51.62	74.00	22.38	PK	Vertical
6	15847.800	38.44	38.20	15.19	-39.27	52.56	74.00	21.44	PK	Vertical

Data List										
NO	Freq. [MHz]	Reading [dBµV/m]	Antenna Factor [dB]	Cable loss [dB]	AMP [dB]	Level [dBµV/m]	Limit [dBµV/m]	Margin [dB]	Detector	Polarity
1	7441.300	46.23	36.62	7.64	-41.80	48.69	54.0	5.31	AV	Vertical

Note:

- Level = Reading + Cable loss + Antenna Factor + AMP
- If Peak Result complies with AV limit, AV Result is deemed to comply with AV limit.
- Test setup: RBW: 1 MHz, VBW: 3 MHz, Sweep time: auto.

TR-4-E-009 Radiated Emission Test Result

Test Date: 2024-03-26 **Tested By:** Junchang Du
EUT: Wireless Hearing Aid **Model Number:** JLH1
Test Mode: DH5 TX 2402MHz **Power Supply:** Battery
Condition: Temp:24.2°C;Humi:62.2% **Test Site:** DDT 3# Chamber
File Path: d:\ts\2024 report data\Q23122824-2E JLH1\FCC ABOVE 1G\31
Memo: R Sample Number:S23122824-03 Power Setting:0X08

Test Graph

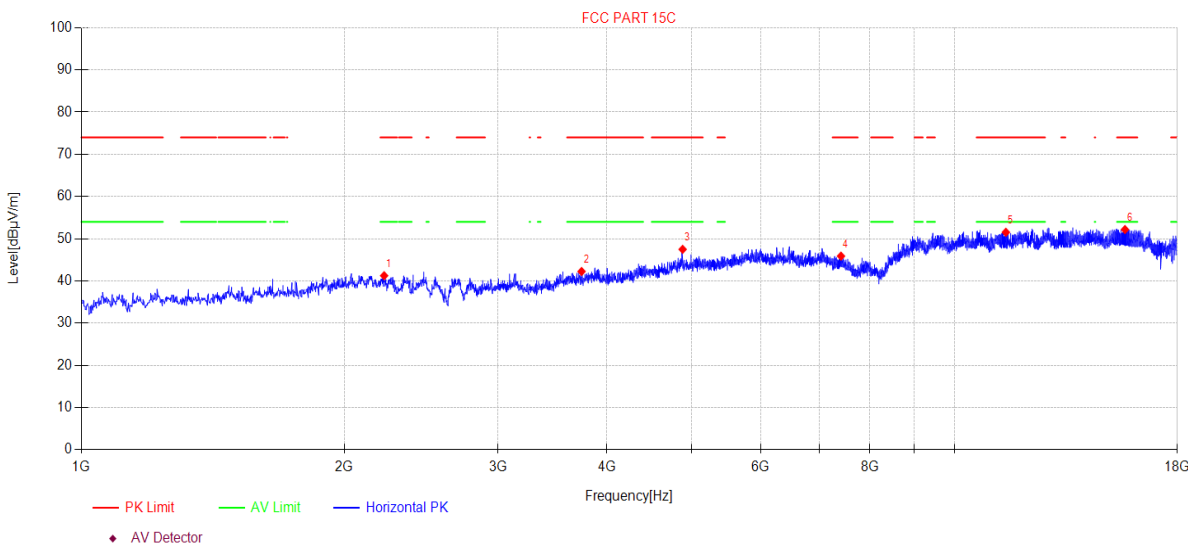

Data List										
NO	Freq. [MHz]	Reading [dBµV/m]	Antenna Factor [dB]	Cable loss [dB]	AMP [dB]	Level [dBµV/m]	Limit [dBµV/m]	Margin [dB]	Detector	Polarity
1	2222.300	45.33	27.58	5.97	-37.64	41.24	74.00	32.76	PK	Horizontal
2	3740.400	46.26	30.48	5.79	-40.29	42.24	74.00	31.76	PK	Horizontal
3	4882.800	46.69	33.28	7.63	-40.12	47.48	74.00	26.52	PK	Horizontal
4	7414.100	43.31	36.67	7.64	-41.74	45.88	74.00	28.12	PK	Horizontal
5	11451.600	41.52	39.25	10.05	-39.30	51.52	74.00	22.48	PK	Horizontal
6	15677.800	38.41	38.52	14.42	-39.17	52.18	74.00	21.82	PK	Horizontal

Note:

- Level = Reading + Cable loss + Antenna Factor + AMP
- If Peak Result complies with AV limit, AV Result is deemed to comply with AV limit.
- Test setup: RBW: 1 MHz, VBW: 3 MHz, Sweep time: auto.

TR-4-E-009 Radiated Emission Test Result

Test Date: 2024-03-26 **Tested By:** Junchang Du
EUT: Wireless Hearing Aid **Model Number:** JLH1
Test Mode: DH5 TX 2402MHz **Power Supply:** Battery
Condition: Temp:24.2°C;Humi:62.2% **Test Site:** DDT 3# Chamber
File Path: d:\ts\2024 report data\Q23122824-2E JLH1\FCC ABOVE 1G\32
Memo: R Sample Number:S23122824-03 Power Setting:0X08

Test Graph

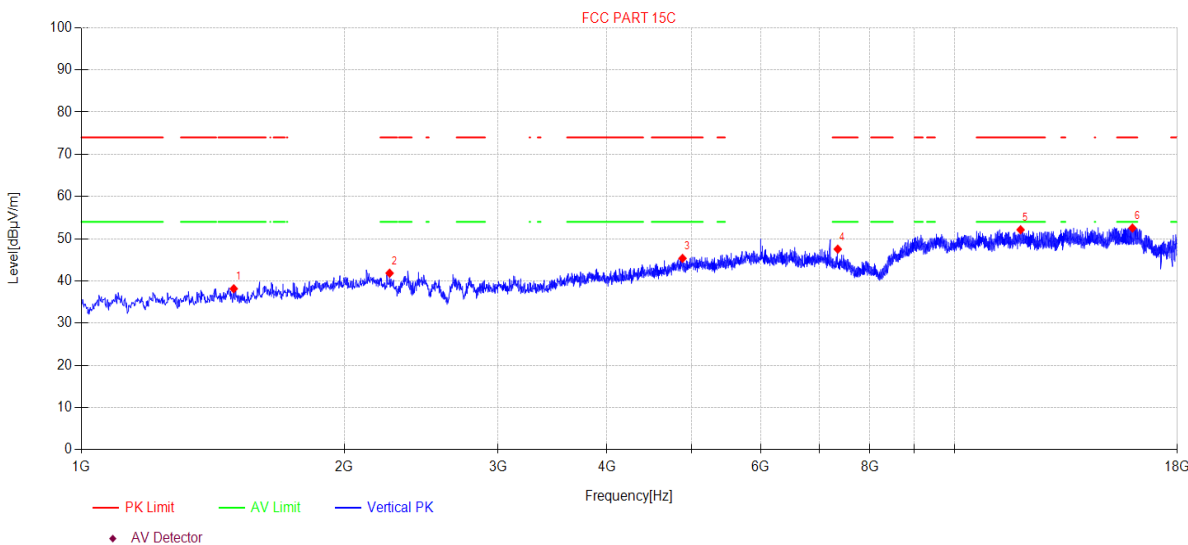

Data List										
NO	Freq. [MHz]	Reading [dBµV/m]	Antenna Factor [dB]	Cable loss [dB]	AMP [dB]	Level [dBµV/m]	Limit [dBµV/m]	Margin [dB]	Detector	Polarity
1	1494.700	45.13	25.48	4.48	-36.94	38.15	74.00	35.85	PK	Vertical
2	2254.600	46.36	27.25	5.96	-37.73	41.84	74.00	32.16	PK	Vertical
3	4881.100	44.53	33.30	7.63	-40.12	45.34	74.00	28.66	PK	Vertical
4	7351.200	44.68	36.80	7.63	-41.58	47.53	74.00	26.47	PK	Vertical
5	11905.500	42.26	38.92	10.46	-39.52	52.12	74.00	21.88	PK	Vertical
6	15990.600	38.03	38.01	15.84	-39.35	52.53	74.00	21.47	PK	Vertical

Note:

- Level = Reading + Cable loss + Antenna Factor + AMP
- If Peak Result complies with AV limit, AV Result is deemed to comply with AV limit.
- Test setup: RBW: 1 MHz, VBW: 3 MHz, Sweep time: auto.

TR-4-E-009 Radiated Emission Test Result

Test Date: 2024-03-26 **Tested By:** Junchang Du
EUT: Wireless Hearing Aid **Model Number:** JLH1
Test Mode: DH5 TX 2441MHz **Power Supply:** Battery
Condition: Temp:24.2°C;Humi:62.2% **Test Site:** DDT 3# Chamber
File Path: d:\ts\2024 report data\Q23122824-2E JLH1\FCC ABOVE 1G\33
Memo: R Sample Number:S23122824-03 Power Setting:0X08

Test Graph

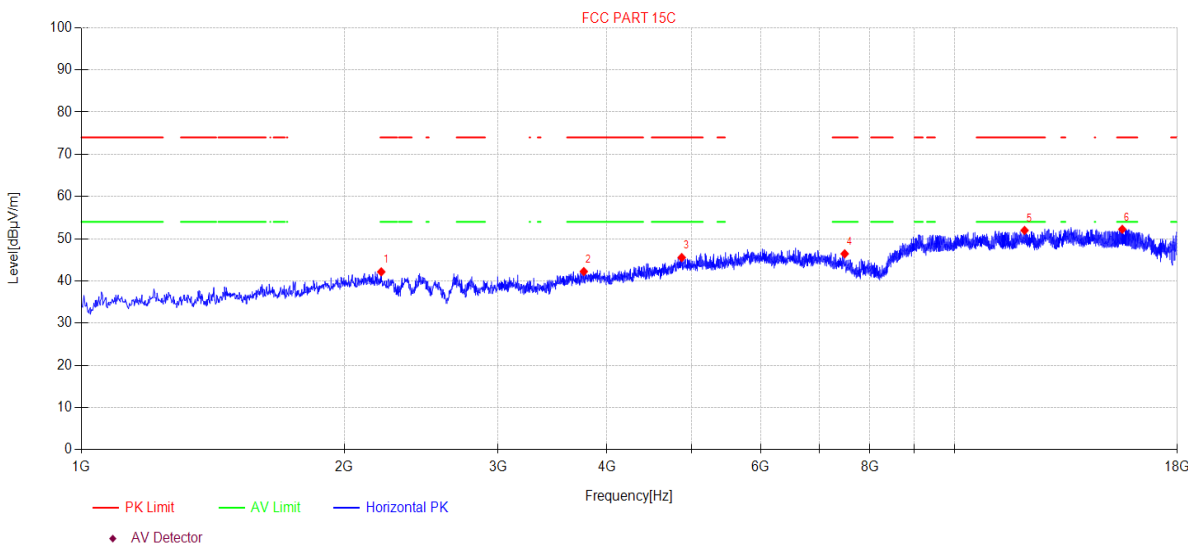

Data List										
NO	Freq. [MHz]	Reading [dBµV/m]	Antenna Factor [dB]	Cable loss [dB]	AMP [dB]	Level [dBµV/m]	Limit [dBµV/m]	Margin [dB]	Detector	Polarity
1	2205.300	46.01	27.75	5.98	-37.59	42.15	74.00	31.85	PK	Horizontal
2	3762.500	46.19	30.55	5.80	-40.31	42.23	74.00	31.77	PK	Horizontal
3	4870.900	44.59	33.47	7.61	-40.13	45.54	74.00	28.46	PK	Horizontal
4	7487.200	44.18	36.53	7.64	-41.92	46.43	74.00	27.57	PK	Horizontal
5	12031.300	41.77	39.23	10.54	-39.57	51.97	74.00	22.03	PK	Horizontal
6	15567.300	38.75	38.67	13.92	-39.10	52.24	74.00	21.76	PK	Horizontal

Note:

- Level = Reading + Cable loss + Antenna Factor + AMP
- If Peak Result complies with AV limit, AV Result is deemed to comply with AV limit.
- Test setup: RBW: 1 MHz, VBW: 3 MHz, Sweep time: auto.

TR-4-E-009 Radiated Emission Test Result

Test Date: 2024-03-26 **Tested By:** Junchang Du
EUT: Wireless Hearing Aid **Model Number:** JLH1
Test Mode: DH5 TX 2441MHz **Power Supply:** Battery
Condition: Temp:24.2°C;Humi:62.2% **Test Site:** DDT 3# Chamber
File Path: d:\ts\2024 report data\Q23122824-2E JLH1\FCC ABOVE 1G\34
Memo: R Sample Number:S23122824-03 Power Setting:0X08

Test Graph

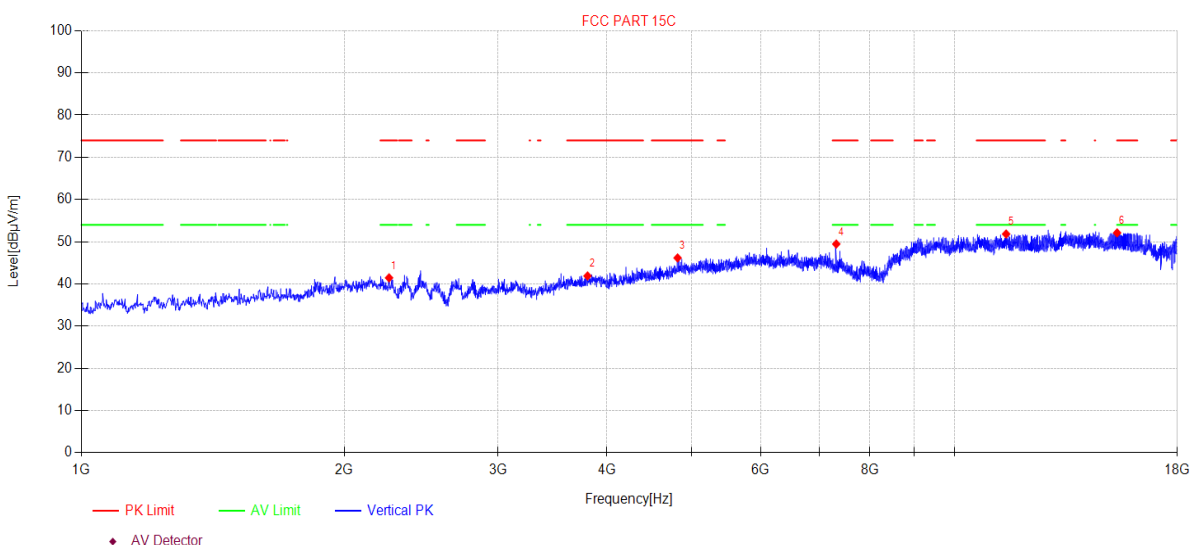

Data List										
NO	Freq. [MHz]	Reading [dBµV/m]	Antenna Factor [dB]	Cable loss [dB]	AMP [dB]	Level [dBµV/m]	Limit [dBµV/m]	Margin [dB]	Detector	Polarity
1	2251.200	45.92	27.29	5.96	-37.72	41.45	74.00	32.55	PK	Vertical
2	3799.900	45.72	30.70	5.81	-40.33	41.90	74.00	32.10	PK	Vertical
3	4818.200	45.84	32.97	7.50	-40.15	46.16	74.00	27.84	PK	Vertical
4	7322.300	46.48	36.86	7.63	-41.51	49.46	74.00	24.54	PK	Vertical
5	11460.100	41.83	39.24	10.06	-39.31	51.82	74.00	22.18	PK	Vertical
6	15356.500	38.76	39.35	12.96	-38.97	52.10	74.00	21.90	PK	Vertical

Note:

1. Level = Reading + Cable loss + Antenna Factor + AMP
2. If Peak Result complies with AV limit, AV Result is deemed to comply with AV limit.
3. Test setup: RBW: 1 MHz, VBW: 3 MHz, Sweep time: auto.

TR-4-E-009 Radiated Emission Test Result

Test Date: 2024-03-26 **Tested By:** Junchang Du
EUT: Wireless Hearing Aid **Model Number:** JLH1
Test Mode: DH5 TX 2480MHz **Power Supply:** Battery
Condition: Temp:24.2°C;Humi:62.2% **Test Site:** DDT 3# Chamber
File Path: d:\ts\2024 report data\Q23122824-2E JLH1\FCC ABOVE 1G\35
Memo: R Sample Number:S23122824-03 Power Setting:0X08

Test Graph

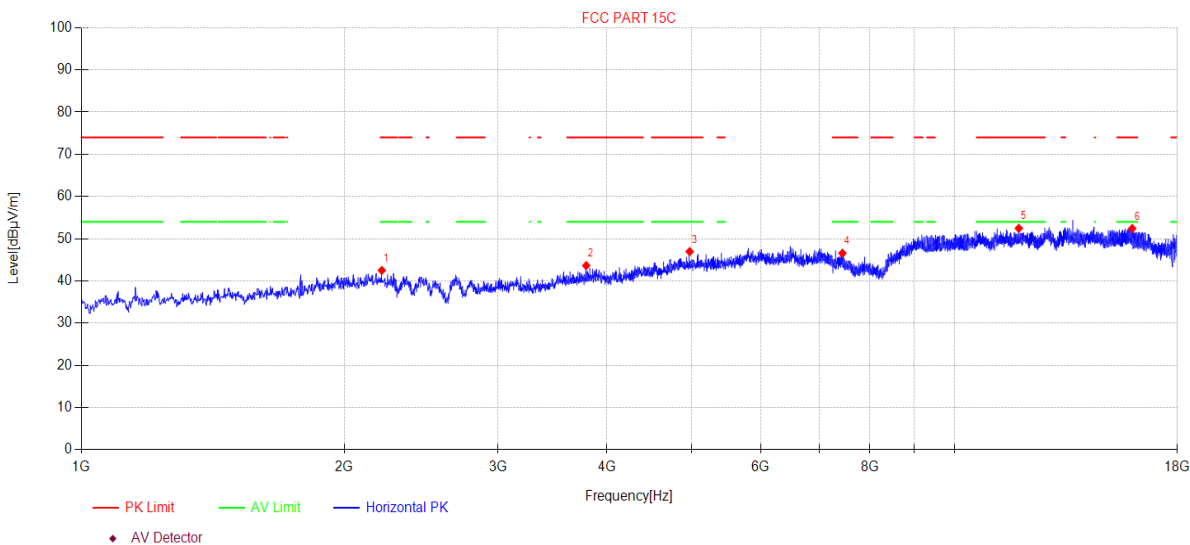

Data List										
NO	Freq. [MHz]	Reading [dBµV/m]	Antenna Factor [dB]	Cable loss [dB]	AMP [dB]	Level [dBµV/m]	Limit [dBµV/m]	Margin [dB]	Detector	Polarity
1	2208.700	46.40	27.71	5.98	-37.60	42.49	74.00	31.51	PK	Horizontal
2	3786.300	47.51	30.65	5.80	-40.32	43.64	74.00	30.36	PK	Horizontal
3	4974.600	46.07	33.15	7.82	-40.09	46.95	74.00	27.05	PK	Horizontal
4	7441.300	44.11	36.62	7.64	-41.80	46.57	74.00	27.43	PK	Horizontal
5	11849.400	42.64	38.90	10.41	-39.49	52.46	74.00	21.54	PK	Horizontal
6	15982.100	37.95	38.02	15.80	-39.35	52.42	74.00	21.58	PK	Horizontal

Note:

1. Level = Reading + Cable loss + Antenna Factor + AMP
2. If Peak Result complies with AV limit, AV Result is deemed to comply with AV limit.
3. Test setup: RBW: 1 MHz, VBW: 3 MHz, Sweep time: auto.

TR-4-E-009 Radiated Emission Test Result

Test Date: 2024-03-26 **Tested By:** Junchang Du
EUT: Wireless Hearing Aid **Model Number:** JLH1
Test Mode: DH5 TX 2480MHz **Power Supply:** Battery
Condition: Temp:24.2°C;Humi:62.2% **Test Site:** DDT 3# Chamber
File Path: d:\ts\2024 report data\Q23122824-2E JLH1\FCC ABOVE 1G\36
Memo: R Sample Number:S23122824-03 Power Setting:0X08

Test Graph

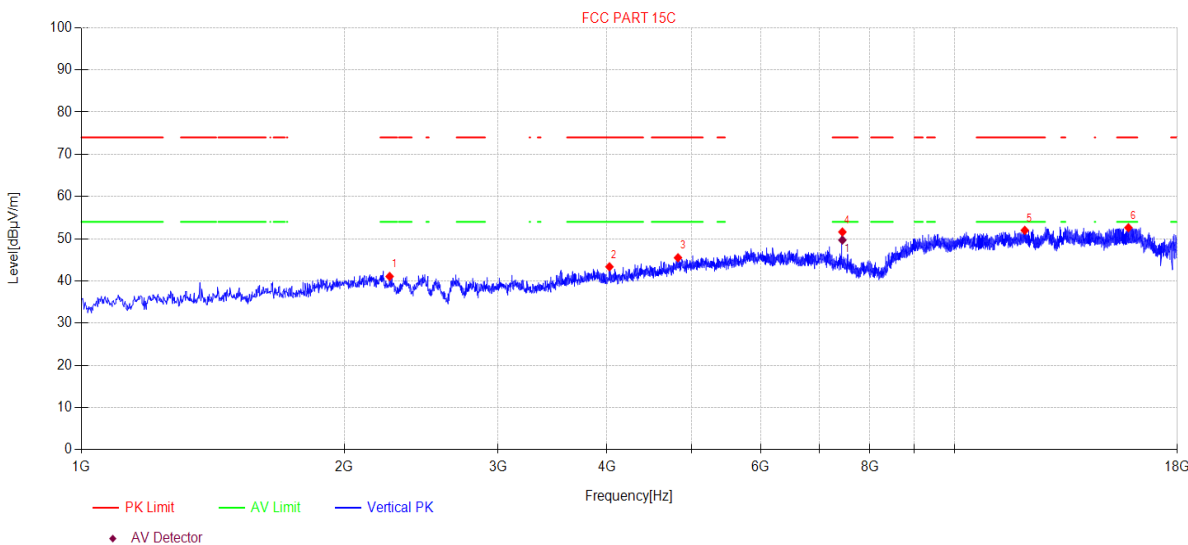

Data List										
NO	Freq. [MHz]	Reading [dBµV/m]	Antenna Factor [dB]	Cable loss [dB]	AMP [dB]	Level [dBµV/m]	Limit [dBµV/m]	Margin [dB]	Detector	Polarity
1	2254.600	45.58	27.25	5.96	-37.73	41.06	74.00	32.94	PK	Vertical
2	4026.000	46.95	30.95	5.90	-40.44	43.36	74.00	30.64	PK	Vertical
3	4823.300	45.03	33.11	7.51	-40.15	45.50	74.00	28.50	PK	Vertical
4	7441.300	49.14	36.62	7.64	-41.80	51.60	74.00	22.40	PK	Vertical
5	12038.100	41.77	39.24	10.54	-39.57	51.98	74.00	22.02	PK	Vertical
6	15820.600	38.54	38.26	15.07	-39.25	52.62	74.00	21.38	PK	Vertical

Data List										
NO	Freq. [MHz]	Reading [dBµV/m]	Antenna Factor [dB]	Cable loss [dB]	AMP [dB]	Level [dBµV/m]	Limit [dBµV/m]	Margin [dB]	Detector	Polarity
1	7441.300	47.22	36.62	7.64	-41.80	49.68	54.0	4.32	AV	Vertical

Note:

1. Level = Reading + Cable loss + Antenna Factor + AMP
2. If Peak Result complies with AV limit, AV Result is deemed to comply with AV limit.
3. Test setup: RBW: 1 MHz, VBW: 3 MHz, Sweep time: auto.

15. Band Edge Compliance

15.1. Test equipment

Equipment	Manufacturer	Model No.	Serial No.	Cal Due To
RF cable	Zhongke Junchuang	JCT26S-NJ-NJ-1.5M	DDT-ZC02762	2024/04/20
High pass filter	Micro-Tronics	HPM50108	DDT-ZC00560	2024/05/14
Micro-Tronics filters	REBES	BRM50702	DDT-ZC03242	/
RF cable	Yuhu Technology	JCTB810-NJ-NJ-9M	DDT-ZC02538	2024/04/22
RF Cable	N/A	W24.02 HL-562	DDT-ZC04022	2024/04/20
Broad-Band Horn Antenna	Schwarzbeck	BBHA 9170	DDT-ZC00506	2024/04/25
Hochgewinn-Hornantenne	Schwarzbeck Mess-Elektronik	BBHA 9120 D	DDT-ZC02129	2025/09/17
EMI TEST RECEIVER	R&S	ESU26	DDT-ZC01909	2024/04/22
PSA Series Spectrum Analyzer	Agilent	E4447A	DDT-ZC00517	2024/04/22
Trilog Broadband Antenna	Schwarzbeck	VULB 9163	DDT-ZC02050	2024/07/11
RF cable	Yuhu Technology	ZT26S-SMAJ-SMAJ-1M	DDT-ZC02037	2024/04/22
Micro-Tronics filters	REBES	BRM50716	DDT-ZC03240	/
Pre-amplifier	COM-POWER	PAM-840A	DDT-ZC01693	2024/04/26
Pre-amplifier	COM-POWER	PAM-118A	DDT-ZC01293	2024/07/14
ELECTRIC AND MAGNETIC FIELD ANALYZER	Narda	EHP-200A	DDT-ZC01401	2024/09/20
High Pass filter	XIANXINGBO	XBLBQ-GTA67	DDT-ZC02179	2024/05/14
RF Cable	N/A	W13.02 AP1-X2	DDT-ZC04023	2024/04/20
High pass filter	Micro-Tronics	HPM50102	DDT-ZC00561	2024/05/14
Active Loop Antenna	Schwarzbeck	FMZB1519	DDT-ZC00524	2025/09/10

15.2. Block diagram of test setup

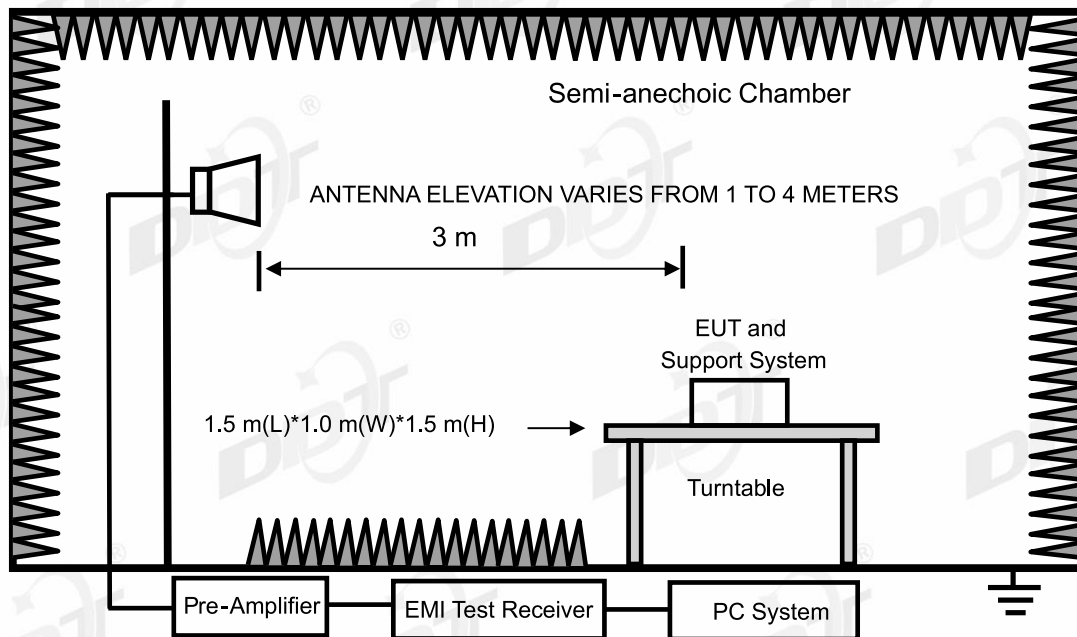

15.3. Limits

All restriction band should comply with 15.209, other emission should be at least 20 dB below the fundamental.

15.4. Assistant equipment used for test

Assistant equipment	Manufacturer	Model number	Description	other
Laptop	Lenovo	00425-00000-00002-AA135	Fixed frequency computer	N/A

15.5. Test procedure

Same with Radiated Emission except change investigated frequency range.

Remark: All restriction band have been tested, and only the worst case is shown in report.

15.6. Test result

PASS. (See below detailed test result)

15.7. Test data

TR-4-E-009 Radiated Emission Test Result

Test Date: 2024-03-27 **Tested By:** Junchang Du
EUT: Wireless Hearing Aid **Model Number:** JLH1
Test Mode: DH5 TX 2402MHz **Power Supply:** Battery
Condition: Temp:24.2°C;Humi:62.2% **Test Site:** DDT 3# Chamber
File Path: d:\ts\2024 report data\Q23122824-2E JLH1\FCC ABOVE 1G\87
Memo: L Sample Number:S23122824-03 Power Setting:0X08

Test Graph

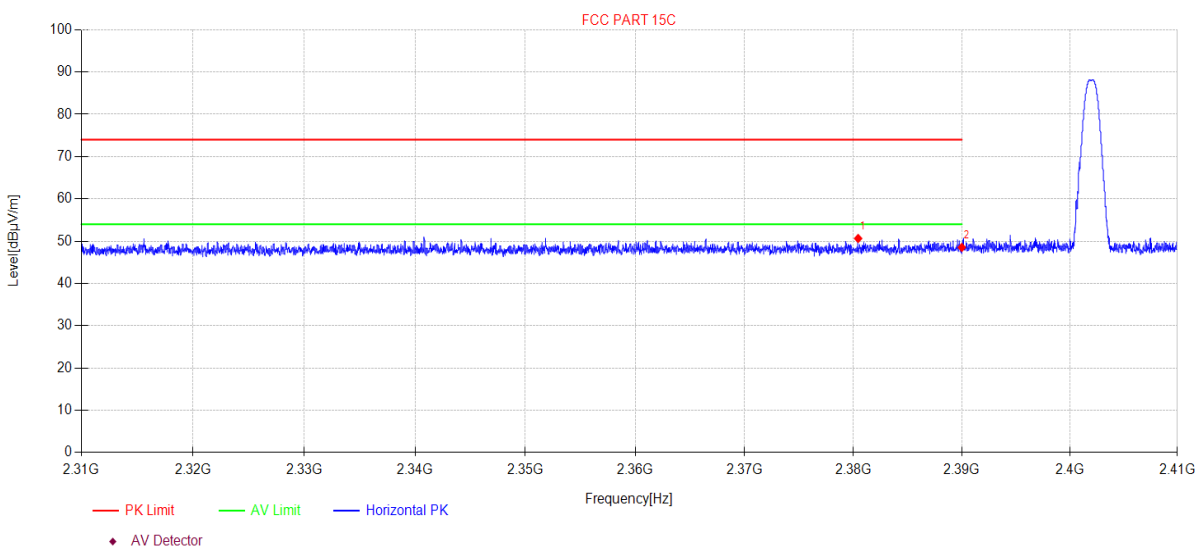

Data List										
N O.	Freq. [MHz]	Reading [dBµV/m]	Antenna Factor [dB]	Cable loss [dB]	AMP [dB]	Level [dBµV/m]	Limit [dBµV/m]	Margin [dB]	Detector	Polarity
1	2380.440	19.56	27.22	3.86	0.00	50.64	74.00	23.36	PK	Horizontal
2	2390.000	17.40	27.26	3.87	0.00	48.53	74.00	25.47	PK	Horizontal

Note:

1. Level = Reading + Cable loss + Antenna Factor + AMP
2. If Peak Result complies with AV limit, AV Result is deemed to comply with AV limit.
3. Test setup: RBW: 1 MHz, VBW: 3 MHz, Sweep time: auto.

TR-4-E-009 Radiated Emission Test Result

Test Date: 2024-03-27 **Tested By:** Junchang Du
EUT: Wireless Hearing Aid **Model Number:** JLH1
Test Mode: DH5 TX 2402MHz **Power Supply:** Battery
Condition: Temp:24.2°C;Humi:62.2% **Test Site:** DDT 3# Chamber
File Path: d:\ts\2024 report data\Q23122824-2E JLH1\FCC ABOVE 1G\88
Memo: L Sample Number:S23122824-03 Power Setting:0X08

Test Graph

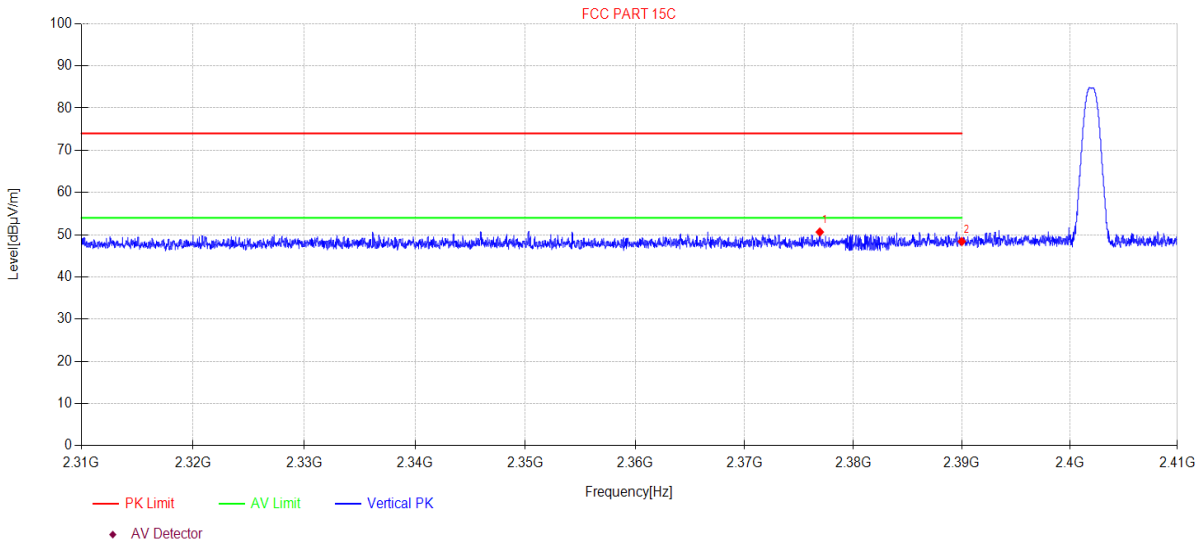

Data List										
N O.	Freq. [MHz]	Reading [dBµV/m]	Antenna Factor [dB]	Cable loss [dB]	AMP [dB]	Level [dBµV/m]	Limit [dBµV/m]	Margin [dB]	Detector	Polarity
1	2376.910	19.57	27.21	3.86	0.00	50.64	74.00	23.36	PK	Vertical
2	2390.000	17.27	27.26	3.87	0.00	48.40	74.00	25.60	PK	Vertical

Note:

1. Level = Reading + Cable loss + Antenna Factor + AMP
2. If Peak Result complies with AV limit, AV Result is deemed to comply with AV limit.
3. Test setup: RBW: 1 MHz, VBW: 3 MHz, Sweep time: auto.

TR-4-E-009 Radiated Emission Test Result

Test Date: 2024-03-27 **Tested By:** Junchang Du
EUT: Wireless Hearing Aid **Model Number:** JLH1
Test Mode: 2DH5 TX 2402MHz **Power Supply:** Battery
Condition: Temp:24.2°C;Humi:62.2% **Test Site:** DDT 3# Chamber
File Path: d:\ts\2024 report data\Q23122824-2E JLH1\FCC ABOVE 1G\89
Memo: L Sample Number:S23122824-03 Power Setting:0X08

Test Graph

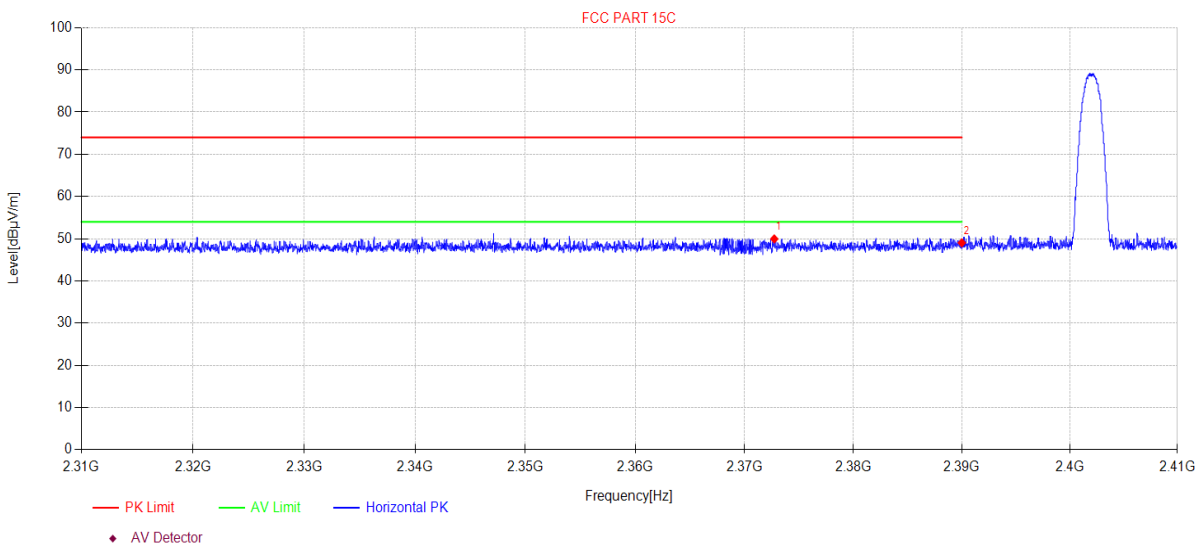

Data List										
N O.	Freq. [MHz]	Reading [dBµV/m]	Antenna Factor [dB]	Cable loss [dB]	AMP [dB]	Level [dBµV/m]	Limit [dBµV/m]	Margin [dB]	Detector	Polarity
1	2372.730	18.92	27.19	3.85	0.00	49.96	74.00	24.04	PK	Horizontal
2	2390.000	17.90	27.26	3.87	0.00	49.03	74.00	24.97	PK	Horizontal

Note:

1. Level = Reading + Cable loss + Antenna Factor + AMP
2. If Peak Result complies with AV limit, AV Result is deemed to comply with AV limit.
3. Test setup: RBW: 1 MHz, VBW: 3 MHz, Sweep time: auto.

TR-4-E-009 Radiated Emission Test Result

Test Date: 2024-03-27 **Tested By:** Junchang Du
EUT: Wireless Hearing Aid **Model Number:** JLH1
Test Mode: 2DH5 TX 2402MHz **Power Supply:** Battery
Condition: Temp:24.2°C;Humi:62.2% **Test Site:** DDT 3# Chamber
File Path: d:\ts\2024 report data\Q23122824-2E JLH1\FCC ABOVE 1G\90
Memo: L Sample Number:S23122824-03 Power Setting:0X08

Test Graph

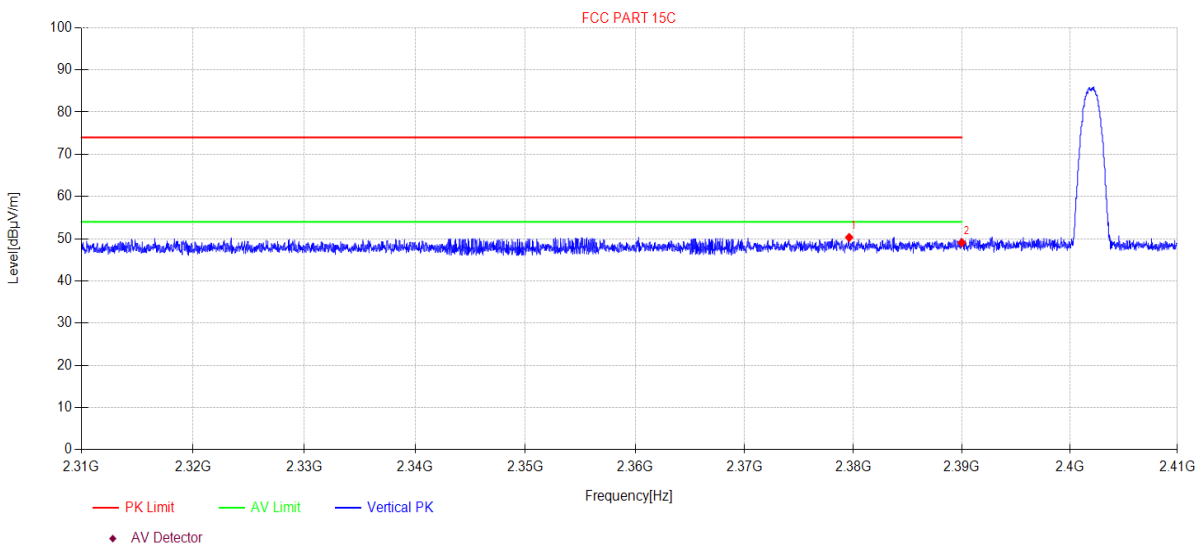

Data List										
N O.	Freq. [MHz]	Reading [dBµV/m]	Antenna Factor [dB]	Cable loss [dB]	AMP [dB]	Level [dBµV/m]	Limit [dBµV/m]	Margin [dB]	Detector	Polarity
1	2379.610	19.22	27.22	3.86	0.00	50.30	74.00	23.70	PK	Vertical
2	2390.000	17.92	27.26	3.87	0.00	49.05	74.00	24.95	PK	Vertical

Note:

1. Level = Reading + Cable loss + Antenna Factor + AMP
2. If Peak Result complies with AV limit, AV Result is deemed to comply with AV limit.
3. Test setup: RBW: 1 MHz, VBW: 3 MHz, Sweep time: auto.

TR-4-E-009 Radiated Emission Test Result

Test Date: 2024-03-27 **Tested By:** Junchang Du
EUT: Wireless Hearing Aid **Model Number:** JLH1
Test Mode: 3DH5 TX 2402MHz **Power Supply:** Battery
Condition: Temp:24.2°C;Humi:62.2% **Test Site:** DDT 3# Chamber
File Path: d:\ts\2024 report data\Q23122824-2E JLH1\FCC ABOVE 1G\91
Memo: L Sample Number:S23122824-03 Power Setting:0X08

Test Graph

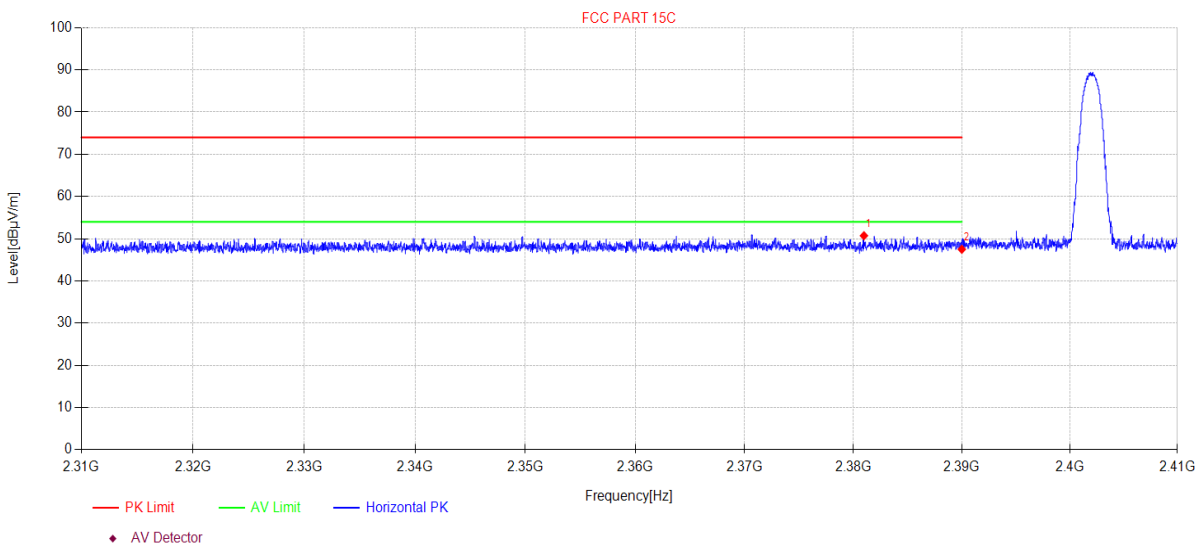

Data List										
N O.	Freq. [MHz]	Reading [dBµV/m]	Antenna Factor [dB]	Cable loss [dB]	AMP [dB]	Level [dBµV/m]	Limit [dBµV/m]	Margin [dB]	Detector	Polarity
1	2380.970	19.63	27.22	3.86	0.00	50.71	74.00	23.29	PK	Horizontal
2	2390.000	16.37	27.26	3.87	0.00	47.50	74.00	26.50	PK	Horizontal

Note:

1. Level = Reading + Cable loss + Antenna Factor + AMP
2. If Peak Result complies with AV limit, AV Result is deemed to comply with AV limit.
3. Test setup: RBW: 1 MHz, VBW: 3 MHz, Sweep time: auto.

TR-4-E-009 Radiated Emission Test Result

Test Date: 2024-03-27 **Tested By:** Junchang Du
EUT: Wireless Hearing Aid **Model Number:** JLH1
Test Mode: 3DH5 TX 2402MHz **Power Supply:** Battery
Condition: Temp:24.2°C;Humi:62.2% **Test Site:** DDT 3# Chamber
File Path: d:\ts\2024 report data\Q23122824-2E JLH1\FCC ABOVE 1G\92
Memo: L Sample Number:S23122824-03 Power Setting:0X08

Test Graph

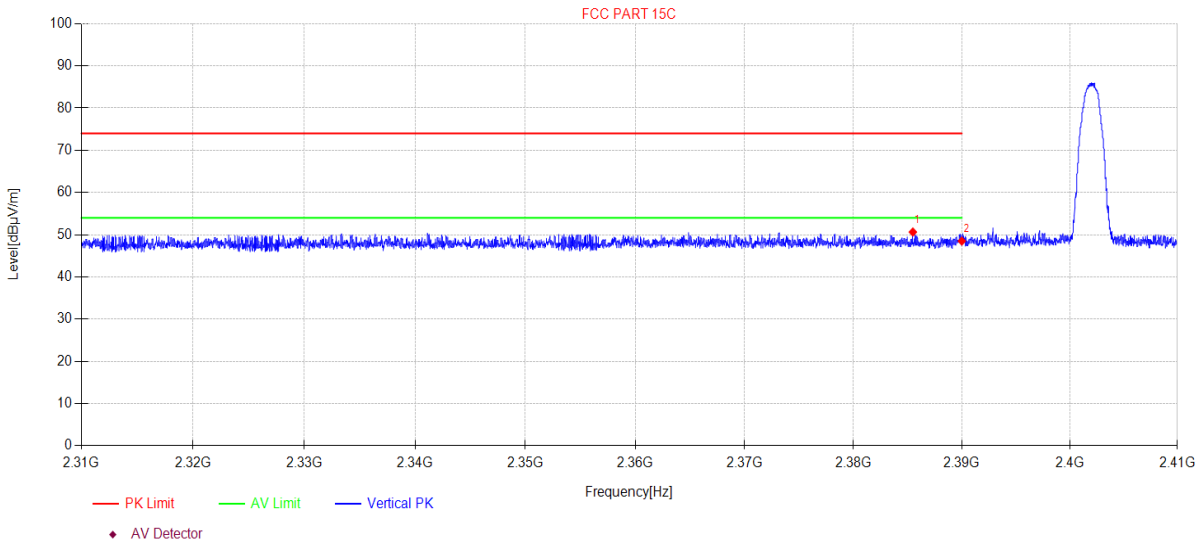

Data List										
N O.	Freq. [MHz]	Reading [dBµV/m]	Antenna Factor [dB]	Cable loss [dB]	AMP [dB]	Level [dBµV/m]	Limit [dBµV/m]	Margin [dB]	Detector	Polarity
1	2385.480	19.54	27.24	3.86	0.00	50.64	74.00	23.36	PK	Vertical
2	2390.000	17.36	27.26	3.87	0.00	48.49	74.00	25.51	PK	Vertical

Note:

1. Level = Reading + Cable loss + Antenna Factor + AMP
2. If Peak Result complies with AV limit, AV Result is deemed to comply with AV limit.
3. Test setup: RBW: 1 MHz, VBW: 3 MHz, Sweep time: auto.

TR-4-E-009 Radiated Emission Test Result

Test Date: 2024-03-27 **Tested By:** Junchang Du
EUT: Wireless Hearing Aid **Model Number:** JLH1
Test Mode: DH5 TX 2480MHz **Power Supply:** Battery
Condition: Temp:24.2°C;Humi:62.2% **Test Site:** DDT 3# Chamber
File Path: d:\ts\2024 report data\Q23122824-2E JLH1\FCC ABOVE 1G\93
Memo: L Sample Number:S23122824-03 Power Setting:0X08

Test Graph

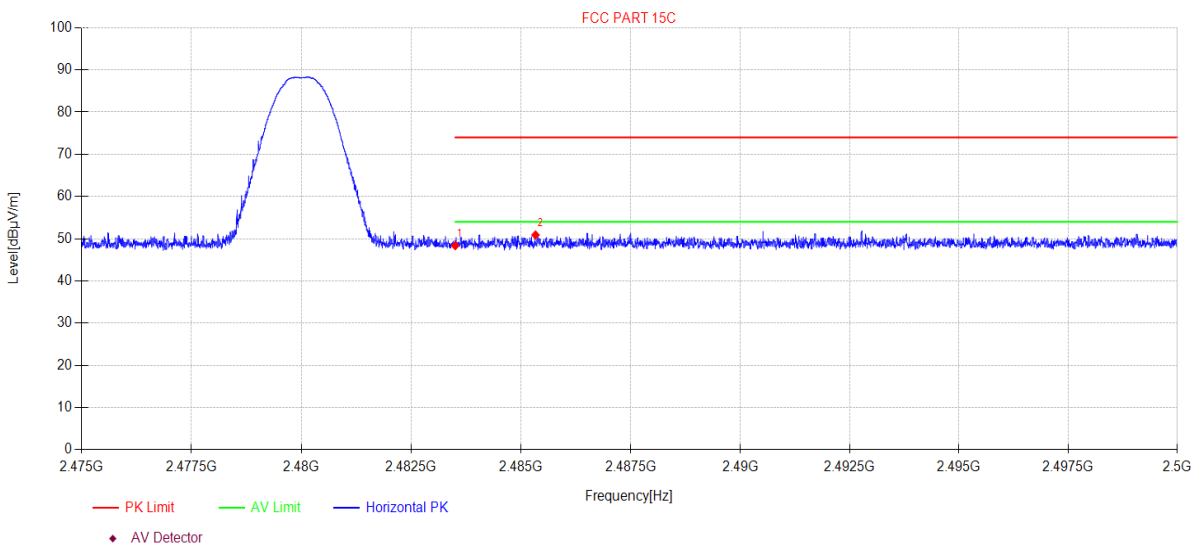

Data List										
N O.	Freq. [MHz]	Reading [dBµV/m]	Antenna Factor [dB]	Cable loss [dB]	AMP [dB]	Level [dBµV/m]	Limit [dBµV/m]	Margin [dB]	Detector	Polarity
1	2483.500	16.89	27.53	3.94	0.00	48.36	74.00	25.64	PK	Horizontal
2	2485.330	19.41	27.54	3.94	0.00	50.89	74.00	23.11	PK	Horizontal

Note:

1. Level = Reading + Cable loss + Antenna Factor + AMP
2. If Peak Result complies with AV limit, AV Result is deemed to comply with AV limit.
3. Test setup: RBW: 1 MHz, VBW: 3 MHz, Sweep time: auto.

TR-4-E-009 Radiated Emission Test Result

Test Date: 2024-03-27 **Tested By:** Junchang Du
EUT: Wireless Hearing Aid **Model Number:** JLH1
Test Mode: DH5 TX 2480MHz **Power Supply:** Battery
Condition: Temp:24.2°C;Humi:62.2% **Test Site:** DDT 3# Chamber
File Path: d:\ts\2024 report data\Q23122824-2E JLH1\FCC ABOVE 1G\94
Memo: L Sample Number:S23122824-03 Power Setting:0X08

Test Graph

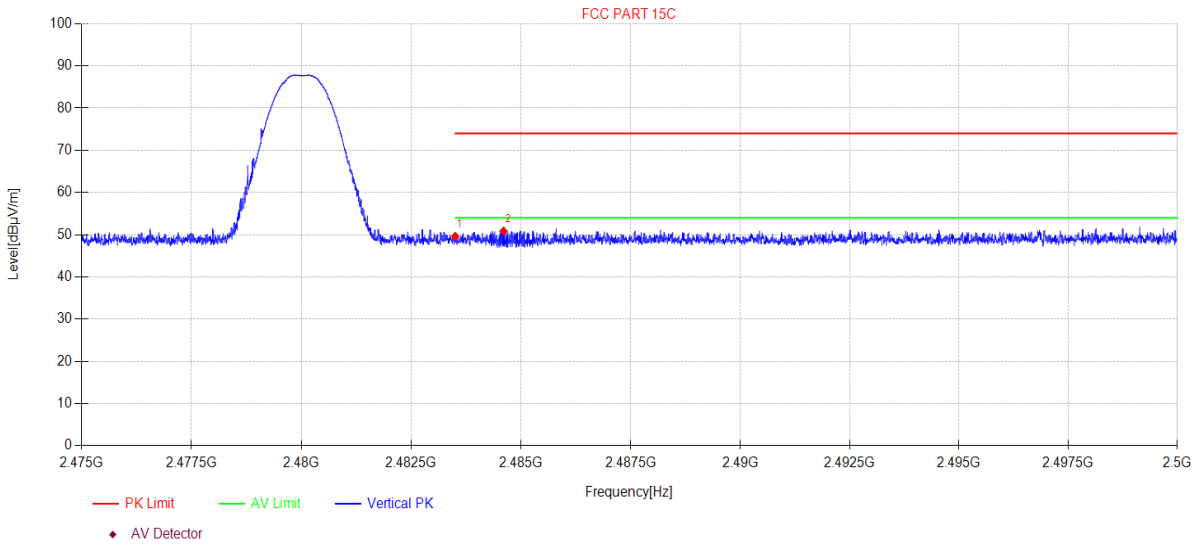

Data List										
N O.	Freq. [MHz]	Reading [dBµV/m]	Antenna Factor [dB]	Cable loss [dB]	AMP [dB]	Level [dBµV/m]	Limit [dBµV/m]	Margin [dB]	Detector	Polarity
1	2483.500	18.12	27.53	3.94	0.00	49.59	74.00	24.41	PK	Vertical
2	2484.600	19.38	27.54	3.94	0.00	50.86	74.00	23.14	PK	Vertical

Note:

1. Level = Reading + Cable loss + Antenna Factor + AMP
2. If Peak Result complies with AV limit, AV Result is deemed to comply with AV limit.
3. Test setup: RBW: 1 MHz, VBW: 3 MHz, Sweep time: auto.

TR-4-E-009 Radiated Emission Test Result

Test Date: 2024-03-27 **Tested By:** Junchang Du
EUT: Wireless Hearing Aid **Model Number:** JLH1
Test Mode: 2DH5 TX 2480MHz **Power Supply:** Battery
Condition: Temp:24.2°C;Humi:62.2% **Test Site:** DDT 3# Chamber
File Path: d:\ts\2024 report data\Q23122824-2E JLH1\FCC ABOVE 1G\95
Memo: L Sample Number:S23122824-03 Power Setting:0X08

Test Graph

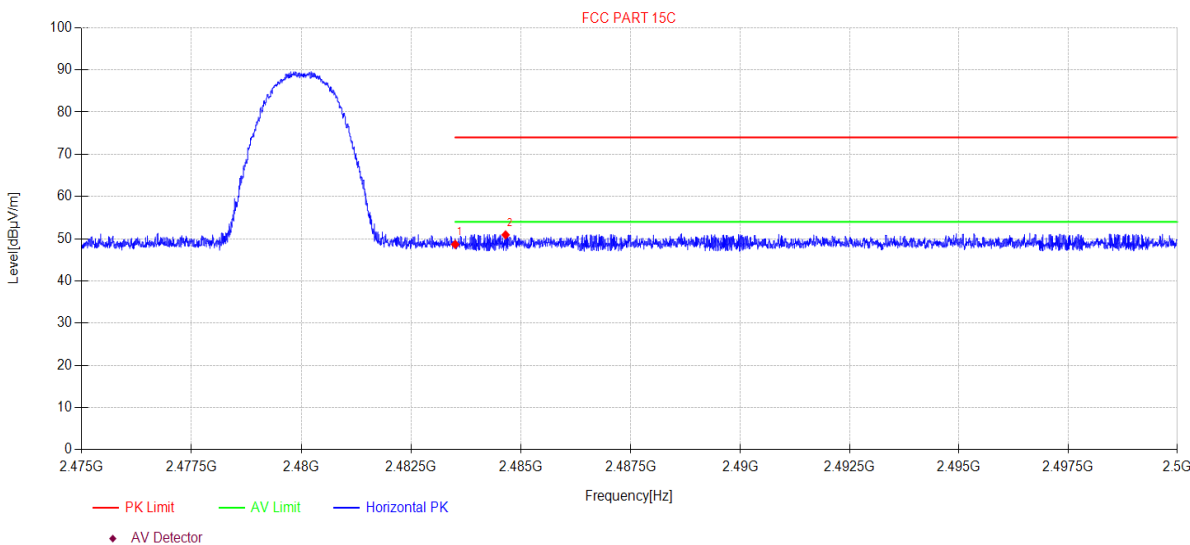

Data List										
N O.	Freq. [MHz]	Reading [dBµV/m]	Antenna Factor [dB]	Cable loss [dB]	AMP [dB]	Level [dBµV/m]	Limit [dBµV/m]	Margin [dB]	Detector	Polarity
1	2483.500	17.19	27.53	3.94	0.00	48.66	74.00	25.34	PK	Horizontal
2	2484.648	19.44	27.54	3.94	0.00	50.92	74.00	23.08	PK	Horizontal

Note:

1. Level = Reading + Cable loss + Antenna Factor + AMP
2. If Peak Result complies with AV limit, AV Result is deemed to comply with AV limit.
3. Test setup: RBW: 1 MHz, VBW: 3 MHz, Sweep time: auto.

TR-4-E-009 Radiated Emission Test Result

Test Date: 2024-03-27 **Tested By:** Junchang Du
EUT: Wireless Hearing Aid **Model Number:** JLH1
Test Mode: 2DH5 TX 2480MHz **Power Supply:** Battery
Condition: Temp:24.2°C;Humi:62.2% **Test Site:** DDT 3# Chamber
File Path: d:\ts\2024 report data\Q23122824-2E JLH1\FCC ABOVE 1G\96
Memo: L Sample Number:S23122824-03 Power Setting:0X08

Test Graph

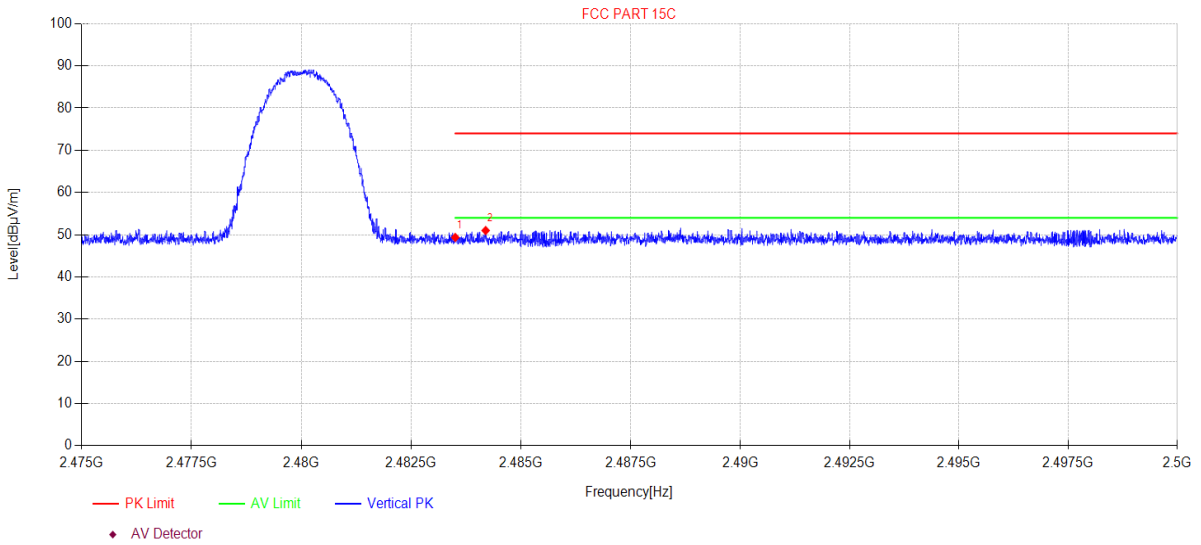

Data List										
N O.	Freq. [MHz]	Reading [dBµV/m]	Antenna Factor [dB]	Cable loss [dB]	AMP [dB]	Level [dBµV/m]	Limit [dBµV/m]	Margin [dB]	Detector	Polarity
1	2483.500	17.89	27.53	3.94	0.00	49.36	74.00	24.64	PK	Vertical
2	2484.193	19.52	27.54	3.94	0.00	51.00	74.00	23.00	PK	Vertical

Note:

1. Level = Reading + Cable loss + Antenna Factor + AMP
2. If Peak Result complies with AV limit, AV Result is deemed to comply with AV limit.
3. Test setup: RBW: 1 MHz, VBW: 3 MHz, Sweep time: auto.

TR-4-E-009 Radiated Emission Test Result

Test Date: 2024-03-27 **Tested By:** Junchang Du
EUT: Wireless Hearing Aid **Model Number:** JLH1
Test Mode: 3DH5 TX 2480MHz **Power Supply:** Battery
Condition: Temp:24.2°C;Humi:62.2% **Test Site:** DDT 3# Chamber
File Path: d:\ts\2024 report data\Q23122824-2E JLH1\FCC ABOVE 1G\97
Memo: L Sample Number:S23122824-03 Power Setting:0X08

Test Graph

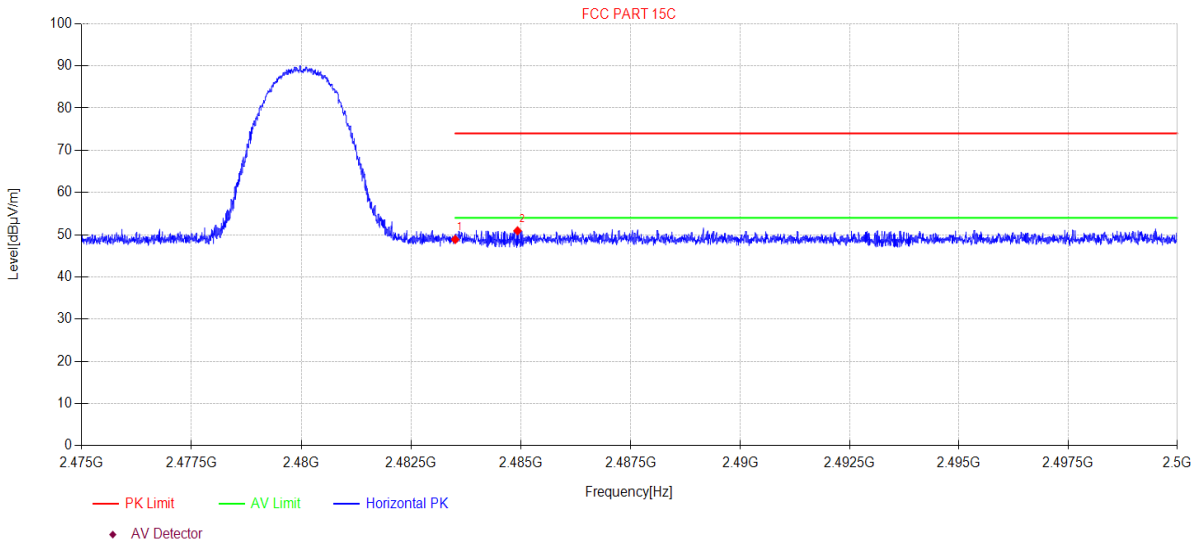

Data List										
N O.	Freq. [MHz]	Reading [dBµV/m]	Antenna Factor [dB]	Cable loss [dB]	AMP [dB]	Level [dBµV/m]	Limit [dBµV/m]	Margin [dB]	Detector	Polarity
1	2483.500	17.40	27.53	3.94	0.00	48.87	74.00	25.13	PK	Horizontal
2	2484.920	19.45	27.54	3.94	0.00	50.93	74.00	23.07	PK	Horizontal

Note:

1. Level = Reading + Cable loss + Antenna Factor + AMP
2. If Peak Result complies with AV limit, AV Result is deemed to comply with AV limit.
3. Test setup: RBW: 1 MHz, VBW: 3 MHz, Sweep time: auto.

TR-4-E-009 Radiated Emission Test Result

Test Date: 2024-03-27 **Tested By:** Junchang Du
EUT: Wireless Hearing Aid **Model Number:** JLH1
Test Mode: 3DH5 TX 2480MHz **Power Supply:** Battery
Condition: Temp:24.2°C;Humi:62.2% **Test Site:** DDT 3# Chamber
File Path: d:\ts\2024 report data\Q23122824-2E JLH1\FCC ABOVE 1G\98
Memo: L Sample Number:S23122824-03 Power Setting:0X08

Test Graph

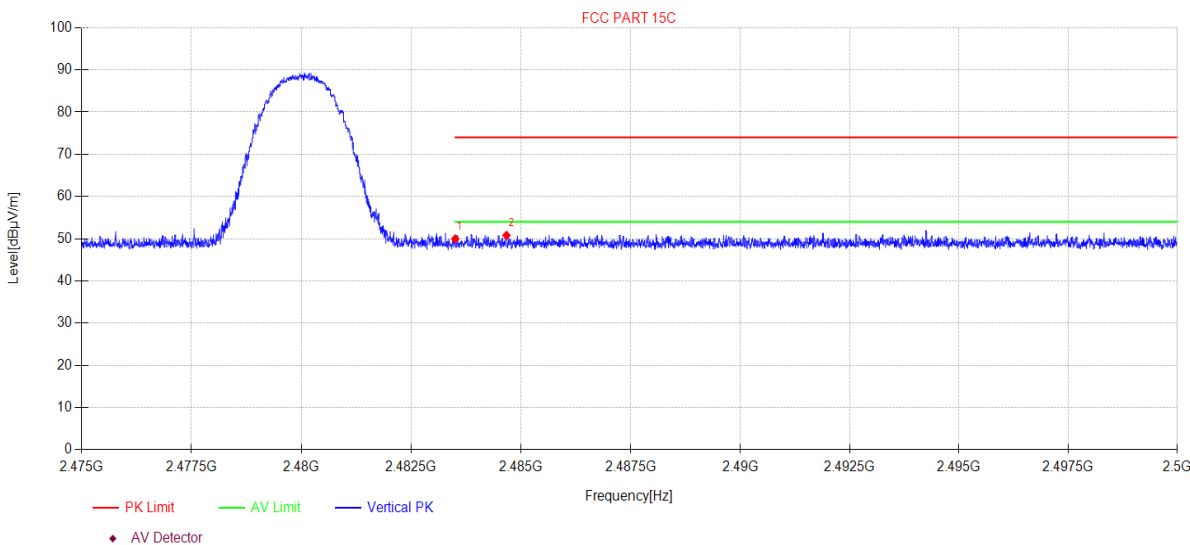

Data List										
N O.	Freq. [MHz]	Reading [dBµV/m]	Antenna Factor [dB]	Cable loss [dB]	AMP [dB]	Level [dBµV/m]	Limit [dBµV/m]	Margin [dB]	Detector	Polarity
1	2483.500	18.50	27.53	3.94	0.00	49.97	74.00	24.03	PK	Vertical
2	2484.668	19.33	27.54	3.94	0.00	50.81	74.00	23.19	PK	Vertical

Note:

1. Level = Reading + Cable loss + Antenna Factor + AMP
2. If Peak Result complies with AV limit, AV Result is deemed to comply with AV limit.
3. Test setup: RBW: 1 MHz, VBW: 3 MHz, Sweep time: auto.

TR-4-E-009 Radiated Emission Test Result

Test Date: 2024-03-26 **Tested By:** Junchang Du
EUT: Wireless Hearing Aid **Model Number:** JLH1
Test Mode: DH5 TX 2402MHz **Power Supply:** Battery
Condition: Temp:24.2°C;Humi:62.2% **Test Site:** DDT 3# Chamber
File Path: d:\ts\2024 report data\Q23122824-2E JLH1\FCC ABOVE 1G49
Memo: R Sample Number:S23122824-03 Power Setting:0X08

Test Graph

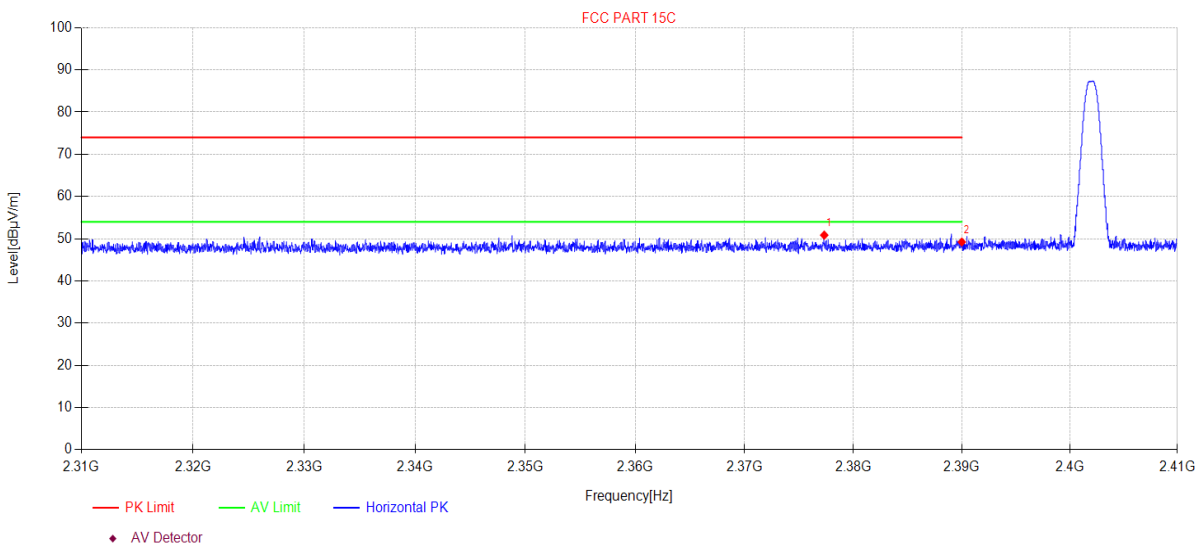

Data List										
N O.	Freq. [MHz]	Reading [dBµV/m]	Antenna Factor [dB]	Cable loss [dB]	AMP [dB]	Level [dBµV/m]	Limit [dBµV/m]	Margin [dB]	Detector	Polarity
1	2377.320	19.78	27.21	3.86	0.00	50.85	74.00	23.15	PK	Horizontal
2	2390.000	18.09	27.26	3.87	0.00	49.22	74.00	24.78	PK	Horizontal

Note:

1. Level = Reading + Cable loss + Antenna Factor + AMP
2. If Peak Result complies with AV limit, AV Result is deemed to comply with AV limit.
3. Test setup: RBW: 1 MHz, VBW: 3 MHz, Sweep time: auto.

TR-4-E-009 Radiated Emission Test Result

Test Date: 2024-03-26 **Tested By:** Junchang Du
EUT: Wireless Hearing Aid **Model Number:** JLH1
Test Mode: DH5 TX 2402MHz **Power Supply:** Battery
Condition: Temp:24.2°C;Humi:62.2% **Test Site:** DDT 3# Chamber
File Path: d:\ts\2024 report data\Q23122824-2E JLH1\FCC ABOVE 1G\50
Memo: R Sample Number:S23122824-03 Power Setting:0X08

Test Graph

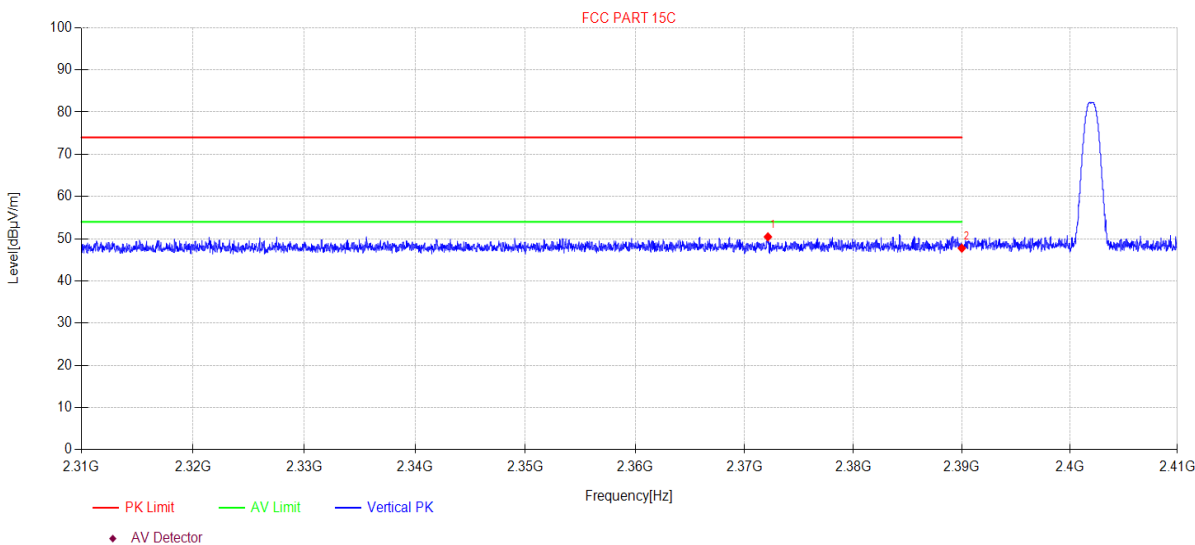

Data List										
N O.	Freq. [MHz]	Reading [dBµV/m]	Antenna Factor [dB]	Cable loss [dB]	AMP [dB]	Level [dBµV/m]	Limit [dBµV/m]	Margin [dB]	Detector	Polarity
1	2372.150	19.40	27.19	3.85	0.00	50.44	74.00	23.56	PK	Vertical
2	2390.000	16.63	27.26	3.87	0.00	47.76	74.00	26.24	PK	Vertical

Note:

1. Level = Reading + Cable loss + Antenna Factor + AMP
2. If Peak Result complies with AV limit, AV Result is deemed to comply with AV limit.
3. Test setup: RBW: 1 MHz, VBW: 3 MHz, Sweep time: auto.

TR-4-E-009 Radiated Emission Test Result

Test Date: 2024-03-26 **Tested By:** Junchang Du
EUT: Wireless Hearing Aid **Model Number:** JLH1
Test Mode: 2DH5 TX 2402MHz **Power Supply:** Battery
Condition: Temp:24.2°C;Humi:62.2% **Test Site:** DDT 3# Chamber
File Path: d:\ts\2024 report data\Q23122824-2E JLH1\FCC ABOVE 1G\51
Memo: R Sample Number:S23122824-03 Power Setting:0X08

Test Graph

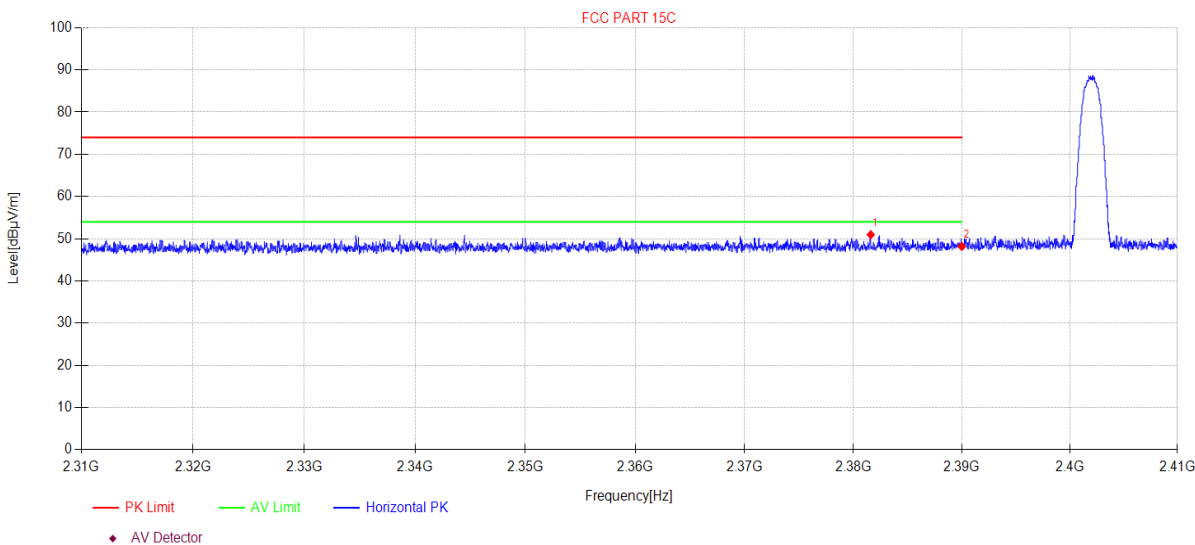

Data List										
N O.	Freq. [MHz]	Reading [dBµV/m]	Antenna Factor [dB]	Cable loss [dB]	AMP [dB]	Level [dBµV/m]	Limit [dBµV/m]	Margin [dB]	Detector	Polarity
1	2381.600	19.87	27.23	3.86	0.00	50.96	74.00	23.04	PK	Horizontal
2	2390.000	17.06	27.26	3.87	0.00	48.19	74.00	25.81	PK	Horizontal

Note:

1. Level = Reading + Cable loss + Antenna Factor + AMP
2. If Peak Result complies with AV limit, AV Result is deemed to comply with AV limit.
3. Test setup: RBW: 1 MHz, VBW: 3 MHz, Sweep time: auto.

TR-4-E-009 Radiated Emission Test Result

Test Date: 2024-03-26 **Tested By:** Junchang Du
EUT: Wireless Hearing Aid **Model Number:** JLH1
Test Mode: 2DH5 TX 2402MHz **Power Supply:** Battery
Condition: Temp:24.2°C;Humi:62.2% **Test Site:** DDT 3# Chamber
File Path: d:\ts\2024 report data\Q23122824-2E JLH1\FCC ABOVE 1G\52
Memo: R Sample Number:S23122824-03 Power Setting:0X08

Test Graph

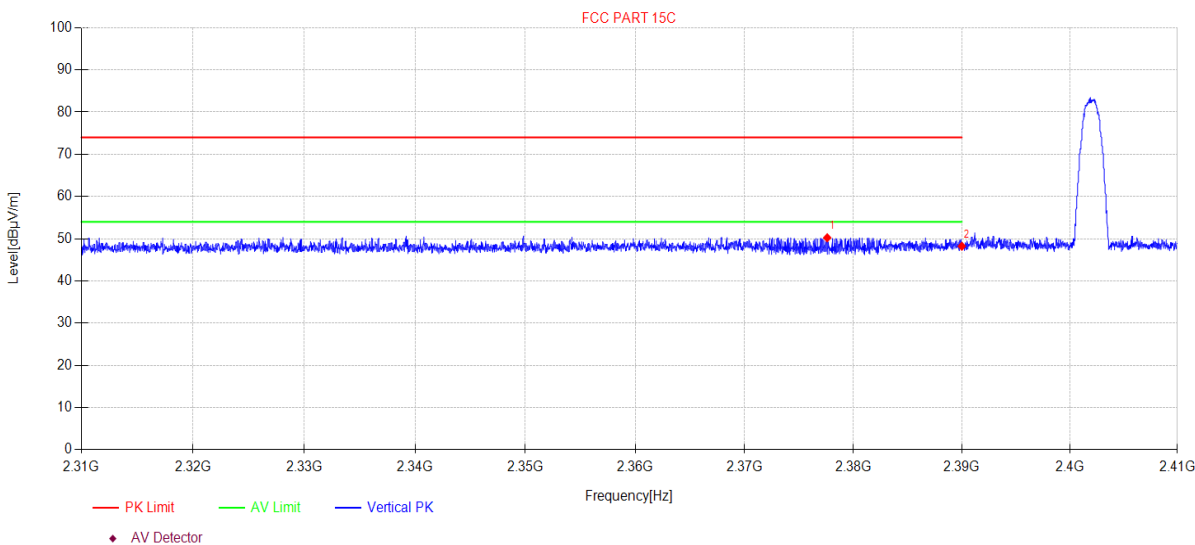

Data List										
N O.	Freq. [MHz]	Reading [dBµV/m]	Antenna Factor [dB]	Cable loss [dB]	AMP [dB]	Level [dBµV/m]	Limit [dBµV/m]	Margin [dB]	Detector	Polarity
1	2377.590	19.15	27.21	3.86	0.00	50.22	74.00	23.78	PK	Vertical
2	2390.000	17.09	27.26	3.87	0.00	48.22	74.00	25.78	PK	Vertical

Note:

1. Level = Reading + Cable loss + Antenna Factor + AMP
2. If Peak Result complies with AV limit, AV Result is deemed to comply with AV limit.
3. Test setup: RBW: 1 MHz, VBW: 3 MHz, Sweep time: auto.

TR-4-E-009 Radiated Emission Test Result

Test Date: 2024-03-26 **Tested By:** Junchang Du
EUT: Wireless Hearing Aid **Model Number:** JLH1
Test Mode: 3DH5 TX 2402MHz **Power Supply:** Battery
Condition: Temp:24.2°C;Humi:62.2% **Test Site:** DDT 3# Chamber
File Path: d:\ts\2024 report data\Q23122824-2E JLH1\FCC ABOVE 1G\53
Memo: R Sample Number:S23122824-03 Power Setting:0X08

Test Graph

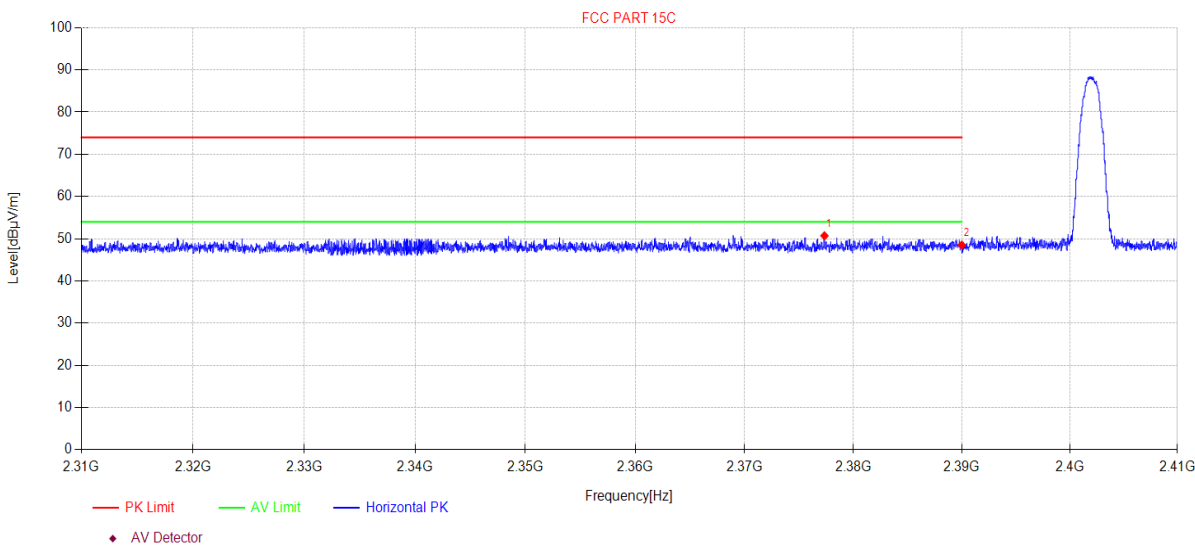

Data List										
N O.	Freq. [MHz]	Reading [dBµV/m]	Antenna Factor [dB]	Cable loss [dB]	AMP [dB]	Level [dBµV/m]	Limit [dBµV/m]	Margin [dB]	Detector	Polarity
1	2377.340	19.63	27.21	3.86	0.00	50.70	74.00	23.30	PK	Horizontal
2	2390.000	17.37	27.26	3.87	0.00	48.50	74.00	25.50	PK	Horizontal

Note:

1. Level = Reading + Cable loss + Antenna Factor + AMP
2. If Peak Result complies with AV limit, AV Result is deemed to comply with AV limit.
3. Test setup: RBW: 1 MHz, VBW: 3 MHz, Sweep time: auto.

TR-4-E-009 Radiated Emission Test Result

Test Date: 2024-03-26 **Tested By:** Junchang Du
EUT: Wireless Hearing Aid **Model Number:** JLH1
Test Mode: 3DH5 TX 2402MHz **Power Supply:** Battery
Condition: Temp:24.2°C;Humi:62.2% **Test Site:** DDT 3# Chamber
File Path: d:\ts\2024 report data\Q23122824-2E JLH1\FCC ABOVE 1G\54
Memo: R Sample Number:S23122824-03 Power Setting:0X08

Test Graph

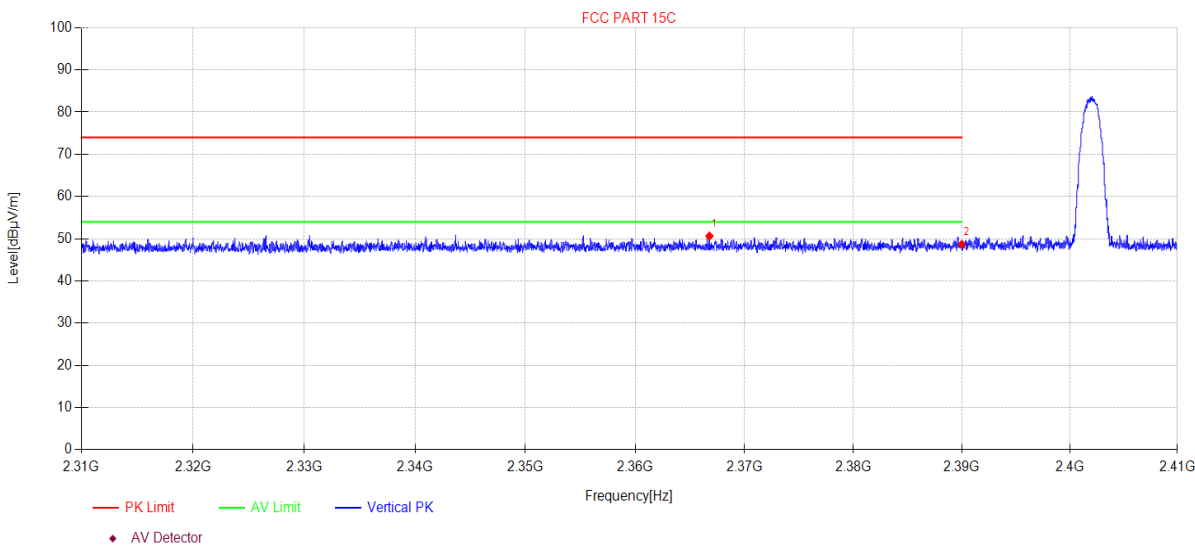

Data List										
N O.	Freq. [MHz]	Reading [dBµV/m]	Antenna Factor [dB]	Cable loss [dB]	AMP [dB]	Level [dBµV/m]	Limit [dBµV/m]	Margin [dB]	Detector	Polarity
1	2366.790	19.61	27.17	3.85	0.00	50.63	74.00	23.37	PK	Vertical
2	2390.000	17.54	27.26	3.87	0.00	48.67	74.00	25.33	PK	Vertical

Note:

1. Level = Reading + Cable loss + Antenna Factor + AMP
2. If Peak Result complies with AV limit, AV Result is deemed to comply with AV limit.
3. Test setup: RBW: 1 MHz, VBW: 3 MHz, Sweep time: auto.

TR-4-E-009 Radiated Emission Test Result

Test Date: 2024-03-26 **Tested By:** Junchang Du
EUT: Wireless Hearing Aid **Model Number:** JLH1
Test Mode: DH5 TX 2480MHz **Power Supply:** Battery
Condition: Temp:24.2°C;Humi:62.2% **Test Site:** DDT 3# Chamber
File Path: d:\ts\2024 report data\Q23122824-2E JLH1\FCC ABOVE 1G\55
Memo: R Sample Number:S23122824-03 Power Setting:0X08

Test Graph

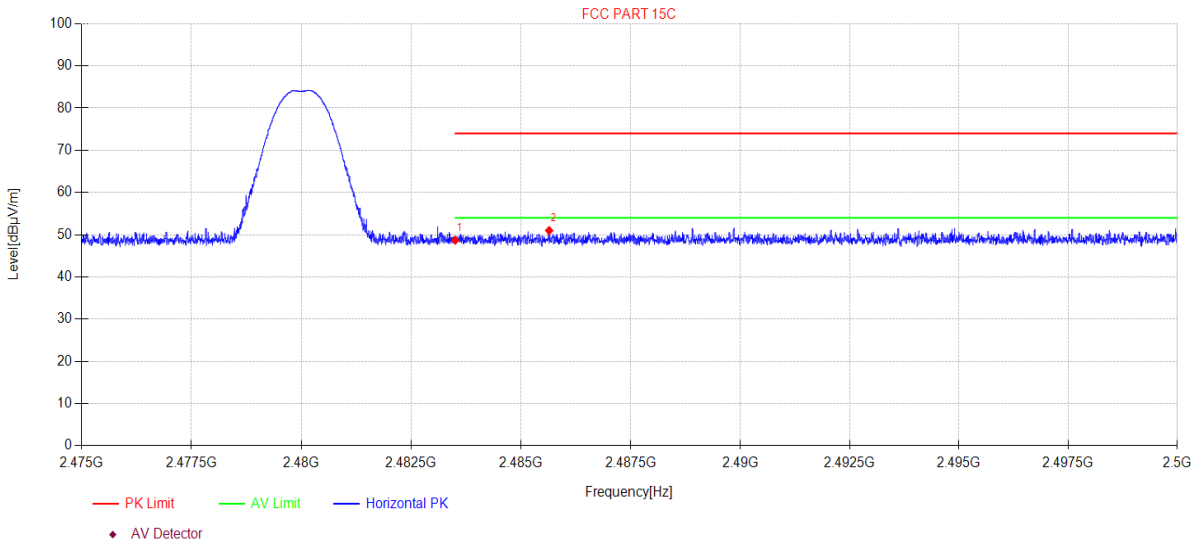

Data List										
N O.	Freq. [MHz]	Reading [dBµV/m]	Antenna Factor [dB]	Cable loss [dB]	AMP [dB]	Level [dBµV/m]	Limit [dBµV/m]	Margin [dB]	Detector	Polarity
1	2483.500	17.24	27.53	3.94	0.00	48.71	74.00	25.29	PK	Horizontal
2	2485.640	19.51	27.54	3.94	0.00	50.99	74.00	23.01	PK	Horizontal

Note:

1. Level = Reading + Cable loss + Antenna Factor + AMP
2. If Peak Result complies with AV limit, AV Result is deemed to comply with AV limit.
3. Test setup: RBW: 1 MHz, VBW: 3 MHz, Sweep time: auto.

TR-4-E-009 Radiated Emission Test Result

Test Date: 2024-03-26 **Tested By:** Junchang Du
EUT: Wireless Hearing Aid **Model Number:** JLH1
Test Mode: DH5 TX 2480MHz **Power Supply:** Battery
Condition: Temp:24.2°C;Humi:62.2% **Test Site:** DDT 3# Chamber
File Path: d:\ts\2024 report data\Q23122824-2E JLH1\FCC ABOVE 1G\56
Memo: R Sample Number:S23122824-03 Power Setting:0X08

Test Graph

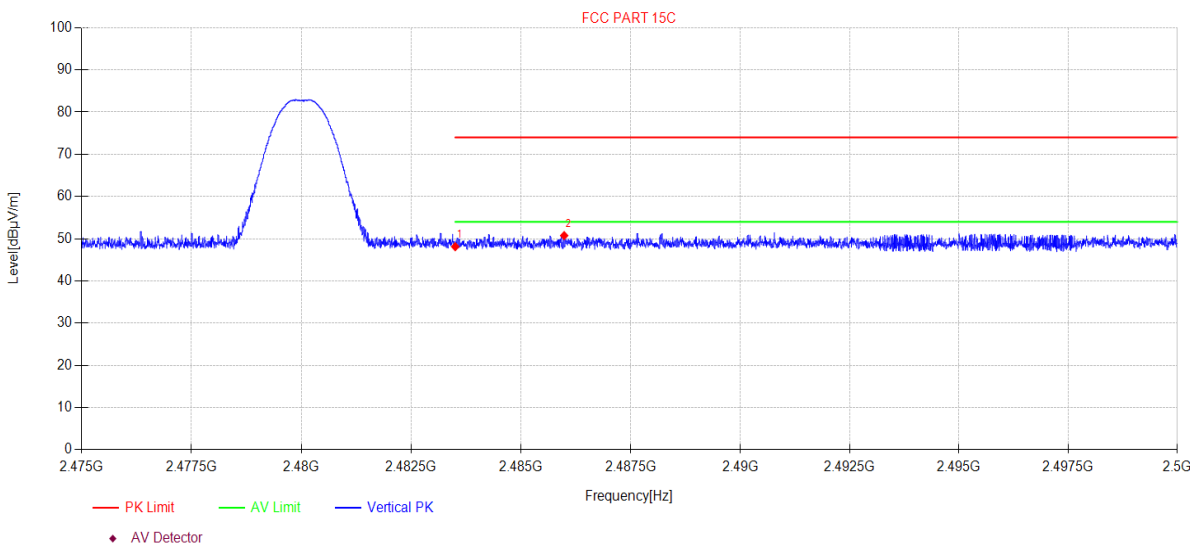

Data List										
N O.	Freq. [MHz]	Reading [dBµV/m]	Antenna Factor [dB]	Cable loss [dB]	AMP [dB]	Level [dBµV/m]	Limit [dBµV/m]	Margin [dB]	Detector	Polarity
1	2483.500	16.65	27.53	3.94	0.00	48.12	74.00	25.88	PK	Vertical
2	2485.983	19.27	27.54	3.94	0.00	50.75	74.00	23.25	PK	Vertical

Note:

1. Level = Reading + Cable loss + Antenna Factor + AMP
2. If Peak Result complies with AV limit, AV Result is deemed to comply with AV limit.
3. Test setup: RBW: 1 MHz, VBW: 3 MHz, Sweep time: auto.

TR-4-E-009 Radiated Emission Test Result

Test Date: 2024-03-26 **Tested By:** Junchang Du
EUT: Wireless Hearing Aid **Model Number:** JLH1
Test Mode: 2DH5 TX 2480MHz **Power Supply:** Battery
Condition: Temp:24.2°C;Humi:62.2% **Test Site:** DDT 3# Chamber
File Path: d:\ts\2024 report data\Q23122824-2E JLH1\FCC ABOVE 1G\57
Memo: R Sample Number:S23122824-03 Power Setting:0X08

Test Graph

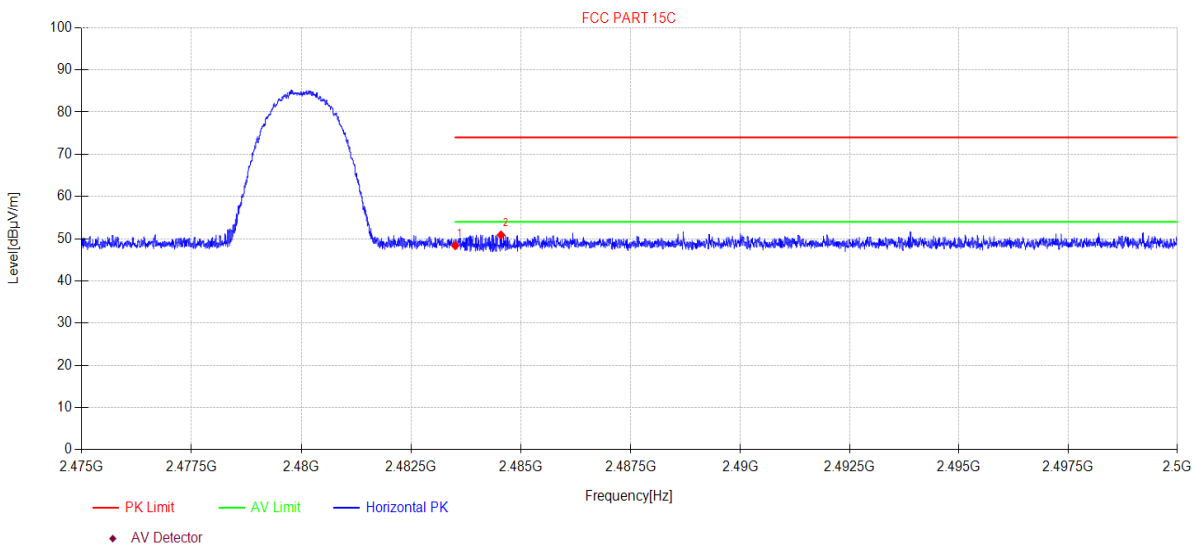

Data List										
N O.	Freq. [MHz]	Reading [dBµV/m]	Antenna Factor [dB]	Cable loss [dB]	AMP [dB]	Level [dBµV/m]	Limit [dBµV/m]	Margin [dB]	Detector	Polarity
1	2483.500	16.92	27.53	3.94	0.00	48.39	74.00	25.61	PK	Horizontal
2	2484.543	19.42	27.54	3.94	0.00	50.90	74.00	23.10	PK	Horizontal

Note:

1. Level = Reading + Cable loss + Antenna Factor + AMP
2. If Peak Result complies with AV limit, AV Result is deemed to comply with AV limit.
3. Test setup: RBW: 1 MHz, VBW: 3 MHz, Sweep time: auto.

TR-4-E-009 Radiated Emission Test Result

Test Date: 2024-03-26 **Tested By:** Junchang Du
EUT: Wireless Hearing Aid **Model Number:** JLH1
Test Mode: 2DH5 TX 2480MHz **Power Supply:** Battery
Condition: Temp:24.2°C;Humi:62.2% **Test Site:** DDT 3# Chamber
File Path: d:\ts\2024 report data\Q23122824-2E JLH1\FCC ABOVE 1G\58
Memo: R Sample Number:S23122824-03 Power Setting:0X08

Test Graph

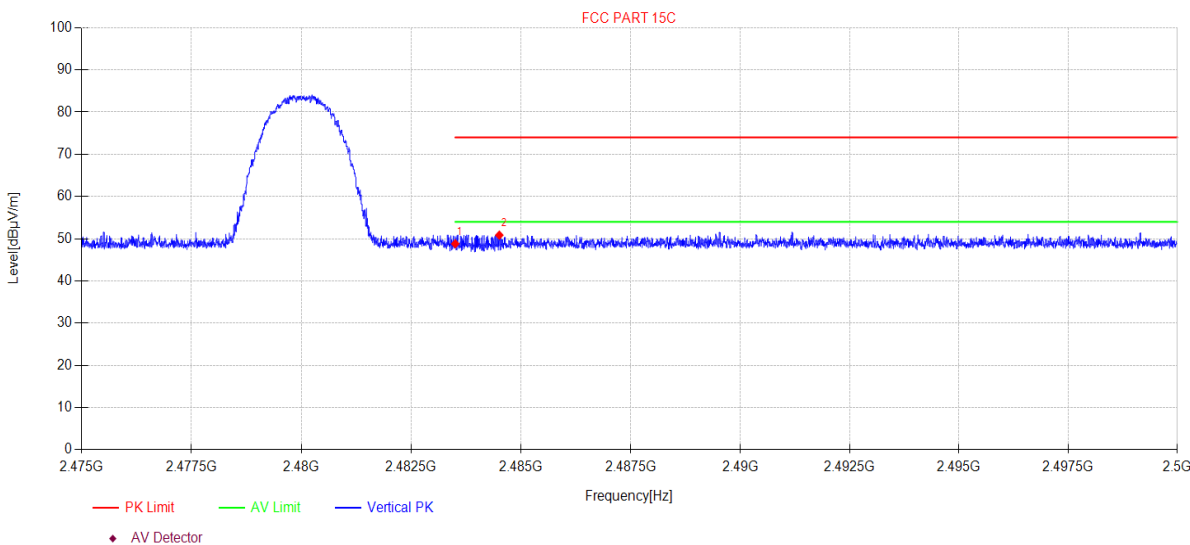

Data List										
N O.	Freq. [MHz]	Reading [dBµV/m]	Antenna Factor [dB]	Cable loss [dB]	AMP [dB]	Level [dBµV/m]	Limit [dBµV/m]	Margin [dB]	Detector	Polarity
1	2483.500	17.34	27.53	3.94	0.00	48.81	74.00	25.19	PK	Vertical
2	2484.505	19.37	27.54	3.94	0.00	50.85	74.00	23.15	PK	Vertical

Note:

1. Level = Reading + Cable loss + Antenna Factor + AMP
2. If Peak Result complies with AV limit, AV Result is deemed to comply with AV limit.
3. Test setup: RBW: 1 MHz, VBW: 3 MHz, Sweep time: auto.

TR-4-E-009 Radiated Emission Test Result

Test Date: 2024-03-26 **Tested By:** Junchang Du
EUT: Wireless Hearing Aid **Model Number:** JLH1
Test Mode: 3DH5 TX 2480MHz **Power Supply:** Battery
Condition: Temp:24.2°C;Humi:62.2% **Test Site:** DDT 3# Chamber
File Path: d:\ts\2024 report data\Q23122824-2E JLH1\FCC ABOVE 1G\59
Memo: R Sample Number:S23122824-03 Power Setting:0X08

Test Graph

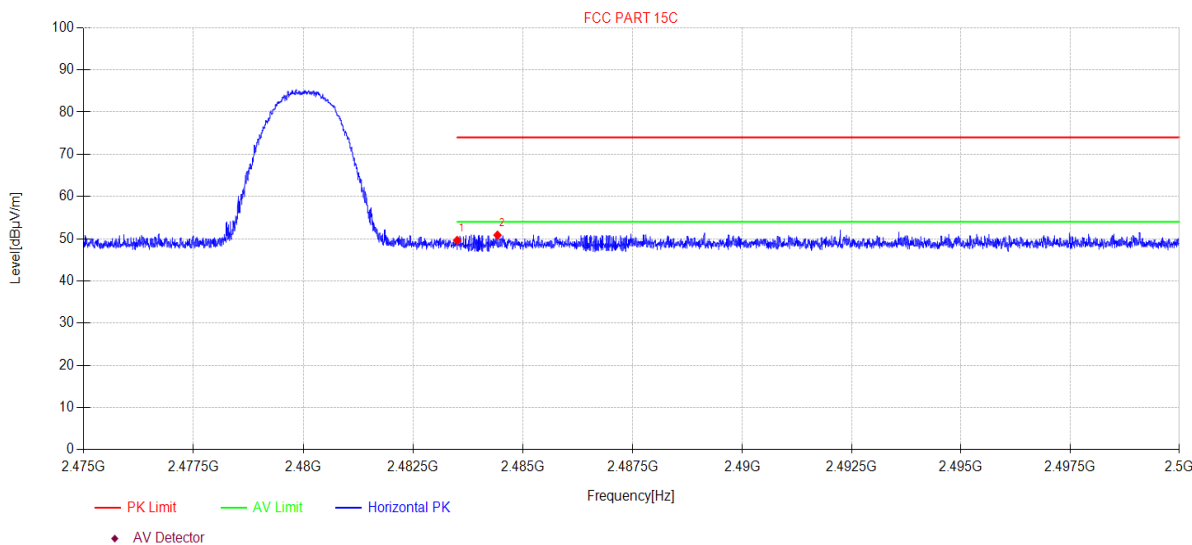

Data List										
N O.	Freq. [MHz]	Reading [dBµV/m]	Antenna Factor [dB]	Cable loss [dB]	AMP [dB]	Level [dBµV/m]	Limit [dBµV/m]	Margin [dB]	Detector	Polarity
1	2483.500	18.14	27.53	3.94	0.00	49.61	74.00	24.39	PK	Horizontal
2	2484.418	19.38	27.54	3.94	0.00	50.86	74.00	23.14	PK	Horizontal

Note:

1. Level = Reading + Cable loss + Antenna Factor + AMP
2. If Peak Result complies with AV limit, AV Result is deemed to comply with AV limit.
3. Test setup: RBW: 1 MHz, VBW: 3 MHz, Sweep time: auto.

TR-4-E-009 Radiated Emission Test Result

Test Date: 2024-03-26 **Tested By:** Junchang Du
EUT: Wireless Hearing Aid **Model Number:** JLH1
Test Mode: 3DH5 TX 2480MHz **Power Supply:** Battery
Condition: Temp:24.2°C;Humi:62.2% **Test Site:** DDT 3# Chamber
File Path: d:\ts\2024 report data\Q23122824-2E JLH1\FCC ABOVE 1G\60
Memo: R Sample Number:S23122824-03 Power Setting:0X08

Test Graph

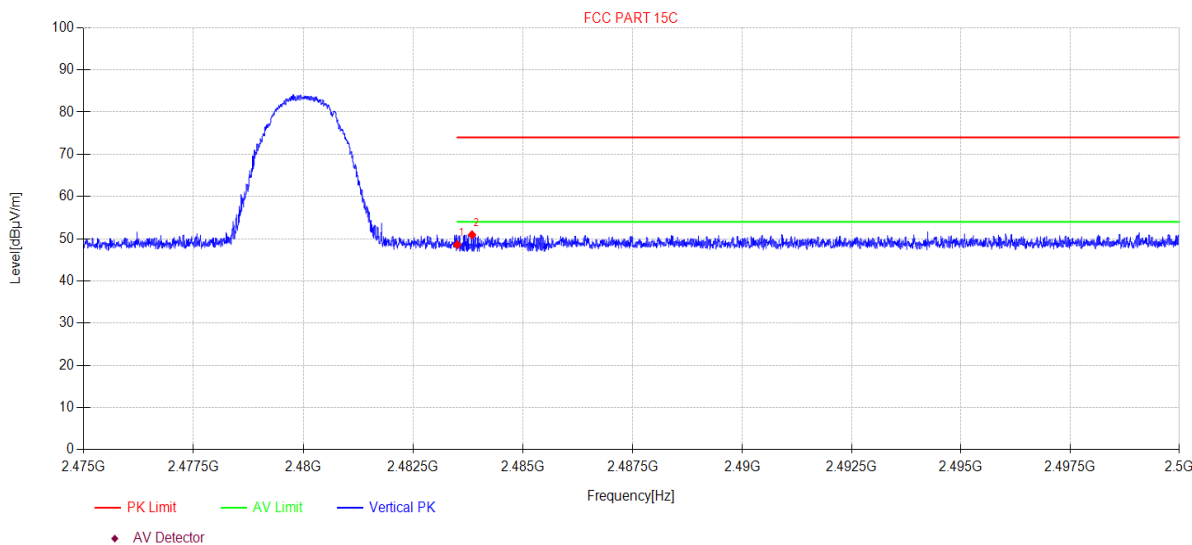

Data List										
N O.	Freq. [MHz]	Reading [dBµV/m]	Antenna Factor [dB]	Cable loss [dB]	AMP [dB]	Level [dBµV/m]	Limit [dBµV/m]	Margin [dB]	Detector	Polarity
1	2483.500	17.12	27.53	3.94	0.00	48.59	74.00	25.41	PK	Vertical
2	2483.838	19.45	27.54	3.94	0.00	50.93	74.00	23.07	PK	Vertical

Note:

1. Level = Reading + Cable loss + Antenna Factor + AMP
2. If Peak Result complies with AV limit, AV Result is deemed to comply with AV limit.
3. Test setup: RBW: 1 MHz, VBW: 3 MHz, Sweep time: auto.

16. Power Line Conducted Emissions

16.1. Test equipment

Equipment	Manufacturer	Model No.	Serial No.	Cal Due To
Two Line V-Network	R&S	ENV216	DDT-ZC00535	2024/07/10
Pulse Limiter	SCHWARZBEC K	ESH3-Z2	DDT-ZC00539	2024/07/14
CE Cable 1	R&S	ESU8/RF2	DDT-ZC00566	2024/07/14
EMI Test Software	Audix/TW	e3	DDT-ZC01252	/
Artificial mains	R&S	ESH2-Z5	DDT-ZC00538	2024/07/11
EMI Test Receiver	R&S	ESCI	DDT-ZC00235	2024/07/10

16.2. Block diagram of test setup

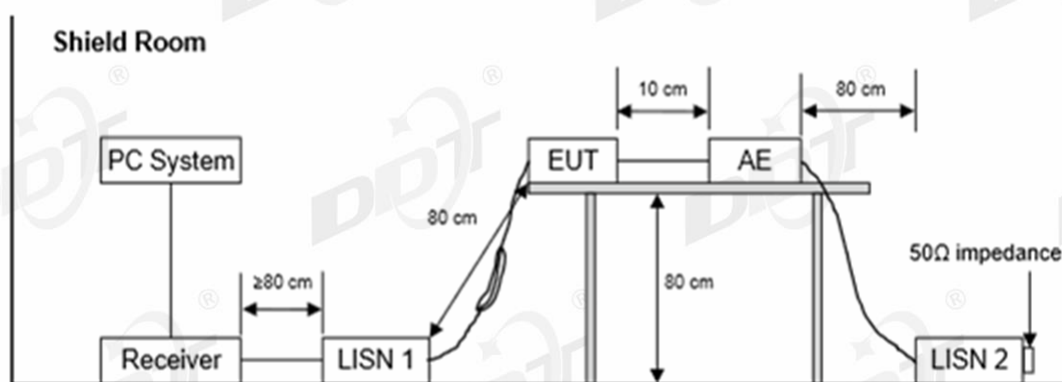

16.3. Limits

Frequency	Quasi-Peak Level dB(mV)	Average Level dB(mV)
150 kHz~500 kHz	66 ~ 56*	56 ~ 46*
500 kHz~5 MHz	56	46
5 MHz~30 MHz	60	50

Note 1: * Decreasing linearly with logarithm of frequency.

Note 2: The lower limit shall apply at the transition frequencies.

16.4. Assistant equipment used for test

Assistant equipment	Manufacturer	Model number	Description	other
Adapter	SAMSUNG	EP-TA200	Samsung fast charging	Input: 100-240~, 50/60Hz, 0.5A; Output: 9V/1.67A or 5V/2A

16.5. Test procedure

The EUT and Support equipment, if needed, were put placed on a non-metallic table, 80cm above the ground plane.

All support equipment power received from a second LISN.

Emissions were measured on each current carrying line of the EUT using an EMI Test Receiver connected to the LISN powering the EUT.

The Receiver scanned from 150 kHz to 30 MHz for emissions in each of the test modes.

During the above scans, the emissions were maximized by cable manipulation.

The test mode(s) described in clause 2.4 were scanned during the preliminary test.

After the preliminary scan, we found the test mode producing the highest emission level.

The EUT configuration and worse cable configuration of the above highest emission levels were recorded for reference of the final test.

EUT and support equipment were set up on the test bench as per the configuration with highest emission level in the preliminary test.

A scan was taken on both power lines, Neutral and Line, recording at least the six highest emissions.

Emission frequency and amplitude were recorded into a computer in which correction factors were used to calculate the emission level and compare reading to the applicable limit.

The test data of the worst-case condition(s) was recorded.

The bandwidth of test receiver is set at 9 kHz.

16.6. Test result

PASS. (See below detailed test result)

Note1: All emissions not reported below are too low against the prescribed limits.

Note2: "----" means Peak detection; "----" means Average detection.

Note3: Pre-test AC conducted emission at both voltage AC 120V/60Hz and AC 240V/50Hz, recorded the worst case.

16.7. Test data

TR-4-E-010 Conducted Emission Test Result

Test Site	: DDT 1# Shield Room	D:\2024 CE report data\Q23122824-2E\FCC CE.EM6
Test Date	: 2024-03-30	Tested By : Junchang Du
EUT	: Wireless Hearing Aid	Model Number : JLH1
Power Supply	: AC 120V/60Hz	Test Mode : BT mode
Condition	: TEMP:22.2°C, RH:57.5%	LISN : 2023 1# ENV216/LINE
Memo	: Sample Number:S23122824-03	

Data: 2

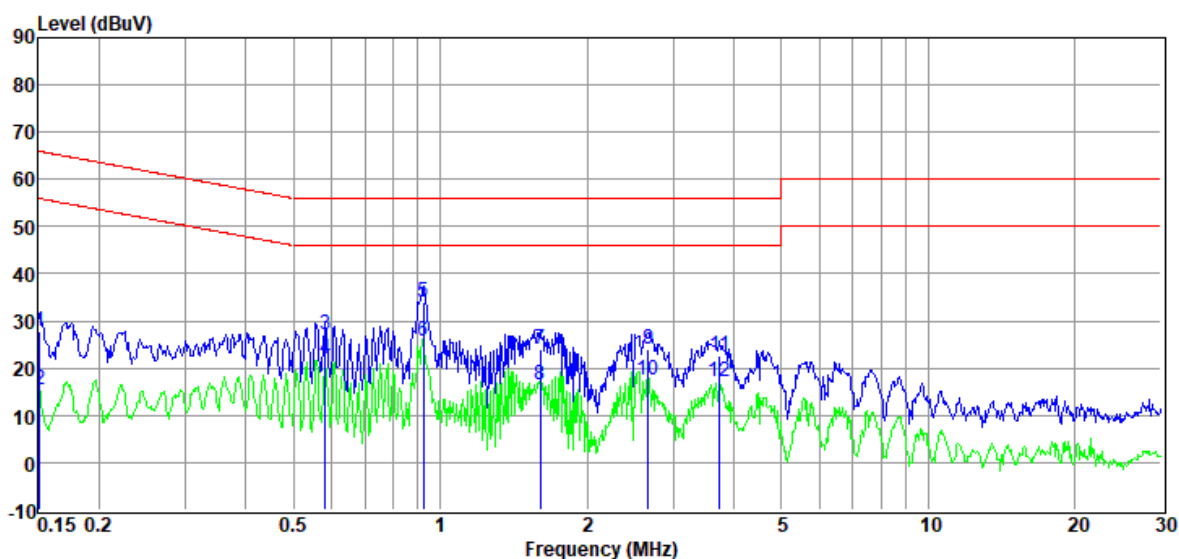

Item (Mark)	Freq. (MHz)	Read Level (dBuV)	LISN Factor (dB)	Cable Loss (dB)	Pulse Limiter Factor (dB)	Result Level (dBuV)	Limit Line (dBuV)	Over Limit (dB)	Detector	Phase
1	0.15	7.31	9.85	0.92	9.68	27.76	65.96	-38.20	QP	LINE
2	0.15	-5.05	9.85	0.92	9.68	15.40	55.96	-40.56	Average	LINE
3	0.58	6.91	9.79	0.83	9.72	27.25	56.00	-28.75	QP	LINE
4	0.58	1.49	9.79	0.83	9.72	21.83	46.00	-24.17	Average	LINE
5	0.92	13.99	9.60	0.69	9.73	34.01	56.00	-21.99	QP	LINE
6	0.92	5.57	9.60	0.69	9.73	25.59	46.00	-20.41	Average	LINE
7	1.60	3.99	9.67	0.65	9.75	24.06	56.00	-31.94	QP	LINE
8	1.60	-3.48	9.67	0.65	9.75	16.59	46.00	-29.41	Average	LINE
9	2.66	3.89	9.70	0.60	9.77	23.96	56.00	-32.04	QP	LINE
10	2.66	-2.54	9.70	0.60	9.77	17.53	46.00	-28.47	Average	LINE
11	3.74	2.69	9.65	0.57	9.78	22.69	56.00	-33.31	QP	LINE
12	3.74	-2.82	9.65	0.57	9.78	17.18	46.00	-28.82	Average	LINE

Note:

1. Result Level = Read Level + LISN Factor + Pulse Limiter Factor + Cable loss.
2. If QP Result complies with AV limit, AV Result is deemed to comply with AV limit.
3. Test setup: RBW: 200 Hz (9 kHz—150 kHz), 9 kHz (150 kHz—30 MHz).
4. Step size: 80Hz (0.009MHz-0.15MHz), 4 kHz (0.15MHz-30MHz), Scan time: auto.

TR-4-E-010 Conducted Emission Test Result

Test Site	: DDT 1# Shield Room	D:\2024 CE report data\Q23122824-2E\FCC CE.EM6
Test Date	: 2024-03-30	Tested By : Junchang Du
EUT	: Wireless Hearing Aid	Model Number : JLH1
Power Supply	: AC 120V/60Hz	Test Mode : BT mode
Condition	: TEMP:22.2°C, RH:57.5%	LISN : 2023 1# ENV216/NEUTRAL
Memo	: Sample Number:S23122824-03	

Data: 4

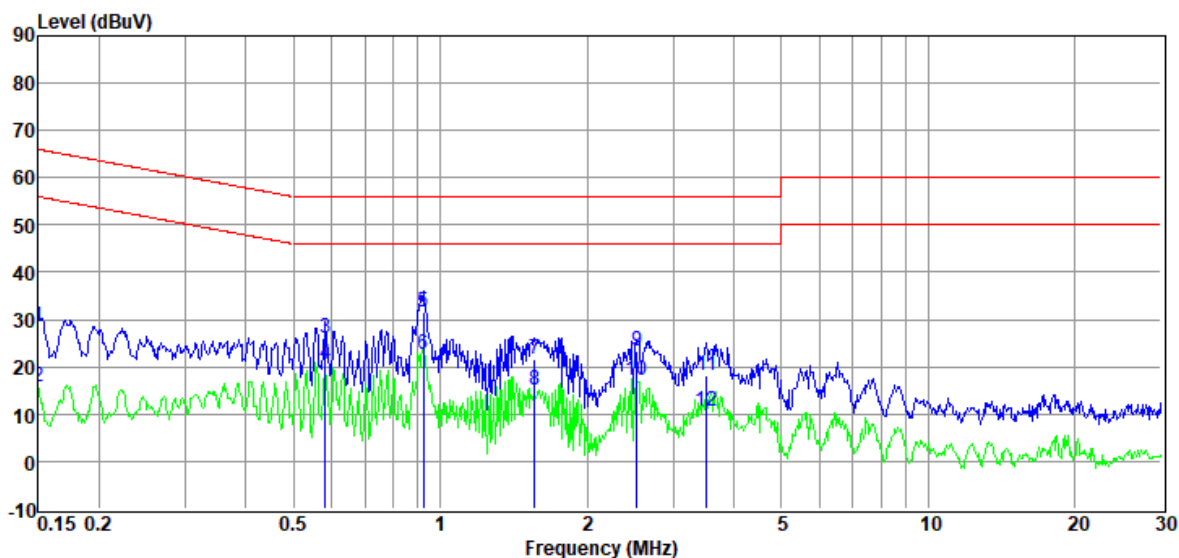

Item	Freq.	Read Level	LISN Factor	Cable Loss	Pulse Limiter Factor	Result Level	Limit Line	Over Limit	Detector	Phase
(Mark)	(MHz)	(dBuV)	(dB)	(dB)	(dB)	(dBuV)	(dBuV)	(dB)		
1	0.15	7.93	9.83	0.92	9.68	28.36	66.00	-37.64	QP	NEUTRAL
2	0.15	-4.54	9.83	0.92	9.68	15.89	56.00	-40.11	Average	NEUTRAL
3	0.58	5.67	9.82	0.83	9.72	26.04	56.00	-29.96	QP	NEUTRAL
4	0.58	0.18	9.82	0.83	9.72	20.55	46.00	-25.45	Average	NEUTRAL
5	0.92	11.35	9.80	0.69	9.73	31.57	56.00	-24.43	QP	NEUTRAL
6	0.92	2.46	9.80	0.69	9.73	22.68	46.00	-23.32	Average	NEUTRAL
7	1.56	1.55	9.75	0.65	9.75	21.70	56.00	-34.30	QP	NEUTRAL
8	1.56	-5.17	9.75	0.65	9.75	14.98	46.00	-31.02	Average	NEUTRAL
9	2.53	3.09	9.72	0.61	9.77	23.19	56.00	-32.81	QP	NEUTRAL
10	2.53	-2.90	9.72	0.61	9.77	17.20	46.00	-28.80	Average	NEUTRAL
11	3.51	-1.91	9.73	0.57	9.78	18.17	56.00	-37.83	QP	NEUTRAL
12	3.51	-9.58	9.73	0.57	9.78	10.50	46.00	-35.50	Average	NEUTRAL

Note:

1. Result Level = Read Level +LISN Factor + Pulse Limiter Factor + Cable loss.
2. If QP Result complies with AV limit, AV Result is deemed to comply with AV limit.
3. Test setup: RBW: 200 Hz (9 kHz—150 kHz), 9 kHz (150 kHz—30 MHz).
4. Step size: 80Hz (0.009MHz-0.15MHz), 4 kHz (0.15MHz-30MHz), Scan time: auto.

18. Photos of the EUT

Please refer to DDT-Q23122824-1E appendix I

-----End Report-----