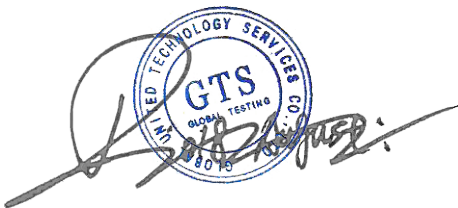

### FCC Report (Bluetooth)

**Applicant:** PEAG LLC (DBA. JLAB AUDIO)  
**Address of Applicant:** 2281 Las Palmas Drive, Suite 101, Carlsbad, CA 92011  
**Manufacturer/Factory:** Dongguan Siyoto Electronics Co., Ltd.  
**Address of Manufacturer/Factory:** Hecheng Industrial District, Dongjiang, Qiaotou Town, Dongguan City, Guangdong, China  
**Equipment Under Test (EUT)**  
Product Name: Flex Sport Headphone  
Model No.: Flex Sport  
**FCC ID:** 2AHYV-FLEXSPORT  
**Applicable standards:** FCC CFR Title 47 Part 15 Subpart C Section 15.247  
**Date of sample receipt:** July 31, 2018  
**Date of Test:** July 31, 2018 –August 09, 2018  
**Date of report issued:** August 09, 2018  
**Test Result :** PASS \*

\* In the configuration tested, the EUT complied with the standards specified above.

Authorized Signature:

A circular logo for GTS Global Testing Co., Ltd. is overlaid with a handwritten signature in black ink. The logo contains the text 'GTS GLOBAL TESTING CO., LTD.' and 'UNIFIED TECHNOLOGY SERVICES CO., LTD.' around the perimeter.

**Robinson Lo**  
**Laboratory Manager**

This results shown in this test report refer only to the sample(s) tested, this test report cannot be reproduced, except in full, without prior written permission of the company. The report would be invalid without specific stamp of test institute and the signatures of compiler and approver.

## 2 Version

Version No.	Date	Description
00	August 09, 2018	Original

**Prepared By:**

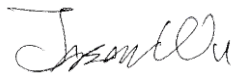

**Date:**

August 09, 2018

**Project Engineer**

**Check By:**

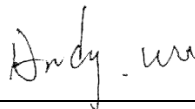

**Date:**

August 09, 2018

**Reviewer**

## 3 Contents

Page

<b>1</b>	<b>COVER PAGE</b> .....	<b>1</b>
<b>2</b>	<b>VERSION</b> .....	<b>2</b>
<b>3</b>	<b>CONTENTS</b> .....	<b>3</b>
<b>4</b>	<b>TEST SUMMARY</b> .....	<b>4</b>
<b>5</b>	<b>GENERAL INFORMATION</b> .....	<b>5</b>
5.1	GENERAL DESCRIPTION OF EUT .....	5
5.2	TEST MODE .....	7
5.3	TEST FACILITY .....	7
5.4	TEST LOCATION .....	7
5.5	OTHER INFORMATION REQUESTED BY THE CUSTOMER .....	7
5.6	DESCRIPTION OF SUPPORT UNITS .....	7
5.7	ADDITIONAL INSTRUCTIONS .....	8
<b>6</b>	<b>TEST INSTRUMENTS LIST</b> .....	<b>9</b>
<b>7</b>	<b>TEST RESULTS AND MEASUREMENT DATA</b> .....	<b>11</b>
7.1	ANTENNA REQUIREMENT .....	11
7.2	CONDUCTED EMISSIONS .....	12
7.3	CONDUCTED PEAK OUTPUT POWER .....	15
7.4	20dB EMISSION BANDWIDTH .....	19
7.5	CARRIER FREQUENCIES SEPARATION .....	23
7.6	HOPPING CHANNEL NUMBER .....	27
7.7	DWELL TIME .....	28
7.8	PSEUDORANDOM FREQUENCY HOPPING SEQUENCE .....	30
7.9	BAND EDGE .....	31
7.9.1	<i>Conducted Emission Method</i> .....	31
7.9.2	<i>Radiated Emission Method</i> .....	35
7.10	SPURIOUS EMISSION .....	37
7.10.1	<i>Conducted Emission Method</i> .....	37
7.10.2	<i>Radiated Emission Method</i> .....	39
<b>8</b>	<b>TEST SETUP PHOTO</b> .....	<b>47</b>
<b>9</b>	<b>EUT CONSTRUCTIONAL DETAILS</b> .....	<b>49</b>

## 4 Test Summary

Test Item	Section in CFR 47	Result
Antenna Requirement	15.203/15.247 (c)	Pass
AC Power Line Conducted Emission	15.207	Pass
Conducted Peak Output Power	15.247 (b)(1)	Pass
20dB Occupied Bandwidth	15.247 (a)(1)	Pass
Carrier Frequencies Separation	15.247 (a)(1)	Pass
Hopping Channel Number	15.247 (a)(1)	Pass
Dwell Time	15.247 (a)(1)	Pass
Pseudorandom Frequency Hopping Sequence	15.247(b)(4)	Pass
Radiated Emission	15.205/15.209	Pass
Band Edge	15.247(d)	Pass

*Pass: The EUT complies with the essential requirements in the standard.*

*Remark: Test according ANSI C63.10:2013*

### Measurement Uncertainty

Test Item	Frequency Range	Measurement Uncertainty	Notes
Radiated Emission	9kHz ~ 30MHz	± 4.34dB	(1)
Radiated Emission	30MHz ~ 1000MHz	± 4.24dB	(1)
Radiated Emission	1GHz ~ 26.5GHz	± 4.68dB	(1)
AC Power Line Conducted Emission	0.15MHz ~ 30MHz	± 3.45dB	(1)

Note (1): The measurement uncertainty is for coverage factor of k=2 and a level of confidence of 95%.

## 5 General Information

### 5.1 General Description of EUT

Product Name:	Flex Sport Headphone
Model No.:	Flex Sport
Serial No.:	xxx
Test sample(s) ID:	GTS201808000077-1
Sample(s) Status	Engineer sample
Hardware:	SMBT-40115-1D
Software:	V1.12
Operation Frequency:	2402MHz-2480MHz
Channel numbers:	79
Channel separation:	1MHz
Modulation type:	GFSK, $\pi/4$ -DQPSK, 8DPSK
Antenna Type:	PCB Antenna
Antenna gain:	2dBi
Power supply:	DC 3.7V

Operation Frequency each of channel							
Channel	Frequency	Channel	Frequency	Channel	Frequency	Channel	Frequency
1	2402MHz	21	2422MHz	41	2442MHz	61	2462MHz
2	2403MHz	22	2423MHz	42	2443MHz	62	2463MHz
3	2404MHz	23	2424MHz	43	2444MHz	63	2464MHz
4	2405MHz	24	2425MHz	44	2445MHz	64	2465MHz
5	2406MHz	25	2426MHz	45	2446MHz	65	2466MHz
6	2407MHz	26	2427MHz	46	2447MHz	66	2467MHz
7	2408MHz	27	2428MHz	47	2448MHz	67	2468MHz
8	2409MHz	28	2429MHz	48	2449MHz	68	2469MHz
9	2410MHz	29	2430MHz	49	2450MHz	69	2470MHz
10	2411MHz	30	2431MHz	50	2451MHz	70	2471MHz
11	2412MHz	31	2432MHz	51	2452MHz	71	2472MHz
12	2413MHz	32	2433MHz	52	2453MHz	72	2473MHz
13	2414MHz	33	2434MHz	53	2454MHz	73	2474MHz
14	2415MHz	34	2435MHz	54	2455MHz	74	2475MHz
15	2416MHz	35	2436MHz	55	2456MHz	75	2476MHz
16	2417MHz	36	2437MHz	56	2457MHz	76	2477MHz
17	2418MHz	37	2438MHz	57	2458MHz	77	2478MHz
18	2419MHz	38	2439MHz	58	2459MHz	78	2479MHz
19	2420MHz	39	2440MHz	59	2460MHz	79	2480MHz
20	2421MHz	40	2441MHz	60	2461MHz		

**Note:**

In section 15.31(m), regards to the operating frequency range over 10 MHz, the Lowest frequency, the middle frequency, and the highest frequency of channel were selected to perform the test, and the selected channel see below:

Channel	Frequency
The lowest channel	2402MHz
The middle channel	2441MHz
The Highest channel	2480MHz

## 5.2 Test mode

Transmitting mode	Keep the EUT in continuously transmitting mode.
<i>Remark: During the test, the test voltage was tuned from 85% to 115% of the nominal rated supply voltage, and found that the worst case was under the nominal rated supply condition. So the report just shows that condition's data.</i>	

## 5.3 Test Facility

<p>The test facility is recognized, certified, or accredited by the following organizations:</p> <ul style="list-style-type: none"> <li>● <b>FCC —Registration No.: 381383</b> Global United Technology Services Co., Ltd., Shenzhen EMC Laboratory has been registered and fully described in a report filed with the (FCC) Federal Communications Commission. The acceptance letter from the FCC is maintained in files. Registration 381383, January 08, 2018.</li> <li>● <b>Industry Canada (IC) —Registration No.: 9079A-2</b> The 3m Semi-anechoic chamber of Global United Technology Services Co., Ltd. has been registered by Certification and Engineering Bureau of Industry Canada for radio equipment testing with Registration No.: 9079A-2, August 15, 2016.</li> </ul>
--

## 5.4 Test Location

All tests were performed at:
<p>Global United Technology Services Co., Ltd. Address: No. 301-309, 3/F., Jinyuan Business Building, No.2, Laodong Industrial Zone, Xixiang Road, Baoan District, Shenzhen, Guangdong, China 518102 Tel: 0755-27798480 Fax: 0755-27798960</p>

## 5.5 Other Information Requested by the Customer

None.
-------

## 5.6 Description of Support Units

Manufacturer	Description	Model	Serial Number
SAMSUNG	Adapter	ETAOU80EBE	N/A
Lenovo	Notebook computer	E470C	PF-10FB5C

## 5.7 Additional Instructions

### EUT Software Settings:

Mode	<p>Special software is used.</p> <p>The software provided by client to enable the EUT under transmission condition continuously at specific channel frequencies individually.</p>
------	---

Power level setup in software			
Test Software Name	Airoha AB152x LAB Test tool		
Mode	Channel	Frequency (MHz)	Soft Set
GFSK, $\pi/4$ -DQPSK, 8DPSK	CH01	2402	TX level : default
	CH40	2442	
	CH79	2480	

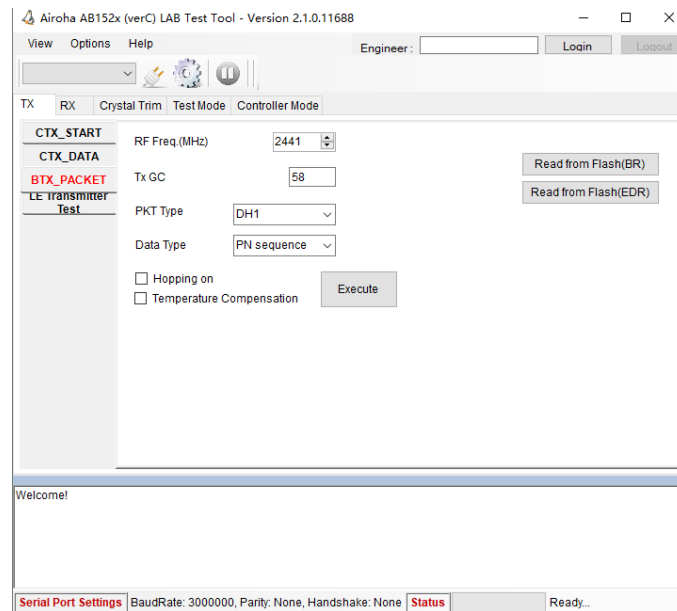



## 6 Test Instruments list

Radiated Emission:						
Item	Test Equipment	Manufacturer	Model No.	Inventory No.	Cal.Date (mm-dd-yy)	Cal.Due date (mm-dd-yy)
1	3m Semi- Anechoic Chamber	ZhongYu Electron	9.2(L)*6.2(W)* 6.4(H)	GTS250	July. 03 2015	July. 02 2020
2	Control Room	ZhongYu Electron	6.2(L)*2.5(W)* 2.4(H)	GTS251	N/A	N/A
3	EMI Test Receiver	Rohde & Schwarz	ESU26	GTS203	June. 27 2018	June. 26 2019
4	BiConiLog Antenna	SCHWARZBECK MESS-ELEKTRONIK	VULB9163	GTS214	June. 27 2018	June. 26 2019
5	Double -ridged waveguide horn	SCHWARZBECK MESS-ELEKTRONIK	BBHA 9120 D	GTS208	June. 27 2018	June. 26 2019
6	Horn Antenna	ETS-LINDGREN	3160	GTS217	June. 27 2018	June. 26 2019
7	EMI Test Software	AUDIX	E3	N/A	N/A	N/A
8	Coaxial Cable	GTS	N/A	GTS213	June. 27 2018	June. 26 2019
9	Coaxial Cable	GTS	N/A	GTS211	June. 27 2018	June. 26 2019
10	Coaxial cable	GTS	N/A	GTS210	June. 27 2018	June. 26 2019
11	Coaxial Cable	GTS	N/A	GTS212	June. 27 2018	June. 26 2019
12	Amplifier(100kHz-3GHz)	HP	8347A	GTS204	June. 27 2018	June. 26 2019
13	Amplifier(2GHz-20GHz)	HP	84722A	GTS206	June. 27 2018	June. 26 2019
14	Amplifier (18-26GHz)	Rohde & Schwarz	AFS33-18002 650-30-8P-44	GTS218	June. 27 2018	June. 26 2019
15	Band filter	Amindeon	82346	GTS219	June. 27 2018	June. 26 2019
16	Power Meter	Anritsu	ML2495A	GTS540	June. 27 2018	June. 26 2019
17	Power Sensor	Anritsu	MA2411B	GTS541	June. 27 2018	June. 26 2019
18	Wideband Radio Communication Tester	Rohde & Schwarz	CMW500	GTS575	June. 27 2018	June. 26 2019
19	Splitter	Agilent	11636B	GTS237	June. 27 2018	June. 26 2019
20	Loop Antenna	ZHINAN	ZN30900A	GTS534	June. 27 2018	June. 26 2019

General used equipment:						
Item	Test Equipment	Manufacturer	Model No.	Inventory No.	Cal.Date (mm-dd-yy)	Cal.Due date (mm-dd-yy)
1	Humidity/ Temperature Indicator	KTJ	TA328	GTS243	June. 27 2018	June. 26 2019
2	Barometer	ChangChun	DYM3	GTS255	June. 27 2018	June. 26 2019

RF Conducted Test:						
Item	Test Equipment	Manufacturer	Model No.	Serial No.	Cal.Date (mm-dd-yy)	Cal.Due date (mm-dd-yy)
1	MXA Signal Analyzer	Agilent	N9020A	GTS566	June. 27 2018	June. 26 2019
2	EMI Test Receiver	R&S	ESCI 7	GTS552	June. 27 2018	June. 26 2019
3	Spectrum Analyzer	Agilent	E4440A	GTS533	June. 27 2018	June. 26 2019
4	MXG vector Signal Generator	Agilent	N5182A	GTS567	June. 27 2018	June. 26 2019
5	ESG Analog Signal Generator	Agilent	E4428C	GTS568	June. 27 2018	June. 26 2019
6	USB RF Power Sensor	DARE	RPR3006W	GTS569	June. 27 2018	June. 26 2019
7	RF Switch Box	Shongyi	RFSW3003328	GTS571	June. 27 2018	June. 26 2019
8	EMI Test Receiver	R&S	ESCI 7	GTS552	June. 27 2018	June. 26 2019
9	Programmable Constant Temp & Humi Test Chamber	WEWON	WHTH-150L-40-880	GTS572	June. 27 2018	June. 26 2019

Conducted Emission						
Item	Test Equipment	Manufacturer	Model No.	Inventory No.	Cal.Date (mm-dd-yy)	Cal.Due date (mm-dd-yy)
1	Shielding Room	ZhongYu Electron	7.3(L)x3.1(W)x2.9(H)	GTS252	May.16 2014	May.15 2019
2	EMI Test Receiver	R&S	ESCI 7	GTS552	June. 27 2018	June. 26 2019
3	Coaxial Switch	ANRITSU CORP	MP59B	GTS225	June. 27 2018	June. 26 2019
4	Artificial Mains Network	SCHWARZBECK MESS	NSLK8127	GTS226	June. 27 2018	June. 26 2019
5	Coaxial Cable	GTS	N/A	GTS227	N/A	N/A
6	EMI Test Software	AUDIX	E3	N/A	N/A	N/A
7	Thermo meter	KTJ	TA328	GTS233	June. 27 2018	June. 26 2019
8	Absorbing clamp	Elektronik-Feinmechanik	MDS21	GTS229	June. 27 2018	June. 26 2019

## 7 Test results and Measurement Data

### 7.1 Antenna requirement

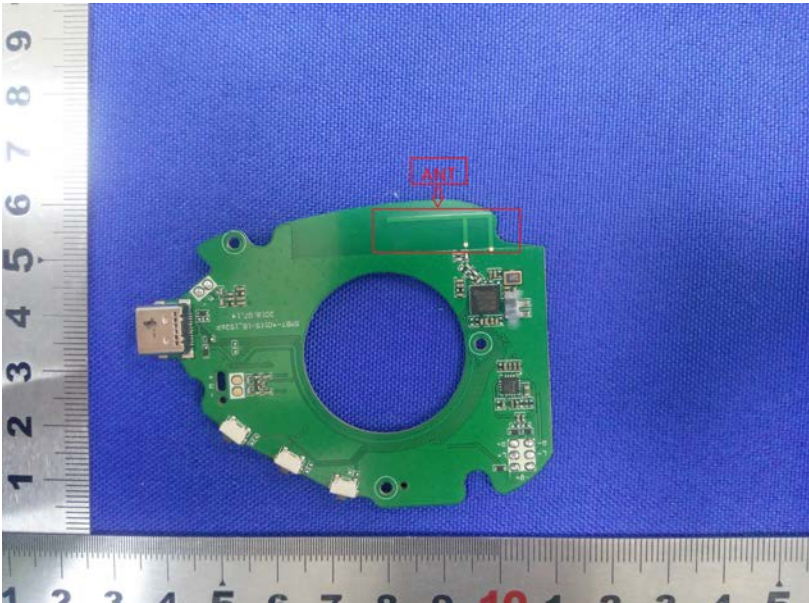
<b>Standard requirement:</b>	FCC Part15 C Section 15.203 /247(c)
<p><b>15.203 requirement:</b>            An intentional radiator shall be designed to ensure that no antenna other than that furnished by the responsible party shall be used with the device. The use of a permanently attached antenna or of an antenna that uses a unique coupling to the intentional radiator, the manufacturer may design the unit so that a broken antenna can be replaced by the user, but the use of a standard antenna jack or electrical connector is prohibited.</p> <p><b>15.247(c) (1)(i) requirement:</b>            (i) Systems operating in the 2400-2483.5 MHz band that is used exclusively for fixed. Point-to-point operations may employ transmitting antennas with directional gain greater than 6dBi provided the maximum conducted output power of the intentional radiator is reduced by 1 dB for every 3 dB that the directional gain of the antenna exceeds 6dBi.</p>	
<b>E.U.T Antenna:</b>	
<p><i>The antenna is PCB antenna, the best case gain of the antenna is 2.0dBi</i></p> 	

## 7.2 Conducted Emissions

Test Requirement:	FCC Part15 C Section 15.207														
Test Method:	ANSI C63.10:2013														
Test Frequency Range:	150KHz to 30MHz														
Class / Severity:	Class B														
Receiver setup:	RBW=9KHz, VBW=30KHz, Sweep time=auto														
Limit:	<table border="1"> <thead> <tr> <th rowspan="2">Frequency range (MHz)</th> <th colspan="2">Limit (dBuV)</th> </tr> <tr> <th>Quasi-peak</th> <th>Average</th> </tr> </thead> <tbody> <tr> <td>0.15-0.5</td> <td>66 to 56*</td> <td>56 to 46*</td> </tr> <tr> <td>0.5-5</td> <td>56</td> <td>46</td> </tr> <tr> <td>5-30</td> <td>60</td> <td>50</td> </tr> </tbody> </table> <p>* Decreases with the logarithm of the frequency.</p>	Frequency range (MHz)	Limit (dBuV)		Quasi-peak	Average	0.15-0.5	66 to 56*	56 to 46*	0.5-5	56	46	5-30	60	50
Frequency range (MHz)	Limit (dBuV)														
	Quasi-peak	Average													
0.15-0.5	66 to 56*	56 to 46*													
0.5-5	56	46													
5-30	60	50													
Test setup:	<p><i>Remark</i>  E.U.T: Equipment Under Test  LISN: Line Impedance Stabilization Network  Test table height=0.8m</p>														
Test procedure:	<ol style="list-style-type: none"> <li>1. The E.U.T and simulators are connected to the main power through a line impedance stabilization network (L.I.S.N.). This provides a 50ohm/50uH coupling impedance for the measuring equipment.</li> <li>2. The peripheral devices are also connected to the main power through a LISN that provides a 50ohm/50uH coupling impedance with 50ohm termination. (Please refer to the block diagram of the test setup and photographs).</li> <li>3. Both sides of A.C. line are checked for maximum conducted interference. In order to find the maximum emission, the relative positions of equipment and all of the interface cables must be changed according to ANSI C63.10:2013 on conducted measurement.</li> </ol>														
Test Instruments:	Refer to section 6.0 for details														
Test mode:	Refer to section 5.2 for details														
Test results:	Pass														

### Measurement data:

<b>EUT:</b>	<b>Flex Sport Headphone</b>	<b>Probe:</b>	<b>Line</b>
<b>Model:</b>	<b>Flex Sport</b>	<b>Power Source:</b>	<b>AC120V/60Hz</b>
<b>Mode:</b>	<b>BT mode</b>	<b>Temp./Hum.(%H):</b>	<b>26°C/60%RH</b>

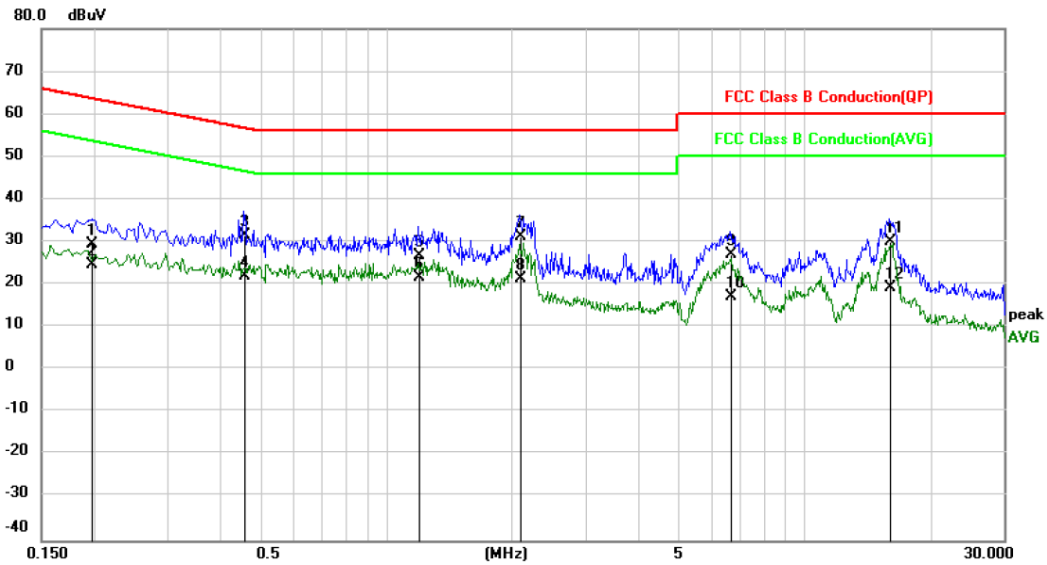

No.	Mk.	Freq.	Reading Level	Correct Factor	Measurement	Limit	Over	Detector
		MHz	dBuV	dB	dBuV	dBuV	dB	
1		0.1980	19.59	9.95	29.54	63.69	-34.15	QP
2		0.1980	14.78	9.95	24.73	53.69	-28.96	AVG
3		0.4580	21.44	10.04	31.48	56.73	-25.25	QP
4		0.4580	11.82	10.04	21.86	46.73	-24.87	AVG
5		1.1940	17.05	9.84	26.89	56.00	-29.11	QP
6	*	1.1940	11.82	9.84	21.66	46.00	-24.34	AVG
7		2.0940	21.42	9.82	31.24	56.00	-24.76	QP
8		2.0940	11.47	9.82	21.29	46.00	-24.71	AVG
9		6.6580	17.38	9.75	27.13	60.00	-32.87	QP
10		6.6580	7.33	9.75	17.08	50.00	-32.92	AVG
11		16.0140	20.15	9.82	29.97	60.00	-30.03	QP
12		16.0140	9.29	9.82	19.11	50.00	-30.89	AVG

<b>EUT:</b>	<b>Flex Sport Headphone</b>	<b>Probe:</b>	<b>Neutral</b>
<b>Model:</b>	<b>Flex Sport</b>	<b>Power Source:</b>	<b>AC120V/60Hz</b>
<b>Mode:</b>	<b>BT mode</b>	<b>Temp./Hum.(%RH):</b>	<b>26°C/60%RH</b>

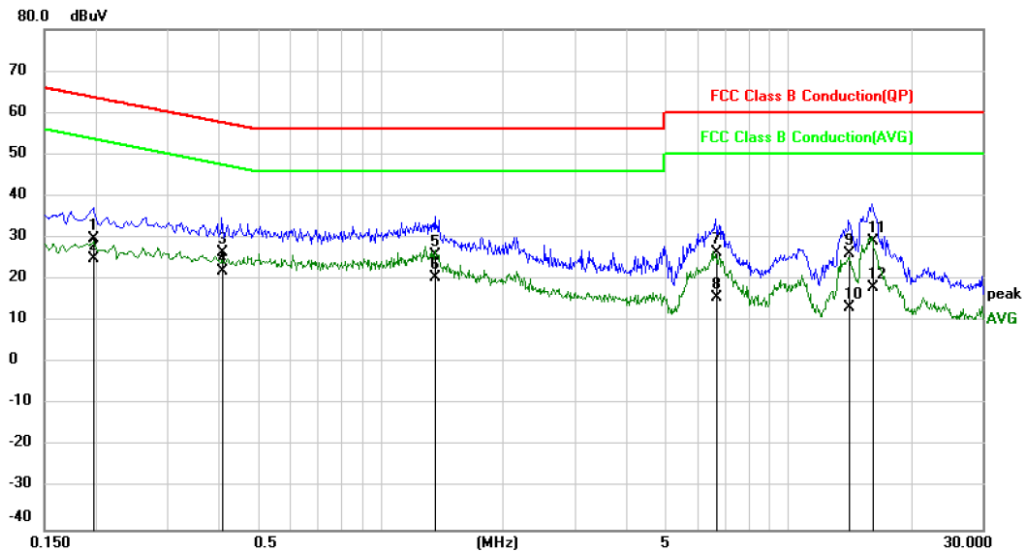

No.	Mk.	Freq.	Reading Level	Correct Factor	Measurement	Limit	Over	Detector
		MHz	dBuV	dB	dBuV	dBuV	dB	
1		0.1980	19.90	9.98	29.88	63.69	-33.81	QP
2		0.1980	15.00	9.98	24.98	53.69	-28.71	AVG
3		0.4100	16.38	10.14	26.52	57.65	-31.13	QP
4		0.4100	11.67	10.14	21.81	47.65	-25.84	AVG
5		1.3619	15.85	10.01	25.86	56.00	-30.14	QP
6	*	1.3619	10.35	10.01	20.36	46.00	-25.64	AVG
7		6.6460	16.49	9.95	26.44	60.00	-33.56	QP
8		6.6460	5.61	9.95	15.56	50.00	-34.44	AVG
9		14.0980	16.14	9.99	26.13	60.00	-33.87	QP
10		14.0980	3.32	9.99	13.31	50.00	-36.69	AVG
11		16.1100	19.26	10.01	29.27	60.00	-30.73	QP
12		16.1100	7.90	10.01	17.91	50.00	-32.09	AVG

**Notes:**

1. An initial pre-scan was performed on the line and neutral lines with peak detector.
2. Quasi-Peak and Average measurement were performed at the frequencies with maximized peak emission.
3. Final Level = Receiver Read level + Correct Factor
4. Correct Factor = LISN Factor + Cable Loss

### 7.3 Conducted Peak Output Power

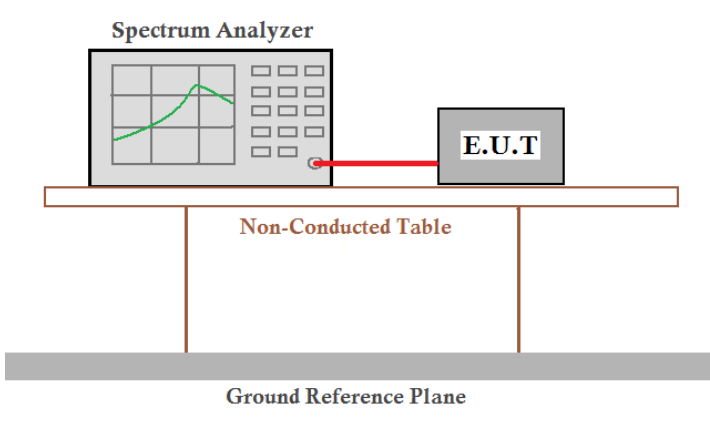
Test Requirement:	FCC Part15 C Section 15.247 (b)(3)
Test Method:	ANSI C63.10:2013
Limit:	30dBm(for GFSK),20.97dBm(for EDR)
Test setup:	 <p>The diagram shows a Spectrum Analyzer on the left and an E.U.T. on the right, connected by a red cable. They are both on a table labeled 'Non-Conducted Table'. Below the table is a 'Ground Reference Plane'.</p>
Test Instruments:	Refer to section 6.0 for details
Test mode:	Refer to section 5.2 for details
Test results:	Pass

#### Measurement Data

Mode	Test channel	Peak Output Power (dBm)	Limit (dBm)	Result
GFSK	Lowest	3.44	30.00	Pass
	Middle	3.69		
	Highest	4.63		
Pi/4QPSK	Lowest	3.08	20.97	Pass
	Middle	3.36		
	Highest	4.21		
8DPSK	Lowest	3.24	20.97	Pass
	Middle	3.51		
	Highest	4.37		

Test plot as follows:

Test mode:	GFSK mode
------------	-----------

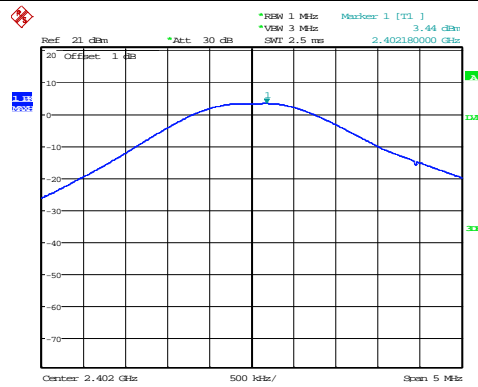

Date: 6.AUG.2018 09:51:15

### Lowest channel

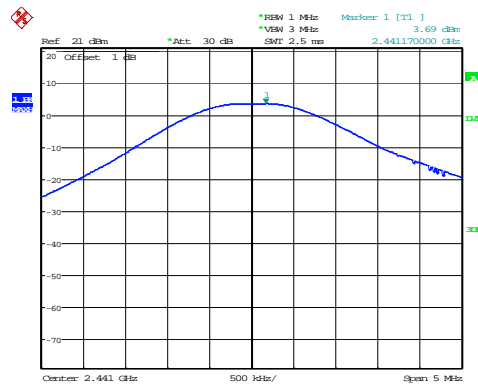

Date: 6.AUG.2018 09:51:45

### Middle channel

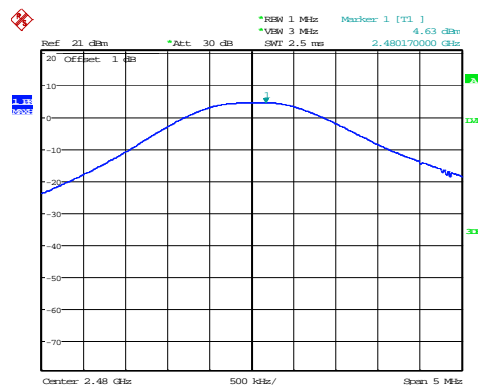

Date: 6.AUG.2018 09:52:11

### Highest channel



Test mode: Pi/4QPSK mode

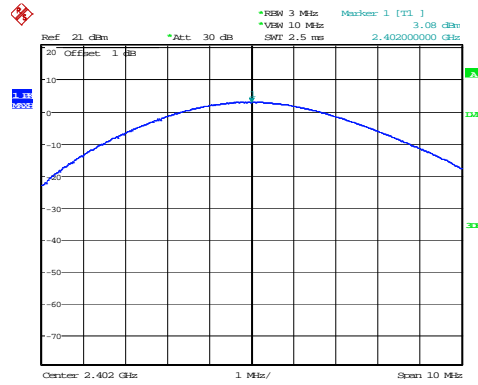

Date: 6.AUG.2018 09:54:04

### Lowest channel

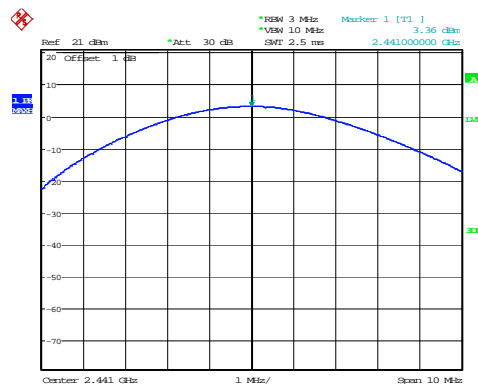

Date: 6.AUG.2018 09:53:30

### Middle channel

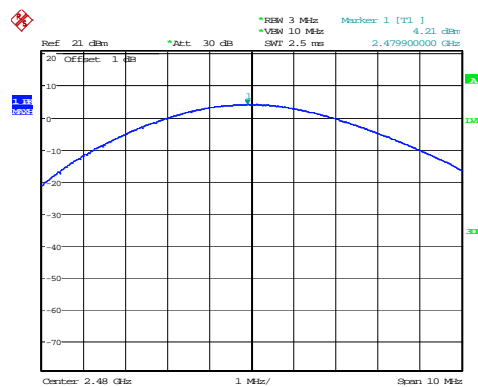

Date: 6.AUG.2018 09:52:53

### Highest channel

Test mode: **8DPSK mode**

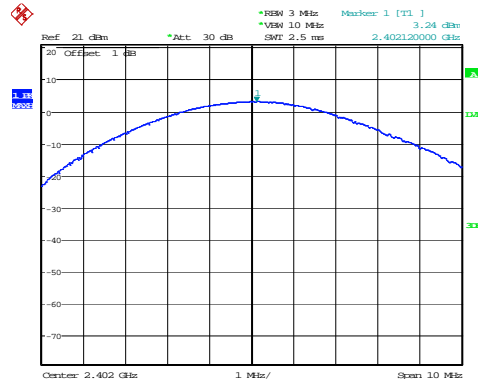

Date: 6.AUG.2018 09:54:29

### Lowest channel

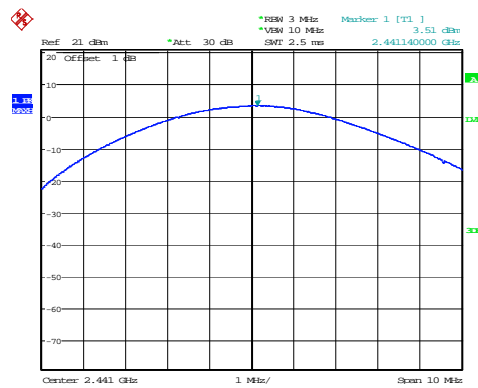

Date: 6.AUG.2018 09:55:15

### Middle channel

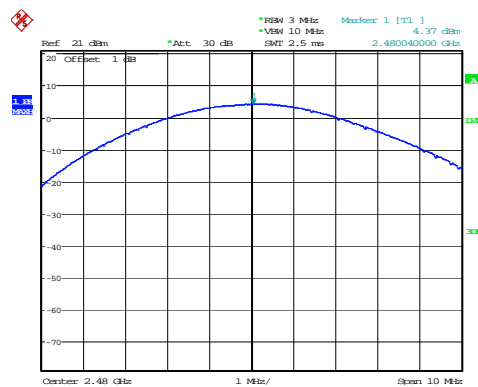

Date: 6.AUG.2018 09:55:50

### Highest channel

## 7.4 20dB Emission Bandwidth

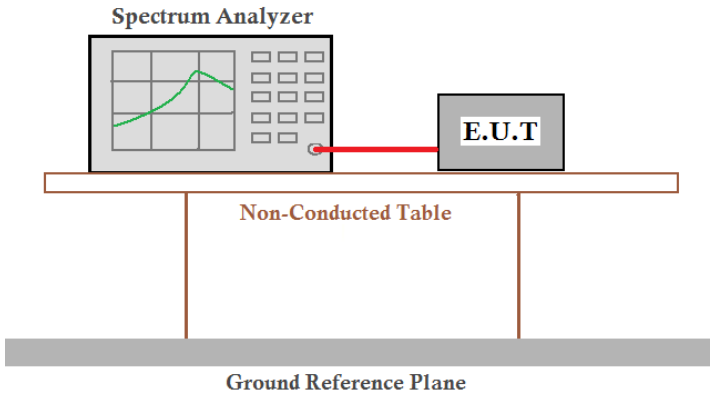
Test Requirement:	FCC Part15 C Section 15.247 (a)(2)
Test Method:	ANSI C63.10:2013
Limit:	N/A
Test setup:	 <p>The diagram illustrates the test setup. A Spectrum Analyzer is connected to an E.U.T. (Equipment Under Test) via a red cable. Both are placed on a Non-Conducted Table, which is supported by a Ground Reference Plane.</p>
Test Instruments:	Refer to section 6.0 for details
Test mode:	Refer to section 5.2 for details
Test results:	Pass

### Measurement Data

Mode	Test channel	20dB Emission Bandwidth (MHz)	Result
GFSK	Lowest	0.864	Pass
	Middle	0.868	
	Highest	0.868	
Pi/4QPSK	Lowest	1.242	Pass
	Middle	1.242	
	Highest	1.248	
8DPSK	Lowest	1.224	Pass
	Middle	1.224	
	Highest	1.224	

Test plot as follows:

Test mode:	GFSK mode
------------	-----------

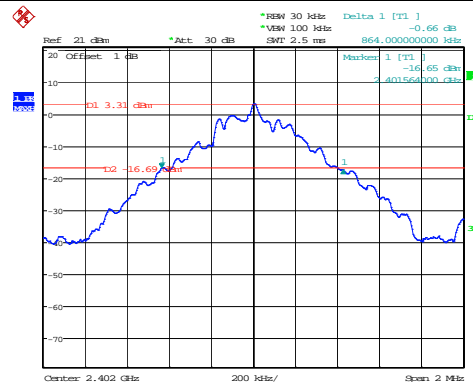

Date: 6.AUG.2018 10:09:39

### Lowest channel

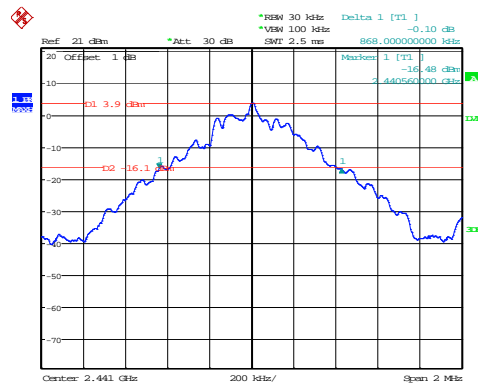

Date: 6.AUG.2018 10:07:36

### Middle channel

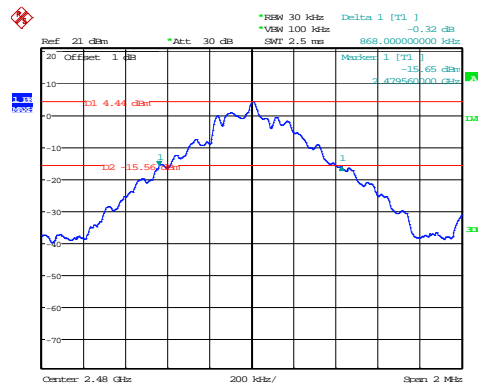

Date: 6.AUG.2018 10:05:40

### Highest channel

Test mode: Pi/4QPSK mode

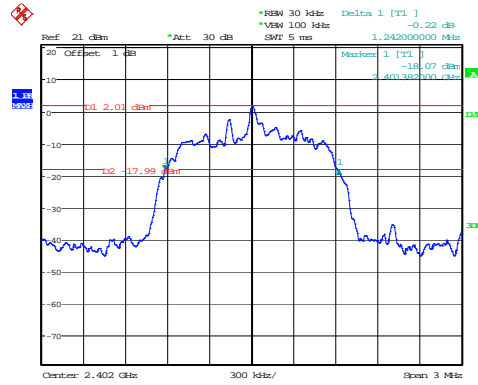

Date: 6.AUG.2018 10:01:54

### Lowest channel

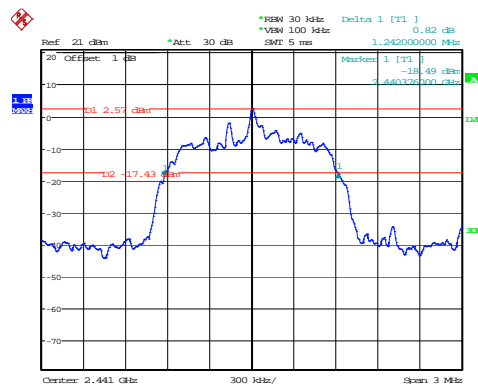

Date: 6.AUG.2018 10:03:03

### Middle channel

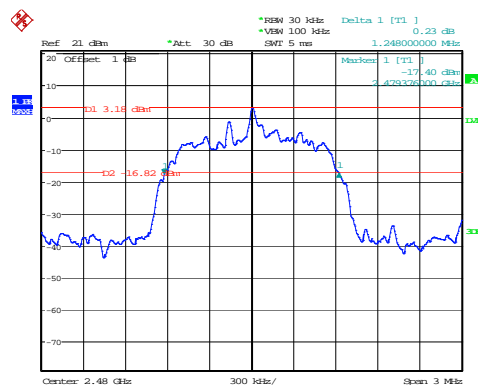

Date: 6.AUG.2018 10:04:12

### Highest channel

Test mode: **8DPSK mode**

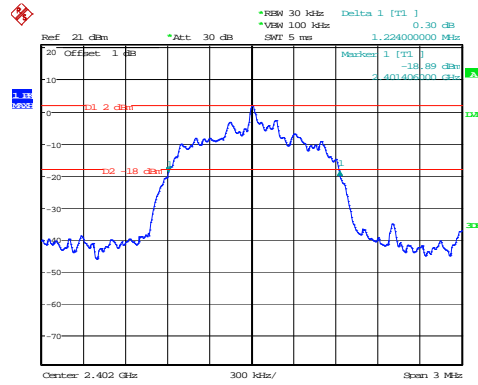

Date: 6.AUG.2018 10:01:02

### Lowest channel

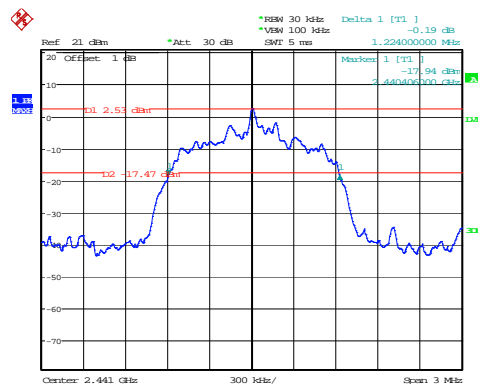

Date: 6.AUG.2018 10:00:00

### Middle channel

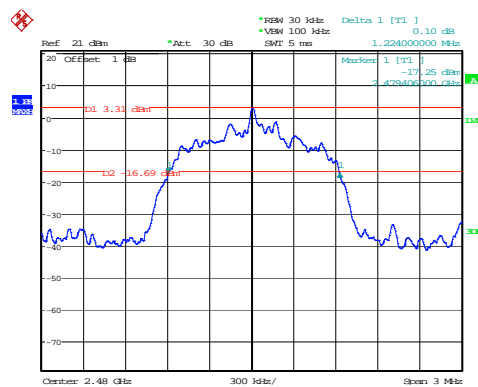

Date: 6.AUG.2018 09:58:39

### Highest channel

## 7.5 Carrier Frequencies Separation

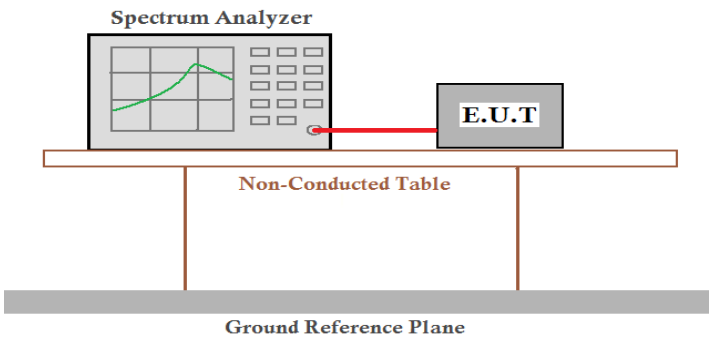
Test Requirement:	FCC Part15 C Section 15.247 (a)(1)
Test Method:	ANSI C63.10:2013
Receiver setup:	RBW=100KHz, VBW=300KHz, detector=Peak
Limit:	0.025MHz or 2/3 of the 20dB bandwidth (whichever is greater)
Test setup:	 <p>The diagram illustrates the test setup. A Spectrum Analyzer is connected via a red cable to an E.U.T. (Equipment Under Test). Both are placed on a Non-Conducted Table. Below the table is a Ground Reference Plane.</p>
Test Instruments:	Refer to section 6.0 for details
Test mode:	Refer to section 5.2 for details
Test results:	Pass

### Measurement Data

Mode	Test channel	Carrier Frequencies Separation (kHz)	Limit (kHz)	Result
GFSK	Lowest	1004	578.67	Pass
	Middle	1004	578.67	Pass
	Highest	1004	578.67	Pass
Pi/4QPSK	Lowest	1004	832.00	Pass
	Middle	1004	832.00	Pass
	Highest	1004	832.00	Pass
8DSK	Lowest	1004	816.00	Pass
	Middle	1004	816.00	Pass
	Highest	1004	816.00	Pass

Note: According to section 7.4

Mode	20dB bandwidth (kHz) (worse case)	Limit (kHz) (Carrier Frequencies Separation)
GFSK	868	578.67
Pi/4QPSK	1248	832.00
8DSK	1.224	816.00

**Test plot as follows:**

Modulation mode:	GFSK
------------------	------

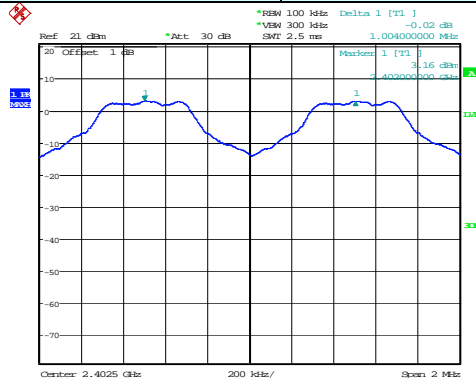

Date: 6.AUG.2018 10:24:32

**Lowest channel**

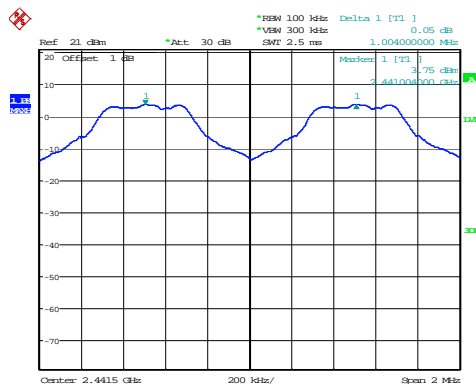

Date: 6.AUG.2018 10:22:40

**Middle channel**

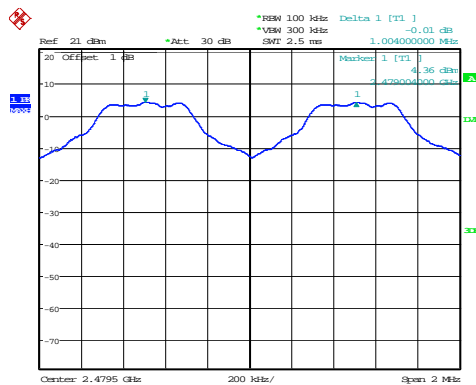

Date: 6.AUG.2018 10:21:07

**Highest channel**



Test mode: Pi/4QPSK mode

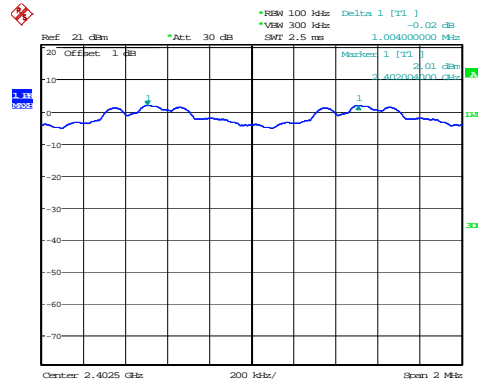

Date: 6.AUG.2018 10:26:40

### Lowest channel

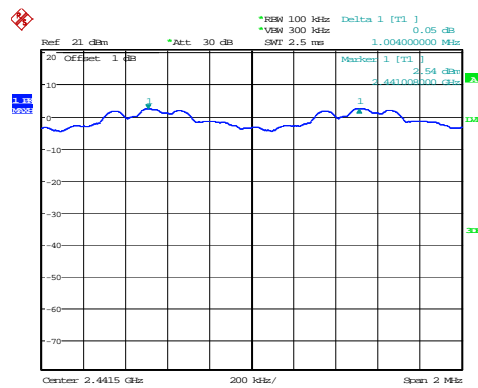

Date: 6.AUG.2018 10:28:45

### Middle channel

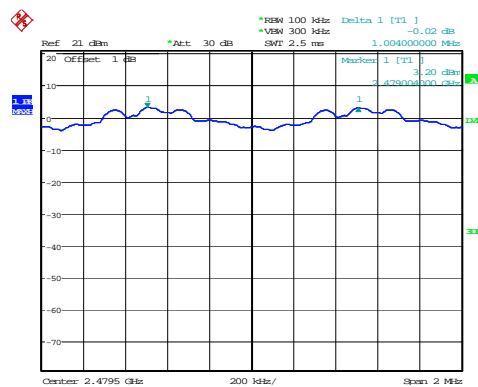

Date: 6.AUG.2018 10:31:38

### Highest channel

Test mode: 8DPSK mode

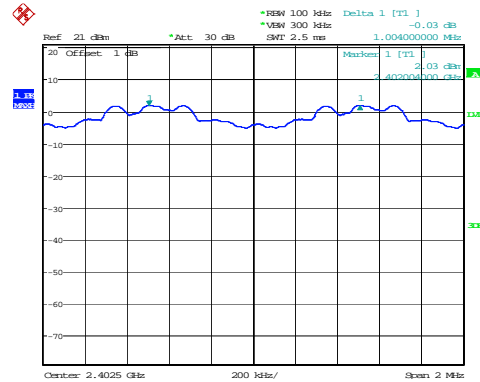

Date: 6.AUG.2018 10:38:53

### Lowest channel

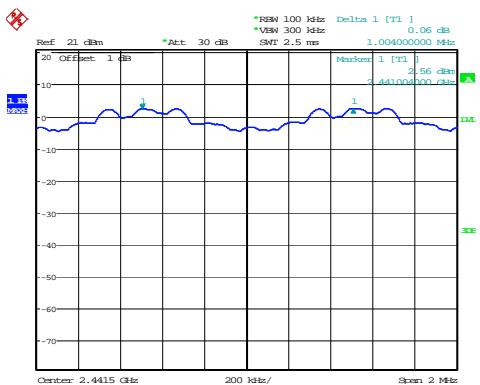

Date: 6.AUG.2018 10:37:04

### Middle channel

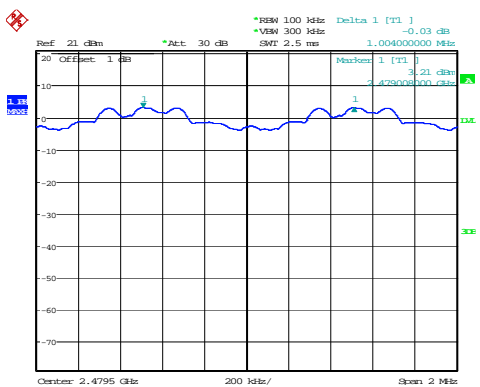

Date: 6.AUG.2018 10:34:07

### Highest channel

## 7.6 Hopping Channel Number

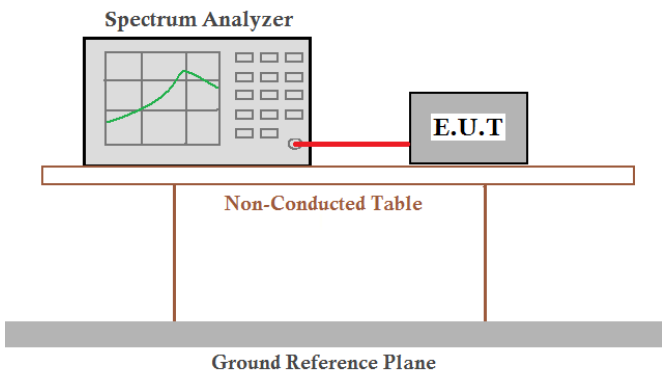
Test Requirement:	FCC Part15 C Section 15.247 (a)(1)
Test Method:	ANSI C63.10:2013
Receiver setup:	RBW=100kHz, VBW=300kHz, Frequency range=2400MHz-2483.5MHz, Detector=Peak
Limit:	15 channels
Test setup:	 <p>The diagram illustrates the test setup. A Spectrum Analyzer is connected via a red cable to an E.U.T. (Equipment Under Test). Both are placed on a Non-Conducted Table. Below the table is a Ground Reference Plane.</p>
Test Instruments:	Refer to section 6.0 for details
Test mode:	Refer to section 5.2 for details
Test results:	Pass

### Measurement Data:

Mode	Hopping channel numbers	Limit	Result
GFSK	79	15	Pass
Pi/4QPSK	79	15	Pass
8DPSK	79	15	Pass

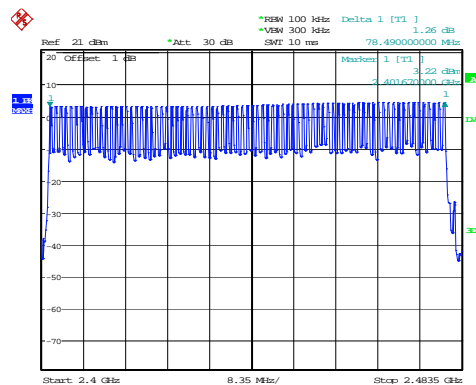

Date: 6.AUG.2018 09:49:44

## 7.7 Dwell Time

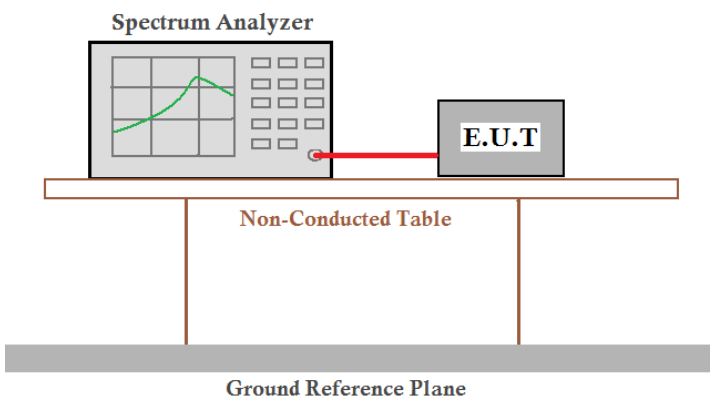
Test Requirement:	FCC Part15 C Section 15.247 (a)(1)
Test Method:	ANSI C63.10:2013
Receiver setup:	RBW=1MHz, VBW=1MHz, Span=0Hz, Detector=Peak
Limit:	0.4 Second
Test setup:	
Test Instruments:	Refer to section 6.0 for details
Test mode:	Refer to section 5.2 for details
Test results:	Pass

### Measurement Data

Frequency	Packet	Dwell time(ms)	Limit(ms)	Result
2441MHz	DH1/2-DH1/3-DH1	141.44	400	Pass
2441MHz	DH3/2-DH3/3-DH3	275.52	400	Pass
2441MHz	DH5/2-DH5/3-DH5	317.44	400	Pass

The test period:  $T = 0.4 \text{ Second/Channel} \times 79 \text{ Channel} = 31.6 \text{ s}$

Test channel: 2441MHz as blow

DH1/2-DH1/3-DH1 time slot =  $0.442(\text{ms}) \times (1600 / (2 \times 79)) \times 31.6 = 141.44\text{ms}$

DH3/2-DH3/3-DH3 time slot =  $1.722(\text{ms}) \times (1600 / (4 \times 79)) \times 31.6 = 275.52\text{ms}$

DH5/2-DH5/3-DH5 time slot =  $2.976(\text{ms}) \times (1600 / (6 \times 79)) \times 31.6 = 317.44\text{ms}$

Test plot as follows:

Test channel: 2441MHz

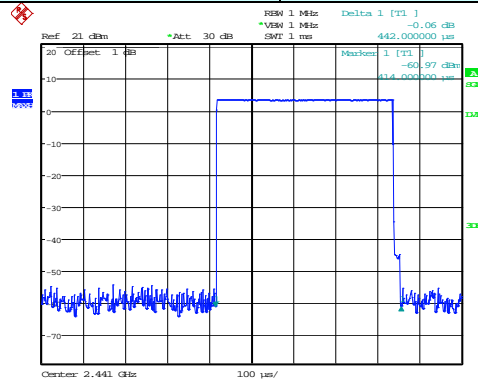

Date: 6.AUG.2018 10:11:09

### DH1/2-DH1/3-DH1

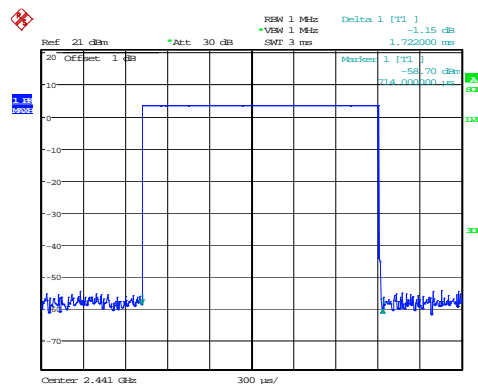

Date: 6.AUG.2018 10:11:54

### DH3/2-DH3/3-DH3

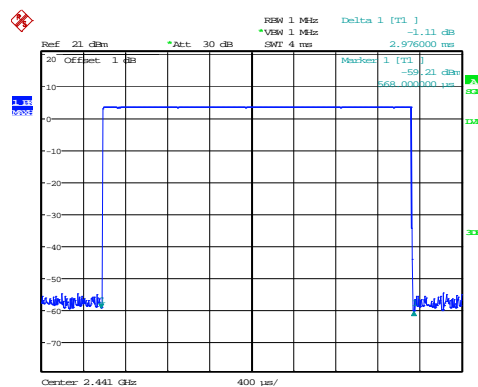

Date: 6.AUG.2018 10:12:47

### DH5/2-DH5/3-DH5

## 7.8 Pseudorandom Frequency Hopping Sequence

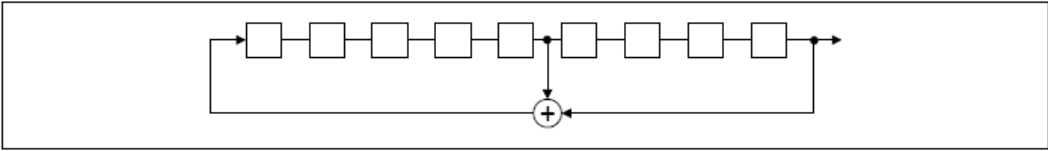
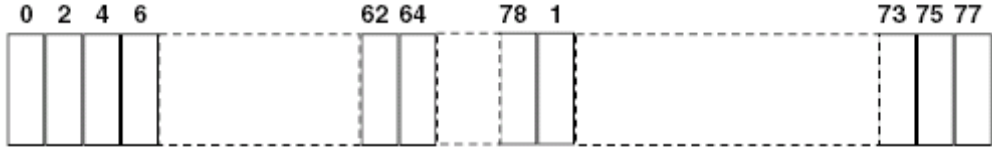
<b>Test Requirement:</b>	<b>FCC Part15 C Section 15.247 (a)(1) requirement:</b>
<p><i>Frequency hopping systems shall have hopping channel carrier frequencies separated by a minimum of 25 kHz or the 20 dB bandwidth of the hopping channel, whichever is greater.</i></p> <p><i>Alternatively. Frequency hopping systems operating in the 2400-2483.5 MHz band may have hopping channel carrier frequencies that are separated by 25 kHz or two-thirds of the 20 dB bandwidth of the hopping channel, whichever is greater, provided the systems operate with an output power no greater than 125 mW. The system shall hop to channel frequencies that are selected at the system hopping rate from a Pseudorandom ordered list of hopping frequencies. Each frequency must be used equally on the average by each transmitter. The system receivers shall have input bandwidths that match the hopping channel bandwidths of their corresponding transmitters and shall shift frequencies in synchronization with the transmitted signals.</i></p>	
<b>EUT Pseudorandom Frequency Hopping Sequence</b>	
<p><i>The pseudorandom sequence may be generated in a nine-stage shift register whose 5th and 9th stage outputs are added in a modulo-two addition stage. And the result is fed back to the input of the first stage. The sequence begins with the first ONE of 9 consecutive ONEs; i.e. the shift register is initialized with nine ones.</i></p> <ul style="list-style-type: none"> <li>• Number of shift register stages: 9</li> <li>• Length of pseudo-random sequence: <math>2^9 - 1 = 511</math> bits</li> <li>• Longest sequence of zeros: 8 (non-inverted signal)</li> </ul>	
	
<p><i>Linear Feedback Shift Register for Generation of the PRBS sequence</i></p>	
<p><i>An example of Pseudorandom Frequency Hopping Sequence as follow:</i></p>	
	
<p><i>Each frequency used equally on the average by each transmitter.</i></p> <p><i>The system receivers have input bandwidths that match the hopping channel bandwidths of their corresponding transmitters and shift frequencies in synchronization with the transmitted signals.</i></p>	

## 7.9 Band Edge

### 7.9.1 Conducted Emission Method

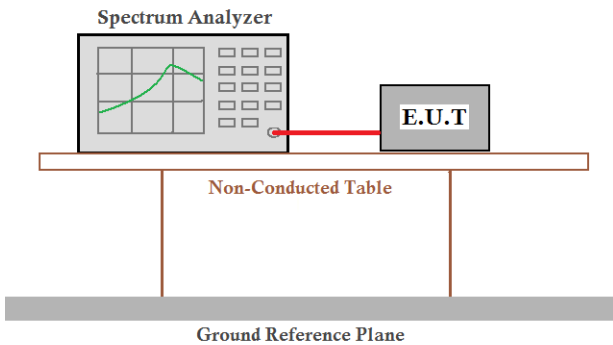
Test Requirement:	FCC Part15 C Section 15.247 (d)
Test Method:	ANSI C63.10:2013
Receiver setup:	RBW=100kHz, VBW=300kHz, Detector=Peak
Limit:	In any 100 kHz bandwidth outside the frequency band in which the spread spectrum intentional radiator is operating, the radio frequency power that is produced by the intentional radiator shall be at least 20 dB below that in the 100 kHz bandwidth within the band that contains the highest level of the desired power, based on either an RF conducted or a radiated measurement.
Test setup:	 <p>The diagram illustrates the test setup. A Spectrum Analyzer is connected to an E.U.T. (Equipment Under Test) via a red cable. Both are placed on a Non-Conducted Table, which is supported by a Ground Reference Plane.</p>
Test Instruments:	Refer to section 6.0 for details
Test mode:	Refer to section 5.2 for details
Test results:	Pass

Test plot as follows:

**GFSK Mode:**

Test channel:	Lowest channel
---------------	----------------

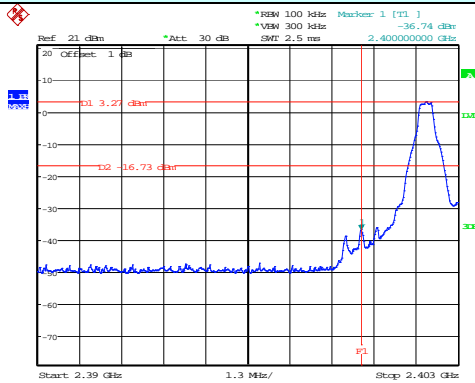

Date: 6.AUG.2018 10:50:17

No-hopping mode

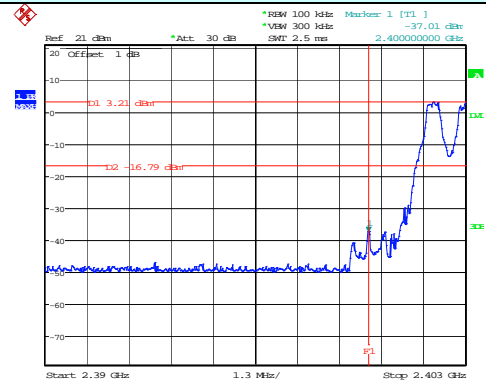

Date: 6.AUG.2018 10:52:23

Hopping mode

Test channel:	Highest channel
---------------	-----------------

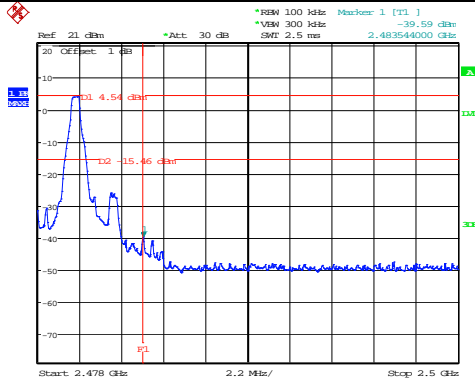

Date: 6.AUG.2018 10:56:54

No-hopping mode

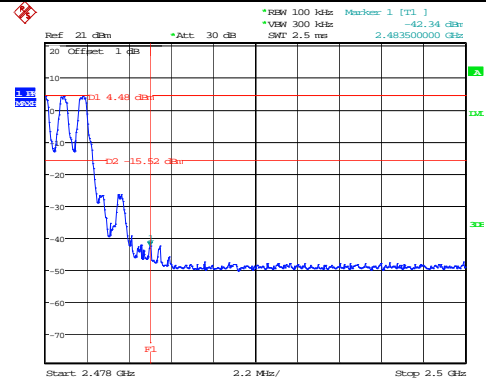

Date: 6.AUG.2018 10:55:31

Hopping mode



**Pi/4QPSK Mode:**

Test channel:	Lowest channel
---------------	----------------

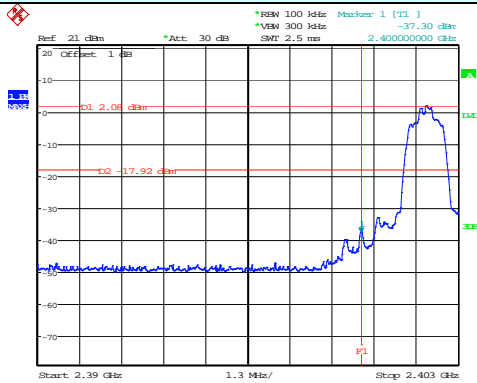

Date: 6.AUG.2018 10:48:43

No-hopping mode

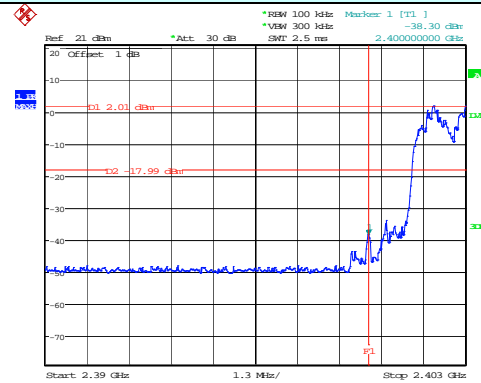

Date: 6.AUG.2018 10:46:14

Hopping mode

Test channel:	Highest channel
---------------	-----------------

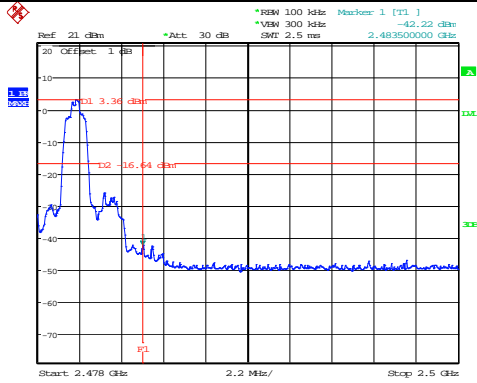

Date: 6.AUG.2018 10:59:05

No-hopping mode

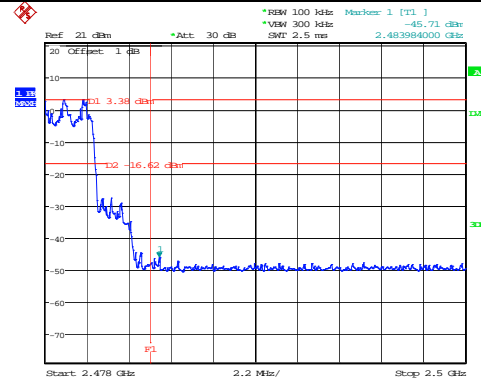

Date: 6.AUG.2018 11:00:41

Hopping mode

## 8DPSK Mode:

Test channel:	Lowest channel
---------------	----------------

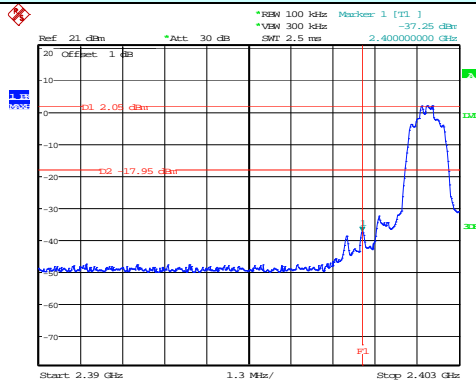

Date: 6.AUG.2018 10:41:15

No-hopping mode

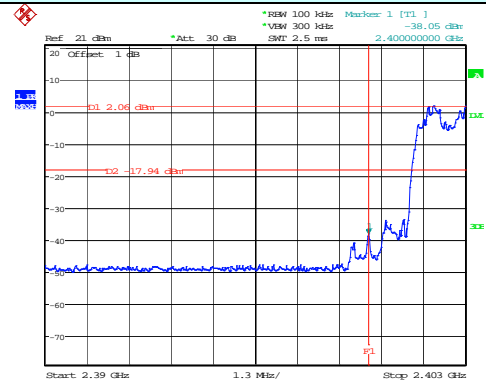

Date: 6.AUG.2018 10:44:49

Hopping mode

Test channel:	Highest channel
---------------	-----------------

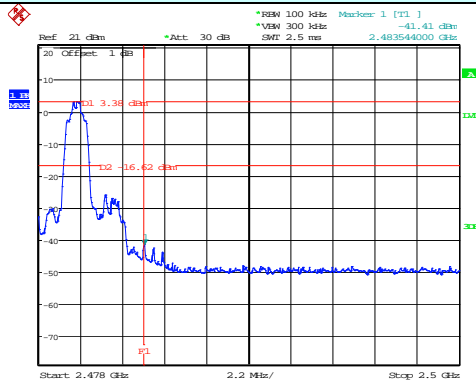

Date: 6.AUG.2018 11:04:21

No-hopping mode

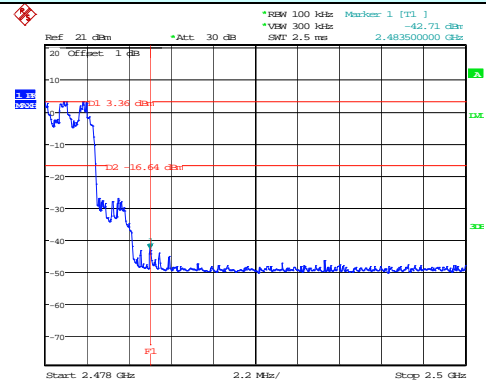

Date: 6.AUG.2018 11:03:18

Hopping mode

## 7.9.2 Radiated Emission Method

Test Requirement:	FCC Part15 C Section 15.209 and 15.205			
Test Method:	ANSI C63.10:2013			
Test Frequency Range:	All restriction band have been tested, and 2310MHz to 2390MHz, 2483.5MHz to 2500MHz band is the worse case			
Test site:	Measurement Distance: 3m			
Receiver setup:	Frequency	Detector	RBW	VBW
	Above 1GHz	Peak	1MHz	3MHz
Limit:	Frequency	Limit (dBuV/m @3m)		Remark
	Above 1GHz	54.00		Average Value
Test setup:			74.00	Peak Value
Test Procedure:	<ol style="list-style-type: none"> <li>1. The EUT was placed on the top of a rotating table 1.5 meters above the ground at a 3 meter camber. The table was rotated 360 degrees to determine the position of the highest radiation.</li> <li>2. The EUT was set 3 meters away from the interference-receiving antenna, which was mounted on the top of a variable-height antenna tower.</li> <li>3. The antenna height is varied from one meter to four meters above the ground to determine the maximum value of the field strength. Both horizontal and vertical polarizations of the antenna are set to make the measurement.</li> <li>4. For each suspected emission, the EUT was arranged to its worst case and then the antenna was tuned to heights from 1 meter to 4 meters and the rota table was turned from 0 degrees to 360 degrees to find the maximum reading.</li> <li>5. The test-receiver system was set to Peak Detect Function and Specified Bandwidth with Maximum Hold Mode.</li> <li>6. If the emission level of the EUT in peak mode was 10dB lower than the limit specified, then testing could be stopped and the peak values of the EUT would be reported. Otherwise the emissions that did not have 10dB margin would be re-tested one by one using peak, quasi-peak or average method as specified and then reported in a data sheet.</li> </ol>			
Test Instruments:	Refer to section 6.0 for details			
Test mode:	Refer to section 5.2 for details			
Test results:	Pass			

**Remark:**

1. During the test, pre-scan the GFSK, Pi/4QPSK, 8DPSK modulation, and found the GFSK modulation which it is worse case.

Test channel:	Lowest
---------------	--------

**Peak value:**

Frequency (MHz)	Read Level (dBuV)	Correct factor (dB/m)	Level (dBuV/m)	Limit Line (dBuV/m)	Over Limit (dB)	Polarization
2310.00	54.71	-15.12	39.59	74.00	-34.41	Horizontal
2390.00	53.69	-15.05	38.64	74.00	-35.36	Horizontal
2310.00	53.86	-15.12	38.74	74.00	-35.26	Vertical
2390.00	54.01	-15.05	38.96	74.00	-35.04	Vertical

**Average value:**

Frequency (MHz)	Read Level (dBuV)	Correct factor (dB/m)	Level (dBuV/m)	Limit Line (dBuV/m)	Over Limit (dB)	Polarization
2310.00	45.69	-15.12	30.57	54.00	-23.43	Horizontal
2390.00	44.18	-15.05	29.13	54.00	-24.87	Horizontal
2310.00	42.32	-15.12	27.20	54.00	-26.80	Vertical
2390.00	43.27	-15.05	28.22	54.00	-25.78	Vertical

Test channel:	Highest
---------------	---------

**Peak value:**

Frequency (MHz)	Read Level (dBuV)	Correct factor (dB/m)	Level (dBuV/m)	Limit Line (dBuV/m)	Over Limit (dB)	Polarization
2483.50	72.35	-14.68	57.57	74.00	-16.33	Horizontal
2500.00	54.15	-14.60	39.55	74.00	-34.45	Horizontal
2483.50	73.06	-14.68	58.38	74.00	-15.62	Vertical
2500.00	53.91	-14.60	39.31	74.00	-34.69	Vertical

**Average value:**

Frequency (MHz)	Read Level (dBuV)	Correct factor (dB/m)	Level (dBuV/m)	Limit Line (dBuV/m)	Over Limit (dB)	Polarization
2483.50	55.36	-14.68	40.68	54.00	-13.32	Horizontal
2500.00	44.36	-14.60	29.76	54.00	-24.24	Horizontal
2483.50	53.13	-14.68	38.45	54.00	-15.55	Vertical
2500.00	44.28	-14.60	29.68	54.00	-24.32	Vertical

**Remark:**

1. Final Level = Receiver Read level + Correct factor
2. The emission levels of other frequencies are very lower than the limit and not show in test report.
3. Correct factor = Antenna Factor + Cable Loss – Pre-amplifier Factor

## 7.10 Spurious Emission

### 7.10.1 Conducted Emission Method

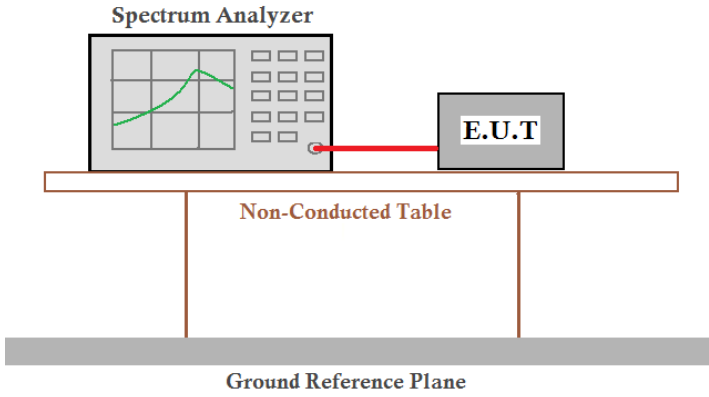
Test Requirement:	FCC Part15 C Section 15.247 (d)
Test Method:	ANSI C63.10:2013
Limit:	In any 100 kHz bandwidth outside the frequency band in which the spread spectrum intentional radiator is operating, the radio frequency power that is produced by the intentional radiator shall be at least 20 dB below that in the 100 kHz bandwidth within the band that contains the highest level of the desired power, based on either an RF conducted or a radiated measurement.
Test setup:	 <p>The diagram illustrates the test setup. A Spectrum Analyzer is connected to an E.U.T. (Equipment Under Test) via a red cable. Both are placed on a Non-Conducted Table, which is supported by a Ground Reference Plane.</p>
Test Instruments:	Refer to section 6.0 for details
Test mode:	Refer to section 5.2 for details
Test results:	Pass

**Remark:**

During the test, pre-scan the GFSK, Pi/4QPSK, 8DPSK modulation, and found the GFSK modulation which it is worse case.

Test channel: Lowest channel

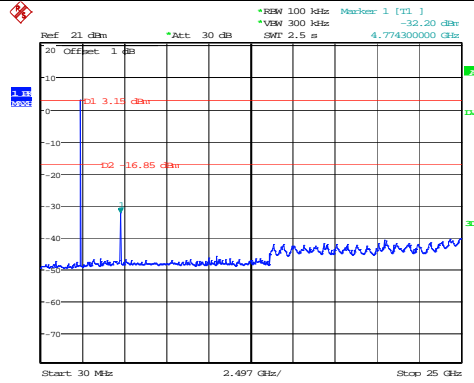

Date: 6.AUG.2018 10:17:29

30MHz~25GHz

Test channel: Middle channel

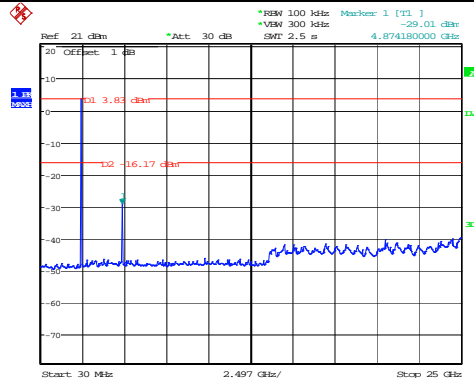

Date: 6.AUG.2018 10:15:44

30MHz~25GHz

Test channel: Highest channel

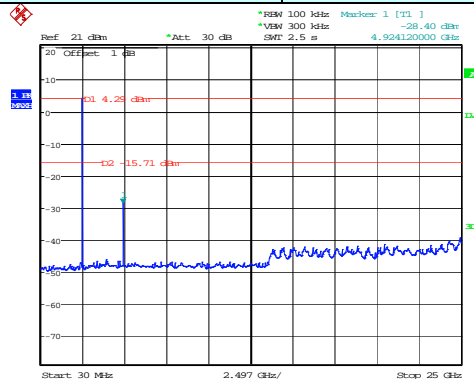

Date: 6.AUG.2018 10:19:29

30MHz~25GHz

## 7.10.2 Radiated Emission Method

Test Requirement:	FCC Part15 C Section 15.209				
Test Method:	ANSI C63.10:2013				
Test Frequency Range:	9kHz to 25GHz				
Test site:	Measurement Distance: 3m				
Receiver setup:	Frequency	Detector	RBW	VBW	Value
	9KHz-150KHz	Quasi-peak	200Hz	600Hz	Quasi-peak
	150KHz-30MHz	Quasi-peak	9KHz	30KHz	Quasi-peak
	30MHz-1GHz	Quasi-peak	100KHz	300KHz	Quasi-peak
	Above 1GHz	Peak	1MHz	3MHz	Peak
Peak		1MHz	10Hz	Average	
Limit: (Spurious Emissions)	Frequency	Limit (uV/m)	Value	Measurement Distance	
	0.009MHz-0.490MHz	2400/F(KHz)	QP	300m	
	0.490MHz-1.705MHz	24000/F(KHz)	QP	300m	
	1.705MHz-30MHz	30	QP	30m	
	30MHz-88MHz	100	QP	3m	
	88MHz-216MHz	150	QP		
	216MHz-960MHz	200	QP		
	960MHz-1GHz	500	QP		
	Above 1GHz	500	Average		
5000		Peak			
Limit: (band edge)	Emissions radiated outside of the specified frequency bands, except for harmonics, shall be attenuated by at least 50 dB below the level of the fundamental or to the general radiated emission limits in Section 15.209, whichever is the lesser attenuation.				

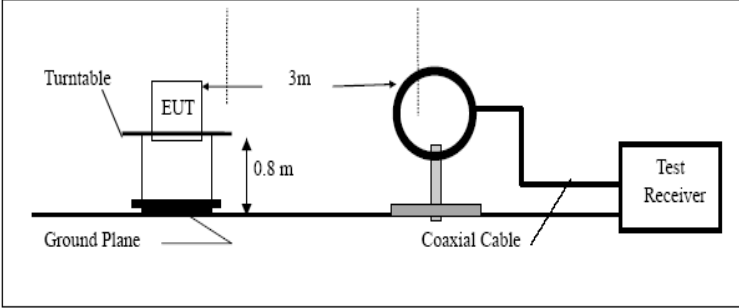
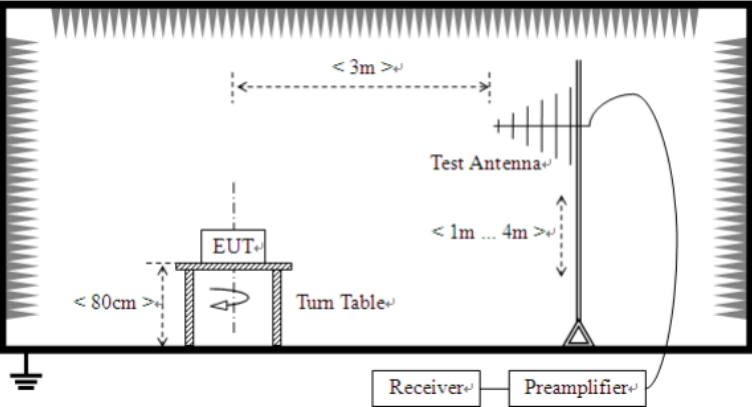
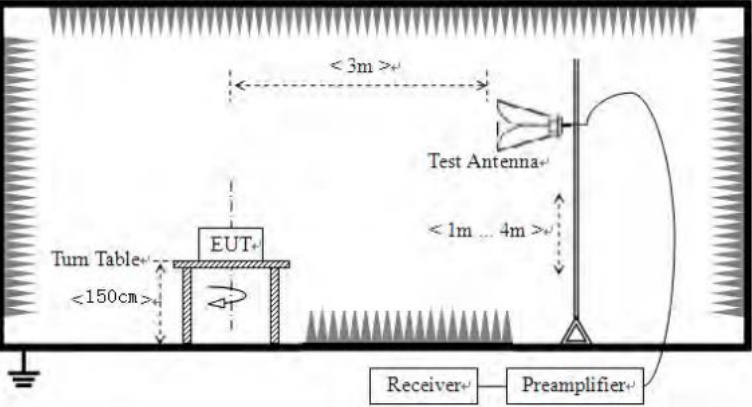
<p>Test setup:</p>	<p>Below 30MHz</p>  <p>Below 1GHz</p>  <p>Above 1GHz</p> 
<p>Test Procedure:</p>	<ol style="list-style-type: none"> <li>1. The EUT was placed on the top of a rotating table (0.8m for below 1G and 1.5m for above 1G) above the ground at a 3 meter camber. The table was rotated 360 degrees to determine the position of the highest radiation.</li> <li>2. The EUT was set 3 meters away from the interference-receiving antenna, which was mounted on the top of a variable-height antenna tower.</li> </ol>



	<ol style="list-style-type: none"> <li>3. The antenna height is varied from one meter to four meters above the ground to determine the maximum value of the field strength. Both horizontal and vertical polarizations of the antenna are set to make the measurement.</li> <li>4. For each suspected emission, the EUT was arranged to its worst case and then the antenna was tuned to heights from 1 meter to 4 meters and the rota table was turned from 0 degrees to 360 degrees to find the maximum reading.</li> <li>5. The test-receiver system was set to Peak Detect Function and Specified Bandwidth with Maximum Hold Mode.</li> <li>6. If the emission level of the EUT in peak mode was 10dB lower than the limit specified, then testing could be stopped and the peak values of the EUT would be reported. Otherwise the emissions that did not have 10dB margin would be re-tested one by one using peak, quasi-peak or average method as specified and then reported in a data sheet.</li> </ol>
Test Instruments:	Refer to section 6.0 for details
Test mode:	Refer to section 5.2 for details
Test results:	Pass

**Measurement data:**

*Remark:*

1. *During the test, pre-scan the GFSK, Pi/4QPSK, 8DPSK modulation, and found the GFSK modulation which it is worse case.*
2. *Pre-scan all kind of the place mode (X-axis, Y-axis, Z-axis), and found the Y-axis which it is worse case.*

■ **9 kHz ~ 30 MHz**

The low frequency, which started from 9 kHz to 30 MHz, was pre-scanned and the result which was 20 dB lower than the limit line per 15.31(o) was not reported.

■ Below 1GHz

EUT:	Flex Sport Headphone	Polarziation:	Horizontal
Model:	Flex Sport	Power Source:	AC120V/60Hz
Mode:	BT mode	Temp./Hum.(%H):	26°C/60%RH

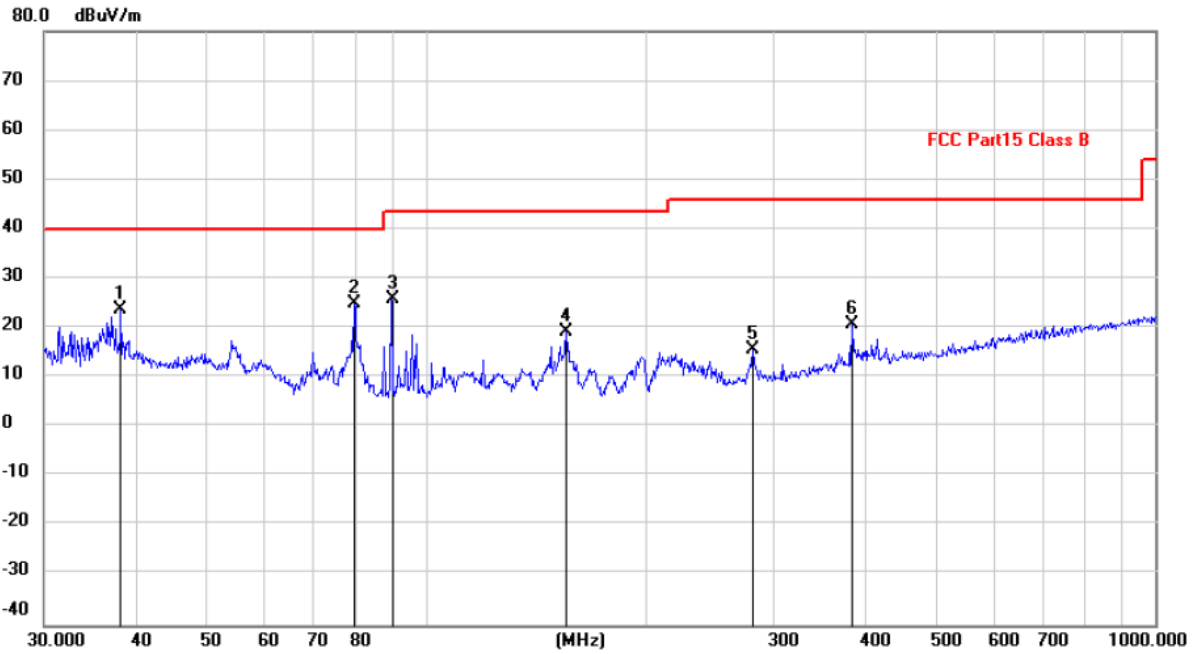

No.	Mk.	Freq. MHz	Reading Level dBuV	Correct Factor dB	Measure- ment dBuV/m	Limit dBuV/m	Over dB	Detector
1		38.2120	56.83	-33.18	23.65	40.00	-16.35	QP
2	*	79.8002	63.85	-38.95	24.90	40.00	-15.10	QP
3		89.9047	64.98	-39.16	25.82	43.50	-17.68	QP
4		155.9100	53.84	-34.70	19.14	43.50	-24.36	QP
5		281.0074	51.15	-35.44	15.71	46.00	-30.29	QP
6		383.9318	53.51	-32.82	20.69	46.00	-25.31	QP

<b>EUT:</b>	<b>Flex Sport Headphone</b>	<b>Polarization:</b>	<b>Vertical</b>
<b>Model:</b>	<b>Flex Sport</b>	<b>Power Source:</b>	<b>AC120V/60Hz</b>
<b>Mode:</b>	<b>BT mode</b>	<b>Temp./Hum.(%H):</b>	<b>26°C/60%RH</b>

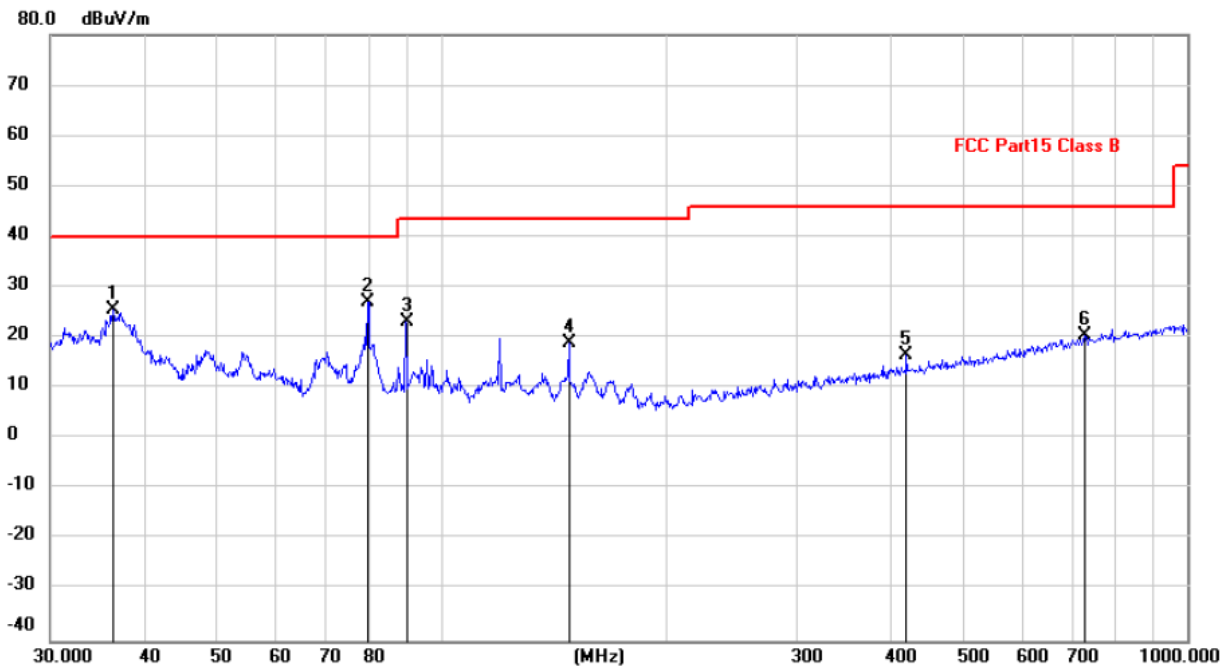

No.	Mk.	Freq. MHz	Reading Level dBuV	Correct Factor dB	Measure- ment dBuV/m	Limit dBuV/m	Over dB	Detector
1		36.3813	58.78	-33.20	25.58	40.00	-14.42	QP
2	*	79.8002	66.09	-38.95	27.14	40.00	-12.86	QP
3		89.9047	62.19	-39.16	23.03	43.50	-20.47	QP
4		148.4410	53.58	-34.72	18.86	43.50	-24.64	QP
5		420.5803	48.49	-31.87	16.62	46.00	-29.38	QP
6		729.3582	46.39	-25.95	20.44	46.00	-25.56	QP

■ Above 1GHz

Test channel:	Lowest
---------------	--------

**Peak value:**

Frequency (MHz)	Read Level (dBuV)	Correct factor (dB/m)	Level (dBuV/m)	Limit Line (dBuV/m)	Over Limit (dB)	Polarization
4804.00	57.64	-7.43	50.21	74.00	-23.79	Vertical
7206.00	57.83	-2.42	55.41	74.00	-18.59	Vertical
9608.00	56.27	-2.38	53.89	74.00	-20.11	Vertical
12010.00	*			74.00		Vertical
14412.00	*			74.00		Vertical
4804.00	59.42	-7.43	51.99	74.00	-22.01	Horizontal
7206.00	58.51	-2.42	56.09	74.00	-17.91	Horizontal
9608.00	57.63	-2.38	55.25	74.00	-18.75	Horizontal
12010.00	*			74.00		Horizontal
14412.00	*			74.00		Horizontal

**Average value:**

Frequency (MHz)	Read Level (dBuV)	Correct factor (dB/m)	Level (dBuV/m)	Limit Line (dBuV/m)	Over Limit (dB)	Polarization
4804.00	48.11	-7.43	40.68	54.00	-13.32	Vertical
7206.00	47.38	-2.42	44.96	54.00	-9.04	Vertical
9608.00	47.25	-2.38	44.87	54.00	-9.13	Vertical
12010.00	*			54.00		Vertical
14412.00	*			54.00		Vertical
4804.00	48.73	-7.43	41.30	54.00	-12.70	Horizontal
7206.00	46.69	-2.42	44.27	54.00	-9.73	Horizontal
9608.00	47.07	-2.38	44.69	54.00	-9.31	Horizontal
12010.00	*			54.00		Horizontal
14412.00	*			54.00		Horizontal

*Remark:*

1. *Final Level = Receiver Read level + Correct factor*
2. *Correct factor = Antenna Factor + Cable Loss – Preamplifier Factor*
3. *“\*”, means this data is the too weak instrument of signal is unable to test.*
4. *The emission levels of other frequencies are very lower than the limit and not show in test report.*

Test channel:	Middle
---------------	--------

**Peak value:**

Frequency (MHz)	Read Level (dBuV)	Correct factor (dB/m)	Level (dBuV/m)	Limit Line (dBuV/m)	Over Limit (dB)	Polarization
4882.00	55.83	-7.49	48.34	74.00	-25.66	Vertical
7323.00	56.18	-2.40	53.78	74.00	-20.22	Vertical
9764.00	55.94	-2.38	53.56	74.00	-20.44	Vertical
12205.00	*			74.00		Vertical
14646.00	*			74.00		Vertical
4882.00	65.73	-7.49	58.24	74.00	-15.76	Horizontal
7323.00	58.84	-2.40	56.44	74.00	-17.56	Horizontal
9764.00	56.49	-2.38	54.11	74.00	-19.89	Horizontal
12205.00	*			74.00		Horizontal
14646.00	*			74.00		Horizontal

**Average value:**

Frequency (MHz)	Read Level (dBuV)	Correct factor (dB/m)	Level (dBuV/m)	Limit Line (dBuV/m)	Over Limit (dB)	Polarization
4882.00	46.63	-7.49	39.14	54.00	-14.86	Vertical
7323.00	47.84	-2.40	45.44	54.00	-8.56	Vertical
9764.00	45.13	-2.38	42.75	54.00	-11.25	Vertical
12205.00	*			54.00		Vertical
14646.00	*			54.00		Vertical
4882.00	48.63	-7.49	41.14	54.00	-12.86	Horizontal
7323.00	47.34	-2.40	44.94	54.00	-9.06	Horizontal
9764.00	46.28	-2.38	43.90	54.00	-10.1	Horizontal
12205.00	*			54.00		Horizontal
14646.00	*			54.00		Horizontal

*Remark:*

1. *Final Level = Receiver Read level + Correct factor*
2. *Correct factor = Antenna Factor + Cable Loss – Preamplifier Factor*
3. *“\*”, means this data is too weak instrument of signal is unable to test.*
4. *The emission levels of other frequencies are very lower than the limit and not show in test report.*

Test channel:	Highest
---------------	---------

**Peak value:**

Frequency (MHz)	Read Level (dBuV)	Correct factor (dB/m)	Level (dBuV/m)	Limit Line (dBuV/m)	Over Limit (dB)	Polarization
4960.00	56.11	-7.47	48.64	74.00	-25.36	Vertical
7440.00	57.26	-2.45	54.81	74.00	-19.19	Vertical
9920.00	56.59	-2.37	54.22	74.00	-19.78	Vertical
12400.00	*			74.00		Vertical
14880.00	*			74.00		Vertical
4960.00	66.96	-7.47	59.49	74.00	-14.51	Horizontal
7440.00	59.18	-2.45	56.73	74.00	-17.27	Horizontal
9920.00	57.43	-2.37	55.06	74.00	-18.94	Horizontal
12400.00	*			74.00		Horizontal
14880.00	*			74.00		Horizontal

**Average value:**

Frequency (MHz)	Read Level (dBuV)	Correct factor (dB/m)	Level (dBuV/m)	Limit Line (dBuV/m)	Over Limit (dB)	Polarization
4960.00	47.19	-7.47	39.72	54.00	-14.28	Vertical
7440.00	48.23	-2.45	45.78	54.00	-8.22	Vertical
9920.00	47.12	-2.37	44.75	54.00	-9.25	Vertical
12400.00	*			54.00		Vertical
14880.00	*			54.00		Vertical
4960.00	48.23	-7.47	40.76	54.00	-13.24	Horizontal
7440.00	47.75	-2.45	45.30	54.00	-8.70	Horizontal
9920.00	46.28	-2.37	43.91	54.00	-10.09	Horizontal
12400.00	*			54.00		Horizontal
14880.00	*			54.00		Horizontal

*Remark:*

1. *Final Level = Receiver Read level + Correct factor*
2. *Correct factor = Antenna Factor + Cable Loss – Preamplifier Factor*
3. *“\*”, means this data is the too weak instrument of signal is unable to test.*
4. *The emission levels of other frequencies are very lower than the limit and not show in test report.*

## 8 Test Setup Photo

Radiated Emission

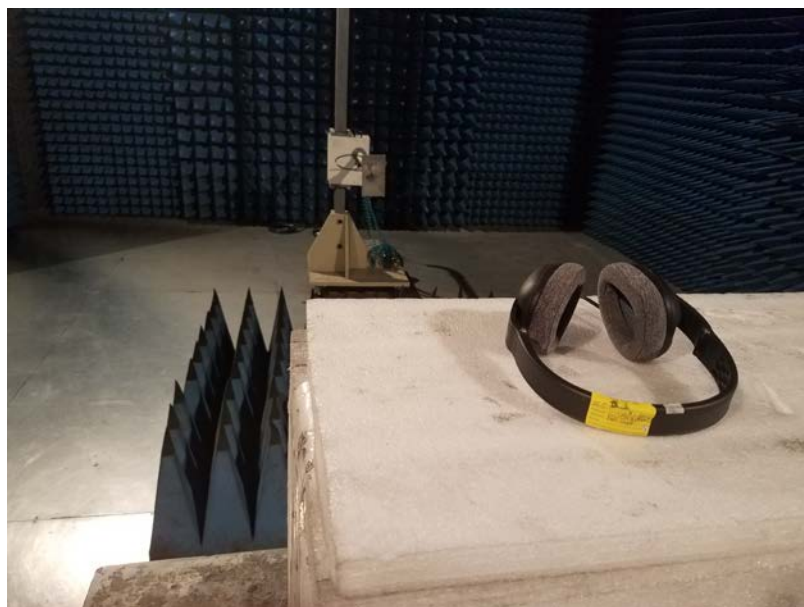

## Conducted Emission





## 9 EUT Constructional Details











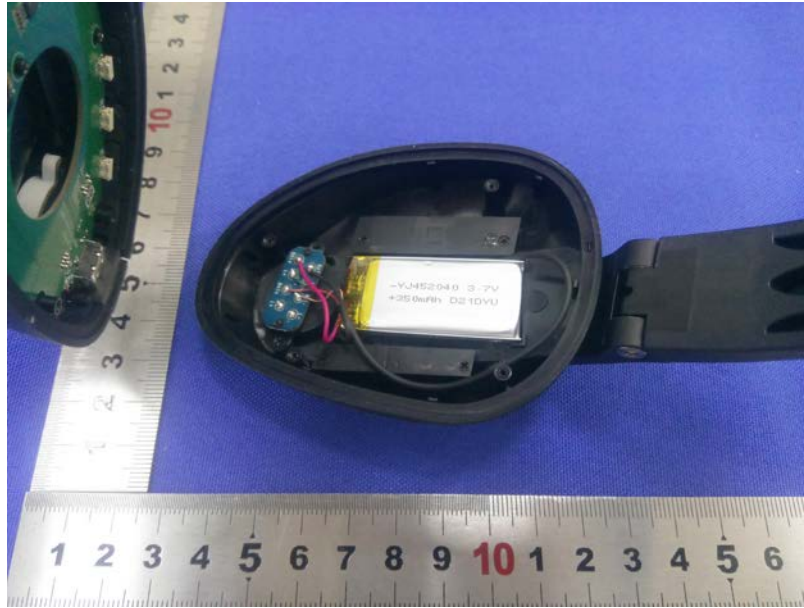

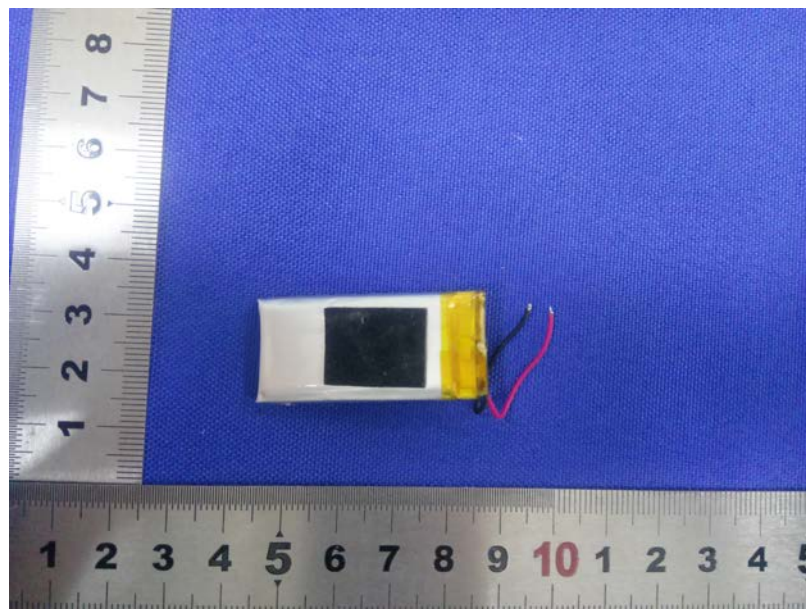
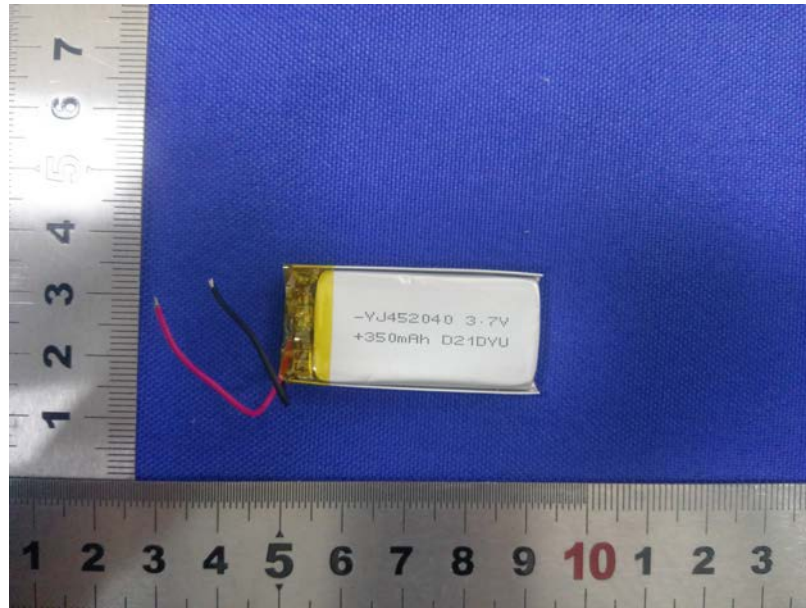





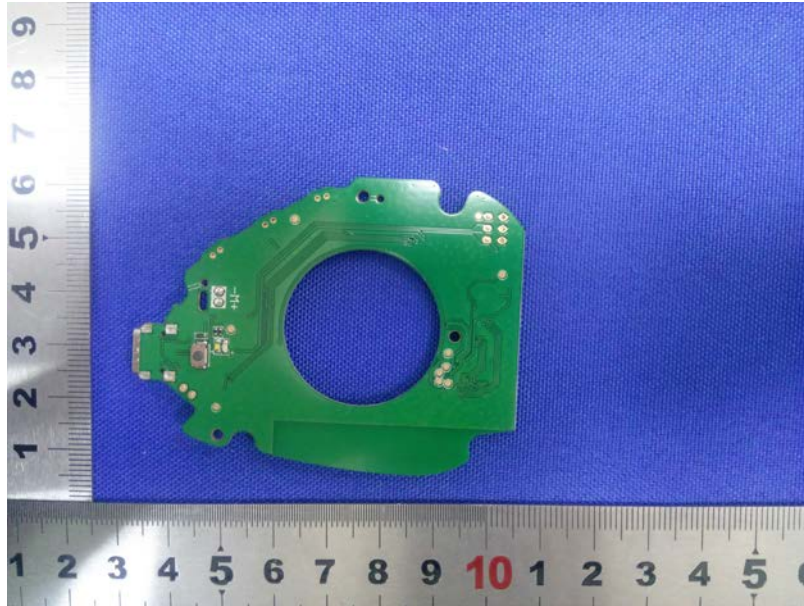

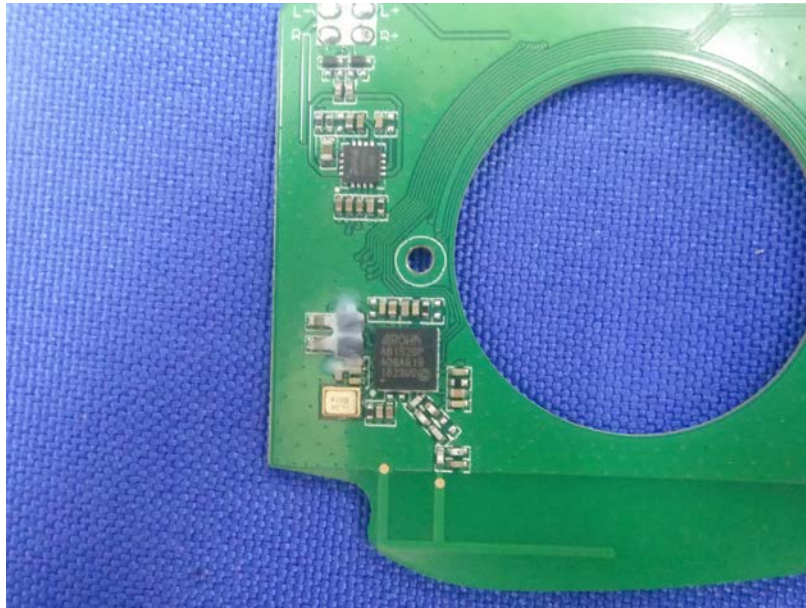

-----End-----