

TEST REPORT

Report No...... : **KS2204S1409E01**

FCC ID..... : **2AHYV-EMOUSE**

Applicant..... : **PEAG, LLC dba JLab Audio**

Address..... : 5927 Landau Ct. Carlsbad, CA 92008 , USA

Manufacturer..... : GuangDong Simpreal Intelligent Technology Co., Ltd

Address..... : Room 2408, JiaHong ZhenXing DaSha, DongGuan Avenue #13,
DongCheng District, DongGuan City, GuangDong Province, P.R.
China

Product Name..... : Bluetooth Mouse

Trade Mark..... : JLAB

Model/Type reference..... : Epic Mouse

Listed Model(s)..... : N/A

Standard..... : **FCC CFR Title 47 Part 15 Subpart C Section 15.249**

Date of Receipt..... : April 21, 2022

Date of Test Date..... : April 21, 2022 ~ June 01, 2022

Date of issue..... : June 10, 2022

Test result..... : **Pass**

Prepared by: Sky Dong

(Printed name+ signature)



Approved by: Neil Wan

(Printed name + Signature)

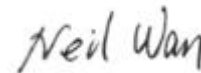

Testing Laboratory Name..... : **KSIGN Testing Co., Ltd.**

Address..... : Building 5, No. 316, Jianghong South Road Binjiang District,
Hangzhou 310052, China

This test report may be duplicated completely for legal use with the approval of the applicant. It should not be reproduced except in full, without the written approval of our laboratory. The client should not use it to claim product endorsement by KSIGN. The test results in the report only apply to the tested sample. The test report shall be invalid without all the signatures of testing engineers, reviewer and approver. Any objections must be raised to KSIGN within 15 days since the date when the report is received. It will not be taken into consideration beyond this limit. The test report merely correspond to the test sample.

TABLE OF CONTENTS**Page**

1. TEST SUMMARY	3
1.1. TEST STANDARDS	3
1.2. REPORT VERSION	3
1.3. TEST DESCRIPTION	4
1.4. TABLE OF CARRIER FREQUENCY	4
1.5. MEASUREMENT UNCERTAINTY	5
1.6. ENVIRONMENTAL CONDITIONS	5
2. GENERAL INFORMATION	6
2.1. CLIENT INFORMATION	6
2.2. GENERAL DESCRIPTION OF EUT	6
2.3. DESCRIPTION OF TEST MODES	7
2.4. MEASUREMENT INSTRUMENTS LIST	8
3. TEST ITEM AND RESULTS	9
3.1. ANTENNA REQUIREMENT	9
3.2. CONDUCTED EMISSION	10
3.3. 20dB BANDWIDTH	13
3.4. RADIATED SPURIOUS EMISSIONS	16
3.5. BAND EDGE EMISSIONS(RADIATED)	22
4. EUT TEST PHOTOS	26
5. PHOTOGRAPHS OF EUT CONSTRUCTIONAL	28

1. TEST SUMMARY

1.1. Test Standards

The tests were performed according to following standards:

FCC Rules Part 15.249: Operation within the bands 902-928 MHz, 2400-2483.5 MHz, 5725-5875 MHz, and 24.0-24.25 GHz.

ANSI C63.10-2013: American National Standard for Testing Unlicensed Wireless Devices.

1.2. Report version

Revised No.	Date of issue	Description
01	June 10, 2022	Original

1.3. Test Description

FCC Rules Part 15.249			
Test Item	Section in CFR 47	Result	Test Engineer
	FCC		
Antenna requirement	15.203	Pass	Tom Chen
AC Power Line Conducted Emissions	15.207	Pass	Tom Chen
20dB Bandwidth	Section 15.215(c)	Pass	Tom Chen
Band edge Emissions	Section 15.249(d)	Pass	Tom Chen
Radiated Spurious Emissions	Section 15.205(a), Section 15.209(a), Section 15.249	Pass	Tom Chen

Note:

1. The measurement uncertainty is not included in the test result.

1.4. Table of Carrier Frequency

Frequency Band	Channel Number	Frequency	Channel Number	Frequency
2400~2483.5MHZ	1	2402MHz	9	2414MHz
	2	2429MHz	10	2434MHz
	3	2446MHz	11	2459MHz
	4	2461MHz	12	2473MHz
	5	2407MHz	13	2419MHz
	6	2424MHz	14	2446MHz
	7	2449MHz	15	2454MHz
	8	2464MHz	16	2479MHz

1.5. Measurement Uncertainty

The data and results referenced in this document are true and accurate. The reader is cautioned that there may be errors within the calibration limits of the equipment and facilities. The measurement uncertainty was calculated for all measurements listed in this test report acc. to TR-100028-01” Electromagnetic compatibility and Radio spectrum Matters (ERM);Uncertainties in the measurement of mobile radio equipment characteristics; Part 1” and TR-100028-02 “Electromagnetic compatibility and Radio spectrum Matters (ERM);Uncertainties in the measurement of mobile radio equipment characteristics; Part 2 “ and is documented in the KSIGN(Guangdong) Testing Co., Ltd. system acc. to DIN EN ISO/IEC 17025. Furthermore, component and process variability of devices similar to that tested may result in additional deviation. The manufacturer has the sole responsibility of continued compliance of the device. Below is the best measurement capability for KSIGN(Guangdong) Testing Co., Ltd.

Test Items	Measurement Uncertainty	Notes
Transmitter power conducted	0.42 dB	(1)
Transmitter power Radiated	2.14 dB	(1)
Conducted spurious emissions 9kHz~40GHz	1.60 dB	(1)
Radiated spurious emissions 9kHz~40GHz	2.20 dB	(1)
Conducted Emissions 9kHz~30MHz	3.20 dB	(1)
Radiated Emissions 30~1000MHz	4.70 dB	(1)
Radiated Emissions 1~18GHz	5.00 dB	(1)
Radiated Emissions 18~40GHz	5.54 dB	(1)
Occupied Bandwidth	2.80 dB	(1)

Note (1): This uncertainty represents an expanded uncertainty expressed at approximately the 95% confidence level using a coverage factor of k=1.96.

1.6. Environmental conditions

During the measurement the environmental conditions were within the listed ranges:

Temperature:	15~35°C
Relative Humidity:	30~60 %
Air Pressure:	950~1050mba

2. GENERAL INFORMATION

2.1. Client Information

Applicant:	PEAG, LLC dba JLab Audio
Address:	5927 Landau Ct. Carlsbad, CA 92008 , USA
Manufacturer:	GuangDong Simpreal Intelligent Technology Co., Ltd
Address:	Room 2408, JiaHong ZhenXing DaSha, DongGuan Avenue #13, DongCheng District, DongGuan City, GuangDong Province, P.R. China

2.2. General Description of EUT

Product Name:	Bluetooth Mouse
Trade Mark:	JLAB
Model/Type reference:	Epic Mouse
Listed Model(s):	N/A
Model Different:	N/A
Power supply:	DC5.0V
Power supply(Battery):	DC3.7V
Hardware version:	V2.1
Software version:	V2.2
Specification	
Modulation:	GFSK
Operation frequency:	2402MHz-2479MHz
Channel number:	16
Antenna type:	PCB antenna
Antenna gain:	0dBi

2.3. Description of Test Modes

Operation Frequency List: The EUT has been tested under typical operating condition. The Applicant provides communication tools software to control the EUT for staying in continuous transmitting and receiving mode for testing.

Operation Frequency: 2402MHz/2446MHz/2479MHz

Test mode

For RF test items:
The engineering test program was provided and enabled to make EUT continuous transmit.
For Radiated spurious emissions test item:
The engineering test program was provided and enabled to make EUT continuous transmit. The EUT in each of three orthogonal axis emissions had been tested, but only the worst case (X axis) data recorded in the report.

2.4. Measurement Instruments List

Tonscend JS0806-2 Test system					
Item	Test Equipment	Manufacturer	Model No.	Serial No.	Cal. Until
1	Spectrum Analyzer	R&S	FSV40-N	101798	03/04/2023
2	Vector Signal Generator	Agilent	N5182A	MY50142520	03/04/2023
3	Analog Signal Generator	HP	83752A	3344A00337	03/04/2023
4	Power Sensor	Agilent	E9304A	MY50390009	03/04/2023
5	Power Sensor	Agilent	E9300A	MY41498315	03/04/2023
6	Wideband Radio Communication Tester	R&S	CMW500	157282	03/04/2023
7	Climate Chamber	Angul	AGNH80L	1903042120	03/04/2023
8	Dual Output DC Power Supply	Agilent	E3646A	MY40009992	03/04/2023
9	RF Control Unit	Tonscend	JS0806-2	/	03/04/2023

Transmitter spurious emissions & Receiver spurious emissions					
Item	Test Equipment	Manufacturer	Model No.	Serial No.	Cal. Until
1	EMI Test Receiver	R&S	ESR	102525	03/04/2023
2	High Pass Filter	Chengdu E-Microwave	OHF-3-18-S	0E01901038	03/04/2023
3	High Pass Filter	Chengdu E-Microwave	OHF-6.5-18-S	0E01901039	03/04/2023
4	Spectrum Analyzer	HP	8593E	3831U02087	03/04/2023
5	Ultra-Broadband logarithmic period Antenna	Schwarzbeck	VULB 9163	01230	12/04/2023
6	Loop Antenna	Beijin ZHINAN	ZN30900C	18050	03/15/2023
7	Spectrum Analyzer	R&S	FSV40-N	101798	03/04/2023
8	Horn Antenna	Schwarzbeck	BBHA 9120 D	2023	03/29/2023
9	Pre-Amplifier	Schwarzbeck	BBV 9745	9745#129	03/04/2023
10	Pre-Amplifier	EMCI	EMC051835SE	980662	03/04/2023
11	Horn Antenna	Schwarzbeck	BBHA 9170	00943	03/04/2023

Item	Test Equipment	Manufacturer	Model No.	Serial No.	Cal. Until
1	LISN	R&S	ENV432	1326.6105.02	03/04/2023
2	EMI Test Receiver	R&S	ESR	102524	03/04/2023
3	Manual RF Switch	JS TOYO	/	MSW-01/002	03/04/2023

Note:

1)The Cal. Interval was one year.

2)The cable loss has calculated in test result which connection between each test instruments.

TRF No. FCC Part 15.249_R1

Add : Building 5, No. 316, Jianghong South Road Binjiang District, Hangzhou 310052, China

Tel : +(86) 0571-8836 6861 Fax: +(86) 0571-8836 6821 E-mail : server@ksign.cn Web: www.ksign.cn

3. TEST ITEM AND RESULTS

3.1. Antenna requirement

Requirement

FCC CFR Title 47 Part 15 Subpart C Section 15.203:

An intentional radiator shall be designed to ensure that no antenna other than that furnished by the responsible party shall be used with the device. The use of a permanently attached antenna or of an antenna that uses a unique coupling to the intentional radiator, the manufacturer may design the unit so that a broken antenna can be replaced by the user, but the use of a standard antenna jack or electrical connector is prohibited.

FCC CFR Title 47 Part 15 Subpart C Section 15.247(c) (1)(i):

(i) Systems operating in the 2400~2483.5 MHz band that is used exclusively for fixed. Point-to-point operations may employ transmitting antennas with directional gain greater than 6dBi provided the maximum conducted output power of the intentional radiator is reduced by 1 dB for every 3 dB that the directional gain of the antenna exceeds 6dBi.

Test Result

The directional gain of the antenna less than 6dBi, please refer to the EUT internal photographs antenna photo.

Note: The antenna is permanently fixed to the EUT

3.2. Conducted Emission

Limit

Conducted Emission Test Limit

Frequency	Maximum RF Line Voltage (dB μ V)	
	Quasi-peak Level	Average Level
150kHz~500kHz	66 ~ 56 *	56 ~ 46 *
500kHz~5MHz	56	46
5MHz~30MHz	60	50

Notes:

- (1) *Decreasing linearly with logarithm of the frequency.
- (2) The lower limit shall apply at the transition frequencies.
- (3) The limit decrease in line with the logarithm of the frequency in the range of 0.15 to 0.50MHz.

Test Configuration

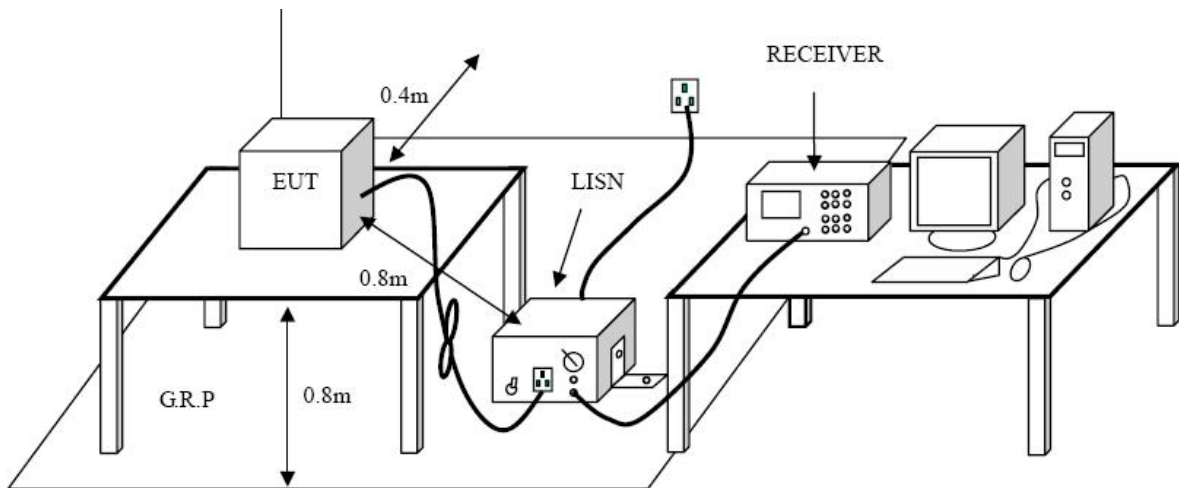

Test Procedure

1. The EUT was setup according to ANSI C63.10:2013 requirements.
2. The EUT was placed on a platform of nominal size, 1 m by 1.5 m, raised 80 cm above the conducting ground plane. The vertical conducting plane was located 40 cm to the rear of the EUT. All other surfaces of EUT were at least 80 cm from any other grounded conducting surface.
3. The EUT and simulators are connected to the main power through a line impedances stabilization network (LISN). The LISN provides a 50ohm /50uH coupling impedance for the measuring equipment. The peripheral devices are also connected to the main power through a LISN. (Please refer to the block diagram of the test setup and photographs)
4. Each current-carrying conductor of the EUT power cord, except the ground (safety) conductor, was individually connected through a LISN to the input power source.
5. The excess length of the power cord between the EUT and the LISN receptacle were folded back and forth at the center of the lead to form a bundle not exceeding 40 cm in length.
6. Conducted Emissions were investigated over the frequency range from 0.15MHz to 30MHz using a receiver bandwidth of 9 kHz.
7. During the above scans, the emissions were maximized by cable manipulation.

Test Results

Test Voltage:	AC 120V/60Hz
Terminal:	Line
Test Mode:	GFSK

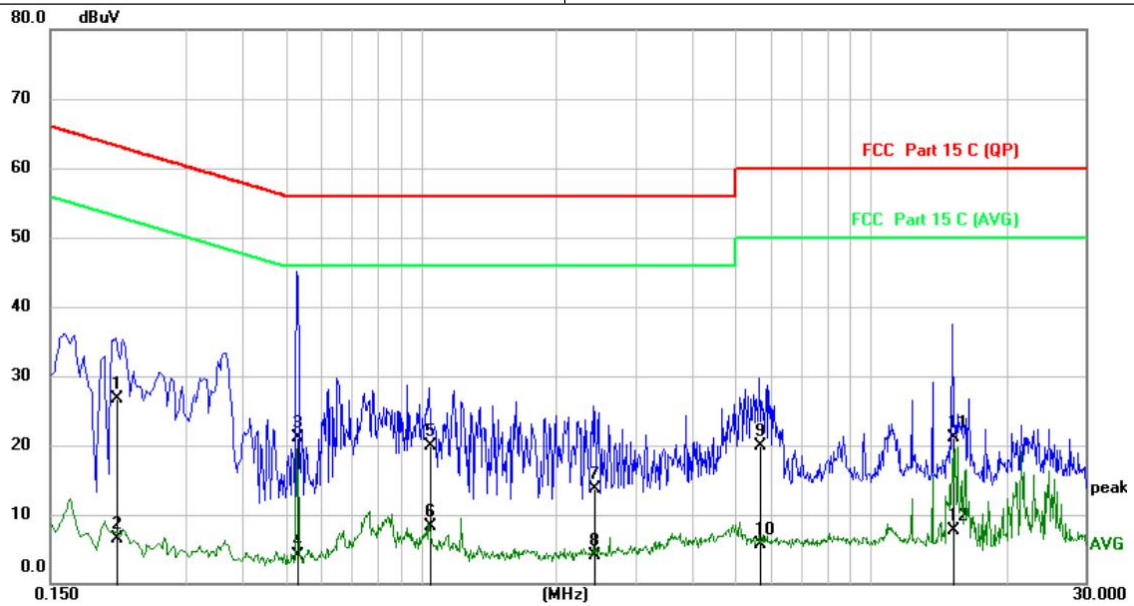

No.	Mk.	Freq. MHz	Reading Level dBuV	Correct Factor dB	Measure- ment dBuV	Limit dBuV	Over dB	Detector
1		0.2100	15.88	10.75	26.63	63.21	-36.58	QP
2		0.2100	-4.17	10.75	6.58	53.21	-46.63	AVG
3	*	0.5299	10.66	10.41	21.07	56.00	-34.93	QP
4		0.5299	-6.35	10.41	4.06	46.00	-41.94	AVG
5		1.0460	9.50	10.48	19.98	56.00	-36.02	QP
6		1.0460	-2.25	10.48	8.23	46.00	-37.77	AVG
7		2.4340	3.12	10.57	13.69	56.00	-42.31	QP
8		2.4340	-6.39	10.57	4.18	46.00	-41.82	AVG
9		5.6779	9.23	10.62	19.85	60.00	-40.15	QP
10		5.6779	-4.97	10.62	5.65	50.00	-44.35	AVG
11		15.1620	10.24	10.77	21.01	60.00	-38.99	QP
12		15.1620	-3.03	10.77	7.74	50.00	-42.26	AVG

Remarks:

- 1.Measurement = Reading Level+ Correct Factor
- 2.Over = Measurement -Limit

Test Voltage:	AC 120V/60Hz
Terminal:	Neutral
Test Mode:	GFSK

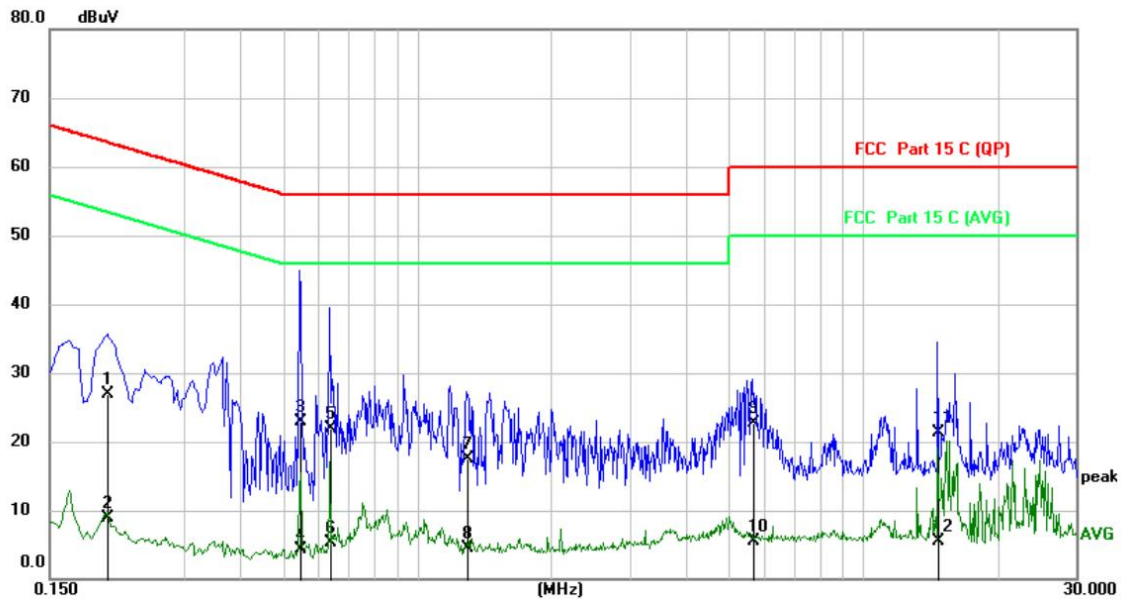

No.	Mk.	Freq. MHz	Reading Level dBuV	Correct Factor dB	Measure- ment dBuV	Limit dBuV	Over dB	Detector
1		0.2020	16.06	10.75	26.81	63.53	-36.72	QP
2		0.2020	-1.89	10.75	8.86	53.53	-44.67	AVG
3	*	0.5460	12.39	10.49	22.88	56.00	-33.12	QP
4		0.5460	-6.15	10.49	4.34	46.00	-41.66	AVG
5		0.6380	11.52	10.45	21.97	56.00	-34.03	QP
6		0.6380	-5.12	10.45	5.33	46.00	-40.67	AVG
7		1.2940	7.07	10.49	17.56	56.00	-38.44	QP
8		1.2940	-6.00	10.49	4.49	46.00	-41.51	AVG
9		5.6540	12.19	10.60	22.79	60.00	-37.21	QP
10		5.6540	-5.02	10.60	5.58	50.00	-44.42	AVG
11		14.6820	10.47	10.76	21.23	60.00	-38.77	QP
12		14.6820	-5.25	10.76	5.51	50.00	-44.49	AVG

Remarks:

- 1.Measurement = Reading Level+ Correct Factor
- 2.Over = Measurement -Limit

3.3. 20dB Bandwidth

Limit

Operation frequency range 2400MHz~2483.5MHz.

Test Configuration

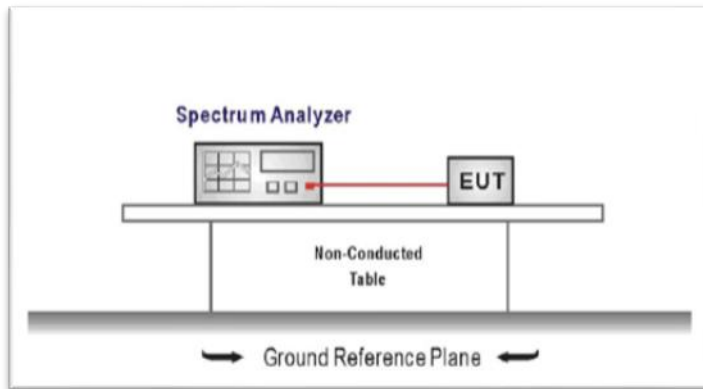

Test Procedure

1. The transmitter output was connected to the spectrum analyzer through an attenuator, the path loss was compensated to the results for each measurement.
2. Set to the maximum power setting and enable the EUT transmit continuously
3. Use the following spectrum analyzer settings:
Span = approximately 2 to 3 times the 20 dB bandwidth, centered on a hopping channel
RBW \geq 1% of the 20 dB bandwidth, VBW \geq RBW
Sweep = auto, Detector function = peak, Trace = max hold
4. Measure and record the results in the test report.

Test Mode

Please refer to the clause 2.3..

Test Results

Test Mode:	GFSK	
Channel frequency (MHz)	20dB Bandwidth [MHz]	Verdict
2402	1.447	PASS
2437	1.447	PASS
2479	1.424	PASS

2402MHz

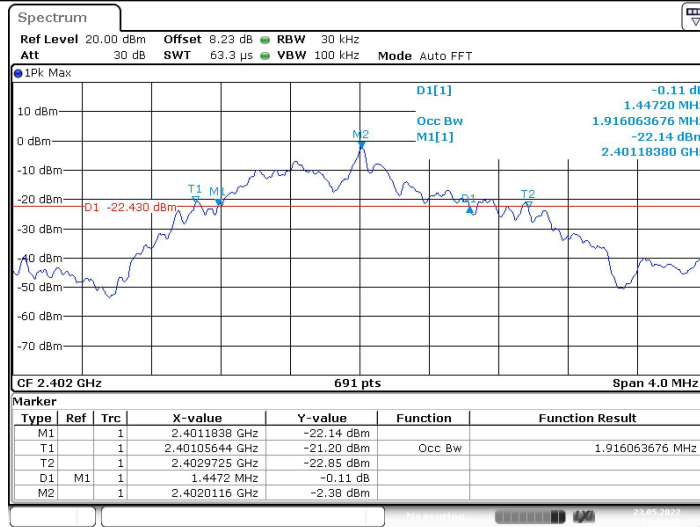

Date: 23.MAY.2022 11:22:22

2446MHz

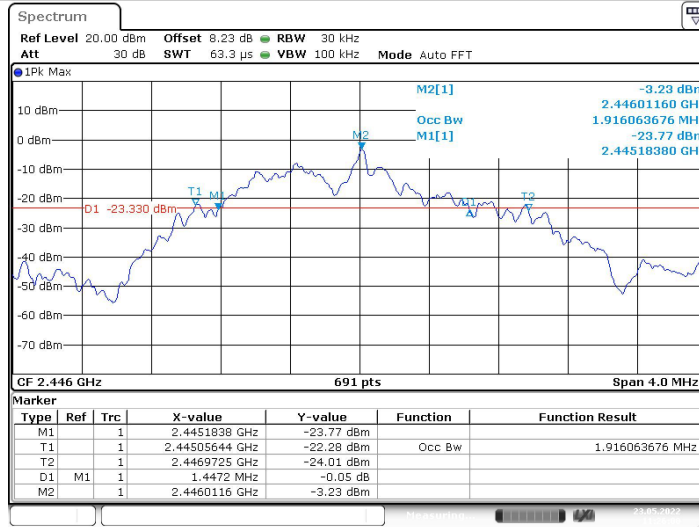

Date: 23.MAY.2022 11:26:00

2479MHz

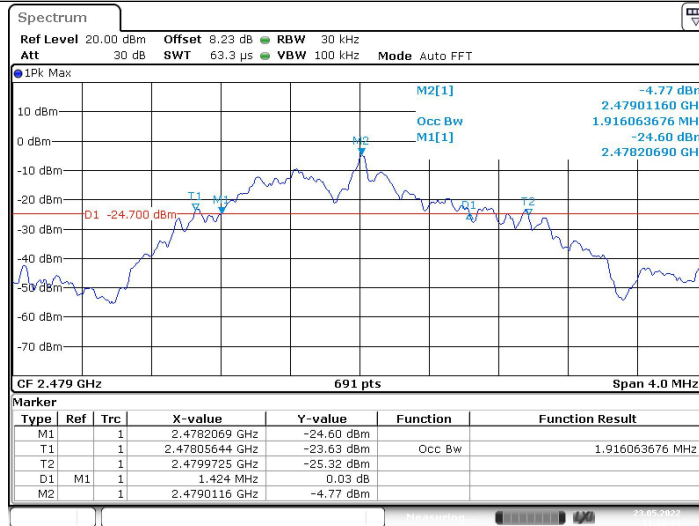

Date: 23.MAY.2022 11:28:34

3.4. Radiated Spurious Emissions

LIMIT

FCC CFR Title 47 Part 15 Subpart C Section 15.209(a) and 15.205(a)

Standard FCC15.249

Fundamental Frequency	Field Strength of Fundamental (millivolts/meter)	Field Strength of Harmonics (microvolts/meter)
900-928MHz	50	500
2400-2483.5MHz	50	500
5725-5875MHz	50	500
24.0-24.25GHz	250	2500

Standard FCC 15.209

Frequency (MHz)	Distance Meters	Field Strengths Limit	
		$\mu V/m$	dB(μV)/m
0.009 ~ 0.490	300	2400/F(kHz)	---
0.490 ~ 1.705	30	24000/F(kHz)	---
1.705 ~ 30	30	30	---
30 ~ 88	3	100	40.0
88 ~ 216	3	150	43.5
216 ~ 960	3	200	46.0
960 ~ 1000	3	500	54.0
Above 1000	3	Other:74.0dB(μV)/m(Peak) 54.0dB(μV)/m (Average)	

Remark: (1) Emission level dB $\mu V = 20 \log$ Emission level $\mu V/m$
 (2) The smaller limit shall apply at the cross point between two frequency bands.
 (3) Distance is the distance in meters between the measuring instrument, antenna and the closest point of any part of the device or system.

FREQUENCY RANGE OF RADIATED MEASUREMENT

Spectrum Parameter	Setting
Start ~Stop Frequency	9KHz~150KHz/RB 200Hz for QP
Start ~Stop Frequency	150KHz~30MHz/RB 9KHz for QP
Start ~Stop Frequency	30MHz~1000MHz/RB 120KHz for QP
Start ~Stop Frequency	1GHz~26.5GHz RBW 1MHz/ VBW 1MHz for Peak, RBW 1MHz/ VBW 10Hz for Average

Receiver Parameter	Setting
Start ~Stop Frequency	9KHz~150KHz/RB 200Hz for QP
Start ~Stop Frequency	150KHz~30MHz/RB 9KHz for QP
Start ~Stop Frequency	30MHz~1000MHz/RB 120KHz for QP

TRF No. FCC Part 15.249_R1

Add : Building 5, No. 316, Jianghong South Road Binjiang District, Hangzhou 310052, China

Tel : +(86) 0571-8836 6861 Fax: +(86) 0571-8836 6821 E-mail : server@ksign.cn Web: www.ksign.cn

Test Configuration

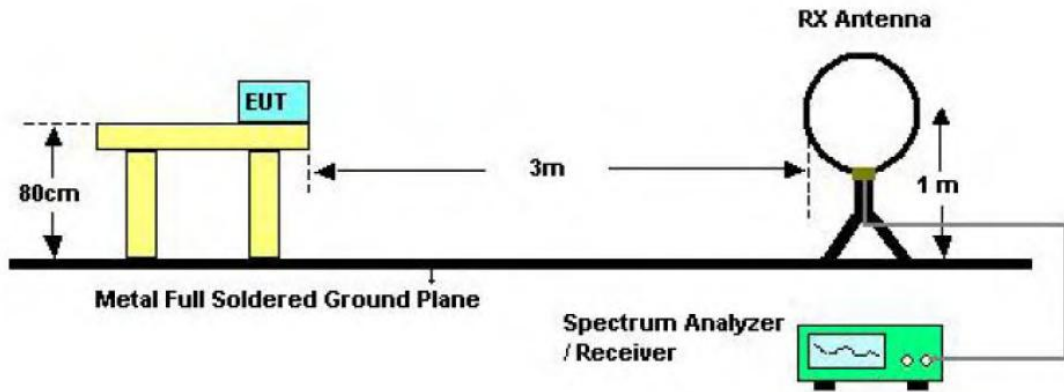

Below 30MHz Test Setup

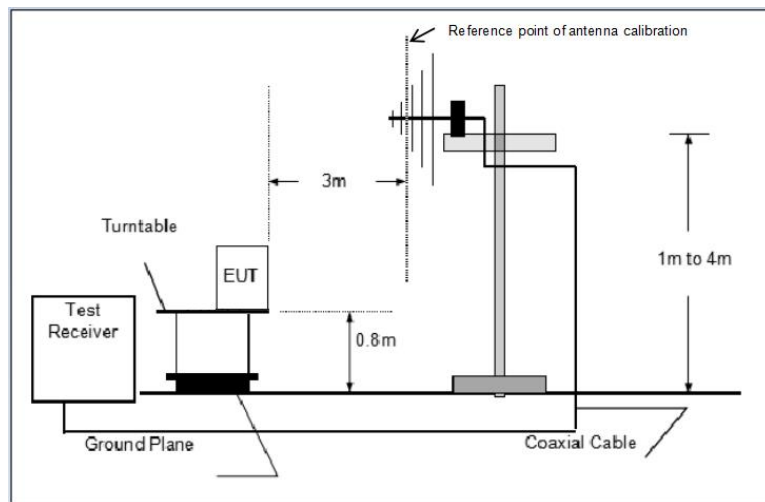

Below 1000MHz Test Setup

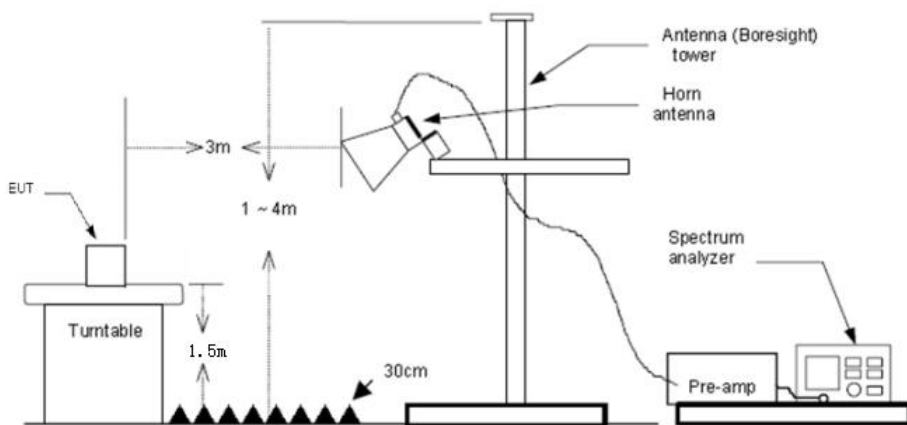

Above 1GHz Test Setup

Test Procedure

1. The EUT was setup and tested according to ANSI C63.10:2013
2. The EUT is placed on a turn table which is 0.8 meter above ground for below 1 GHz, and 1.5 m for above 1 GHz. The turn table is rotated 360 degrees to determine the position of the maximum emission level.
3. The EUT was set 3 meters from the receiving antenna, which was mounted on the top of a variable height antenna tower.
4. For each suspected emission, the EUT was arranged to its worst case and then tune the Antenna tower (from 1 m to 4 m) and turntable (from 0 degree to 360 degrees) to find the maximum reading. A pre-amp and a high pass filter are used for the test in order to get better signal level to comply with the guidelines.
5. Set to the maximum power setting and enable the EUT transmit continuously.
6. Use the following spectrum analyzer settings
 - (1) Span shall wide enough to fully capture the emission being measured;
 - (2) Below 1 GHz:
RBW=120 kHz, VBW=300 kHz, Sweep=auto, Detector function=peak, Trace=max hold;
If the emission level of the EUT measured by the peak detector is 3 dB lower than the applicable limit, the peak emission level will be reported. Otherwise, the emission measurement will be repeated using the quasi-peak detector and reported.
 - (3) From 1 GHz to 10th harmonic:
RBW=1MHz, VBW=3MHz Peak detector for Peak value.
RBW=1MHz, VBW=10Hz RMS detector for Average value.

TEST MODE:

Please refer to the clause 2.3

TEST RESULTS

Passed **Not Applicable**

9 KHz~30 MHz and 18GHz~25GHz

From 9 KHz~30 MHz and 18GHz~25GHz: Conclusion: PASS

Note:

- 1) Final level = Reading level + Correct Factor
Correct Factor=Antenna Factor + Cable Loss -Preamplifier Factor
- 2) The emission levels of other frequencies are very lower than the limit and not show in test report.
- 3) The amplitude of spurious emissions which are attenuated by more than 20dB below the permissible value has no need to be reported.
- 4) Pre-scan 2402MHz, 2437MHz and 2479MHz mode, and found the 2408MHz which it is worse case for 30MHz-1GHz , so only show the test data for worse case.
- 5) Pre-scan 2402MHz, 2437MHz and 2479MHz mode, and found the 2408MHz mode it is worse case for above 1GHz, so only show the test data for worse case.
- 6) 18GHz ~ 25GHz
The EUT was pre-scanned the frequency band (18GHz~25GHz), found the radiated level(Background noise) lower than the limit, so don't show on the report. 3

Radiated field strength of the fundamental signal

Frequency (MHz)	Read Level (dBuV)	Correct Factor (dB/m)	Level (dBuV/m)	Limit Line (dBuV/m)	Over Limit (dBuV/m)	Polarization	Test value
2402	90.42	-10.88	79.54	114	-34.46	Horizontal	Peak
2446	91.05	-10.88	80.17	114	-33.83	Horizontal	Peak
2479	92.66	-10.88	81.78	114	-32.22	Horizontal	Peak
2402	74.43	-10.88	63.55	94	-30.45	Horizontal	AVG
2446	76.69	-10.88	65.81	94	-28.19	Horizontal	AVG
2479	77.42	-10.88	66.54	94	-27.46	Horizontal	AVG

Frequency (MHz)	Read Level (dBuV)	Correct Factor (dB/m)	Level (dBuV/m)	Limit Line (dBuV/m)	Over Limit (dBuV/m)	Polarization	Test value
2402	93.39	-10.88	82.51	114	-31.49	Vertical	Peak
2446	92.95	-10.88	82.07	114	-31.93	Vertical	Peak
2479	95.86	-10.88	84.98	114	-29.02	Vertical	Peak
2402	75.40	-10.88	64.52	94	-29.48	Vertical	AVG
2446	73.47	-10.88	62.59	94	-31.41	Vertical	AVG
2479	71.72	-10.88	60.84	94	-33.16	Vertical	AVG

Note:

Correct Factor=Antenna Factor + Cable Loss -Preamplifier Factor

RADIATED EMISSION BELOW 30MHZ

No emission found between lowest internal used/generated frequencies to 30MHz.

30MHz-1GHz

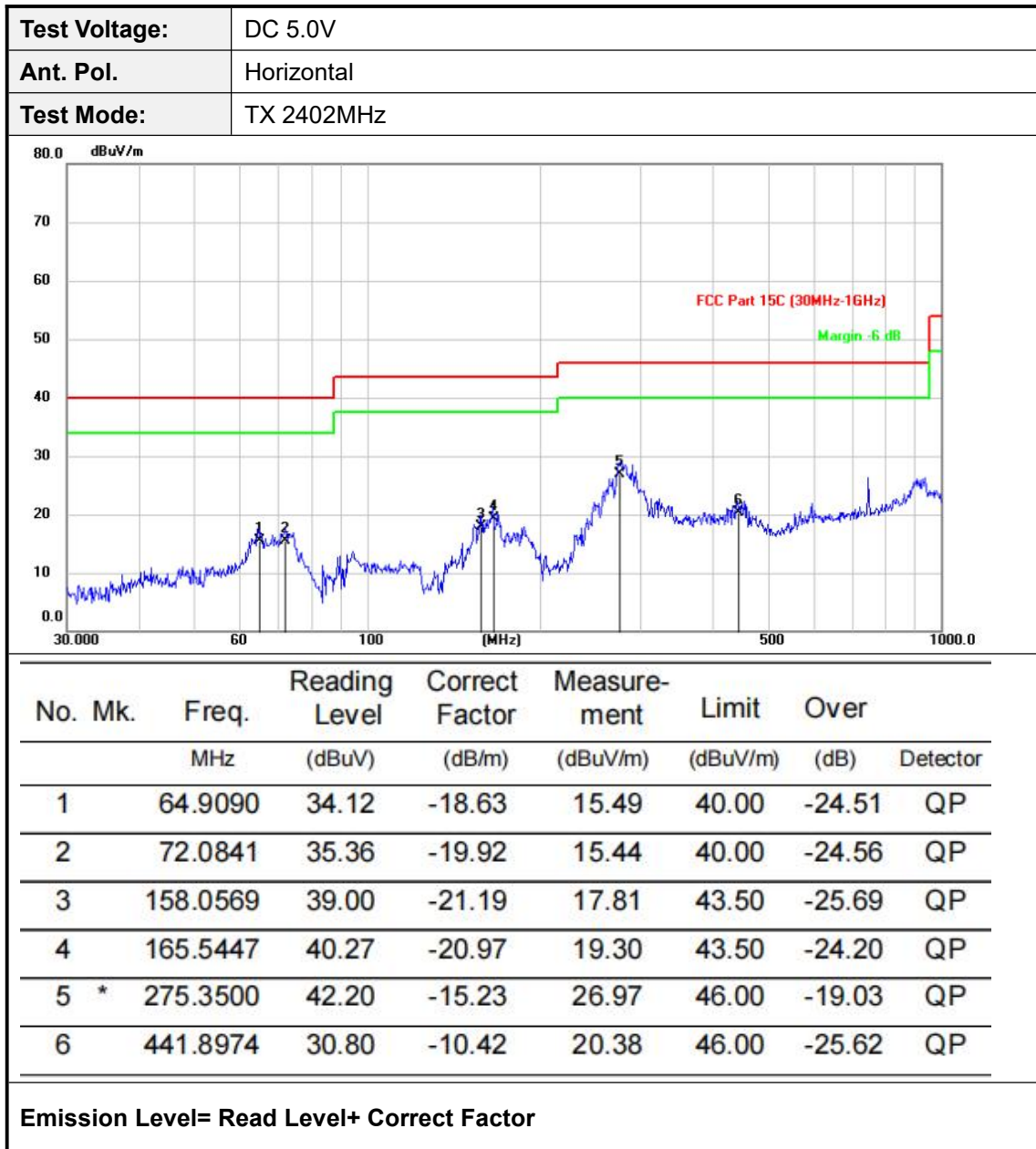

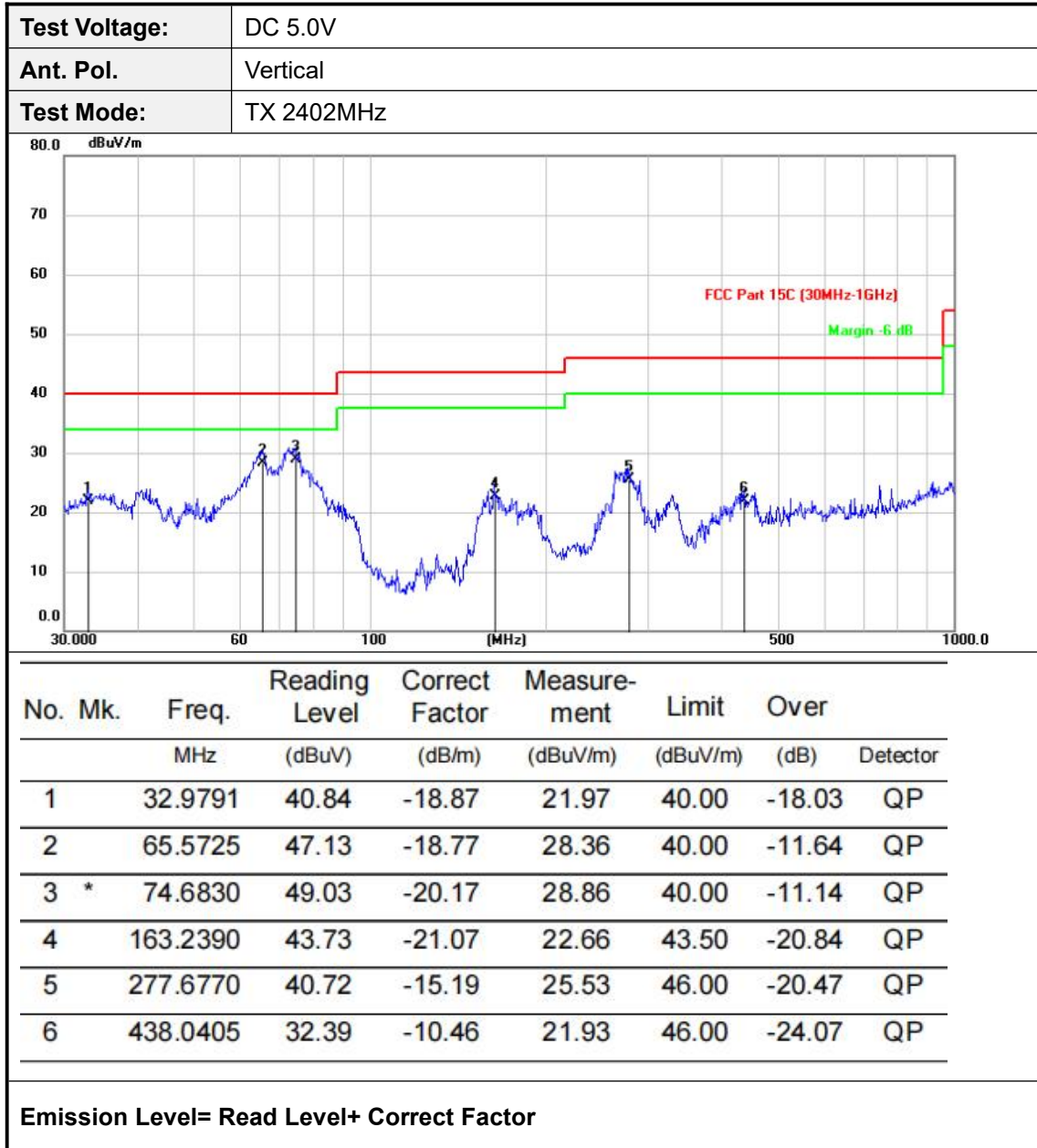

Above 1GHz

Frequency(MHz):		2402		Polarity:		HORIZONTAL
Frequency (MHz)	Reading Level (dBuV/m)	Correc Factor (dB/m)	Measurement (dBuV/m)	Limit (dBuV/m)	Over (dB)	Detector
4804.00	60.10	-5.92	54.18	74	19.82	PK
4804.00	43.71	-5.92	37.79	54	16.21	AV
7206.00	52.50	-1.81	50.69	74	23.31	PK
7206.00	42.24	-1.81	40.43	54	13.57	AV

Frequency(MHz):		2402		Polarity:		VERTICAL
Frequency (MHz)	Reading Level (dBuV/m)	Correc Factor (dB/m)	Measurement (dBuV/m)	Limit (dBuV/m)	Over (dB)	Detector
4804.00	53.48	-5.92	47.56	74	26.44	PK
4804.00	43.72	-5.92	37.80	54	16.20	AV
7206.00	52.23	-1.81	50.42	74	23.58	PK
7206.00	39.77	-1.81	37.96	54	16.04	AV

Frequency(MHz):		2446		Polarity:		HORIZONTAL
Frequency (MHz)	Reading Level (dBuV/m)	Correc Factor (dB/m)	Measurement (dBuV/m)	Limit (dBuV/m)	Over (dB)	Detector
4892.00	53.61	-5.71	47.90	74	26.10	PK
4892.00	43.55	-5.71	37.84	54	16.16	AV
7338.00	51.96	-0.36	51.60	74	22.40	PK
7338.00	38.43	-0.36	38.07	54	15.93	AV

Frequency(MHz):		2446		Polarity:		VERTICAL
Frequency (MHz)	Reading Level (dBuV/m)	Correc Factor (dB/m)	Measurement (dBuV/m)	Limit (dBuV/m)	Over (dB)	Detector
4892.00	53.88	-5.71	48.17	74	25.83	PK
4892.00	44.15	-5.71	38.44	54	15.56	AV
7338.00	52.62	-0.36	52.26	74	21.74	PK
7338.00	38.7	-0.36	38.34	54	15.66	AV

Frequency(MHz):		2479		Polarity:		HORIZONTAL
Frequency (MHz)	Reading Level (dBuV/m)	Correc Factor (dB/m)	Measurement (dBuV/m)	Limit (dBuV/m)	Over (dB)	Detector
4958.00	51.68	-5.51	46.17	74	27.83	PK
4958.00	42.89	-5.51	37.38	54	16.62	AV
7437.00	51.2	0.99	52.19	74	21.81	PK
7437.00	37.83	0.99	38.82	54	15.18	AV

Frequency(MHz):		2479		Polarity:		VERTICAL
Frequency (MHz)	Reading Level (dBuV/m)	Correc Factor (dB/m)	Measurement (dBuV/m)	Limit (dBuV/m)	Over (dB)	Detector
4958.00	52.64	-5.51	47.13	74	26.87	PK
4958.00	42.69	-5.51	37.18	54	16.82	AV
7437.00	51.42	0.99	52.41	74	21.59	PK
7437.00	38.95	0.99	39.94	54	14.06	AV

Note:

- 1.Above 18GHz is the background of the site, there is no radiated spurious.

3.5. Band Edge Emissions(Radiated)

Test Configuration

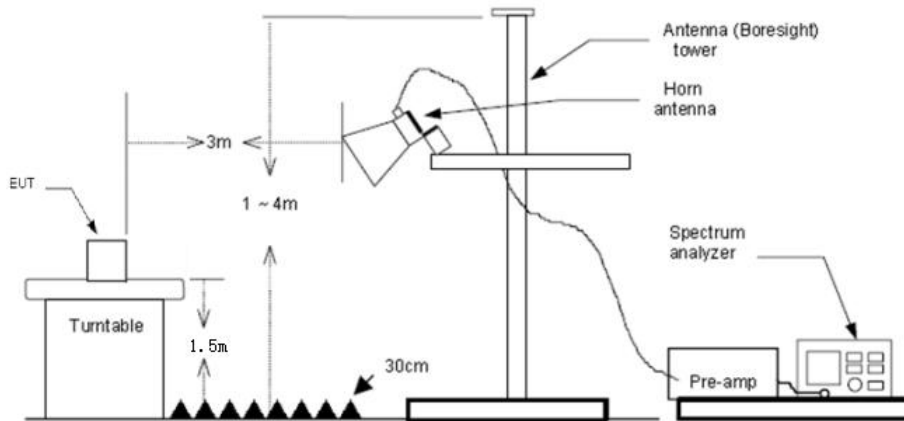

Test Procedure

1. The EUT was setup and tested according to ANSI C63.10:2013
2. The EUT is placed on a turn table which is 0.8 meter above ground for below 1 GHz, and 1.5 m for above 1 GHz. The turn table is rotated 360 degrees to determine the position of the maximum emission level.
3. The EUT was set 3 meters from the receiving antenna, which was mounted on the top of a variable height antenna tower.
4. For each suspected emission, the EUT was arranged to its worst case and then tune the Antenna tower (from 1 m to 4 m) and turntable (from 0 degree to 360 degrees) to find the maximum reading. A pre-amp and a high pass filter are used for the test in order to get better signal level to comply with the guidelines.
5. Set to the maximum power setting and enable the EUT transmit continuously.
6. Use the following spectrum analyzer settings
 - (1) Span shall wide enough to fully capture the emission being measured;
 - RBW=1MHz, VBW=3MHz PEAK detector for Peak value.
 - RBW=1MHz, VBW=10Hz with Average Detector for Average Value.

Test Mode

Please refer to the clause 2.3.

Test Results

Frequency(MHz):		2402		Polarity:		HORIZONTAL
Frequency (MHz)	Reading Level (dBuV/m)	Correc Factor (dB/m)	Measurement (dBuV/m)	Limit (dBuV/m)	Over (dB)	Detector
2390.00	56.97	-10.92	46.05	74	27.95	PK
2390.00	41.57	-10.92	30.65	54	23.35	AV

Frequency(MHz):		2402		Polarity:		HORIZONTAL
Frequency (MHz)	Reading Level (dBuV/m)	Correc Factor (dB/m)	Measurement (dBuV/m)	Limit (dBuV/m)	Over (dB)	Detector
2390.00	51.43	-10.92	40.51	74	33.49	PK
2390.00	40.80	-10.92	29.88	54	24.12	AV

TRF No. FCC Part 15.249_R1

Add : Building 5, No. 316, Jianghong South Road Binjiang District, Hangzhou 310052, China

Tel : +(86) 0571-8836 6861 Fax: +(86) 0571-8836 6821 E-mail : server@ksign.cn Web: www.ksign.cn

Frequency(MHz):		2479		Polarity:		HORIZONTAL
Frequency (MHz)	Reading Level (dBuV/m)	Correc Factor (dB/m)	Measurement (dBuV/m)	Limit (dBuV/m)	Over (dB)	Detector
2483.50	60.72	-10.88	49.84	74	24.16	PK
2483.50	40.66	-10.88	29.78	54	24.22	AV

Frequency(MHz):		2479		Polarity:		HORIZONTAL
Frequency (MHz)	Reading Level (dBuV/m)	Correc Factor (dB/m)	Measurement (dBuV/m)	Limit (dBuV/m)	Over (dB)	Detector
2483.50	59.69	-10.88	48.81	74	25.19	PK
2483.50	40.02	-10.88	29.14	54	24.86	AV

Note:

- 1) Level (dBμV/m)= Reading (dBμV)+ Factor (dB/m)
- 2) Factor(dB/m)=Antenna Factor (dB/m) + Cable loss (dB) - Pre Amplifier gain (dB)

4.EUT TEST PHOTOS

Radiated Measurement (Below 1GHz)



Radiated Measurement (Above 1GHz)



Conducted Emission

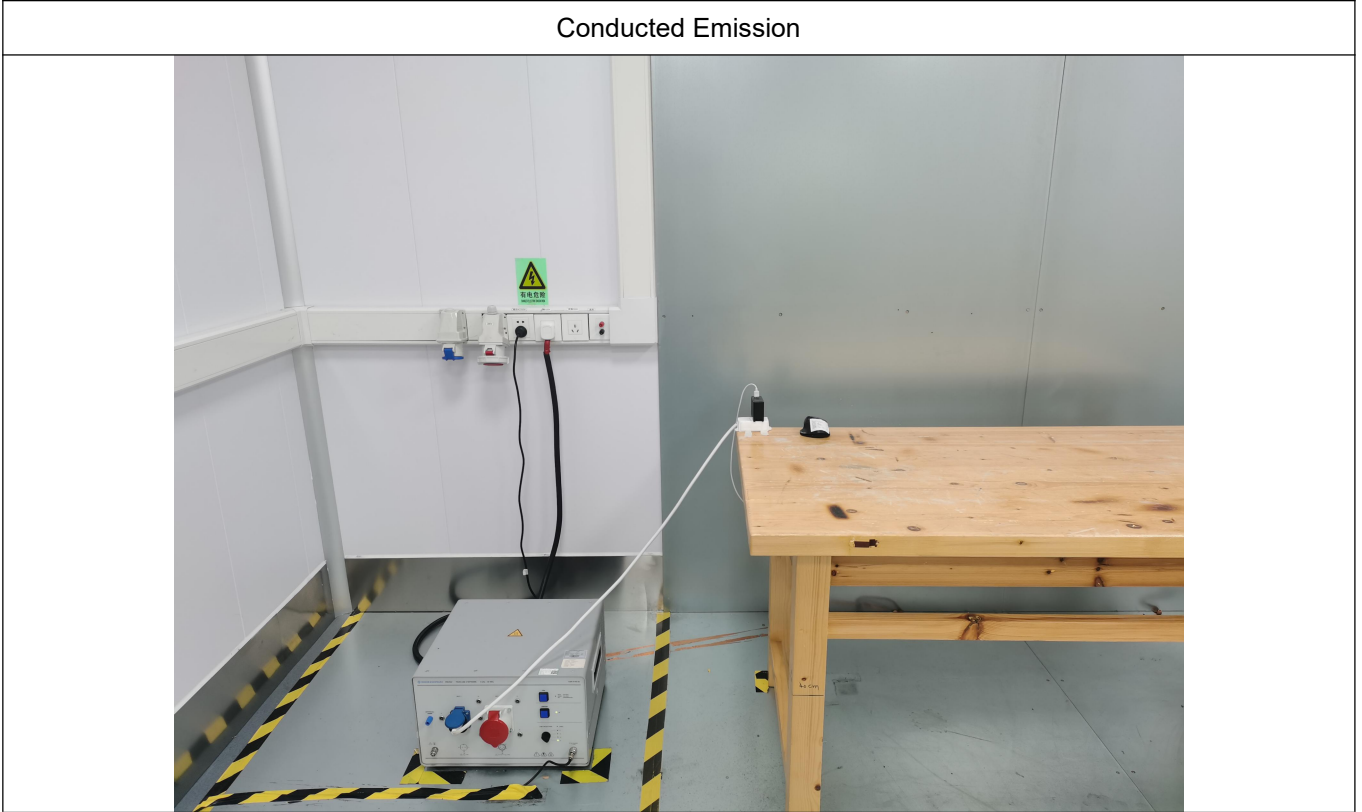

5. PHOTOGRAPHS OF EUT CONSTRUCTIONAL

External Photographs

Photo 1



Photo 2

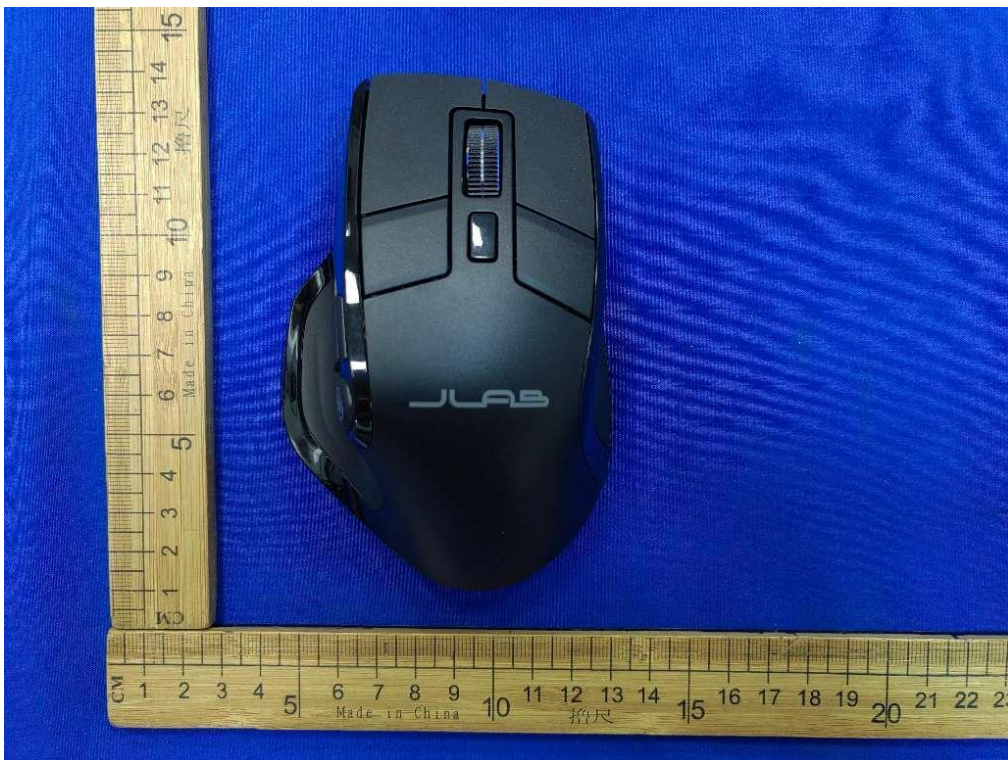

Photo 3



Photo 4



Photo 5



Photo 6



Photo 7



Photo 8



Internal Photographs

Photo 1



Photo 2



Photo 3

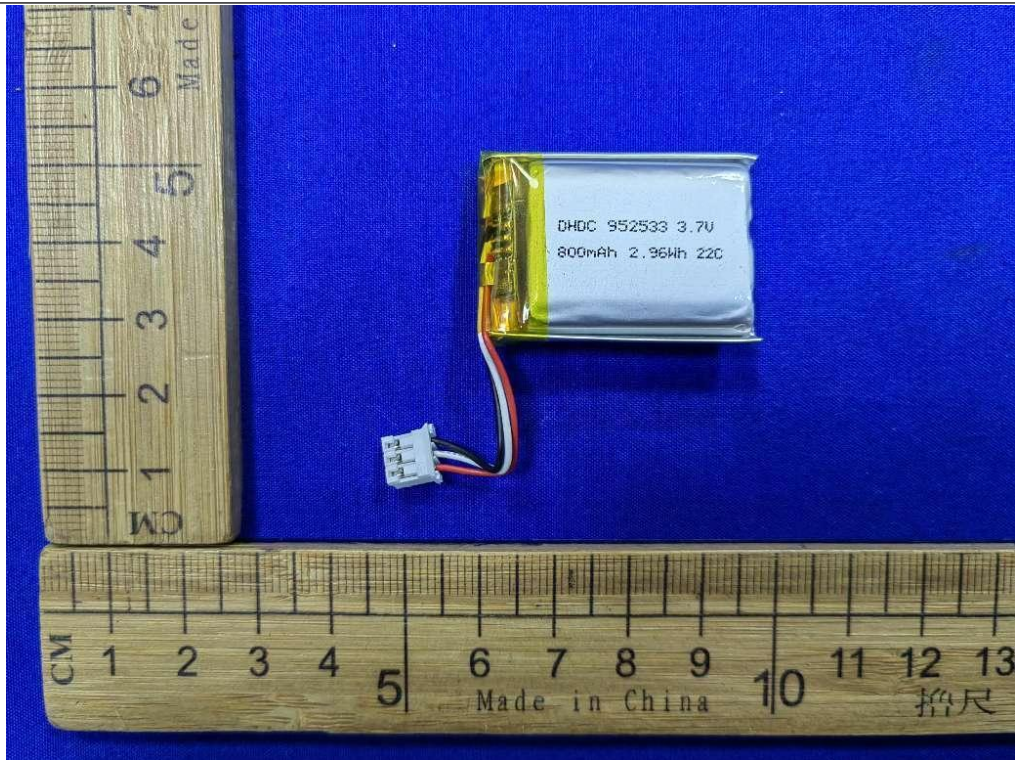

Photo 4

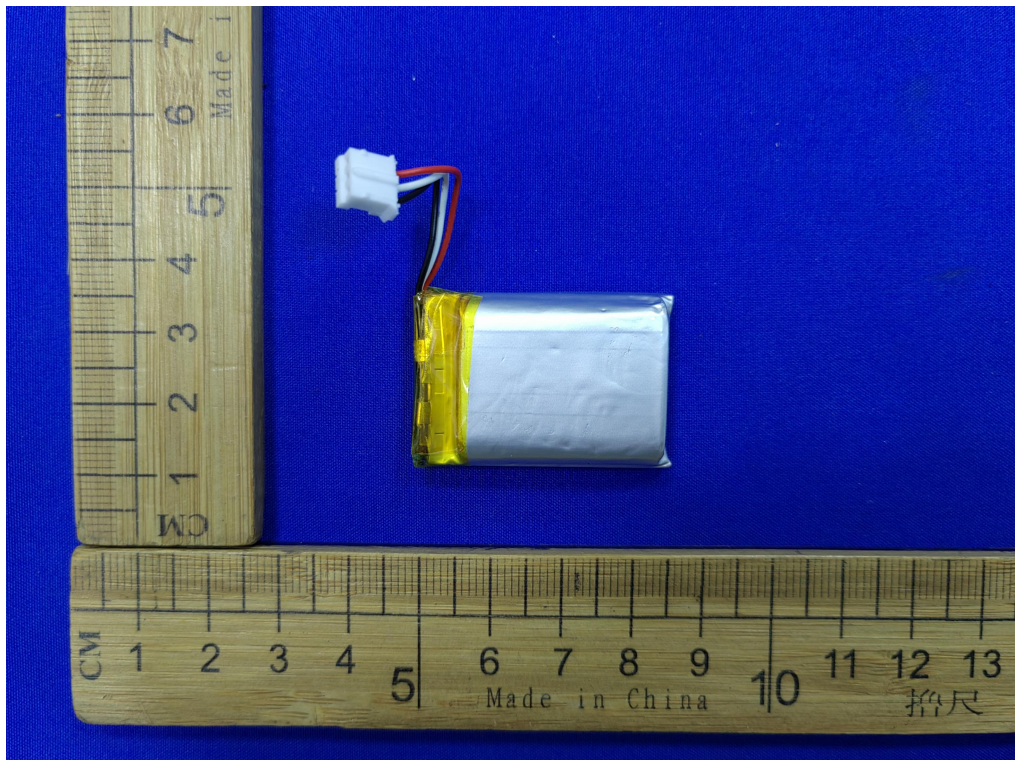

Photo 5

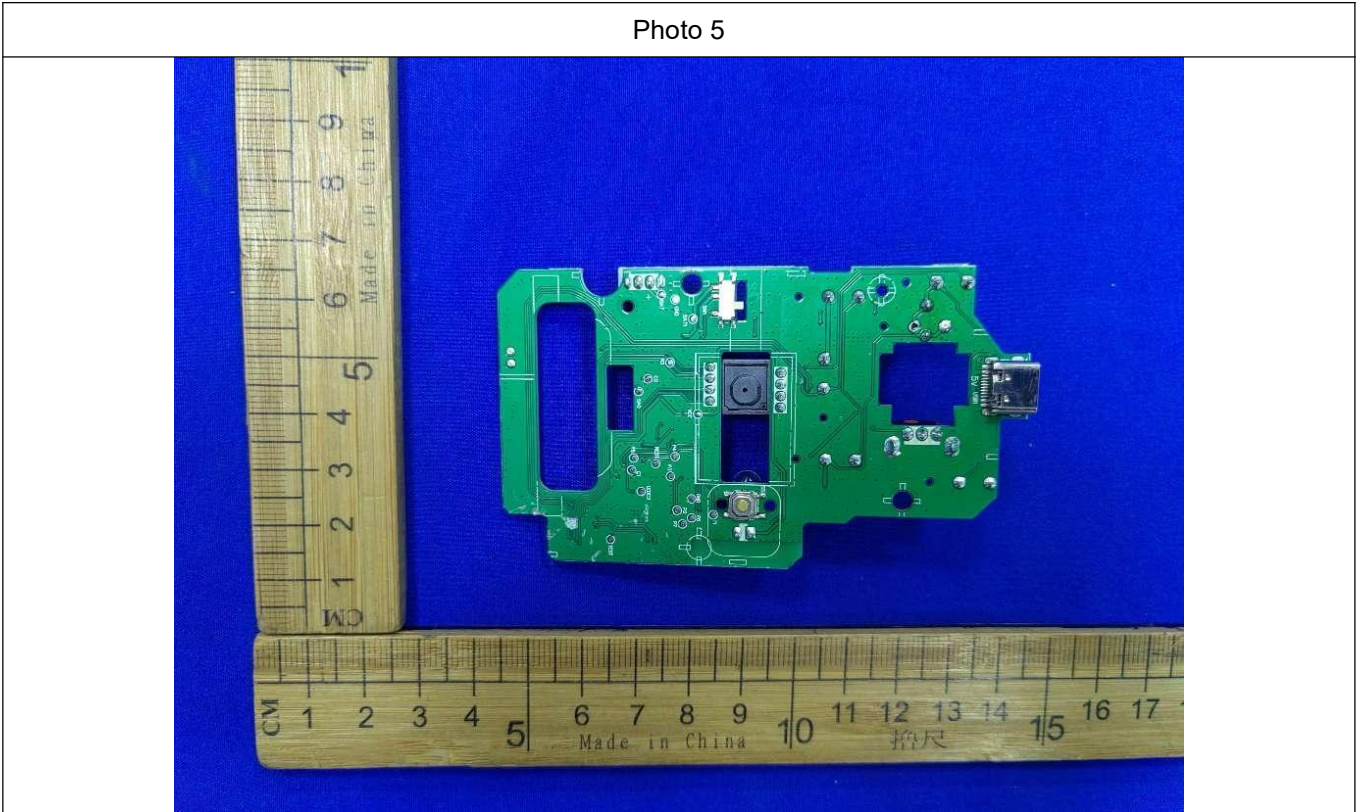

Photo 6

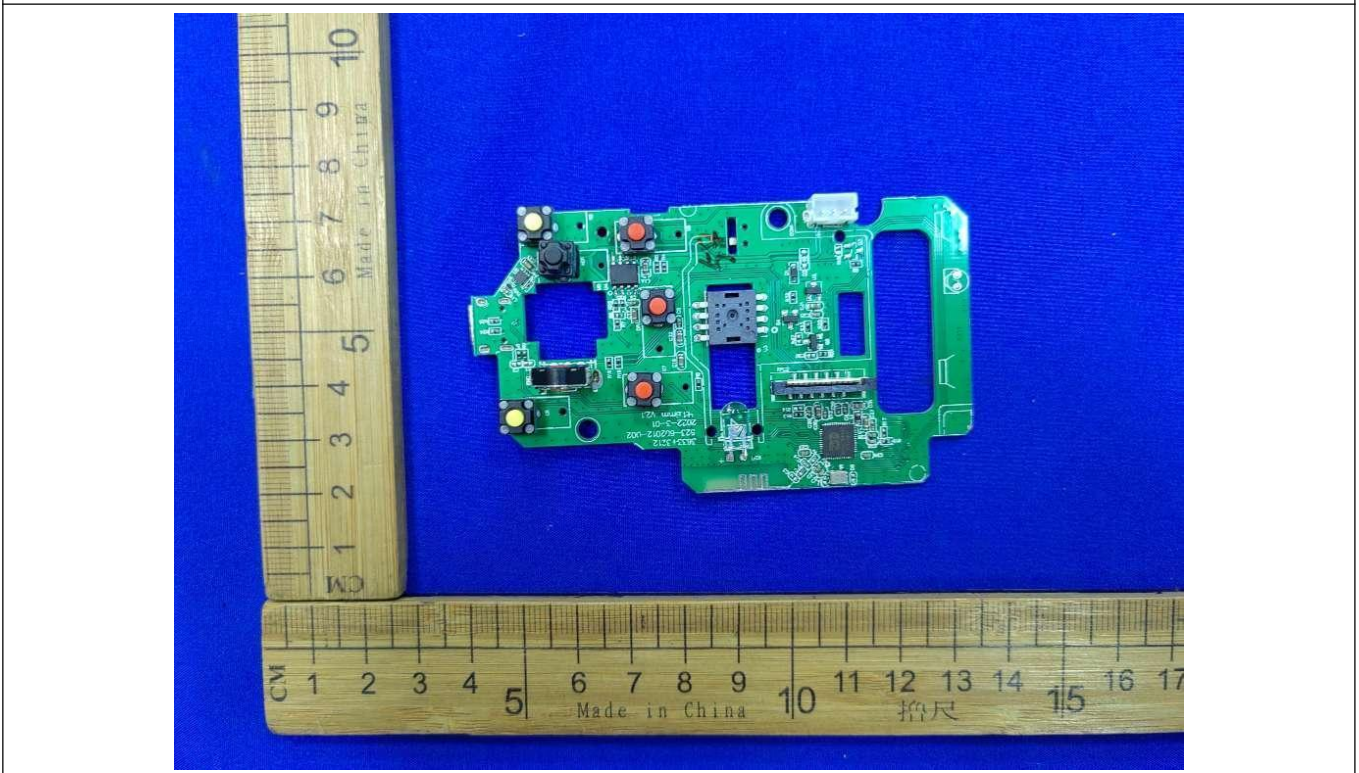
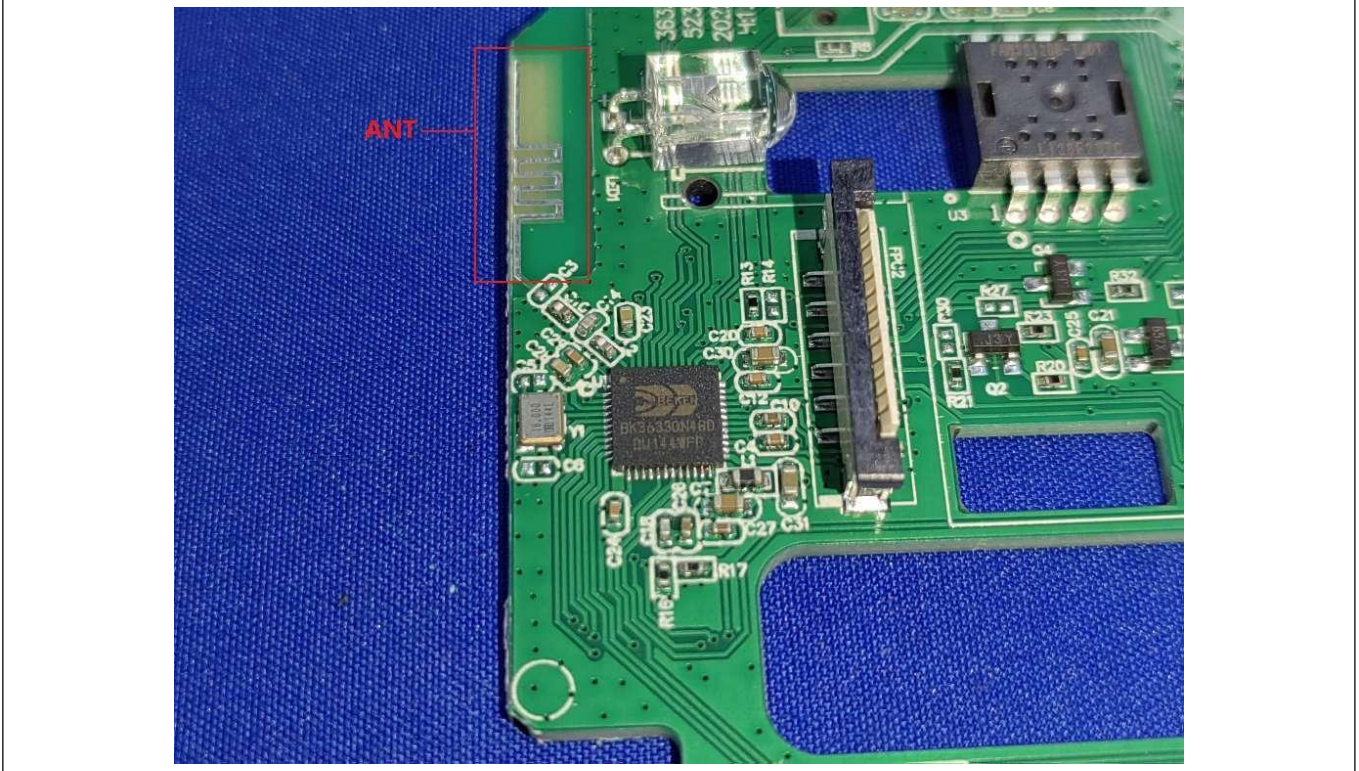

Photo 7



--THE END--