

TEST REPORT

Applicant: SHENZHEN GIEC DIGITAL CO., LTD

Address of Applicant: 1st&3rd Building, No.26 Puzai Road, Pingdi, Longgang District, Shenzhen, China

Manufacturer: SHENZHEN GIEC DIGITAL CO., LTD

Address of Manufacturer: 1st&3rd Building, No.26 Puzai Road, Pingdi, Longgang District, Shenzhen, China

Factory: SHENZHEN JOWAY POWER SUPPLY CO., LTD

Address of Factory: Building 11, antuoshan hi tech Industrial Park, Shaer community, Shajing street, Bao'an District, Shenzhen, China

Equipment Under Test (EUT)

Product Name: True Wireless Earbuds

Model No.: Z3001

FCC ID: 2AHYK-GIECZ3001

Applicable standards: FCC CFR Title 47 Part 15 Subpart C Section 15.247

Date of sample receipt: March 30, 2023

Date of Test: March 31, 2023-April 13, 2023

Date of report issued: April 13, 2023

Test Result : PASS *

* In the configuration tested, the EUT complied with the standards specified above.

Authorized Signature:



Robinson Luo
Laboratory Manager

This results shown in this test report refer only to the sample(s) tested, this test report cannot be reproduced, except in full, without prior written permission of the company. The report would be invalid without specific stamp of test institute and the signatures of compiler and approver.

2 Version

| Version No. | Date | Description |
|-------------|----------------|-------------|
| 00 | April 13, 2023 | Original |
| | | |
| | | |
| | | |
| | | |

Prepared By:

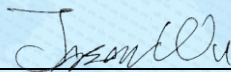

Project Engineer

Date:

April 13, 2023

Check By:



Reviewer

Date:

April 13, 2023

3 Contents

| | Page |
|--|------|
| 1 COVER PAGE..... | 1 |
| 2 VERSION..... | 2 |
| 3 CONTENTS | 3 |
| 4 TEST SUMMARY | 4 |
| 5 GENERAL INFORMATION..... | 5 |
| 5.1 GENERAL DESCRIPTION OF EUT | 5 |
| 5.2 TEST MODE | 7 |
| 5.3 DESCRIPTION OF SUPPORT UNITS | 7 |
| 5.4 DEVIATION FROM STANDARDS..... | 7 |
| 5.5 ABNORMALITIES FROM STANDARD CONDITIONS | 7 |
| 5.6 TEST FACILITY..... | 7 |
| 5.7 TEST LOCATION | 7 |
| 5.8 ADDITIONAL INSTRUCTIONS..... | 7 |
| 6 TEST INSTRUMENTS LIST | 8 |
| 7 TEST RESULTS AND MEASUREMENT DATA..... | 10 |
| 7.1 ANTENNA REQUIREMENT | 10 |
| 7.2 CONDUCTED EMISSIONS | 11 |
| 7.3 CONDUCTED PEAK OUTPUT POWER | 14 |
| 7.4 20dB EMISSION BANDWIDTH | 15 |
| 7.5 CARRIER FREQUENCIES SEPARATION..... | 16 |
| 7.6 HOPPING CHANNEL NUMBER | 17 |
| 7.7 DWELL TIME..... | 18 |
| 7.8 SPURIOUS EMISSION IN NON-RESTRICTED & RESTRICTED BANDS | 19 |
| 7.8.1 Conducted Emission Method..... | 19 |
| 7.8.2 Radiated Emission Method..... | 20 |
| 8 TEST SETUP PHOTO..... | 35 |
| 9 EUT CONSTRUCTIONAL DETAILS | 35 |

4 Test Summary

| Test Item | Section in CFR 47 | Result |
|----------------------------------|--------------------|--------|
| Antenna Requirement | 15.203/15.247 (c) | Pass |
| AC Power Line Conducted Emission | 15.207 | Pass |
| Conducted Peak Output Power | 15.247 (b)(1) | Pass |
| 20dB Occupied Bandwidth | 15.247 (a)(1) | Pass |
| Carrier Frequencies Separation | 15.247 (a)(1) | Pass |
| Hopping Channel Number | 15.247 (a)(1)(iii) | Pass |
| Dwell Time | 15.247 (a)(1)(iii) | Pass |
| Radiated Emission | 15.205/15.209 | Pass |
| Band Edge | 15.247(d) | Pass |

Remarks:

1. Pass: The EUT complies with the essential requirements in the standard.
2. Test according to ANSI C63.10:2013

Measurement Uncertainty

| Test Item | Frequency Range | Measurement Uncertainty | Notes |
|----------------------------------|-----------------|-------------------------|-------|
| Radiated Emission | 9kHz-30MHz | 3.1dB | (1) |
| Radiated Emission | 30MHz-200MHz | 3.8039dB | (1) |
| Radiated Emission | 200MHz-1GHz | 3.9679dB | (1) |
| Radiated Emission | 1GHz-18GHz | 4.29dB | (1) |
| Radiated Emission | 18GHz-40GHz | 3.30dB | (1) |
| AC Power Line Conducted Emission | 0.15MHz ~ 30MHz | 3.44dB | (1) |

Note (1): The measurement uncertainty is for coverage factor of k=2 and a level of confidence of 95%.

5 General Information

5.1 General Description of EUT

| | |
|----------------------|--|
| Product Name: | True Wireless Earbuds |
| Model No.: | Z3001 |
| Test sample(s) ID: | GTS2023030508-1 |
| Sample(s) Status: | Engineer sample |
| Serial No.: | GIECZ3001X23050100001 |
| Operation Frequency: | 2402MHz~2480MHz |
| Channel numbers: | 79 |
| Channel separation: | 1MHz |
| Modulation type: | GFSK, $\pi/4$ -DQPSK |
| Antenna Type: | Chip Antenna |
| Antenna gain: | 2.16dBi |
| Power supply: | Charge box: DC 3.7V, 300mAh, 1.11Wh for Li-ion battery Earphone: Battery DC 3.7V, 25mAh, 0.0925Wh for Li-ion battery The battery is charged via USB DC5V |

| Operation Frequency each of channel | | | | | | | |
|-------------------------------------|-----------|---------|-----------|---------|-----------|---------|-----------|
| Channel | Frequency | Channel | Frequency | Channel | Frequency | Channel | Frequency |
| 1 | 2402MHz | 21 | 2422MHz | 41 | 2442MHz | 61 | 2462MHz |
| 2 | 2403MHz | 22 | 2423MHz | 42 | 2443MHz | 62 | 2463MHz |
| 3 | 2404MHz | 23 | 2424MHz | 43 | 2444MHz | 63 | 2464MHz |
| 4 | 2405MHz | 24 | 2425MHz | 44 | 2445MHz | 64 | 2465MHz |
| 5 | 2406MHz | 25 | 2426MHz | 45 | 2446MHz | 65 | 2466MHz |
| 6 | 2407MHz | 26 | 2427MHz | 46 | 2447MHz | 66 | 2467MHz |
| 7 | 2408MHz | 27 | 2428MHz | 47 | 2448MHz | 67 | 2468MHz |
| 8 | 2409MHz | 28 | 2429MHz | 48 | 2449MHz | 68 | 2469MHz |
| 9 | 2410MHz | 29 | 2430MHz | 49 | 2450MHz | 69 | 2470MHz |
| 10 | 2411MHz | 30 | 2431MHz | 50 | 2451MHz | 70 | 2471MHz |
| 11 | 2412MHz | 31 | 2432MHz | 51 | 2452MHz | 71 | 2472MHz |
| 12 | 2413MHz | 32 | 2433MHz | 52 | 2453MHz | 72 | 2473MHz |
| 13 | 2414MHz | 33 | 2434MHz | 53 | 2454MHz | 73 | 2474MHz |
| 14 | 2415MHz | 34 | 2435MHz | 54 | 2455MHz | 74 | 2475MHz |
| 15 | 2416MHz | 35 | 2436MHz | 55 | 2456MHz | 75 | 2476MHz |
| 16 | 2417MHz | 36 | 2437MHz | 56 | 2457MHz | 76 | 2477MHz |
| 17 | 2418MHz | 37 | 2438MHz | 57 | 2458MHz | 77 | 2478MHz |
| 18 | 2419MHz | 38 | 2439MHz | 58 | 2459MHz | 78 | 2479MHz |
| 19 | 2420MHz | 39 | 2440MHz | 59 | 2460MHz | 79 | 2480MHz |
| 20 | 2421MHz | 40 | 2441MHz | 60 | 2461MHz | X | |

Note:

In section 15.31(m), regards to the operating frequency range over 10 MHz, the Lowest frequency, the middle frequency, and the highest frequency of channel were selected to perform the test, and the selected channel see below:

| Channel | Frequency |
|---------------------|-----------|
| The lowest channel | 2402MHz |
| The middle channel | 2441MHz |
| The Highest channel | 2480MHz |

5.2 Test mode

| | |
|-------------------|---|
| Transmitting mode | Keep the EUT in continuously transmitting mode. |
|-------------------|---|

5.3 Description of Support Units

| |
|-------|
| None. |
|-------|

5.4 Deviation from Standards

| |
|-------|
| None. |
|-------|

5.5 Abnormalities from Standard Conditions

| |
|-------|
| None. |
|-------|

5.6 Test Facility

| |
|--|
| <p>The test facility is recognized, certified, or accredited by the following organizations:</p> <ul style="list-style-type: none"> ● FCC—Registration No.: 381383 Designation Number: CN5029 Global United Technology Services Co., Ltd., Shenzhen EMC Laboratory has been registered and fully described in a report filed with the (FCC) Federal Communications Commission. The acceptance letter from the FCC is maintained in files. ● IC —Registration No.: 9079A CAB identifier: CN0091 The 3m Semi-anechoic chamber of Global United Technology Services Co., Ltd. has been registered by Certification and Engineering Bureau of Industry Canada for radio equipment testing ● NVLAP (LAB CODE:600179-0) Global United Technology Services Co., Ltd., is accredited by the National Voluntary Laboratory Accreditation Program (NVLAP). |
|--|

5.7 Test Location

| |
|---|
| All tests were performed at: |
| <p>Global United Technology Services Co., Ltd. Address: No. 123-128, Tower A, Jinyuan Business Building, No.2, Laodong Industrial Zone, Xixiang Road, Baoan District, Shenzhen, Guangdong, China 518102 Tel: 0755-27798480 Fax: 0755-27798960</p> |

5.8 Additional Instructions

| | |
|-------------------|--|
| Test Software | Special test software provided by manufacturer |
| Power level setup | Default |

6 Test Instruments list

| Radiated Emission: | | | | | | |
|--------------------|-------------------------------------|--------------------------------|-----------------------------|---------------|---------------------|-------------------------|
| Item | Test Equipment | Manufacturer | Model No. | Inventory No. | Cal.Date (mm-dd-yy) | Cal.Due date (mm-dd-yy) |
| 1 | 3m Semi- Anechoic Chamber | ZhongYu Electron | 9.2(L)*6.2(W)* 6.4(H) | GTS250 | July 02, 2020 | July 01, 2025 |
| 2 | Control Room | ZhongYu Electron | 6.2(L)*2.5(W)* 2.4(H) | GTS251 | N/A | N/A |
| 3 | EMI Test Receiver | Rohde & Schwarz | ESU26 | GTS203 | April 22, 2022 | April 21, 2023 |
| 4 | BiConiLog Antenna | SCHWARZBECK MESS-ELEKTRONIK | VULB9168 | GTS640 | March 20, 2023 | March 19, 2025 |
| 5 | Double -ridged waveguide horn | SCHWARZBECK MESS-ELEKTRONIK | BBHA 9120 D | GTS208 | June 12, 2022 | June 11, 2023 |
| 6 | Horn Antenna | ETS-LINDGREN | 3160 | GTS217 | June 23, 2022 | June 22, 2023 |
| 7 | EMI Test Software | AUDIX | E3 | N/A | N/A | N/A |
| 8 | Coaxial Cable | GTS | N/A | GTS213 | April 22, 2022 | April 21, 2023 |
| 9 | Coaxial Cable | GTS | N/A | GTS211 | April 22, 2022 | April 21, 2023 |
| 10 | Coaxial cable | GTS | N/A | GTS210 | April 22, 2022 | April 21, 2023 |
| 11 | Coaxial Cable | GTS | N/A | GTS212 | April 22, 2022 | April 21, 2023 |
| 12 | Amplifier(100kHz-3GHz) | HP | 8347A | GTS204 | April 22, 2022 | April 21, 2023 |
| 13 | Amplifier (18-26GHz) | Rohde & Schwarz | AFS33-18002 650-30-8P-44 | GTS218 | June 23, 2022 | June 22, 2023 |
| 14 | Band filter | Amindeon | 82346 | GTS219 | June 23, 2022 | June 22, 2023 |
| 15 | Power Meter | Anritsu | ML2495A | GTS540 | June 23, 2022 | June 22, 2023 |
| 16 | Power Sensor | Anritsu | MA2411B | GTS541 | June 23, 2022 | June 22, 2023 |
| 17 | Wideband Radio Communication Tester | Rohde & Schwarz | CMW500 | GTS575 | April 22, 2022 | April 21, 2023 |
| 18 | Splitter | Agilent | 11636B | GTS237 | June 23, 2022 | June 22, 2023 |
| 19 | Loop Antenna | ZHINAN | ZN30900A | GTS534 | Nov. 29, 2022 | Nov. 28, 2023 |
| 20 | Broadband Preamplifier | SCHWARZBECK | BBV9718 | GTS535 | April 22, 2022 | April 21, 2023 |
| 21 | Breitband hornantenna | SCHWARZBECK | BBHA 9170 | GTS579 | Oct. 16, 2022 | Oct. 15, 2023 |
| 22 | Amplifier | TDK | PA-02-02 | GTS574 | Oct. 16, 2022 | Oct. 15, 2023 |
| 23 | Amplifier | TDK | PA-02-03 | GTS576 | Oct. 16, 2022 | Oct. 15, 2023 |
| 24 | PSA Series Spectrum Analyzer | Rohde & Schwarz | FSP | GTS578 | June 23, 2022 | June 22, 2023 |
| 25 | Amplifier(1GHz-26.5GHz) | HP | 8449B | GTS601 | April 22, 2022 | April 21, 2023 |

| Conducted Emission | | | | | | |
|--------------------|---------------------------|-------------------------|----------------------|---------------|---------------------|-------------------------|
| Item | Test Equipment | Manufacturer | Model No. | Inventory No. | Cal.Date (mm-dd-yy) | Cal.Due date (mm-dd-yy) |
| 1 | Shielding Room | ZhongYu Electron | 7.3(L)x3.1(W)x2.9(H) | GTS252 | May 14, 2022 | May 13, 2025 |
| 2 | EMI Test Receiver | R&S | ESCI 7 | GTS552 | April 24, 2022 | April 23, 2023 |
| 3 | Coaxial Switch | ANRITSU CORP | MP59B | GTS225 | June 23, 2022 | June 22, 2023 |
| 4 | ENV216 2-L-V-NETZNACHB.DE | ROHDE&SCHWARZ | ENV216 | GTS226 | April 22, 2022 | April 21, 2023 |
| 5 | Coaxial Cable | GTS | N/A | GTS227 | N/A | N/A |
| 6 | EMI Test Software | AUDIX | E3 | N/A | N/A | N/A |
| 7 | Thermo meter | JINCHUANG | GSP-8A | GTS639 | April 28, 2022 | April 27, 2023 |
| 8 | Absorbing clamp | Elektronik-Feinmechanik | MDS21 | GTS229 | April 15, 2022 | April 14, 2023 |
| 9 | ISN | SCHWARZBECK | NTFM 8158 | GTS565 | April 22, 2022 | April 21, 2023 |
| 10 | High voltage probe | SCHWARZBECK | TK9420 | GTS537 | April 22, 2022 | April 21, 2023 |

| RF Conducted Test: | | | | | | |
|--------------------|--|--------------|------------------|------------|---------------------|-------------------------|
| Item | Test Equipment | Manufacturer | Model No. | Serial No. | Cal.Date (mm-dd-yy) | Cal.Due date (mm-dd-yy) |
| 1 | MXA Signal Analyzer | Agilent | N9020A | GTS566 | April 22, 2022 | April 21, 2023 |
| 2 | EMI Test Receiver | R&S | ESCI 7 | GTS552 | April 22, 2022 | April 21, 2023 |
| 3 | Spectrum Analyzer | Agilent | E4440A | GTS536 | April 22, 2022 | April 21, 2023 |
| 4 | MXG vector Signal Generator | Agilent | N5182A | GTS567 | April 22, 2022 | April 21, 2023 |
| 5 | ESG Analog Signal Generator | Agilent | E4428C | GTS568 | April 22, 2022 | April 21, 2023 |
| 6 | USB RF Power Sensor | DARE | RPR3006W | GTS569 | April 22, 2022 | April 21, 2023 |
| 7 | RF Switch Box | Shongyi | RFSW3003328 | GTS571 | April 22, 2022 | April 21, 2023 |
| 8 | Programmable Constant Temp & Humi Test Chamber | WEWON | WHTH-150L-40-880 | GTS572 | April 22, 2022 | April 21, 2023 |
| 9 | EXA Signal Analyzer | Keysight | N9010B | MY60241168 | Nov. 04, 2022 | Nov. 03, 2023 |

| General used equipment: | | | | | | |
|-------------------------|---------------------------------|--------------|-----------|---------------|---------------------|-------------------------|
| Item | Test Equipment | Manufacturer | Model No. | Inventory No. | Cal.Date (mm-dd-yy) | Cal.Due date (mm-dd-yy) |
| 1 | Humidity/ Temperature Indicator | KTJ | TA328 | GTS243 | April 25, 2022 | April 24, 2023 |
| 2 | Barometer | KUMAO | SF132 | GTS647 | July 26, 2022 | July 25, 2023 |

7 Test results and Measurement Data

7.1 Antenna requirement

| | |
|--|-------------------------------------|
| Standard requirement: | FCC Part15 C Section 15.203 /247(c) |
| 15.203 requirement: An intentional radiator shall be designed to ensure that no antenna other than that furnished by the responsible party shall be used with the device. The use of a permanently attached antenna or of an antenna that uses a unique coupling to the intentional radiator, the manufacturer may design the unit so that a broken antenna can be replaced by the user, but the use of a standard antenna jack or electrical connector is prohibited. | |
| 15.247(c) (1)(i) requirement: (i) Systems operating in the 2400-2483.5 MHz band that is used exclusively for fixed. Point-to-point operations may employ transmitting antennas with directional gain greater than 6dBi provided the maximum conducted output power of the intentional radiator is reduced by 1 dB for every 3 dB that the directional gain of the antenna exceeds 6dBi. | |
| E.U.T Antenna: | |
| The antenna is chip antenna, reference to the appendix II for details. | |

7.2 Conducted Emissions

| | | | | | |
|--|--|--------------|-----------|-----|------------------|
| Test Requirement: | FCC Part15 C Section 15.207 | | | | |
| Test Method: | ANSI C63.10:2013 | | | | |
| Test Frequency Range: | 150KHz to 30MHz | | | | |
| Class / Severity: | Class B | | | | |
| Receiver setup: | RBW=9KHz, VBW=30KHz, Sweep time=auto | | | | |
| Limit: | Frequency range (MHz) | Limit (dBuV) | | | |
| | | Quasi-peak | Average | | |
| | 0.15-0.5 | 66 to 56* | 56 to 46* | | |
| | 0.5-5 | 56 | 46 | | |
| | 5-30 | 60 | 50 | | |
| * Decreases with the logarithm of the frequency. | | | | | |
| Test setup: | <p>Reference Plane</p> <p>40cm 80cm</p> <p>LISN LISN</p> <p>AUX Equipment E.U.T</p> <p>Filter AC power</p> <p>EMI Receiver</p> <p>Test table/Insulation plane</p> <p>Remark E.U.T: Equipment Under Test LISN: Line Impedance Stabilization Network Test table height=0.8m</p> | | | | |
| Test procedure: | <ol style="list-style-type: none"> 1. The E.U.T and simulators are connected to the main power through a line impedance stabilization network (L.I.S.N.). This provides a 50ohm/50uH coupling impedance for the measuring equipment. 2. The peripheral devices are also connected to the main power through a LISN that provides a 50ohm/50uH coupling impedance with 50ohm termination. (Please refer to the block diagram of the test setup and photographs). 3. Both sides of A.C. line are checked for maximum conducted interference. In order to find the maximum emission, the relative positions of equipment and all of the interface cables must be changed according to ANSI C63.10:2013 on conducted measurement. | | | | |
| Test Instruments: | Refer to section 6.0 for details | | | | |
| Test mode: | Refer to section 5.2 for details | | | | |
| Test environment: | Temp.: | 25 °C | Humid.: | 52% | Press.: 1012mbar |
| Test voltage: | AC 120V, 60Hz | | | | |
| Test results: | Pass | | | | |

Measurement data:

Pre-scan all test modes, found worst case at GFSK 2402MHz, and so only show the test result of it
Line:

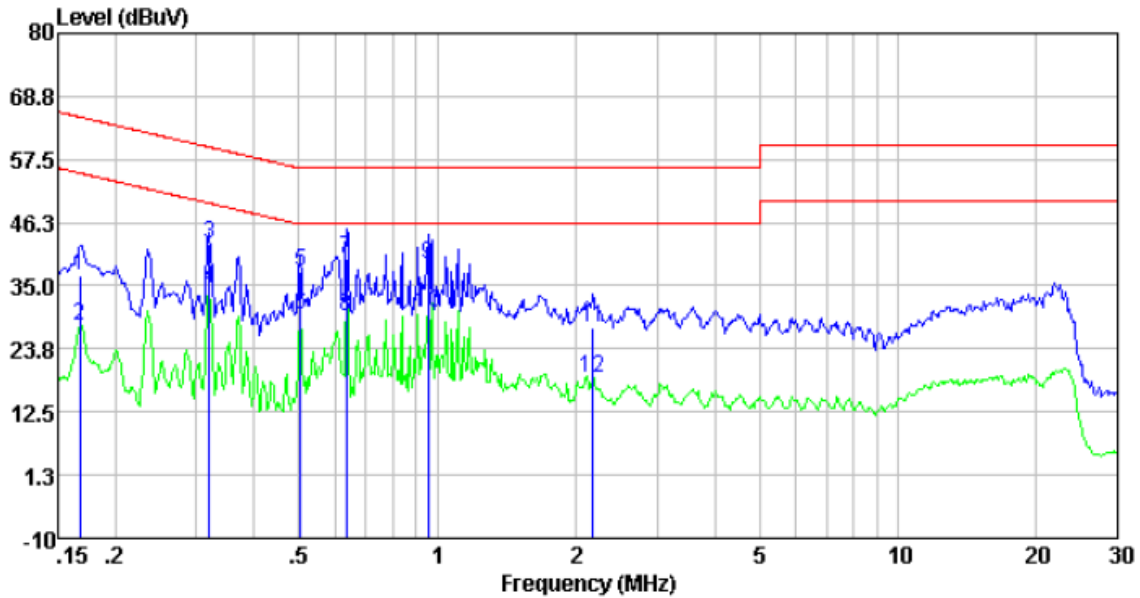

| Freq | Reading level | LISN/ISM factor | Cable loss | Level | Limit level | Over limit | Remark |
|------|---------------|-----------------|------------|-------|-------------|------------|---------|
| MHz | dBuV | dB | dB | dBuV | dBuV | dB | |
| 0.17 | 26.57 | 10.10 | 0.01 | 36.68 | 65.08 | -28.40 | QP |
| 0.17 | 17.59 | 10.10 | 0.01 | 27.70 | 55.08 | -27.38 | Average |
| 0.32 | 32.34 | 9.98 | 0.01 | 42.33 | 59.71 | -17.38 | QP |
| 0.32 | 24.36 | 9.98 | 0.01 | 34.35 | 49.71 | -15.36 | Average |
| 0.50 | 27.51 | 9.96 | 0.01 | 37.48 | 56.00 | -18.52 | QP |
| 0.50 | 19.77 | 9.96 | 0.01 | 29.74 | 46.00 | -16.26 | Average |
| 0.63 | 29.97 | 9.96 | 0.02 | 39.95 | 56.00 | -16.05 | QP |
| 0.63 | 19.61 | 9.96 | 0.02 | 29.59 | 46.00 | -16.41 | Average |
| 0.95 | 28.75 | 9.96 | 0.03 | 38.74 | 56.00 | -17.26 | QP |
| 0.95 | 20.34 | 9.96 | 0.03 | 30.33 | 46.00 | -15.67 | Average |
| 2.18 | 17.73 | 9.82 | 0.05 | 27.60 | 56.00 | -28.40 | QP |
| 2.18 | 8.57 | 9.82 | 0.05 | 18.44 | 46.00 | -27.56 | Average |

Neutral:

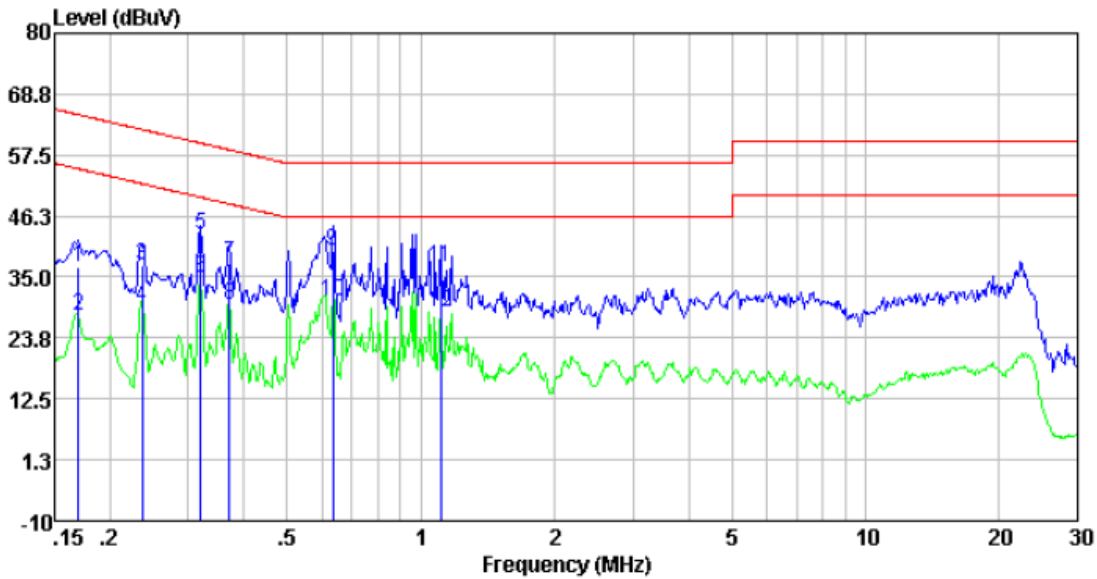

| Freq | Reading level | LISN/ISN factor | Cable loss | Level | Limit level | Over limit | Remark |
|------|---------------|-----------------|------------|-------|-------------|------------|---------|
| MHz | dBuV | dB | dB | dBuV | dBuV | dB | |
| 0.17 | 26.58 | 10.12 | 0.01 | 36.71 | 64.99 | -28.28 | QP |
| 0.17 | 17.62 | 10.12 | 0.01 | 27.75 | 54.99 | -27.24 | Average |
| 0.24 | 27.25 | 10.02 | 0.01 | 37.28 | 62.22 | -24.94 | QP |
| 0.24 | 19.65 | 10.02 | 0.01 | 29.68 | 52.22 | -22.54 | Average |
| 0.32 | 32.78 | 9.97 | 0.01 | 42.76 | 59.71 | -16.95 | QP |
| 0.32 | 24.88 | 9.97 | 0.01 | 34.86 | 49.71 | -14.85 | Average |
| 0.37 | 27.52 | 9.96 | 0.01 | 37.49 | 58.47 | -20.98 | QP |
| 0.37 | 20.01 | 9.96 | 0.01 | 29.98 | 48.47 | -18.49 | Average |
| 0.63 | 29.90 | 9.96 | 0.02 | 39.88 | 56.00 | -16.12 | QP |
| 0.63 | 20.55 | 9.96 | 0.02 | 30.53 | 46.00 | -15.47 | Average |
| 1.11 | 26.76 | 9.95 | 0.03 | 36.74 | 56.00 | -19.26 | QP |
| 1.11 | 18.67 | 9.95 | 0.03 | 28.65 | 46.00 | -17.35 | Average |

Notes:

1. An initial pre-scan was performed on the line and neutral lines with peak detector.
2. Quasi-Peak and Average measurement were performed at the frequencies with maximized peak emission.
3. Final Level = Receiver Read level + LISN Factor + Cable Loss

7.3 Conducted Peak Output Power

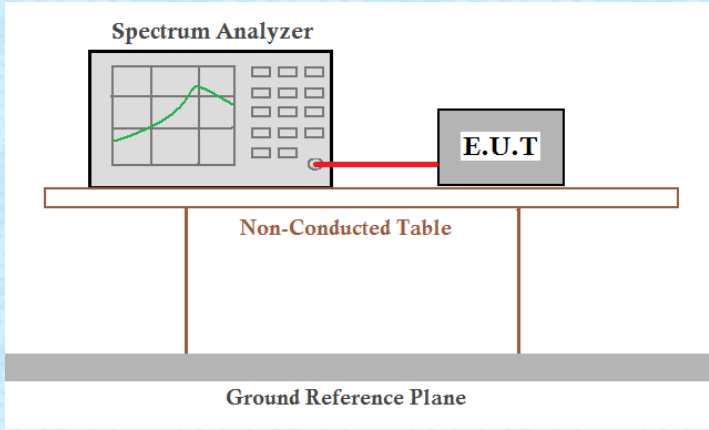
| | |
|-------------------|---|
| Test Requirement: | FCC Part15 C Section 15.247 (a)(1) |
| Test Method: | ANSI C63.10:2013 |
| Limit: | 20.97dBm |
| Test setup: |  <p>The diagram illustrates the test setup. A Spectrum Analyzer is connected to an E.U.T. (Equipment Under Test) via a red cable. Both are placed on a Non-Conducted Table, which sits on a Ground Reference Plane.</p> |
| Test Instruments: | Refer to section 6.0 for details |
| Test mode: | Refer to section 5.2 for details |
| Test results: | Pass |

Measurement Data: The detailed test data see Appendix for BT EDR.

7.4 20dB Emission Bandwidth

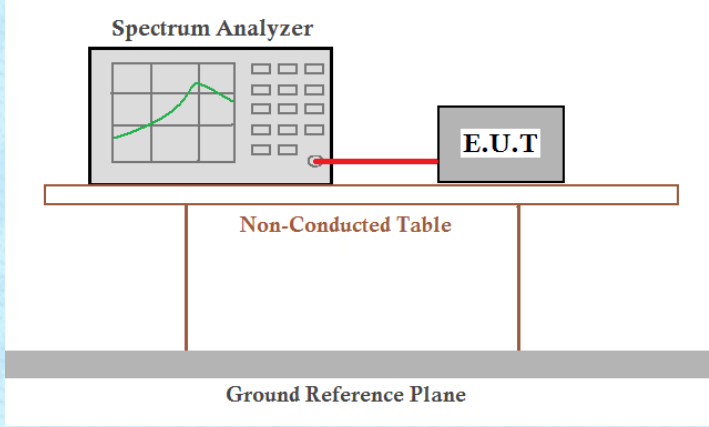
| | |
|-------------------|---|
| Test Requirement: | FCC Part15 C Section 15.247 (a)(1) |
| Test Method: | ANSI C63.10:2013 |
| Limit: | N/A |
| Test setup: |  <p>The diagram illustrates the test setup. A Spectrum Analyzer is connected to an E.U.T. (Equipment Under Test) via a red cable. Both are placed on a Non-Conducted Table, which is supported by a Ground Reference Plane.</p> |
| Test Instruments: | Refer to section 6.0 for details |
| Test mode: | Refer to section 5.2 for details |
| Test results: | Pass |

Measurement Data: The detailed test data see Appendix for BT EDR.

7.5 Carrier Frequencies Separation

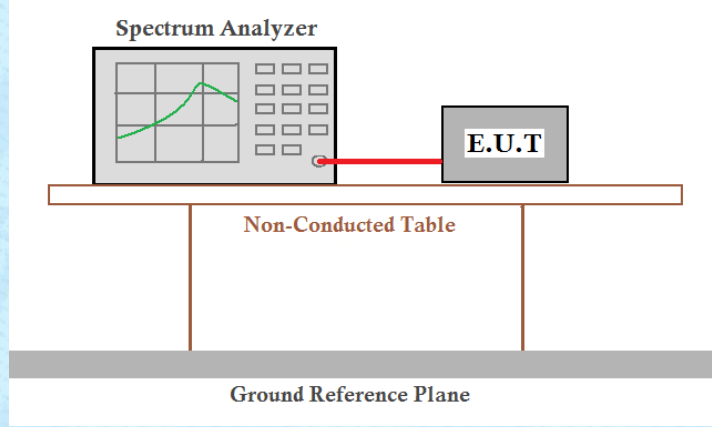
| | |
|-------------------|---|
| Test Requirement: | FCC Part15 C Section 15.247 (a)(1) |
| Test Method: | ANSI C63.10:2013 |
| Receiver setup: | RBW=100KHz, VBW=300KHz, detector=Peak |
| Limit: | GFSK: 20dB bandwidth $\pi/4$ -DQPSK: 0.025MHz or 2/3 of the 20dB bandwidth (whichever is greater) |
| Test setup: |  <p>The diagram illustrates the test setup. A Spectrum Analyzer is connected to an E.U.T. (Equipment Under Test) via a red cable. Both are placed on a Non-Conducted Table, which is supported by two legs. Below the table is a Ground Reference Plane.</p> |
| Test Instruments: | Refer to section 6.0 for details |
| Test mode: | Refer to section 5.2 for details |
| Test results: | Pass |

Measurement Data: The detailed test data see Appendix for BT EDR.

7.6 Hopping Channel Number

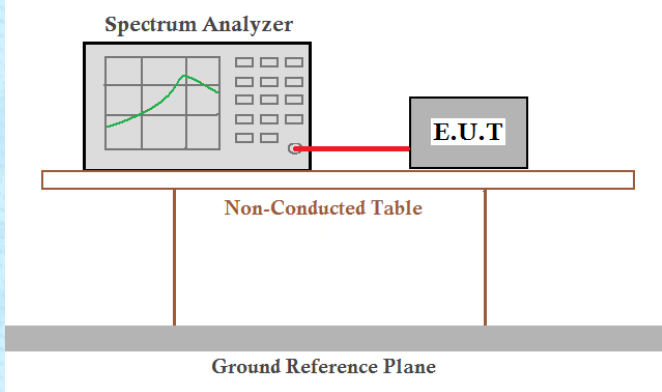
| | |
|-------------------|---|
| Test Requirement: | FCC Part15 C Section 15.247 (a)(1)(iii) |
| Test Method: | ANSI C63.10:2013 |
| Receiver setup: | RBW=100kHz, VBW=300kHz, Frequency range=2400MHz-2483.5MHz, Detector=Peak |
| Limit: | 15 channels |
| Test setup: |  <p>The diagram illustrates the test setup. A Spectrum Analyzer is connected to an E.U.T. (Equipment Under Test) via a red cable. Both are placed on a Non-Conducted Table, which is supported by a Ground Reference Plane.</p> |
| Test Instruments: | Refer to section 6.0 for details |
| Test mode: | Refer to section 5.2 for details |
| Test results: | Pass |

Measurement Data: The detailed test data see Appendix for BT EDR.

7.7 Dwell Time

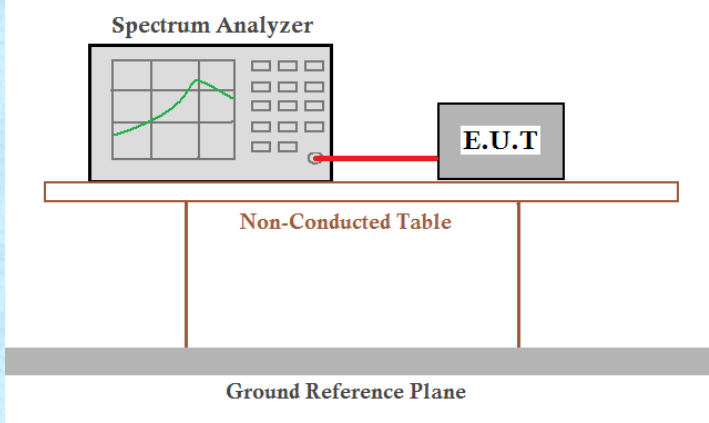
| | |
|-------------------|---|
| Test Requirement: | FCC Part15 C Section 15.247 (a)(1)(iii) |
| Test Method: | ANSI C63.10:2013 |
| Receiver setup: | RBW=1MHz, VBW=1MHz, Span=0Hz, Detector=Peak |
| Limit: | 0.4 Second |
| Test setup: |  <p>The diagram illustrates the test setup. A Spectrum Analyzer is connected to an E.U.T. (Equipment Under Test) via a red cable. Both are placed on a Non-Conducted Table, which is supported by a Ground Reference Plane.</p> |
| Test Instruments: | Refer to section 6.0 for details |
| Test mode: | Refer to section 5.2 for details |
| Test results: | Pass |

Measurement Data: The detailed test data see Appendix for BT EDR.

7.8 Spurious Emission in Non-restricted & restricted Bands

7.8.1 Conducted Emission Method

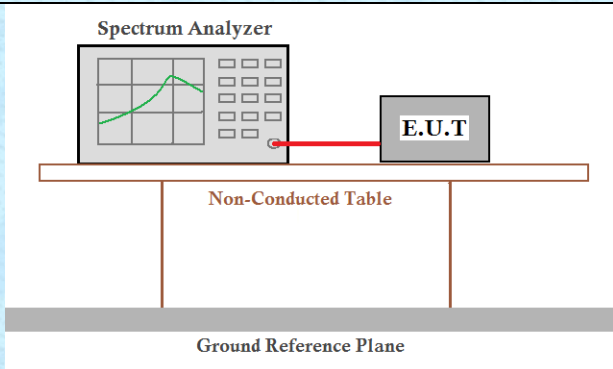
| | |
|-------------------|---|
| Test Requirement: | FCC Part15 C Section 15.247 (d) |
| Test Method: | ANSI C63.10:2013 |
| Receiver setup: | RBW=100kHz, VBW=300kHz, Detector=Peak |
| Limit: | In any 100 kHz bandwidth outside the frequency band in which the spread spectrum intentional radiator is operating, the radio frequency power that is produced by the intentional radiator shall be at least 30 dB below that in the 100 kHz bandwidth within the band that contains the highest level of the desired power, based on either an RF conducted or a radiated measurement. |
| Test setup: |  <p>The diagram illustrates the test setup. A Spectrum Analyzer is connected to an E.U.T. (Equipment Under Test) via a red cable. Both the Spectrum Analyzer and the E.U.T. are placed on a Non-Conducted Table. The table is supported by a Ground Reference Plane.</p> |
| Test Instruments: | Refer to section 6.0 for details |
| Test mode: | Refer to section 5.2 for details |
| Test results: | Pass |

Measurement Data: The detailed test data see Appendix for BT EDR.

7.8.2 Radiated Emission Method

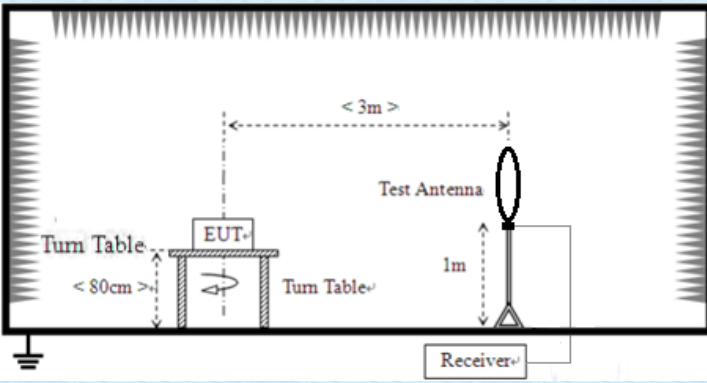
| | | | | | |
|--|---|--------------|----------|----------------------|------------|
| Test Requirement: | FCC Part15 C Section 15.209 | | | | |
| Test Method: | ANSI C63.10:2013 | | | | |
| Test Frequency Range: | 9kHz to 25GHz | | | | |
| Test site: | Measurement Distance: 3m | | | | |
| Receiver setup: | Frequency | Detector | RBW | VBW | Value |
| | 9KHz-150KHz | Quasi-peak | 200Hz | 600Hz | Quasi-peak |
| | 150KHz-30MHz | Quasi-peak | 9KHz | 30KHz | Quasi-peak |
| | 30MHz-1GHz | Quasi-peak | 120KHz | 300KHz | Quasi-peak |
| | Above 1GHz | Peak | 1MHz | 3MHz | Peak |
| | | Peak | 1MHz | 10Hz | Average |
| Note: For Duty cycle $\geq 98\%$, average detector set as above For Duty cycle $< 98\%$, average detector set as below: $VBW \geq 1 / T$ | | | | | |
| Limit: | Frequency | Limit (uV/m) | Value | Measurement Distance | |
| | 0.009MHz-0.490MHz | 2400/F(KHz) | PK/QP/AV | 300m | |
| | 0.490MHz-1.705MHz | 24000/F(KHz) | QP | 30m | |
| | 1.705MHz-30MHz | 30 | QP | 30m | |
| | 30MHz-88MHz | 100 | QP | 3m | |
| | 88MHz-216MHz | 150 | QP | | |
| | 216MHz-960MHz | 200 | QP | | |
| | 960MHz-1GHz | 500 | QP | | |
| | Above 1GHz | 500 | Average | | |
| | | 5000 | Peak | | |
| Test setup: | <p>For radiated emissions from 9kHz to 30MHz</p>  | | | | |

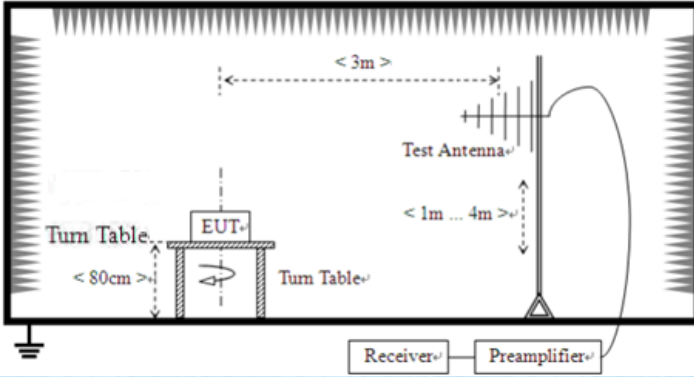
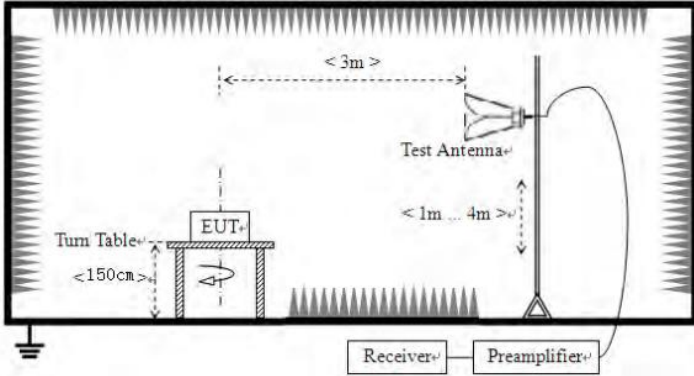
| | |
|--------------------------|--|
| | <p>For radiated emissions from 30MHz to 1GHz</p>  <p>For radiated emissions above 1GHz</p>  |
| <p>Test Procedure:</p> | <ol style="list-style-type: none"> 1. The EUT was placed on the top of a rotating table (0.8m for below 1G and 1.5m for above 1G) above the ground at a 3 meter camber. The table was rotated 360 degrees to determine the position of the highest radiation. 2. The EUT was set 3 meters away from the interference-receiving antenna, which was mounted on the top of a variable-height antenna tower. 3. The antenna height is varied from one meter to four meters above the ground to determine the maximum value of the field strength. Both horizontal and vertical polarizations of the antenna are set to make the measurement. 4. For each suspected emission, the EUT was arranged to its worst case and then the antenna was tuned to heights from 1 meter to 4 meters and the rota table was turned from 0 degrees to 360 degrees to find the maximum reading. 5. The test-receiver system was set to Peak Detect Function and Specified Bandwidth with Maximum Hold Mode. 6. If the emission level of the EUT in peak mode was 10dB lower than the limit specified, then testing could be stopped and the peak values of the EUT would be reported. Otherwise the emissions that did not have 10dB margin would be re-tested one by one using peak, quasi-peak or average method as specified and then reported in a data sheet. |
| <p>Test Instruments:</p> | <p>Refer to section 6.0 for details</p> |
| <p>Test mode:</p> | <p>Refer to section 5.2 for details</p> |

| | | | | | | |
|-------------------|---------|-------|---------|-----|---------|----------|
| Test environment: | Temp.: | 25 °C | Humid.: | 52% | Press.: | 1012mbar |
| Test voltage: | DC 3.7V | | | | | |
| Test results: | Pass | | | | | |

Measurement data:*Remarks:*

1. *During the test, pre-scan the GFSK, $\pi/4$ -DQPSK modulation, and found the GFSK modulation which it is worse case.*
2. *Pre-scan all kind of the place mode (X-axis, Y-axis, Z-axis), and found the Y-axis which it is worse case.*

■ 9kHz~30MHz

The low frequency, which started from 9 kHz to 30 MHz, was pre-scanned and the result which was 20 dB lower than the limit line per 15.31(o) was not reported.

■ **Below 1GHz**

Pre-scan all test modes, found worst case at GFSK 2402MHz, and so only show the test result of it
Horizontal:

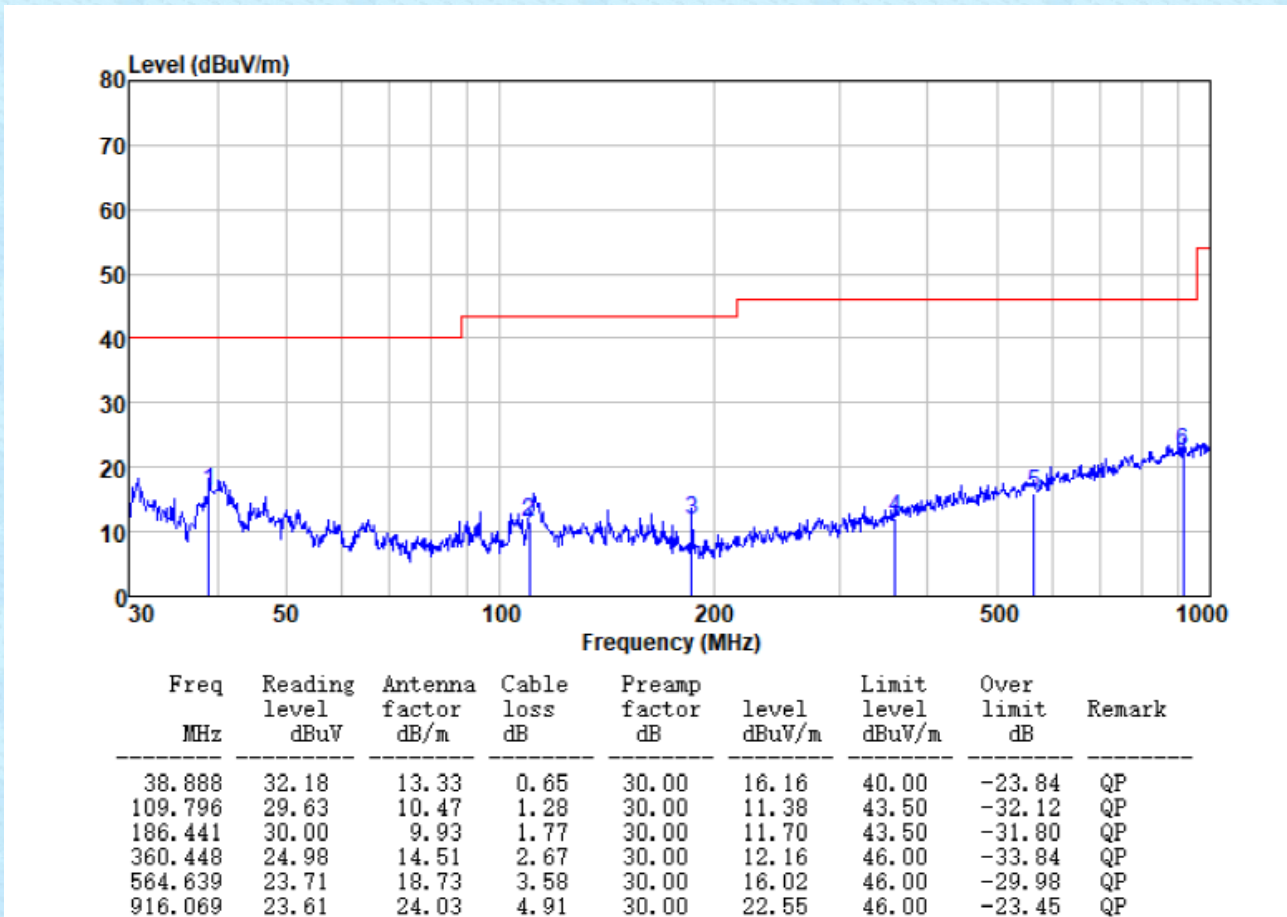

Vertical:

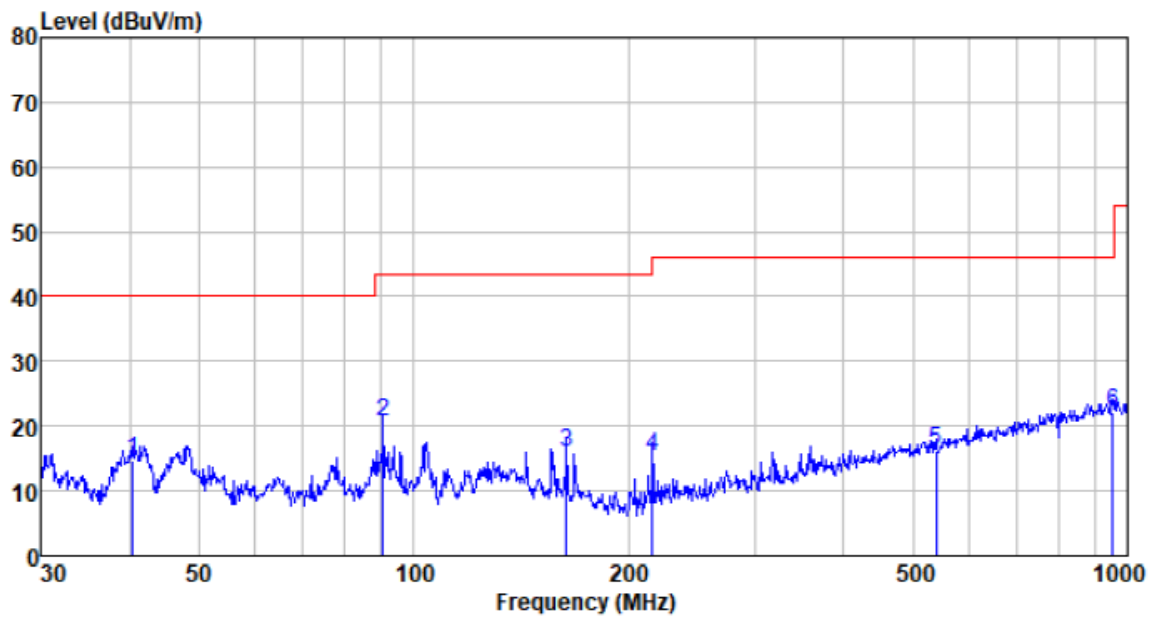

| Freq MHz | Reading level dBUV | Antenna factor dB/m | Cable loss dB | Preamp factor dB | level dBUV/m | Limit level dBUV/m | Over limit dB | Remark |
|-------------|--------------------------|---------------------------|---------------------|------------------------|-----------------|--------------------------|---------------------|--------|
| 40.417 | 30.74 | 13.49 | 0.66 | 30.00 | 14.89 | 40.00 | -25.11 | QP |
| 90.537 | 40.94 | 8.66 | 1.11 | 30.00 | 20.71 | 43.50 | -22.79 | QP |
| 163.755 | 32.17 | 12.15 | 1.65 | 30.00 | 15.97 | 43.50 | -27.53 | QP |
| 216.024 | 33.44 | 10.09 | 1.93 | 30.00 | 15.46 | 46.00 | -30.54 | QP |
| 539.478 | 24.34 | 18.31 | 3.48 | 30.00 | 16.13 | 46.00 | -29.87 | QP |
| 952.094 | 22.71 | 24.33 | 5.04 | 30.00 | 22.08 | 46.00 | -23.92 | QP |

- Above 1GHz
- Unwanted Emissions in Restricted Frequency Bands

| | | | |
|---------------|--------|---------------|------------|
| Test channel: | Lowest | Polarization: | Horizontal |
|---------------|--------|---------------|------------|

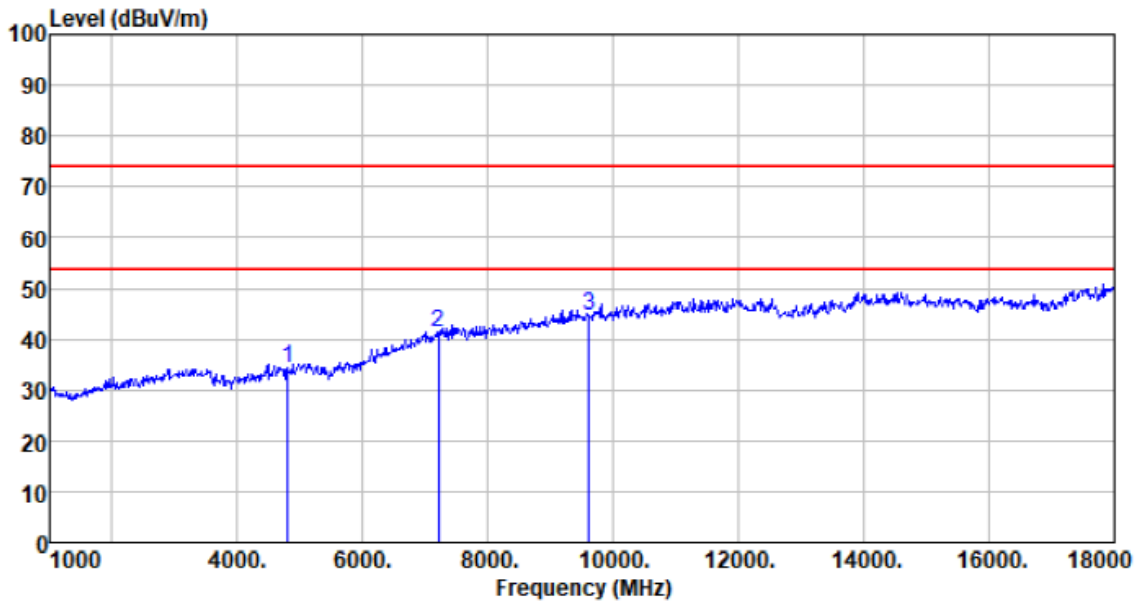

| Freq MHz | Reading level dBuV | Antenna factor dB/m | Cable loss dB | Preamp factor dB | level dBuV/m | Limit level dBuV/m | Over limit dB | Remark |
|-------------|--------------------------|---------------------------|---------------------|------------------------|-----------------|--------------------------|---------------------|--------|
| 4804.000 | 37.00 | 31.05 | 4.61 | 38.36 | 34.30 | 74.00 | -39.70 | Peak |
| 7206.000 | 37.88 | 35.91 | 6.48 | 38.96 | 41.31 | 74.00 | -32.69 | Peak |
| 9608.000 | 38.43 | 37.91 | 7.97 | 39.68 | 44.63 | 74.00 | -29.37 | Peak |

| | | | |
|---------------|--------|---------------|----------|
| Test channel: | Lowest | Polarization: | Vertical |
|---------------|--------|---------------|----------|

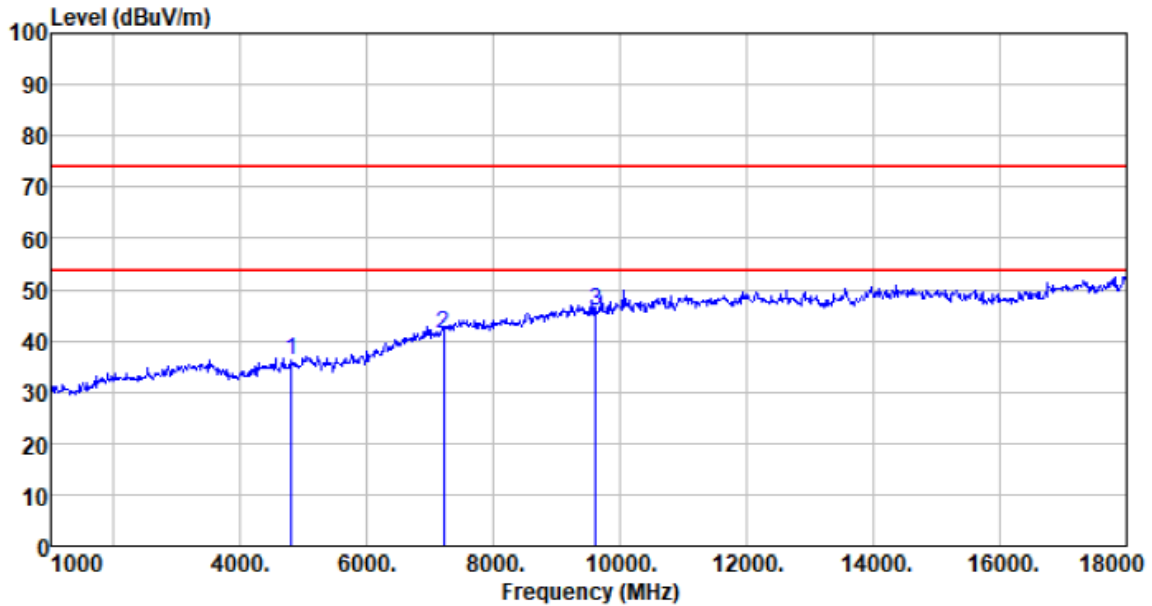

| Freq MHz | Reading level dBuV | Antenna factor dB/m | Cable loss dB | Preamp factor dB | level dBuV/m | Limit level dBuV/m | Over limit dB | Remark |
|-------------|--------------------------|---------------------------|---------------------|------------------------|-----------------|--------------------------|---------------------|--------|
| 4804.000 | 38.89 | 31.05 | 4.61 | 38.36 | 36.19 | 74.00 | -37.81 | Peak |
| 7206.000 | 38.03 | 35.91 | 6.48 | 38.96 | 41.46 | 74.00 | -32.54 | Peak |
| 9608.000 | 39.61 | 37.91 | 7.97 | 39.68 | 45.81 | 74.00 | -28.19 | Peak |

| | | | |
|---------------|--------|---------------|------------|
| Test channel: | Middle | Polarization: | Horizontal |
|---------------|--------|---------------|------------|

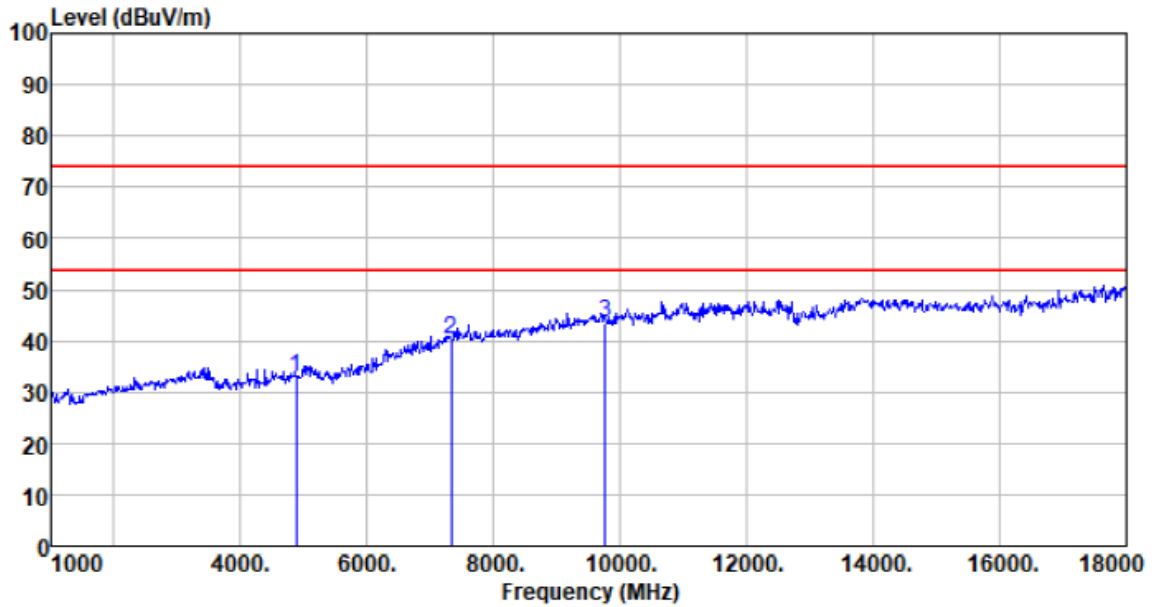

| Freq MHz | Reading level dBuV | Antenna factor dB/m | Cable loss dB | Preamp factor dB | level dBuV/m | Limit level dBuV/m | Over limit dB | Remark |
|-------------|--------------------------|---------------------------|---------------------|------------------------|-----------------|--------------------------|---------------------|--------|
| 4882.000 | 35.29 | 31.27 | 4.69 | 38.38 | 32.87 | 74.00 | -41.13 | Peak |
| 7323.000 | 36.41 | 36.15 | 6.63 | 39.00 | 40.19 | 74.00 | -33.81 | Peak |
| 9764.000 | 37.29 | 38.06 | 8.03 | 39.73 | 43.65 | 74.00 | -30.35 | Peak |

| | | | |
|---------------|--------|---------------|----------|
| Test channel: | Middle | Polarization: | Vertical |
|---------------|--------|---------------|----------|

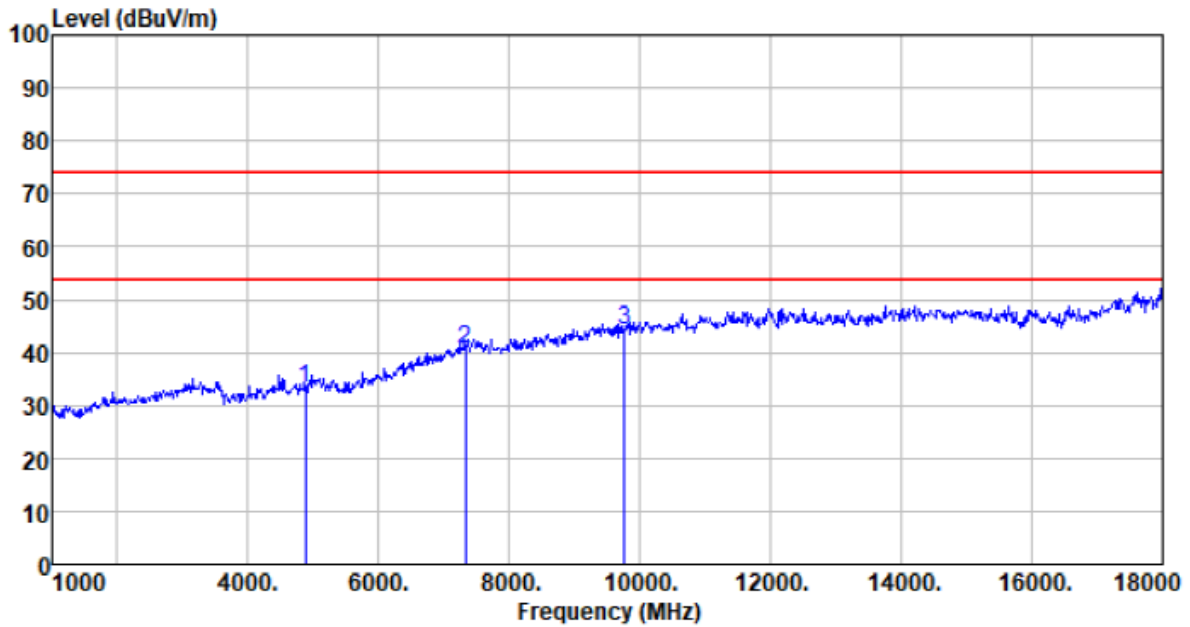

| Freq MHz | Reading level dBuV | Antenna factor dB/m | Cable loss dB | Preamp factor dB | level dBuV/m | Limit level dBuV/m | Over limit dB | Remark |
|-------------|--------------------------|---------------------------|---------------------|------------------------|-----------------|--------------------------|---------------------|--------|
| 4882.000 | 35.81 | 31.27 | 4.69 | 38.38 | 33.39 | 74.00 | -40.61 | Peak |
| 7323.000 | 36.65 | 36.15 | 6.63 | 39.00 | 40.43 | 74.00 | -33.57 | Peak |
| 9764.000 | 37.83 | 38.06 | 8.03 | 39.73 | 44.19 | 74.00 | -29.81 | Peak |

| | | | |
|---------------|---------|---------------|------------|
| Test channel: | Highest | Polarization: | Horizontal |
|---------------|---------|---------------|------------|

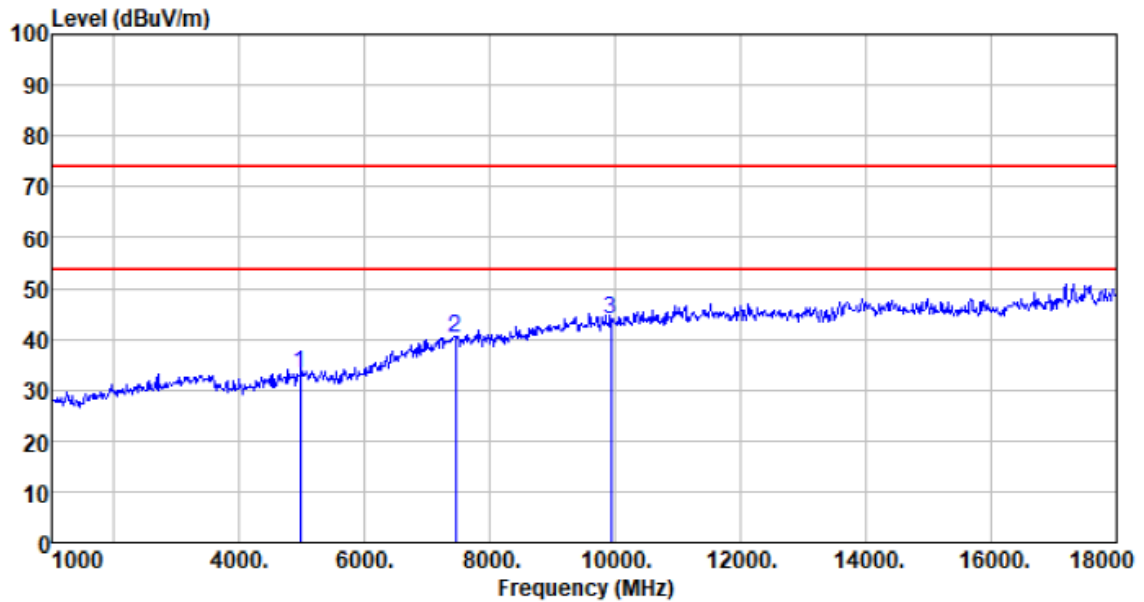

| Freq MHz | Reading level dBuV | Antenna factor dB/m | Cable loss dB | Preamp factor dB | level dBuV/m | Limit level dBuV/m | Over limit dB | Remark |
|-------------|--------------------------|---------------------------|---------------------|------------------------|-----------------|--------------------------|---------------------|--------|
| 4960.000 | 35.19 | 31.49 | 4.79 | 38.39 | 33.08 | 74.00 | -40.92 | Peak |
| 7440.000 | 35.97 | 36.38 | 6.77 | 39.03 | 40.09 | 74.00 | -33.91 | Peak |
| 9920.000 | 37.29 | 38.22 | 8.09 | 39.78 | 43.82 | 74.00 | -30.18 | Peak |

| | | | |
|---------------|---------|---------------|----------|
| Test channel: | Highest | Polarization: | Vertical |
|---------------|---------|---------------|----------|

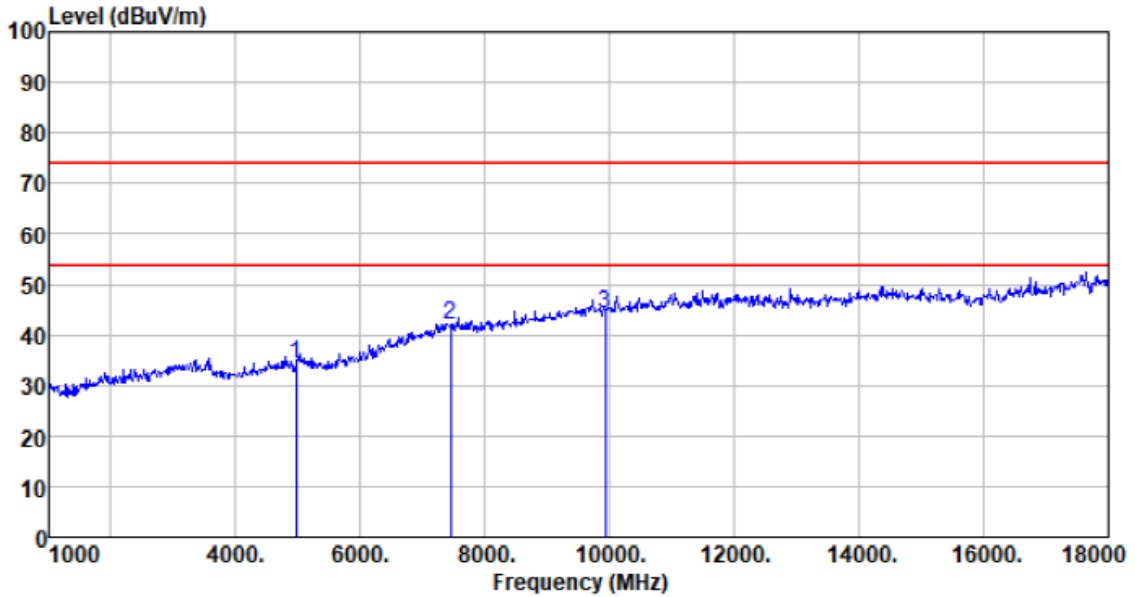

| Freq MHz | Reading level dBuV | Antenna factor dB/m | Cable loss dB | Preamp factor dB | level dBuV/m | Limit level dBuV/m | Over limit dB | Remark |
|-------------|--------------------------|---------------------------|---------------------|------------------------|-----------------|--------------------------|---------------------|--------|
| 4960.000 | 36.38 | 31.49 | 4.79 | 38.39 | 34.27 | 74.00 | -39.73 | Peak |
| 7440.000 | 37.90 | 36.38 | 6.77 | 39.03 | 42.02 | 74.00 | -31.98 | Peak |
| 9920.000 | 37.77 | 38.22 | 8.09 | 39.78 | 44.30 | 74.00 | -29.70 | Peak |

Remarks:

1. *Final Level = Receiver Read level + Antenna Factor + Cable Loss – Pre-amplifier Factor*
2. *The emission levels of frequencies range from 18GHz-25GHz are very lower than the limit and not show in test report.*

■ Unwanted Emissions in Non-restricted Frequency Bands

| | | | |
|---------------|--------|---------------|------------|
| Test channel: | Lowest | Polarization: | Horizontal |
|---------------|--------|---------------|------------|

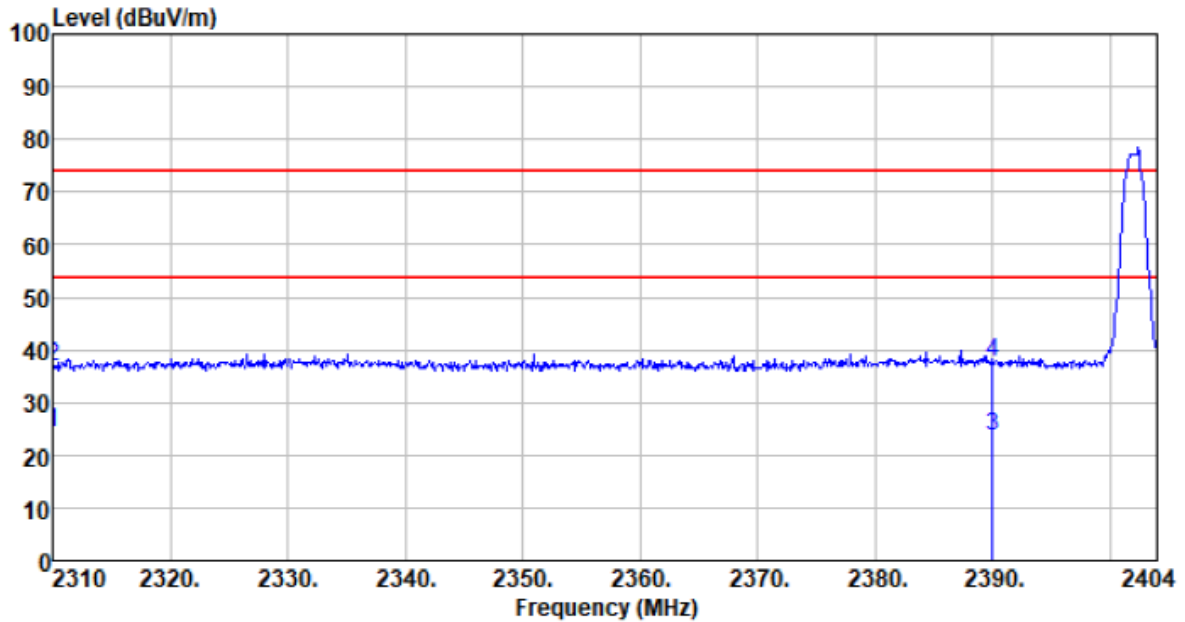

| Freq MHz | Reading level dBuV | Antenna factor dB/m | Cable loss dB | Preamp factor dB | level dBuV/m | Limit level dBuV/m | Over limit dB | Remark |
|-------------|--------------------------|---------------------------|---------------------|------------------------|-----------------|--------------------------|---------------------|---------|
| 2310.000 | 32.73 | 27.17 | 2.81 | 38.52 | 24.19 | 54.00 | -29.81 | Average |
| 2310.000 | 45.48 | 27.17 | 2.81 | 38.52 | 36.94 | 74.00 | -37.06 | Peak |
| 2390.000 | 31.87 | 27.27 | 2.91 | 38.56 | 23.49 | 54.00 | -30.51 | Average |
| 2390.000 | 45.95 | 27.27 | 2.91 | 38.56 | 37.57 | 74.00 | -36.43 | Peak |

| | | | |
|---------------|--------|---------------|----------|
| Test channel: | Lowest | Polarization: | Vertical |
|---------------|--------|---------------|----------|

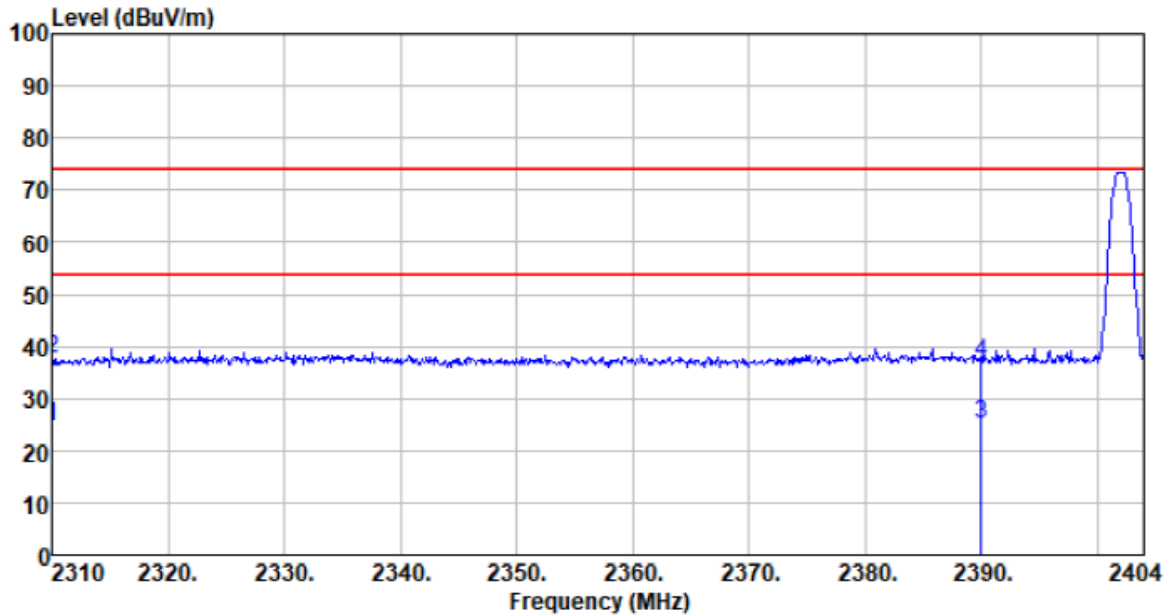

| Freq MHz | Reading level dBuV | Antenna factor dB/m | Cable loss dB | Preamp factor dB | level dBuV/m | Limit level dBuV/m | Over limit dB | Remark |
|-------------|--------------------------|---------------------------|---------------------|------------------------|-----------------|--------------------------|---------------------|---------|
| 2310.000 | 33.16 | 27.17 | 2.81 | 38.52 | 24.62 | 54.00 | -29.38 | Average |
| 2310.000 | 46.06 | 27.17 | 2.81 | 38.52 | 37.52 | 74.00 | -36.48 | Peak |
| 2390.000 | 33.31 | 27.27 | 2.91 | 38.56 | 24.93 | 54.00 | -29.07 | Average |
| 2390.000 | 45.28 | 27.27 | 2.91 | 38.56 | 36.90 | 74.00 | -37.10 | Peak |

| | | | |
|---------------|---------|---------------|------------|
| Test channel: | Highest | Polarization: | Horizontal |
|---------------|---------|---------------|------------|

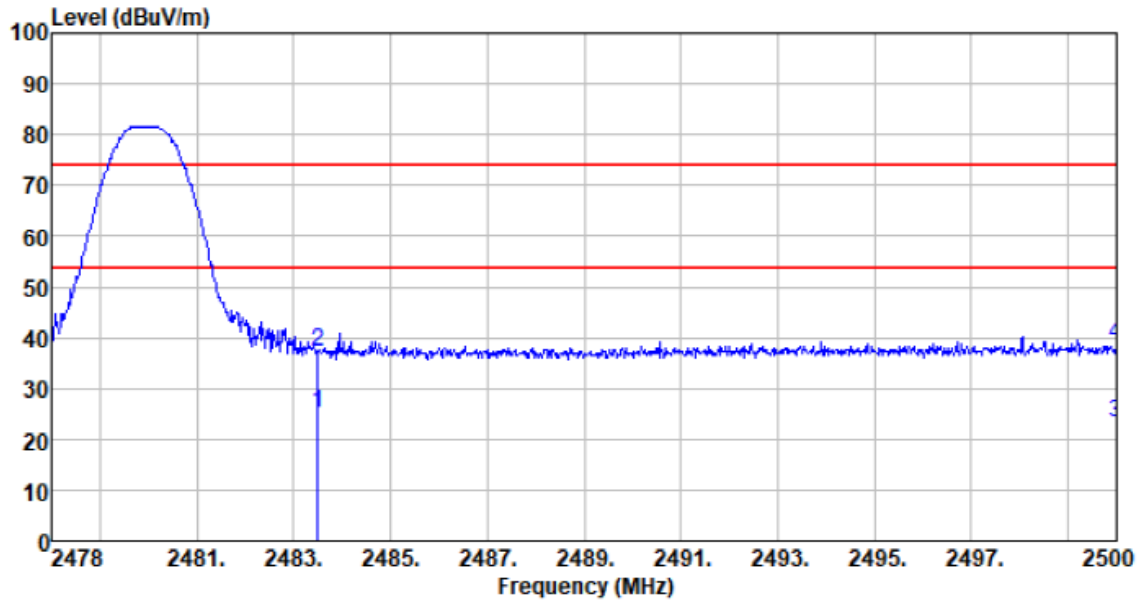

| Freq MHz | Reading level dBuV | Antenna factor dB/m | Cable loss dB | Preamp factor dB | level dBuV/m | Limit level dBuV/m | Over limit dB | Remark |
|-------------|--------------------------|---------------------------|---------------------|------------------------|-----------------|--------------------------|---------------------|---------|
| 2483.500 | 33.46 | 27.38 | 2.99 | 38.59 | 25.24 | 54.00 | -28.76 | Average |
| 2483.500 | 45.67 | 27.38 | 2.99 | 38.59 | 37.45 | 74.00 | -36.55 | Peak |
| 2500.000 | 31.62 | 27.40 | 3.01 | 38.60 | 23.43 | 54.00 | -30.57 | Average |
| 2500.000 | 46.88 | 27.40 | 3.01 | 38.60 | 38.69 | 74.00 | -35.31 | Peak |

| | | | |
|---------------|---------|---------------|----------|
| Test channel: | Highest | Polarization: | Vertical |
|---------------|---------|---------------|----------|

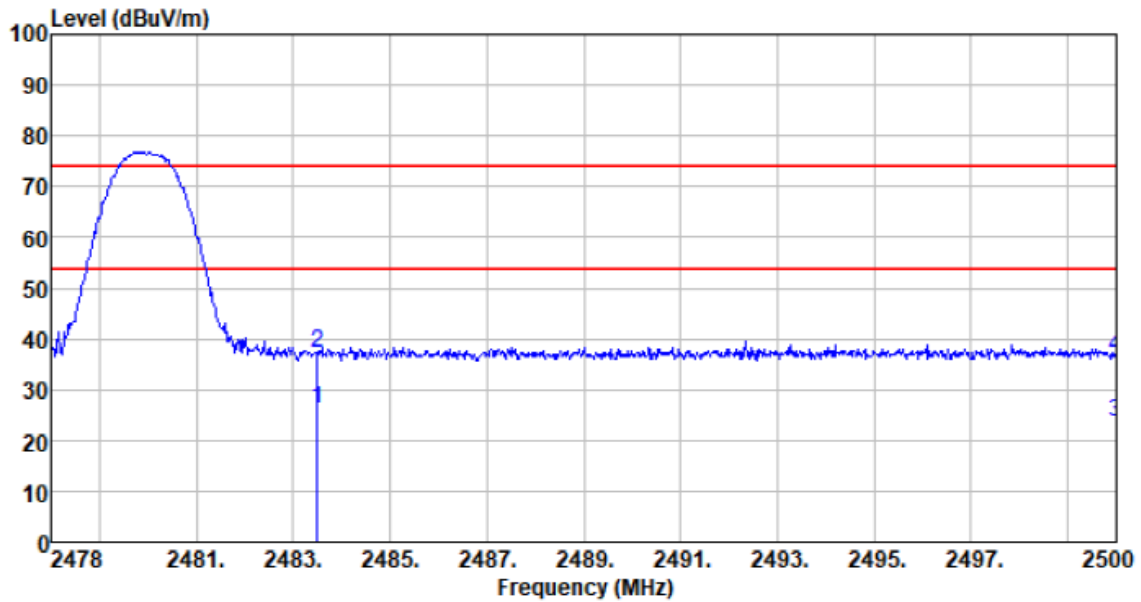

| Freq MHz | Reading level dBuV | Antenna factor dB/m | Cable loss dB | Preamp factor dB | level dBuV/m | Limit level dBuV/m | Over limit dB | Remark |
|-------------|--------------------------|---------------------------|---------------------|------------------------|-----------------|--------------------------|---------------------|---------|
| 2483.500 | 34.44 | 27.38 | 2.99 | 38.59 | 26.22 | 54.00 | -27.78 | Average |
| 2483.500 | 45.38 | 27.38 | 2.99 | 38.59 | 37.16 | 74.00 | -36.84 | Peak |
| 2500.000 | 31.80 | 27.40 | 3.01 | 38.60 | 23.61 | 54.00 | -30.39 | Average |
| 2500.000 | 44.61 | 27.40 | 3.01 | 38.60 | 36.42 | 74.00 | -37.58 | Peak |

Remarks:

1. Final Level = Receiver Read level + Antenna Factor + Cable Loss – Pre-amplifier Factor
2. The emission levels of other frequencies are very lower than the limit and not show in test report.

8 Test Setup Photo

Reference to the **appendix I** for details.

9 EUT Constructional Details

Reference to the **appendix II** for details.

-----End-----