

FCC Radio Test Report

FCC ID: 2AHYHHFD-810A

Original Grant

Report No. : TB-FCC147355
Applicant : Shenzhen Hi-FiD Electronics Tech Co., Ltd
Equipment Under Test (EUT)
EUT Name : Bluetooth Speaker
Model No. : HFD-810A
Series Model No. : BP-WANTS, SP-SKBT810, SP-SKBT812, SP-SKBEAST, HFD-895, HFD-896, HFD-810, HFD-812, WSP-895
Brand Name : N/A
Receipt Date : 2016-03-24
Test Date : 2016-03-25 to 2016-04-15
Issue Date : 2016-04-16
Standards : FCC Part 15: 2015, Subpart C(15.247)
Test Method : ANSI C63.10: 2013
Conclusions : **PASS**

In the configuration tested, the EUT complied with the standards specified above,
The EUT technically complies with the FCC requirements

Test/Witness Engineer :

WANG SU

Approved & Authorized :

Long Hai



This report details the results of the testing carried out on one sample. The results contained in this test report do not relate to other samples of the same product. The manufacturer should ensure that all products in series production are in conformity with the product sample detailed in the report.

Contents

CONTENTS	2
1. GENERAL INFORMATION ABOUT EUT	4
1.1 Client Information.....	4
1.2 General Description of EUT (Equipment Under Test)	4
1.3 Block Diagram Showing the Configuration of System Tested.....	5
1.4 Description of Support Units	6
1.5 Description of Test Mode.....	6
1.6 Description of Test Software Setting	7
1.7 Measurement Uncertainty	7
1.8 Test Facility.....	8
2. TEST SUMMARY	9
3. TEST EQUIPMENT	10
4. CONDUCTED EMISSION TEST	11
4.1 Test Standard and Limit.....	11
4.2 Test Setup.....	11
4.3 Test Procedure.....	11
4.4 EUT Operating Mode	12
4.5 Test Data.....	12
5. RADIATED EMISSION TEST	17
5.1 Test Standard and Limit.....	17
5.2 Test Setup.....	18
5.3 Test Procedure.....	19
5.4 EUT Operating Condition	19
6. RESTRICTED BANDS REQUIREMENT	39
6.1 Test Standard and Limit.....	39
6.2 Test Setup.....	39
6.3 Test Procedure.....	39
6.4 EUT Operating Condition	40
6.4 Test Data.....	40
7. NUMBER OF HOPPING CHANNEL	53
7.1 Test Standard and Limit.....	53
7.2 Test Setup.....	53
7.3 Test Procedure.....	53
7.4 EUT Operating Condition	53
7.5 Test Data.....	53
8. AVERAGE TIME OF OCCUPANCY	55
8.1 Test Standard and Limit.....	55
8.2 Test Setup.....	55

8.3 Test Procedure.....	55
8.4 EUT Operating Condition	55
8.5 Test Data.....	56
9. CHANNEL SEPARATION AND BANDWIDTH TEST	74
9.1 Test Standard and Limit.....	74
9.2 Test Setup.....	74
9.3 Test Procedure.....	74
9.4 EUT Operating Condition	74
9.5 Test Data.....	75
10. PEAK OUTPUT POWER TEST.....	87
10.1 Test Standard and Limit	87
10.2 Test Setup.....	87
10.3 Test Procedure.....	87
10.4 EUT Operating Condition	87
10.5 Test Data.....	88
11. ANTENNA REQUIREMENT.....	94
11.1 Standard Requirement.....	94
11.2 Antenna Connected Construction.....	94

1. General Information about EUT

1.1 Client Information

Applicant : Shenzhen Hi-FiD Electronics Tech Co., Ltd
Address : 4F, B7 Building, Hengfeng industrial City, Hezhou Village, Xixiang Town, Bao'an District, Shenzhen City, China
Manufacturer : Shenzhen Hi-FiD Electronics Tech Co., Ltd
Address : 4F, B7 Building, Hengfeng industrial City, Hezhou Village, Xixiang Town, Bao'an District, Shenzhen City, China

1.2 General Description of EUT (Equipment Under Test)

EUT Name	: Bluetooth Speaker
Models No.	: HFD-810A ,BP-WANTS, SP-SKBT810, SP-SKBT812, SP-SKBEAST, HFD-895, HFD-896, HFD-810, HFD-812, WSP-895
Model Difference	: All these models are identical in the same PCB, layout and electrical circuit, the only difference is model name for commercial.
Product Description	Operation Frequency: Bluetooth : 2402~2480MHz BLE: 2402MHz~2480MHz <small>See Note 1</small>
	Number of Channel: Bluetooth:79 Channels <small>See Note 2</small>
	Max Peak Output Power: Bluetooth: 3.782 dBm(8-DPSK)
	Antenna Gain: 0.5 dBi PCB Antenna
	Modulation Type: GFSK 1Mbps(1 Mbps) π /4-DQPSK(2 Mbps) 8-DPSK(3 Mbps)
Power Supply	: DC power by AC/DC Adapter. DC power by Li-ion Battery.
Power Rating	: Input: AC 100-240V~50/60Hz 0.6A. Output: 15V,1500mA. DC 11.1V by 2250mAh Li-ion Battery.
Connecting I/O Port(S)	: Please refer to the User's Manual

Note:

- (1) For a more detailed features description, please refer to the manufacturer's specifications or the User's Manual. The EUT has also been tested and complied the FCC 15C for BLE function, and recorded in the separate test report.
- (2) Channel List:

Bluetooth Channel List					
Channel	Frequency (MHz)	Channel	Frequency (MHz)	Channel	Frequency (MHz)

00	2402	27	2429	54	2456
01	2403	28	2430	55	2457
02	2404	29	2431	56	2458
03	2405	30	2432	57	2459
04	2406	31	2433	58	2460
05	2407	32	2434	59	2461
06	2408	33	2435	60	2462
07	2409	34	2436	61	2463
08	2410	35	2437	62	2464
09	2411	36	2438	63	2465
10	2412	37	2439	64	2466
11	2413	38	2440	65	2467
12	2414	39	2441	66	2468
13	2415	40	2442	67	2469
14	2416	41	2443	68	2470
15	2417	42	2444	69	2471
16	2418	43	2445	70	2472
17	2419	44	2446	71	2473
18	2420	45	2447	72	2474
19	2421	46	2448	73	2475
20	2422	47	2449	74	2476
21	2423	48	2450	75	2477
22	2424	49	2451	76	2478
23	2425	50	2452	77	2479
24	2426	51	2453	78	2480
25	2427	52	2454		
26	2428	53	2455		

(3) The Antenna information about the equipment is provided by the applicant.

1.3 Block Diagram Showing the Configuration of System Tested

TX Mode

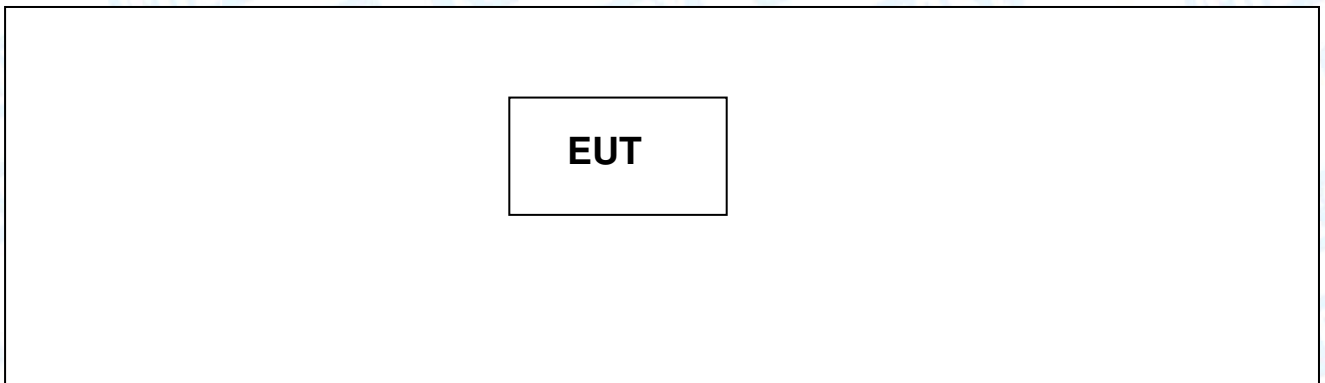

1.4 Description of Support Units

The EUT has been test as an independent unit.

1.5 Description of Test Mode

To investigate the maximum EMI emission characteristics generates from EUT, the test system was pre-scanning tested base on the consideration of following EUT operation mode or test configuration mode which possible have effect on EMI emission level. Each of these EUT operation mode(s) or test configuration mode(s) mentioned follow was evaluated respectively.

For Conducted Test	
Final Test Mode	Description
Mode 1	USB Charging with TX GFSK Mode

For Radiated Test	
Final Test Mode	Description
Mode 1	USB Charging with TX GFSK Mode
Mode 2	TX Mode(GFSK) Channel 00/39/78
Mode 3	TX Mode($\pi/4$ -DQPSK) Channel 00/39/78
Mode 4	TX Mode(8-DPSK) Channel 00/39/78
Mode 5	Hopping Mode(GFSK)
Mode 6	Hopping Mode($\pi/4$ -DQPSK)
Mode 7	Hopping Mode(8-DPSK)

Note:

- (1) For all test, we have verified the construction and function in typical operation. And all the test modes were carried out with the EUT in transmitting operation in maximum power with all kinds of data rate. We have pretested all the test mode above.

According to ANSI C63.10 standards, the measurements are performed at the highest, middle, lowest available channels, and the worst case data rate as follows:

- TX Mode: GFSK (1 Mbps)
- TX Mode: $\pi/4$ -DQPSK (2 Mbps)
- TX Mode: 8-DPSK (3Mbps)

- (2) The EUT is considered a portable unit; it was pre-tested on the positioned of each 3 axis, X-plane, Y-plane and Z-plane. The worst case was found positioned on X-plane as the normal use. Therefore only the test data of this X-plane was used for radiated emission measurement test.

1.6 Description of Test Software Setting

During testing channel & Power controlling software provided by the customer was used to control the operating channel as well as the output power level. The RF output power selection is for the setting of RF output power expected by the customer and is going to be fixed on the firmware of the final end product power parameters of Bluetooth mode.

Test Software Version	Realtek Bluetooth MP		
	2402 MHz	2441MHz	2480 MHz
Frequency	2402 MHz	2441MHz	2480 MHz
GFSK	DEF	DEF	DEF
$\pi/4$ -DQPSK	DEF	DEF	DEF
8-DPSK	DEF	DEF	DEF

1.7 Measurement Uncertainty

The reported uncertainty of measurement $y \pm U$, where expanded uncertainty U is based on a standard uncertainty multiplied by a coverage factor of $k=2$, providing a level of confidence of approximately 95 %.

Test Item	Parameters	Expanded Uncertainty (U_{Lab})
Conducted Emission	Level Accuracy: 9kHz~150kHz	± 3.42 dB
	150kHz to 30MHz	± 3.42 dB
Radiated Emission	Level Accuracy: 9kHz to 30 MHz	± 4.60 dB
Radiated Emission	Level Accuracy: 30MHz to 1000 MHz	± 4.40 dB
Radiated Emission	Level Accuracy: Above 1000MHz	± 4.20 dB

1.8 Test Facility

The testing report were performed by the Shenzhen Toby Technology Co., Ltd., in their facilities located at 1A/F., Bldg.6, Yusheng Industrial Zone, The National Road No.107 Xixiang Section 467, Xixiang, Bao'an, Shenzhen, Guangdong, China. At the time of testing, the following bodies accredited the Laboratory:

CNAS (L5813)

The Laboratory has been accredited by CNAS to ISO/IEC 17025: 2005 General Requirements for the Competence of Testing and Calibration Laboratories for the competence in the field of testing. And the Registration No.: CNAS L5813.

FCC List No.: (811562)

The Laboratory is listed in the United States of American Federal Communications Commission (FCC), and the registration number is 811562.

IC Registration No.: (11950A-1)

The Laboratory has been registered by Certification and Engineering Bureau of Industry Canada for radio equipment testing. The site registration: Site# 11950A-1.

2. Test Summary

FCC Part 15 Subpart C(15.247)/ RSS 247 Issue 1				
Standard Section		Test Item	Judgment	Remark
FCC	IC			
15.203		Antenna Requirement	PASS	N/A
15.207	RSS-GEN 7.2.2	Conducted Emission	PASS	N/A
15.205	RSS-Gen 7.2.3	Restricted Bands	PASS	N/A
15.247(a)(1)	RSS 247 5.1 (2)	Hopping Channel Separation	PASS	N/A
15.247(a)(1)	RSS 247 5.1 (4)	Dwell Time	PASS	N/A
15.247(b)(1)	RSS 247 5.4 (2)	Peak Output Power	PASS	N/A
15.247(b)(1)	RSS 247 5.1 (4)	Number of Hopping Frequency	PASS	N/A
15.247(c)	RSS 247 5.5	Radiated Spurious Emission	PASS	N/A
15.247(a)	RSS 247 5.1 (1)	99% Occupied Bandwidth & 20dB Bandwidth	PASS	99%OBW GFSK:820.5198kHz π /4-DQPSK: 1085.20kHz 8-DPSK: 1170.40KHz

Note: N/A is an abbreviation for Not Applicable.

3. Test Equipment

Conducted Emission Test					
Equipment	Manufacturer	Model No.	Serial No.	Last Cal.	Cal. Due Date
EMI Test Receiver	Rohde & Schwarz	ESCI	100321	Aug. 07, 2015	Aug. 06, 2016
RF Switching Unit	Compliance Direction Systems Inc	RSU-A4	34403	Aug. 07, 2015	Aug. 06, 2016
AMN	SCHWARZBECK	NNBL 8226-2	8226-2/164	Aug. 07, 2015	Aug. 06, 2016
LISN	Rohde & Schwarz	ENV216	101131	Aug. 08, 2015	Aug. 07, 2016
Radiation Emission Test					
Equipment	Manufacturer	Model No.	Serial No.	Last Cal.	Cal. Due Date
Spectrum Analyzer	Agilent	E4407B	MY45106456	Aug. 29, 2015	Aug. 28, 2016
EMI Test Receiver	Rohde & Schwarz	ESCI	100010/007	Aug. 07, 2015	Aug. 06, 2016
Bilog Antenna	ETS-LINDGREN	3142E	00117537	Mar. 26, 2016	Mar. 25, 2017
Bilog Antenna	ETS-LINDGREN	3142E	00117542	Mar. 26, 2016	Mar. 25, 2017
Horn Antenna	ETS-LINDGREN	3117	00143207	Mar. 26, 2016	Mar. 25, 2017
Horn Antenna	ETS-LINDGREN	3117	00143209	Mar. 26, 2016	Mar. 25, 2017
Pre-amplifier	Sonoma	310N	185903	Mar. 26, 2016	Mar. 25, 2017
Pre-amplifier	HP	8447B	3008A00849	Mar. 26, 2016	Mar. 25, 2017
Cable	HUBER+SUHNER	100	SUCOFLEX	Mar. 26, 2016	Mar. 25, 2017
Positioning Controller	ETS-LINDGREN	2090	N/A	N/A	N/A

4. Conducted Emission Test

4.1 Test Standard and Limit

4.1.1 Test Standard
FCC Part 15.207

4.1.2 Test Limit

Conducted Emission Test Limit

Frequency	Maximum RF Line Voltage (dB μ V)	
	Quasi-peak Level	Average Level
150kHz~500kHz	66 ~ 56 *	56 ~ 46 *
500kHz~5MHz	56	46
5MHz~30MHz	60	50

Notes:

- (1) *Decreasing linearly with logarithm of the frequency.
- (2) The lower limit shall apply at the transition frequencies.
- (3) The limit decrease in line with the logarithm of the frequency in the range of 0.15 to 0.50MHz.

4.2 Test Setup

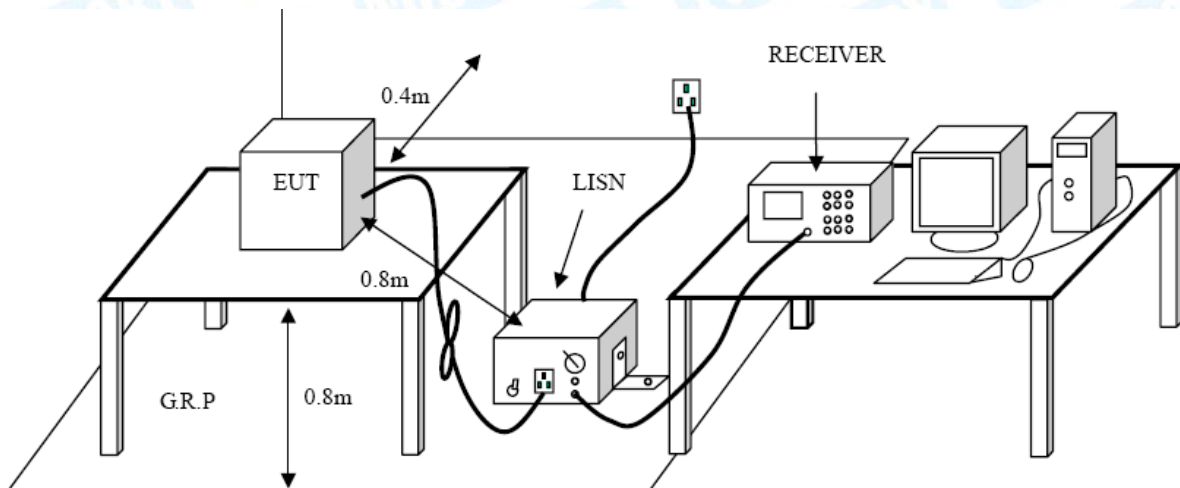

4.3 Test Procedure

The EUT was placed 0.8 meters from the horizontal ground plane with EUT being connected to the power mains through a line impedance stabilization network (LISN). All other support equipments powered from additional LISN(s). The LISN provide 50 Ohm/50uH of coupling impedance for the measuring instrument.

Interconnecting cables that hang closer than 40 cm to the ground plane shall be folded back and forth in the center forming a bundle 30 to 40 cm long.

I/O cables that are not connected to a peripheral shall be bundled in the center. The end of the cable may be terminated, if required, using the correct terminating impedance. The overall length shall not exceed 1 m.

LISN at least 80 cm from nearest part of EUT chassis

The bandwidth of EMI test receiver is set at 9kHz, and the test frequency band is from 0.15MHz to 30MHz.

4.4 EUT Operating Mode

Please refer to the description of test mode.

4.5 Test Data

Test data please refer the following pages.

EUT:	Bluetooth Speaker	Model Name :	HFD-810A
Temperature:	25 °C	Relative Humidity:	55%
Test Voltage:	AC 120V/60 Hz		
Terminal:	Line		
Test Mode:	USB Charging with TX GFSK Mode 2402 MHz		
Remark:	Only worse case is reported		

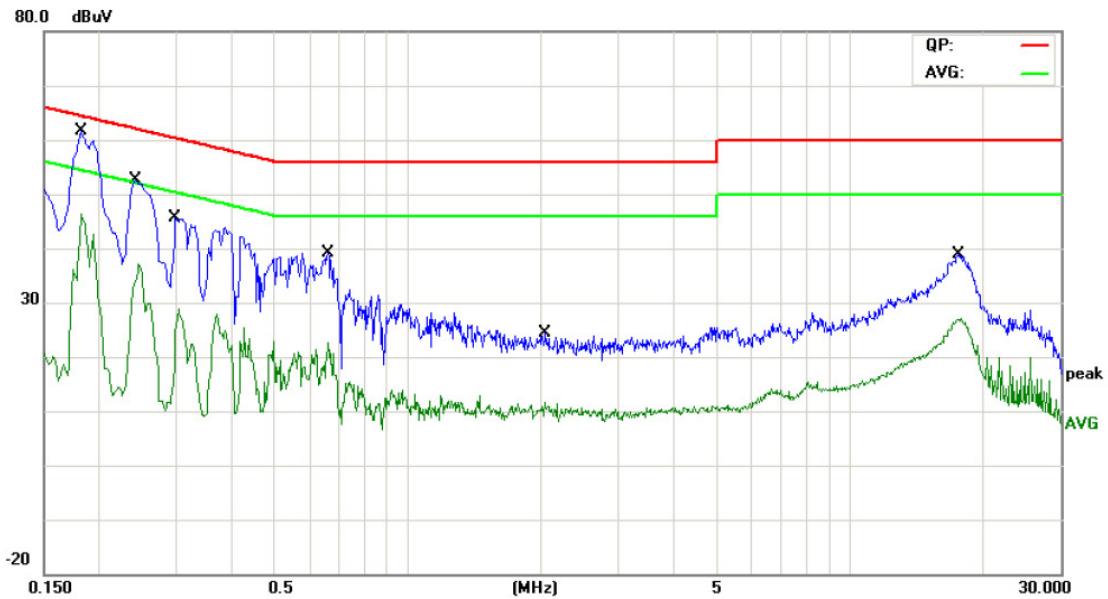

No.	Mk.	Freq.	Reading Level	Correct Factor	Measurement	Limit	Over	Detector
		MHz	dBuV	dB	dBuV	dBuV	dB	
1	*	0.1819	49.02	9.98	59.00	64.39	-5.39	QP
2		0.1819	31.59	9.98	41.57	54.39	-12.82	AVG
3		0.2420	39.88	10.02	49.90	62.02	-12.12	QP
4		0.2420	21.72	10.02	31.74	52.02	-20.28	AVG
5		0.2980	30.68	10.02	40.70	60.30	-19.60	QP
6		0.2980	8.23	10.02	18.25	50.30	-32.05	AVG
7		0.6580	25.57	10.10	35.67	56.00	-20.33	QP
8		0.6580	8.92	10.10	19.02	46.00	-26.98	AVG
9		2.0540	7.10	10.06	17.16	56.00	-38.84	QP
10		2.0540	-0.85	10.06	9.21	46.00	-36.79	AVG
11		17.6220	22.72	10.21	32.93	60.00	-27.07	QP
12		17.6220	15.76	10.21	25.97	50.00	-24.03	AVG

Emission Level= Read Level+ Correct Factor

EUT:	Bluetooth Speaker	Model Name :	HFD-810A
Temperature:	25 °C	Relative Humidity:	55%
Test Voltage:	AC 120V/60 Hz		
Terminal:	Neutral		
Test Mode:	USB Charging with TX GFSK Mode 2402 MHz		
Remark:	Only worse case is reported		

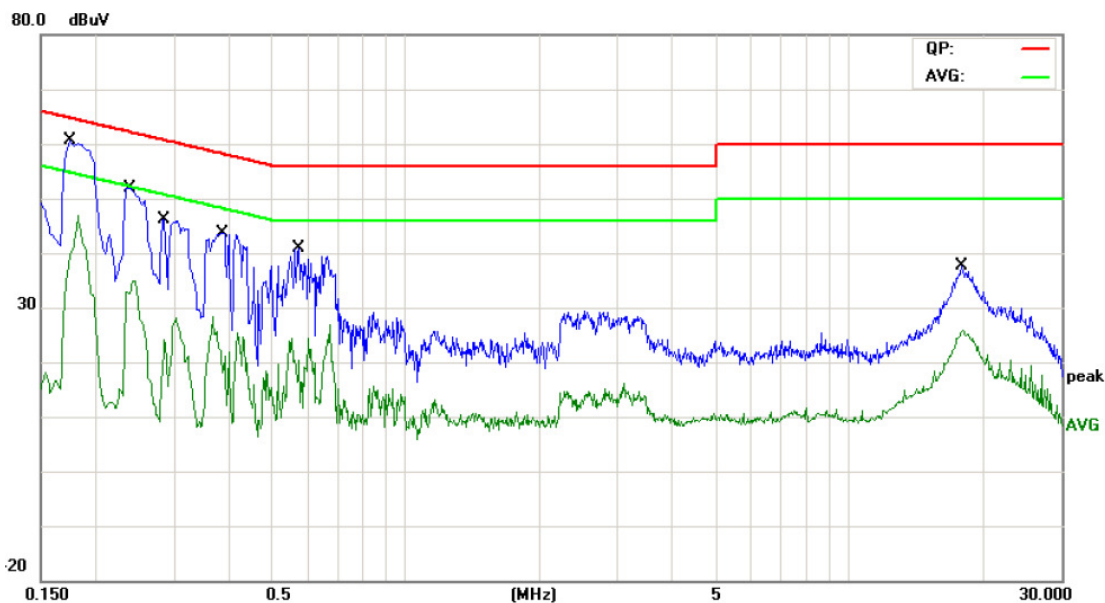

No.	Mk.	Freq. MHz	Reading Level dBuV	Correct Factor dB	Measure- ment dBuV	Limit dBuV	Over dB	Detector
1	*	0.1740	44.88	10.12	55.00	64.76	-9.76	QP
2		0.1740	22.06	10.12	32.18	54.76	-22.58	AVG
3		0.2380	39.41	10.11	49.52	62.16	-12.64	QP
4		0.2380	20.84	10.11	30.95	52.16	-21.21	AVG
5		0.2860	16.85	10.09	26.94	60.64	-33.70	QP
6		0.2860	0.85	10.09	10.94	50.64	-39.70	AVG
7		0.3860	28.28	10.06	38.34	58.15	-19.81	QP
8		0.3860	8.07	10.06	18.13	48.15	-30.02	AVG
9		0.5740	25.60	10.02	35.62	56.00	-20.38	QP
10		0.5740	7.88	10.02	17.90	46.00	-28.10	AVG
11		17.8540	20.95	10.06	31.01	60.00	-28.99	QP
12		17.8540	14.06	10.06	24.12	50.00	-25.88	AVG

Emission Level= Read Level+ Correct Factor

EUT:	Bluetooth Speaker	Model Name :	HFD-810A
Temperature:	25 °C	Relative Humidity:	55%
Test Voltage:	AC 240V/60 Hz		
Terminal:	Line		
Test Mode:	USB Charging with TX GFSK Mode 2402 MHz		
Remark:	Only worse case is reported		

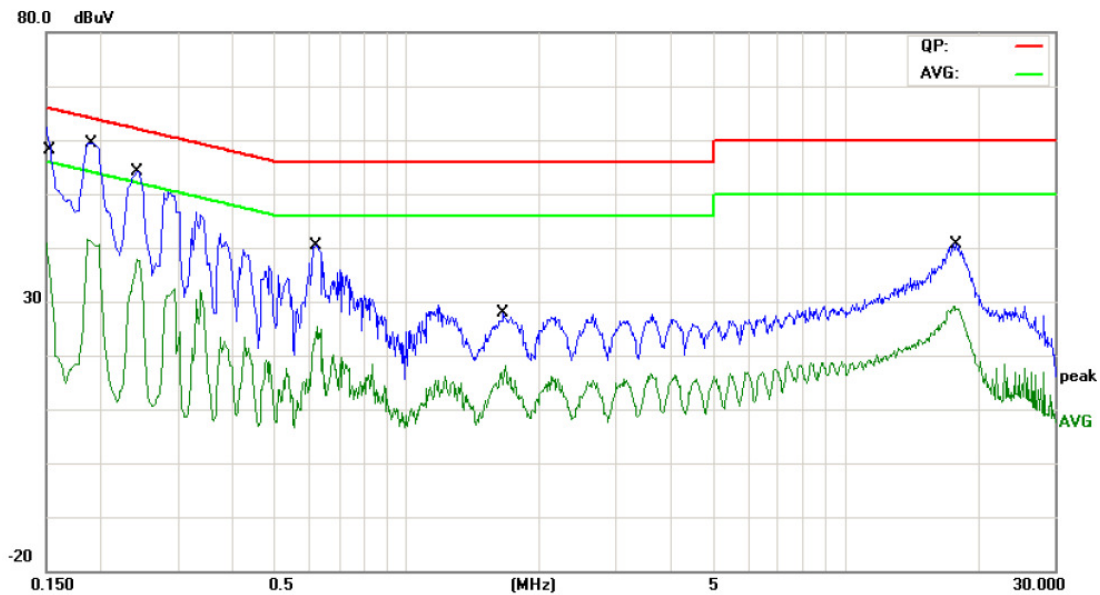

No.	Mk.	Freq. MHz	Reading Level dBuV	Correct Factor dB	Measure- ment dBuV	Limit dBuV	Over dB	Detector
1		0.1548	37.52	9.93	47.45	65.73	-18.28	QP
2		0.1548	14.29	9.93	24.22	55.73	-31.51	AVG
3	*	0.1900	46.57	10.00	56.57	64.03	-7.46	QP
4		0.1900	29.48	10.00	39.48	54.03	-14.55	AVG
5		0.2420	40.99	10.02	51.01	62.02	-11.01	QP
6		0.2420	25.26	10.02	35.28	52.02	-16.74	AVG
7		0.6180	26.40	10.08	36.48	56.00	-19.52	QP
8		0.6180	12.78	10.08	22.86	46.00	-23.14	AVG
9		1.6620	12.73	10.06	22.79	56.00	-33.21	QP
10		1.6620	3.52	10.06	13.58	46.00	-32.42	AVG
11		17.8580	24.15	10.20	34.35	60.00	-25.65	QP
12		17.8580	17.52	10.20	27.72	50.00	-22.28	AVG

Emission Level= Read Level+ Correct Factor

EUT:	Bluetooth Speaker	Model Name :	HFD-810A
Temperature:	25 °C	Relative Humidity:	55%
Test Voltage:	AC 240V/60 Hz		
Terminal:	Neutral		
Test Mode:	USB Charging with TX GFSK Mode 2402 MHz		
Remark:	Only worse case is reported		

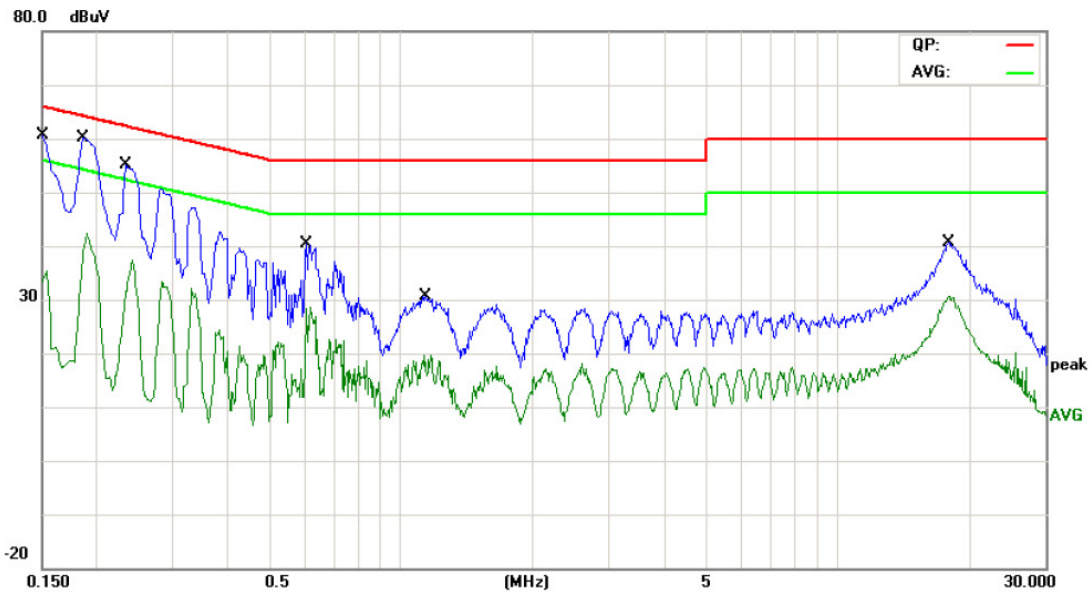

No.	Mk.	Freq. MHz	Reading Level dBuV	Correct Factor dB	Measure- ment dBuV	Limit dBuV	Over dB	Detector
1		0.1499	14.78	10.12	24.90	66.00	-41.10	QP
2		0.1499	9.41	10.12	19.53	56.00	-36.47	AVG
3	*	0.1860	46.51	10.12	56.63	64.21	-7.58	QP
4		0.1860	26.50	10.12	36.62	54.21	-17.59	AVG
5		0.2340	41.99	10.11	52.10	62.30	-10.20	QP
6		0.2340	23.04	10.11	33.15	52.30	-19.15	AVG
7		0.6060	24.73	10.02	34.75	56.00	-21.25	QP
8		0.6060	11.42	10.02	21.44	46.00	-24.56	AVG
9		1.1380	16.24	10.15	26.39	56.00	-29.61	QP
10		1.1380	5.46	10.15	15.61	46.00	-30.39	AVG
11		18.0379	25.14	10.06	35.20	60.00	-24.80	QP
12		18.0379	18.81	10.06	28.87	50.00	-21.13	AVG

Emission Level= Read Level+ Correct Factor

5. Radiated Emission Test

5.1 Test Standard and Limit

5.1.1 Test Standard

FCC Part 15.209

5.1.2 Test Limit

Radiated Emission Limit (9 kHz~1000MHz)

Frequency (MHz)	Field Strength (microvolt/meter)	Measurement Distance (meters)
0.009~0.490	2400/F(KHz)	300
0.490~1.705	24000/F(KHz)	30
1.705~30.0	30	30
30~88	100	3
88~216	150	3
216~960	200	3
Above 960	500	3

Radiated Emission Limit (Above 1000MHz)

Frequency (MHz)	Class B (dBuV/m)(at 3m)	
	Peak	Average
Above 1000	74	54

Note:

- (1) The tighter limit applies at the band edges.
- (2) Emission Level (dBuV/m)=20log Emission Level (uV/m)

5.2 Test Setup

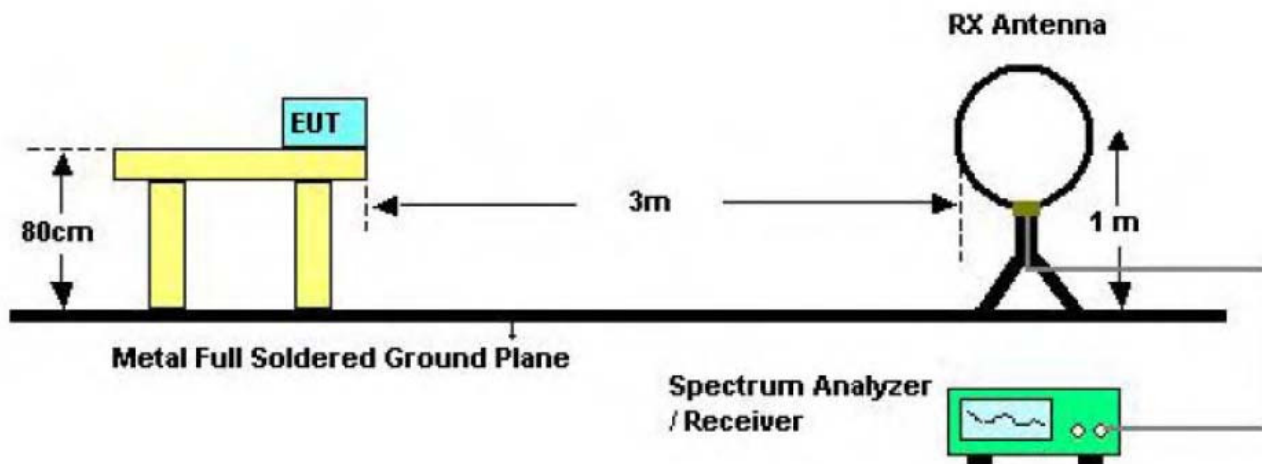

Bellow 30MHz Test Setup

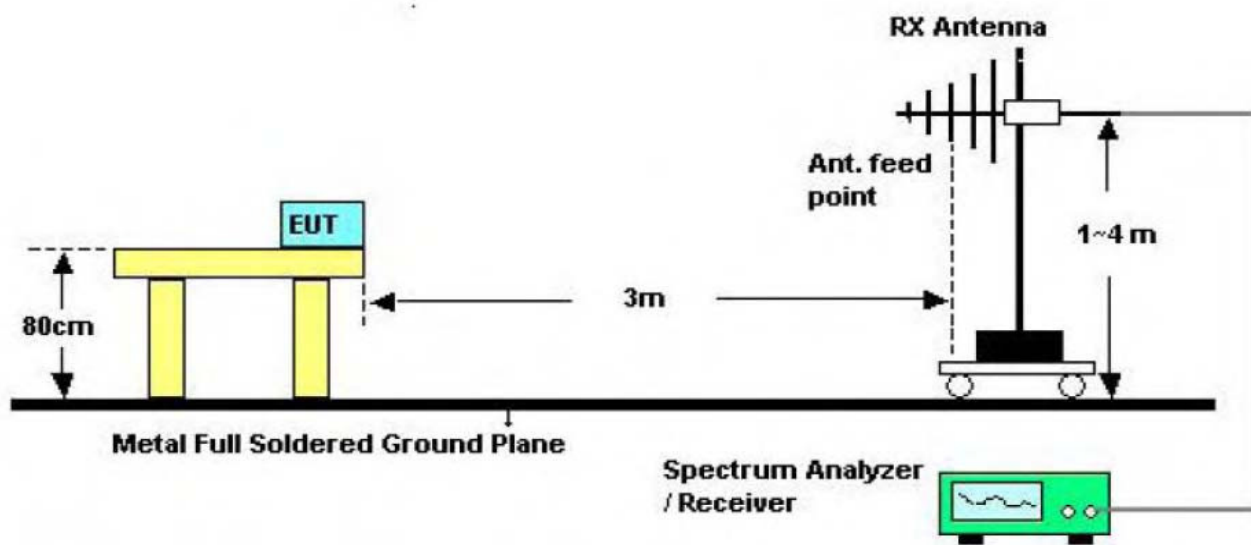

Bellow 1000MHz Test Setup

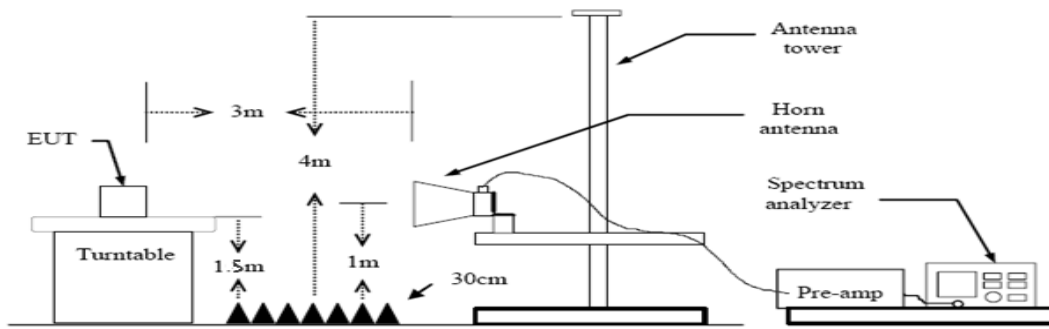

Above 1GHz Test Setup

5.3 Test Procedure

- (1) The measuring distance of 3m shall be used for measurements at frequency up to 1GHz and above 1 GHz. The EUT was placed on a rotating 0.8m high above ground, the table was rotated 360 degrees to determine the position of the highest radiation.
- (2) Measurements at frequency above 1GHz. The EUT was placed on a rotating 1.5m high above the ground. RF absorbers covered the ground plane with a minimum area of 3.0m by 3.0m between the EUT and measurement receiver antenna. The RF absorber shall not exceed 30cm in high above the conducting floor. The table was rotated 360 degrees to determine the position of the highest radiation.
- (3) The Test antenna shall vary between 1m and 4m, Both Horizontal and Vertical antenna are set to make measurement.
- (4) The initial step in collecting conducted emission data is a spectrum analyzer peak detector mode pre-scanning the measurement frequency range. Significant peaks are then marked and then Quasi Peak detector mode re-measured.
- (5) If the Peak Mode measured value compliance with and lower than Quasi Peak Mode Limit Bellow 1 GHz, the EUT shall be deemed to meet QP Limits and then no additional QP Mode measurement performed. But the Peak Value and average value both need to comply with applicable limit above 1 GHz.
- (6) Testing frequency range below 1GHz the measuring instrument use VBW=120 kHz with Quasi-peak detection.
- (7) Testing frequency range above 1GHz the measuring instrument use RBW=1 MHz and VBW=3 MHz with Peak Detector for Peak Values, and use RBW=1 MHz and VBW=10 Hz with Peak Detector for Average Values.
- (8) For the actual test configuration, please see the test setup photo.

5.4 EUT Operating Condition

The Equipment Under Test was set to Continual Transmitting in maximum power in TX mode.

5.5 Test Data

Remark: During testing above 1GHz the measuring instrument use RBW=1 MHz and VBW=3 MHz with Peak Detector for Peak Values, and use RBW=1 MHz and VBW=1 kHz with Peak Detector for Average Values.

Test data please refer the following pages.

EUT:	Bluetooth Speaker	Model Name :	HFD-810A
Temperature:	25 °C	Relative Humidity:	55%
Test Voltage:	AC 120V/60Hz		
Ant. Pol.	Horizontal		
Test Mode:	TX GFSK Mode 2402MHz		
Remark:	Only worse case is reported		

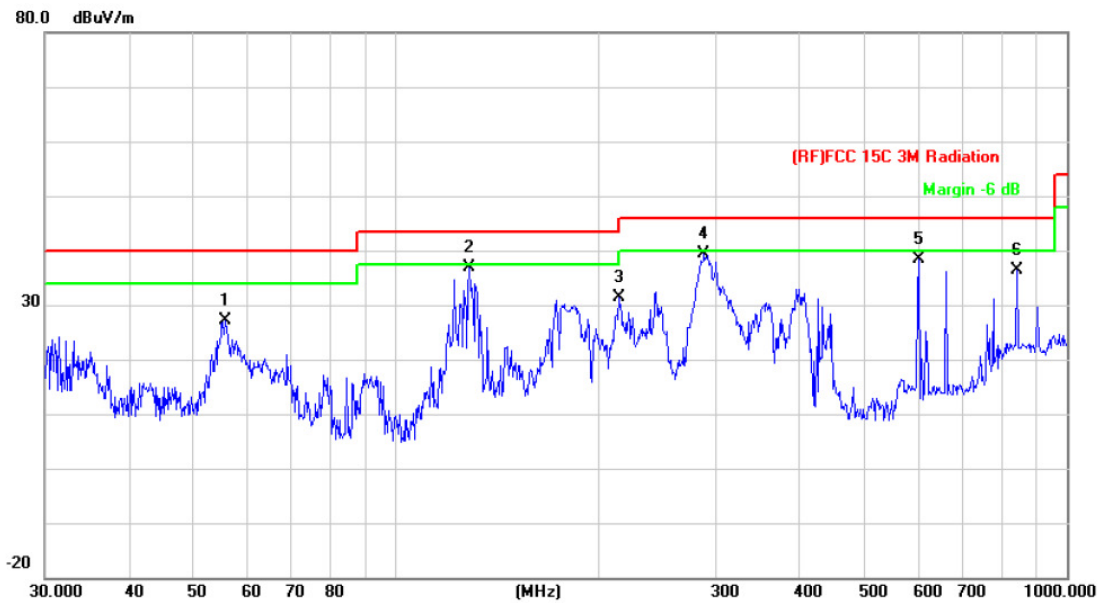

No.	Mk.	Freq. MHz	Reading Level dBuV	Correct Factor dB/m	Measure- ment dBuV/m	Limit dBuV/m	Over dB	Detector
1		55.6094	51.57	-24.46	27.11	40.00	-12.89	peak
2		128.5629	59.00	-22.22	36.78	43.50	-6.72	peak
3		215.2675	51.22	-19.73	31.49	43.50	-12.01	peak
4	*	287.9904	56.79	-17.32	39.47	46.00	-6.53	peak
5		601.4265	47.86	-9.41	38.45	46.00	-7.55	peak
6		842.1295	42.83	-6.56	36.27	46.00	-9.73	peak

*:Maximum data x:Over limit !:over margin

Emission Level= Read Level+ Correct Factor

EUT:	Bluetooth Speaker	Model Name :	HFD-810A
Temperature:	25 °C	Relative Humidity:	55%
Test Voltage:	AC 120V/60Hz		
Ant. Pol.	Vertical		
Test Mode:	TX GFSK Mode 2402MHz		
Remark:	Only worse case is reported		



No.	Mk.	Freq. MHz	Reading Level dBuV	Correct Factor dB/m	Measure- ment dBuV/m	Limit dBuV/m	Over dB	Detector
1	*	30.3170	50.57	-14.15	36.42	40.00	-3.58	peak
2		54.2610	56.06	-24.45	31.61	40.00	-8.39	peak
3		76.7806	52.58	-23.39	29.19	40.00	-10.81	peak
4		132.2204	56.28	-22.13	34.15	43.50	-9.35	peak
5		300.3672	56.15	-17.07	39.08	46.00	-6.92	peak
6		393.4723	44.49	-13.23	31.26	46.00	-14.74	peak

*:Maximum data x:Over limit !:over margin

Emission Level= Read Level+ Correct Factor

EUT:	Bluetooth Speaker	Model Name :	HFD-810A
Temperature:	25 °C	Relative Humidity:	55%
Test Voltage:	AC 120V/60Hz		
Ant. Pol.	Horizontal		
Test Mode:	TX $\pi/4$ -DQPSK Mode 2402MHz		
Remark:	Only worse case is reported		

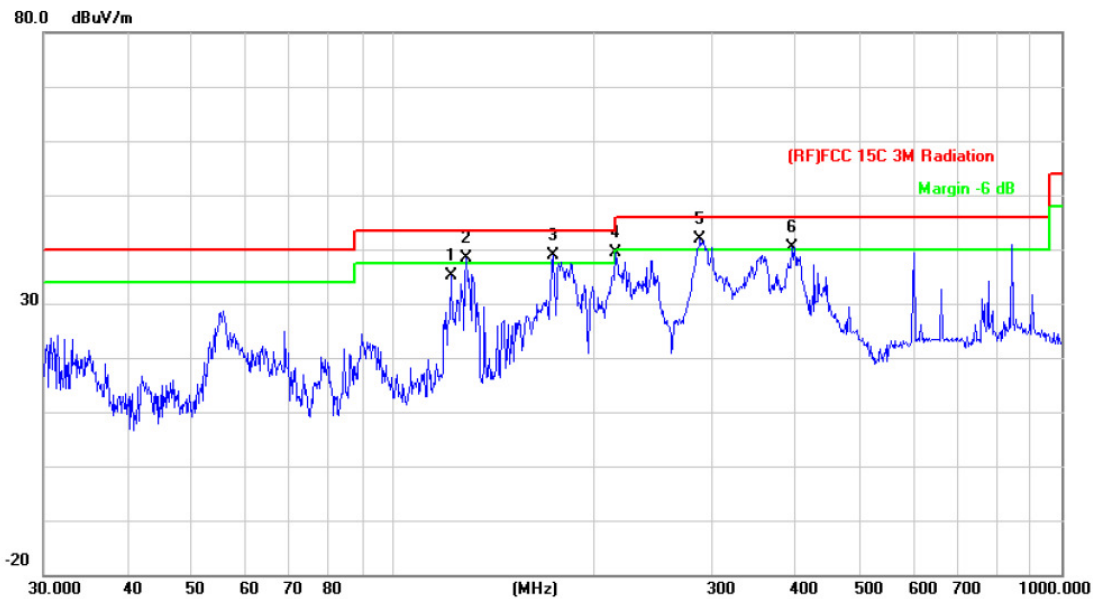

No.	Mk.	Freq. MHz	Reading Level dBuV	Correct Factor dB/m	Measure- ment dBuV/m	Limit dBuV/m	Over dB	Detector
1		121.9753	57.62	-22.44	35.18	43.50	-8.32	peak
2	!	128.5629	60.50	-22.22	38.28	43.50	-5.22	peak
3	!	173.2050	59.86	-20.98	38.88	43.50	-4.62	peak
4	*	215.2675	59.22	-19.73	39.49	43.50	-4.01	peak
5	!	287.9904	59.29	-17.32	41.97	46.00	-4.03	peak
6	!	394.8543	53.52	-13.15	40.37	46.00	-5.63	peak

*:Maximum data x:Over limit !:over margin

Emission Level= Read Level+ Correct Factor

EUT:	Bluetooth Speaker	Model Name :	HFD-810A
Temperature:	25 °C	Relative Humidity:	55%
Test Voltage:	AC 120V/60Hz		
Ant. Pol.	Vertical		
Test Mode:	TX π/4-DQPSK Mode 2402MHz		
Remark:	Only worse case is reported		

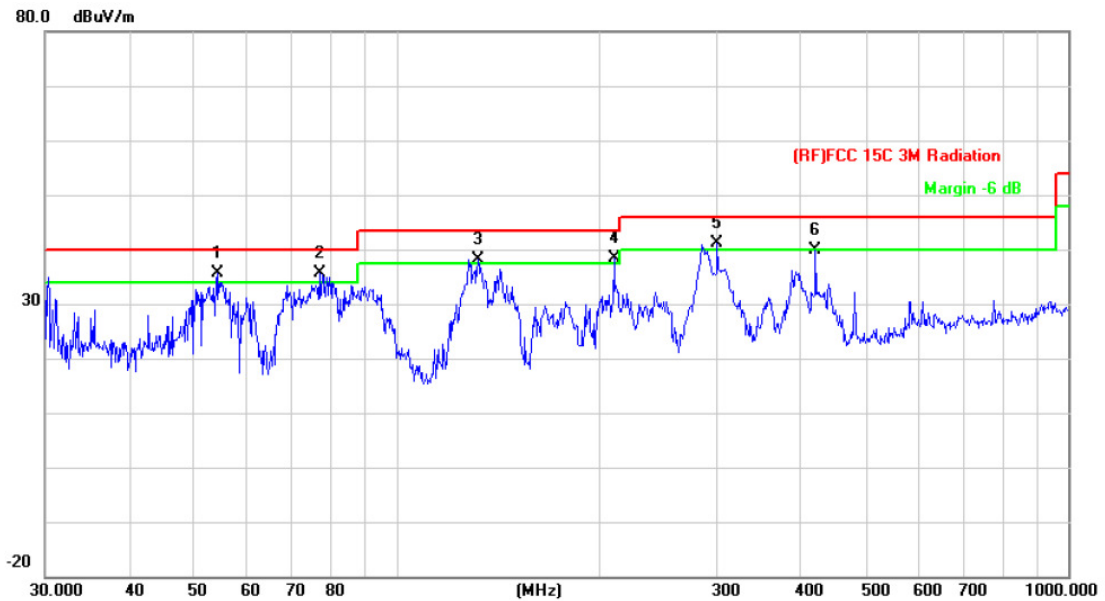

No.	Mk.	Freq. MHz	Reading Level dBuV	Correct Factor dB/m	Measure- ment dBuV/m	Limit dBuV/m	Over dB	Detector
1	!	54.2610	60.06	-24.45	35.61	40.00	-4.39	peak
2	*	76.7806	59.08	-23.39	35.69	40.00	-4.31	peak
3	!	132.2204	60.28	-22.13	38.15	43.50	-5.35	peak
4	!	210.7860	58.19	-19.92	38.27	43.50	-5.23	peak
5	!	300.3672	58.15	-17.07	41.08	46.00	-4.92	peak
6		420.5803	52.76	-12.91	39.85	46.00	-6.15	peak

*:Maximum data x:Over limit !:over margin

Emission Level= Read Level+ Correct Factor

EUT:	Bluetooth Speaker	Model Name :	HFD-810A
Temperature:	25 °C	Relative Humidity:	55%
Test Voltage:	AC 120V/60Hz		
Ant. Pol.	Horizontal		
Test Mode:	TX 8-DPSK Mode 2402MHz		
Remark:	Only worse case is reported		

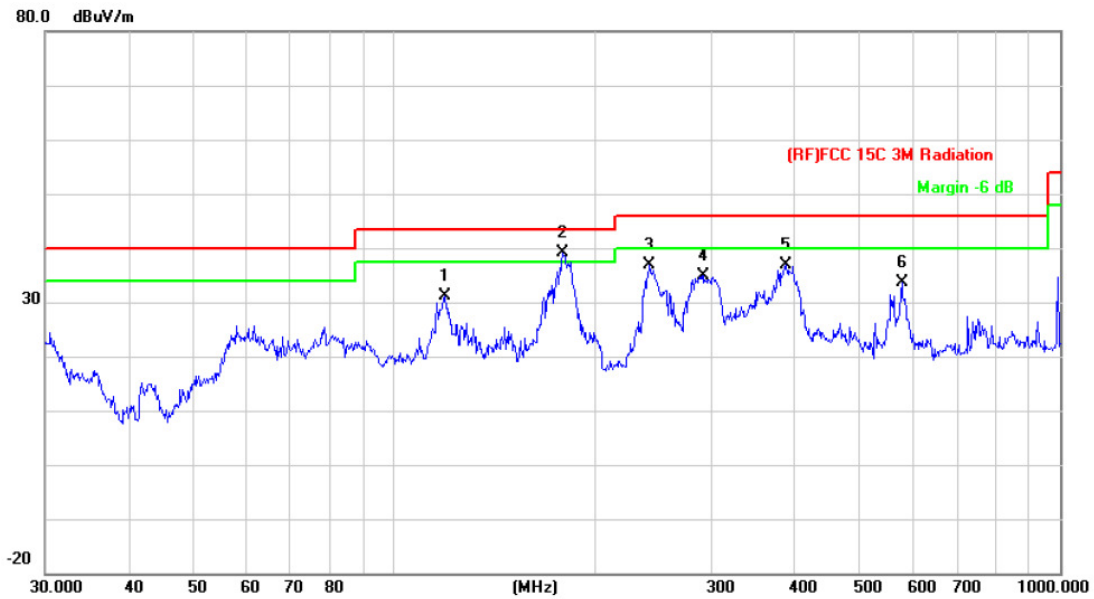

No.	Mk.	Freq.	Reading Level	Correct Factor	Measurement	Limit	Over	
		MHz	dBuV	dB/m	dBuV/m	dBuV/m	dB	Detector
1		119.4360	53.56	-22.47	31.09	43.50	-12.41	peak
2	*	179.3863	59.83	-20.61	39.22	43.50	-4.28	peak
3		241.6762	55.51	-18.52	36.99	46.00	-9.01	peak
4		292.0582	52.07	-17.24	34.83	46.00	-11.17	peak
5		387.9920	50.43	-13.60	36.83	46.00	-9.17	peak
6		578.6698	43.69	-10.03	33.66	46.00	-12.34	peak

*:Maximum data x:Over limit !:over margin

Emission Level= Read Level+ Correct Factor

EUT:	Bluetooth Speaker	Model Name :	HFD-810A
Temperature:	25 °C	Relative Humidity:	55%
Test Voltage:	AC 120V/60Hz		
Ant. Pol.	Vertical		
Test Mode:	TX 8-DPSK Mode 2402MHz		
Remark:	Only worse case is reported		

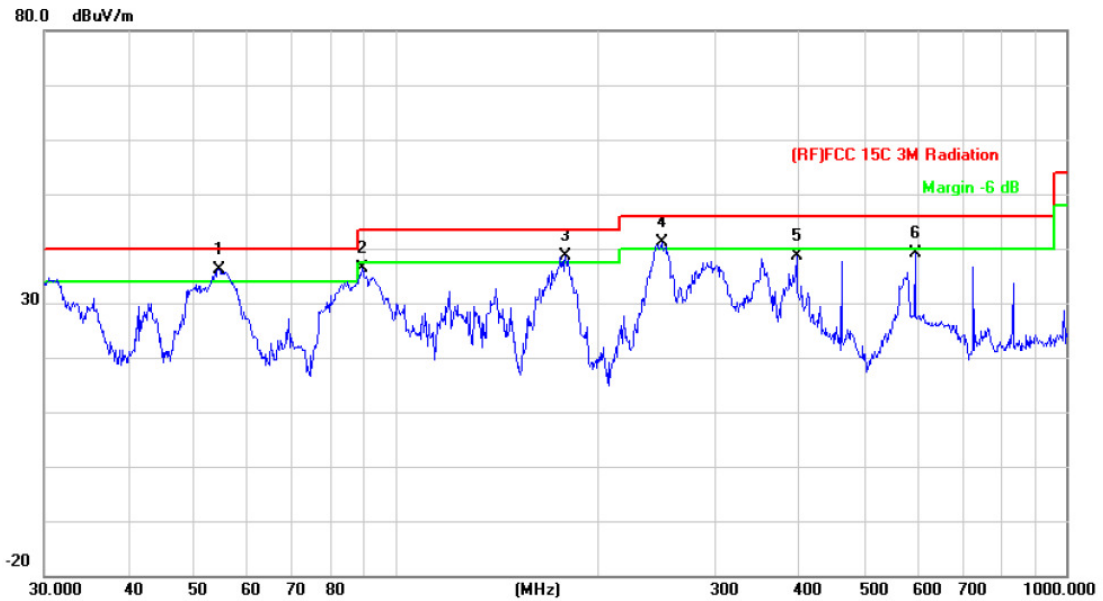

No.	Mk.	Freq. MHz	Reading Level dBuV	Correct Factor dB/m	Measure- ment dBuV/m	Limit dBuV/m	Over dB	Detector
1	*	54.6428	60.65	-24.45	36.20	40.00	-3.80	peak
2		89.2762	59.08	-22.74	36.34	43.50	-7.16	peak
3	!	179.3863	59.36	-20.61	38.75	43.50	-4.75	peak
4	!	249.4250	59.33	-18.15	41.18	46.00	-4.82	peak
5		396.2414	51.68	-13.05	38.63	46.00	-7.37	peak
6		595.1327	48.60	-9.59	39.01	46.00	-6.99	peak

*:Maximum data x:Over limit !:over margin

Emission Level= Read Level+ Correct Factor

EUT:	Bluetooth Speaker	Model Name :	HFD-810A
Temperature:	25 °C	Relative Humidity:	55%
Test Voltage:	AC 120V/60Hz		
Ant. Pol.	Horizontal		
Test Mode:	TX GFSK Mode 2402MHz		
Remark:	No report for the emission which more than 10 dB below the prescribed limit.		

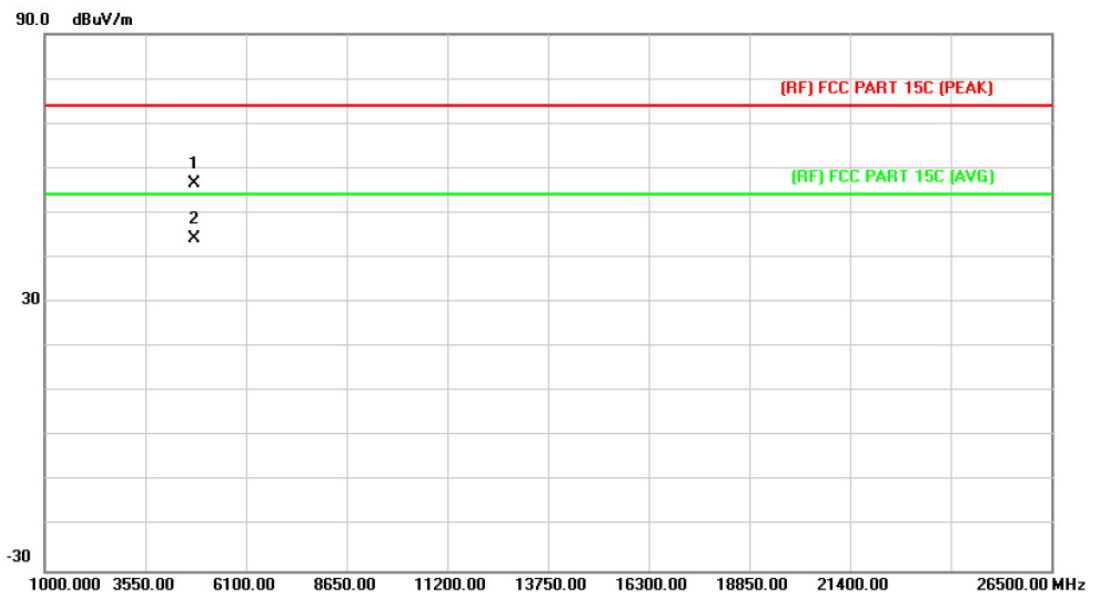

No.	Mk.	Freq. MHz	Reading Level dBuV	Correct Factor dB/m	Measure- ment dBuV/m	Limit dBuV/m	Over dB	Detector
1		4803.253	43.09	13.44	56.53	74.00	-17.47	peak
2	*	4804.123	30.88	13.44	44.32	54.00	-9.68	AVG

Emission Level= Read Level+ Correct Factor

EUT:	Bluetooth Speaker	Model Name :	HFD-810A
Temperature:	25 °C	Relative Humidity:	55%
Test Voltage:	AC 120V/60Hz		
Ant. Pol.	Vertical		
Test Mode:	TX GFSK Mode 2402MHz		
Remark:	No report for the emission which more than 10 dB below the prescribed limit.		

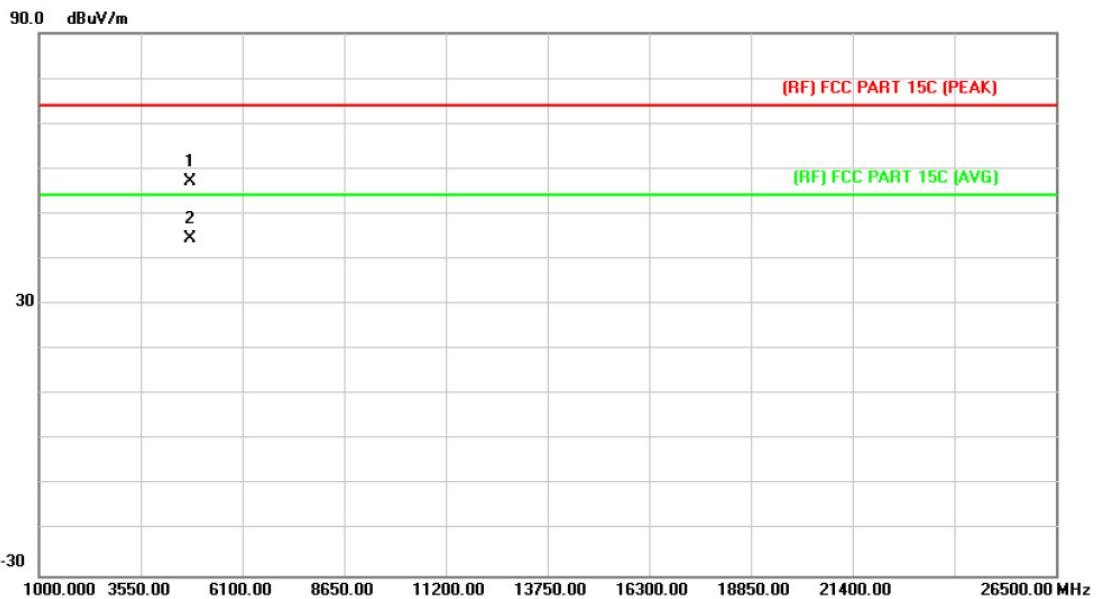

No.	Mk.	Freq. MHz	Reading Level dBuV	Correct Factor dB/m	Measure- ment dBuV/m	Limit dBuV/m	Over dB	Detector
1		4803.787	43.76	13.44	57.20	74.00	-16.80	peak
2	*	4803.907	31.25	13.44	44.69	54.00	-9.31	AVG

Emission Level= Read Level+ Correct Factor

EUT:	Bluetooth Speaker	Model Name :	HFD-810A
Temperature:	25 °C	Relative Humidity:	55%
Test Voltage:	AC 120V/60Hz		
Ant. Pol.	Horizontal		
Test Mode:	TX GFSK Mode 2441MHz		
Remark:	No report for the emission which more than 10 dB below the prescribed limit.		

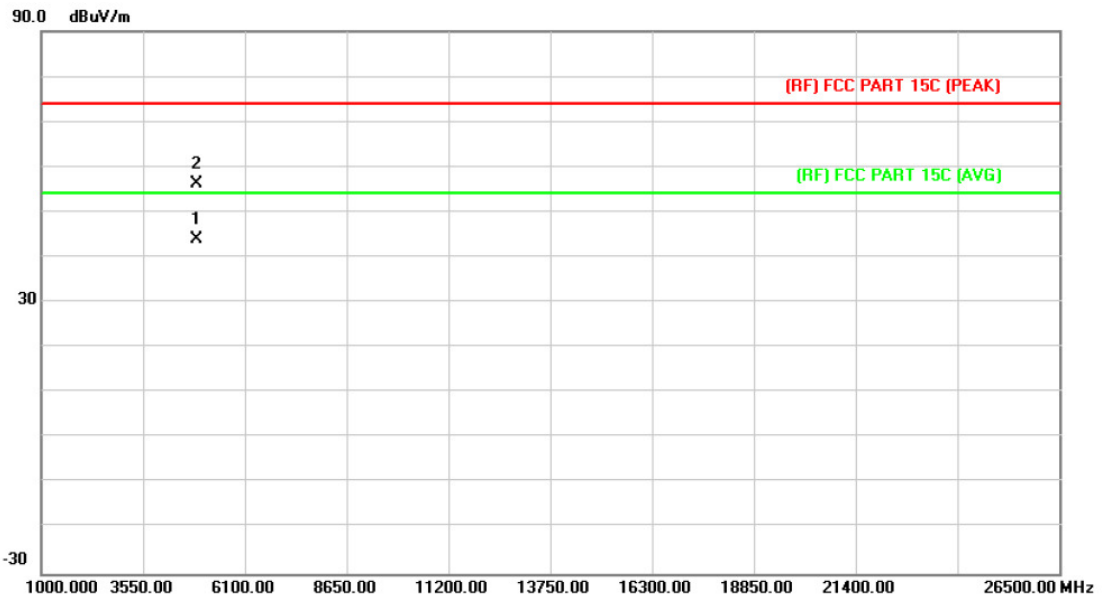

No.	Mk.	Freq. MHz	Reading Level dBuV	Correct Factor dB/m	Measure- ment dBuV/m	Limit dBuV/m	Over dB	Detector
1	*	4880.620	30.00	13.89	43.89	54.00	-10.11	AVG
2		4882.531	42.48	13.90	56.38	74.00	-17.62	peak

Emission Level= Read Level+ Correct Factor

EUT:	Bluetooth Speaker	Model Name :	HFD-810A
Temperature:	25 °C	Relative Humidity:	55%
Test Voltage:	AC 120V/60Hz		
Ant. Pol.	Vertical		
Test Mode:	TX GFSK Mode 2441MHz		
Remark:	No report for the emission which more than 10 dB below the prescribed limit.		

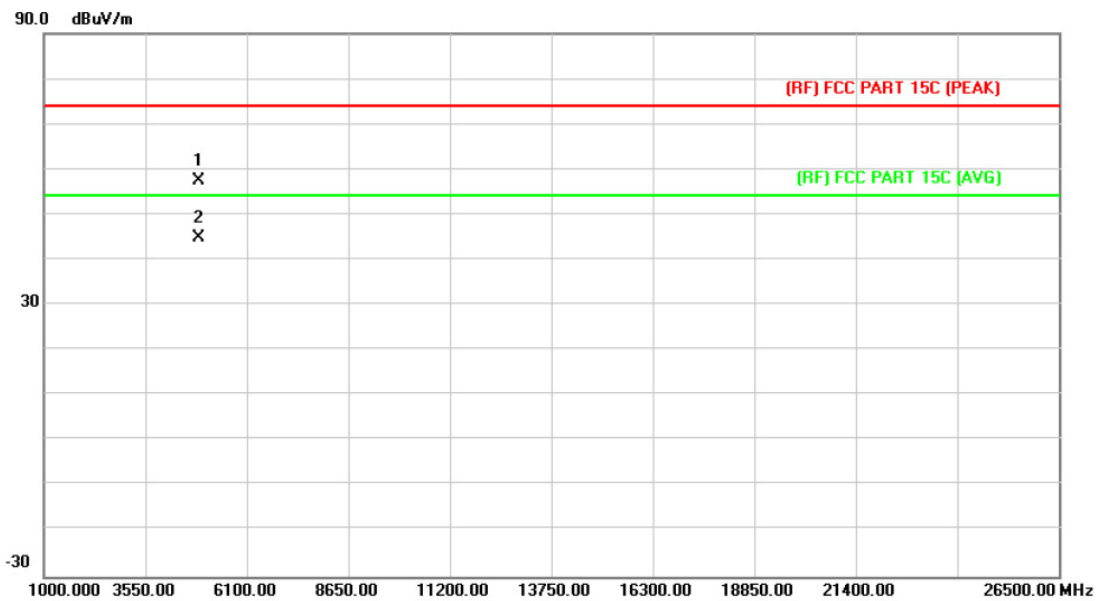

No.	Mk.	Freq. MHz	Reading Level dBuV	Correct Factor dB/m	Measure- ment dBuV/m	Limit dBuV/m	Over dB	Detector
1		4881.352	43.44	13.90	57.34	74.00	-16.66	peak
2	*	4882.312	30.97	13.90	44.87	54.00	-9.13	AVG

Emission Level= Read Level+ Correct Factor

EUT:	Bluetooth Speaker	Model Name :	HFD-810A
Temperature:	25 °C	Relative Humidity:	55%
Test Voltage:	AC 120V/60Hz		
Ant. Pol.	Horizontal		
Test Mode:	TX GFSK Mode 2480MHz		
Remark:	No report for the emission which more than 10 dB below the prescribed limit.		

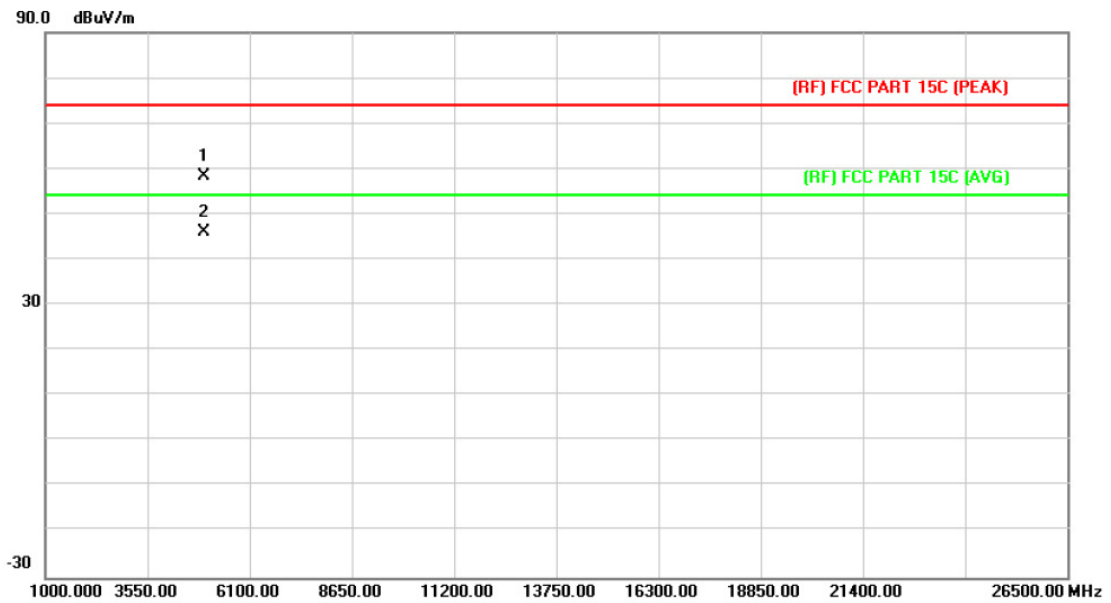

No.	Mk.	Freq. MHz	Reading Level dBuV	Correct Factor dB/m	Measure- ment dBuV/m	Limit dBuV/m	Over dB	Detector
1		4959.445	43.96	14.36	58.32	74.00	-15.68	peak
2	*	4960.804	31.77	14.36	46.13	54.00	-7.87	AVG

Emission Level= Read Level+ Correct Factor

EUT:	Bluetooth Speaker	Model Name :	HFD-810A
Temperature:	25 °C	Relative Humidity:	55%
Test Voltage:	AC 120V/60Hz		
Ant. Pol.	Vertical		
Test Mode:	TX GFSK Mode 2480MHz		
Remark:	No report for the emission which more than 10 dB below the prescribed limit.		

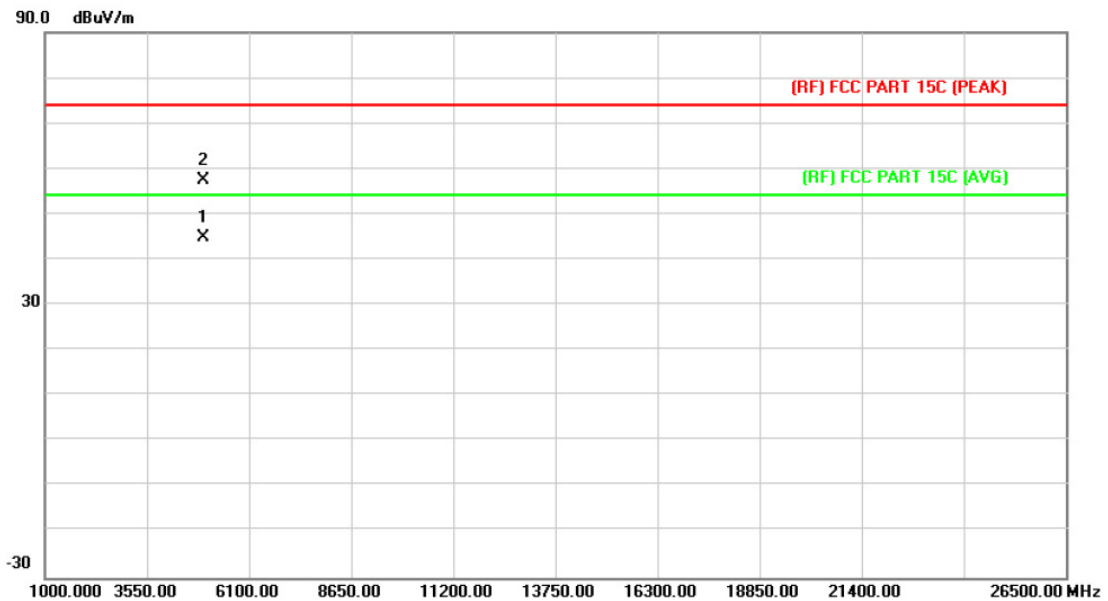

No.	Mk.	Freq. MHz	Reading Level dBuV	Correct Factor dB/m	Measure- ment dBuV/m	Limit dBuV/m	Over dB	Detector
1	*	4959.743	30.63	14.36	44.99	54.00	-9.01	AVG
2		4960.493	43.16	14.36	57.52	74.00	-16.48	peak

Emission Level= Read Level+ Correct Factor

EUT:	Bluetooth Speaker	Model Name :	HFD-810A
Temperature:	25 °C	Relative Humidity:	55%
Test Voltage:	AC 120V/60Hz		
Ant. Pol.	Horizontal		
Test Mode:	TX 8-DPSK Mode 2402MHz		
Remark:	No report for the emission which more than 10 dB below the prescribed limit.		

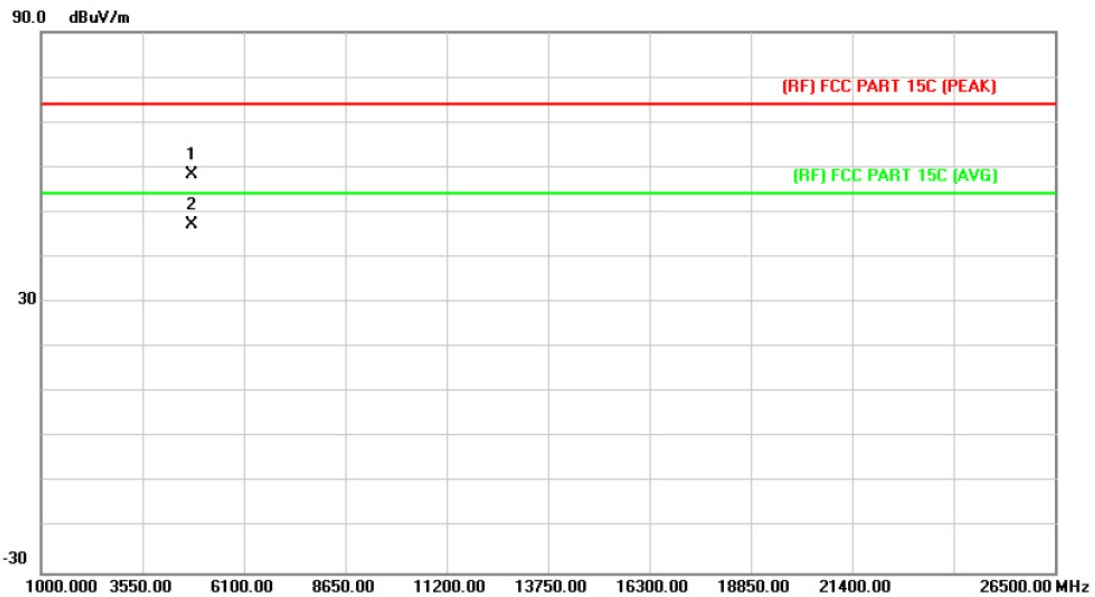

No.	Mk.	Freq. MHz	Reading Level dBuV	Correct Factor dB/m	Measure- ment dBuV/m	Limit dBuV/m	Over dB	Detector
1		4803.649	44.87	13.44	58.31	74.00	-15.69	peak
2	*	4803.881	33.82	13.44	47.26	54.00	-6.74	AVG

Emission Level= Read Level+ Correct Factor

EUT:	Bluetooth Speaker	Model Name :	HFD-810A
Temperature:	25 °C	Relative Humidity:	55%
Test Voltage:	AC 120V/60Hz		
Ant. Pol.	Vertical		
Test Mode:	TX 8-DPSK Mode 2402MHz		
Remark:	No report for the emission which more than 10 dB below the prescribed limit.		

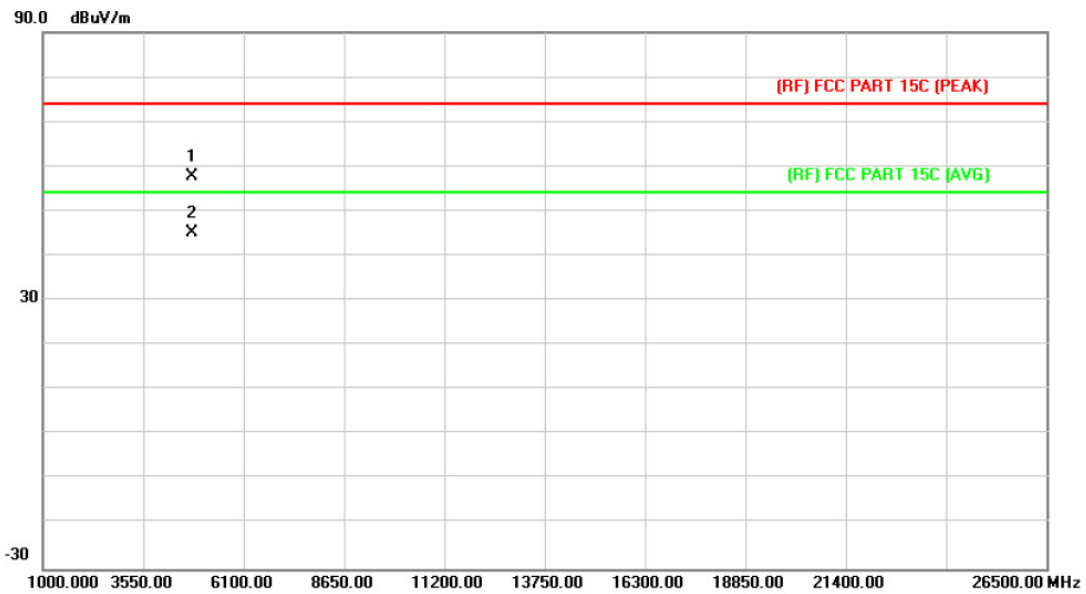

No.	Mk.	Freq. MHz	Reading Level dBuV	Correct Factor dB/m	Measure- ment dBuV/m	Limit dBuV/m	Over dB	Detector
1		4804.017	44.24	13.44	57.68	74.00	-16.32	peak
2	*	4804.457	31.77	13.44	45.21	54.00	-8.79	AVG

Emission Level= Read Level+ Correct Factor

EUT:	Bluetooth Speaker	Model Name :	HFD-810A
Temperature:	25 °C	Relative Humidity:	55%
Test Voltage:	AC 120V/60Hz		
Ant. Pol.	Horizontal		
Test Mode:	TX 8-DPSK Mode 2441MHz		
Remark:	No report for the emission which more than 10 dB below the prescribed limit.		

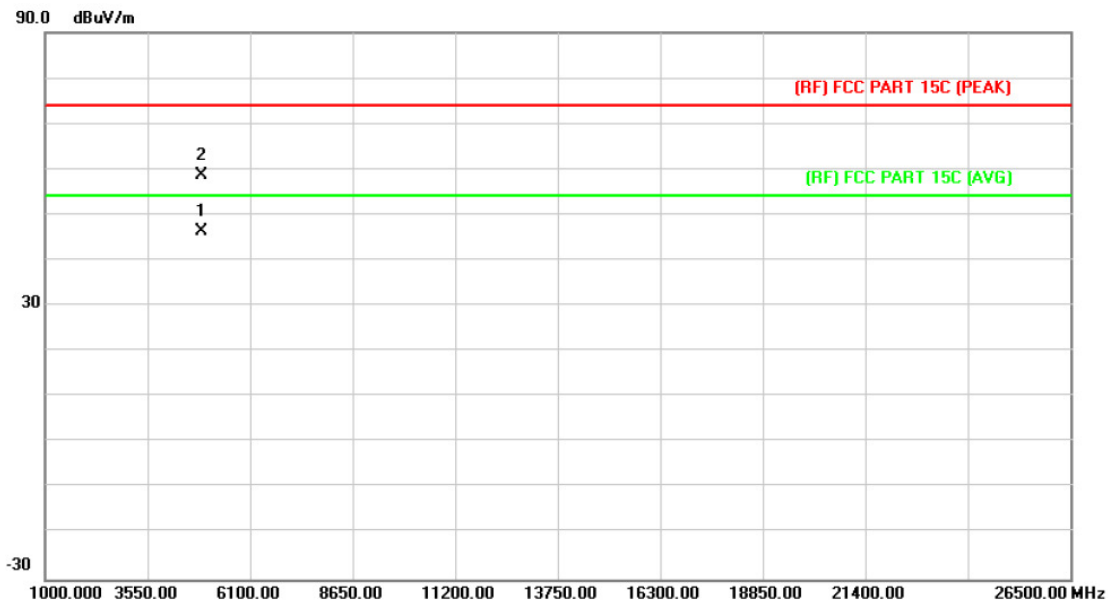

No.	Mk.	Freq.	Reading Level	Correct Factor	Measurement	Limit	Over	
		MHz	dBuV	dB/m	dBuV/m	dBuV/m	dB	Detector
1	*	4881.511	32.43	13.90	46.33	54.00	-7.67	AVG
2		4882.130	44.74	13.90	58.64	74.00	-15.36	peak

Emission Level= Read Level+ Correct Factor

EUT:	Bluetooth Speaker	Model Name :	HFD-810A
Temperature:	25 °C	Relative Humidity:	55%
Test Voltage:	AC 120V/60Hz		
Ant. Pol.	Vertical		
Test Mode:	TX 8-DPSK Mode 2441MHz		
Remark:	No report for the emission which more than 10 dB below the prescribed limit.		

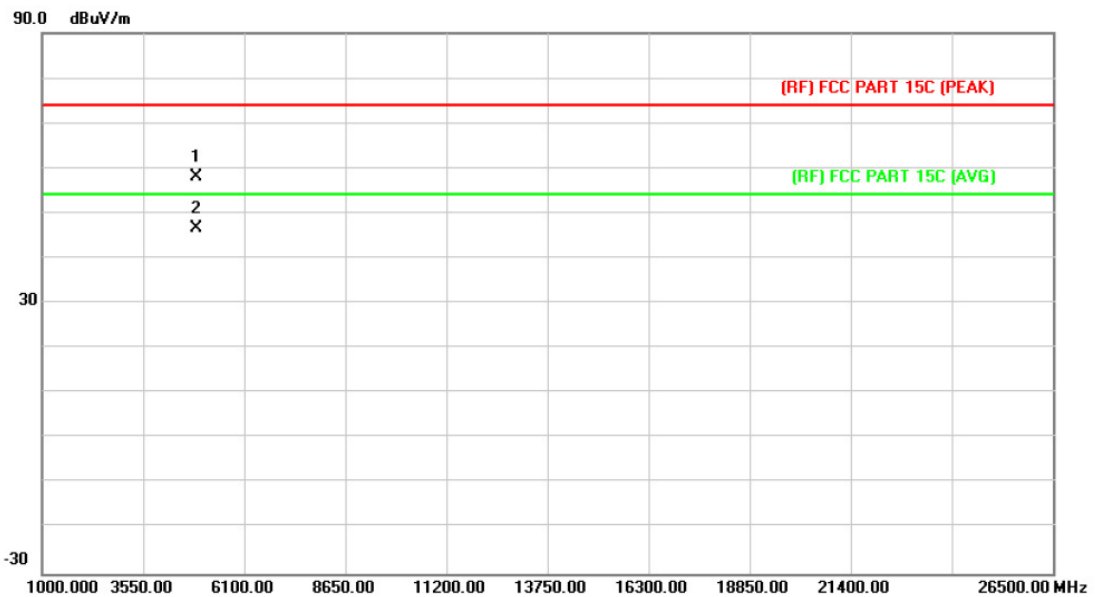

No.	Mk.	Freq.	Reading Level	Correct Factor	Measurement	Limit	Over	Detector
		MHz	dBuV	dB/m	dBuV/m	dBuV/m	dB	
1		4881.649	44.22	13.90	58.12	74.00	-15.88	peak
2	*	4882.188	32.84	13.90	46.74	54.00	-7.26	AVG

Emission Level= Read Level+ Correct Factor

EUT:	Bluetooth Speaker	Model Name :	HFD-810A
Temperature:	25 °C	Relative Humidity:	55%
Test Voltage:	AC 120V/60Hz		
Ant. Pol.	Horizontal		
Test Mode:	TX 8-DPSK Mode 2480MHz		
Remark:	No report for the emission which more than 10 dB below the prescribed limit.		

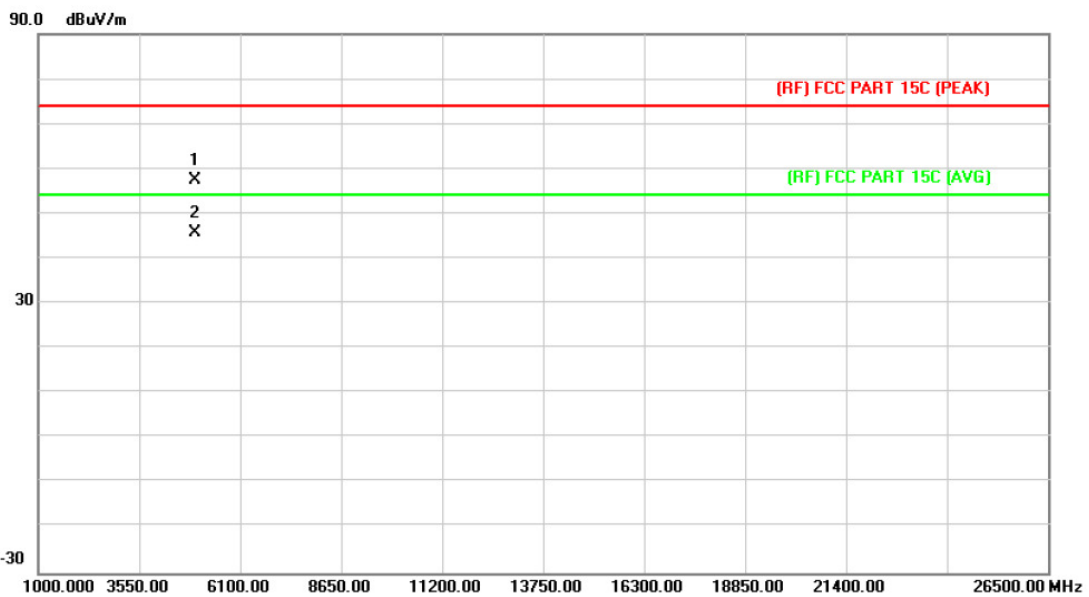

No.	Mk.	Freq. MHz	Reading Level dBuV	Correct Factor dB/m	Measure- ment dBuV/m	Limit dBuV/m	Over dB	Detector
1		4959.699	43.02	14.36	57.38	74.00	-16.62	peak
2	*	4960.430	31.31	14.36	45.67	54.00	-8.33	AVG

Emission Level= Read Level+ Correct Factor

EUT:	Bluetooth Speaker	Model Name :	HFD-810A
Temperature:	25 °C	Relative Humidity:	55%
Test Voltage:	AC 120V/60Hz		
Ant. Pol.	Vertical		
Test Mode:	TX 8-DPSK Mode 2480MHz		
Remark:	No report for the emission which more than 10 dB below the prescribed limit.		

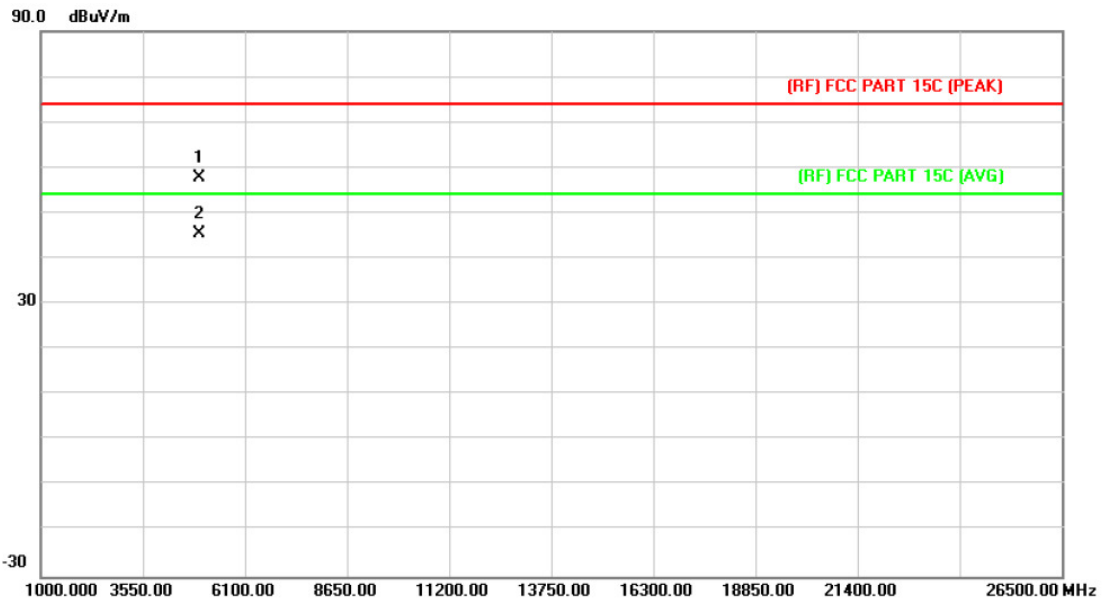

No.	Mk.	Freq. MHz	Reading Level dBuV	Correct Factor dB/m	Measure- ment dBuV/m	Limit dBuV/m	Over dB	Detector
1		4959.754	43.52	14.36	57.88	74.00	-16.12	peak
2	*	4960.147	31.10	14.36	45.46	54.00	-8.54	AVG

Emission Level= Read Level+ Correct Factor

6. Restricted Bands Requirement

6.1 Test Standard and Limit

6.1.1 Test Standard

FCC Part 15.209

FCC Part 15.205

6.1.2 Test Limit

Restricted Frequency Band (MHz)	Class B (dBUV/m)(at 3m)	
	Peak	Average
2310 ~2390	74	54
2483.5 ~2500	74	54

Note: All restriction bands have been tested, only the worst case is reported.

6.2 Test Setup

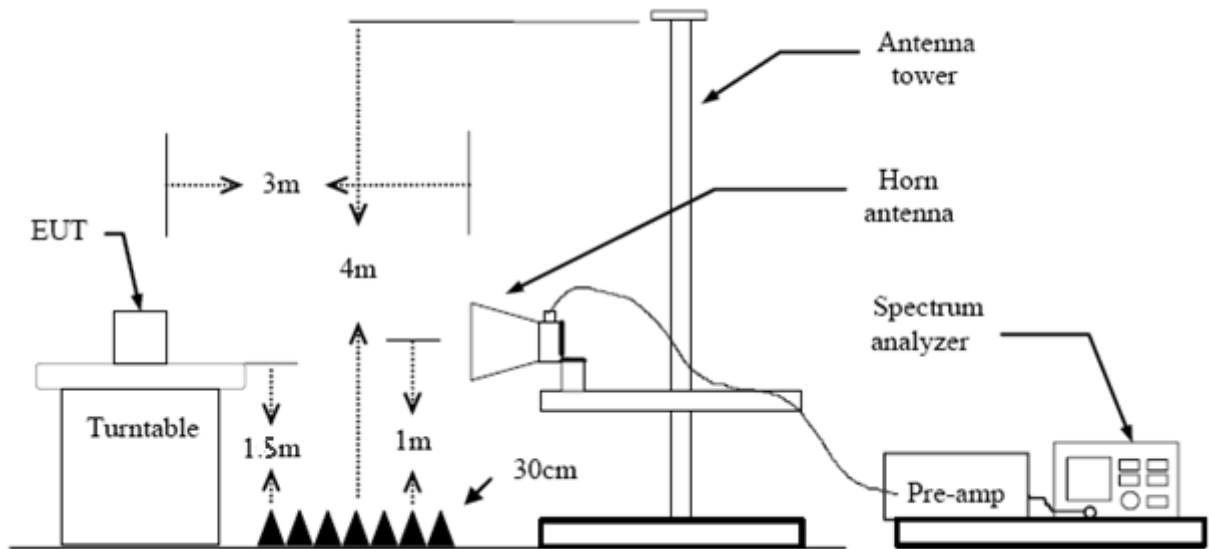

6.3 Test Procedure

- (1) The measuring distance of 3m shall be used for measurements at frequency up to 1GHz and above 1 GHz. The EUT was placed on a rotating 0.8m high above ground, the table was rotated 360 degrees to determine the position of the highest radiation.
- (2) Measurements at frequency above 1GHz. The EUT was placed on a rotating 1.5m high above the ground. RF absorbers covered the ground plane with a minimum area of 3.0m by 3.0m between the EUT and measurement receiver antenna. The RF absorber shall not exceed 30cm in high above the conducting floor. The table was rotated 360 degrees to determine the position of the highest radiation.

- (3) The Test antenna shall vary between 1m and 4m, Both Horizontal and Vertical antenna are set to make measurement.
- (4) The initial step in collecting conducted emission data is a spectrum analyzer peak detector mode pre-scanning the measurement frequency range. Significant peaks are then marked and then Quasi Peak detector mode re-measured.
- (5) If the Peak Mode measured value compliance with and lower than Quasi Peak Mode Limit Bellow 1 GHz, the EUT shall be deemed to meet QP Limits and then no additional QP Mode measurement performed. But the Peak Value and average value both need to comply with applicable limit above 1 GHz.
- (6) Testing frequency range below 1GHz the measuring instrument use VBW=120 kHz with Quasi-peak detection.
- (7) Testing frequency range above 1GHz the measuring instrument use RBW=1 MHz and VBW=3 MHz with Peak Detector for Peak Values, and use RBW=1 MHz and VBW=10 Hz with Peak Detector for Average Values.
- (8) For the actual test configuration, please see the test setup photo.

6.4 EUT Operating Condition

The Equipment Under Test was set to Continual Transmitting in maximum power.

6.4 Test Data

Remark: During testing above 1GHz the measuring instrument use RBW=1 MHz and VBW=3 MHz with Peak Detector for Peak Values, and use RBW=1 MHz and VBW=1 KHz with Peak Detector for Average Values.

All restriction bands have been tested, only the worst case is reported.

(1) Radiation Test

EUT:	Bluetooth Speaker	Model Name :	HFD-810A
Temperature:	25 °C	Relative Humidity:	55%
Test Voltage:	AC 120V/60Hz		
Ant. Pol.	Horizontal		
Test Mode:	TX GFSK Mode 2402MHz		
Remark:	N/A		

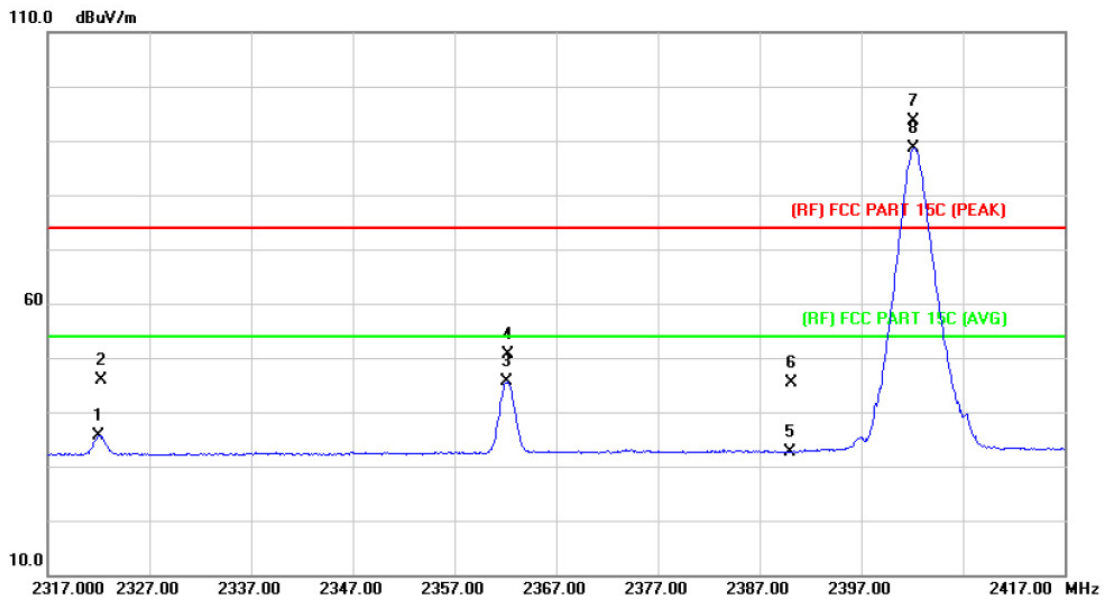

No.	Mk.	Freq. MHz	Reading Level dBuV	Correct Factor dB/m	Measure- ment dBuV/m	Limit dBuV/m	Over dB	Detector
1		2322.000	35.18	0.48	35.66	54.00	-18.34	AVG
2		2322.300	45.46	0.48	45.94	74.00	-28.06	peak
3		2362.200	44.94	0.65	45.59	54.00	-8.41	AVG
4		2362.300	50.10	0.65	50.75	74.00	-23.25	peak
5		2390.000	31.89	0.77	32.66	54.00	-21.34	AVG
6		2390.100	44.66	0.77	45.43	74.00	-28.57	peak
7	X	2402.200	92.81	0.82	93.63	Fundamental Frequency		peak
8	*	2402.200	87.81	0.82	88.63	Fundamental Frequency		AVG

Emission Level= Read Level+ Correct Factor

EUT:	Bluetooth Speaker	Model Name :	HFD-810A
Temperature:	25 °C	Relative Humidity:	55%
Test Voltage:	AC 120V/60Hz		
Ant. Pol.	Vertical		
Test Mode:	TX GFSK Mode 2402MHz		
Remark:	N/A		

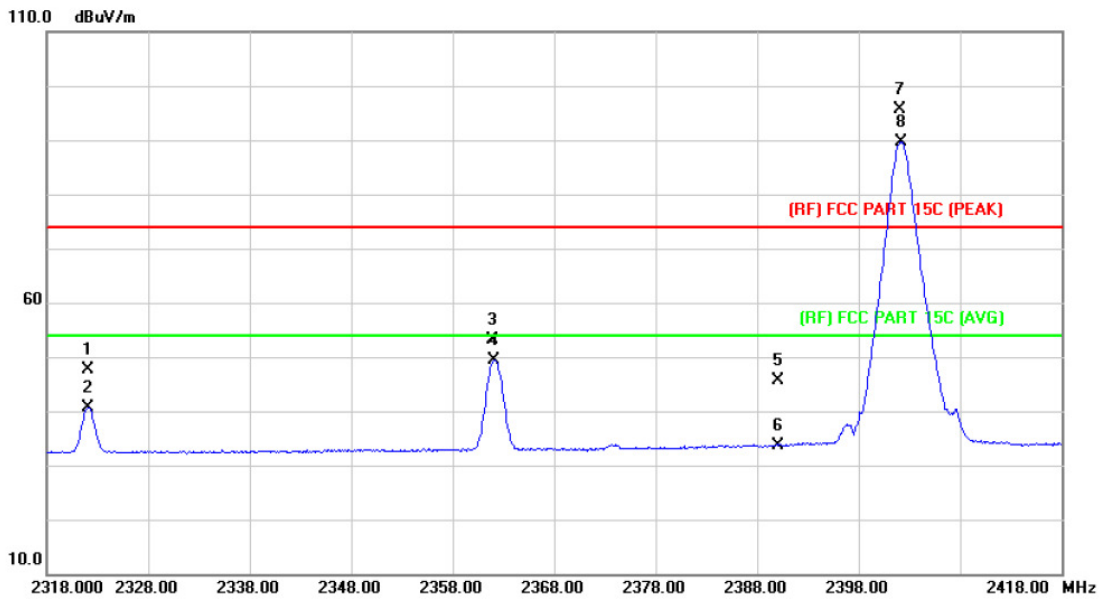

No.	Mk.	Freq. MHz	Reading Level dBuV	Correct Factor dB/m	Measure- ment dBuV/m	Limit dBuV/m	Over dB	Detector
1		2322.100	47.24	0.48	47.72	74.00	-26.28	peak
2		2322.100	40.25	0.48	40.73	54.00	-13.27	AVG
3		2361.900	52.47	0.65	53.12	74.00	-20.88	peak
4		2362.100	48.84	0.65	49.49	54.00	-4.51	AVG
5		2390.000	44.82	0.77	45.59	74.00	-28.41	peak
6		2390.000	32.94	0.77	33.71	54.00	-20.29	AVG
7	X	2402.000	94.85	0.82	95.67	Fundamental Frequency		peak
8	*	2402.200	88.86	0.82	89.68	Fundamental Frequency		AVG

Emission Level= Read Level+ Correct Factor

EUT:	Bluetooth Speaker	Model Name :	HFD-810A
Temperature:	25 °C	Relative Humidity:	55%
Test Voltage:	AC 120V/60Hz		
Ant. Pol.	Horizontal		
Test Mode:	TX GFSK Mode 2480 MHz		
Remark:	N/A		

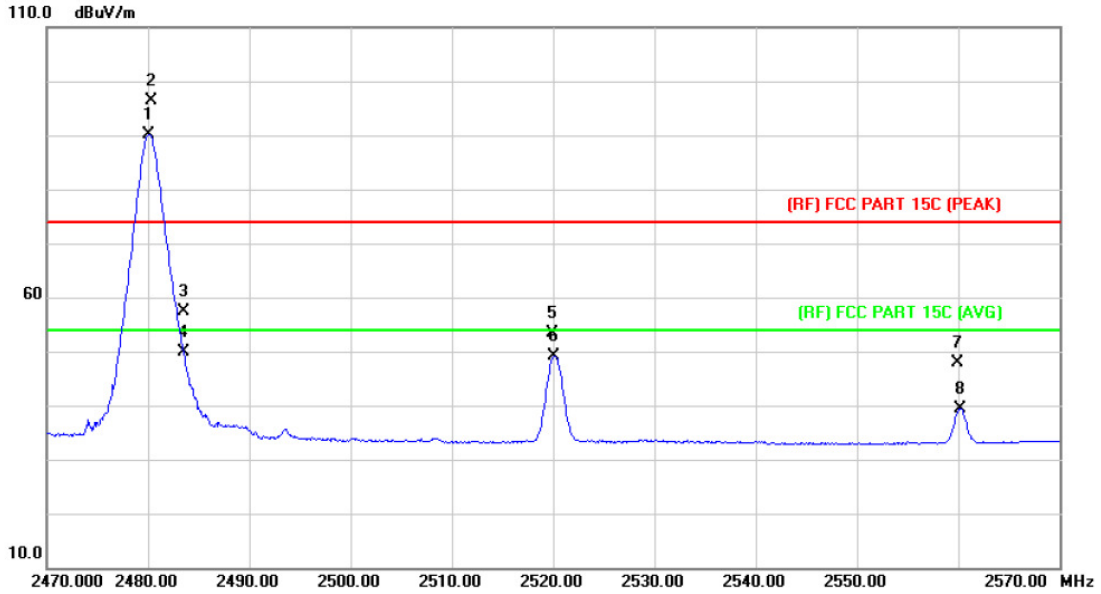

No.	Mk.	Freq. MHz	Reading Level dBuV	Correct Factor dB/m	Measure- ment dBuV/m	Limit dBuV/m	Over dB	Detector
1	*	2480.100	88.99	1.15	90.14	Fundamental Frequency		AVG
2	X	2480.300	95.15	1.15	96.30	Fundamental Frequency		peak
3		2483.500	56.17	1.17	57.34	74.00	-16.66	peak
4		2483.500	48.72	1.17	49.89	54.00	-4.11	AVG
5		2519.900	52.06	1.36	53.42	74.00	-20.58	peak
6		2520.100	47.77	1.36	49.13	54.00	-4.87	AVG
7		2559.900	46.25	1.59	47.84	74.00	-26.16	peak
8		2560.200	37.86	1.60	39.46	54.00	-14.54	AVG

Emission Level= Read Level+ Correct Factor

EUT:	Bluetooth Speaker	Model Name :	HFD-810A
Temperature:	25 °C	Relative Humidity:	55%
Test Voltage:	AC 120V/60Hz		
Ant. Pol.	Vertical		
Test Mode:	TX GFSK Mode 2480 MHz		
Remark:	N/A		

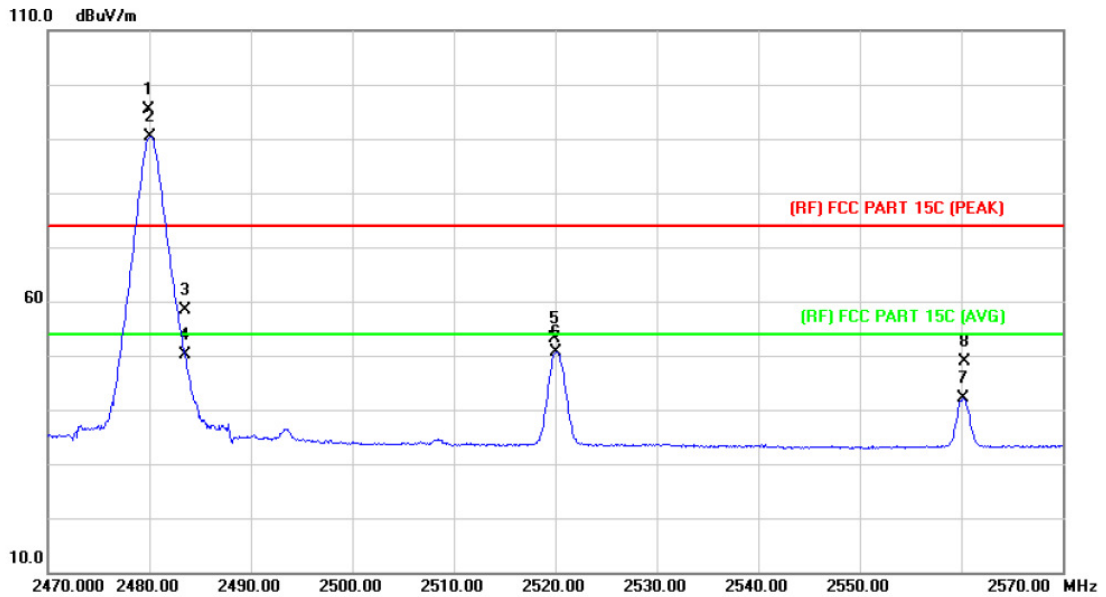

No.	Mk.	Freq. MHz	Reading Level dBuV	Correct Factor dB/m	Measure- ment dBuV/m	Limit dBuV/m	Over dB	Detector
1	X	2479.900	94.11	1.15	95.26	Fundamental Frequency		peak
2	*	2480.100	89.27	1.15	90.42	Fundamental Frequency		AVG
3		2483.500	57.21	1.17	58.38	74.00	-15.62	peak
4		2483.500	48.98	1.17	50.15	54.00	-3.85	AVG
5		2519.900	51.86	1.36	53.22	74.00	-20.78	peak
6		2520.100	49.34	1.36	50.70	54.00	-3.30	AVG
7		2560.200	40.43	1.60	42.03	54.00	-11.97	AVG
8		2560.300	47.35	1.60	48.95	74.00	-25.05	peak

Emission Level= Read Level+ Correct Factor

EUT:	Bluetooth Speaker	Model Name :	HFD-810A
Temperature:	25 °C	Relative Humidity:	55%
Test Voltage:	AC 120V/60Hz		
Ant. Pol.	Horizontal		
Test Mode:	TX 8-DPSK Mode 2402MHz		
Remark:	N/A		

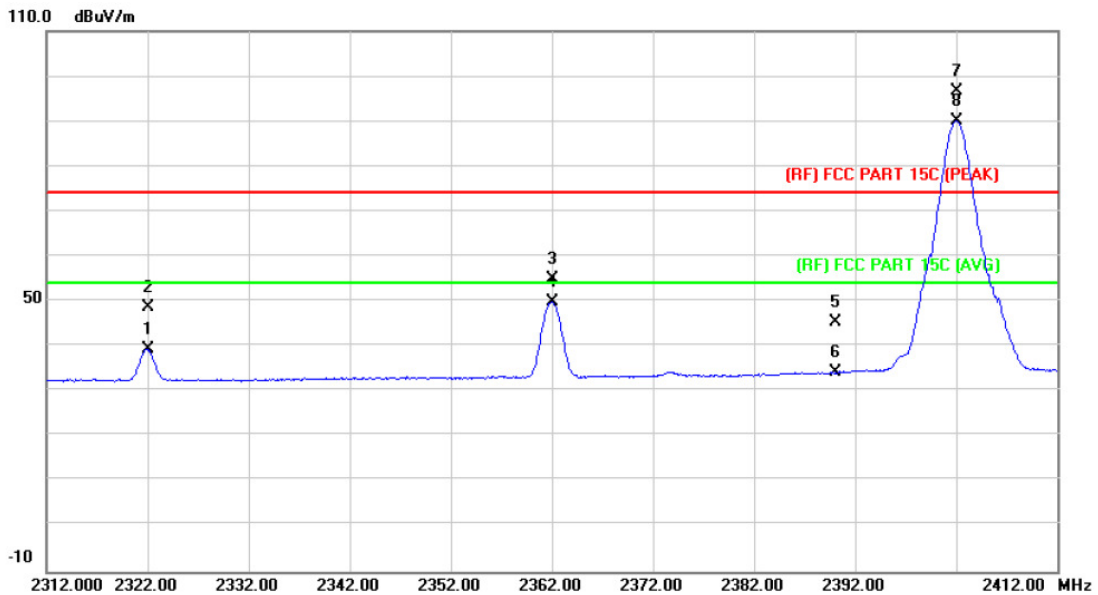

No.	Mk.	Freq. MHz	Reading Level dBuV	Correct Factor dB/m	Measure- ment dBuV/m	Limit dBuV/m	Over dB	Detector
1		2322.000	38.87	0.48	39.35	54.00	-14.65	AVG
2		2322.100	48.24	0.48	48.72	74.00	-25.28	peak
3		2362.000	54.41	0.65	55.06	74.00	-18.94	peak
4		2362.000	49.17	0.65	49.82	54.00	-4.18	AVG
5		2390.000	44.52	0.77	45.29	74.00	-28.71	peak
6		2390.000	33.36	0.77	34.13	54.00	-19.87	AVG
7	X	2402.000	95.70	0.82	96.52	Fundamental Frequency		peak
8	*	2402.000	89.16	0.82	89.98	Fundamental Frequency		AVG

Emission Level= Read Level+ Correct Factor

EUT:	Bluetooth Speaker	Model Name :	HFD-810A
Temperature:	25 °C	Relative Humidity:	55%
Test Voltage:	AC 120V/60Hz		
Ant. Pol.	Vertical		
Test Mode:	TX 8-DPSK Mode 2402MHz		
Remark:	N/A		

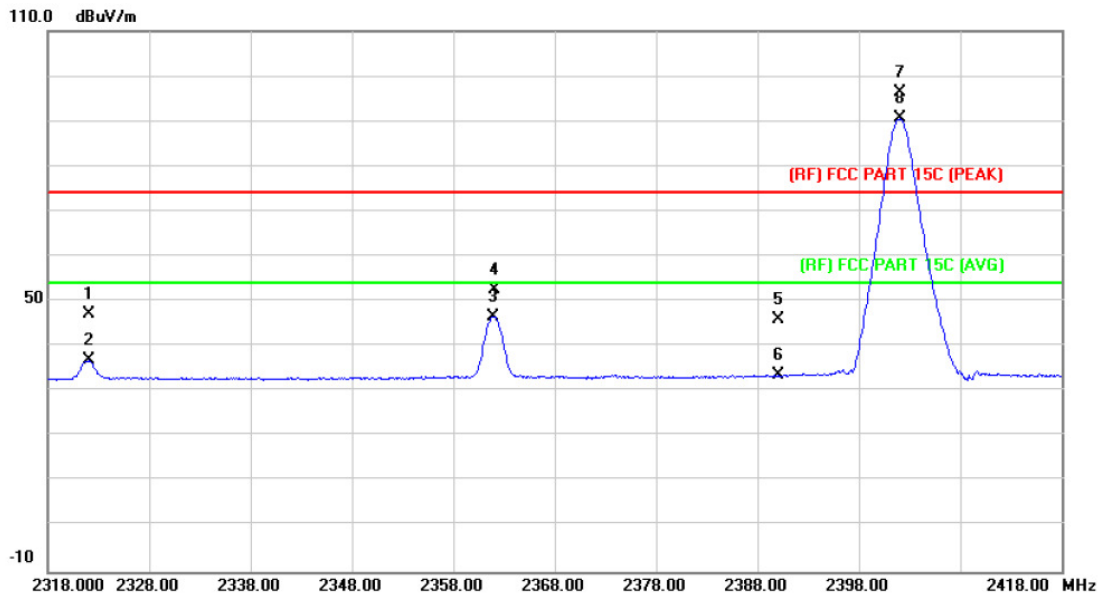

No.	Mk.	Freq.	Reading Level	Correct Factor	Measurement	Limit	Over	Detector
		MHz	dBuV	dB/m	dBuV/m	dBuV/m	dB	
1		2322.000	46.81	0.48	47.29	74.00	-26.71	peak
2		2322.100	36.39	0.48	36.87	54.00	-17.13	AVG
3		2361.900	45.97	0.65	46.62	54.00	-7.38	AVG
4		2362.000	51.93	0.65	52.58	74.00	-21.42	peak
5		2390.000	45.15	0.77	45.92	74.00	-28.08	peak
6		2390.000	32.77	0.77	33.54	54.00	-20.46	AVG
7	*	2402.000	95.67	0.82	96.49	Fundamental Frequency		peak
8	X	2402.000	89.69	0.82	90.51	Fundamental Frequency		peak

Emission Level= Read Level+ Correct Factor

EUT:	Bluetooth Speaker	Model Name :	HFD-810A
Temperature:	25 °C	Relative Humidity:	55%
Test Voltage:	AC 120V/60Hz		
Ant. Pol.	Horizontal		
Test Mode:	TX 8-DPSK Mode 2480MHz		
Remark:	N/A		

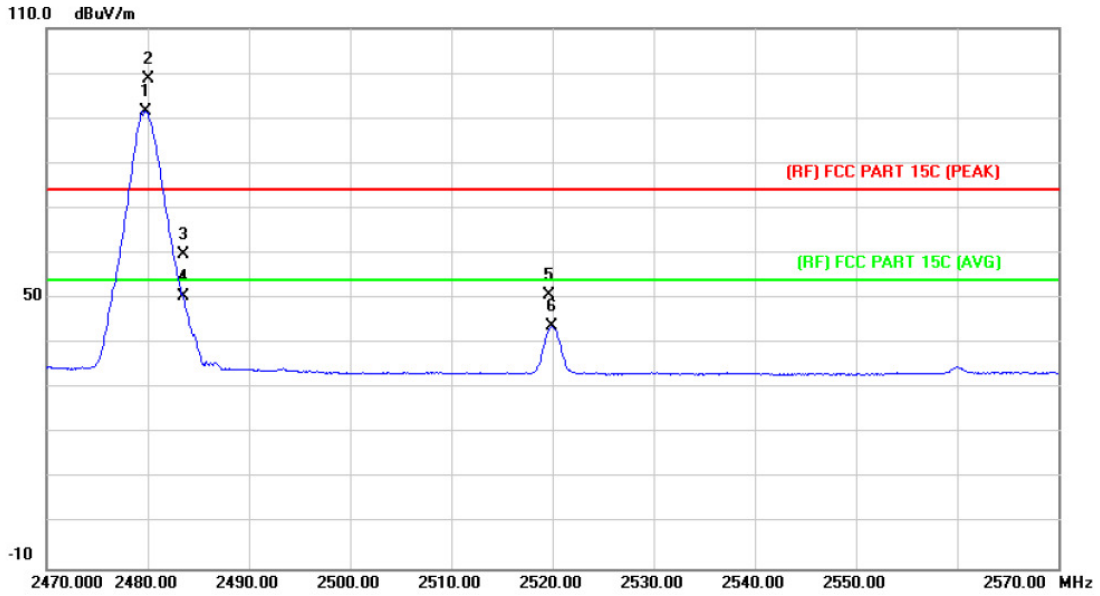

No.	Mk.	Freq. MHz	Reading Level dBuV	Correct Factor dB/m	Measure- ment dBuV/m	Limit dBuV/m	Over dB	Detector
1	X	2479.800	90.48	1.15	91.63	Fundamental Frequency		peak
2	*	2480.000	97.61	1.15	98.76	Fundamental Frequency		AVG
3		2483.500	58.73	1.17	59.90	74.00	-14.10	peak
4		2483.500	49.41	1.17	50.58	54.00	-3.42	AVG
5		2519.700	49.32	1.36	50.68	74.00	-23.32	peak
6		2519.900	42.34	1.36	43.70	54.00	-10.30	AVG

Emission Level= Read Level+ Correct Factor

EUT:	Bluetooth Speaker	Model Name :	HFD-810A
Temperature:	25 °C	Relative Humidity:	55%
Test Voltage:	AC 120V/60Hz		
Ant. Pol.	Vertical		
Test Mode:	TX 8-DPSK Mode 2480MHz		
Remark:	N/A		

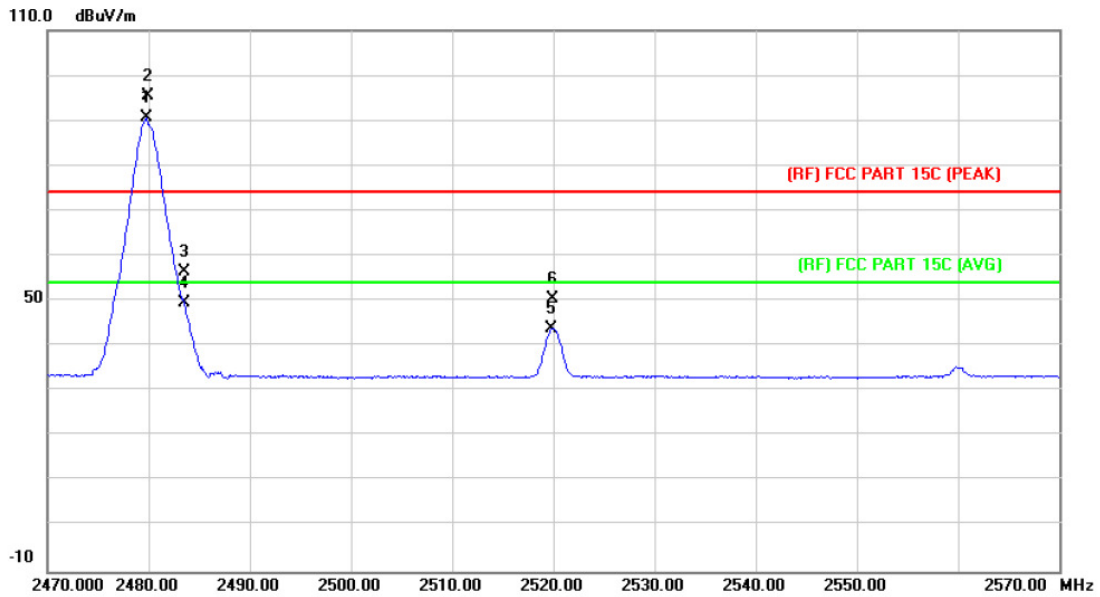

No.	Mk.	Freq. MHz	Reading Level dBuV	Correct Factor dB/m	Measure- ment dBuV/m	Limit dBuV/m	Over dB	Detector
1	*	2479.800	89.38	1.15	90.53	Fundamental Frequency		AVG
2	X	2479.900	94.39	1.15	95.54	Fundamental Frequency		peak
3		2483.500	55.36	1.17	56.53	74.00	-17.47	peak
4		2483.500	48.45	1.17	49.62	54.00	-4.38	AVG
5		2519.800	42.53	1.36	43.89	54.00	-10.11	AVG
6		2519.900	49.22	1.36	50.58	74.00	-23.42	peak

Emission Level= Read Level+ Correct Factor

(2) Conducted Test

EUT:	Bluetooth Speaker	Model Name :	HFD-810A
Temperature:	25 °C	Relative Humidity:	55%
Test Voltage:	AC 120V/60Hz		
Test Mode:	TX GFSK Mode 2402MHz / 2480 MHz		
Remark:	N/A		

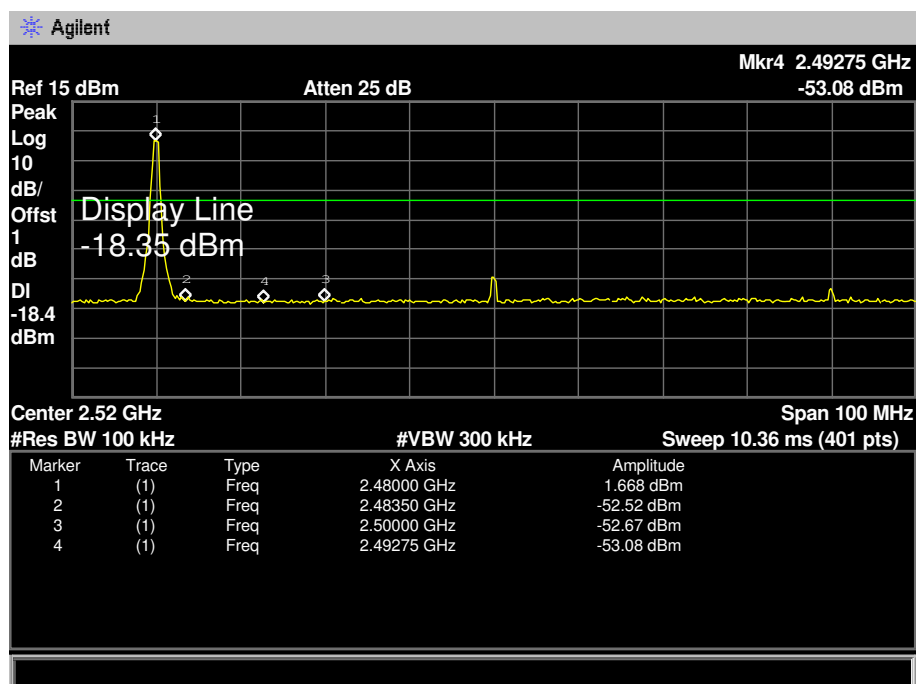
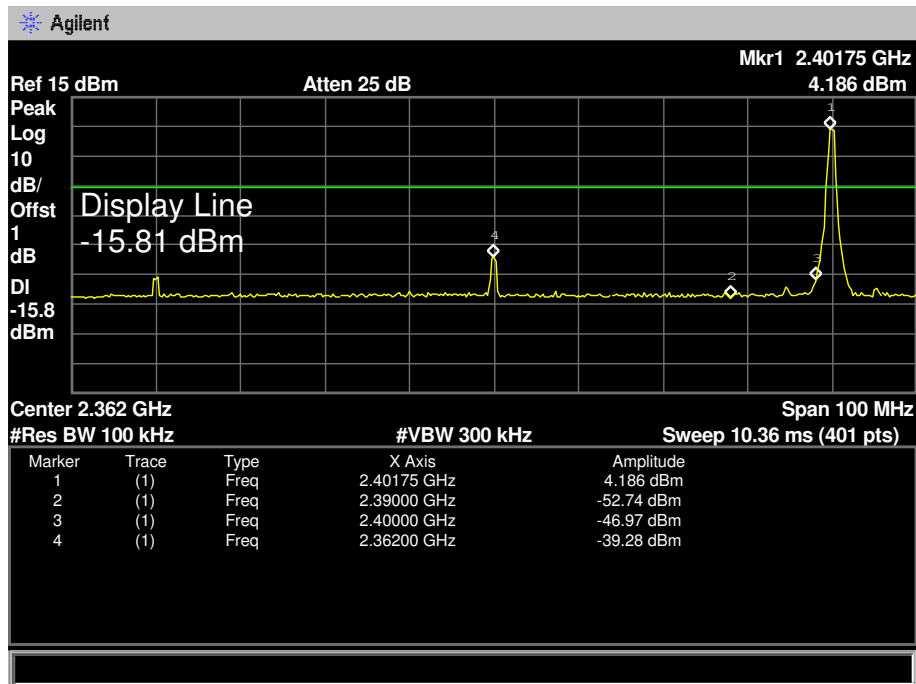

EUT:	Bluetooth Speaker	Model Name :	HFD-810A
Temperature:	25 °C	Relative Humidity:	55%
Test Voltage:	AC 120V/60Hz		
Test Mode:	GFSK Hopping Mode		
Remark:	N/A		

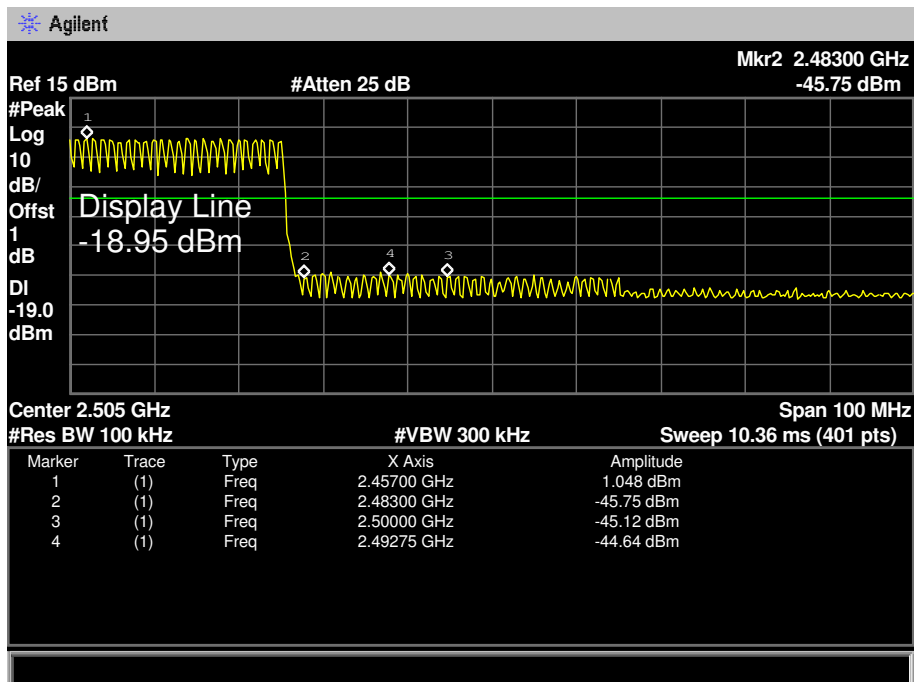
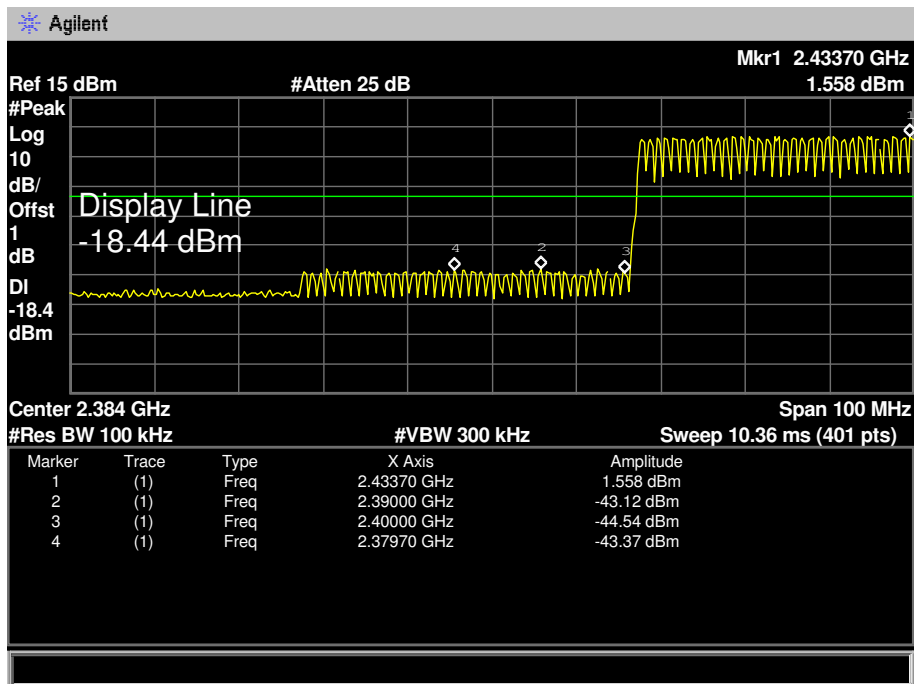

EUT:	Bluetooth Speaker	Model Name :	HFD-810A
Temperature:	25 °C	Relative Humidity:	55%
Test Voltage:	AC 120V/60Hz		
Test Mode:	TX 8-DPSK Mode 2402MHz / 2480 MHz		
Remark:	N/A		

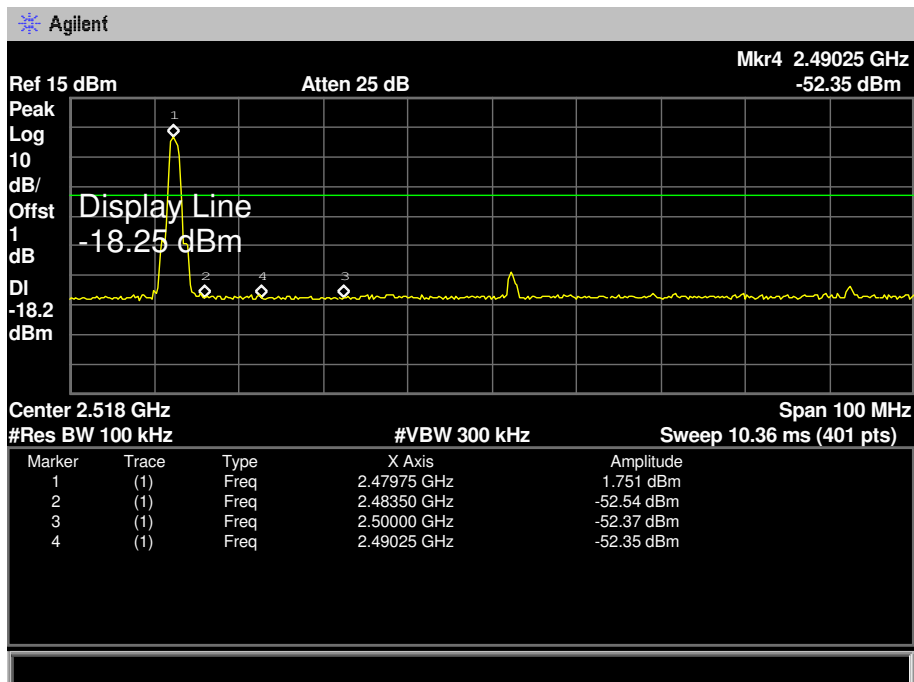
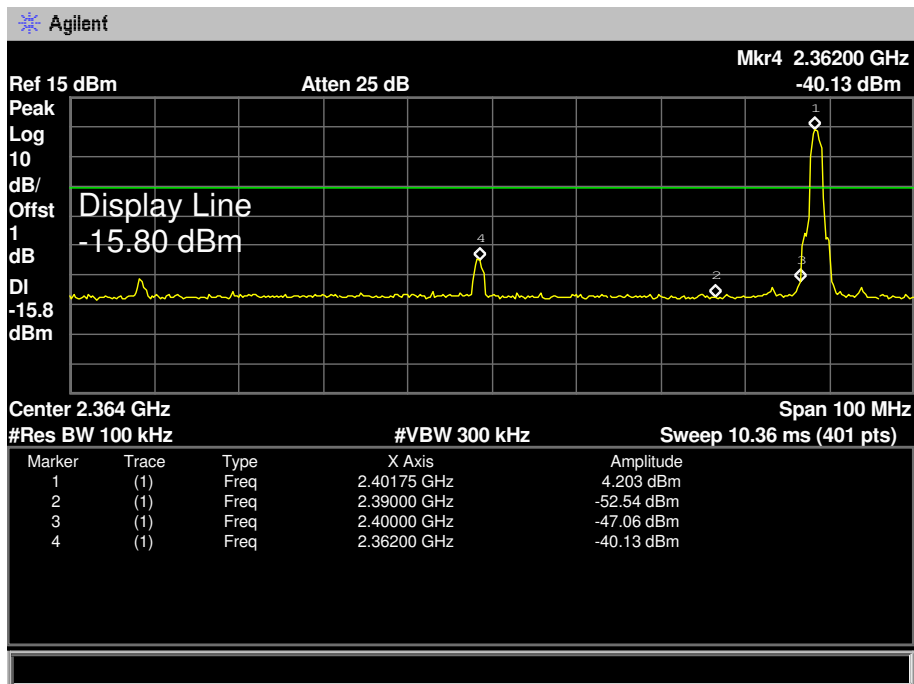

EUT:	Bluetooth Speaker	Model Name :	HFD-810A
Temperature:	25 °C	Relative Humidity:	55%
Test Voltage:	AC 120V/60Hz		
Test Mode:	8-DPSK Hopping Mode		
Remark:	N/A		

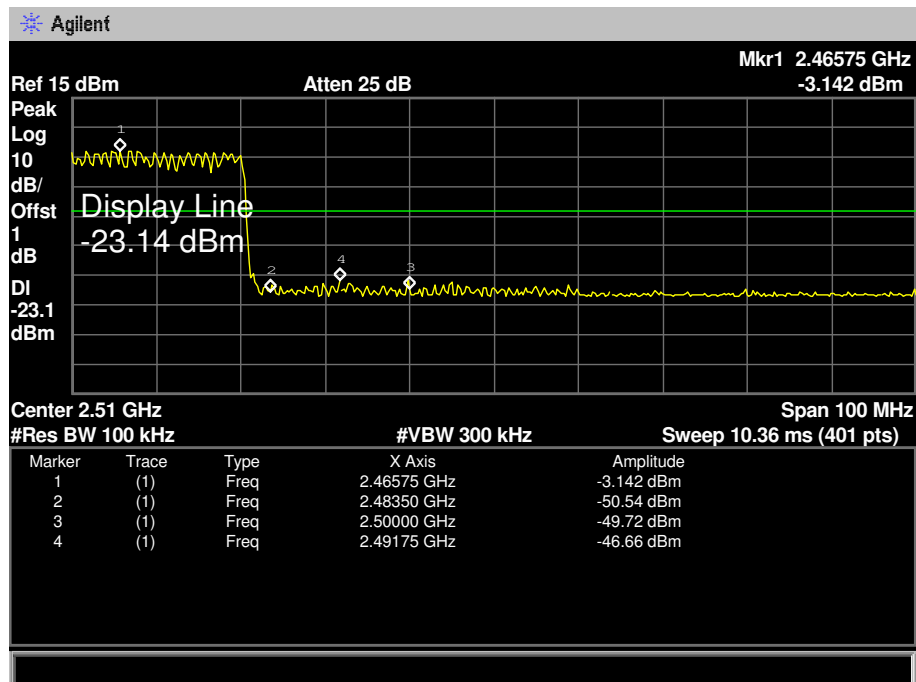
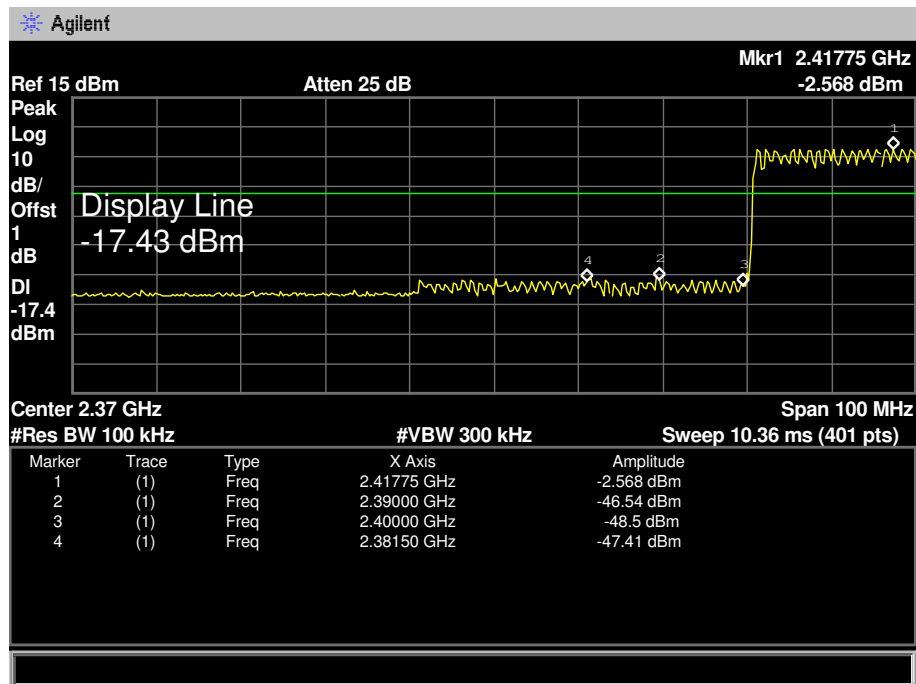

7. Number of Hopping Channel

7.1 Test Standard and Limit

6.1.1 Test Standard

FCC Part 15.247 (a)(1)

6.1.2 Test Limit

Section	Test Item	Limit
15.247	Number of Hopping Channel	>15

7.2 Test Setup

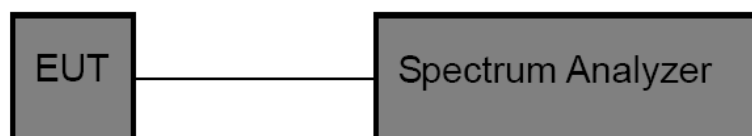

7.3 Test Procedure

- (1) The EUT was directly connected to the spectrum analyzer and antenna output port as show in the block diagram above.
- (2) Spectrum Setting: RBW=100 KHz, VBW=100 KHz, Sweep time= Auto.

7.4 EUT Operating Condition

The EUT was set to the Hopping Mode by the Customer.

7.5 Test Data

EUT:	Bluetooth Speaker	Model Name :	HFD-810A
Temperature:	25 °C	Relative Humidity:	55%
Test Voltage:	AC 120V/60Hz		
Test Mode:	Hopping Mode (GFSK/8-DPSK)		
Frequency Range	Quantity of Hopping Channel		Limit
2402MHz~2480MHz	79		>15
	79		

GFSK Mode

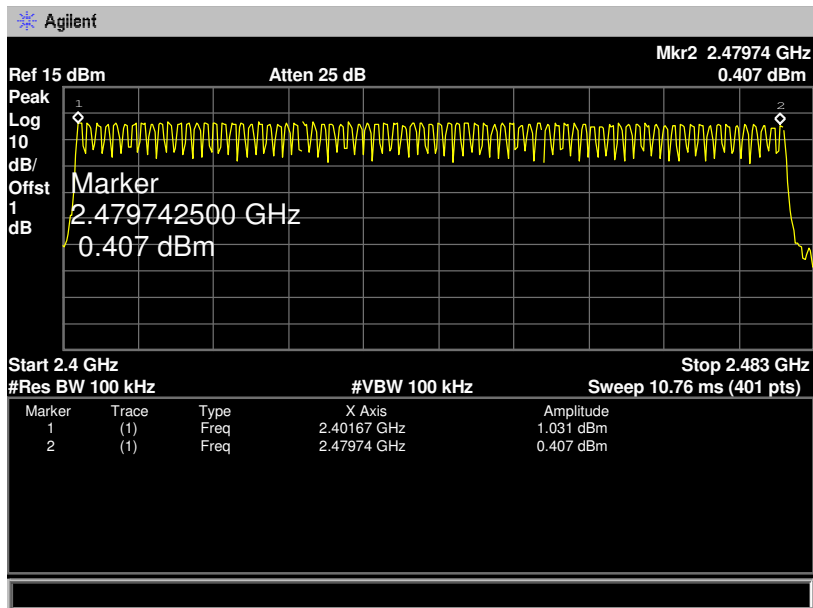

8-DPSK Mode

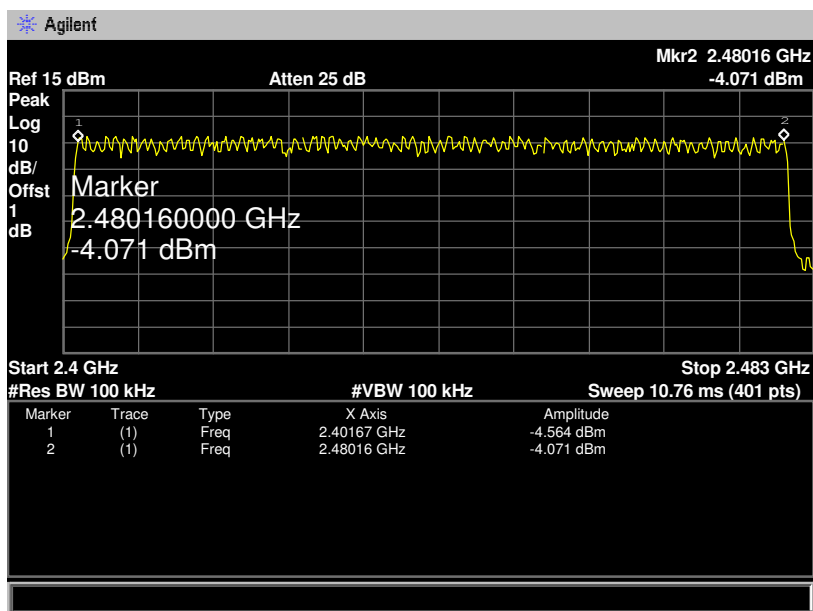

8. Average Time of Occupancy

8.1 Test Standard and Limit

8.1.1 Test Standard

FCC Part 15.247 (a)(1)

8.1.2 Test Limit

Section	Test Item	Limit
15.247(a)(1)/ RSS-210 Annex 8(A8.1d)	Average Time of Occupancy	0.4 sec

8.2 Test Setup

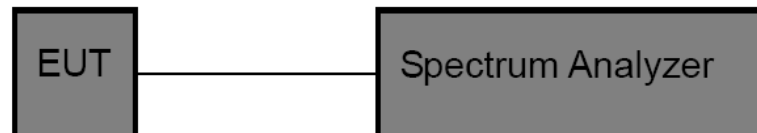

8.3 Test Procedure

- (1) The EUT was directly connected to the spectrum analyzer and antenna output port as show in the block diagram above.
- (2) Spectrum Setting: RBW=1MHz, VBW=1MHz.
- (3) Use video trigger with the trigger level set to enable triggering only on full pulses.
- (4) Sweep Time is more than once pulse time.
- (5) Set the center frequency on any frequency would be measure and set the frequency span to zero.
- (6) Measure the maximum time duration of one single pulse.
- (7) Set the EUT for packet transmitting.
- (8) Measure the maximum time duration of one single pulse.

8.4 EUT Operating Condition

The EUT was set to the Hopping Mode by the Customer.

8.5 Test Data

EUT:	Bluetooth Speaker	Model Name :	HFD-810A		
Temperature:	25 °C	Relative Humidity:	55%		
Test Voltage:	AC 120V/60Hz				
Test Mode:	Hopping Mode (GFSK DH1)				
Channel (MHz)	Pulse Time (ms)	Total of Dwell (ms)	Period Time (s)	Limit (ms)	Result
2402	0.430	137.60	31.60	400	PASS
2441	0.430	137.60			
2480	0.440	140.80			
GFSK Hopping Mode DH1					
2402 MHz					
<p>Agilent</p> <p>Ref 15 dBm Atten 25 dB Mkr1 Δ 430 μs -0.236 dB</p> <p>Peak Log 10 dB/ Offst 1 dB</p> <p>Marker Δ 430.000000 μs -0.236 dB</p> <p>W1 S2 S3 FS AA</p> <p>Center 2.402 GHz Span 0 Hz Res BW 1 MHz #VBW 1 MHz Sweep 4 ms (401 pts)</p>					

GFSK Hopping Mode DH1

2441 MHz

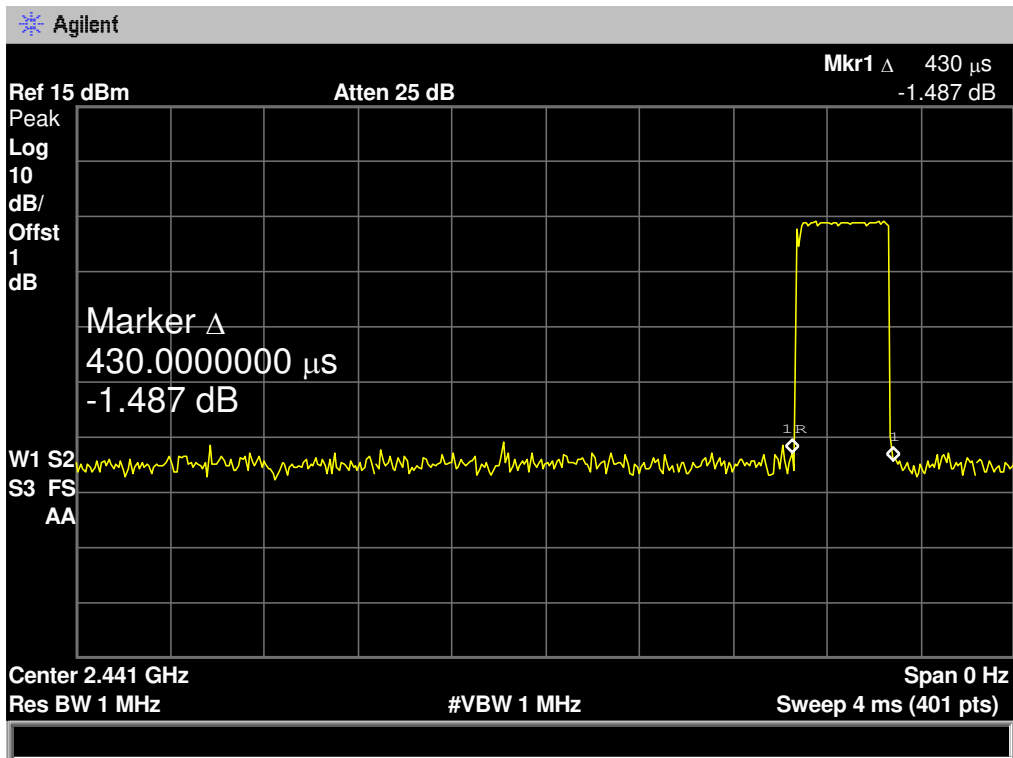

GFSK Hopping Mode DH1

2480 MHz

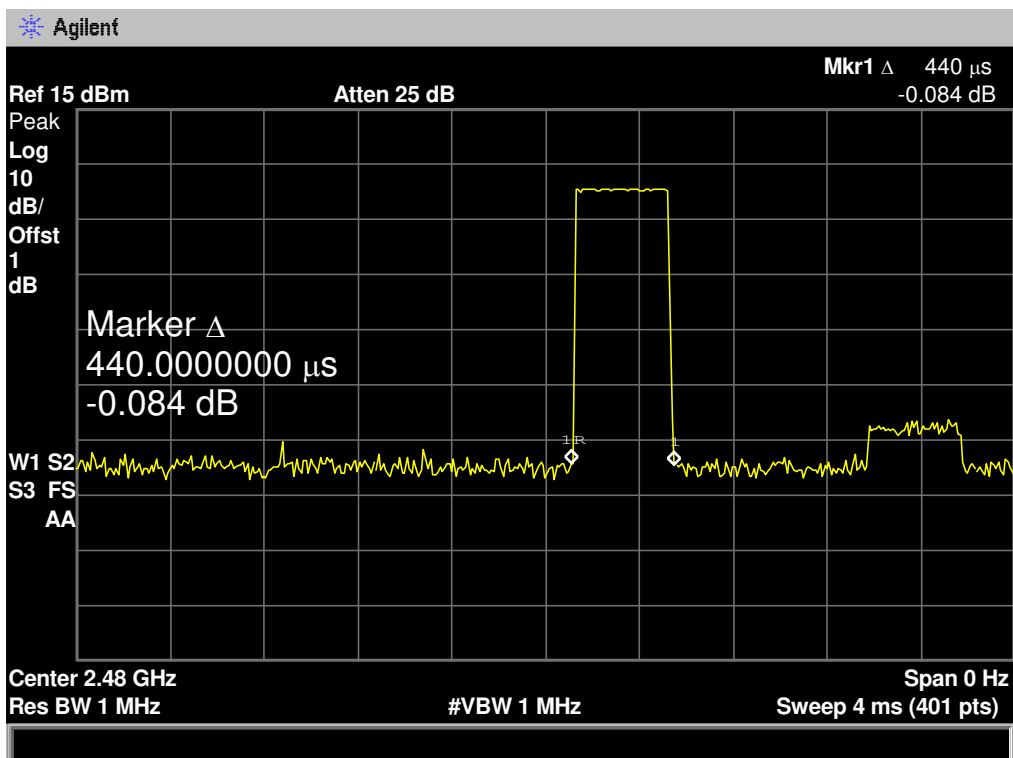

EUT:	Bluetooth Speaker	Model Name :	HFD-810A		
Temperature:	25 °C	Relative Humidity:	55%		
Test Voltage:	AC 120V/60Hz				
Test Mode:	Hopping Mode (GFSK DH3)				
Channel (MHz)	Pulse Time (ms)	Total of Dwell (ms)	Period Time (s)	Limit (ms)	Result
2402	1.700	272.00	31.60	400	PASS
2441	1.700	272.00			
2480	1.700	272.00			

GFSK Hopping Mode DH3

2402 MHz

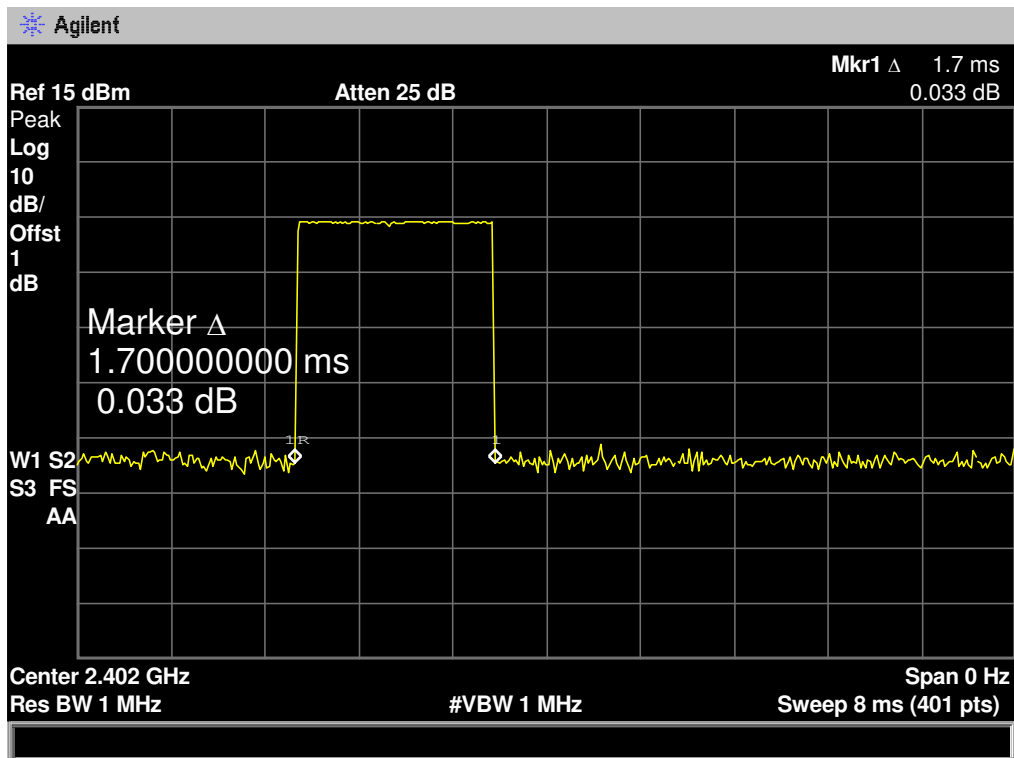

GFSK Hopping Mode DH3

2441 MHz

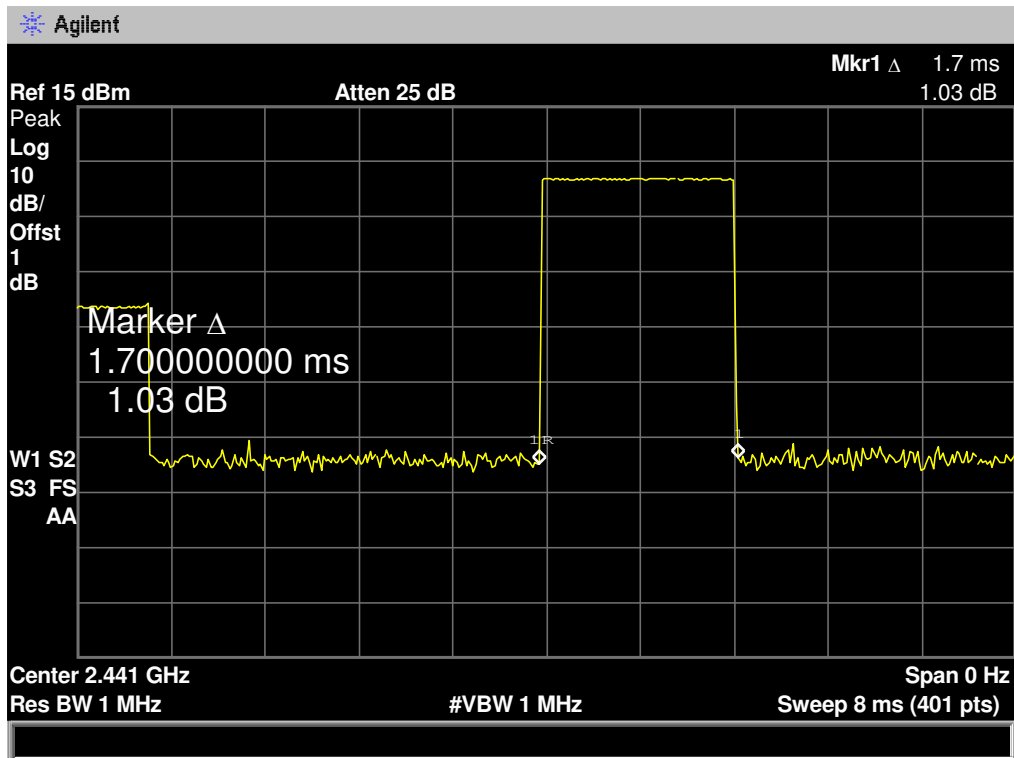

GFSK Hopping Mode DH3

2480 MHz

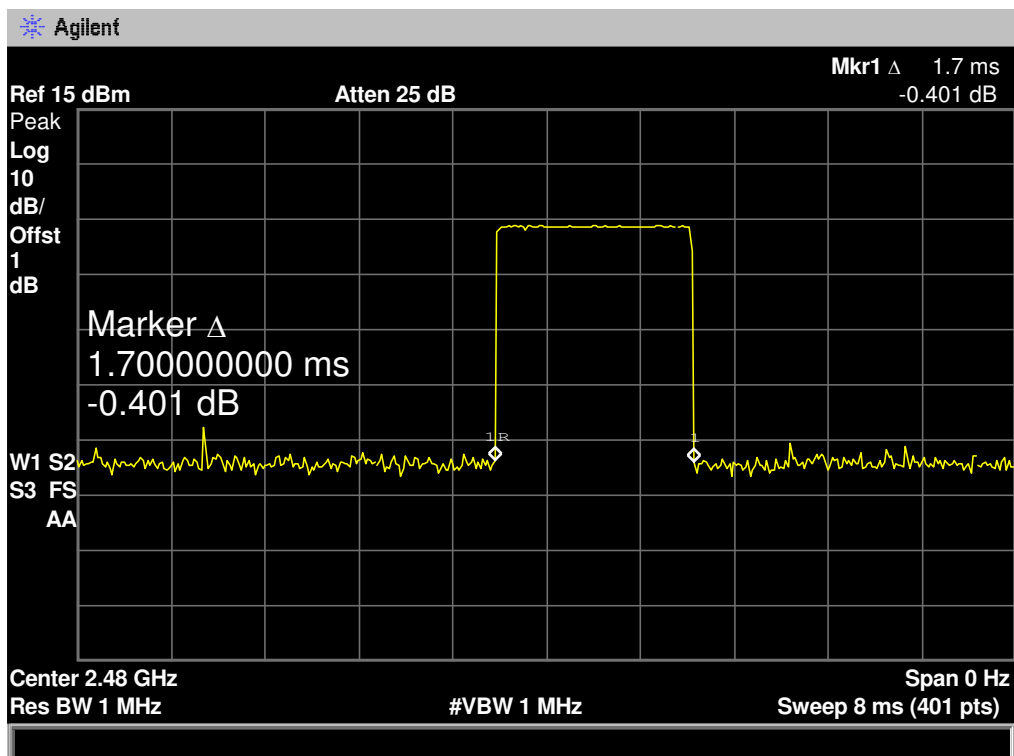

EUT:	Bluetooth Speaker	Model Name :	HFD-810A		
Temperature:	25 °C	Relative Humidity:	55%		
Test Voltage:	AC 120V/60Hz				
Test Mode:	Hopping Mode (GFSK DH5)				
Channel (MHz)	Pulse Time (ms)	Total of Dwell (ms)	Period Time (s)	Limit (ms)	Result
2402	3.000	320.00	31.60	400	PASS
2441	3.000	320.00			
2480	3.000	320.00			

GFSK Hopping Mode DH5

2402 MHz

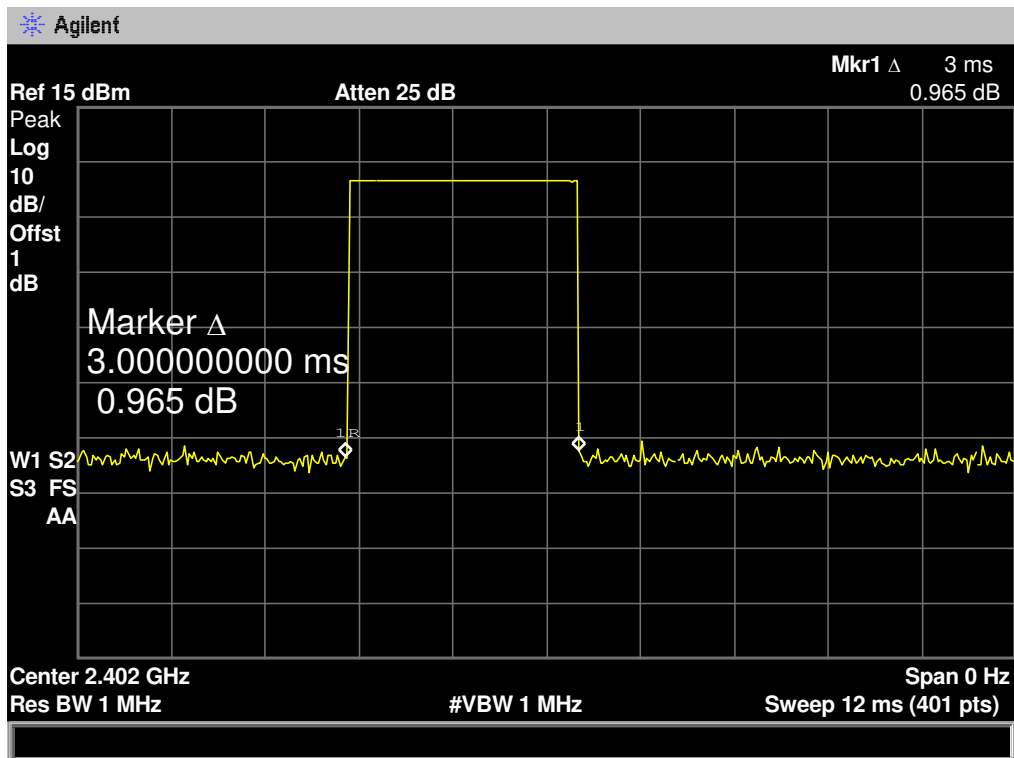

GFSK Hopping Mode DH5

2441 MHz

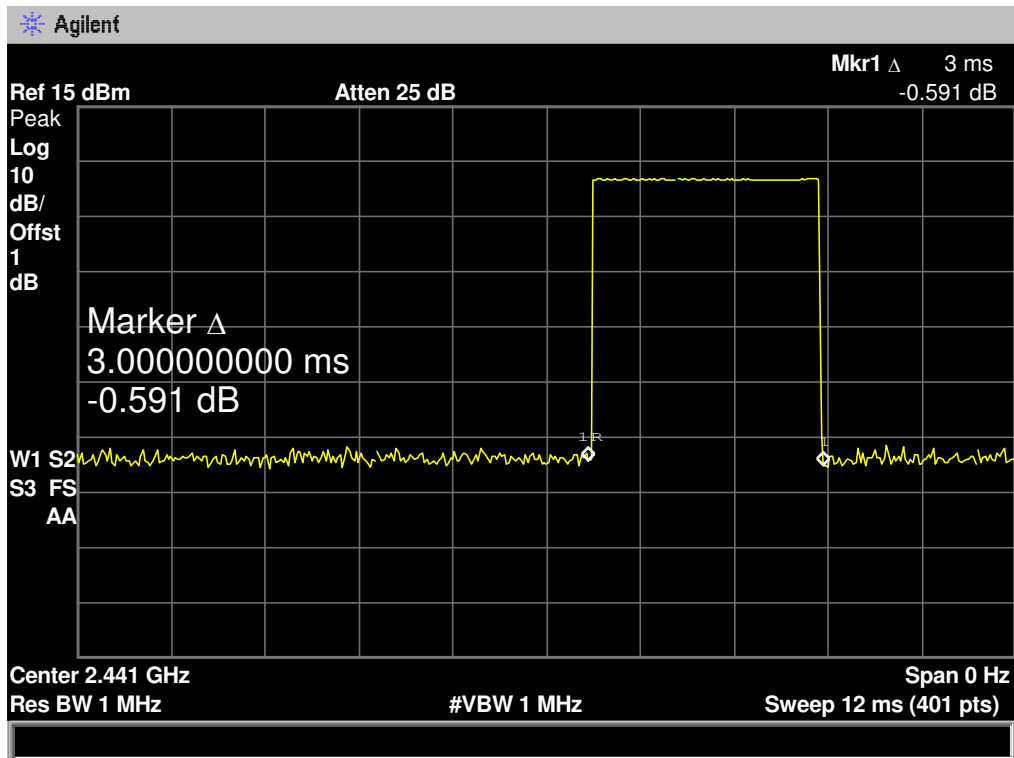

GFSK Hopping Mode DH5

2480 MHz

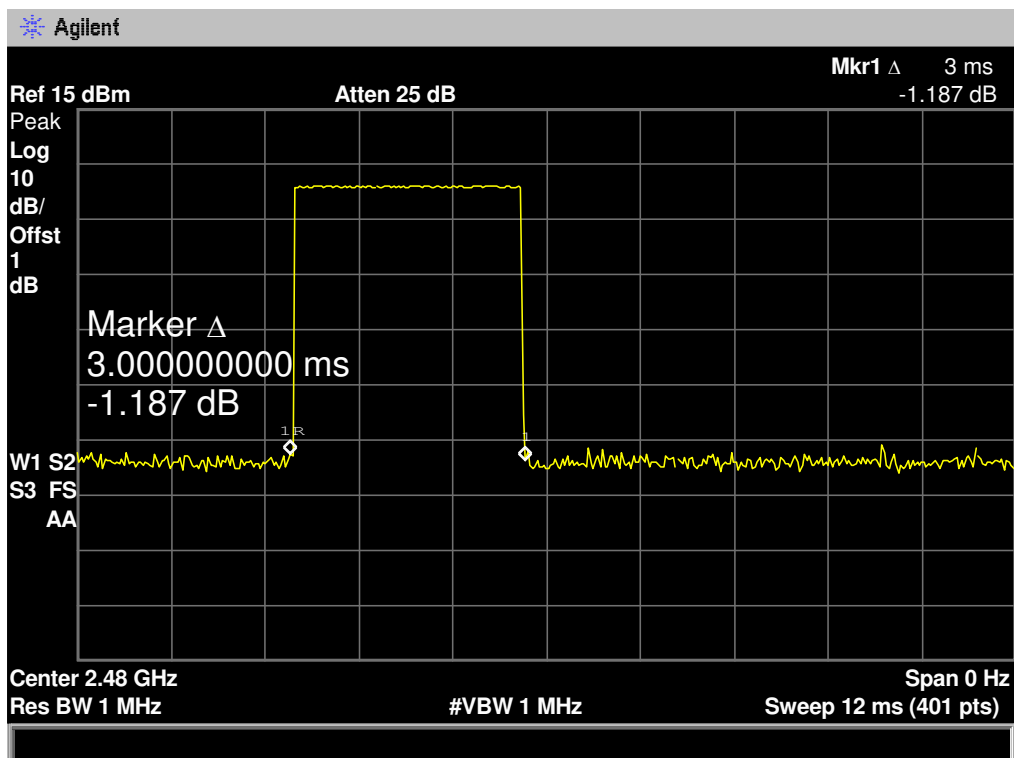

EUT:	Bluetooth Speaker	Model Name :	HFD-810A		
Temperature:	25 °C	Relative Humidity:	55%		
Test Voltage:	AC 120V/60Hz				
Test Mode:	Hopping Mode (π /4-DQPSK DH1)				
Channel (MHz)	Pulse Time (ms)	Total of Dwell (ms)	Period Time (s)	Limit (ms)	Result
2402	0.440	140.80	31.60	400	PASS
2441	0.430	137.60			
2480	0.430	137.60			

π /4-DQPSK Hopping Mode DH1

2402 MHz

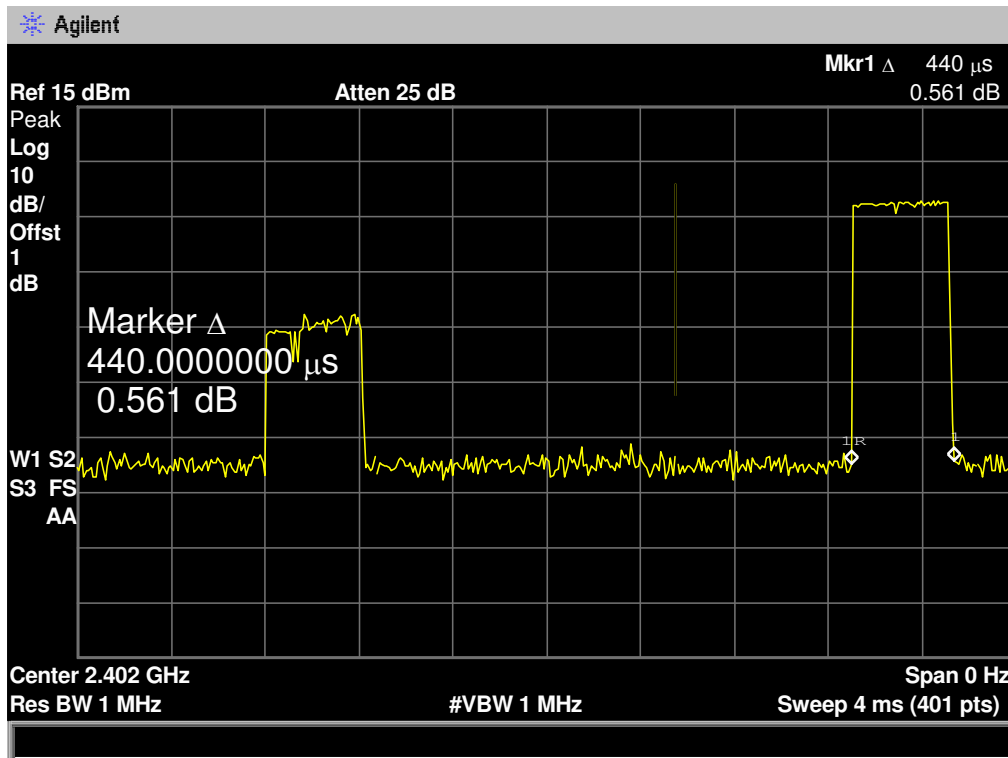

π /4-DQPSK Hopping Mode DH1

2441 MHz

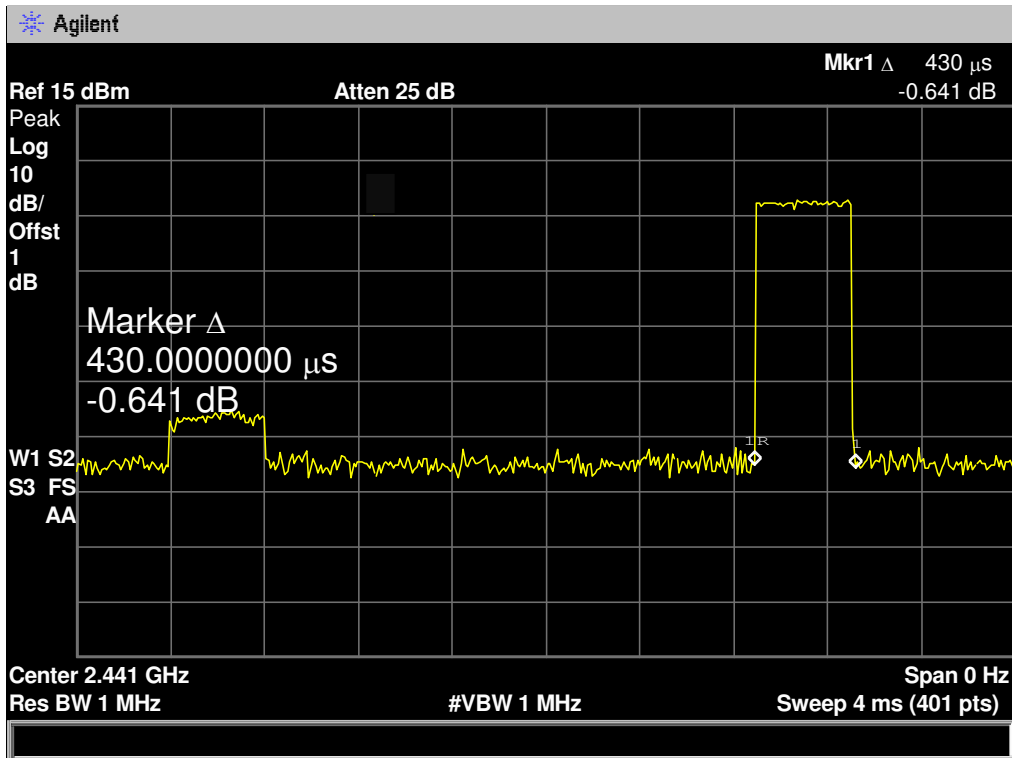

π /4-DQPSK Hopping Mode DH1

2480 MHz

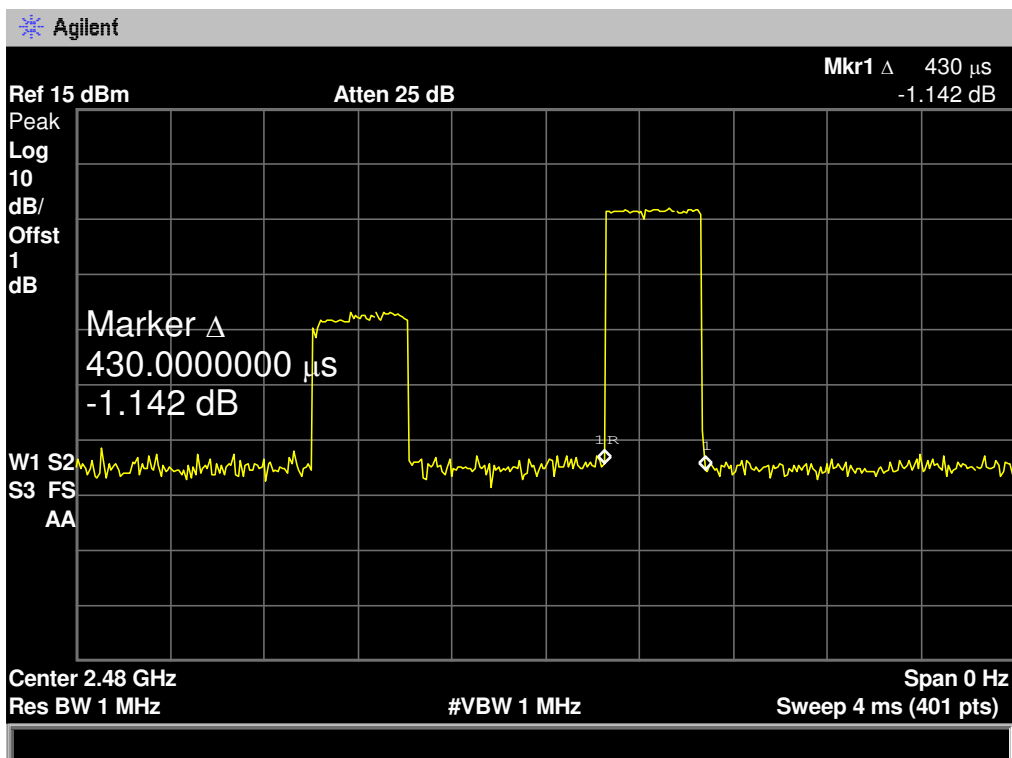

EUT:	Bluetooth Speaker	Model Name :	HFD-810A		
Temperature:	25 °C	Relative Humidity:	55%		
Test Voltage:	AC 120V/60Hz				
Test Mode:	Hopping Mode (π /4-DQPSK DH3)				
Channel (MHz)	Pulse Time (ms)	Total of Dwell (ms)	Period Time (s)	Limit (ms)	Result
2402	1.720	275.20	31.60	400	PASS
2441	1.720	275.20			
2480	1.720	275.20			

π /4-DQPSK Hopping Mode DH3

2402 MHz

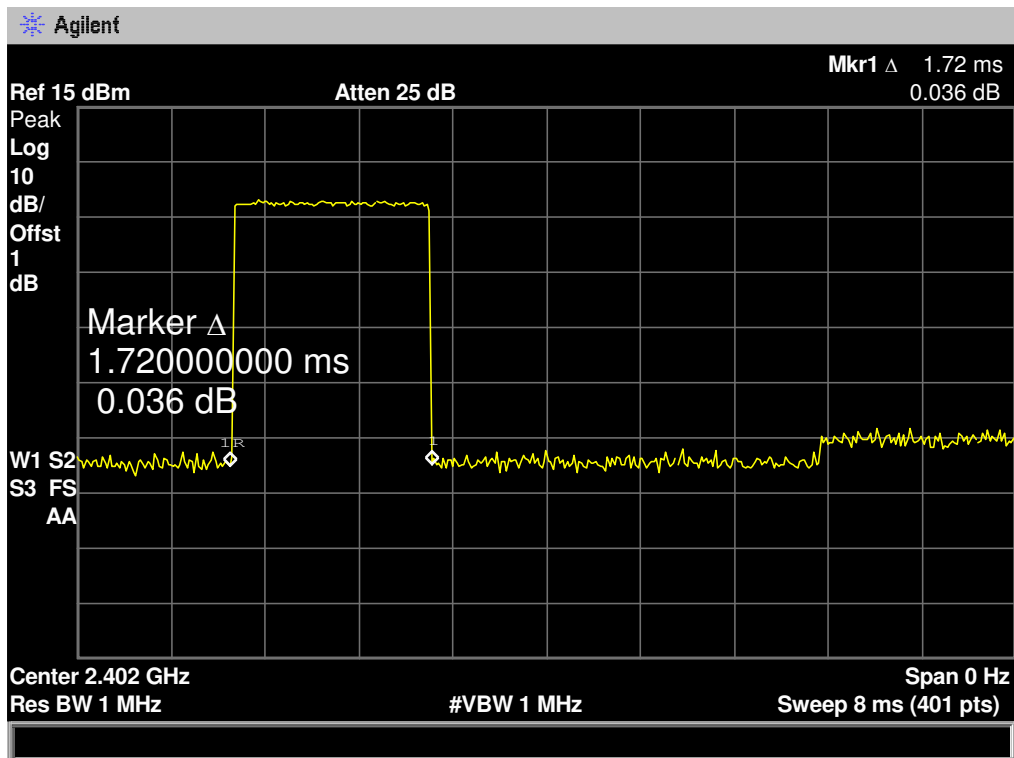

π /4-DQPSK Hopping Mode DH3

2441 MHz

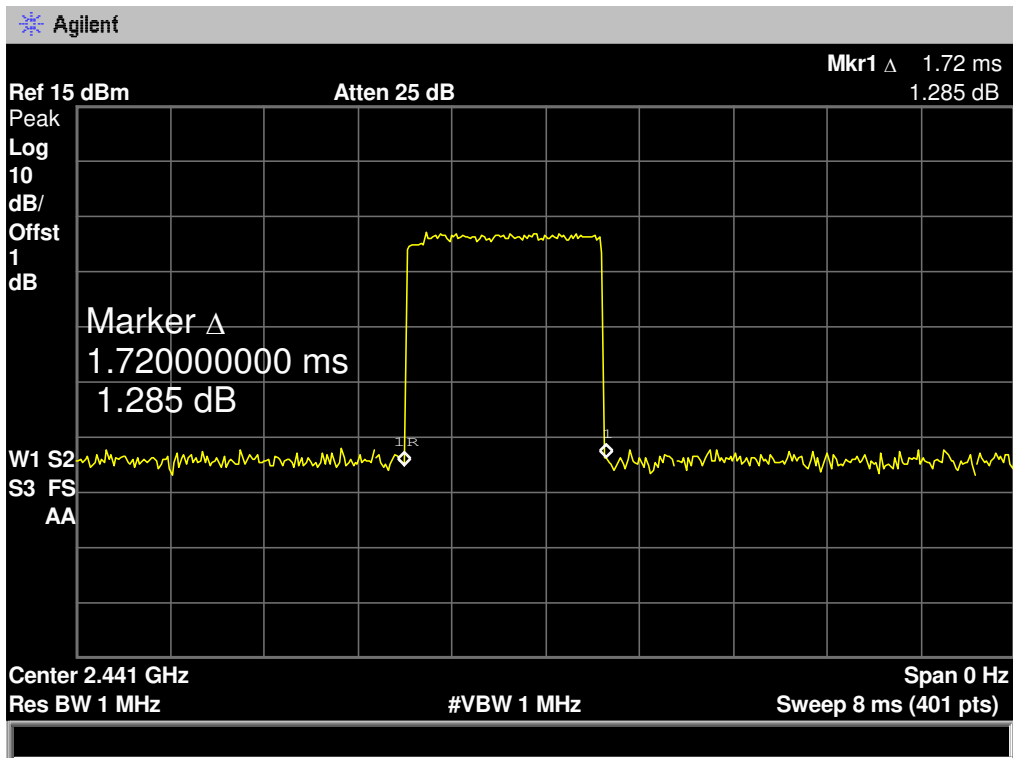

π /4-DQPSK Hopping Mode DH3

2480 MHz

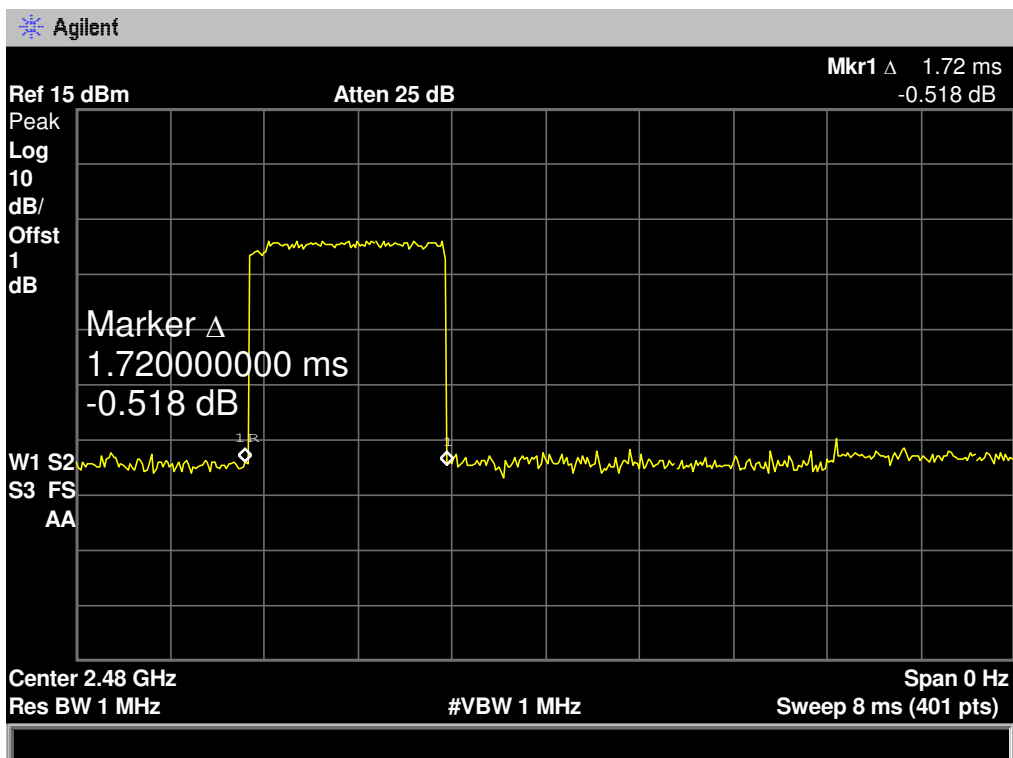

EUT:	Bluetooth Speaker	Model Name :	HFD-810A		
Temperature:	25 °C	Relative Humidity:	55%		
Test Voltage:	AC 120V/60Hz				
Test Mode:	Hopping Mode (π /4-DQPSK DH5)				
Channel (MHz)	Pulse Time (ms)	Total of Dwell (ms)	Period Time (s)	Limit (ms)	Result
2402	3.000	320.00	31.60	400	PASS
2441	3.000	320.00			
2480	3.000	320.00			

π /4-DQPSK Hopping Mode DH5

2402 MHz

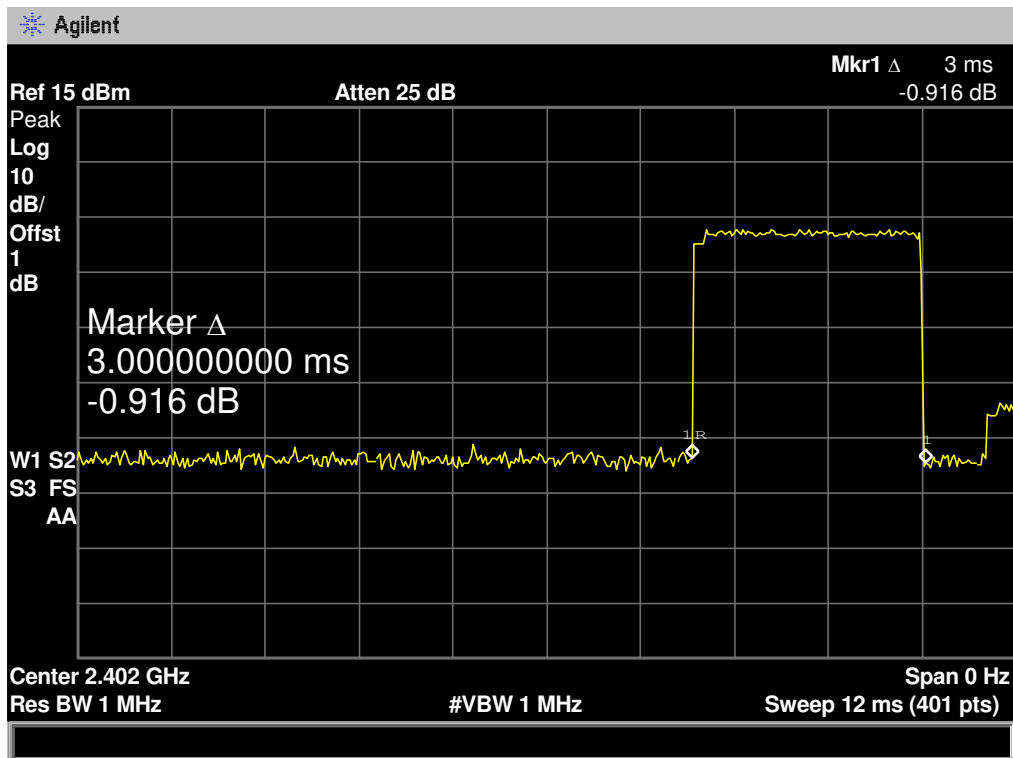

$\pi/4$ -DQPSK Hopping Mode DH5

2441 MHz

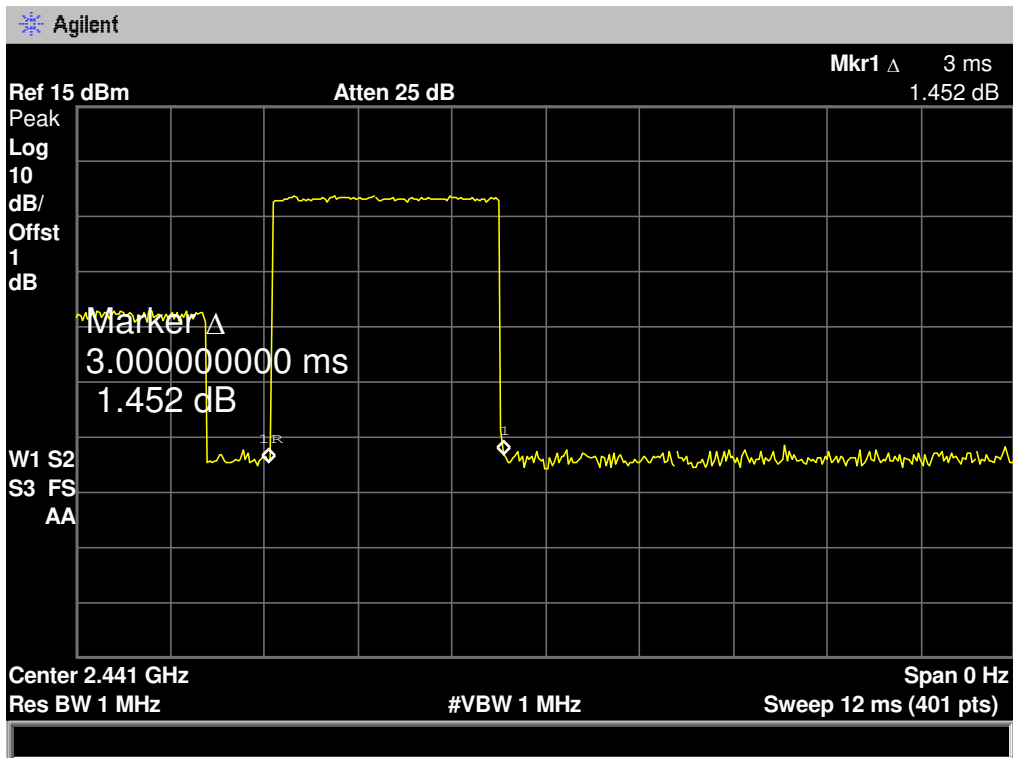

$\pi/4$ -DQPSK Hopping Mode DH5

2480 MHz

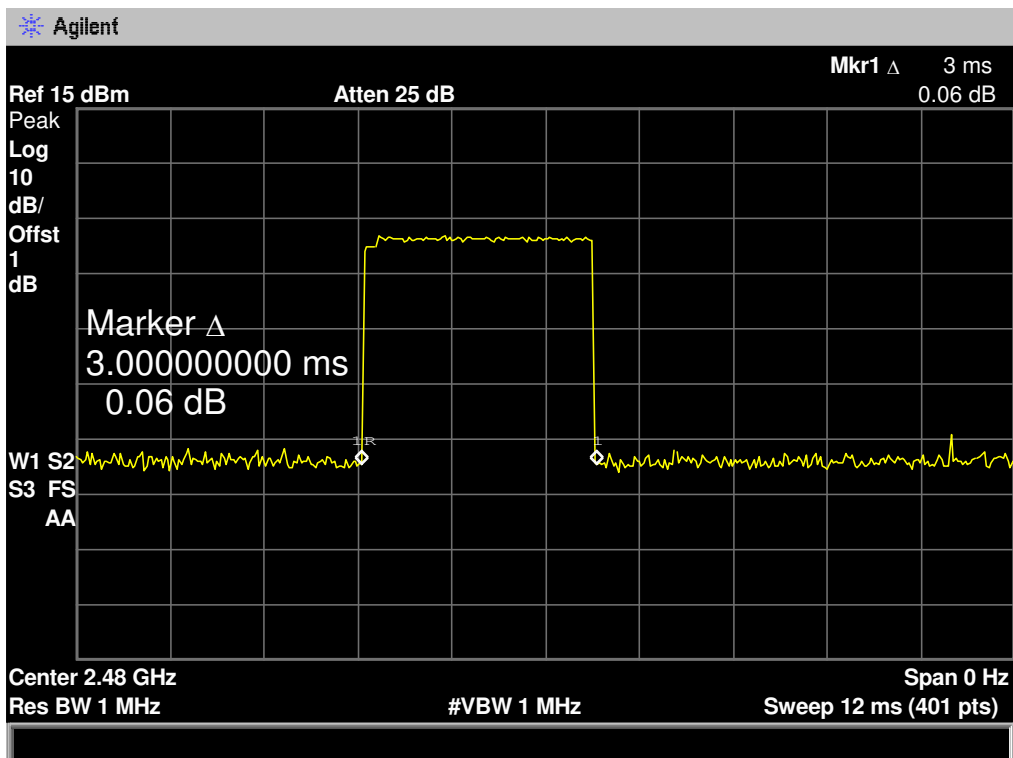

EUT:	Bluetooth Speaker	Model Name :	HFD-810A		
Temperature:	25 °C	Relative Humidity:	55%		
Test Voltage:	AC 120V/60Hz				
Test Mode:	Hopping Mode (8-DPSK DH1)				
Channel (MHz)	Pulse Time (ms)	Total of Dwell (ms)	Period Time (s)	Limit (ms)	Result
2402	0.440	140.80	31.60	400	PASS
2441	0.440	140.80			
2480	0.440	140.80			
8-DPSK Hopping Mode DH1					
2402 MHz					

8-DPSK Hopping Mode DH1

2441 MHz

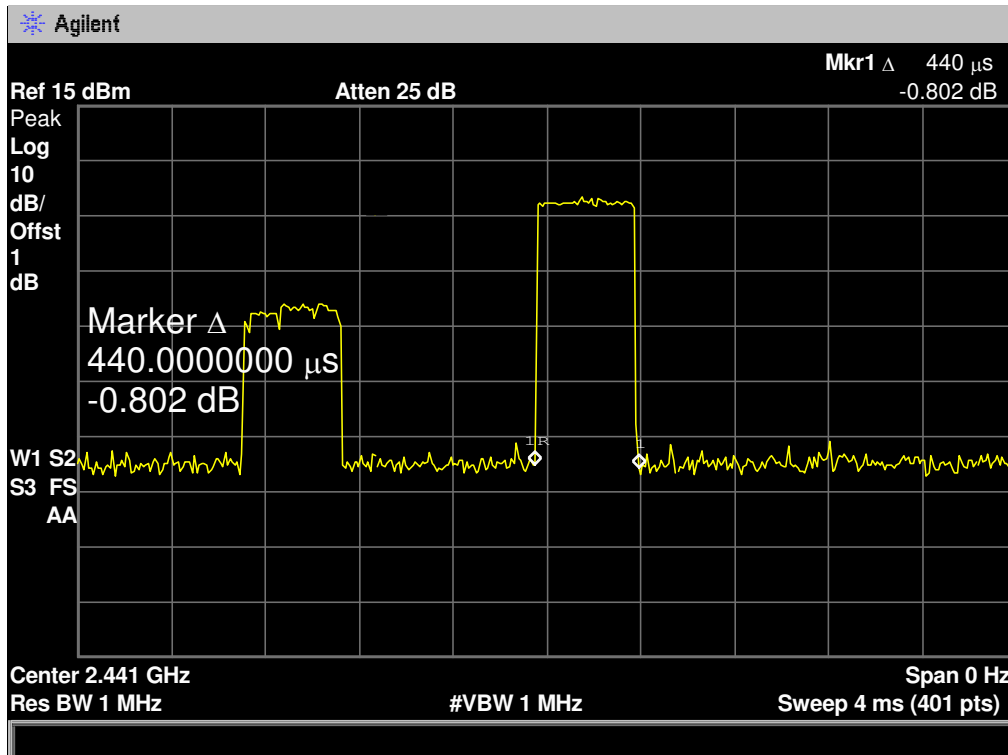

8-DPSK Hopping Mode DH1

2480 MHz

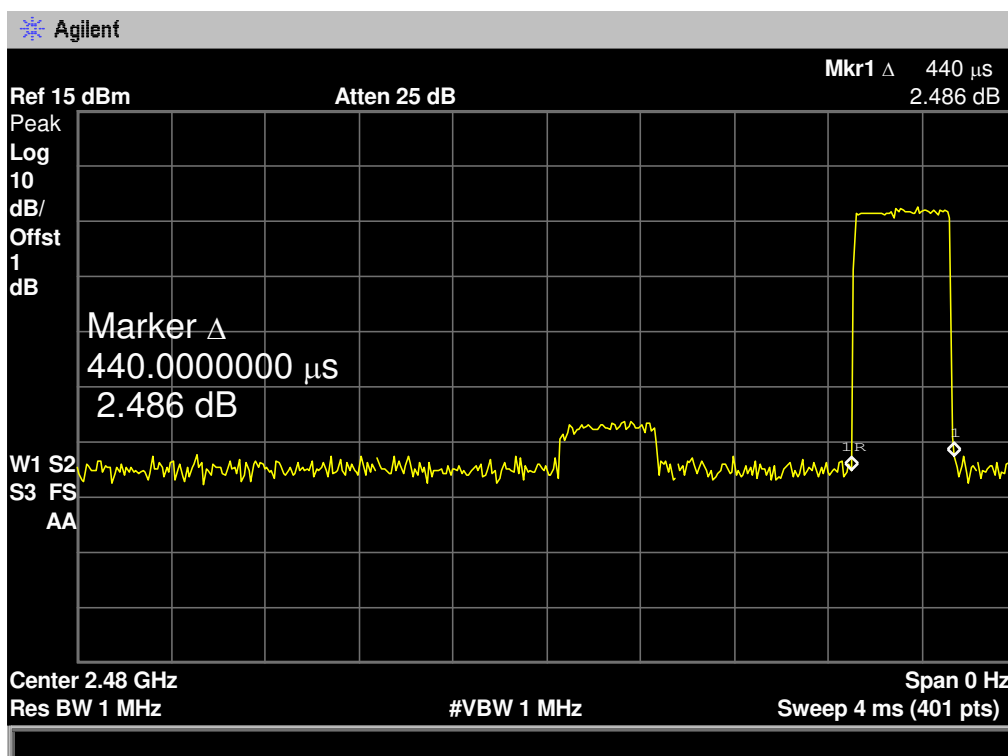

EUT:	Bluetooth Speaker	Model Name :	HFD-810A		
Temperature:	25 °C	Relative Humidity:	55%		
Test Voltage:	AC 120V/60Hz				
Test Mode:	Hopping Mode (8-DPSK DH3)				
Channel (MHz)	Pulse Time (ms)	Total of Dwell (ms)	Period Time (s)	Limit (ms)	Result
2402	1.700	272.00	31.60	400	PASS
2441	1.720	275.20			
2480	1.700	272.00			

8-DPSK Hopping Mode DH3

2402 MHz

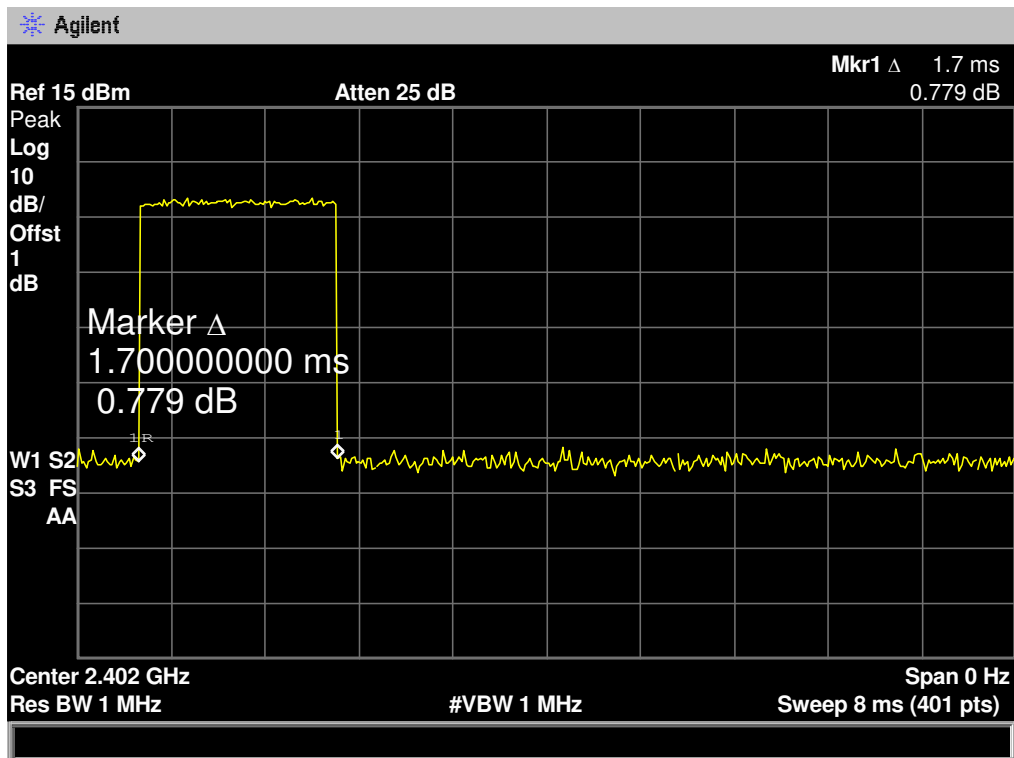

8-DPSK Hopping Mode DH3

2441 MHz

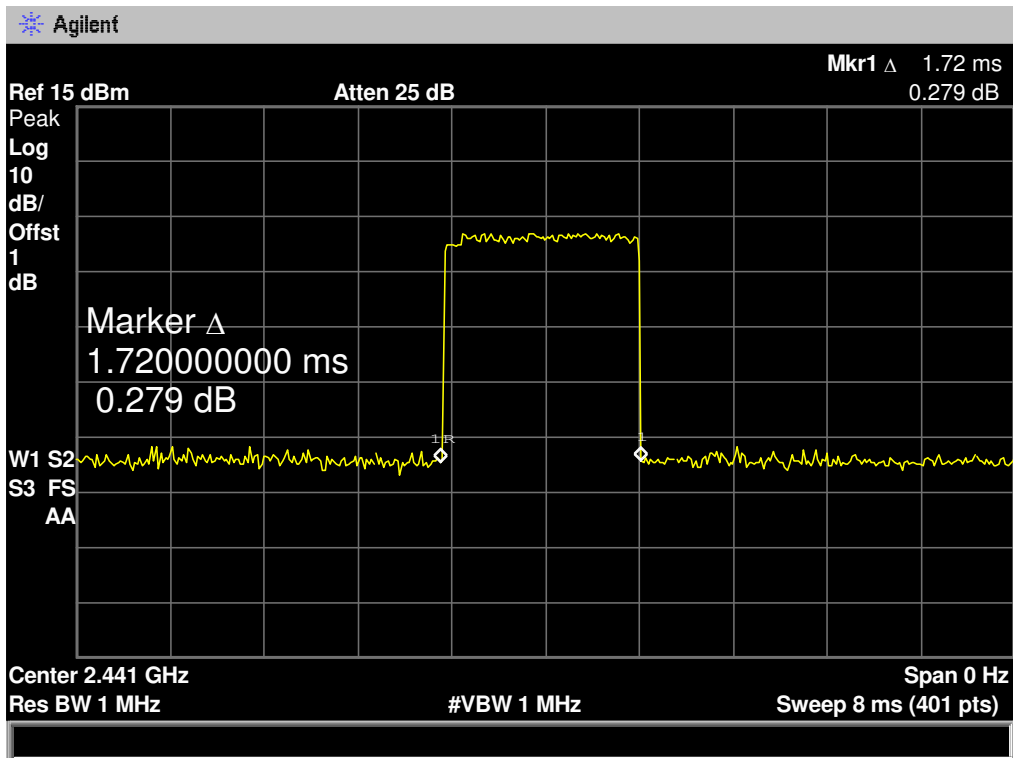

8-DPSK Hopping Mode DH3

2480 MHz

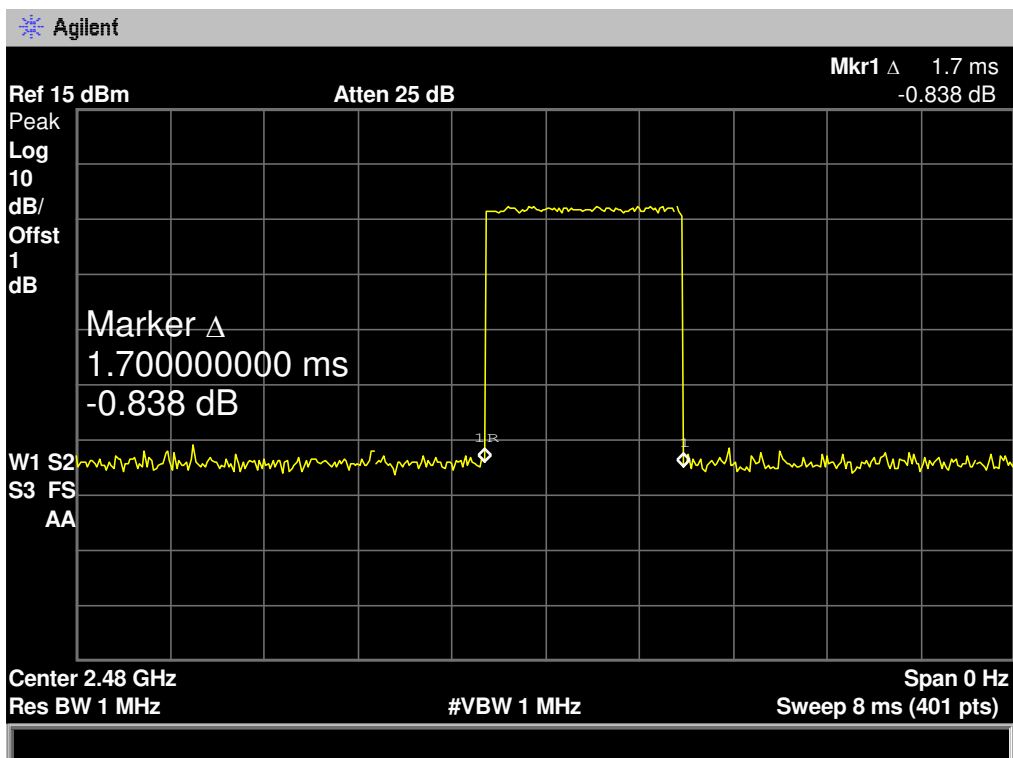

EUT:	Bluetooth Speaker	Model Name :	HFD-810A		
Temperature:	25 °C	Relative Humidity:	55%		
Test Voltage:	AC 120V/60Hz				
Test Mode:	Hopping Mode (8-DPSK DH5)				
Channel (MHz)	Pulse Time (ms)	Total of Dwell (ms)	Period Time (s)	Limit (ms)	Result
2402	3.000	320.00	31.60	400	PASS
2441	3.000	320.00			
2480	3.000	320.00			

8-DPSK Hopping Mode DH5

2402 MHz

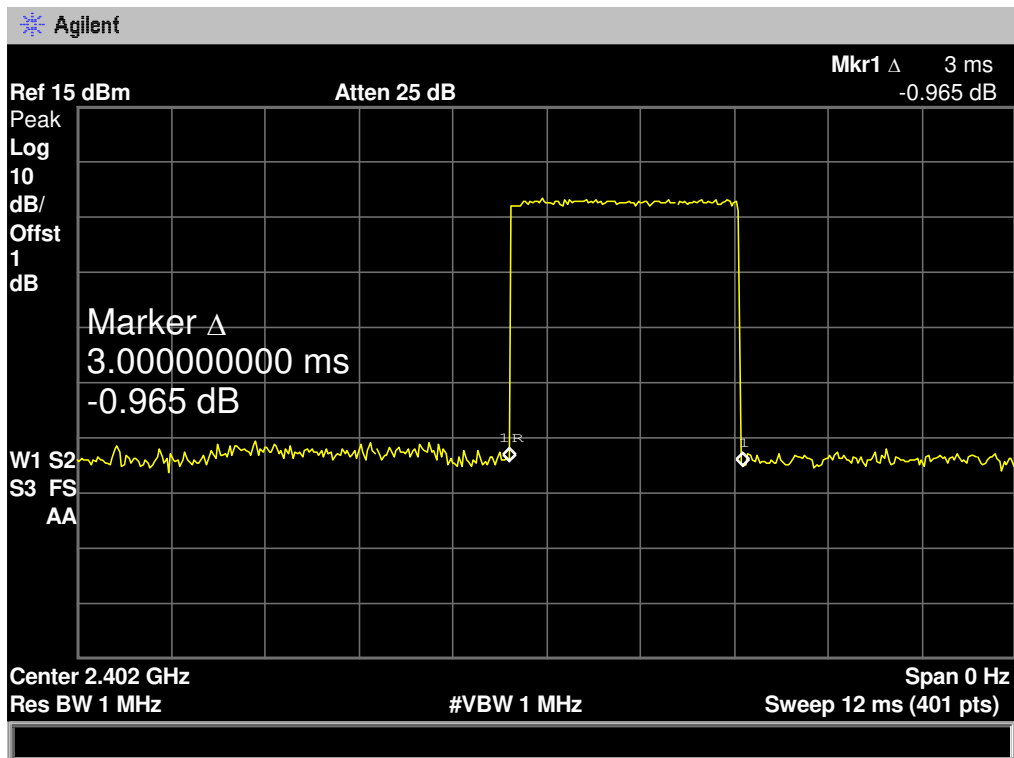

8-DPSK Hopping Mode DH5

2441 MHz

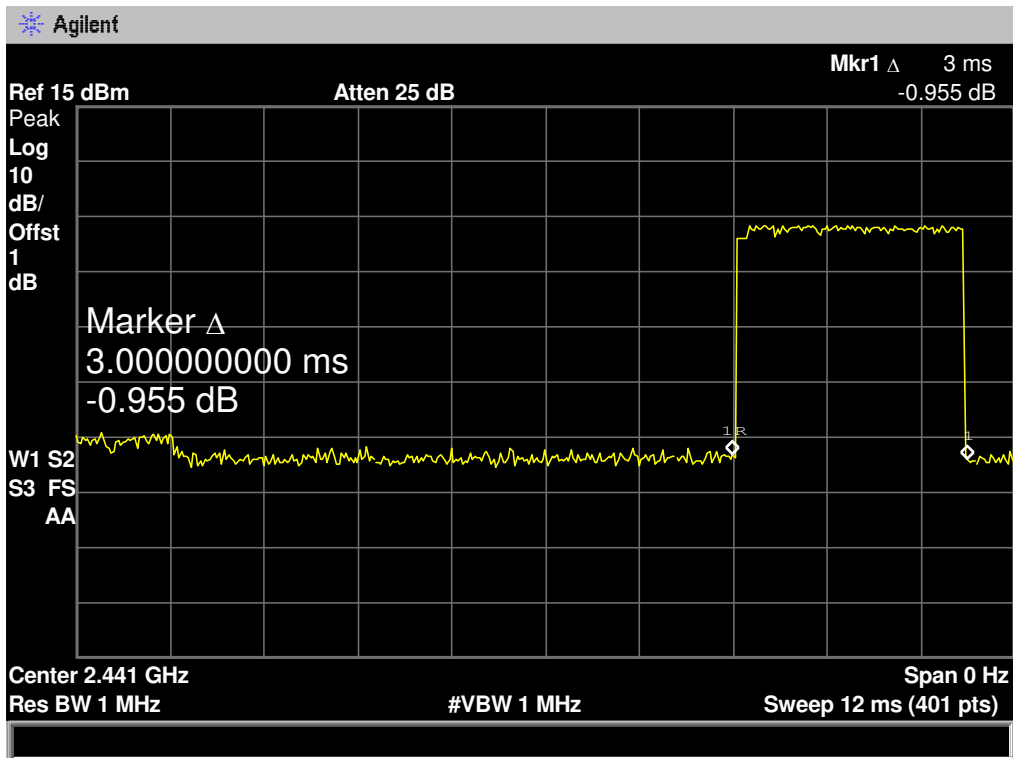

8-DPSK Hopping Mode DH5

2480 MHz

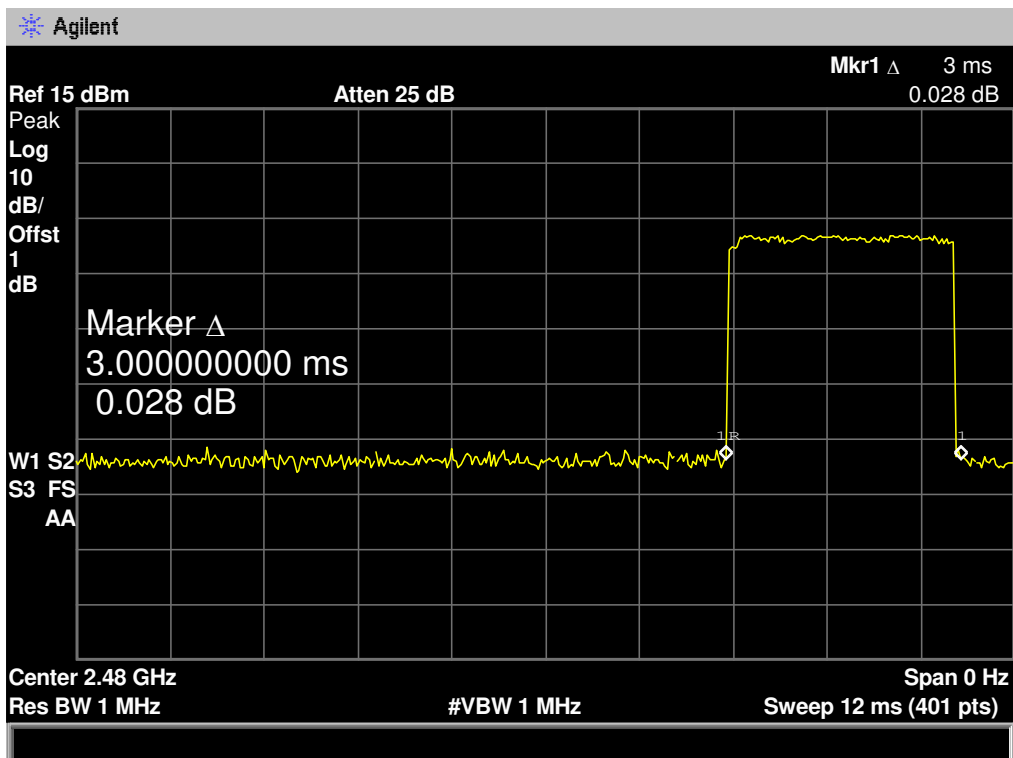

9. Channel Separation and Bandwidth Test

9.1 Test Standard and Limit

- 9.1.1 Test Standard
FCC Part 15.247
- 9.1.2 Test Limit

Test Item	Limit	Frequency Range(MHz)
Bandwidth	≤ 1 MHz (20dB bandwidth)	2400~2483.5
Channel Separation	>25 KHz or $>$ two-thirds of the 20 dB bandwidth Which is greater	2400~2483.5

9.2 Test Setup

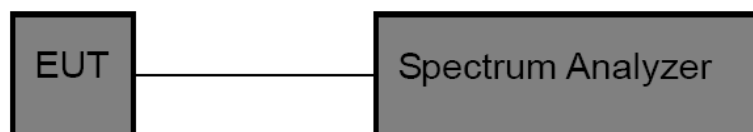

9.3 Test Procedure

- (1) The EUT was directly connected to the spectrum analyzer and antenna output port as show in the block diagram above.
- (2) Spectrum Setting:
Channel Separation: RBW=30 kHz, VBW=100 kHz.
Bandwidth: RBW=30 kHz, VBW=100 kHz.
- (3) The bandwidth is measured at an amplitude level reduced 20dB from the reference level. The reference level is the level of the highest amplitude signal observed from the transmitter at the fundamental frequency. Once the reference level is established, the equipment is conditioned with typical modulating signal to produce the worst –case (i.e the widest) bandwidth.
- (4) Measure the channel separation the spectrum analyzer was set to Resolution Bandwidth:30 kHz, and Video Bandwidth:100 kHz. Sweep Time set auto.

9.4 EUT Operating Condition

The EUT was set to the Hopping Mode for Channel Separation Test and continuously transmitting for the Bandwidth Test.

9.5 Test Data

EUT:	Bluetooth Speaker	Model Name :	HFD-810A
Temperature:	25 °C	Relative Humidity:	55%
Test Voltage:	AC 120V/60Hz		
Test Mode:	TX Mode (GFSK)		
Channel frequency (MHz)	99% OBW (kHz)	20dB Bandwidth (kHz)	20dB Bandwidth *2/3 (kHz)
2402	817.0810	849.460	
2441	818.2112	845.337	
2480	820.5198	848.473	

GFSK TX Mode

2402 MHz

Agilent

Ref 15 dBm Atten 25 dB

#Peak

Log

10

dB/

Offst

Center

1

dB

2.40200000 GHz

Center 2.402 GHz Span 3 MHz

#Res BW 30 kHz #VBW 100 kHz Sweep 8.04 ms (401 pts)

Occupied Bandwidth

817.0810 kHz

Occ BW % Pwr 99.00 %

x dB -20.00 dB

Transmit Freq Error -69.281 kHz

x dB Bandwidth 849.460 kHz

GFSK TX Mode

2441 MHz

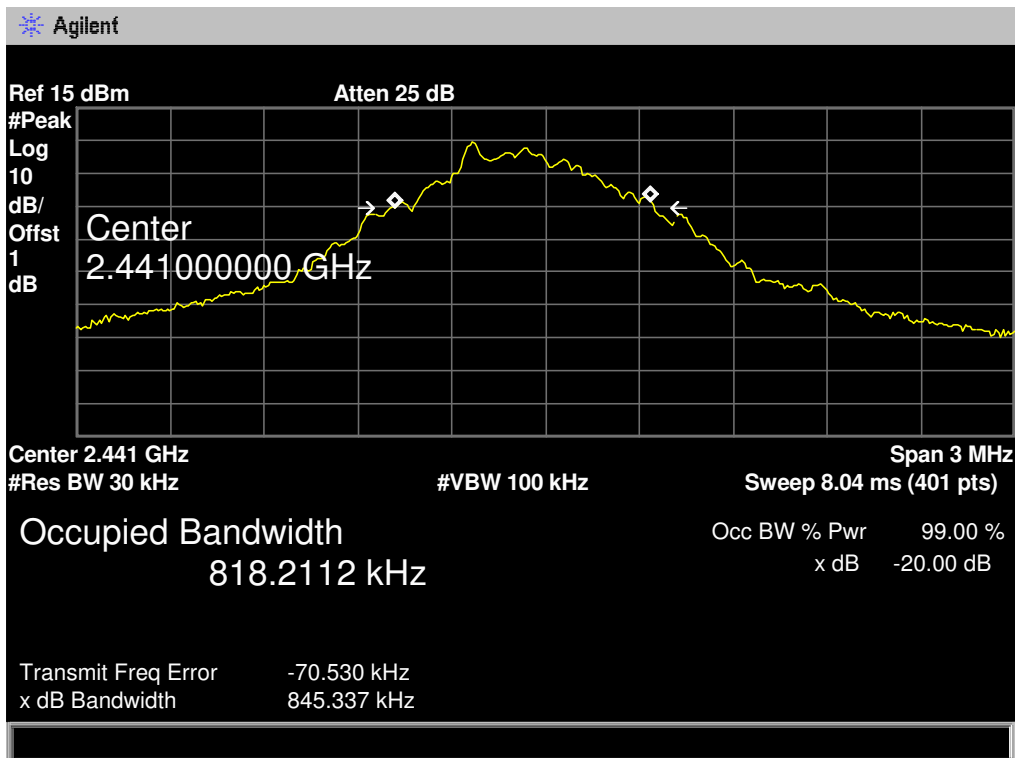

GFSK TX Mode

2480 MHz

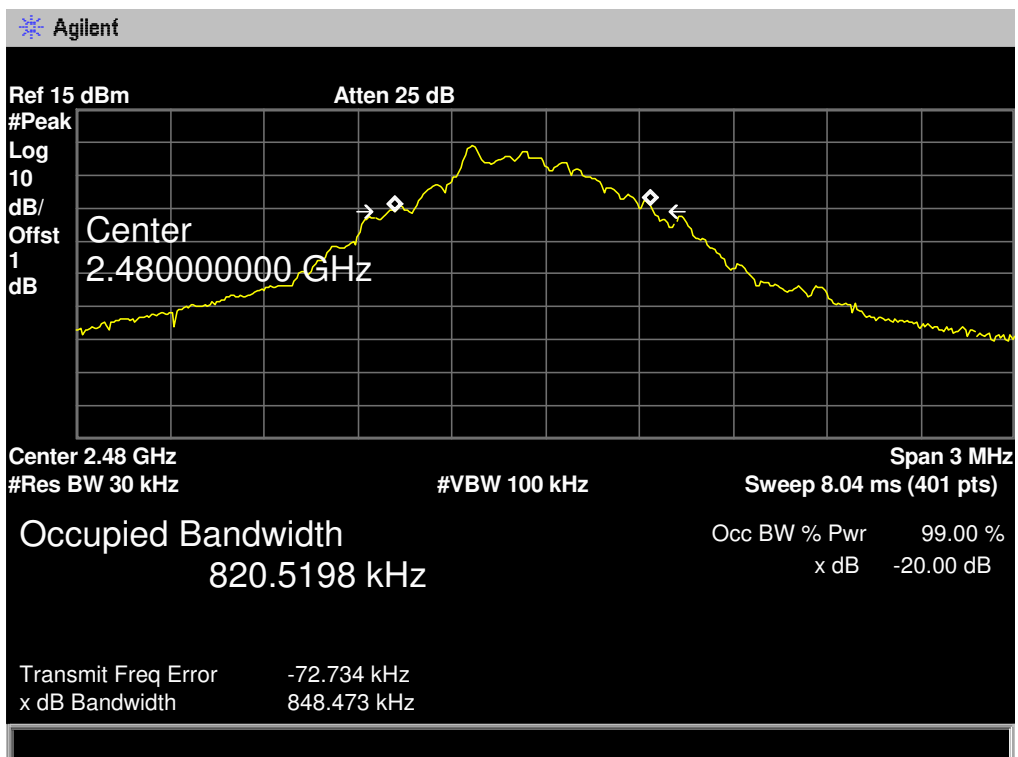

EUT:	Bluetooth Speaker	Model Name :	HFD-810A
Temperature:	25 °C	Relative Humidity:	55%
Test Voltage:	AC 120V/60Hz		
Test Mode:	TX Mode ($\pi/4$ -DQPSK)		
Channel frequency (MHz)	99% OBW (kHz)	20dB Bandwidth (kHz)	20dB Bandwidth *2/3 (kHz)
2402	1073.60	1120.00	746.67
2441	1076.20	1147.00	764.67
2480	1085.20	1157.00	771.30

$\pi/4$ -DQPSK TX Mode

2402 MHz

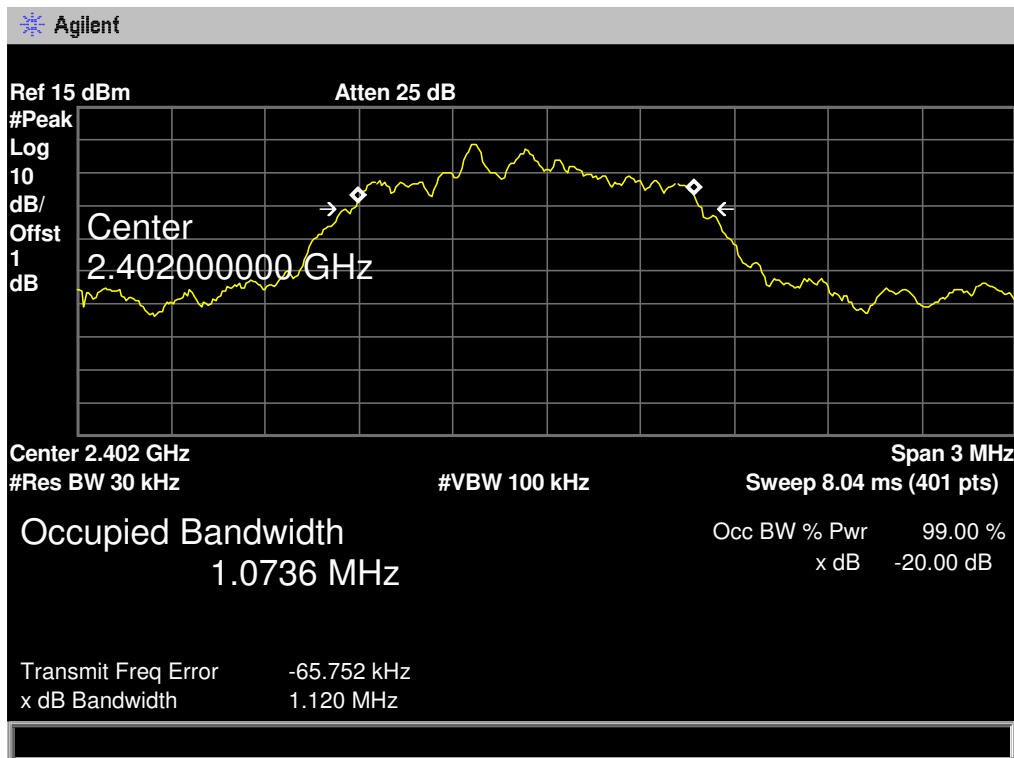

π /4-DQPSK TX Mode

2441 MHz

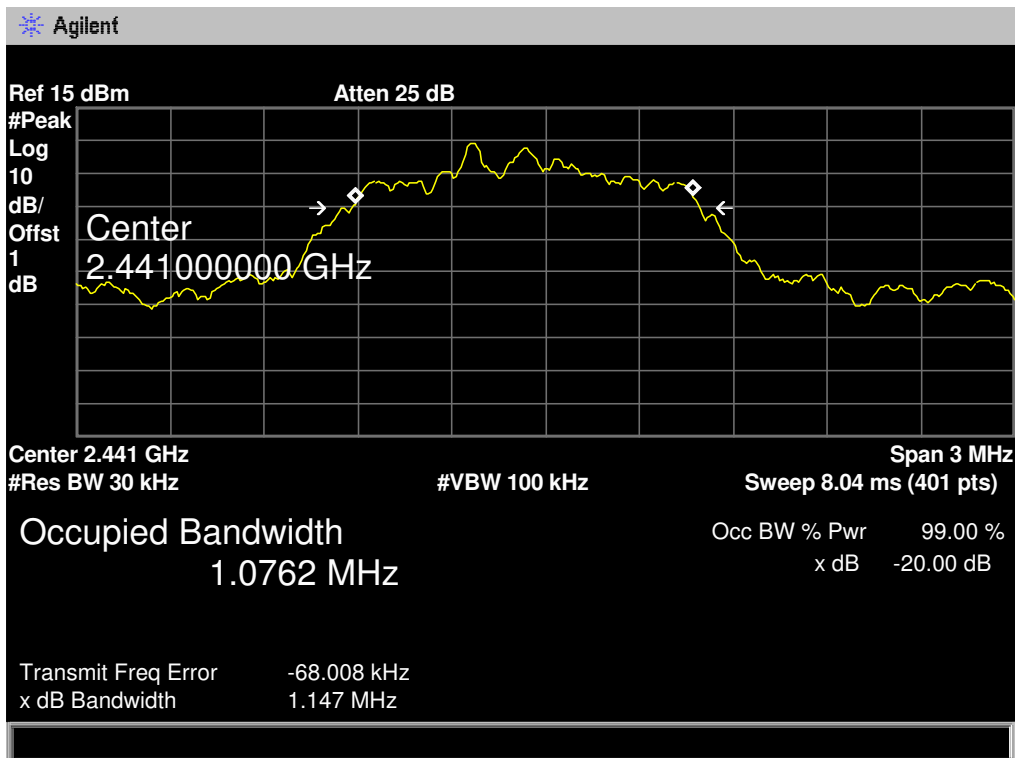

π /4-DQPSK TX Mode

2480 MHz

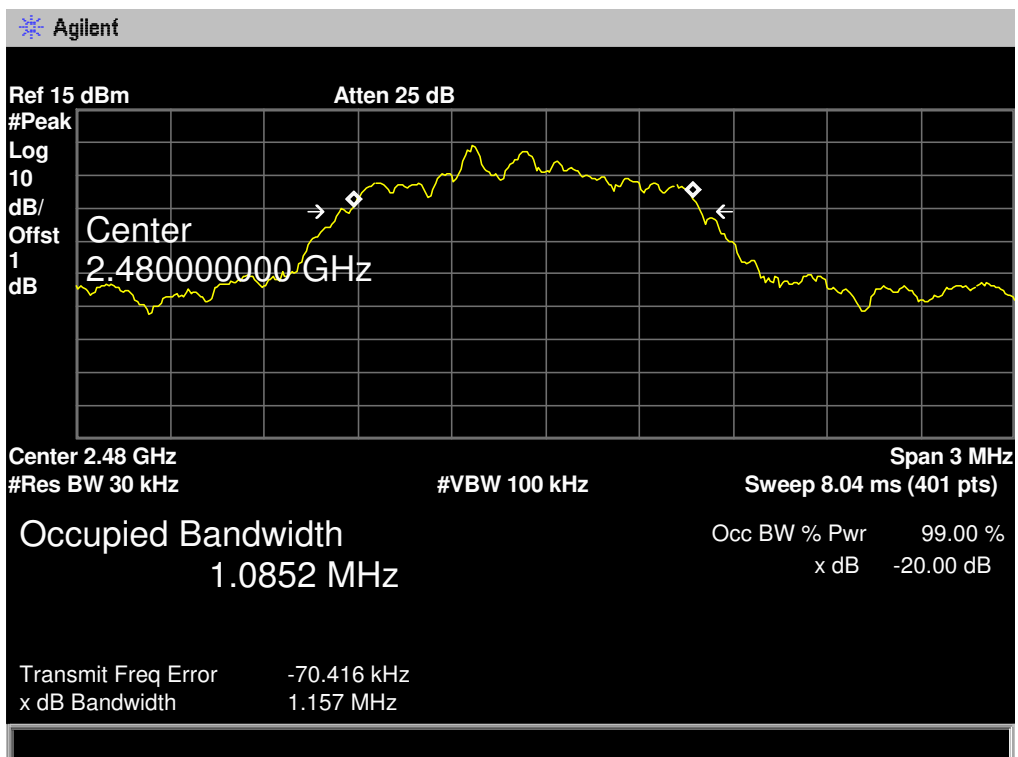

EUT:	Bluetooth Speaker	Model Name :	HFD-810A
Temperature:	25 °C	Relative Humidity:	55%
Test Voltage:	AC 120V/60Hz		
Test Mode:	TX Mode (8-DPSK)		
Channel frequency (MHz)	99% OBW (kHz)	20dB Bandwidth (kHz)	20dB Bandwidth *2/3 (kHz)
2402	1112.40	1215.00	810.00
2441	1116.80	1215.00	810.00
2480	1170.40	1239.00	826.00

8-DPSK TX Mode

2402 MHz

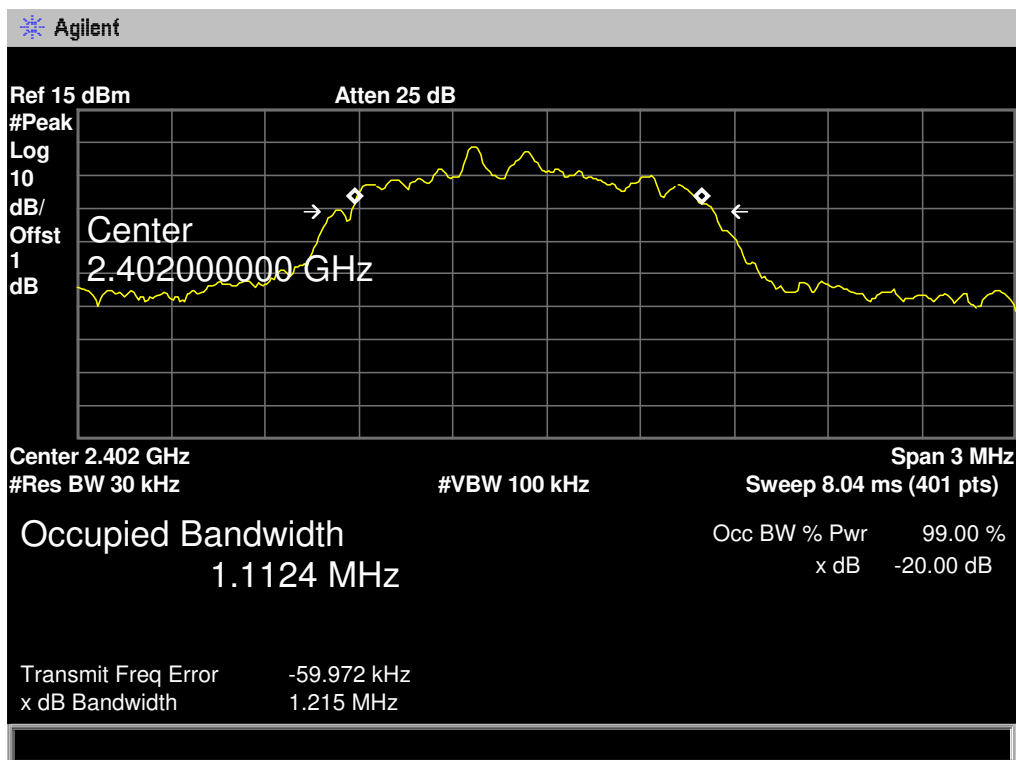

8-DPSK TX Mode

2441 MHz

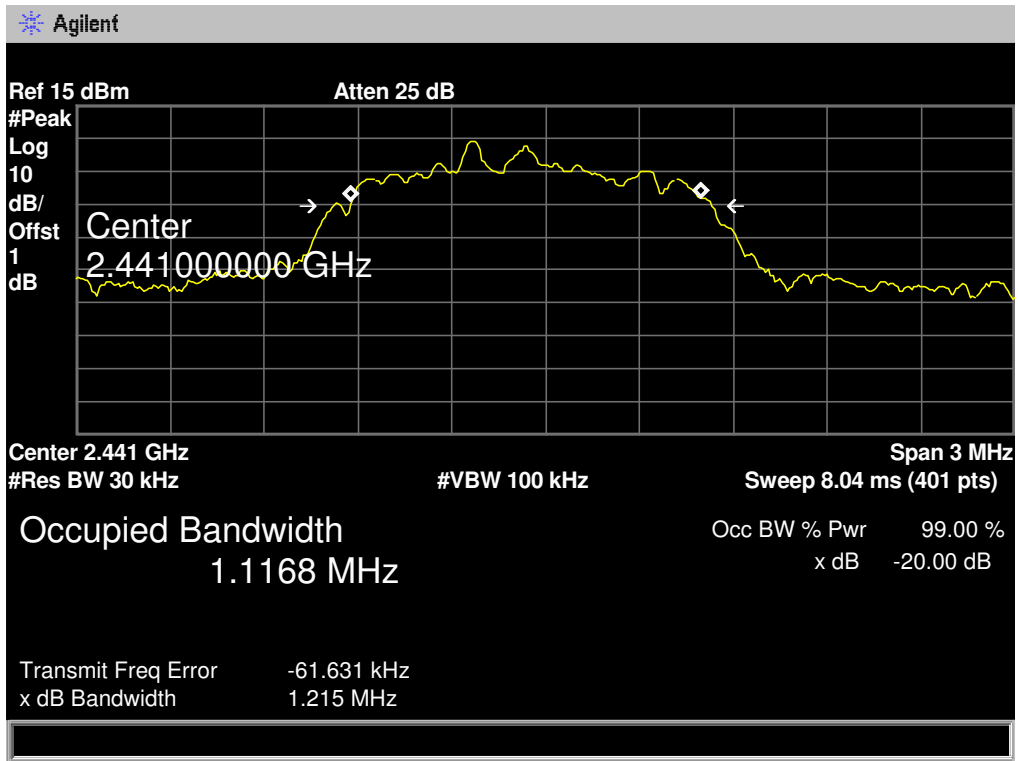

8-DPSK TX Mode

2480 MHz

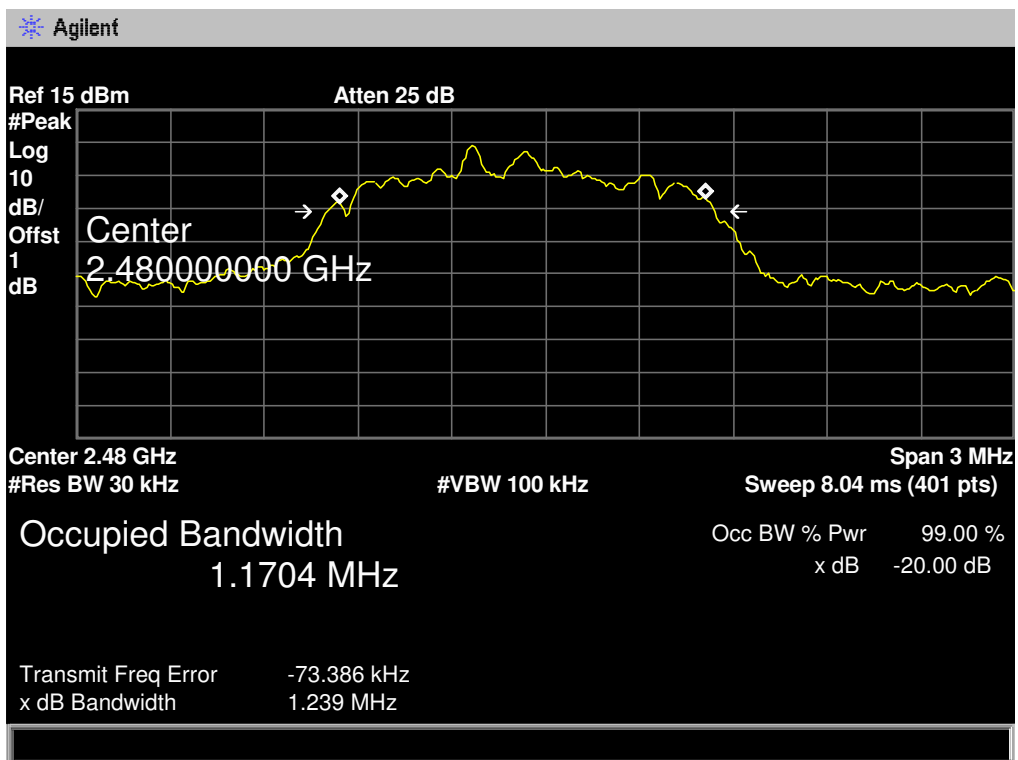

EUT:	Bluetooth Speaker	Model Name :	HFD-810A
Temperature:	25 °C	Relative Humidity:	55%
Test Voltage:	AC 120V/60Hz		
Test Mode:	Hopping Mode (GFSK)		
Channel frequency (MHz)	Separation Read Value (kHz)	Separation Limit (kHz)	
2402	1005.00	849.460	
2441	1005.00	845.337	
2480	1005.00	848.473	

GFSK Hopping Mode

2402 MHz

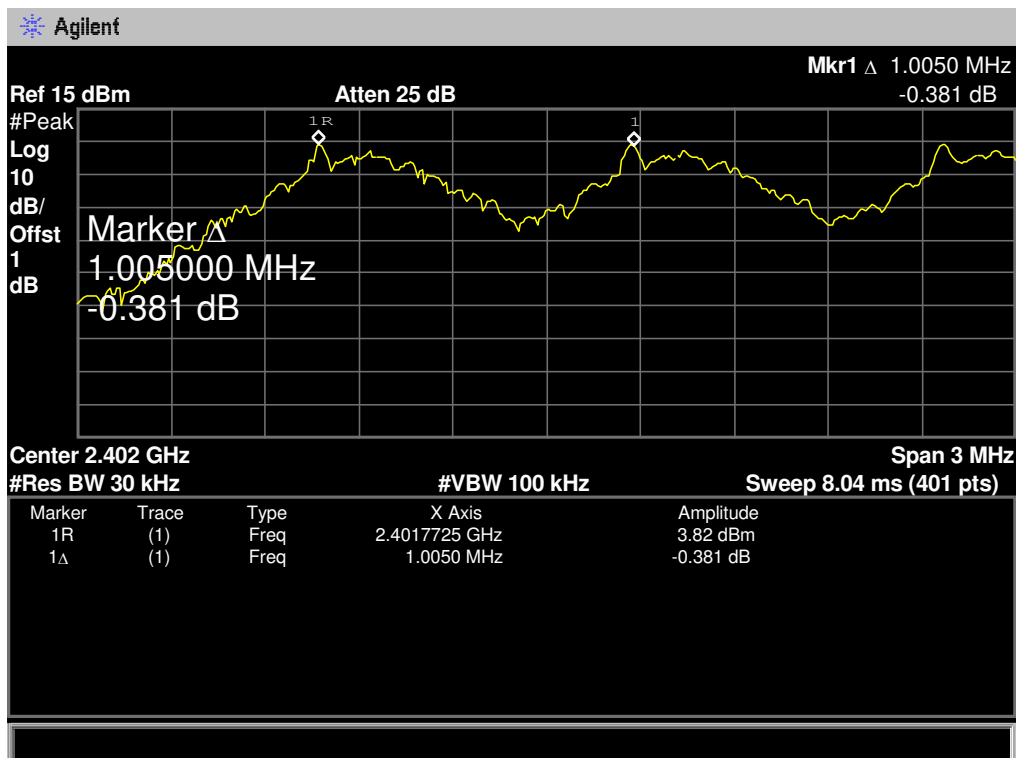

GFSK Hopping Mode

2441 MHz

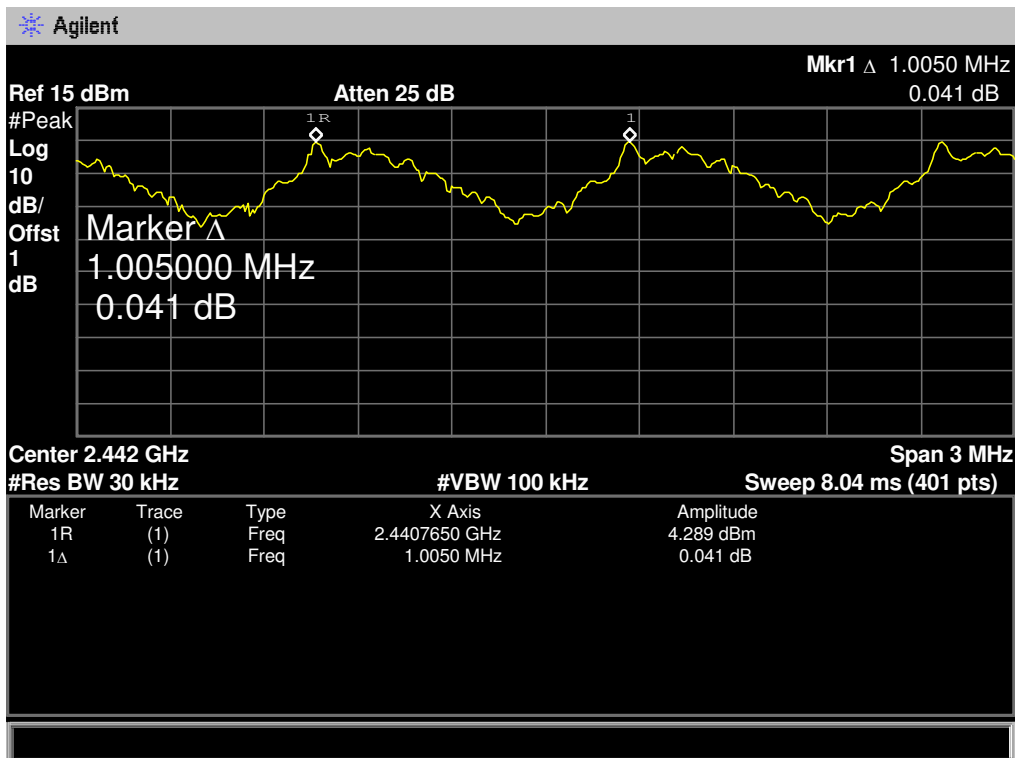

GFSK Hopping Mode

2480 MHz

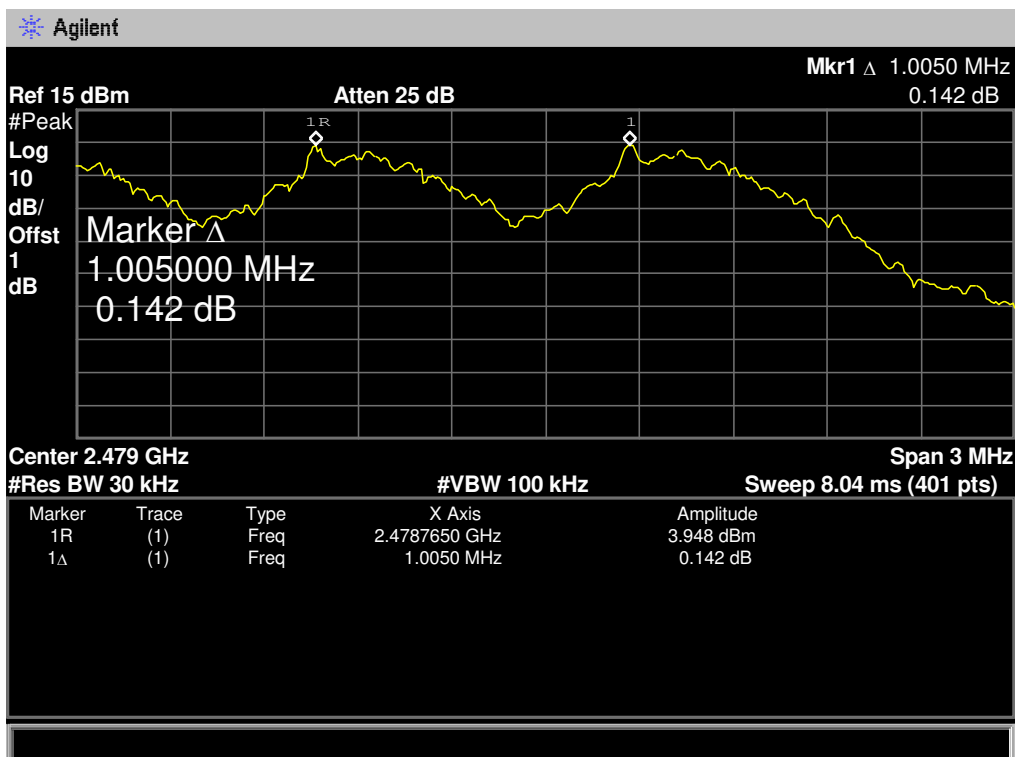

EUT:	Bluetooth Speaker	Model Name :	HFD-810A
Temperature:	25 °C	Relative Humidity:	55%
Test Voltage:	AC 120V/60Hz		
Test Mode:	Hopping Mode ($\pi/4$ -DQPSK)		
Channel frequency (MHz)	Separation Read Value (kHz)	Separation Limit (kHz)	
2402	1005.00	746.67	
2441	1005.00	764.67	
2480	1005.00	771.30	

$\pi/4$ -DQPSK Hopping Mode

2402 MHz

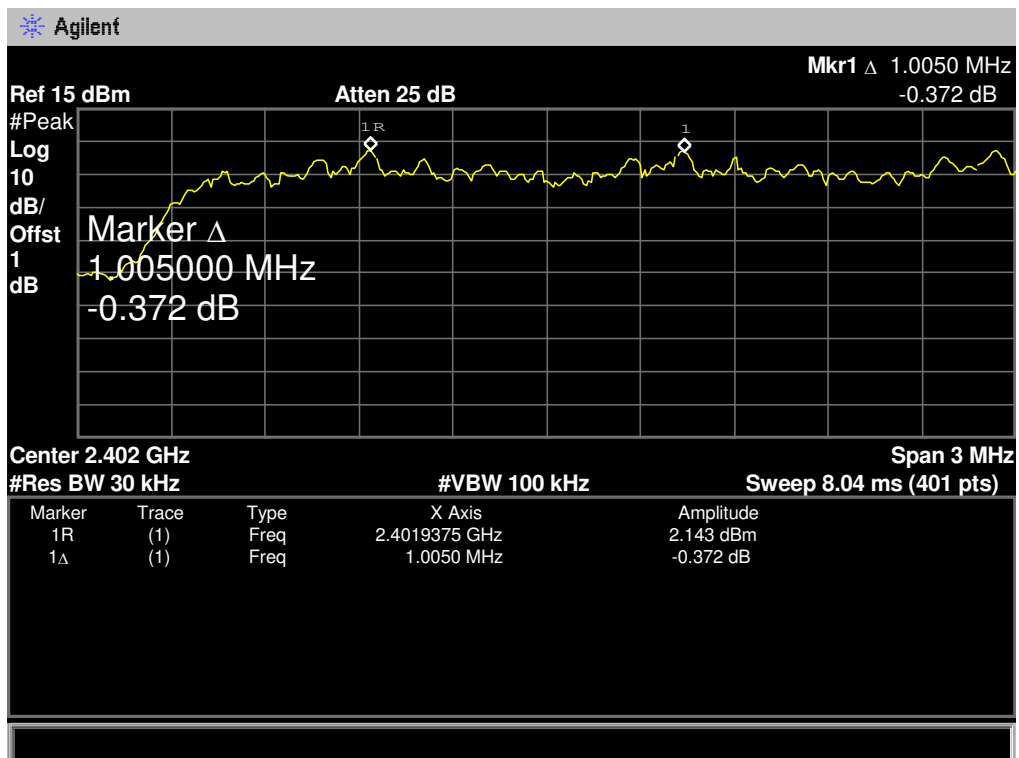

π /4-DQPSK Hopping Mode

2441 MHz

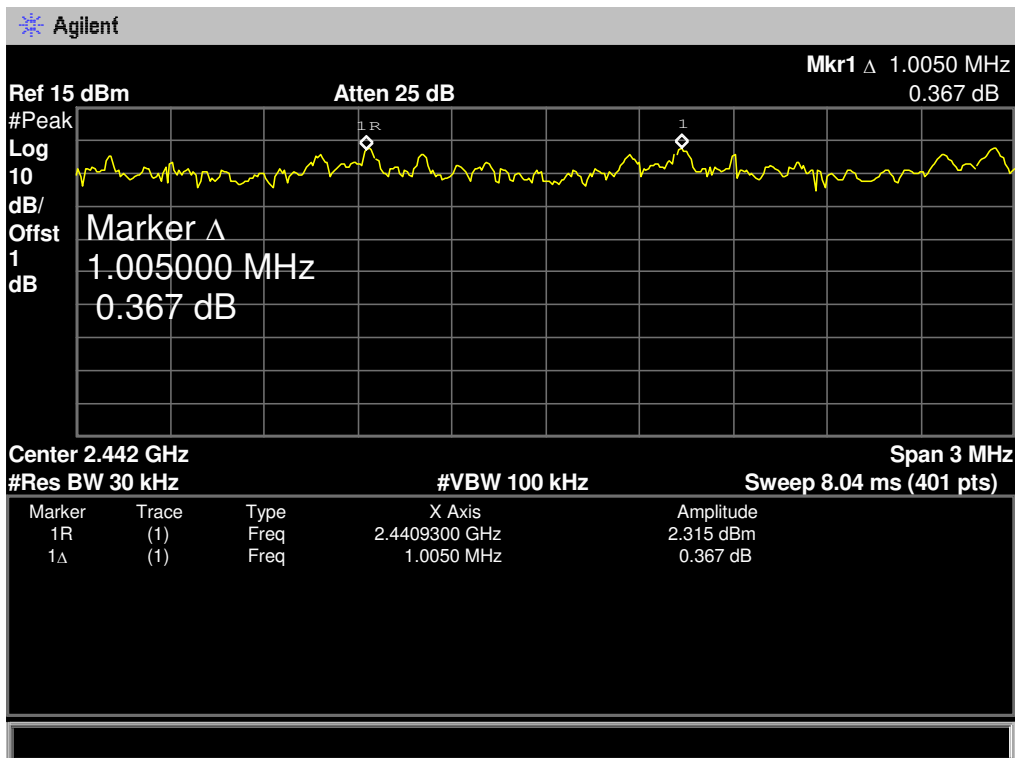

π /4-DQPSK Hopping Mode

2480 MHz

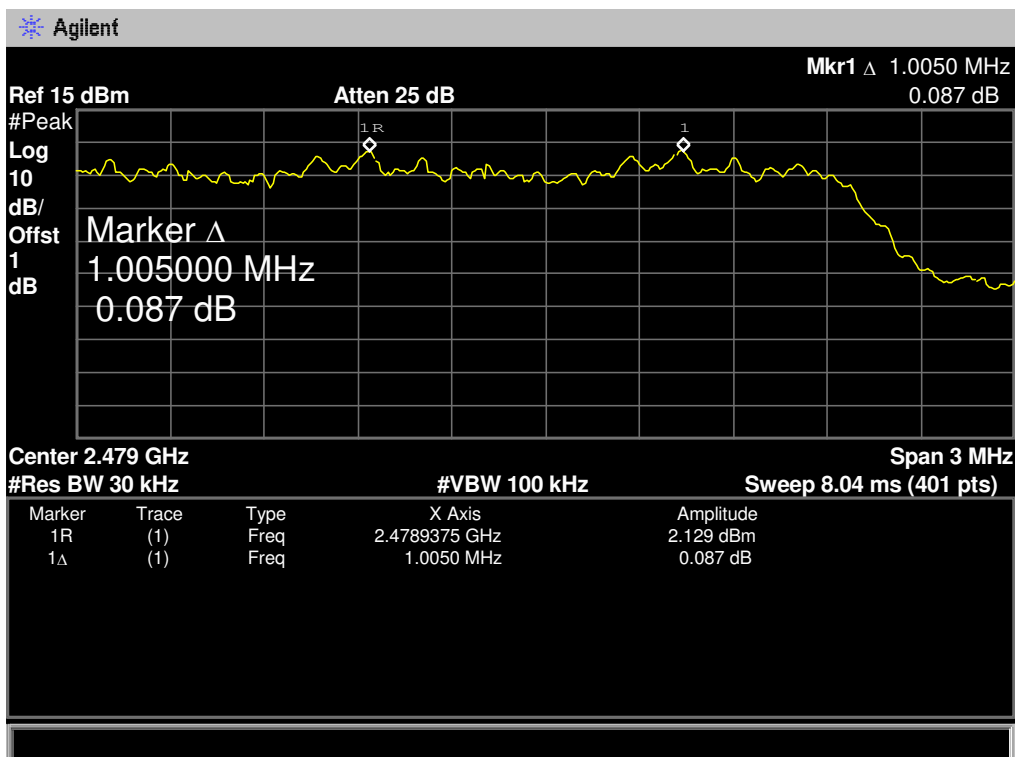

EUT:	Bluetooth Speaker	Model Name :	HFD-810A
Temperature:	25 °C	Relative Humidity:	55%
Test Voltage:	AC 120V/60Hz		
Test Mode:	Hopping Mode (8-DPSK)		
Channel frequency (MHz)	Separation Read Value (kHz)	Separation Limit (kHz)	
2402	1005.00	810.00	
2441	1005.00	810.00	
2480	1005.00	826.00	

8-DPSK Hopping Mode

2402 MHz

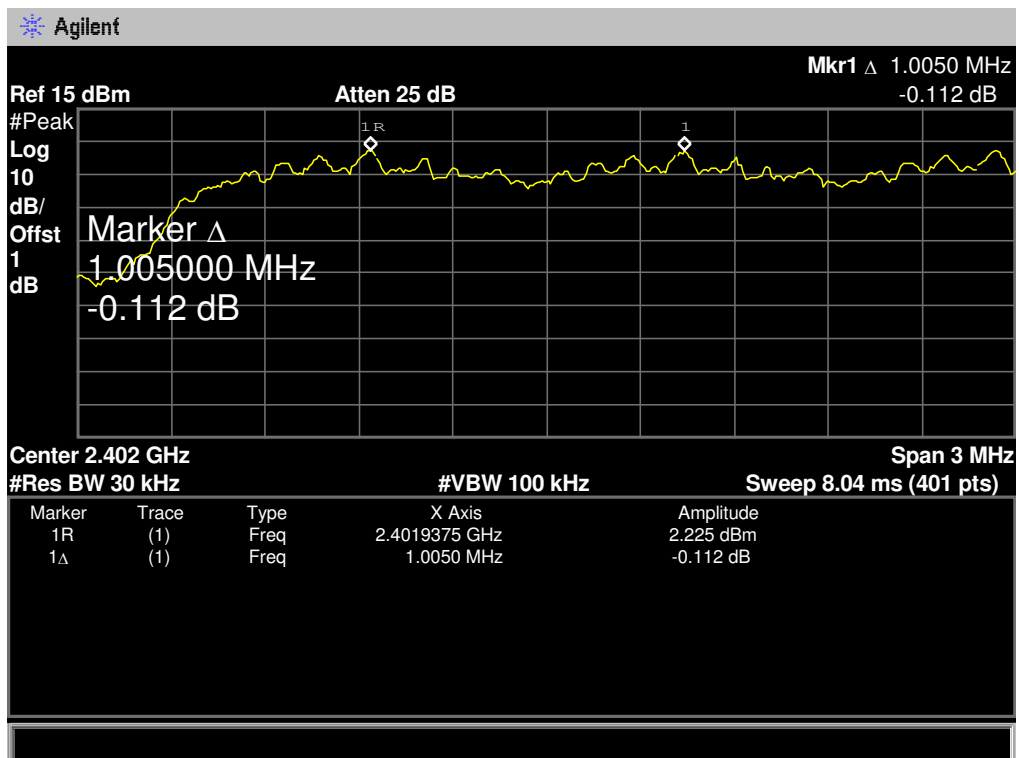

8-DPSK Hopping Mode

2441 MHz

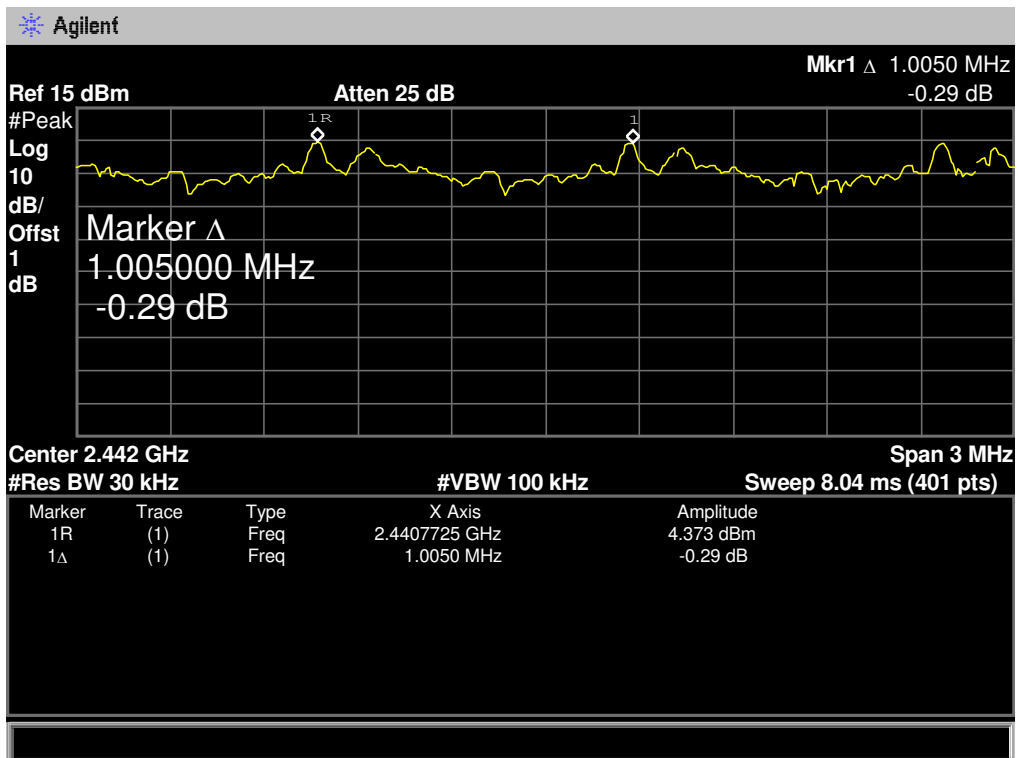

8-DPSK Hopping Mode

2480 MHz

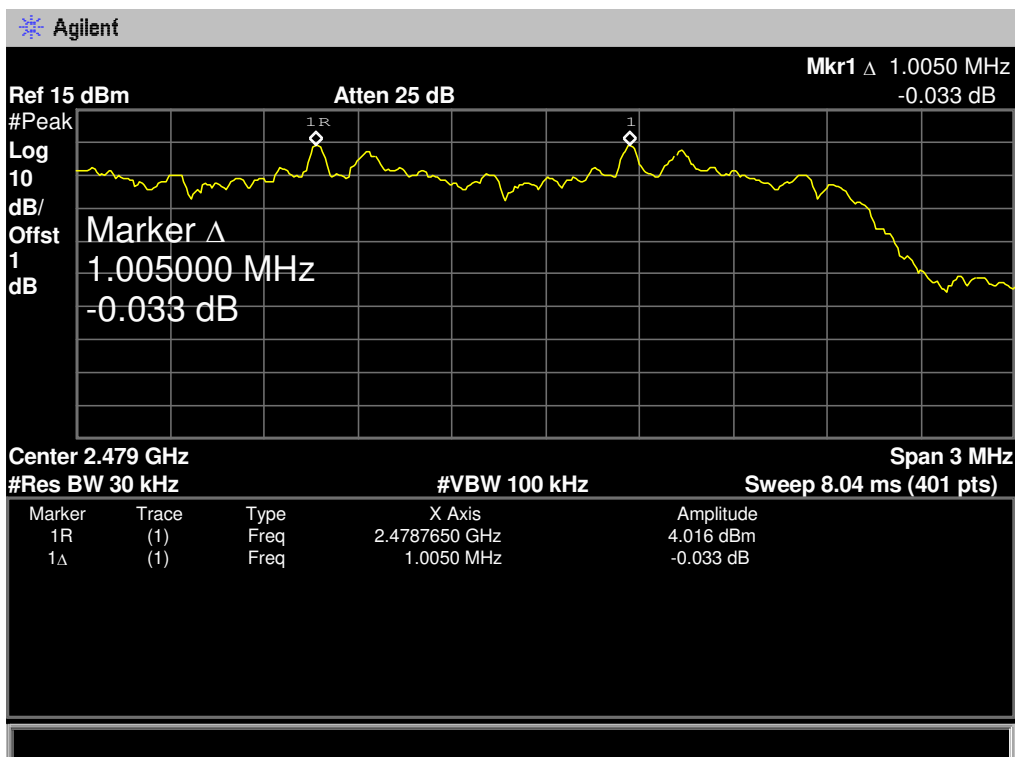

10. Peak Output Power Test

10.1 Test Standard and Limit

10.1.1 Test Standard

FCC Part 15.247 (b) (1)

10.1.2 Test Limit

Test Item	Limit	Frequency Range(MHz)
Peak Output Power	Hopping Channels>75 Power<1W(30dBm) Other <125 mW(21dBm)	2400~2483.5

10.2 Test Setup

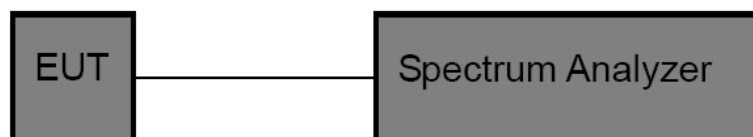

10.3 Test Procedure

- (1) The EUT was directly connected to the spectrum analyzer and antenna output port as show in the block diagram above.
- (2) Spectrum Setting:
Peak Detector: RBW=1 MHz, VBW=3 MHz for bandwidth less than 1MHz.
RBW=3 MHz, VBW=3 MHz for bandwidth more than 1MHz.

10.4 EUT Operating Condition

The EUT was set to continuously transmitting in the max power during the test.

10.5 Test Data

EUT:	Bluetooth Speaker	Model Name :	HFD-810A
Temperature:	25 °C	Relative Humidity:	55%
Test Voltage:	AC 120V/60Hz		
Test Mode:	TX Mode (GFSK)		
Channel frequency (MHz)	Test Result (dBm)	Limit (dBm)	
2402	0.816	30	
2441	3.288		
2480	2.041		

GFSK TX Mode

2402 MHz

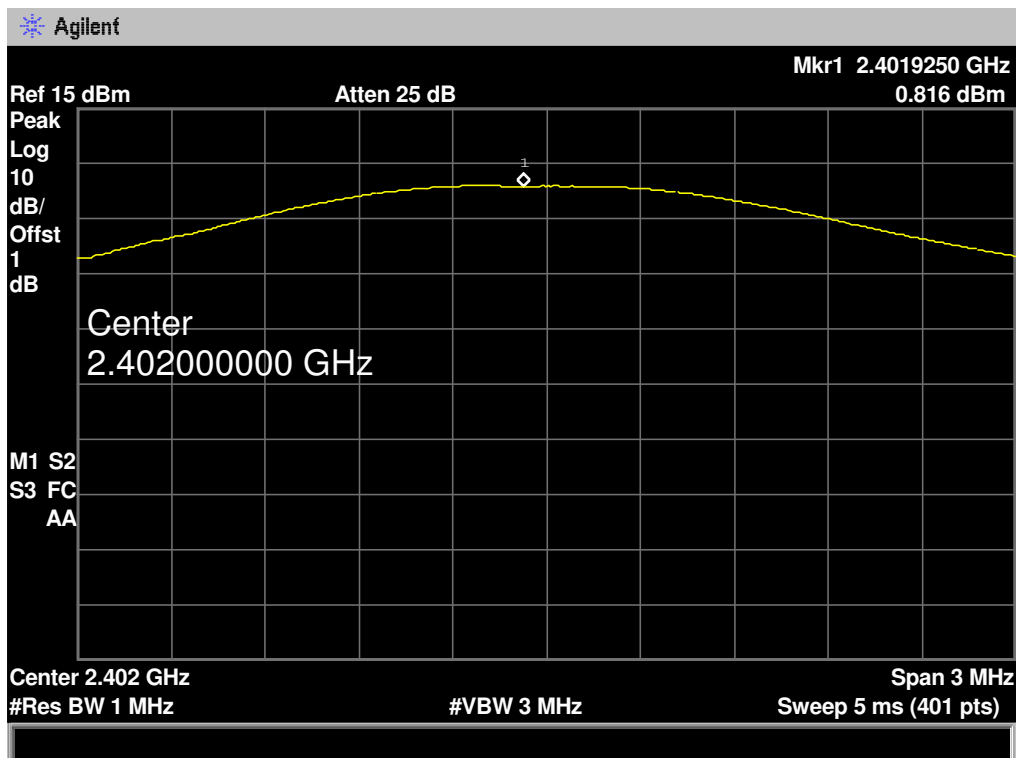

GFSK TX Mode

2441 MHz

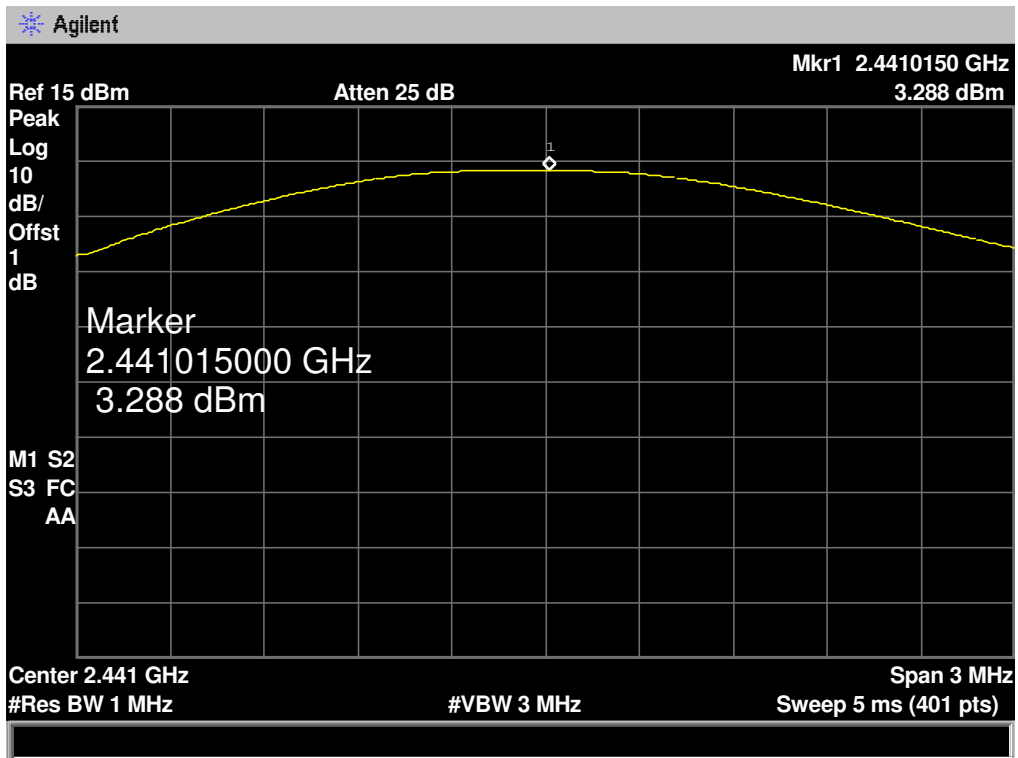

GFSK TX Mode

2480 MHz

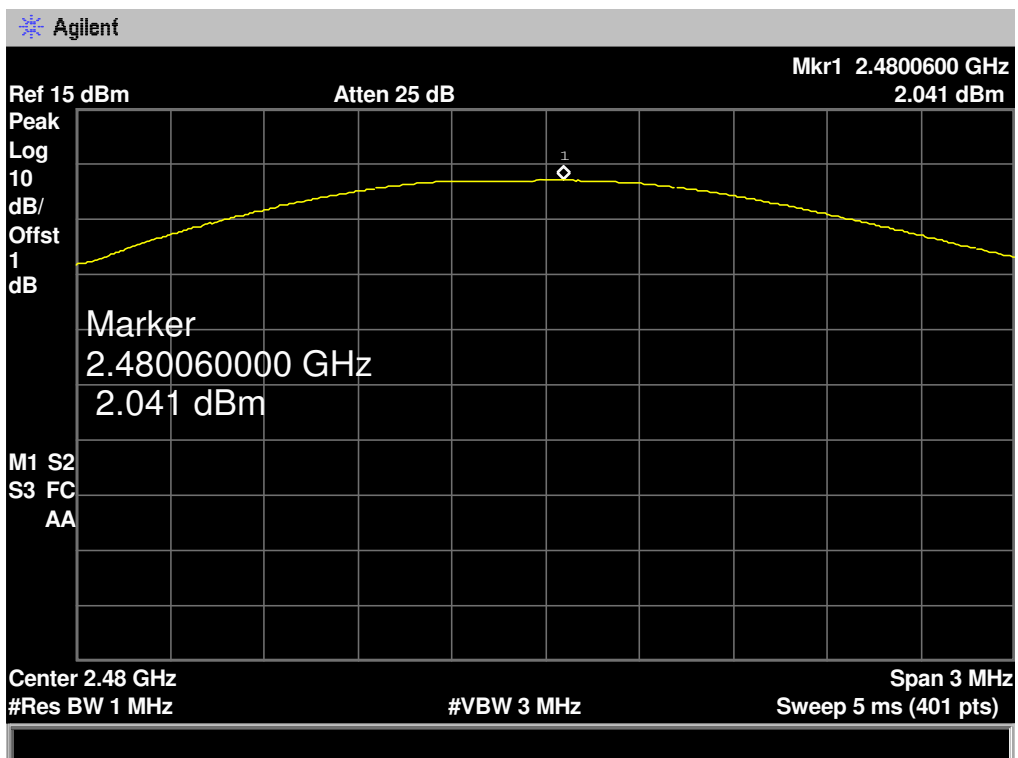

EUT:	Bluetooth Speaker	Model Name :	HFD-810A
Temperature:	25 °C	Relative Humidity:	55%
Test Voltage:	AC 120V/60Hz		
Test Mode:	TX Mode ($\pi/4$ -DQPSK)		
Channel frequency (MHz)	Test Result (dBm)	Limit (dBm)	
2402	2.509	21	
2441	1.248		
2480	3.241		

$\pi/4$ -DQPSK TX Mode

2402 MHz

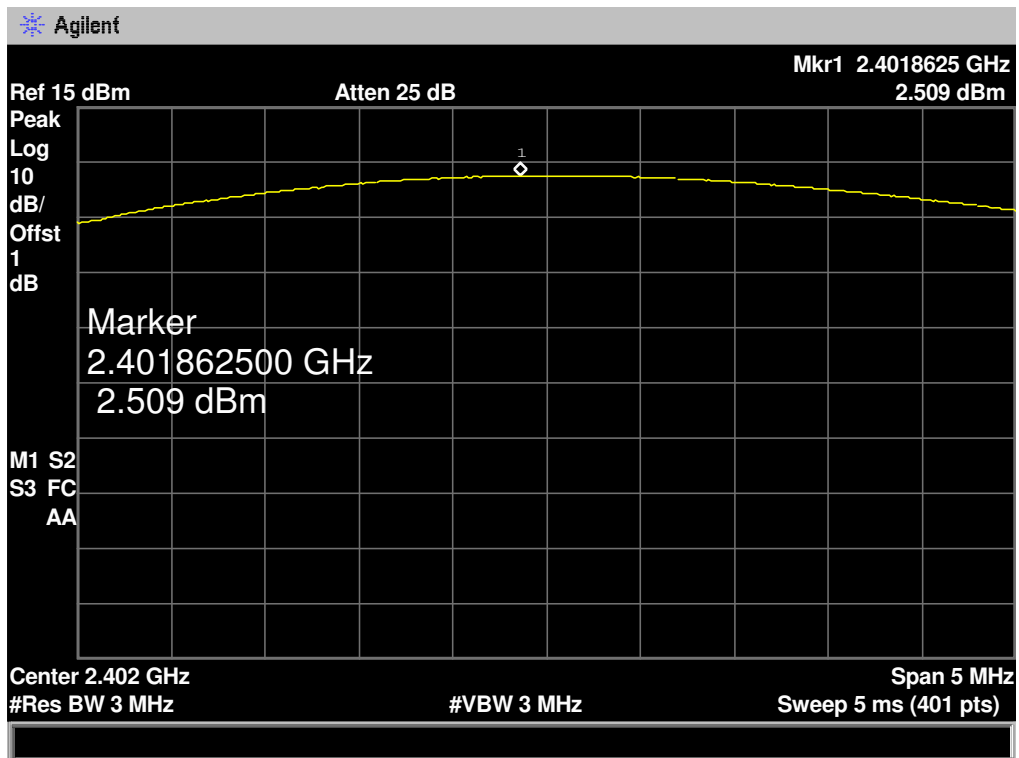

π /4-DQPSK TX Mode

2441 MHz

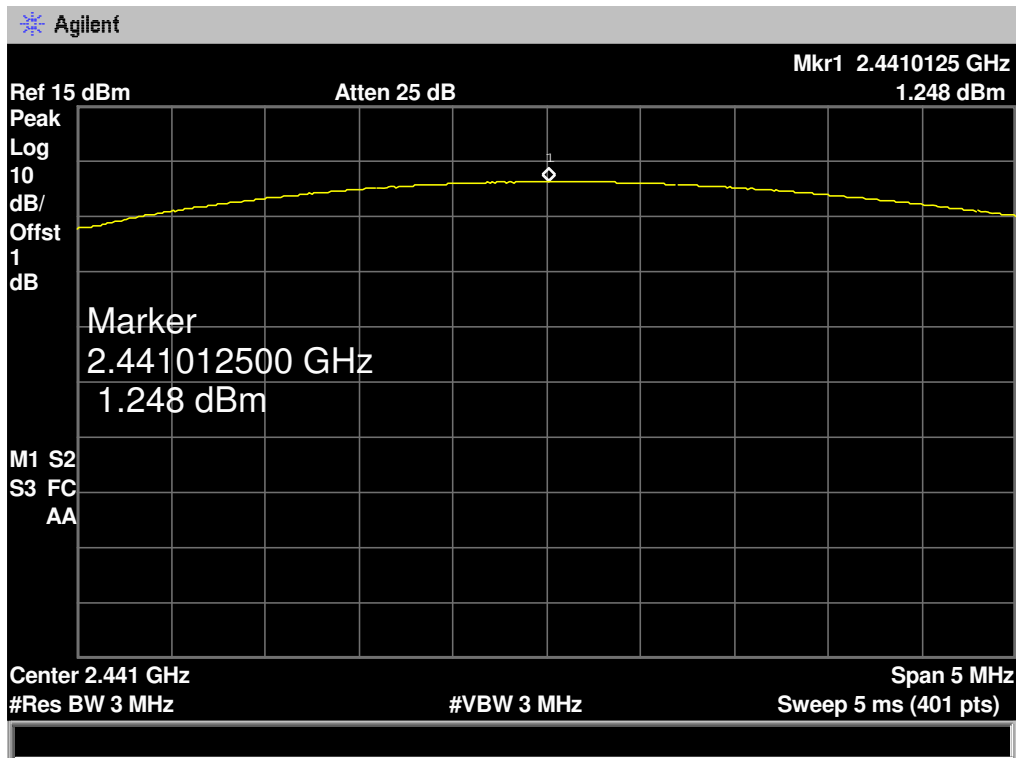

π /4-DQPSK TX Mode

2480 MHz

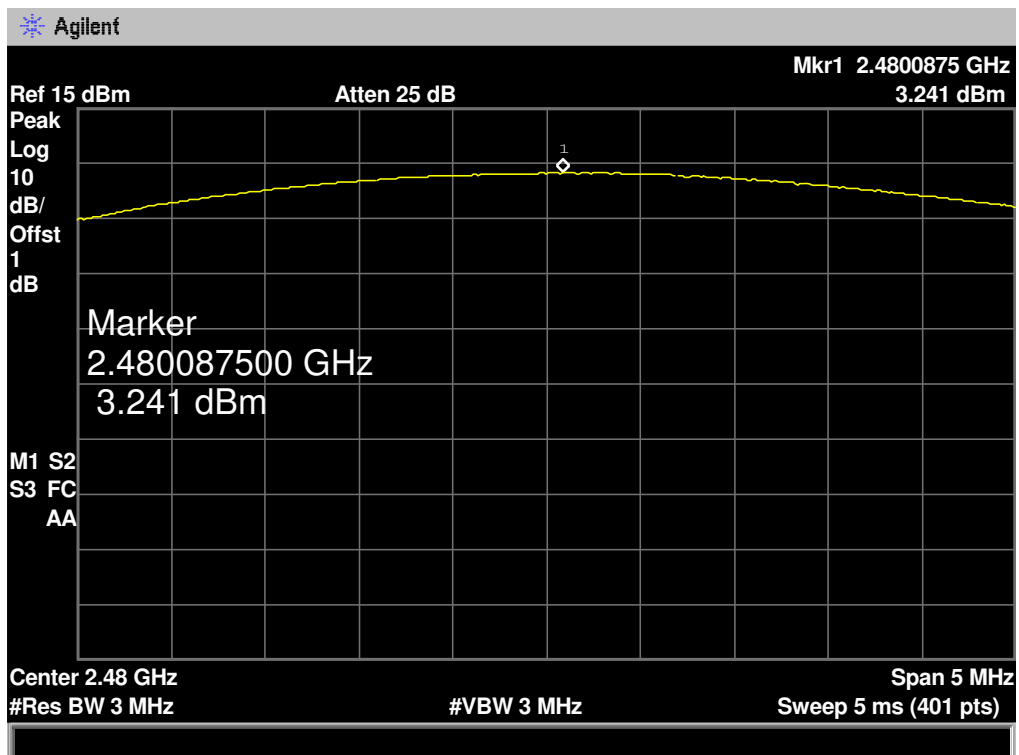

EUT:	Bluetooth Speaker	Model Name :	HFD-810A
Temperature:	25 °C	Relative Humidity:	55%
Test Voltage:	AC 120V/60Hz		
Test Mode:	TX Mode (8-DPSK)		
Channel frequency (MHz)	Test Result (dBm)	Limit (dBm)	
2402	2.978	21	
2441	1.743		
2480	3.782		
8-DPSK TX Mode			
2402 MHz			
<p>Agilent</p> <p>Ref 15 dBm Atten 25 dB Mkr1 2.4021125 GHz 2.978 dBm</p> <p>Peak Log 10 dB/ Offst 1 dB</p> <p>Marker 2.402112500 GHz 2.978 dBm</p> <p>M1 S2 S3 FC AA</p> <p>Center 2.402 GHz Span 5 MHz #Res BW 3 MHz #VBW 3 MHz Sweep 5 ms (401 pts)</p>			

8-DPSK TX Mode

2441 MHz

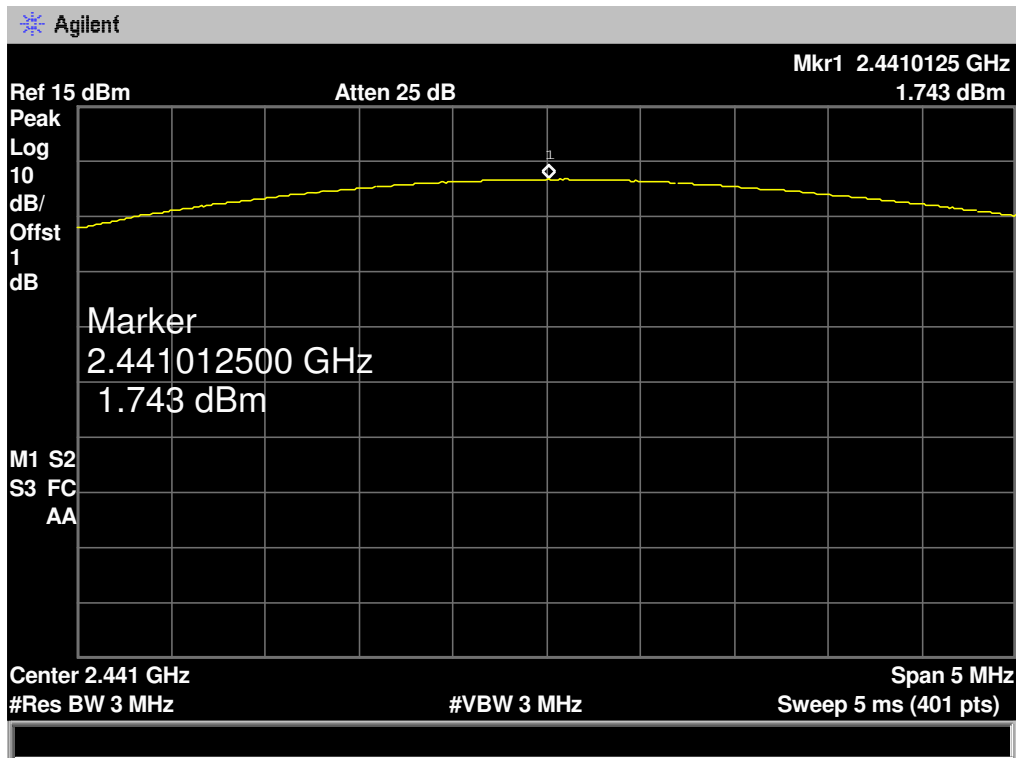

8-DPSK TX Mode

2480 MHz

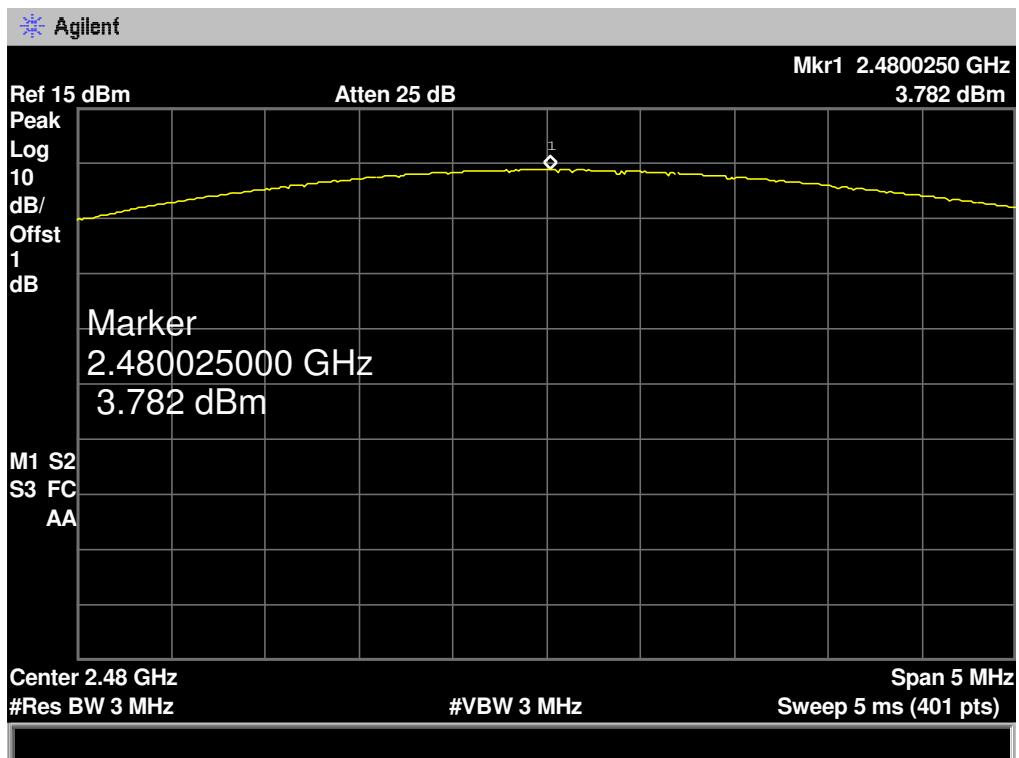

11. Antenna Requirement

11.1 Standard Requirement

11.1.1 Standard

FCC Part 15.203

11.1.2 Requirement

An intentional radiator shall be designed to ensure that no antenna other than that furnished by the responsible party shall be used with the device. The use of a permanently attached antenna or of an antenna that uses a unique coupling to the intentional radiator shall be considered sufficient to comply with the provisions of this Section. The manufacturer may design the unit so that a broken antenna can be replaced by the user, but the use of a standard antenna jack or electrical connector is prohibited.

11.2 Antenna Connected Construction

The directional gains of the antenna used for transmitting is 0.5 dBi, and the antenna connector is de-signed with permanent attachment and no consideration of replacement. Please see the EUT photo for details.

The EUT antenna is a PCB antenna. It complies with the standard requirement.

Antenna Type
<input checked="" type="checkbox"/> Permanent attached antenna
<input type="checkbox"/> Unique connector antenna
<input type="checkbox"/> Professional installation antenna