

# FCC TEST REPORT

Test report  
On Behalf of  
HOPSUN INTERNATIONAL (H.K.)LTD  
For

Motor of electric self-balan cing scooters PA Speaker  
Model No.: HS-PA210504, A17-T1002BUF, A17-T10112BUF,  
A17-T10122BUF, A17-P1022BNF, A17-P10212BNF,  
A17-P10222BNF, A17-P10312BUF, A17-P10322BUF,  
A17-P12312BUF, A17-P12322BUF, HS-PA110501, HS-PA110502,  
HS-PA112501 , HS-PA112502, P17-P1032BNF, P17-P1022BNF,  
P17-P1232BNF, HS-PA210501, HS-PA210502, HS-PA210503,  
HS-PA210504, HS-PA210505, HS-PA212501, HS-PA212503,  
PBX-410101  
FCC ID: 2AHY7PA210504

Prepared for : HOPSUN INTERNATIONAL (H.K.)LTD  
Room1609,B Building, new day CBC, second street of SHIXIA, Futian District,  
Shenzhen, China

Prepared By : Shenzhen ZCT Technology Co., Ltd.  
3F, 5th Building, Hongsheng Industrial Zone, No.4336 Bao'an Road, Bao'an  
District, Shenzhen, China.

Date of Test: October. 03, 2016 ~ October. 10, 2016  
Date of Report: October. 11, 2016  
Report Number: HK1601003040-E

## TEST RESULT CERTIFICATION

**Applicant's name** ..... : HOPSUN INTERNATIONAL (H.K.)LTD  
**Address** ..... : Room1609, B Building, new day CBC, second street of SHIXIA,  
 Futian District, Shenzhen, China  
**Manufacture's Name** ..... : HOPSUN INTERNATIONAL (H.K.)LTD  
**Address** ..... : Room1609, B Building, new day CBC, second street of SHIXIA,  
 Futian District, Shenzhen, China

### Product description

Trade Mark: N/A  
 Product name ..... : Motor of electric self-balan cing scooers PA Speaker  
 Model and/or type reference : HS-PA210504; (Series models, see page 1 )

**Standards** ..... : FCC Rules and Regulations Part 15 Subpart C Section 15.249  
 ANSI C63.10: 2013

This publication may be reproduced in whole or in part for non-commercial purposes as long as the **Shenzhen ZCT Technology Co., Ltd.** is acknowledged as copyright owner and source of the material. **Shenzhen ZCT Technology Co., Ltd.** takes no responsibility for and will not assume liability for damages resulting from the reader's interpretation of the reproduced material due to its placement and context.

**Date of Test** ..... :  
 Date (s) of performance of tests ..... : **October. 03, 2016 ~ October. 10, 2016**  
 Date of Issue ..... : **October. 11, 2016**  
 Test Result ..... : **Pass**

Testing Engineer :



---

(Eric Xie)

Technical Manager :



---

(Dora Qin)

Authorized Signatory :



---

(Kait Chen)

<b>Table of Contents</b>	<b>Page</b>
1 . TEST SUMMARY	4
2 . GENERAL INFORMATION	5
2.1 GENERAL DESCRIPTION OF EUT	5
2.2 Operation of EUT during testing	6
2.3 DESCRIPTION OF TEST SETUP	6
2.4 MEASUREMENT INSTRUMENTS LIST	7
3 . CONDUCTED EMISSIONS TEST	8
3.1 Conducted Power Line Emission Limit	8
3.2 Test Setup	8
3.3 Test Procedure	8
3.4 Test Result	8
4 RADIATED EMISSION TEST	11
4.1 Radiation Limit	11
4.2 Test Setup	11
4.3 Test Procedure	12
4.4 Test Result	12
5 BAND EDGE	18
5.1 Limits	18
5.2 Test Procedure	18
5.3 Test Result	18
6 OCCUPIED BANDWIDTH MEASUREMENT	20
6.1 Test Setup	20
6.2 Test Procedure	20
6.3 Measurement Equipment Used	20
6.4 Test Result	20
7 ANTENNA REQUIREMENT	22
8 PHOTOGRAPH OF TEST	23
8.1 Radiated Emission	23
8.2 Conducted Emission	24

## 1. TEST SUMMARY

### 1.1 TEST PROCEDURES AND RESULTS

DESCRIPTION OF TEST	RESULT
CONDUCTED EMISSIONS TEST	COMPLIANT
RADIATED EMISSION TEST	COMPLIANT
BAND EDGE	COMPLIANT
OCCUPIED BANDWIDTH MEASUREMENT	COMPLIANT
ANTENNA REQUIREMENT	COMPLIANT

### 1.2 TEST FACILITY

Test Firm : Dongguan Dongdian Testing Service Co., Ltd  
Certificated by FCC, Registration No.: 270092

Address : No.17 Zongbu road 2, Songshan Lake Sci&Tech Park, DongGuan  
City, Guangdong province,523808 China

### 1.3 MEASUREMENT UNCERTAINTY

Measurement Uncertainty

Conducted Emission Expanded Uncertainty	= 2.23dB, k=2
Radiated emission expanded uncertainty(9kHz-30MHz)	= 3.08dB, k=2
Radiated emission expanded uncertainty(30MHz-1000MHz)	= 4.42dB, k=2
Radiated emission expanded uncertainty(Above 1GHz)	= 4.06dB, k=2

## 2. GENERAL INFORMATION

### 2.1 GENERAL DESCRIPTION OF EUT

Equipment	Motor of electric self-balan cing scooers PA Speaker
Model Name	HS-PA210504
Serial No	A17-T1002BUF, A17-T10112BUF, A17-T10122BUF, A17-P1022BNF, A17-P10212BNF, A17-P10222BNF, A17-P10312BUF, A17-P10322BUF, A17-P12312BUF, A17-P12322BUF, HS-PA110501, HS-PA110502, HS-PA112501 , HS-PA112502, P17-P1032BNF, P17-P1022BNF, P17-P1232BNF, HS-PA210501, HS-PA210502, HS-PA210503, HS-PA210504, HS-PA210505, HS-PA212501, HS-PA212503, PBX-410101
Model Difference	All model's the function, software and electric circuit are the same, only with a product color and model named different. Test sample model: HS-PA210504.
FCC ID	<b>2AHY7PA210504</b>
Antenna Type	PCB Antenna
Antenna Gain	1 dBi
BT Operation frequency	2402-2480MHz
Number of Channels	79CH
Modulation Type	GFSK
Power Source	AC 120V/60Hz
Power Rating	AC 120V/60Hz

## 2.1.1 Carrier Frequency of Channels

Channel List					
Channel	Frequency (MHz)	Channel	Frequency (MHz)	Channel	Frequency (MHz)
00	2402	27	2429	54	2456
01	2403	28	2430	55	2457
02	2404	29	2431	56	2458
03	2405	30	2432	57	2459
04	2406	31	2433	58	2460
05	2407	32	2434	59	2461
06	2408	33	2435	60	2462
07	2409	34	2436	61	2463
08	2410	35	2437	62	2464
09	2411	36	2438	63	2465
10	2412	37	2439	64	2466
11	2413	38	2440	65	2467
12	2414	39	2441	66	2468
13	2415	40	2442	67	2469
14	2416	41	2443	68	2470
15	2417	42	2444	69	2471
16	2418	43	2445	70	2472
17	2419	44	2446	71	2473
18	2420	45	2447	72	2474
19	2421	46	2448	73	2475
20	2422	47	2449	74	2476
21	2423	48	2450	75	2477
22	2424	49	2451	76	2478
23	2425	50	2452	77	2479
24	2426	51	2453	78	2480
25	2427	52	2454		
26	2428	53	2455		

## 2.2 Operation of EUT during testing

Operating Mode

The mode is used: **Transmitting mode**

Low Channel: 2402MHz

Middle Channel: 2441MHz

High Channel: 2480MHz

## 2.3 DESCRIPTION OF TEST SETUP

Operation of EUT during conducted and below 1GHz Radiation testing:

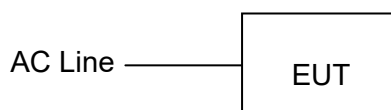

Operation of EUT during Above1GHz Radiation testing:

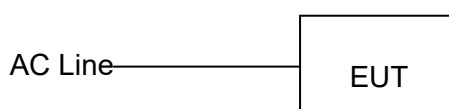

## 2.4 MEASUREMENT INSTRUMENTS LIST

Item	Equipment	Manufacturer	Model No.	Serial No.	Last Cal.	Cal. Interval
1.	EMI Receiver	Rohde & Schwarz	ESCI	100627	Feb. 19, 2016	1 Year
2.	LISN	SchwarzBeck	NSLK 8126	8126377	Feb. 19, 2016	1 Year
3.	RF Switching Unit	Compliance Direction	RSU-M2	38303	Feb. 19, 2016	1 Year
4.	EMI Test Software ES-K1	Rohde & Schwarz	N/A	N/A	N/A	N/A
5.	EMI Test Receiver	Rohde & Schwarz	ESCI	100627	Feb. 19, 2016	1 Year
6.	Trilog Broadband Antenna	Schwarzbeck	VULB9163	VULB 9163-289	Feb. 19, 2016	1 Year
7.	Pre-amplifier	Compliance Direction	PAP-0203	22008	Feb. 19, 2016	1 Year
8.	EMI Test Software EZ-EMC	SHURPLE	N/A	N/A	N/A	N/A
9.	EMI Receiver	Rohde & Schwarz	ESCI	100627	Feb. 19, 2016	1 Year
10.	LISN	SchwarzBeck	NSLK 8126	8126377	Feb. 19, 2016	1 Year
11.	RF Switching Unit	Compliance Direction	RSU-M2	38303	Feb. 19, 2016	1 Year
12.	EMI Test Software ES-K1	Rohde & Schwarz	N/A	N/A	N/A	N/A
13.	EMI Receiver	Rohde & Schwarz	ESCI	100627	Feb. 19, 2016	1 Year
14.	EMI Receiver	Rohde & Schwarz	ESCI	100627	Feb. 19, 2016	1 Year
15.	LISN	SchwarzBeck	NSLK 8126	8126377	Feb. 19, 2016	1 Year
16.	RF Switching Unit	Compliance Direction	RSU-M2	38303	Feb. 19, 2016	1 Year
17.	EMI Test Software ES-K1	Rohde & Schwarz	N/A	N/A	N/A	N/A
18.	Power Meter	R&S	NRVD	SEL0069	Feb. 19, 2016	1 Year
19.	Power Sensor	R&S	URV5-Z2	SEL0071	Feb. 19, 2016	1 Year
20.	Power Sensor	R&S	URV5-Z2	SEL0072	Feb. 19, 2016	1 Year
21.	Software EMC32	R&S	EMC32-S	SEL0082	N/A	N/A
22.	Log-periodic Antenna	Amplifier Reasearch	AHS-PA2105 0480	SEL0073	N/A	N/A
23.	Antenna Tripod	Amplifier Reasearch	TP1000A	SEL0074	N/A	N/A
24.	High Gain Horn Antenna(0.8-5GHz)	Amplifier Reasearch	AT4002A	SEL0075	N/A	N/A
25.	Spectrum analyzer	Agilent	N9020A	MY499110 048	Feb. 19, 2016	1 Year
26.	Spectrum analyzer	Agilent	E4407B	MY461843 26	Feb. 19, 2016	1 Year

### 3. CONDUCTED EMISSIONS TEST

#### 3.1 Conducted Power Line Emission Limit

For unintentional device, according to § 15.107(a) Line Conducted Emission Limits is as following

Frequency (MHz)	Maximum RF Line Voltage (dB $\mu$ V)			
	CLASS A		CLASS B	
	Q.P.	Ave.	Q.P.	Ave.
0.15 - 0.50	79	66	66-56*	56-46*
0.50 - 5.00	73	60	56	46
5.00 - 30.0	73	60	60	50

\* Decreasing linearly with the logarithm of the frequency

For intentional device, according to §15.207(a) Line Conducted Emission Limit is same as above table.

#### 3.2 Test Setup

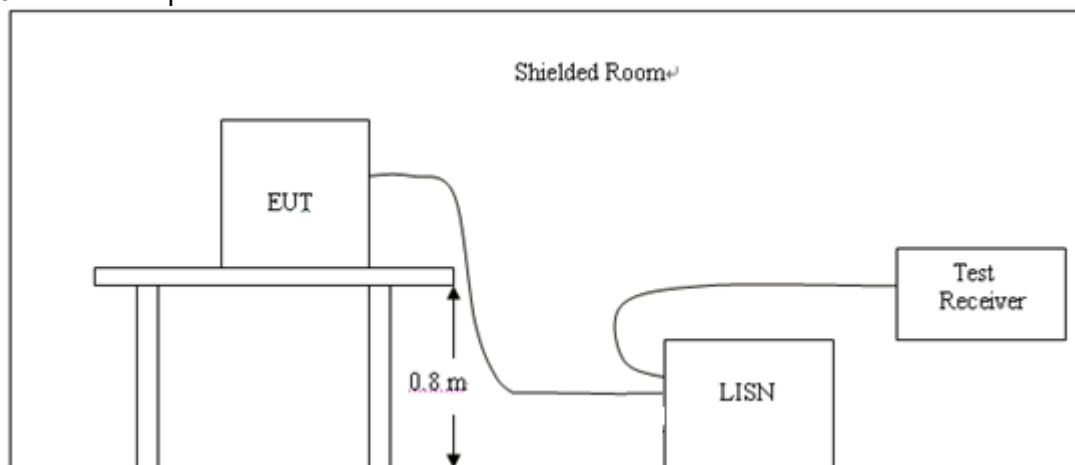

#### 3.3 Test Procedure

- 1, The equipment was set up as per the test configuration to simulate typical actual usage per the user's manual. The EUT is a tabletop system, a wooden table with a height of 0.1 meters is used and is placed on the ground plane as per ANSI C63.10.
- 2, Support equipment, if needed, was placed as per ANSI C63.10.
- 3, All I/O cables were positioned to simulate typical actual usage as per ANSI C63.10.
- 4, If a EUT received DC power from the USB Port of Notebook PC, the PC's adapter received AC120V/60Hz power through a Line Impedance Stabilization Network (LISN) which supplied power source and was grounded to the ground plane.
- 5, All support equipments received AC power from a second LISN, if any.
- 6, The EUT test program was started. Emissions were measured on each current carrying line of the EUT using a spectrum Analyzer / Receiver connected to the LISN powering the EUT. The LISN has two monitoring points: Line 1 (Hot Side) and Line 2 (Neutral Side). Two scans were taken: one with Line 1 connected to Analyzer / Receiver and Line 2 connected to a 50 ohm load; the second scan had Line 1 connected to a 50 ohm load and Line 2 connected to the Analyzer / Receiver.
- 7, Analyzer / Receiver scanned from 150 KHz to 30MHz for emissions in each of the test modes.

#### 3.4 Test Result

PASS

All the test modes completed for test. The worst case of Conducted Emission is CH 2402; the test data of this mode was reported.



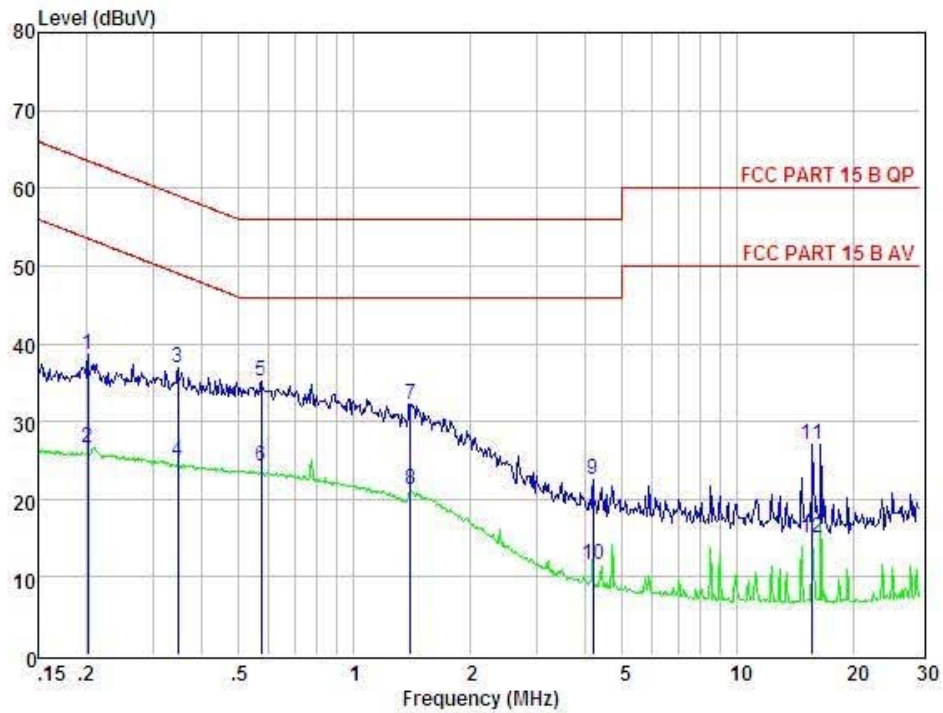

Condition : FCC PART 15 B QP      POL: LINE      Temp:24 °C      Hum:56 %

Item	Freq MHz	Read dBuV	LISN Factor dB	Preamp Factor dB	Cable Loss dB	Level dBuV	Limit dBuV	Margin dBuV	Remark
1	0.202	28.70	0.03	-9.72	0.10	38.55	63.54	-24.99	QP
2	0.202	16.70	0.03	-9.72	0.10	26.55	53.54	-26.99	Average
3	0.346	27.01	0.03	-9.72	0.10	36.86	59.05	-22.19	QP
4	0.346	15.01	0.03	-9.72	0.10	24.86	49.05	-24.19	Average
5	0.573	25.32	0.03	-9.72	0.10	35.17	56.00	-20.83	QP
6	0.573	14.32	0.03	-9.72	0.10	24.17	46.00	-21.83	Average
7	1.403	22.32	0.05	-9.71	0.10	32.18	56.00	-23.82	QP
8	1.403	11.32	0.05	-9.71	0.10	21.18	46.00	-24.82	Average
9	4.202	12.73	0.08	-9.69	0.12	22.62	56.00	-33.38	QP
10	4.202	1.73	0.08	-9.69	0.12	11.62	46.00	-34.38	Average
11	15.718	17.13	0.25	-9.40	0.26	27.04	60.00	-32.96	QP
12	15.718	5.13	0.25	-9.40	0.26	15.04	50.00	-34.96	Average

Remarks: Level = Read + LISN Factor - Preamp Factor + Cable loss

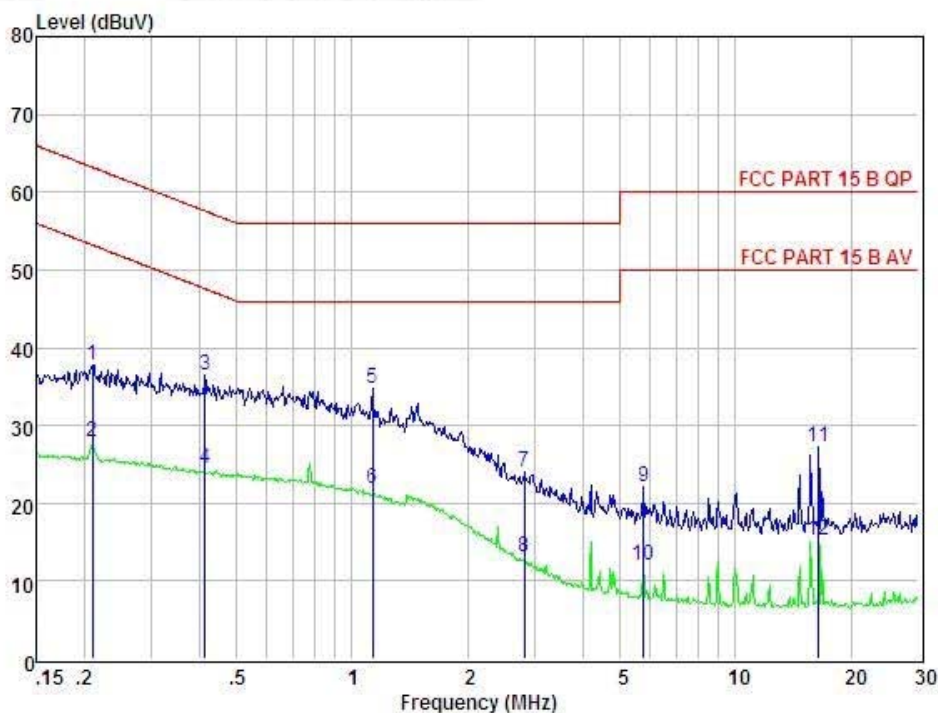

Condition : FCC PART 15 B QP      POL: NEUTRAL      Temp:24 °C      Hum:56 %

Item	Freq MHz	Read dBuV	LISN Factor dB	Preamp Factor dB	Cable Loss dB	Level dBuV	Limit dBuV	Margin dBuV	Remark
1	0.211	28.00	0.03	-9.72	0.10	37.85	63.18	-25.33	QP
2	0.211	18.00	0.03	-9.72	0.10	27.85	53.18	-25.33	Average
3	0.413	26.68	0.03	-9.72	0.10	36.53	57.59	-21.06	QP
4	0.413	14.68	0.03	-9.72	0.10	24.53	47.59	-23.06	Average
5	1.129	24.97	0.04	-9.71	0.10	34.82	56.00	-21.18	QP
6	1.129	11.97	0.04	-9.71	0.10	21.82	46.00	-24.18	Average
7	2.809	14.13	0.07	-9.70	0.12	24.02	56.00	-31.98	QP
8	2.809	3.13	0.07	-9.70	0.12	13.02	46.00	-32.98	Average
9	5.774	12.22	0.11	-9.63	0.14	22.10	60.00	-37.90	QP
10	5.774	2.22	0.11	-9.63	0.14	12.10	50.00	-37.90	Average
11	16.486	17.22	0.26	-9.41	0.28	27.17	60.00	-32.83	QP
12	16.486	5.22	0.26	-9.41	0.28	15.17	50.00	-34.83	Average

Remarks: Level = Read + LISN Factor - Preamp Factor + Cable loss

## 4 RADIATED EMISSION TEST

### 4.1 Radiation Limit

For unintentional device, according to § 15.109(a), except for Class A digital devices, the field strength of radiated emissions from unintentional radiators at a distance of 3 meters shall not exceed the following values:

Frequency (MHz)	Distance (Meters)	Radiated (dB $\mu$ V/m)	Radiated ( $\mu$ V/m)
30-88	3	40	100
88-216	3	43.5	150
216-960	3	46	200
Above 960	3	54	500

For intentional device, according to § 15.209(a), the general requirement of field strength of radiated emissions from intentional radiators at a distance of 3 meters shall not exceed the above table.

### 4.2 Test Setup

#### (1) Radiated Emission Test-Up Frequency Below 30MHz

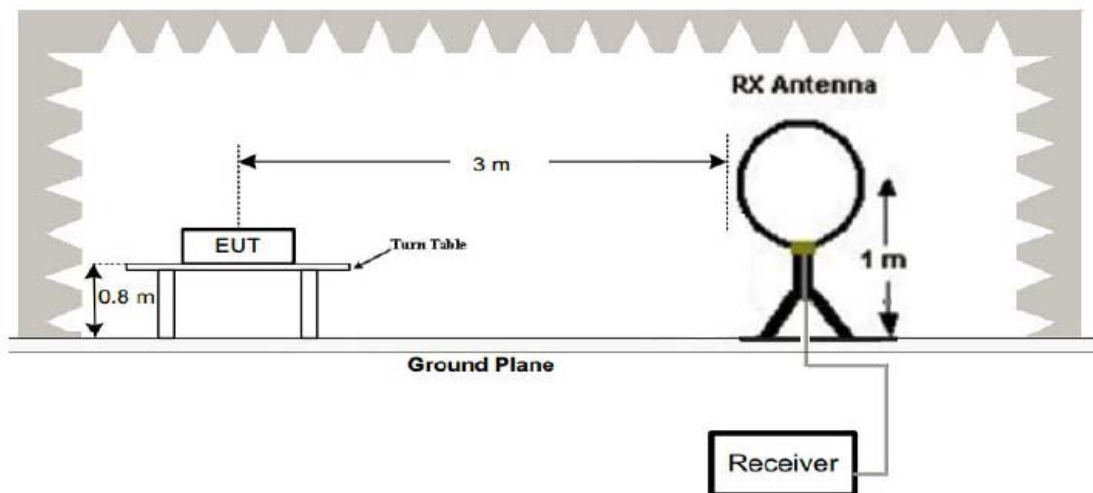

#### (2) Radiated Emission Test-Up Frequency 30MHz~1GHz

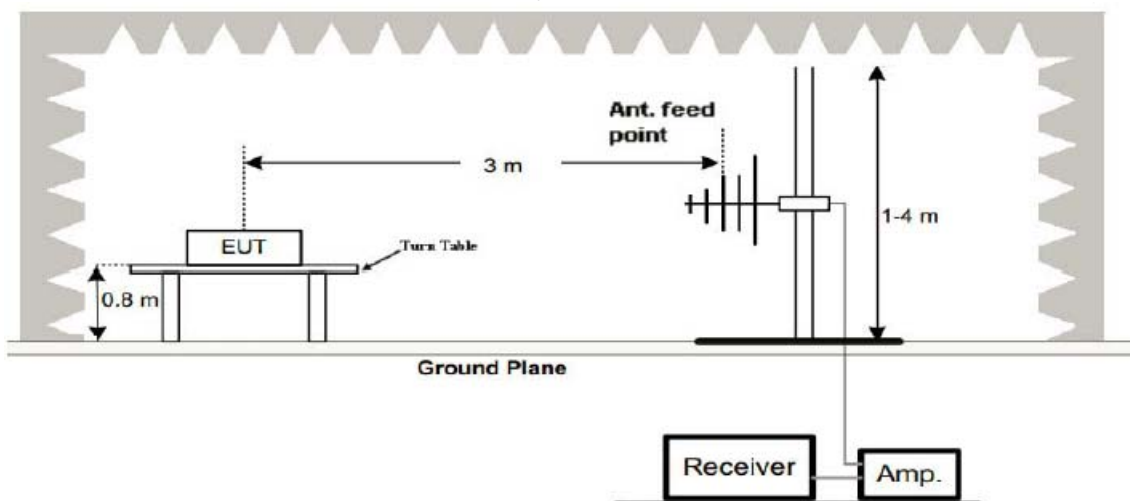

## (3) Radiated Emission Test-Up Frequency Above 1GHz

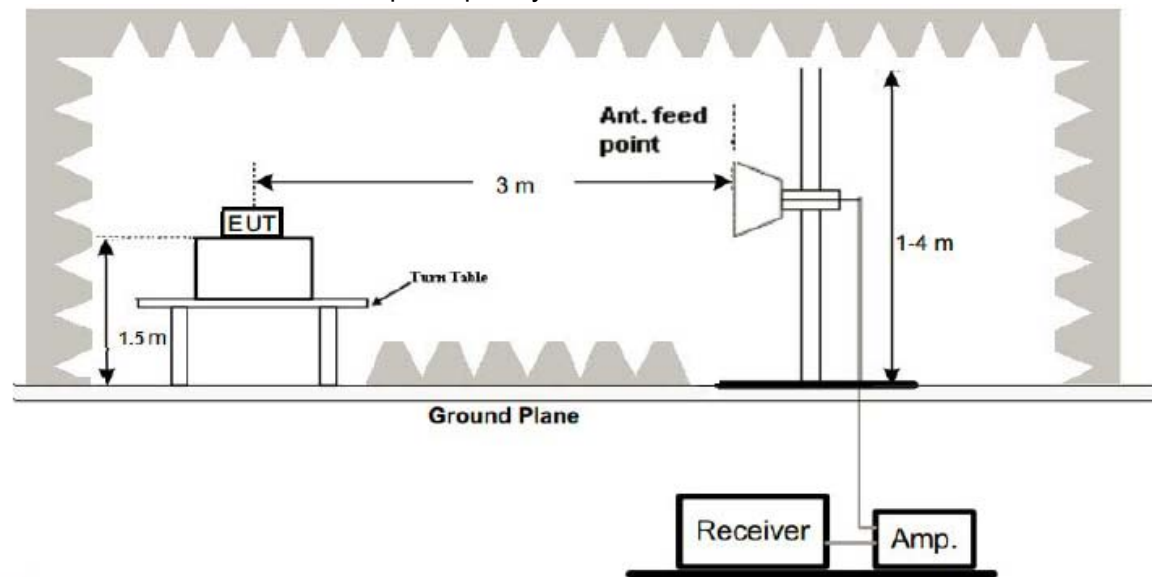

## 4.3 Test Procedure

1. Below 1GHz measurement the EUT is placed on turntable which is 0.1m above ground plane. And above 1GHz measurement EUT was placed on low permittivity and low tangent turn table which is 1.5m above ground plane.
2. The turntable shall be rotated for 360 degrees to determine the position of maximum emission level.
3. EUT is set 3m away from the receiving antenna, which is varied from 1m to 4m to find out the highest emissions.
4. Maximum procedure was performed on the six highest emissions to ensure EUT compliance.
5. And also, each emission was to be maximized by changing the polarization of receiving antenna both horizontal and vertical.
6. Repeat above procedures until the measurements for all frequencies are complete.
7. The test frequency range from 9KHz to 25GHz per FCC PART 15.33(a).

## Note:

For battery operated equipment, the equipment tests shall be performed using a new battery.

## 4.4 Test Result

## PASS

All the test modes completed for test. The worst case of Radiated Emission is CH 2402; the test data of this mode was reported.

Below 1GHz Test Results:  
Antenna polarity: H

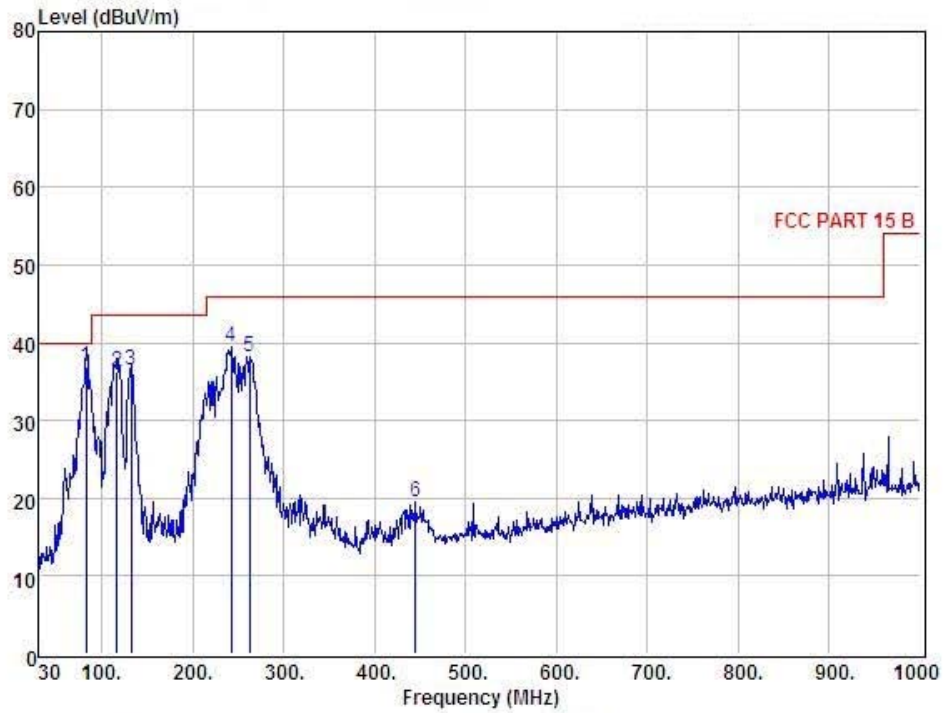

Condition : FCC PART 15 B 3m POL: HORIZONTAL										
Item	Freq	Read	Antenna	Preamp	Cable	Level	Limit	Margin	Remark	
	MHz	dBuV	dB	dB	dB	dBuV	dBuV	dBuV		
1	82.38	54.19	9.35	26.80	0.20	36.94	40.00	-3.06	QP	
2	116.33	50.82	11.87	26.87	0.37	36.19	43.50	-7.31	QP	
3	131.85	49.96	12.79	26.89	0.57	36.43	43.50	-7.07	QP	
4	242.43	54.70	11.47	27.09	0.49	39.57	46.00	-6.43	QP	
5	262.80	52.64	11.90	27.13	0.73	38.14	46.00	-7.86	QP	
6	445.16	30.37	15.87	27.48	0.76	19.52	46.00	-26.48	QP	

Remark: Level = Read Level + Antenna Factor - Preamp Factor + Cable Loss

Antenna polarity: V

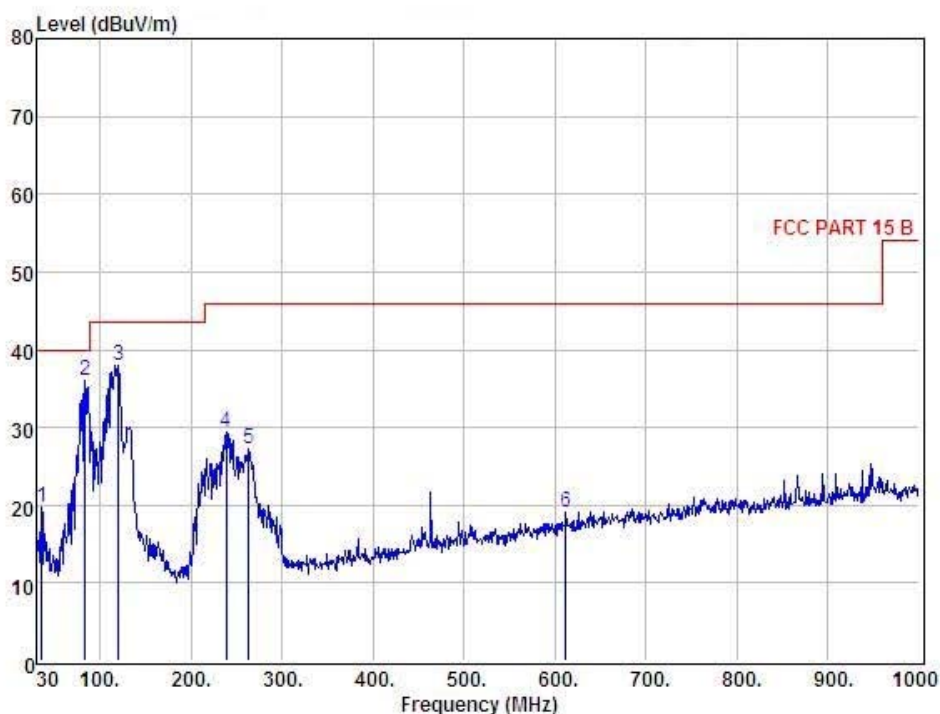

Condition : FCC PART 15 B 3m POL: VERTICAL										
Item	Freq	Read	Antenna	Preamp	Cable	Level	Limit	Margin	Remark	
	MHz	dBuV	Factor	Factor	Loss	dBuV	dBuV	dBuV		
			dB	dB	dB					
1	35.82	33.97	13.39	27.66	0.11	19.81	40.00	-20.19	QP	
2	83.35	53.16	9.35	26.80	0.23	35.94	40.00	-4.06	QP	
3	120.21	52.28	12.24	26.88	0.36	38.00	43.50	-5.50	QP	
4	238.55	44.44	11.40	27.09	0.54	29.29	46.00	-16.71	QP	
5	263.77	41.86	11.90	27.13	0.65	27.28	46.00	-18.72	QP	
6	612.00	27.10	18.54	27.81	1.35	19.18	46.00	-26.82	QP	

Remark: Level = Read Level + Antenna Factor - Preamp Factor + Cable Loss

Remark:

- (1) Measuring frequencies from 9 KHz to the 1 GHz, Radiated emission test from 9KHz to 30MHz was verified, and no any emission was found except system noise floor.
- (2) \* denotes emission frequency which appearing within the Restricted Bands specified in provision of 15.205, then the general radiated emission limits in 15.209 apply.
- (3) The IF bandwidth of EMI Test Receiver between 30MHz to 1GHz was 120KHz, 1 MHz for measuring above 1 GHz, below 30MHz was 10KHz.

Above 1 GHz Test Results:

CH Low (2402MHz)

Horizontal:

Frequency	Meter Reading	Factor	Emission Level	Limits	Margin	Detector Type
(MHz)	(dBµV)	(dB)	(dBµV/m)	(dBµV/m)	(dB)	
2402	114.68	-5.84	108.84	114	-5.16	peak
2402	89.68	-5.84	83.84	94	-10.16	AVG
4804	59.29	-3.64	55.65	74	-18.35	peak
4804	43.92	-3.64	40.28	54	-13.72	AVG
7206	55.54	-0.95	54.59	74	-19.41	peak
7206	40.20	-0.95	39.25	54	-14.75	AVG
---	---	---	---	---	---	---
---	---	---	---	---	---	---

Remark: Factor = Antenna Factor + Cable Loss – Pre-amplifier.

Vertical:

Frequency	Meter Reading	Factor	Emission Level	Limits	Margin	Detector Type
(MHz)	(dBµV)	(dB)	(dBµV/m)	(dBµV/m)	(dB)	
2402	112.36	-5.84	106.52	114	-7.48	peak
2402	86.27	-5.84	80.43	94	-13.57	AVG
4804	58.20	-3.64	54.56	74	-19.44	peak
4804	43.78	-3.64	40.14	54	-13.86	AVG
7206	54.90	-0.95	53.95	74	-20.05	peak
7206	40.24	-0.95	39.29	54	-14.71	AVG
---	---	---	---	---	---	---
---	---	---	---	---	---	---

Remark: Factor = Antenna Factor + Cable Loss – Pre-amplifier.

CH Middle (2441MHz)  
Horizontal:

Frequency	Meter Reading	Factor	Emission Level	Limits	Margin	Detector Type
(MHz)	(dBµV)	(dB)	(dBµV/m)	(dBµV/m)	(dB)	
2441	111.13	-5.71	105.42	114	-8.58	peak
2441	85.44	-5.71	79.73	94	-14.27	AVG
4882	60.16	-3.51	56.65	74	-17.35	peak
4882	44.67	-3.51	41.16	54	-12.84	AVG
7323	55.19	-0.82	54.37	74	-19.63	peak
7323	41.28	-0.82	40.46	54	-13.54	AVG
---	---	---	---	---	---	---
---	---	---	---	---	---	---

Remark: Factor = Antenna Factor + Cable Loss – Pre-amplifier.

Vertical:

Frequency	Meter Reading	Factor	Emission Level	Limits	Margin	Detector Type
(MHz)	(dBµV)	(dB)	(dBµV/m)	(dBµV/m)	(dB)	
2441	109.09	-5.71	103.38	114	-10.62	peak
2441	82.97	-5.71	77.26	94	-16.74	AVG
4882	58.88	-3.51	55.37	74	-18.63	peak
4882	44.33	-3.51	40.82	54	-13.18	AVG
7323	55.10	-0.82	54.28	74	-19.72	peak
7323	40.47	-0.82	39.65	54	-14.35	AVG
---	---	---	---	---	---	---
---	---	---	---	---	---	---

Remark: Factor = Antenna Factor + Cable Loss – Pre-amplifier.



CH High (2480MHz)  
Horizontal:

Frequency	Meter Reading	Factor	Emission Level	Limits	Margin	Detector Type
(MHz)	(dB $\mu$ V)	(dB)	(dB $\mu$ V/m)	(dB $\mu$ V/m)	(dB)	
2480	108.67	-5.65	103.02	114	-10.98	peak
2480	82.61	-5.65	76.96	94	-17.04	AVG
4960	59.00	-3.43	55.57	74	-18.43	peak
4960	44.17	-3.43	40.74	54	-13.26	AVG
7440	54.18	-0.75	53.43	74	-20.57	peak
7440	39.46	-0.75	38.71	54	-15.29	AVG
---	---	---	---	---	---	---
---	---	---	---	---	---	---

Remark: Factor = Antenna Factor + Cable Loss – Pre-amplifier.

Vertical:

Frequency	Meter Reading	Factor	Emission Level	Limits	Margin	Detector Type
(MHz)	(dB $\mu$ V)	(dB)	(dB $\mu$ V/m)	(dB $\mu$ V/m)	(dB)	
2480	107.88	-5.65	102.23	114	-11.77	peak
2480	81.32	-5.65	75.67	94	-18.33	AVG
4960	58.72	-3.43	55.29	74	-18.71	peak
4960	44.01	-3.43	40.58	54	-13.42	AVG
7440	53.20	-0.75	52.45	74	-21.55	peak
7440	39.02	-0.75	38.27	54	-15.73	AVG
---	---	---	---	---	---	---
---	---	---	---	---	---	---

Remark: Factor = Antenna Factor + Cable Loss – Pre-amplifier.

Remark:

- (1) Measuring frequencies from 1 GHz to the 25 GHz.
- (2) "F" denotes fundamental frequency; "H" denotes spurious frequency. "E" denotes band edge frequency.
- (3) \* denotes emission frequency which appearing within the Restricted Bands specified in provision of 15.205, then the general radiated emission limits in 15.209 apply.
- (4) Data of measurement within this frequency range shown "---" in the table above means the reading of emissions are attenuated more than 20dB below the permissible limits or the field strength is too small to be measured.
- (5) The IF bandwidth of EMI Test Receiver between 30MHz to 1GHz was 120KHz, 1 MHz for measuring above 1 GHz, below 30MHz was 10KHz.
- (6) When the test results of Peak Detected below the limits of Average Detected, the Average Detected is not need completed. For example: Top Channel at Fundamental 73.16dBuV/m(PK Value) <93.98(AV Limit), at harmonic 53.20 dBuV/m(PK Value) <54 dBuV/m(AV Limit), the Average Detected not need to completed.

## 5 BAND EDGE

### 5.1 Limits

FCC PART 15.249(d) Emissions radiated outside of the specified frequency bands, except for harmonics, shall be attenuated by at least 50 dB below the level of the fundamental or to the general radiated emission limits in §15.209, whichever is the lesser attenuation.

### 5.2 Test Procedure

The band edge compliance of RF radiated emission should be measured by following the guidance in ANSI C63.10 with respect to maximizing the emission by rotating the EUT, measuring the emission while the EUT is situated in three orthogonal planes (if appropriate), adjusting the measurement antenna height and polarization etc. Set RBW to 100KHz and VBM to 300KHz to measure the peak field strength and set RBW to 1MHz and VBW to 10Hz to measure the average radiated field strength. The conducted RF band edge was measured by using a spectrum analyzer. Set span wide enough to capture the highest in-band emission and the emission at the band edge. Set RBW to 100 KHz and VBW to 300 KHz, to measure the conducted peak band edge.

### 5.3 Test Result

**PASS**

Radiated Band Edge Test:  
 Operation Mode: TX CH Low (2402MHz)  
 Horizontal

Frequency (MHz)	Meter Reading (dBµV)	Factor (dB)	Emission Level (dBµV/m)	Limits (dBµV/m)	Margin (dB)	Detector Type
2390	51.66	-5.81	45.85	74	-28.15	peak
2390	/	-5.81	/	54	/	AVG
2400	55.26	-5.84	49.42	74	-24.58	peak
2400	/	-5.84	/	54	/	AVG

Remark: Factor = Antenna Factor + Cable Loss – Pre-amplifier.

Vertical:

Frequency (MHz)	Meter Reading (dBµV)	Factor (dB)	Emission Level (dBµV/m)	Limits (dBµV/m)	Margin (dB)	Detector Type
2390	51.09	-5.81	45.28	74	-28.72	peak
2390	/	-5.81	/	54	/	AVG
2400	54.53	-5.84	48.69	74	-25.31	peak
2400	/	-5.84	/	54	/	AVG

Remark: Factor = Antenna Factor + Cable Loss – Pre-amplifier.

Operation Mode: TX CH High (2480MHz)  
Horizontal

Frequency	Meter Reading	Factor	Emission Level	Limits	Margin	Detector Type
(MHz)	(dB $\mu$ V)	(dB)	(dB $\mu$ V/m)	(dB $\mu$ V/m)	(dB)	
2483.5	51.71	-5.65	46.06	74	-27.94	peak
2483.5	/	-5.65	/	54	/	AVG

Remark: Factor = Antenna Factor + Cable Loss – Pre-amplifier.

Vertical:

Frequency	Meter Reading	Factor	Emission Level	Limits	Margin	Detector Type
(MHz)	(dB $\mu$ V)	(dB)	(dB $\mu$ V/m)	(dB $\mu$ V/m)	(dB)	
2483.5	51.07	-5.65	45.42	74	-28.58	peak
2483.5	/	-5.65	/	54	/	AVG

Remark: Factor = Antenna Factor + Cable Loss – Pre-amplifier.

Remark: All the other emissions not reported were too low to read and deemed to comply with FCC limit.

## 6 OCCUPIED BANDWIDTH MEASUREMENT

### 6.1 Test Setup

Same as Radiated Emission Measurement

### 6.2 Test Procedure

1. The EUT was placed on a turn table which is 0.8m above ground plane.
2. Set EUT as normal operation.
3. Based on FCC Part15 C Section 15.249(a): RBW= 30KHz. VBW= 100 KHz, Span=3MHz.
4. The useful radiated emission from the EUT was detected by the spectrum analyser with peak detector.

### 6.3 Measurement Equipment Used

Same as Radiated Emission Measurement

### 6.4 Test Result

**PASS**

Frequency	20dB Bandwidth (KHz)	Result
2402 MHz	834.8	<b>PASS</b>
2441 MHz	835.2	<b>PASS</b>
2480 MHz	831.5	<b>PASS</b>

CH: 2402MHz

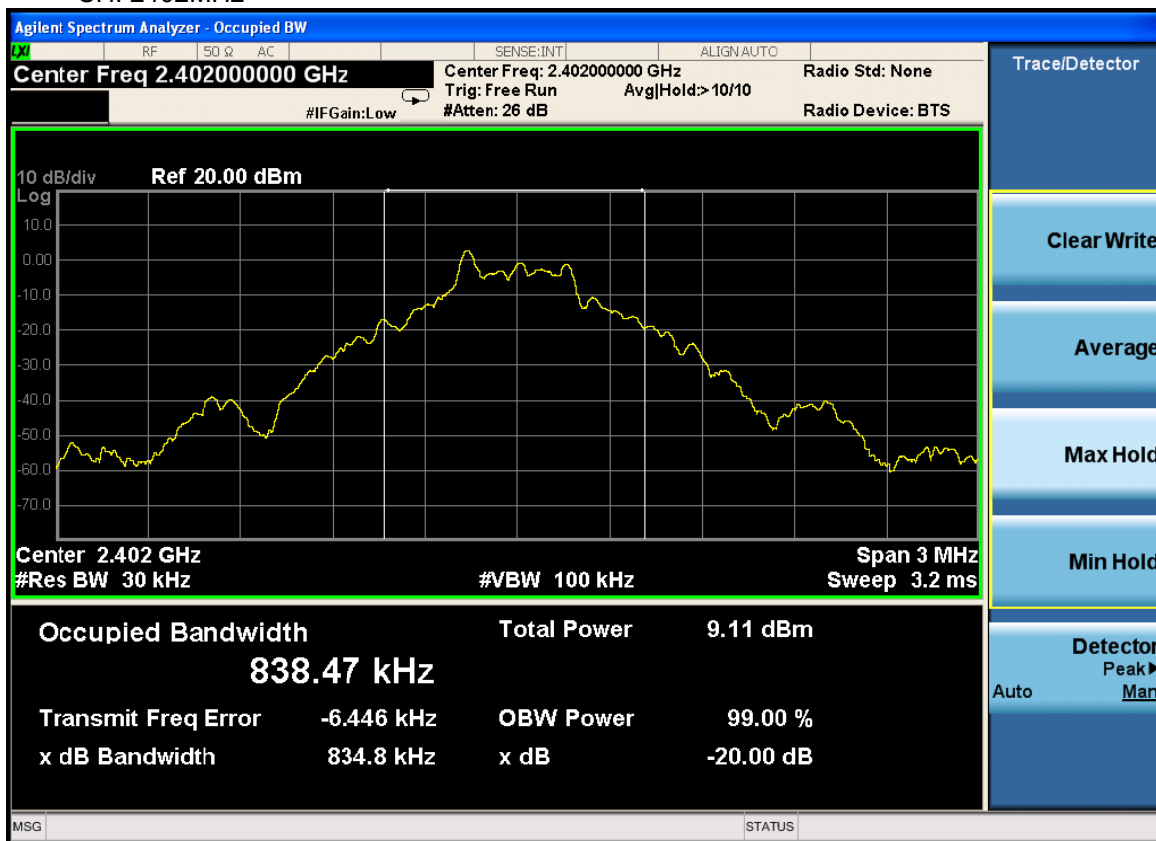

CH: 2441MHz

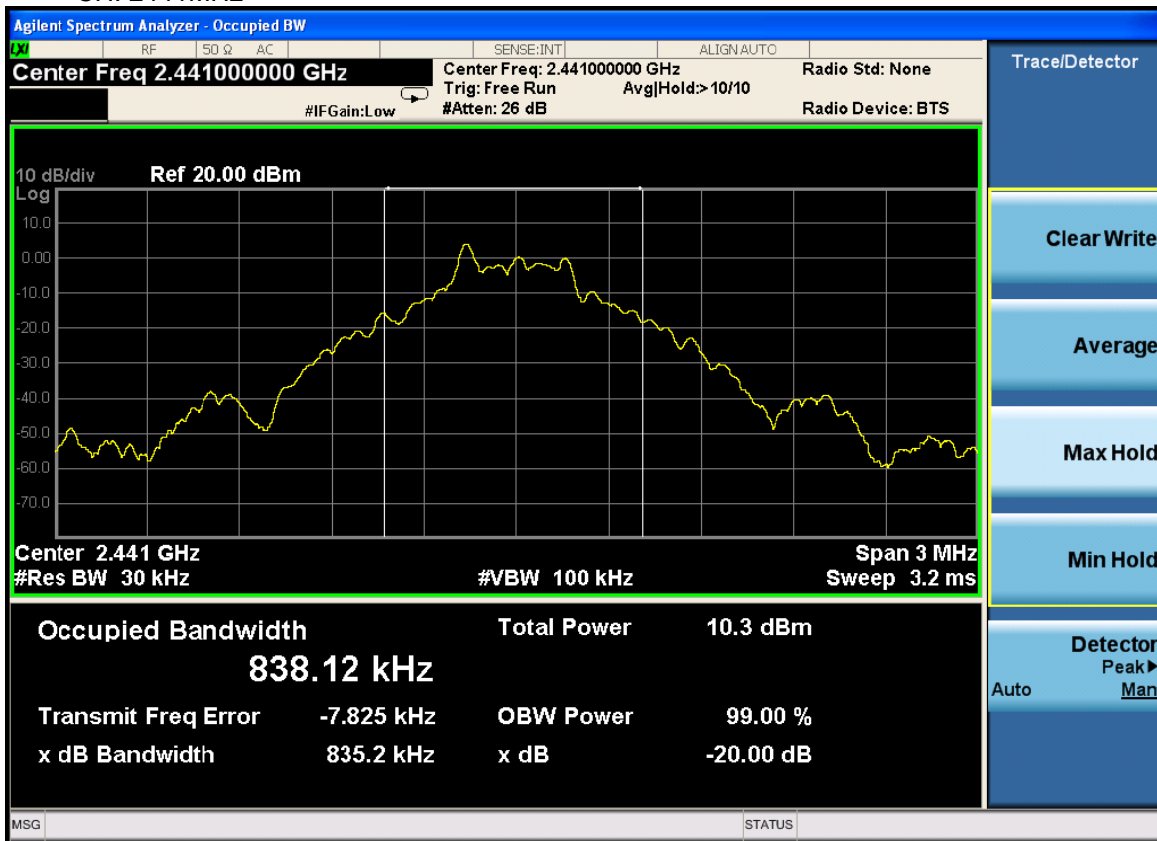

CH: 2480MHz

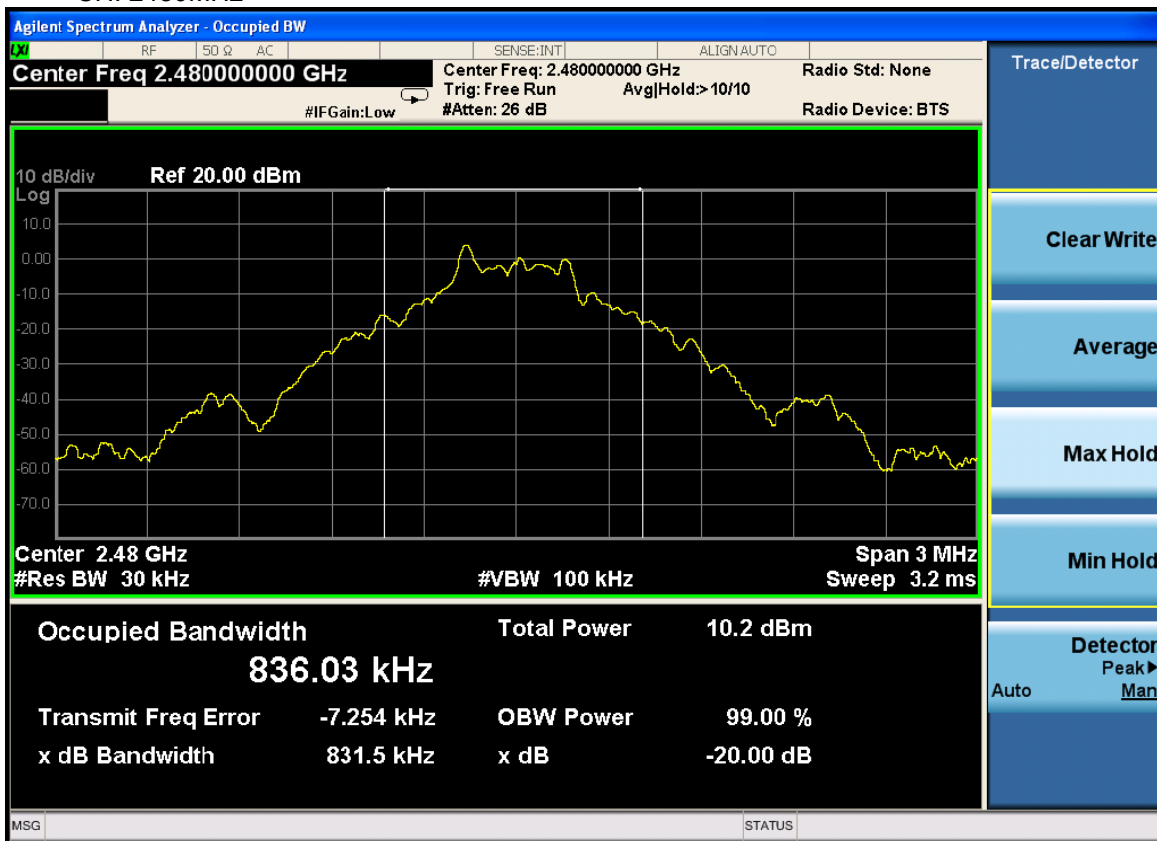

## 7 ANTENNA REQUIREMENT

### Standard Applicable

For intentional device, according to FCC 47 CFR Section 15.203, an intentional radiator shall be designed to ensure that no antenna other than that furnished by the responsible party shall be used with the device. And according to FCC 47 CFR Section 15.249, if transmitting antennas of directional gain greater than 6dBi are used, the power shall be reduced by the amount in dB that the directional gain of the antenna exceeds 6dBi.

### Refer to statement below for compliance.

The manufacturer may design the unit so that the user can replace a broken antenna, but the use of a standard antenna jack or electrical connector is prohibited. Further, this requirement does not apply to intentional radiators that must be professionally installed.

### Antenna Connected Construction

The antenna used in this product is a PCB Antenna, The directional gains of antenna used for transmitting is 1dBi.

### ANTENNA

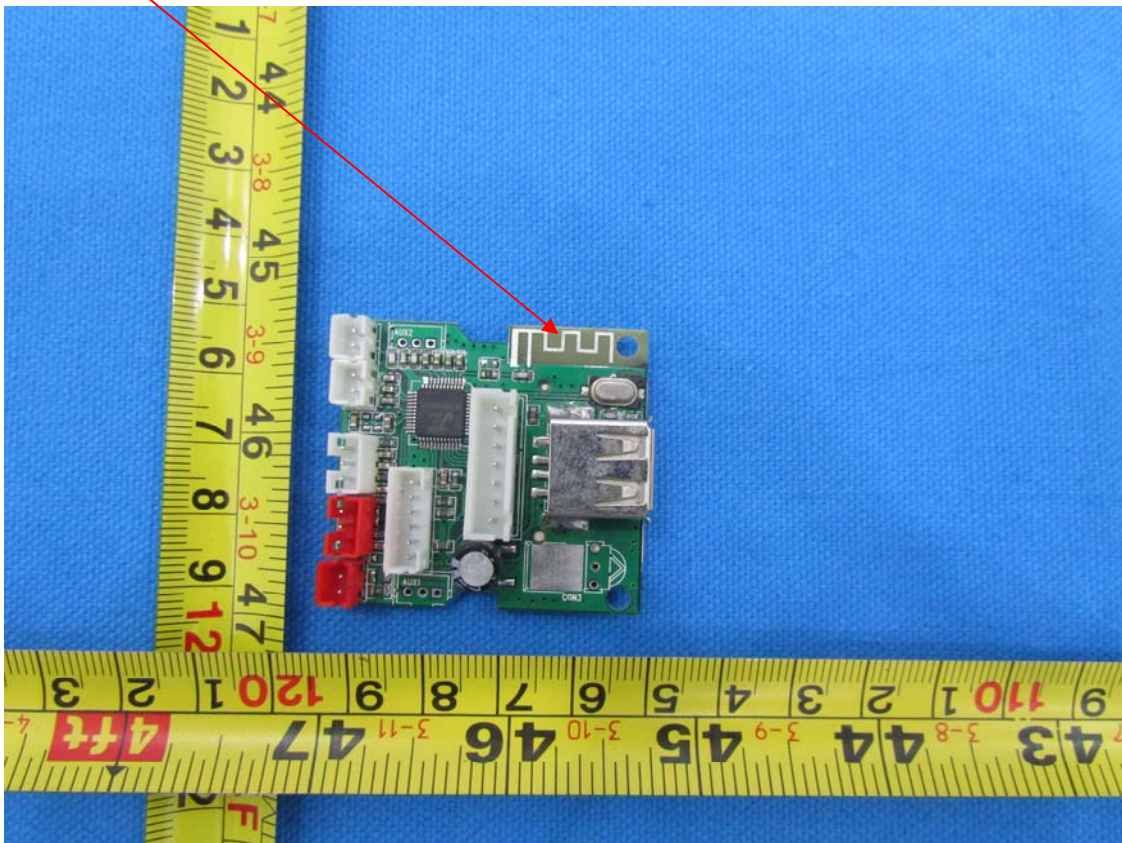

## 8 PHOTOGRAPH OF TEST

### 8.1 Radiated Emission



## 8.2 Conducted Emission

