



Shenzhen GTI Technology Co., Ltd.

1F,2 Block, Jiaquan Building, Guanlan High-tech Park Baoan District,
Shenzhen, Guangdong, China.

Tel: +86-755-27559792

Fax: +86-755-86116468

Report No.: GTI20160274F-1

Page 1 of 49

TEST REPORT

Product Name: WLAN 11n USB 1T1R Module

Trademark: /

Model/Type reference: A28188E

FCC ID.....: 2AHXS-A28188E

Test Standards: **FCC Part 15.247: Operation within the bands 902-928 MHz, 2400-2483.5 MHz and 5725-5850 MHz**

Applicant: TATUNG COMPANY OF AMERICA, INC.

Address of applicant: 2850 EI PRESIDIO STREET, LONG BEACH, CA 90810,
USA

Date of Receipt: Mar. 17, 2016

Date of Test Date.....: Mar. 17, 2016 - Apr. 21, 2016

Data of issue.: May 09, 2016

Test result	Pass *
--------------------	---------------

* In the configuration tested, the EUT complied with the standards specified above

GENERAL DESCRIPTION OF EUT	
Equipment:	WLAN 11n USB 1T1R Module
Model Name:	A28188E
Manufacturer:	TATUNG COMPANY OF AMERICA, INC.
Manufacturer Address:	2850 EI PRESIDIO STREET, LONG BEACH, CA 90810, USA
Power Rating:	DC 5.0V form USB Interface

Compiled By: Thomas Morgan
(Thomas Morgan)

Reviewed By: Tony Wang
(Tony Wang)

Approved By: Walter Chen
(Walter Chen)

This test report consists of 49 pages in total. It may be duplicated completely for legal use with the approval of the applicant. It should not be reproduced except in full, without the written approval of our laboratory. The client should not use it to claim product endorsement by GTI. The test results in the report only apply to the tested sample. The test report shall be invalid without all the signatures of compiler, reviewer and approver. Any objections must be raised to GTI within 15 days since the date when the report is received. It will not be taken into consideration beyond this limit.



Table of Contents

Page

1. SUMMARY.....	4
1.1. TEST STANDARDS.....	4
1.2. TEST DESCRIPTION.....	4
1.3. TEST FACILITY	5
1.4. MEASUREMENT UNCERTAINTY	5
2. GENERAL INFORMATION.....	6
2.1. ENVIRONMENTAL CONDITIONS	6
2.2. GENERAL DESCRIPTION OF EUT	6
2.3. DESCRIPTION OF TEST MODES	7
2.1. MEASUREMENT INSTRUMENTS LIST	8
2.2. TEST CONDITIONS AND RESULTS	9
2.3. CONDUCTED EMISSION (AC MAIN)	9
2.4. RADIATED EMISSION	12
2.5. MAXIMUM CONDUCTED OUTPUT POWER.....	20
2.6. POWER SPECTRAL DENSITY	21
2.7. 6dB BANDWIDTH.....	24
2.8. BAND EDGE COMPLIANCE OF RF EMISSION	27
2.9. SPURIOUS RF CONDUCTED EMISSION.....	32
2.10. ANTENNA REQUIREMENT.....	45
3. EUT TEST PHOTO	46
4. PHOTOGRAPHS OF EUT CONSTRUCTIONAL	48

1 SUMMARY

1.1 Test Standards

The tests were performed according to following standards:

[FCC Rules Part 15.247](#): Frequency Hopping, Direct Spread Spectrum and Hybrid Systems that are in operation within the bands of 902-928 MHz, 2400-2483.5 MHz, and 5725-5850 MHz

[ANSI C63.10-2013](#): American National Standard for Testing Unlicensed Wireless Devices

1.2 Test Description

FCC PART 15 15.247		
FCC Part 15.207	AC Power Conducted Emission	PASS
FCC Part 15.247(a)(2)	6dB Bandwidth	PASS
FCC Part 15.247(d)	Spurious RF Conducted Emission	PASS
FCC Part 15.247(b)	Maximum Conducted Output Power	PASS
FCC Part 15.247(e)	Power Spectral Density	PASS
FCC Part 15.109/ 15.205/ 15.209	Radiated Emissions	PASS
FCC Part 15.247(d)	Band Edge	PASS
FCC Part 15.203/15.247 (b)	Antenna Requirement	PASS

Remark: The measurement uncertainty is not included in the test result.

1.3 Test Facility

1.3.1 Address of the test laboratory

Shenzhen General Testing & Inspection Technology Co., Ltd.

Add: 1F, 2 Block, Jiaquan Building, Guanlan High-tech Park Baoan District, Shenzhen, Guangdong, China

1.3.2 Laboratory accreditation

The test facility is recognized, certified, or accredited by the following organizations:

IC Registration No.: 9783A

The 3m alternate test site of Shenzhen GTI Technology Co., Ltd. EMC Laboratory has been registered by Certification and Engineer Bureau of Industry Canada for the performance of with Registration NO.: 9783A on Aug, 2011.

FCC-Registration No.: 214666

Shenzhen GTI Technology Co., Ltd. EMC Laboratory has been registered and fully described in a report filed with the (FCC) Federal Communications Commission. The acceptance letter from the FCC is maintained in our files. Registration 214666, Sep 19, 2011

1.4 Measurement Uncertainty

The data and results referenced in this document are true and accurate. The reader is cautioned that there may be errors within the calibration limits of the equipment and facilities. The measurement uncertainty was calculated for all measurements listed in this test report acc. to CISPR 16 - 4 Specification for radio disturbance and immunity measuring apparatus and methods – Part 4: Uncertainty in EMC Measurements and is documented in the Shenzhen General Testing & Inspection Technology Co., Ltd quality system acc. to DIN EN ISO/IEC 17025. Furthermore, component and process variability of devices similar to that tested may result in additional deviation. The manufacturer has the sole responsibility of continued compliance of the device.

Hereafter the best measurement capability for General Testing & Inspection laboratory is reported:

Test Items	Measurement Uncertainty	Notes
Transmitter power conducted	0.57 dB	(1)
Transmitter power Radiated	2.20 dB	(1)
Conducted spurious emission 9KHz-40 GHz	1.60 dB	(1)
Radiated spurious emission 9KHz-40 GHz	2.20 dB	(1)
Conducted Emission 9KHz-30MHz	3.39 dB	(1)
Radiated Emission 30~1000MHz	4.24 dB	(1)
Radiated Emission 1~18GHz	5.16 dB	(1)
Radiated Emission 18-40GHz	5.54 dB	(1)
Occupied Bandwidth	-----	(1)

(1) This uncertainty represents an expanded uncertainty expressed at approximately the 95% confidence level using a coverage factor of k=1.96.

2 GENERAL INFORMATION

2.1 Environmental conditions

During the measurement the environmental conditions were within the listed ranges:

Temperature:	15~35°C
Relative Humidity:	30~60 %
Air Pressure:	950~1050mba

2.2 General Description of EUT

Product Name:	WLAN 11n USB 1T1R Module
Model/Type reference:	A28188E
Power supply:	DC 5.0V form USB Interface
Hardware Version:	V0
Software Version:	V1.1
WIFI :	
Supported type:	802.11b/802.11g/802.11n(HT20)/802.11n(H40)
Modulation:	802.11b: DSSS 802.11g/802.11n(HT20)/802.11n(HT40): OFDM
Modulation type:	802.11b: BPSK/QPSK/CCK 802.11g/802.11n(HT20)/802.11n(HT40): BPSK/QPSK/16QAM/64QAM
Operation frequency:	802.11b/802.11g/802.11n(HT20): 2412MHz~2462MHz 802.11n(HT40): 2422MHz~2452MHz
Channel number:	802.11b/802.11g/802.11n(HT20): 11 802.11n(HT40): 7
Channel separation:	5MHz
Antenna type:	Monopole Antenna
Antenna gain:	2.0dBi

Note: For a more detailed features description, please refer to the manufacturer's specifications or the User's Manual.

2.3 Description of Test Modes

Peripheral equipment list

Name:	Model:	Serial	Manufacture	Remark
1	Elitebook 2540p	CND05201BS	HP	DOC
2	Mouse	N889	DELL	DOC
3	Keyboard	SK-8185	DELL	DOC

WIFI Operation Frequency

The Applicant provides engineering files to control the EUT for staying in continuous transmitting (Duty Cycle more than 98%) mode for testing.

Note: The engineering sample had fixed the transmit parameter by the fixed files that the manufacture supplied. The fixed parameter: modulation style, channel, power level, bandwidth

For example 802.11b-Low channel is a single file, the 802.11b-middle is a single file, the same as others.

Channel	Frequency(MHz)	Channel	Frequency(MHz)
1	2412	8	2447
2	2417	9	2452
3	2422	10	2457
4	2427	11	2462
5	2432		
6	2437		
7	2442		

Data Rate Used:

Preliminary tests were performed in different data rate to find the worst radiated emission. The data rate shown in the table below is the worst-case rate with respect to the specific test item. Investigation has been done on all the possible configurations for searching the worst cases. The following table is a list of the test modes shown in this test report.

Test Items	Mode	Data Rate	Channel
Maximum Peak Conducted Output Power Power Spectral Density 6dB Bandwidth Spurious RF conducted emission Radiated Emission 9kHz~1GHz& Radiated Emission 1GHz~10th Harmonic	11b/DSSS	1 Mbps	1/6/11
	11g/OFDM	6 Mbps	1/6/11
	11n(20MHz)/OFDM	6.5Mbps	1/6/11
	11n(40MHz)/OFDM	MCS0	3/6/9
Band Edge	11b/DSSS	1 Mbps	1/11
	11g/OFDM	6 Mbps	1/11
	11n(20MHz)/OFDM	6.5Mbps	1/11
	11n(40MHz)/OFDM	MCS0	3/9

2.4 Measurement Instruments List

Maximum Conducted Output Power/Power Spectral Density / 6dB Bandwidth / Band Edge Compliance of RF Emission / Spurious RF Conducted Emission					
Item	Test Equipment	Manufacturer	Model No.	Serial No.	Calibrated until
1	Power Meter	Anritsu	ML2487B	110553	July 10,2016
2	Power Sensor	Anritsu	MA2411B	100345	July 10,2016
3	Spectrum Analyzer	Rohde & Schwarz	FSU	100105	Jan 04,2017
4	RF Cable	Schwarzbeck	AH32D4	SF0150	Jan 04,2017
5	Temporary Antenna connector	Schwarzbeck	SMA24D	ED1201	Jan 04,2017

Note: The temporary antenna connector is soldered on the PCB board in order to perform conducted tests and this temporary antenna connector is listed in the equipment list.

Conducted Emission					
Item	Test Equipment	Manufacturer	Model No.	Serial No.	Calibrate until
1	LISN	R&S	ENV216	101112	Jan. 04, 2017
2	LISN	R&S	ENV216	101113	Jan. 04, 2017
3	EMI Test Receiver	R&S	ESCI	100920	Jan. 04, 2017
4	Cable	Schwarzbeck	AK9515E	33156	Jan. 04, 2017

Radiated Emission					
Item	Test Equipment	Manufacturer	Model No.	Serial No.	Calibrated until
1	EMI Test Receiver	R&S	ESCI	100967	Jan 04,2017
2	High pass filter	micro-tranics	HPM50111	34202	Jan 04,2017
3	Log-Bicon Antenna	Schwarzbeck	CBL6141A	4180	Jan 04,2017
4	Ultra-Broadband Antenna	ShwarzBeck	BBHA9170	25841	Jan 07,2017
5	Loop Antenna	LAPLAC	RF300	9138	Jan 07,2017
6	Spectrum Analyzer	Rohde & Schwarz	FSU	100105	Jan 04,2017
7	Horn Antenna	Schwarzbeck	BBHA 9120D	648	Jan 07,2017
8	Pre-Amplifier	HP	8447D	1937A03050	Jan 04,2017
9	Pre-Amplifier	EMCI	EMC05183 5	980075	Jan 04,2017
10	Antenna Mast	UC	UC3000	N/A	N/A
11	Turn Table	UC	UC3000	N/A	N/A
12	Cable Below 1GHz	Schwarzbeck	AK9515E	33155	Jan 04,2017
13	Cable Above 1GHz	Hubersuhner	SUCOFLEX1 02	DA1580	Jan 04,2017

- Note: 1. The Cal.Interval was one year.
 2. The cable loss has calculated in test result which connection between each test instruments.

3 TEST CONDITIONS AND RESULTS

3.1 Conducted Emission (AC Main)

LIMIT

FCC CFR Title 47 Part 15 Subpart C Section 15.207

Frequency range (MHz)	Limit (dBuV)	
	Quasi-peak	Average
0.15-0.5	66 to 56*	56 to 46*
0.5-5	56	46
5-30	60	50

* Decreases with the logarithm of the frequency.

TEST CONFIGURATION

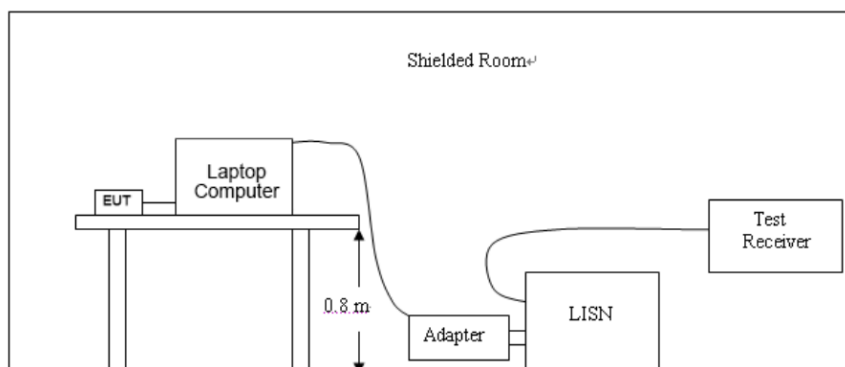

TEST PROCEDURE

1. The equipment was set up as per the test configuration to simulate typical actual usage per the user’s manual. The EUT is a tabletop system; a wooden table with a height of 0.8 meters is used and is placed on the ground plane as per ANSI C63.10-2013.
2. Support equipment, if needed, was placed as per ANSI C63.10-2013
3. All I/O cables were positioned to simulate typical actual usage as per ANSI C63.10-2013
4. The EUT received DC5V power from the USB Port of the laptop PC, the adapter received AC120V/60Hz power through a Line Impedance Stabilization Network (LISN) which supplied power source and was grounded to the ground plane.
5. All support equipments received AC power from a second LISN, if any.
6. The EUT test program was started. Emissions were measured on each current carrying line of the Adapter using a spectrum Analyzer / Receiver connected to the LISN powering the EUT. The LISN has two monitoring points: Line 1 (Hot Side) and Line 2 (Neutral Side). Two scans were taken: one with Line 1 connected to Analyzer / Receiver and Line 2 connected to a 50 ohm load; the second scan had Line 1 connected to a 50 ohm load and Line 2 connected to the Analyzer / Receiver.
7. Analyzer / Receiver scanned from 150 KHz to 30MHz for emissions in each of the test modes.
8. During the above scans, the emissions were maximized by cable manipulation.

TEST RESULTS

Note: We tested all modes, recorded the worst case at wifi 802.11b mode L Channel

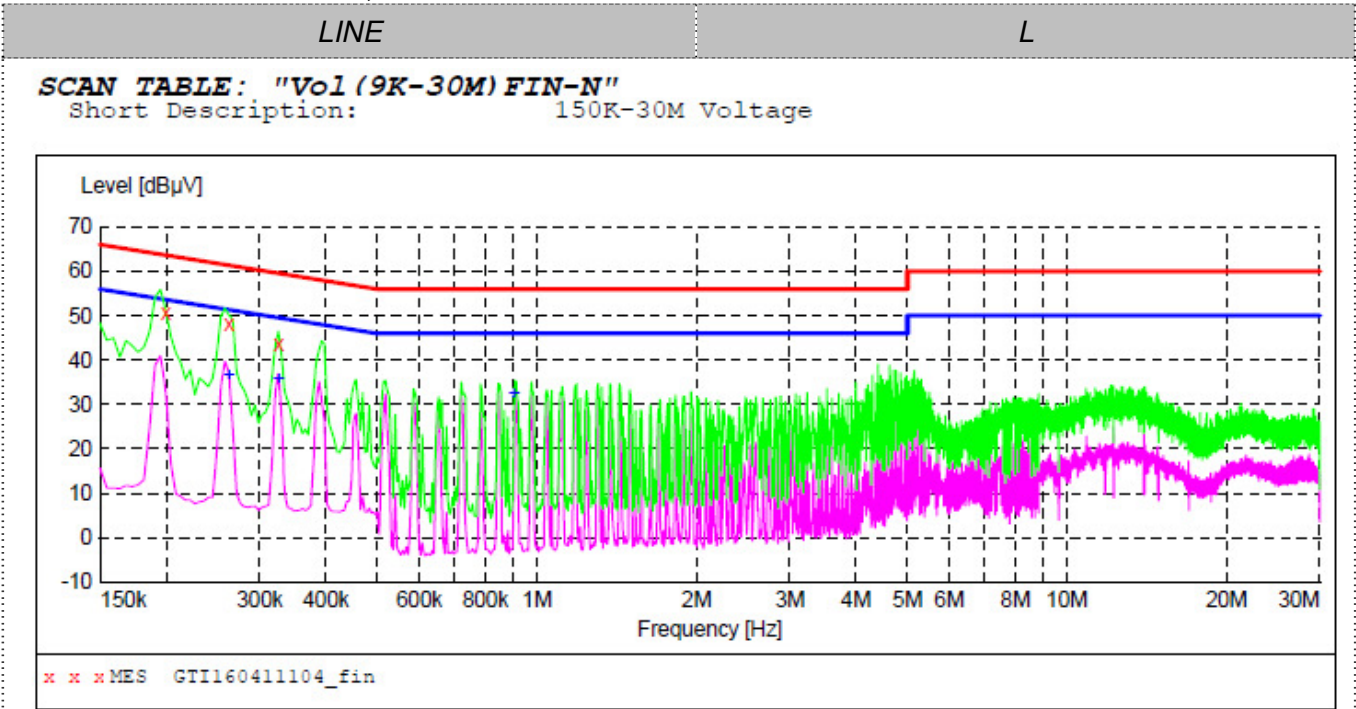

MEASUREMENT RESULT: "GTI160411104_fin"

04/11/2016 11:48AM

Frequency MHz	Level dBuV	Transd dB	Limit dBuV	Margin dB	Detector	Line	PE
0.199500	50.70	9.7	64	12.9	QP	L1	GND
0.262500	48.30	9.7	61	13.1	QP	L1	GND
0.325500	43.70	9.8	60	15.9	QP	L1	GND

MEASUREMENT RESULT: "GTI160411104_fin2"

04/11/2016 11:48AM

Frequency MHz	Level dBuV	Transd dB	Limit dBuV	Margin dB	Detector	Line	PE
0.262500	36.60	9.7	51	14.8	AV	L1	GND
0.325500	35.90	9.8	50	13.7	AV	L1	GND
0.905000	32.50	10.0	46	13.5	AV	L1	GND

LINE	N
------	---

SCAN TABLE: "Vol (9K-30M) FIN-N"
 Short Description: 150K-30M Voltage

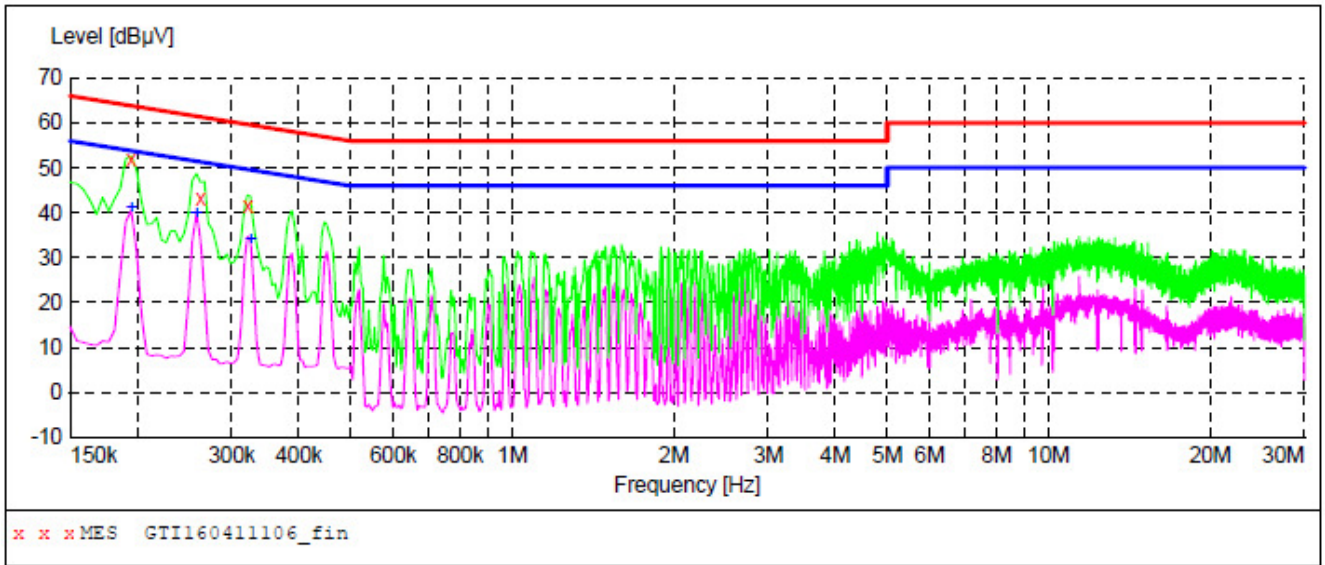

MEASUREMENT RESULT: "GTI160411106_fin"

04/11/2016 11:51AM

Frequency MHz	Level dBµV	Transd dB	Limit dBµV	Margin dB	Detector	Line	PE
0.195000	51.90	9.5	64	11.9	QP	N	GND
0.262500	43.20	9.5	61	18.2	QP	N	GND
0.321000	41.60	9.5	60	18.1	QP	N	GND

MEASUREMENT RESULT: "GTI160411106_fin2"

04/11/2016 11:51AM

Frequency MHz	Level dBµV	Transd dB	Limit dBµV	Margin dB	Detector	Line	PE
0.195000	41.00	9.5	54	12.8	AV	N	GND
0.258000	39.70	9.5	52	11.8	AV	N	GND
0.325500	34.20	9.5	50	15.4	AV	N	GND

3.2 Radiated Emission

Limit

For intentional device, according to § 15.209(a), the general requirement of field strength of radiated emission from intentional radiators at a distance of 3 meters shall not exceed the following table. According to § 15.247(d), in any 100kHz bandwidth outside the frequency band in which the EUT is operating, the radio frequency power that is produced by the intentional radiator shall be at least 20dB below that in the 100kHz bandwidth within the band that contains the highest level of desired power.

The frequency spectrum above 1 GHz for Transmitter was investigated. All emission not reported are much lower than the prescribed limits. Set the RBW=1MHz, VBW=3MHz for Peak Detector while the RBW=1MHz, VBW=10Hz for Average Detector, Readings are both peak and average values. The pre-test have done for the EUT in three axes and found the worst emission at position shown in test setup photos.

Frequency (MHz)	Distance (Meters)	Radiated (dBuV/m)	Radiated (µV/m)
0.009-0.49	3	$20\log(2400/F(\text{KHz}))+40\log(300/3)$	$2400/F(\text{KHz})$
0.49-1.705	3	$20\log(24000/F(\text{KHz}))+40\log(30/3)$	$24000/F(\text{KHz})$
1.705-30	3	$20\log(30)+40\log(30/3)$	30
30-88	3	40.0	100
88-216	3	43.5	150
216-960	3	46.0	200
Above 960	3	54.0	500

Test Procedure

1. For below 1GHz test, The EUT was placed on a turn table which is 0.8m above ground plane. For Above 1GHz test, The EUT was placed on a turn table which is 1.5m above ground plane;
2. Maximum procedure was performed by raising the receiving antenna from 1m to 4m and rotating the turn table from 0° to 360° to acquire the highest emissions from EUT
3. And also, each emission was to be maximized by changing the polarization of receiving antenna both horizontal and vertical.
4. Repeat above procedures until all frequency measurements have been completed.

Note: For the radiated emission test above 1GHz:

Place the measurement antenna away from each area of the EUT determined to be a source of emissions at the specified measurement distance, while keeping the measurement antenna aimed at the source of emissions at each frequency of significant emissions, with polarization oriented for maximum response. The measurement antenna may have to be higher or lower than the EUT, depending on the radiation pattern of the emission and staying aimed at the emission source for receiving the maximum signal. The final measurement antenna elevation shall be that which maximizes the emissions. The measurement antenna elevation for maximum emissions shall be restricted to a range of heights of from 1 m to 4 m above the ground or reference ground plane.

Field Strength Calculation

The field strength is calculated by adding the Antenna Factor and Cable Factor and subtracting the Amplifier Gain and Duty Cycle Correction Factor (if any) from the measured reading. The basic equation with a sample calculation is as follows:

$$FS = RA + AF + CL - AG$$

Where FS = Field Strength	CL = Cable Attenuation Factor (Cable Loss)
RA = Reading Amplitude	AG = Amplifier Gain
AF = Antenna Factor	

For example

Frequency (MHz)	FS (dB μ V/m)	RA (dB μ V/m)	AF (dB)	CL (dB)	AG (dB)	Transd (dB)
150.00	40	58.1	12.2	1.6	31.90	-18.1

Transd=AF +CL-AG

Test Configuration

For the actual test configuration, please refer to the related Item –EUT Test Photos.

Frequency range 9 KHz – 30MHz

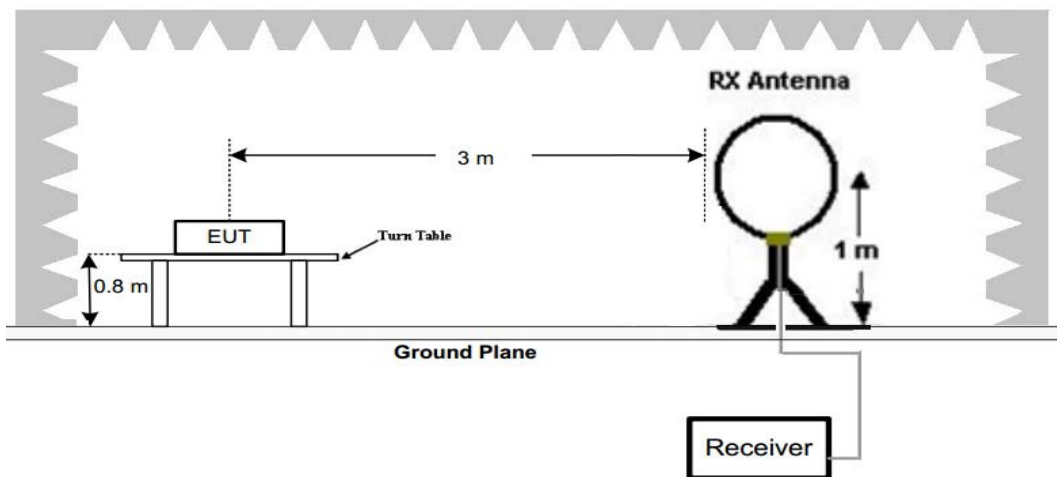

Frequency range 30MHz – 1000MHz

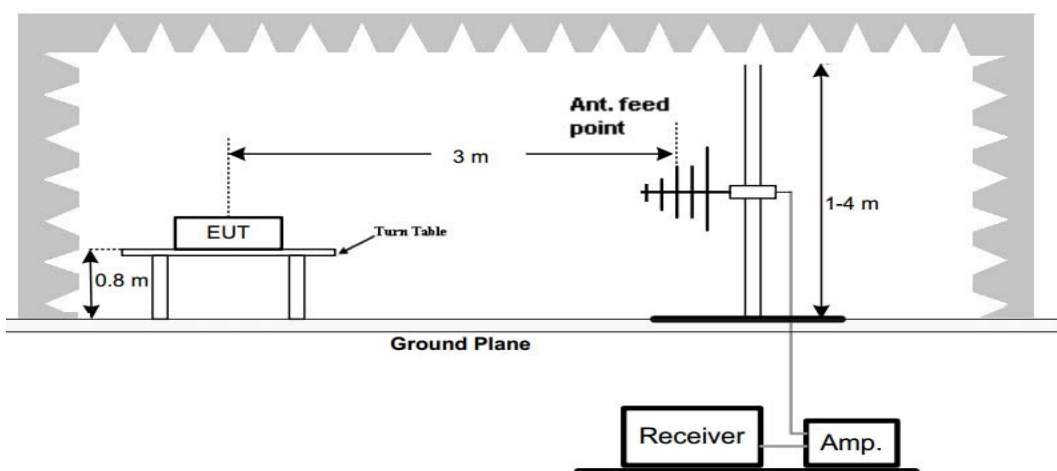

Frequency range above 1GHz-25GHz

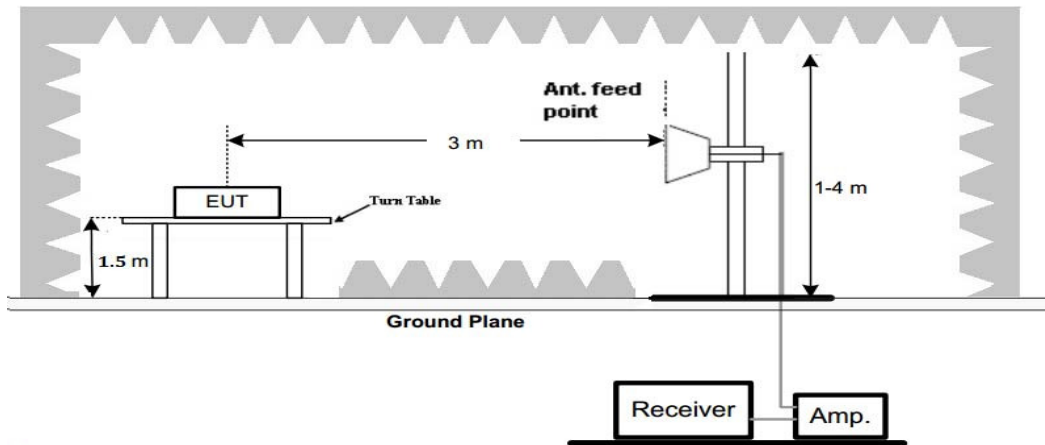

Test Results

Remark:

1. We tested three channels for each mode and recorded worst case at low channel of 802.11b Mode below 1GHz
2. By preliminary testing and verifying three axis (X, Y and Z) position of EUT transmitted status, it was found that “Y axis” position was the worst, and test data recorded in this report.

For 9 KHz-30MHz

Frequency (MHz)	Corrected Reading (dBuV/m)@3m	FCC Limit (dBuV/m) @3m	Margin (dB)	Detector	Result
0.21	54.62	100.37	54.02	QP	PASS
1.15	18.24	64.93	29.10	QP	PASS
13.56	36.02	69.54	27.87	QP	PASS
25.01	48.03	69.54	25.02	QP	PASS

For 30MHz-1GHz

Horizontal

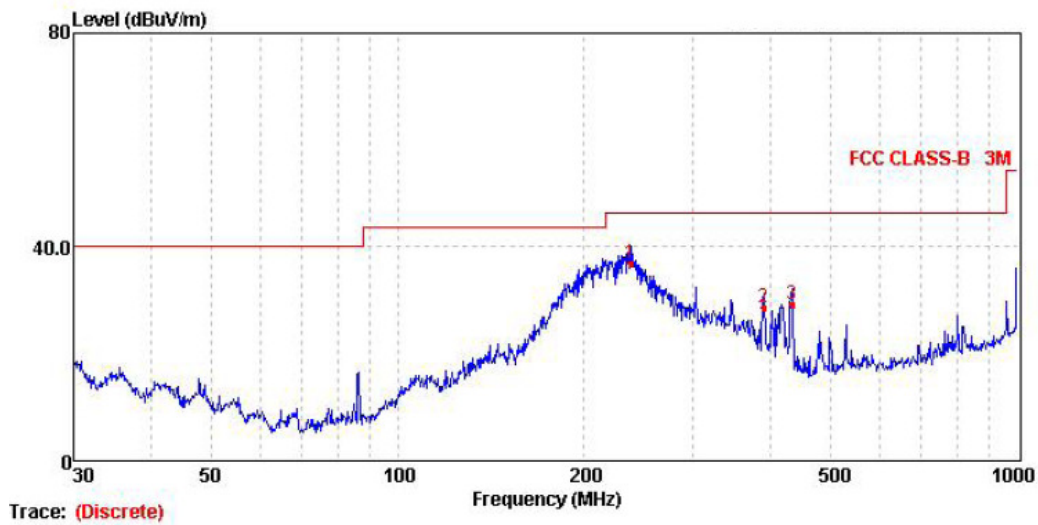

Mark	Frequency MHz	Level dBuV/m	Factor dB/m	Reading dBuV	Limit dBuV/m	Margin dB	Polarization	Detector
1	237.48	36.64	-17.66	54.30	46.00	9.36	HORIZONTAL	QP
2	389.35	28.15	-13.65	41.80	46.00	17.85	HORIZONTAL	QP
3	432.55	28.94	-12.67	41.61	46.00	17.06	HORIZONTAL	QP

Vertical

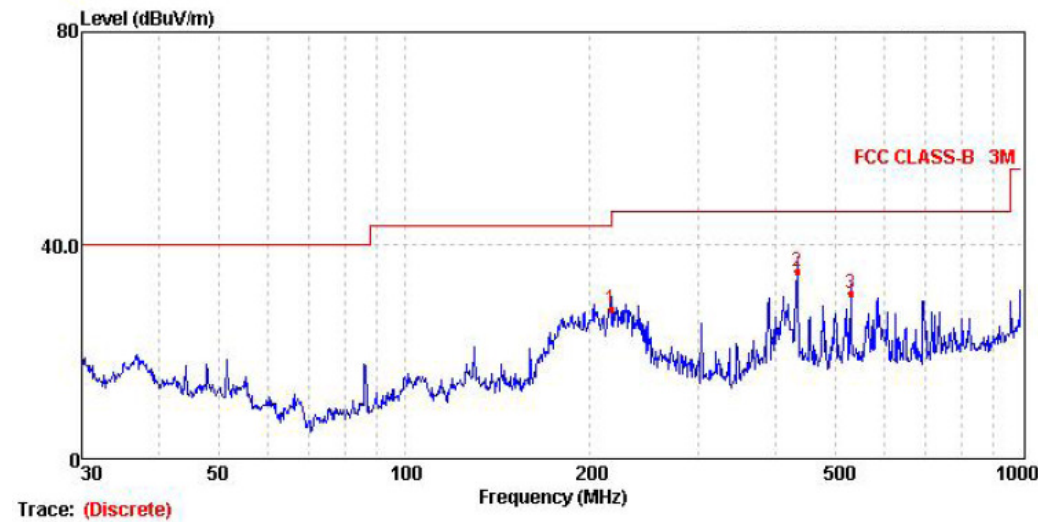

Mark	Frequency MHz	Level dBuV/m	Factor dB/m	Reading dBuV	Limit dBuV/m	Margin dB	Polarization	Detector
1	216.02	27.73	-17.77	45.50	46.00	18.27	VERTICAL	QP
2	432.55	34.74	-12.67	47.41	46.00	11.26	VERTICAL	QP
3	528.25	30.77	-11.14	41.91	46.00	15.23	VERTICAL	QP

For 1GHz to 25GHz

802.11b Mode (above 1GHz)

Frequency(MHz):			2412			Polarity:			HORIZONTAL		
No.	Frequency (MHz)	Emission Level (dBUV/m)	Limit (dBUV/m)	Margin (dB)	Antenna Height (m)	Table Angle (Degree)	Raw Value (dBUV)	Antenna Factor (dB/m)	Cable Factor (dB)	Pre-amplifier (dB)	Correction Factor (dB/m)
1	4824	49.85 PK	74.00	24.15	1.00	112.00	47.75	31.60	7.00	36.5	2.10
1	4824	42.97 AV	54.00	11.03	1.00	112.00	40.87	31.60	7.00	36.5	2.10
2	7236	42.76 PK	74.00	31.24	1.00	112.00	31.83	37.33	8.90	35.3	10.93
2	7236	37.49 AV	54.00	16.51	1.00	112.00	26.56	37.33	8.90	35.3	10.93

Frequency(MHz):			2412			Polarity:			VERTICAL		
No.	Frequency (MHz)	Emission Level (dBUV/m)	Limit (dBUV/m)	Margin (dB)	Antenna Height (m)	Table Angle (Degree)	Raw Value (dBUV)	Antenna Factor (dB/m)	Cable Factor (dB)	Pre-amplifier (dB)	Correction Factor (dB/m)
1	4824	51.29 PK	74.00	22.71	1.00	156.00	49.19	31.60	7.00	36.5	2.10
1	4824	45.67 AV	54.00	8.33	1.00	156.00	43.57	31.60	7.00	36.5	2.10
2	7236	44.39 PK	74.00	29.61	1.00	156.00	33.46	37.33	8.90	35.3	10.93
2	7236	38.25 AV	54.00	15.75	1.00	156.00	27.32	37.33	8.90	35.3	10.93

Frequency(MHz):			2437			Polarity:			HORIZONTAL		
No.	Frequency (MHz)	Emission Level (dBUV/m)	Limit (dBUV/m)	Margin (dB)	Antenna Height (m)	Table Angle (Degree)	Raw Value (dBUV)	Antenna Factor (dB/m)	Cable Factor (dB)	Pre-amplifier (dB)	Correction Factor (dB/m)
1	4874.00	48.96 PK	74.00	25.04	1.00	106.00	46.84	31.02	7.60	36.5	2.12
1	4874.00	42.79 AV	54.00	11.21	1.00	106.00	40.67	31.02	7.60	36.5	2.12
2	7311.00	42.97 PK	74.00	31.03	1.00	106.00	31.89	37.28	8.60	34.8	11.08
2	7311.00	36.15 AV	54.00	17.85	1.00	106.00	25.07	37.28	8.60	34.8	11.08

Frequency(MHz):			2437			Polarity:			VERTICAL		
No.	Frequency (MHz)	Emission Level (dBUV/m)	Limit (dBUV/m)	Margin (dB)	Antenna Height (m)	Table Angle (Degree)	Raw Value (dBUV)	Antenna Factor (dB/m)	Cable Factor (dB)	Pre-amplifier (dB)	Correction Factor (dB/m)
1	4874.00	51.53 PK	74.00	22.47	1.00	166.00	49.41	31.02	7.60	36.5	2.12
1	4874.00	46.14 AV	54.00	7.86	1.00	166.00	44.02	31.02	7.60	36.5	2.12
2	7311.00	43.81 PK	74.00	30.19	1.00	166.00	32.73	37.28	8.60	34.8	11.08
2	7311.00	37.91 AV	54.00	16.09	1.00	166.00	26.83	37.28	8.60	34.8	11.08

Frequency(MHz):			2462			Polarity:			HORIZONTAL		
No.	Frequency (MHz)	Emission Level (dBUV/m)	Limit (dBUV/m)	Margin (dB)	Antenna Height (m)	Table Angle (Degree)	Raw Value (dBUV)	Antenna Factor (dB/m)	Cable Factor (dB)	Pre-amplifier (dB)	Correction Factor (dB/m)
1	4924.00	51.04 PK	74.00	22.96	1.00	124.00	47.84	31.58	7.82	36.2	3.20
1	4924.00	43.65 AV	54.00	10.35	1.00	124.00	40.45	31.58	7.82	36.2	3.20
2	7386.00	42.72 PK	74.00	31.28	1.00	124.00	30.78	38.51	8.73	35.3	11.94
2	7386.00	36.86 AV	54.00	17.14	1.00	124.00	24.92	38.51	8.73	35.3	11.94

Frequency(MHz):			2462			Polarity:			VERTICAL		
No.	Frequency (MHz)	Emission Level (dBUV/m)	Limit (dBUV/m)	Margin (dB)	Antenna Height (m)	Table Angle (Degree)	Raw Value (dBUV)	Antenna Factor (dB/m)	Cable Factor (dB)	Pre-amplifier (dB)	Correction Factor (dB/m)
1	4924.00	50.78 PK	74.00	23.22	1.00	152.00	47.58	31.58	7.82	36.2	3.20
1	4924.00	46.48 AV	54.00	7.52	1.00	152.00	43.28	31.58	7.82	36.2	3.20
2	7386.00	43.45 PK	74.00	30.55	1.00	152.00	31.51	38.51	8.73	35.3	11.94
2	7386.00	36.54 AV	54.00	17.46	1.00	152.00	24.60	38.51	8.73	35.3	11.94

802.11g Mode (above 1GHz)

Frequency(MHz):				2412			Polarity:			HORIZONTAL		
No.	Frequency (MHz)	Emission Level (dBuV/m)		Limit (dBuV/m)	Margin (dB)	Antenna Height (m)	Table Angle (Degree)	Raw Value (dBuV)	Antenna Factor (dB/m)	Cable Factor (dB)	Pre-amplifier (dB)	Correction Factor (dB/m)
1	4824	48.29	PK	74.00	25.71	1.00	112.00	46.19	31.6	7.00	36.5	2.10
1	4824	41.59	AV	54.00	12.41	1.00	112.00	39.49	31.6	7.00	36.5	2.10
2	7236	43.54	PK	74.00	30.46	1.00	112.00	32.61	37.33	8.90	35.3	10.93
2	7236	33.22	AV	54.00	20.78	1.00	112.00	22.29	37.33	8.90	35.3	10.93

Frequency(MHz):				2412			Polarity:			VERTICAL		
No.	Frequency (MHz)	Emission Level (dBuV/m)		Limit (dBuV/m)	Margin (dB)	Antenna Height (m)	Table Angle (Degree)	Raw Value (dBuV)	Antenna Factor (dB/m)	Cable Factor (dB)	Pre-amplifier (dB)	Correction Factor (dB/m)
1	4824	50.26	PK	74.00	23.74	1.00	156.00	48.16	31.60	7.00	36.5	2.10
1	4824	42.42	AV	54.00	11.58	1.00	156.00	40.32	31.60	7.00	36.5	2.10
2	7236	44.20	PK	74.00	29.80	1.00	156.00	33.27	37.33	8.90	35.3	10.93
2	7236	37.44	AV	54.00	16.56	1.00	156.00	26.51	37.33	8.90	35.3	10.93

Frequency(MHz):				2437			Polarity:			HORIZONTAL		
No.	Frequency (MHz)	Emission Level (dBuV/m)		Limit (dBuV/m)	Margin (dB)	Antenna Height (m)	Table Angle (Degree)	Raw Value (dBuV)	Antenna Factor (dB/m)	Cable Factor (dB)	Pre-amplifier (dB)	Correction Factor (dB/m)
1	4874.00	49.93	PK	74.00	24.07	1.00	106.00	47.81	31.02	7.60	36.5	2.12
1	4874.00	42.02	AV	54.00	11.98	1.00	106.00	39.90	31.02	7.60	36.5	2.12
2	7311.00	43.15	PK	74.00	30.85	1.00	106.00	32.07	37.28	8.60	34.8	11.08
2	7311.00	34.92	AV	54.00	19.08	1.00	106.00	23.84	37.28	8.60	34.8	11.08

Frequency(MHz):				2437			Polarity:			VERTICAL		
No.	Frequency (MHz)	Emission Level (dBuV/m)		Limit (dBuV/m)	Margin (dB)	Antenna Height (m)	Table Angle (Degree)	Raw Value (dBuV)	Antenna Factor (dB/m)	Cable Factor (dB)	Pre-amplifier (dB)	Correction Factor (dB/m)
1	4874.00	51.03	PK	74.00	22.97	1.00	166.00	48.91	31.02	7.60	36.5	2.12
1	4874.00	41.62	AV	54.00	12.38	1.00	166.00	39.50	31.02	7.60	36.5	2.12
2	7311.00	44.35	PK	74.00	29.65	1.00	166.00	33.27	37.28	8.60	34.8	11.08
2	7311.00	35.38	AV	54.00	18.62	1.00	166.00	24.30	37.28	8.60	34.8	11.08

Frequency(MHz):				2462			Polarity:			HORIZONTAL		
No.	Frequency (MHz)	Emission Level (dBuV/m)		Limit (dBuV/m)	Margin (dB)	Antenna Height (m)	Table Angle (Degree)	Raw Value (dBuV)	Antenna Factor (dB/m)	Cable Factor (dB)	Pre-amplifier (dB)	Correction Factor (dB/m)
1	4924.00	50.15	PK	74.00	23.85	1.00	166.00	46.95	31.58	7.82	36.2	3.20
1	4924.00	41.98	AV	54.00	12.02	1.00	166.00	38.78	31.58	7.82	36.2	3.20
2	7386.00	43.55	PK	74.00	30.45	1.00	166.00	31.61	38.51	8.73	35.3	11.94
2	7386.00	35.79	AV	54.00	18.21	1.00	166.00	23.85	38.51	8.73	35.3	11.94

Frequency(MHz):				2462			Polarity:			VERTICAL		
No.	Frequency (MHz)	Emission Level (dBuV/m)		Limit (dBuV/m)	Margin (dB)	Antenna Height (m)	Table Angle (Degree)	Raw Value (dBuV)	Antenna Factor (dB/m)	Cable Factor (dB)	Pre-amplifier (dB)	Correction Factor (dB/m)
1	4924.00	50.33	PK	74.00	23.67	1.00	152.00	47.13	55.70	7.82	36.2	3.20
1	4924.00	41.32	AV	54.00	12.68	1.00	152.00	38.12	49.20	7.82	36.2	3.20
2	7386.00	44.86	PK	74.00	29.14	1.00	152.00	32.92	50.45	8.73	35.3	11.94
2	7386.00	36.47	AV	54.00	17.53	1.00	152.00	24.53	41.28	8.73	35.3	11.94

802.11n20 Mode (above 1GHz)

Frequency(MHz):				2412			Polarity:			HORIZONTAL		
No.	Frequency (MHz)	Emission Level (dBuV/m)		Limit (dBuV/m)	Margin (dB)	Antenna Height (m)	Table Angle (Degree)	Raw Value (dBuV)	Antenna Factor (dB/m)	Cable Factor (dB)	Pre-amplifier (dB)	Correction Factor (dB/m)
1	4824	48.13	PK	74.00	25.87	1.00	100.00	46.03	31.6	7.00	36.5	2.10
1	4824	40.86	AV	54.00	13.14	1.00	100.00	38.76	31.6	7.00	36.5	2.10
2	7236	42.14	PK	74.00	31.86	1.00	100.00	31.21	37.33	8.90	35.3	10.93
2	7236	33.48	AV	54.00	20.52	1.00	100.00	22.55	37.33	8.90	35.3	10.93

Frequency(MHz):				2412			Polarity:			VERTICAL		
No.	Frequency (MHz)	Emission Level (dBuV/m)		Limit (dBuV/m)	Margin (dB)	Antenna Height (m)	Table Angle (Degree)	Raw Value (dBuV)	Antenna Factor (dB/m)	Cable Factor (dB)	Pre-amplifier (dB)	Correction Factor (dB/m)
1	4824	48.51	PK	74.00	25.49	1.00	141.00	46.41	31.60	7.00	36.5	2.10
1	4824	41.78	AV	54.00	12.22	1.00	141.00	39.68	31.60	7.00	36.5	2.10
2	7236	43.83	PK	74.00	30.17	1.00	141.00	32.90	37.33	8.90	35.3	10.93
2	7236	37.63	AV	54.00	16.37	1.00	141.00	26.70	37.33	8.90	35.3	10.93

Frequency(MHz):				2437			Polarity:			HORIZONTAL		
No.	Frequency (MHz)	Emission Level (dBuV/m)		Limit (dBuV/m)	Margin (dB)	Antenna Height (m)	Table Angle (Degree)	Raw Value (dBuV)	Antenna Factor (dB/m)	Cable Factor (dB)	Pre-amplifier (dB)	Correction Factor (dB/m)
1	4874.00	47.09	PK	74.00	26.91	1.00	100.00	44.97	56.38	7.60	36.5	2.12
1	4874.00	39.28	AV	54.00	14.72	1.00	100.00	37.16	48.60	7.60	36.5	2.12
2	7311.00	43.56	PK	74.00	30.44	1.00	100.00	32.48	51.34	8.60	34.8	11.08
2	7311.00	34.93	AV	54.00	19.07	1.00	100.00	23.85	43.25	8.60	34.8	11.08

Frequency(MHz):				2437			Polarity:			VERTICAL		
No.	Frequency (MHz)	Emission Level (dBuV/m)		Limit (dBuV/m)	Margin (dB)	Antenna Height (m)	Table Angle (Degree)	Raw Value (dBuV)	Antenna Factor (dB/m)	Cable Factor (dB)	Pre-amplifier (dB)	Correction Factor (dB/m)
1	4874.00	47.30	PK	74.00	26.70	1.00	171.00	45.18	31.02	7.60	36.5	2.12
1	4874.00	40.26	AV	54.00	13.74	1.00	171.00	38.14	31.02	7.60	36.5	2.12
2	7311.00	43.87	PK	74.00	30.13	1.00	171.00	32.79	37.28	8.60	34.8	11.08
2	7311.00	35.07	AV	54.00	18.93	1.00	171.00	23.99	37.28	8.60	34.8	11.08

Frequency(MHz):				2462			Polarity:			HORIZONTAL		
No.	Frequency (MHz)	Emission Level (dBuV/m)		Limit (dBuV/m)	Margin (dB)	Antenna Height (m)	Table Angle (Degree)	Raw Value (dBuV)	Antenna Factor (dB/m)	Cable Factor (dB)	Pre-amplifier (dB)	Correction Factor (dB/m)
1	4924.00	49.41	PK	74.00	24.59	1.00	176.00	46.21	31.58	7.82	36.2	3.20
1	4924.00	41.68	AV	54.00	12.32	1.00	176.00	38.48	31.58	7.82	36.2	3.20
2	7386.00	42.96	PK	74.00	31.04	1.00	176.00	31.02	38.51	8.73	35.3	11.94
2	7386.00	35.00	AV	54.00	19.00	1.00	176.00	23.06	38.51	8.73	35.3	11.94

Frequency(MHz):				2462			Polarity:			VERTICAL		
No.	Frequency (MHz)	Emission Level (dBuV/m)		Limit (dBuV/m)	Margin (dB)	Antenna Height (m)	Table Angle (Degree)	Raw Value (dBuV)	Antenna Factor (dB/m)	Cable Factor (dB)	Pre-amplifier (dB)	Correction Factor (dB/m)
1	4924.00	49.77	PK	74.00	24.23	1.00	146.00	46.57	31.58	7.82	36.2	3.20
1	4924.00	41.14	AV	54.00	12.86	1.00	146.00	37.94	31.58	7.82	36.2	3.20
2	7386.00	45.32	PK	74.00	28.68	1.00	146.00	33.38	38.51	8.73	35.3	11.94
2	7386.00	35.80	AV	54.00	18.20	1.00	146.00	23.86	38.51	8.73	35.3	11.94

802.11n40 Mode (above 1GHz)

Frequency(MHz):			2422			Polarity:			HORIZONTAL		
No.	Frequency (MHz)	Emission Level (dBuV/m)	Limit (dBuV/m)	Margin (dB)	Antenna Height (m)	Table Angle (Degree)	Raw Value (dBuV)	Antenna Factor (dB/m)	Cable Factor (dB)	Pre-amplifier (dB)	Correction Factor (dB/m)
1	4844.00	46.26 PK	74.00	27.74	1.00	122.00	44.16	31.6	7.00	36.5	2.10
1	4844.00	37.24 AV	54.00	16.76	1.00	122.00	35.14	31.6	7.00	36.5	2.10
2	7266.00	40.83 PK	74.00	33.17	1.00	122.00	29.90	37.33	8.90	35.3	10.93
2	7266.00	34.43 AV	54.00	19.57	1.00	122.00	23.50	37.33	8.90	35.3	10.93

Frequency(MHz):			2422			Polarity:			VERTICAL		
No.	Frequency (MHz)	Emission Level (dBuV/m)	Limit (dBuV/m)	Margin (dB)	Antenna Height (m)	Table Angle (Degree)	Raw Value (dBuV)	Antenna Factor (dB/m)	Cable Factor (dB)	Pre-amplifier (dB)	Correction Factor (dB/m)
1	4844.00	47.56 PK	74.00	26.44	1.00	161.00	45.46	31.60	7.00	36.5	2.10
1	4844.00	38.75 AV	54.00	15.25	1.00	161.00	36.65	31.60	7.00	36.5	2.10
2	7266.00	43.57 PK	74.00	30.43	1.00	161.00	32.64	37.33	8.90	35.3	10.93
2	7266.00	36.59 AV	54.00	17.41	1.00	161.00	25.66	37.33	8.90	35.3	10.93

Frequency(MHz):			2437			Polarity:			HORIZONTAL		
No.	Frequency (MHz)	Emission Level (dBuV/m)	Limit (dBuV/m)	Margin (dB)	Antenna Height (m)	Table Angle (Degree)	Raw Value (dBuV)	Antenna Factor (dB/m)	Cable Factor (dB)	Pre-amplifier (dB)	Correction Factor (dB/m)
1	4874.00	45.75 PK	74.00	28.25	1.00	102.00	43.63	31.02	7.60	36.5	2.12
1	4874.00	38.22 AV	54.00	15.78	1.00	102.00	36.10	31.02	7.60	36.5	2.12
2	7311.00	42.37 PK	74.00	31.63	1.00	102.00	31.29	37.28	8.60	34.8	11.08
2	7311.00	33.75 AV	54.00	20.25	1.00	102.00	22.67	37.28	8.60	34.8	11.08

Frequency(MHz):			2437			Polarity:			VERTICAL		
No.	Frequency (MHz)	Emission Level (dBuV/m)	Limit (dBuV/m)	Margin (dB)	Antenna Height (m)	Table Angle (Degree)	Raw Value (dBuV)	Antenna Factor (dB/m)	Cable Factor (dB)	Pre-amplifier (dB)	Correction Factor (dB/m)
1	4874.00	47.41 PK	74.00	26.59	1.00	181.00	45.29	31.02	7.60	36.5	2.12
1	4874.00	41.12 AV	54.00	12.88	1.00	181.00	39.00	31.02	7.60	36.5	2.12
2	7311.00	45.04 PK	74.00	28.96	1.00	181.00	33.96	37.28	8.60	34.8	11.08
2	7311.00	35.55 AV	54.00	18.45	1.00	181.00	24.47	37.28	8.60	34.8	11.08

Frequency(MHz):			2452			Polarity:			HORIZONTAL		
No.	Frequency (MHz)	Emission Level (dBuV/m)	Limit (dBuV/m)	Margin (dB)	Antenna Height (m)	Table Angle (Degree)	Raw Value (dBuV)	Antenna Factor (dB/m)	Cable Factor (dB)	Pre-amplifier (dB)	Correction Factor (dB/m)
1	4904.00	47.65 PK	74.00	26.35	1.00	166.00	44.45	31.58	7.82	36.2	3.20
1	4904.00	41.44 AV	54.00	12.56	1.00	166.00	38.24	31.58	7.82	36.2	3.20
2	7356.00	43.87 PK	74.00	30.13	1.00	166.00	31.93	38.51	8.73	35.3	11.94
2	7356.00	35.32 AV	54.00	18.68	1.00	166.00	23.38	38.51	8.73	35.3	11.94

Frequency(MHz):			2452			Polarity:			VERTICAL		
No.	Frequency (MHz)	Emission Level (dBuV/m)	Limit (dBuV/m)	Margin (dB)	Antenna Height (m)	Table Angle (Degree)	Raw Value (dBuV)	Antenna Factor (dB/m)	Cable Factor (dB)	Pre-amplifier (dB)	Correction Factor (dB/m)
1	4904.00	48.15 PK	74.00	25.85	1.00	152.00	44.95	31.58	7.82	36.2	3.20
1	4904.00	40.40 AV	54.00	13.60	1.00	152.00	37.20	31.58	7.82	36.2	3.20
2	7356.00	45.95 PK	74.00	28.05	1.00	152.00	34.01	38.51	8.73	35.3	11.94
2	7356.00	34.69 AV	54.00	19.31	1.00	152.00	22.75	38.51	8.73	35.3	11.94

3.3 Maximum Conducted Output Power

Limit

30dBm for digital modulation systems.

Test Procedure

1. Remove the antenna from the EUT and then connect a low loss RF cable from the antenna port to the Power Meter.
2. Ensure EUT transmitting with a duty cycle $\geq 98\%$.
3. Record the value of Power Meter.

Test Configuration

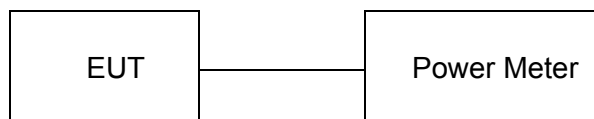

Test Results

WIFI				
Type	Channel	Output power PK(dBm)	Limit (dBm)	Result
802.11b	01	14.12	30.00	Pass
	06	14.19		
	11	13.98		
802.11g	01	12.45	30.00	Pass
	06	12.78		
	11	12.71		
802.11n(H20)	01	12.44	30.00	Pass
	06	12.75		
	11	12.19		
802.11n(H40)	03	12.18	30.00	Pass
	06	12.04		
	09	12.07		

Note: 1.The test results including the cable lose.

3.4 Power Spectral Density

Limit

For digitally modulated systems, the power spectral density conducted from the intentional radiator to the antenna shall not be greater than 8 dBm in any 3 kHz band during any time interval of continuous transmission.

Test Procedure

- This procedure shall be used if maximum peak conducted output power was used to demonstrate compliance to the output power limit.
 1. Set analyzer center frequency to DTS channel center frequency.
 2. Set the span to 1.5 times the DTS bandwidth.
 3. Set the RBW to: $3\text{ kHz} \leq \text{RBW} \leq 100\text{ kHz}$.
 4. Set the VBW $\geq 3 \times \text{RBW}$.
 5. Detector = peak.
 6. Sweep time = auto couple.
 7. Trace mode = max hold.
 8. Allow trace to fully stabilize.
 9. Use the peak marker function to determine the maximum amplitude level within the RBW.
 10. If measured value exceeds limit, reduce RBW (no less than 3 kHz) and repeat

Test Configuration

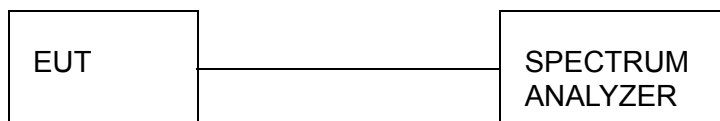

Test Results

WIFI				
Type	Channel	Power Spectral Density (dBm/30KHz)	Limit (dBm/3KHz)	Result
802.11b	01	-0.63	8.00	Pass
	06	-0.53		
	11	-0.74		
802.11g	01	-6.15	8.00	Pass
	06	-6.16		
	11	-6.36		
802.11n(HT20)	01	-6.13	8.00	Pass
	06	-5.91		
	11	-6.56		
802.11n(HT40)	01	-9.91	8.00	Pass
	06	-10.25		
	11	-10.23		

Test plot as follows:

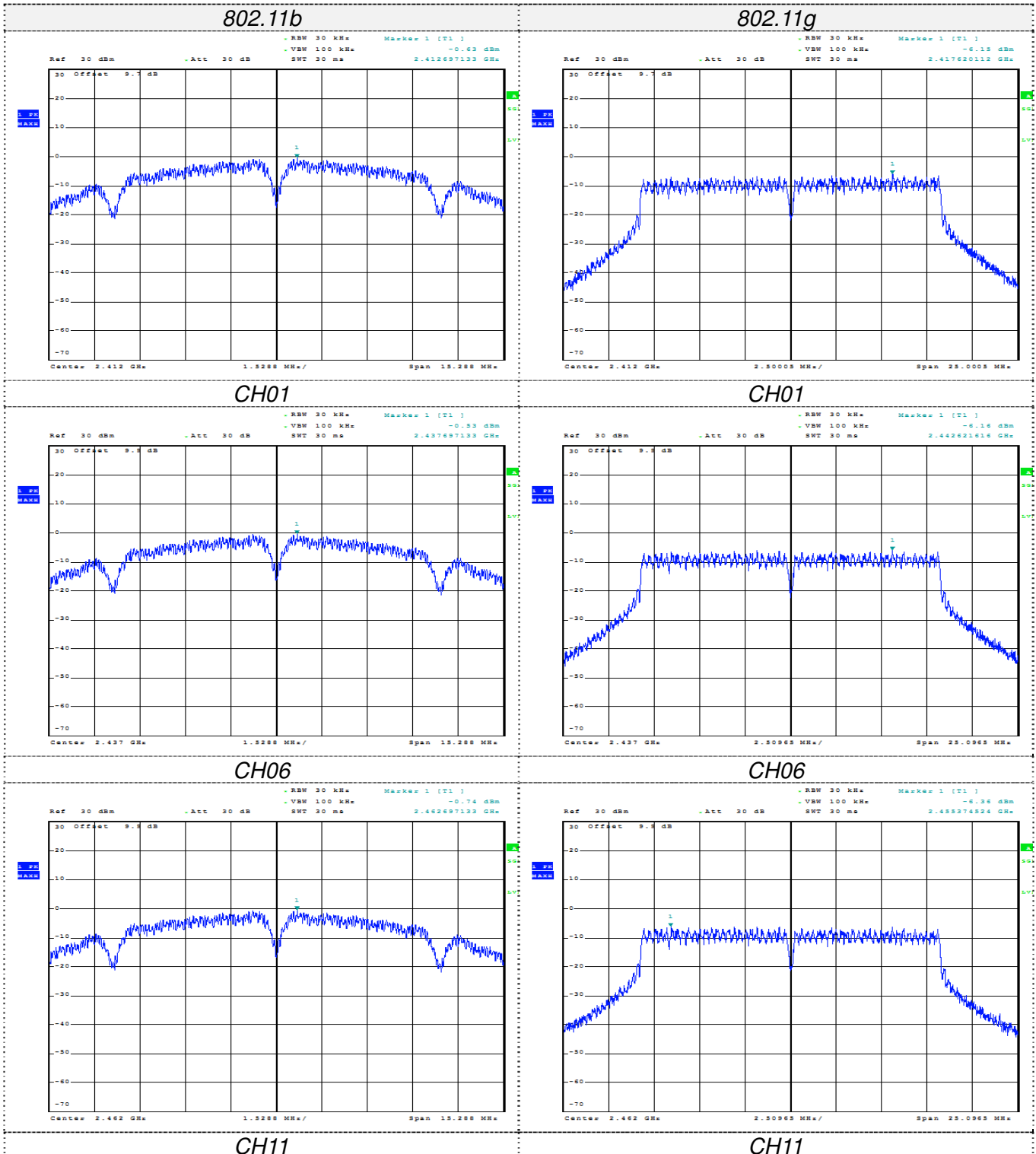

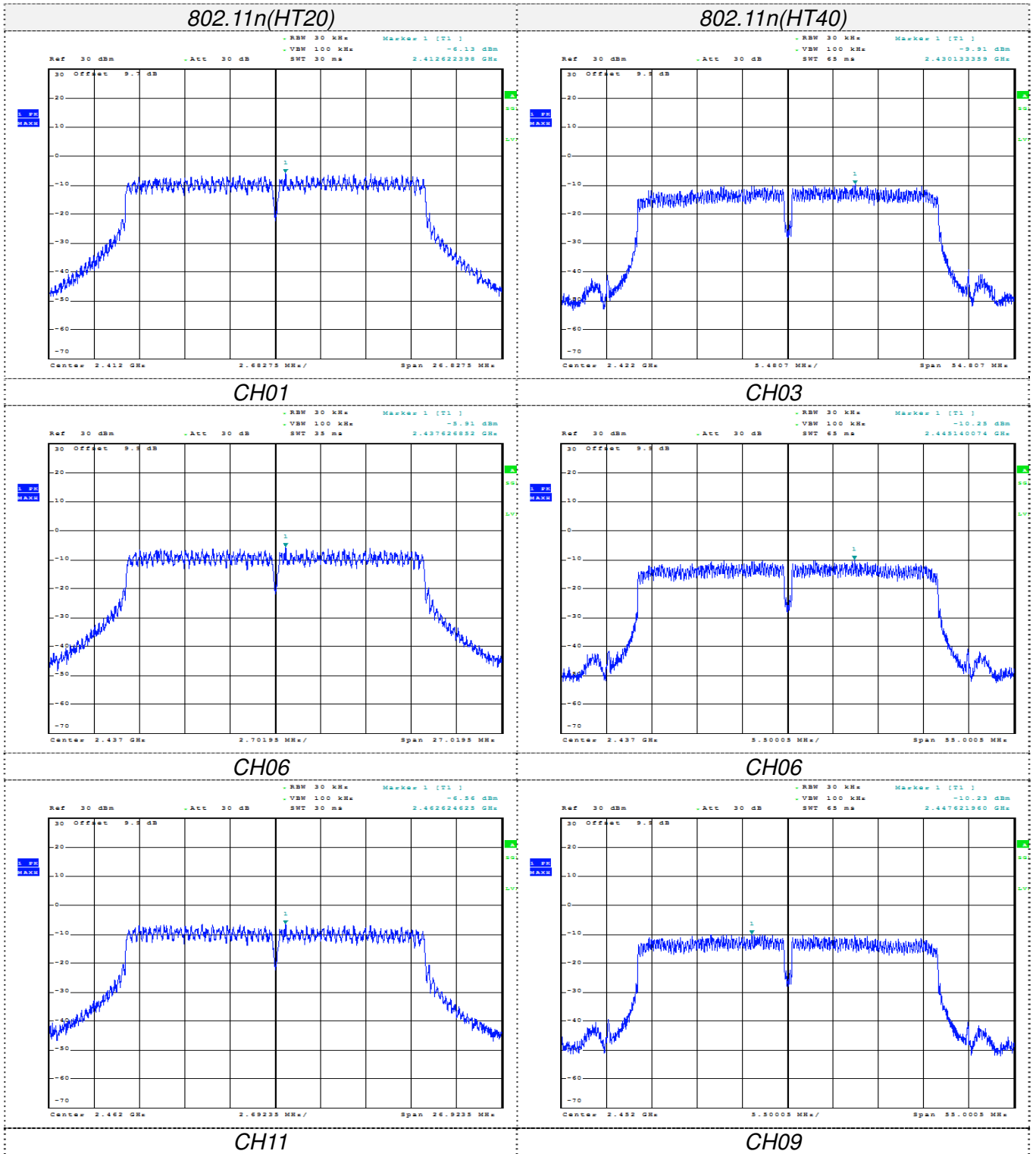

3.5 6dB Bandwidth

Limit

For digital modulation systems, the minimum 6 dB bandwidth shall be at least 500 kHz

Test Procedure

1. The transmitter output was connected to the spectrum analyzer.
2. Set SA as follow:
 - a) RBW: 100 kHz.
 - b) VBW: $\geq 3 \times$ RBW.
 - c) Detector: Peak.
 - d) Trace mode: max hold.
 - e) Sweep: auto couple.
3. Allow the trace to stabilize.
4. Measure the maximum width of the emission that is constrained by the frequencies associated with the two outermost amplitude points (upper and lower frequencies) that are attenuated by 6 dB relative to the maximum level measured in the fundamental emission.

Test Configuration

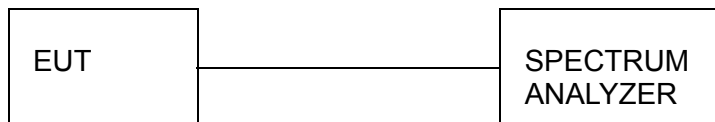

Test Results

WIFI				
Type	Channel	6dB Bandwidth (MHz)	Limit (KHz)	Result
802.11b	01	10.000	≥ 500	Pass
	06	9.936		
	11	9.936		
802.11g	01	16.603	≥ 500	Pass
	06	16.603		
	11	16.603		
802.11n(HT20)	01	17.756	≥ 500	Pass
	06	17.756		
	11	17.756		
802.11n(HT40)	03	35.897	≥ 500	Pass
	06	36.282		
	09	36.282		

Test plot as follows:

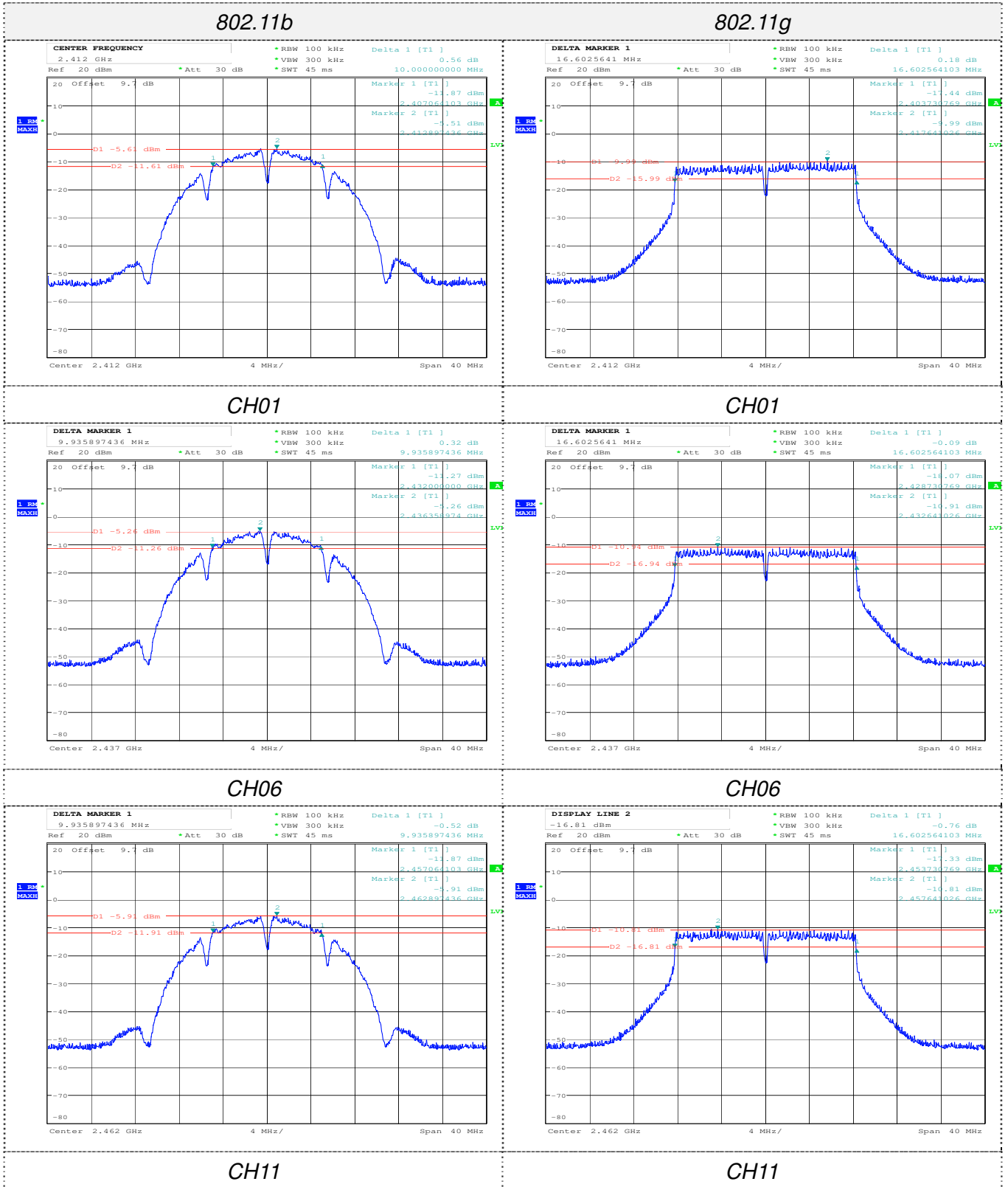

802.11n(HT20)

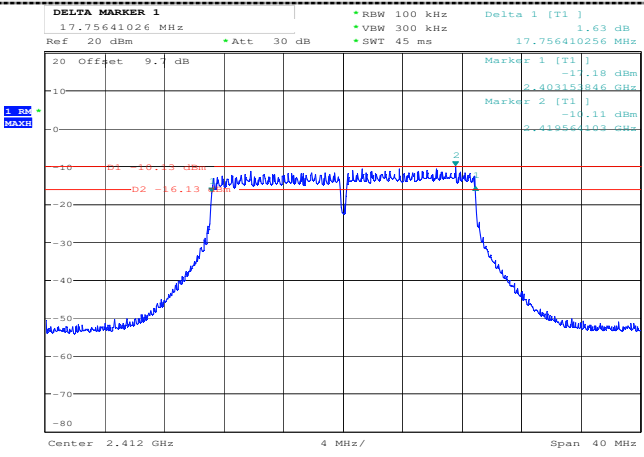

802.11n(HT40)

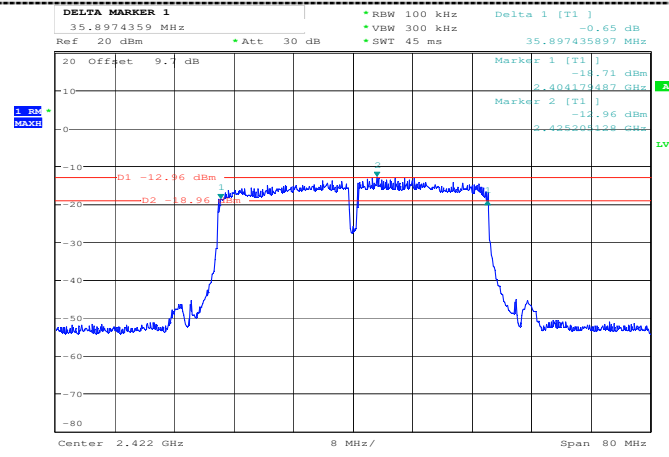

CH01

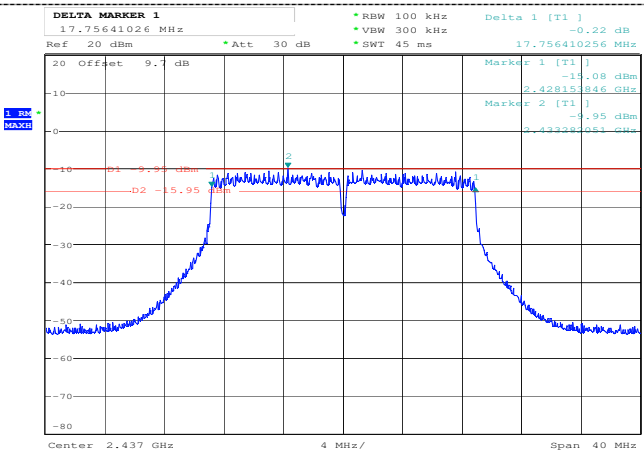

CH03

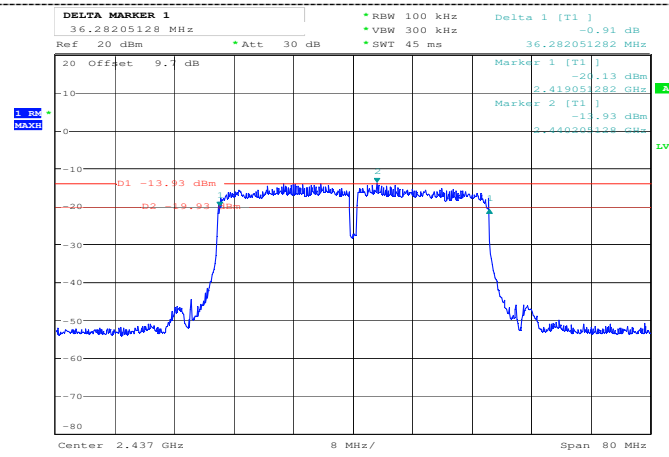

CH06

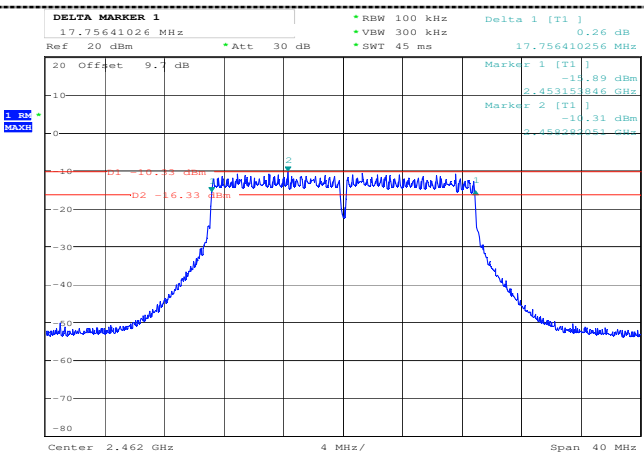

CH06

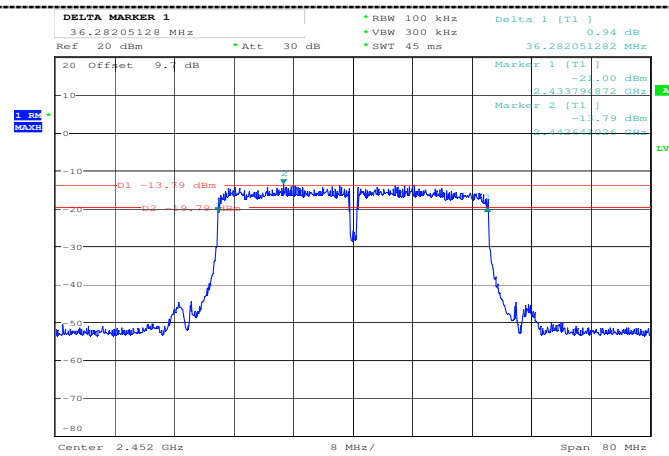

CH11

CH09

3.6 Band Edge Compliance of RF Emission

Limit

In any 100 kHz bandwidth outside the frequency band in which the spread spectrum or digitally modulated intentional radiator is operating, the radio frequency power that is produced by the intentional radiator shall be at least 20 dB below that in the 100 kHz bandwidth within the band that contains the highest level of the desired power, based on either an RF conducted or a radiated measurement, provided the transmitter demonstrates compliance with the peak conducted power limits. If the transmitter complies with the conducted power limits based on the use of RMS averaging over a time interval, as permitted under paragraph (b)(3) of this section, the attenuation required under this paragraph shall be 30 dB instead of 20 dB. Attenuation below the general limits specified in §15.209(a) is not required. In addition, radiated emissions which fall in the restricted bands, as defined in §15.205(a), must also comply with the radiated emission limits specified in §15.209(a) (see §15.205(c)).

Radiated emissions which fall in the restricted bands, as defined in § 15.205(a), must also comply with the radiated emission limits specified in § 15.209(a)

Test Procedure

Test Procedure for conducted method

- Use this procedure when the maximum (average) conducted output power was used to demonstrate compliance to the output power limit.
 1. Remove the antenna from the EUT and then connect to a low loss RF cable from the antenna port to a spectrum analyzer
 2. Turn on the EUT and make it operate in transmitting mode. Then set it to Low Channel and High Channel within its operating range, and make sure the instrument is operated in its linear range.
 1. Set spectrum analyzer RBW =100 kHz, VBW=300 kHz, Detector=peak, Sweep time=Auto, trace=maxhold
 3. Marker the highest point which fall into restricted frequency bands
 4. Repeat above procedures until all measured frequencies were complete.

Test Procedure for radiated method

1. The EUT was placed on the top of a rotating table 0.8 meters above the ground at a 3 meter anechoic chamber. The table was rotated 360 degrees to determine the position of the highest radiation.
2. The EUT was set 3 meters away from the interference receiving antenna, which was mounted on the top of a variable height antenna tower.
3. The antenna height is varied from one meter to four meters above the ground to determine the maximum value of the field strength. Both horizontal and vertical polarizations of the antenna are set to make the measurement.
4. For each suspected emission, the EUT was arranged to its worst case and then the antenna was tuned to heights from 1 meter to 4 meters and the rotatable table was turned from 0 degrees to 360 degrees to find the maximum reading.
5. The test-receiver system was set to Peak Detect Function and Specified Bandwidth with Maximum Hold Mode.
6. Place a marker at the end of the restricted band closest to the transmit frequency to show compliance. Also measure any emissions in the restricted bands. Save the spectrum analyzer plot. Repeat for each power and modulation for lowest and highest channel
7. Test the EUT in the lowest channel, the highest channel
8. The radiation measurements are performed in X, Y, Z axis positioning. And found the X axis positioning which it is worse case, only the test worst case mode is recorded in the report.
9. Repeat above procedures until all frequencies measured was complete.

Test Results

A. Conducted measurements

802.11b			
Frequency (MHz)	Delta Peak to Band emission (dBc)	Limit (dBc)	Verdict
2362.370	47.856	20	PASS
2486.655	47.906	20	PASS

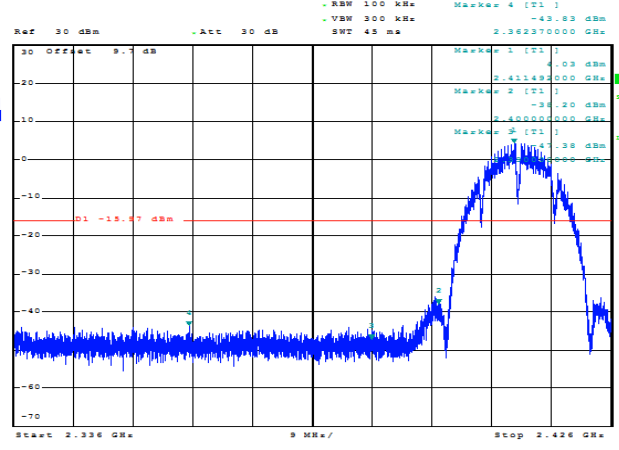
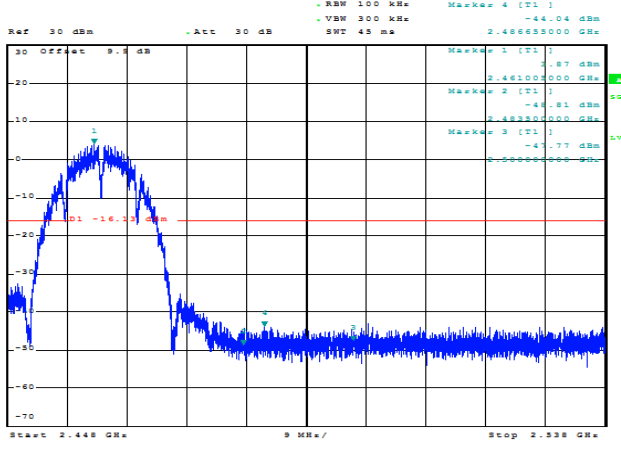
	
2412	2462

802.11g			
Frequency (MHz)	Delta Peak to Band emission (dBc)	Limit (dBc)	Verdict
2340.113	39.202	20	PASS
2493.207	39.887	20	PASS

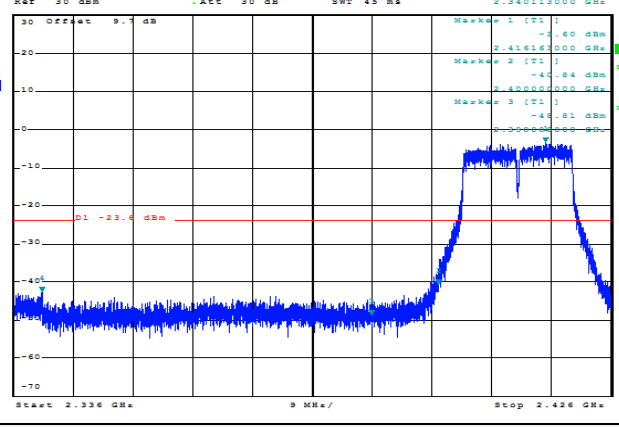
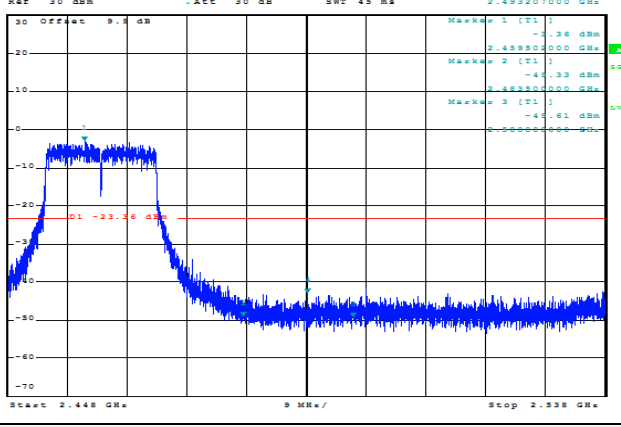
	
2412	2462

802.11n20			
Frequency (MHz)	Delta Peak to Band emission (dBc)	Limit (dBc)	Verdict
2337.908	39.806	20	PASS
2491.263	39.036	20	PASS

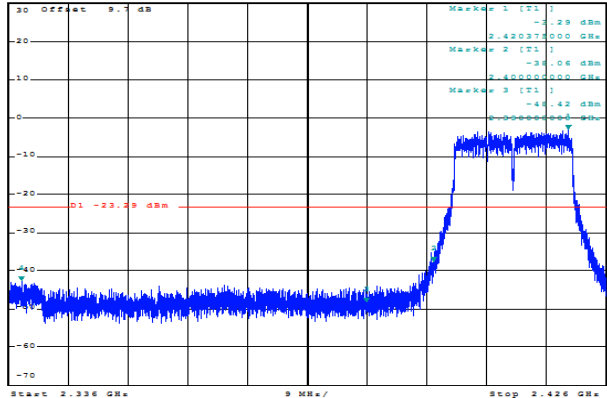
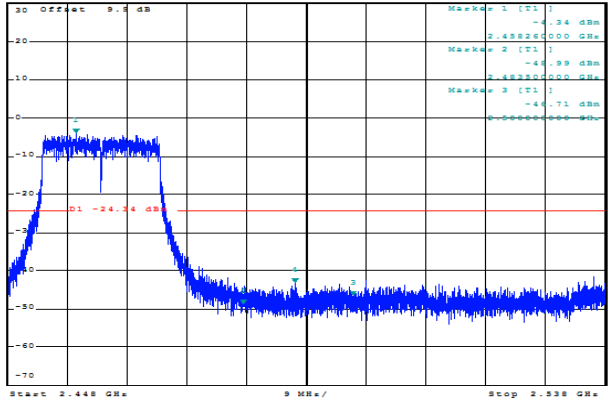
 <p>Ref: 30 dBm, Att: 30 dB, VSW: 300 kHz, SWT: 45 ms, Marker 4: -43.10 dBm, 2.337908000 GHz</p> <p>Marker 1: -2.29 dBm, 2.420370000 GHz</p> <p>Marker 2: -31.06 dBm, 2.420000000 GHz</p> <p>Marker 3: -44.42 dBm, 2.420000000 GHz</p> <p>Marker 4: -43.10 dBm, 2.337908000 GHz</p> <p>Limit: D1 -23.59 dBm</p> <p>Start: 2.336 GHz, Stop: 2.426 GHz</p>	 <p>Ref: 30 dBm, Att: 30 dB, VSW: 300 kHz, SWT: 45 ms, Marker 4: -43.38 dBm, 2.491263000 GHz</p> <p>Marker 1: -4.34 dBm, 2.488260000 GHz</p> <p>Marker 2: -44.99 dBm, 2.488260000 GHz</p> <p>Marker 3: -44.71 dBm, 2.488260000 GHz</p> <p>Marker 4: -43.38 dBm, 2.491263000 GHz</p> <p>Limit: D1 -24.34 dBm</p> <p>Start: 2.448 GHz, Stop: 2.538 GHz</p>		
2412	2462		

802.11n40			
Frequency (MHz)	Delta Peak to Band emission (dBc)	Limit (dBc)	Verdict
2357.852	35.536	20	PASS
2487.438	35.814	20	PASS

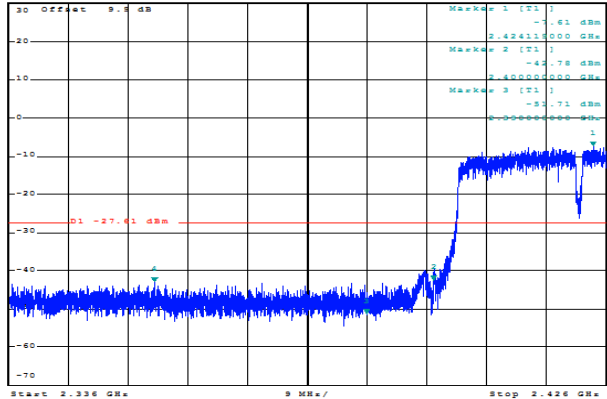
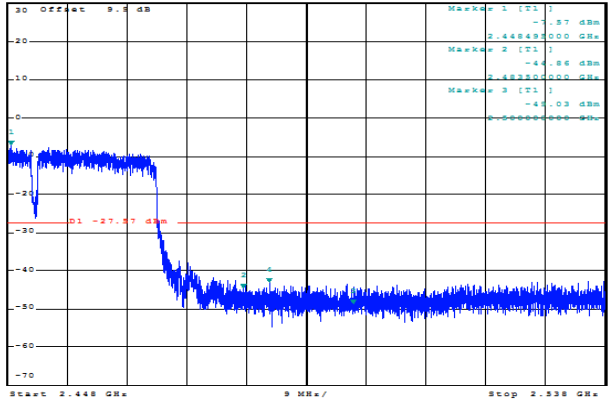
 <p>Ref: 30 dBm, Att: 30 dB, VSW: 300 kHz, SWT: 45 ms, Marker 4: -43.15 dBm, 2.357852000 GHz</p> <p>Marker 1: -1.61 dBm, 2.424110000 GHz</p> <p>Marker 2: -42.78 dBm, 2.420000000 GHz</p> <p>Marker 3: -51.71 dBm, 2.420000000 GHz</p> <p>Marker 4: -43.15 dBm, 2.357852000 GHz</p> <p>Limit: D1 -27.61 dBm</p> <p>Start: 2.336 GHz, Stop: 2.426 GHz</p>	 <p>Ref: 30 dBm, Att: 30 dB, VSW: 300 kHz, SWT: 45 ms, Marker 4: -43.38 dBm, 2.487438000 GHz</p> <p>Marker 1: -1.57 dBm, 2.488490000 GHz</p> <p>Marker 2: -44.56 dBm, 2.488260000 GHz</p> <p>Marker 3: -45.03 dBm, 2.488260000 GHz</p> <p>Marker 4: -43.38 dBm, 2.487438000 GHz</p> <p>Limit: D1 -27.67 dBm</p> <p>Start: 2.448 GHz, Stop: 2.538 GHz</p>		
2422	2452		

B. Radiated measurements

802.11b

Frequency(MHz):			2412			Polarity:			HORIZONTAL		
Frequency (MHz)	Emission Level (dBuV/m)		Limit (dBuV/m)	Margin (dB)	Antenna Height (m)	Table Angle (Degree)	Raw Value (dBuV)	Antenna Factor (dB/m)	Cable Factor (dB)	Pre-amplifier (dB)	Correction Factor (dB/m)
2390.00	54.35	PK	74.00	19.65	1.00	136	59.66	27.49	3.32	36.12	-5.31
2390.00	46.55	AV	54.00	7.45	1.00	136	51.86	27.49	3.32	36.12	-5.31
Frequency(MHz):			2412			Polarity:			VERTICAL		
Frequency (MHz)	Emission Level (dBuV/m)		Limit (dBuV/m)	Margin (dB)	Antenna Height (m)	Table Angle (Degree)	Raw Value (dBuV)	Antenna Factor (dB/m)	Cable Factor (dB)	Pre-amplifier (dB)	Correction Factor (dB/m)
2390.00	52.36	PK	74.00	21.64	1.00	172	57.67	27.49	3.32	36.12	-5.31
2390.00	41.55	AV	54.00	12.45	1.00	172	46.86	27.49	3.32	36.12	-5.31
Frequency(MHz):			2462			Polarity:			HORIZONTAL		
Frequency (MHz)	Emission Level (dBuV/m)		Limit (dBuV/m)	Margin (dB)	Antenna Height (m)	Table Angle (Degree)	Raw Value (dBuV)	Antenna Factor (dB/m)	Cable Factor (dB)	Pre-amplifier (dB)	Correction Factor (dB/m)
2483.50	54.92	PK	74.00	19.08	1.00	141	60.64	27.45	3.38	36.55	-5.72
2483.50	44.78	AV	54.00	9.22	1.00	141	50.50	27.45	3.38	36.55	-5.72
Frequency(MHz):			2462			Polarity:			VERTICAL		
Frequency (MHz)	Emission Level (dBuV/m)		Limit (dBuV/m)	Margin (dB)	Antenna Height (m)	Table Angle (Degree)	Raw Value (dBuV)	Antenna Factor (dB/m)	Cable Factor (dB)	Pre-amplifier (dB)	Correction Factor (dB/m)
2483.50	53.26	PK	74.00	20.74	1.00	162	58.98	27.45	3.38	36.55	-5.72
2483.50	42.23	AV	54.00	11.77	1.00	162	47.95	27.45	3.38	36.55	-5.72

802.11g

Frequency(MHz):			2412			Polarity:			HORIZONTAL		
Frequency (MHz)	Emission Level (dBuV/m)		Limit (dBuV/m)	Margin (dB)	Antenna Height (m)	Table Angle (Degree)	Raw Value (dBuV)	Antenna Factor (dB/m)	Cable Factor (dB)	Pre-amplifier (dB)	Correction Factor (dB/m)
2390.00	54.22	PK	74.00	19.78	1.00	131	59.53	27.49	3.32	36.12	-5.31
2390.00	44.08	AV	54.00	9.92	1.00	131	49.39	27.49	3.32	36.12	-5.31
Frequency(MHz):			2412			Polarity:			VERTICAL		
Frequency (MHz)	Emission Level (dBuV/m)		Limit (dBuV/m)	Margin (dB)	Antenna Height (m)	Table Angle (Degree)	Raw Value (dBuV)	Antenna Factor (dB/m)	Cable Factor (dB)	Pre-amplifier (dB)	Correction Factor (dB/m)
2390.00	52.39	PK	74.00	21.61	1.00	167	57.70	27.49	3.32	36.12	-5.31
2390.00	44.48	AV	54.00	9.52	1.00	167	49.79	27.49	3.32	36.12	-5.31
Frequency(MHz):			2462			Polarity:			HORIZONTAL		
Frequency (MHz)	Emission Level (dBuV/m)		Limit (dBuV/m)	Margin (dB)	Antenna Height (m)	Table Angle (Degree)	Raw Value (dBuV)	Antenna Factor (dB/m)	Cable Factor (dB)	Pre-amplifier (dB)	Correction Factor (dB/m)
2483.50	54.02	PK	74.00	19.98	1.00	141	59.74	27.45	3.38	36.55	-5.72
2483.50	42.49	AV	54.00	11.51	1.00	141	48.21	27.45	3.38	36.55	-5.72
Frequency(MHz):			2462			Polarity:			VERTICAL		
Frequency (MHz)	Emission Level (dBuV/m)		Limit (dBuV/m)	Margin (dB)	Antenna Height (m)	Table Angle (Degree)	Raw Value (dBuV)	Antenna Factor (dB/m)	Cable Factor (dB)	Pre-amplifier (dB)	Correction Factor (dB/m)
2483.50	53.59	PK	74.00	20.41	1.00	182	59.31	27.45	3.38	36.55	-5.72
2483.50	43.54	AV	54.00	10.46	1.00	182	49.26	27.45	3.38	36.55	-5.72

802.11n20

Frequency(MHz):			2412			Polarity:			HORIZONTAL		
Frequency (MHz)	Emission Level (dBuV/m)		Limit (dBuV/m)	Margin (dB)	Antenna Height (m)	Table Angle (Degree)	Raw Value (dBuV)	Antenna Factor (dB/m)	Cable Factor (dB)	Pre-amplifier (dB)	Correction Factor (dB/m)
2390.00	52.87	PK	74.00	21.13	1.00	156	58.18	27.49	3.32	36.12	-5.31
2390.00	43.83	AV	54.00	10.17	1.00	156	49.14	27.49	3.32	36.12	-5.31
Frequency(MHz):			2412			Polarity:			VERTICAL		
Frequency (MHz)	Emission Level (dBuV/m)		Limit (dBuV/m)	Margin (dB)	Antenna Height (m)	Table Angle (Degree)	Raw Value (dBuV)	Antenna Factor (dB/m)	Cable Factor (dB)	Pre-amplifier (dB)	Correction Factor (dB/m)
2390.00	53.72	PK	74.00	20.28	1.00	184	59.03	27.49	3.32	36.12	-5.31
2390.00	44.49	AV	54.00	9.51	1.00	184	49.80	27.49	3.32	36.12	-5.31
Frequency(MHz):			2462			Polarity:			HORIZONTAL		
Frequency (MHz)	Emission Level (dBuV/m)		Limit (dBuV/m)	Margin (dB)	Antenna Height (m)	Table Angle (Degree)	Raw Value (dBuV)	Antenna Factor (dB/m)	Cable Factor (dB)	Pre-amplifier (dB)	Correction Factor (dB/m)
2483.50	54.14	PK	74.00	19.86	1.00	151	59.86	27.45	3.38	36.55	-5.72
2483.50	43.05	AV	54.00	10.95	1.00	151	48.77	27.45	3.38	36.55	-5.72
Frequency(MHz):			2462			Polarity:			VERTICAL		
Frequency (MHz)	Emission Level (dBuV/m)		Limit (dBuV/m)	Margin (dB)	Antenna Height (m)	Table Angle (Degree)	Raw Value (dBuV)	Antenna Factor (dB/m)	Cable Factor (dB)	Pre-amplifier (dB)	Correction Factor (dB/m)
2483.50	53.83	PK	74.00	20.17	1.00	192	59.55	27.45	3.38	36.55	-5.72
2483.50	43.96	AV	54.00	10.04	1.00	192	49.68	27.45	3.38	36.55	-5.72

802.11n40

Frequency(MHz):			2422			Polarity:			HORIZONTAL		
Frequency (MHz)	Emission Level (dBuV/m)		Limit (dBuV/m)	Margin (dB)	Antenna Height (m)	Table Angle (Degree)	Raw Value (dBuV)	Antenna Factor (dB/m)	Cable Factor (dB)	Pre-amplifier (dB)	Correction Factor (dB/m)
2390.00	52.52	PK	74.00	21.48	1.00	156	57.83	27.49	3.32	36.12	-5.31
2390.00	42.02	AV	54.00	11.98	1.00	156	47.33	27.49	3.32	36.12	-5.31
Frequency(MHz):			2422			Polarity:			VERTICAL		
Frequency (MHz)	Emission Level (dBuV/m)		Limit (dBuV/m)	Margin (dB)	Antenna Height (m)	Table Angle (Degree)	Raw Value (dBuV)	Antenna Factor (dB/m)	Cable Factor (dB)	Pre-amplifier (dB)	Correction Factor (dB/m)
2390.00	50.28	PK	74.00	23.72	1.00	184	55.59	27.49	3.32	36.12	-5.31
2390.00	42.32	AV	54.00	11.68	1.00	184	47.63	27.49	3.32	36.12	-5.31
Frequency(MHz):			2452			Polarity:			HORIZONTAL		
Frequency (MHz)	Emission Level (dBuV/m)		Limit (dBuV/m)	Margin (dB)	Antenna Height (m)	Table Angle (Degree)	Raw Value (dBuV)	Antenna Factor (dB/m)	Cable Factor (dB)	Pre-amplifier (dB)	Correction Factor (dB/m)
2483.50	52.19	PK	74.00	21.81	1.00	151	57.91	27.45	3.38	36.55	-5.72
2483.50	39.87	AV	54.00	14.13	1.00	151	45.59	27.45	3.38	36.55	-5.72
Frequency(MHz):			2452			Polarity:			VERTICAL		
Frequency (MHz)	Emission Level (dBuV/m)		Limit (dBuV/m)	Margin (dB)	Antenna Height (m)	Table Angle (Degree)	Raw Value (dBuV)	Antenna Factor (dB/m)	Cable Factor (dB)	Pre-amplifier (dB)	Correction Factor (dB/m)
2483.50	52.39	PK	74.00	21.61	1.00	192	58.11	27.45	3.38	36.55	-5.72
2483.50	40.3	AV	54.00	13.70	1.00	192	46.02	27.45	3.38	36.55	-5.72

3.7 Spurious RF Conducted Emission

Limit

1. Below -20dB of the highest emission level in operating band.
2. Fall in the restricted bands listed in section 15.205. The maximum permitted average field strength is listed in section 15.209.

Test Procedure

The transmitter output was connected to the spectrum analyzer through a low loss RF cable. Spurious RF Conducted Emission was measured by spectrum analyzer with 100 KHz RBW and 300KHz VBW, measurement frequency range from 30MHz to 26.5GHz.

Test Configuration

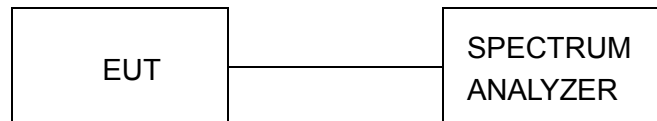

Test Results

Remark: The measurement frequency range is from 30MHz to the 10th harmonic of the fundamental frequency. The lowest, middle and highest channels are tested to verify the spurious emissions and bandage measurement data.

Test plot as follows:

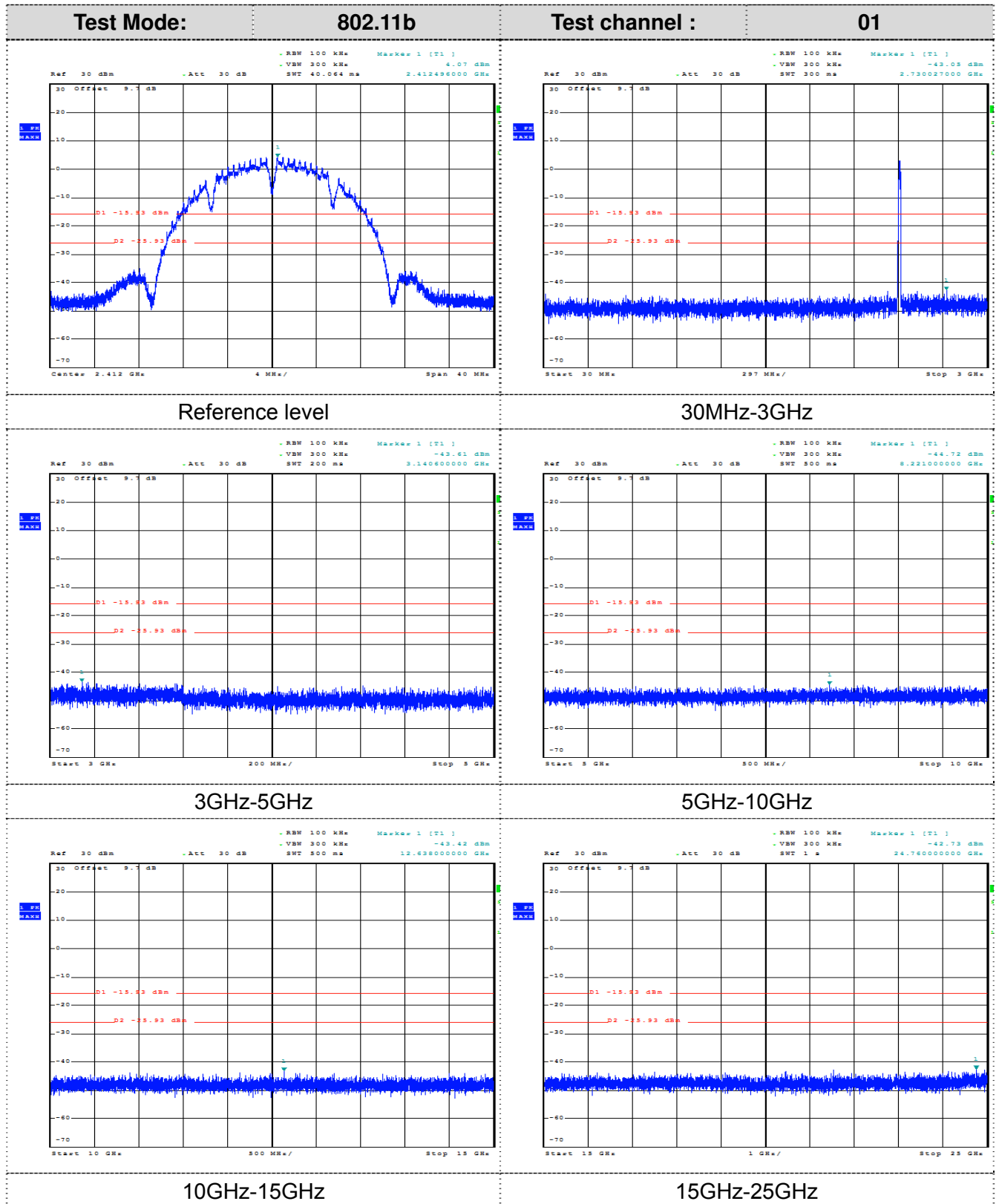

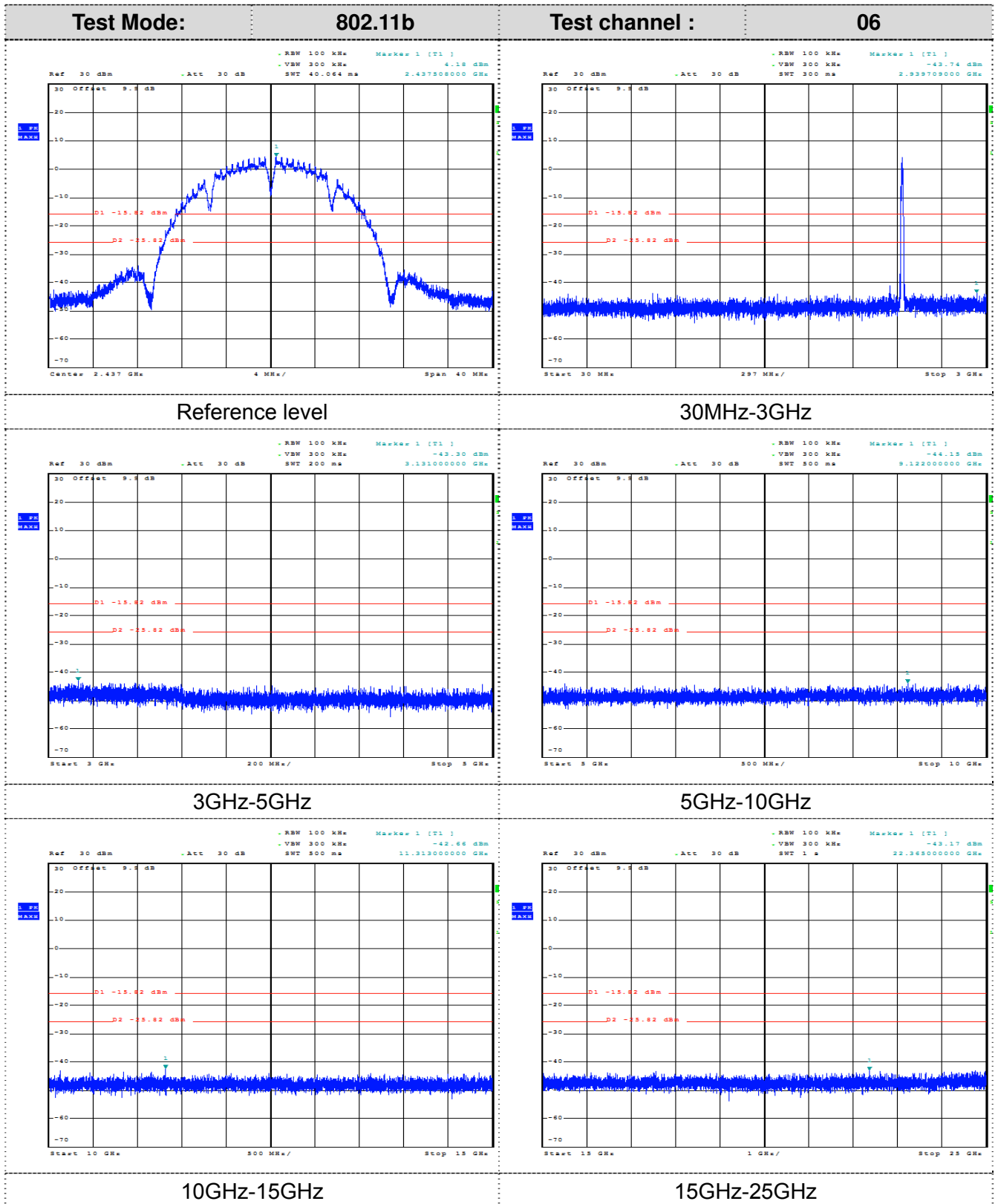

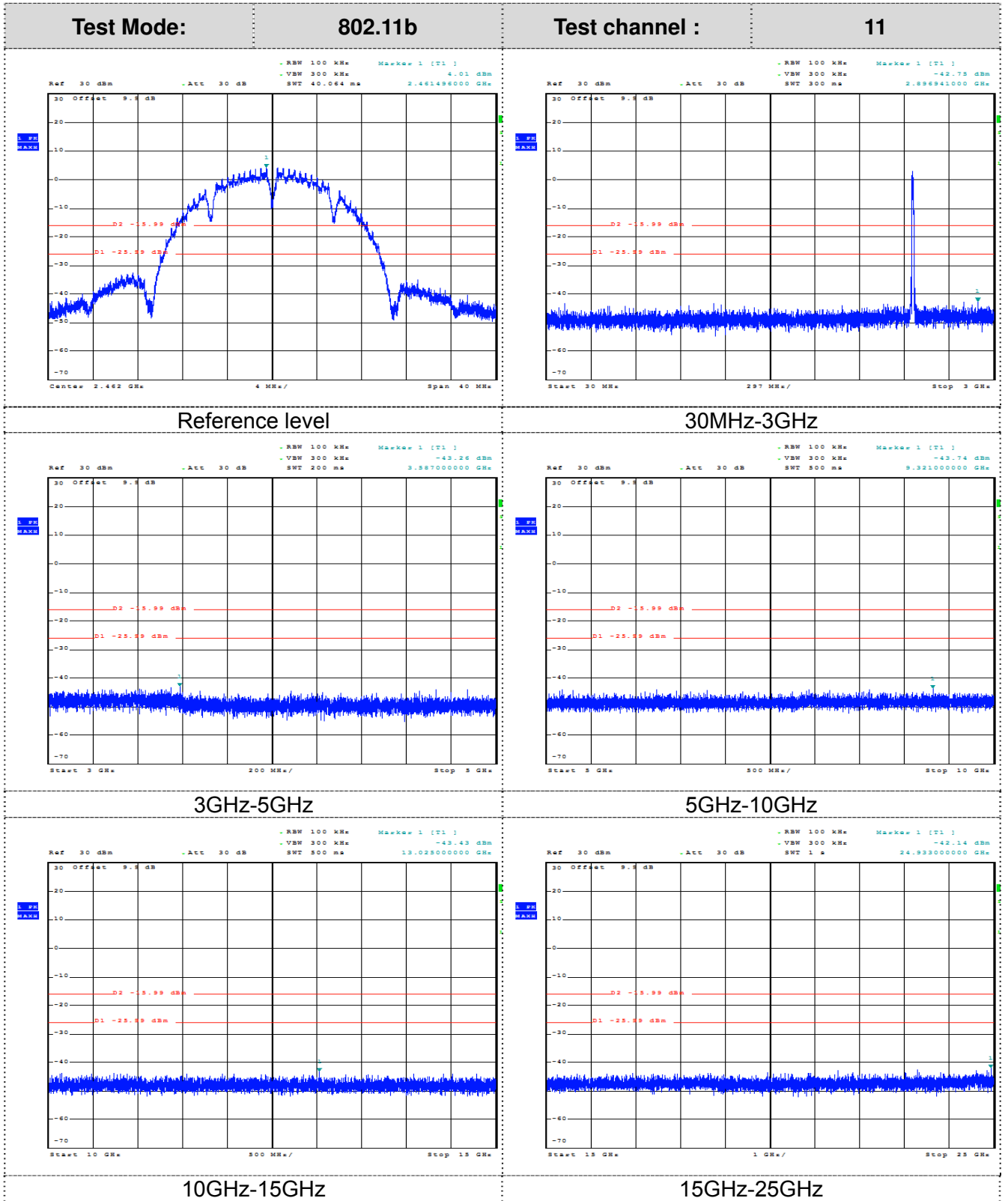

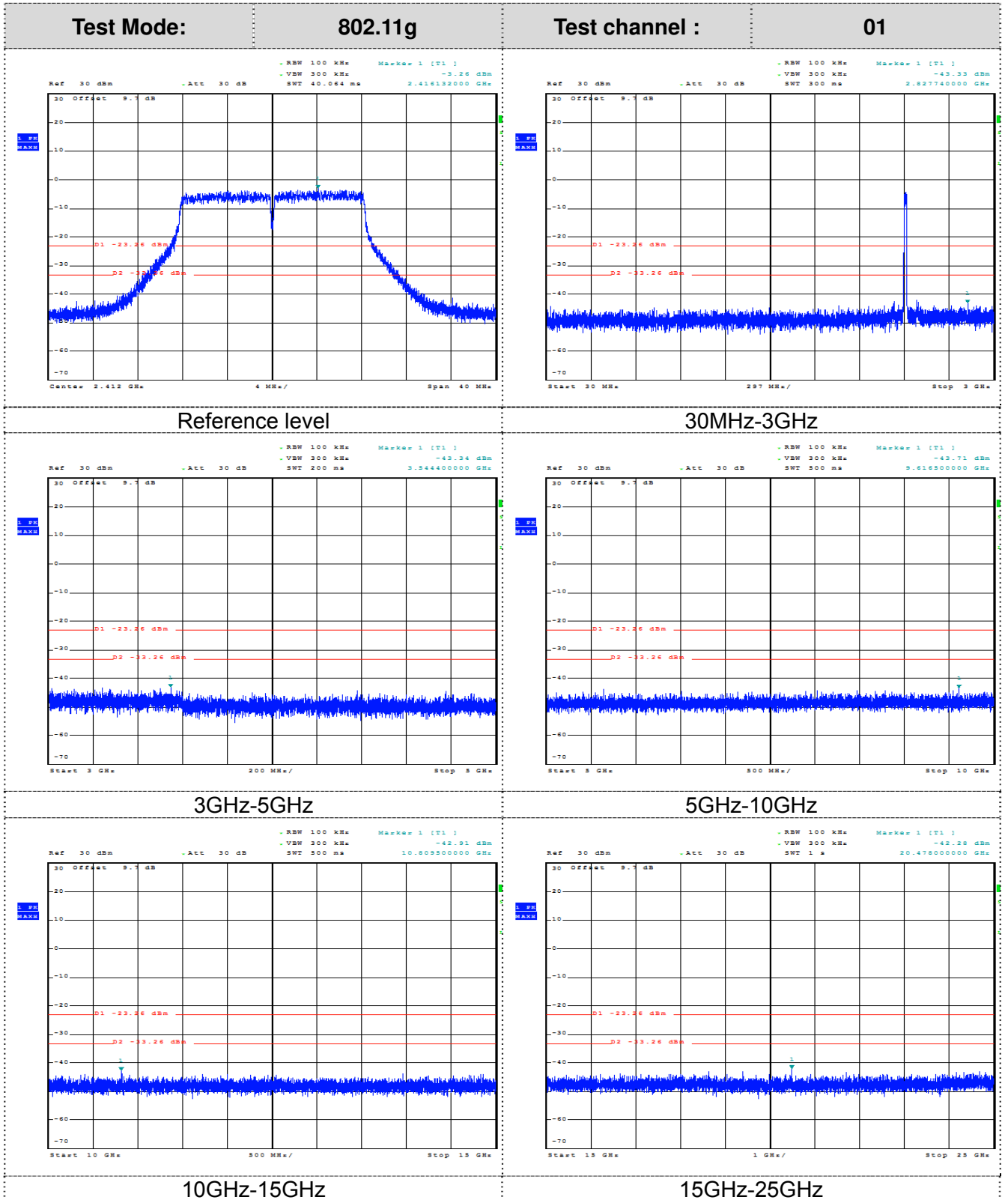

Test Mode:

802.11g

Test channel :

06

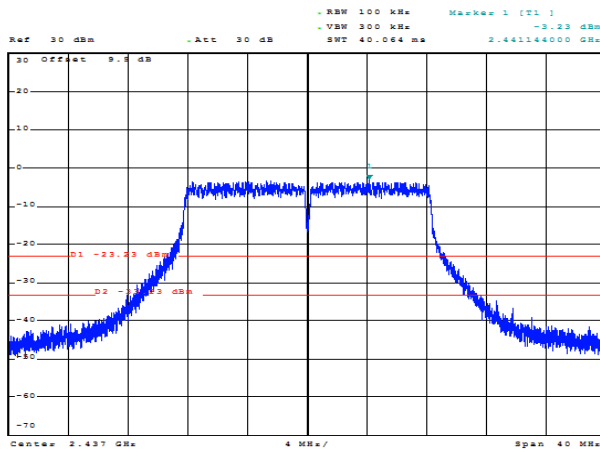

Reference level

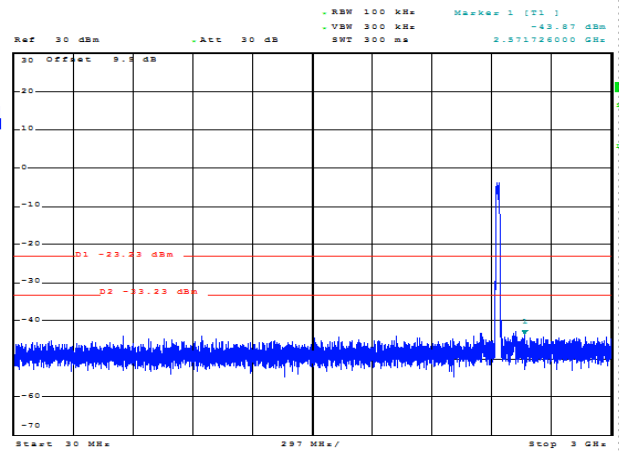

30MHz-3GHz

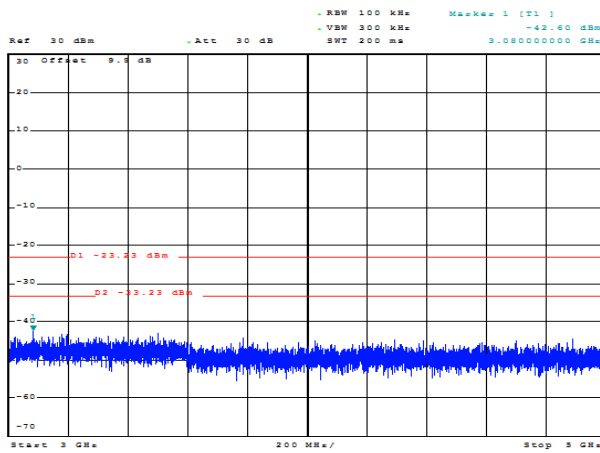

3GHz-5GHz

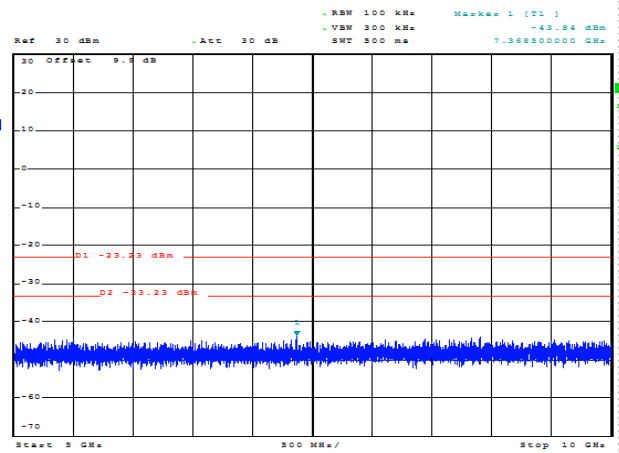

5GHz-10GHz

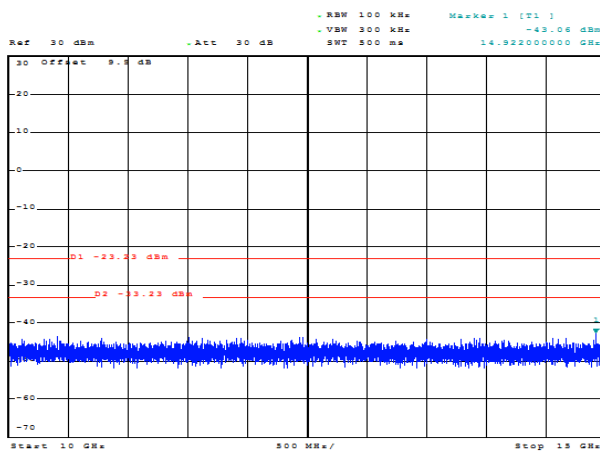

10GHz-15GHz

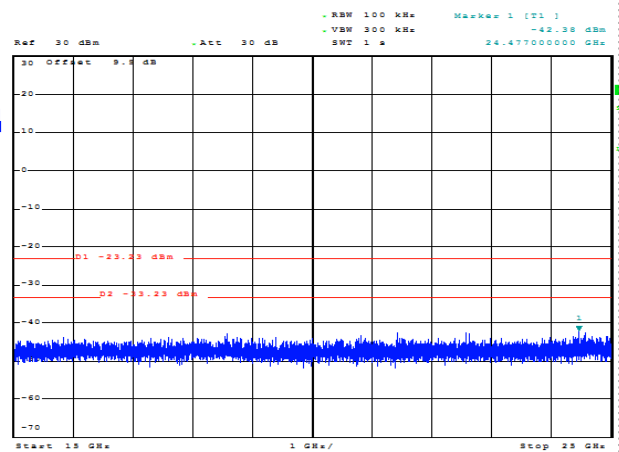

15GHz-25GHz

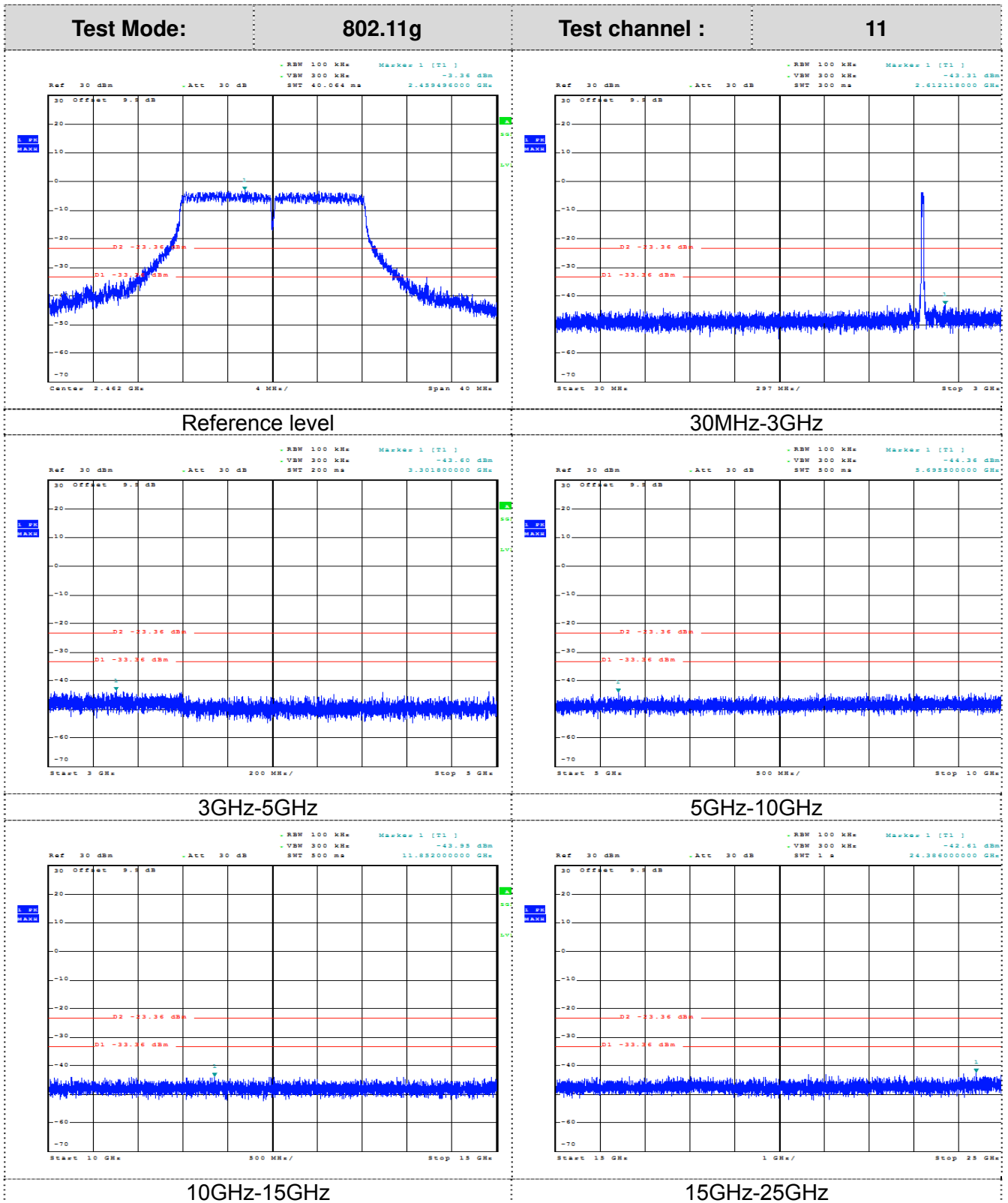

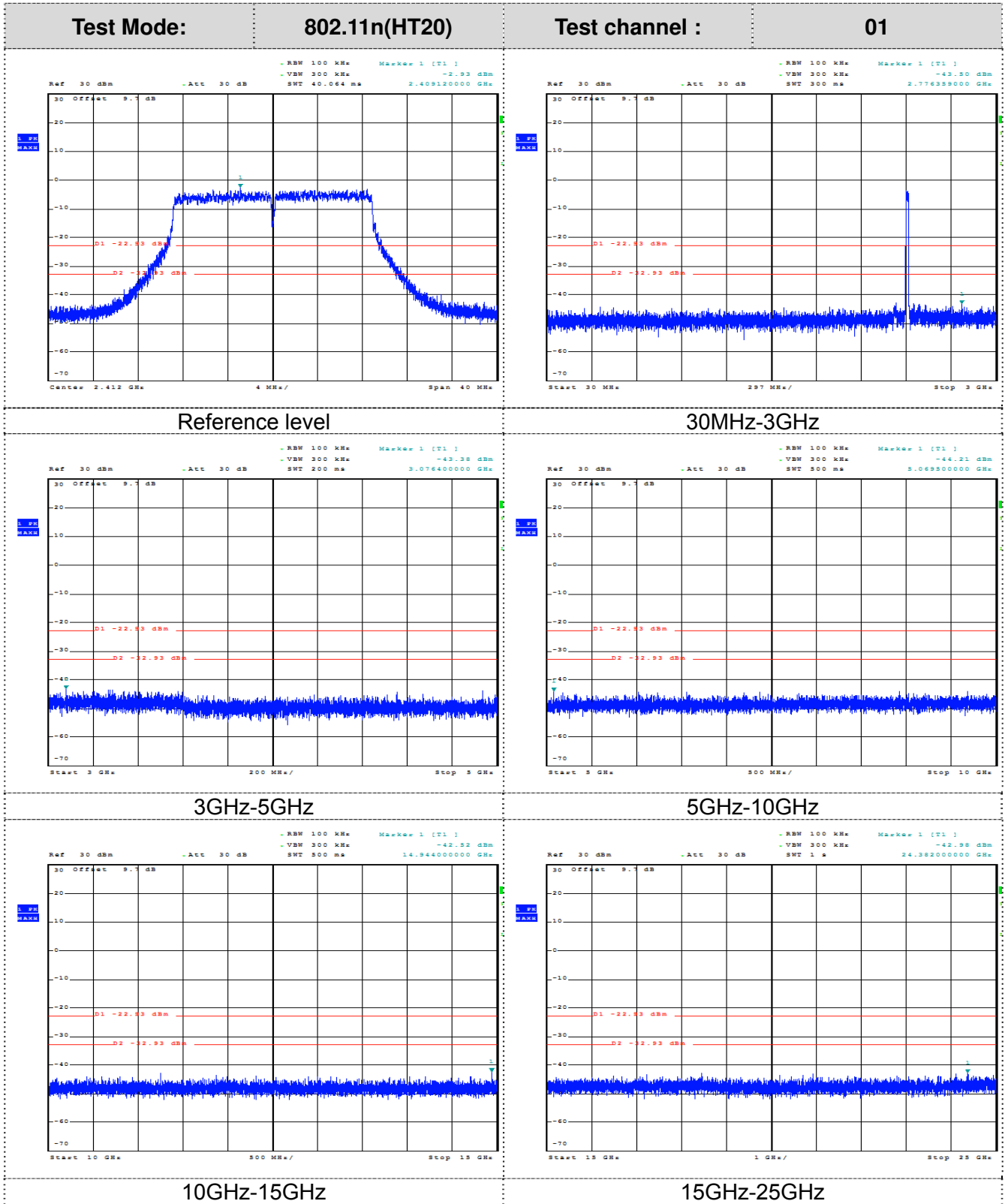

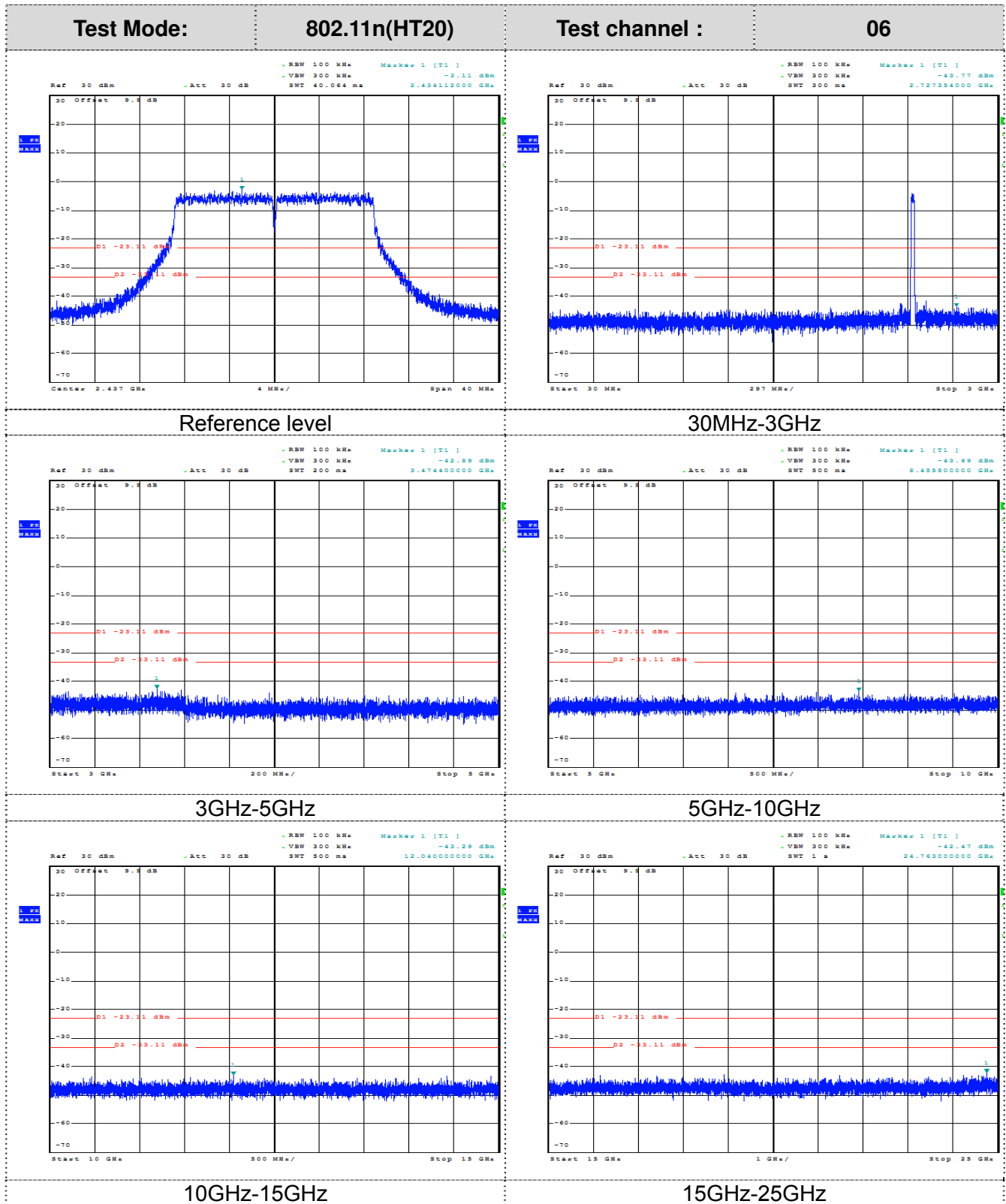

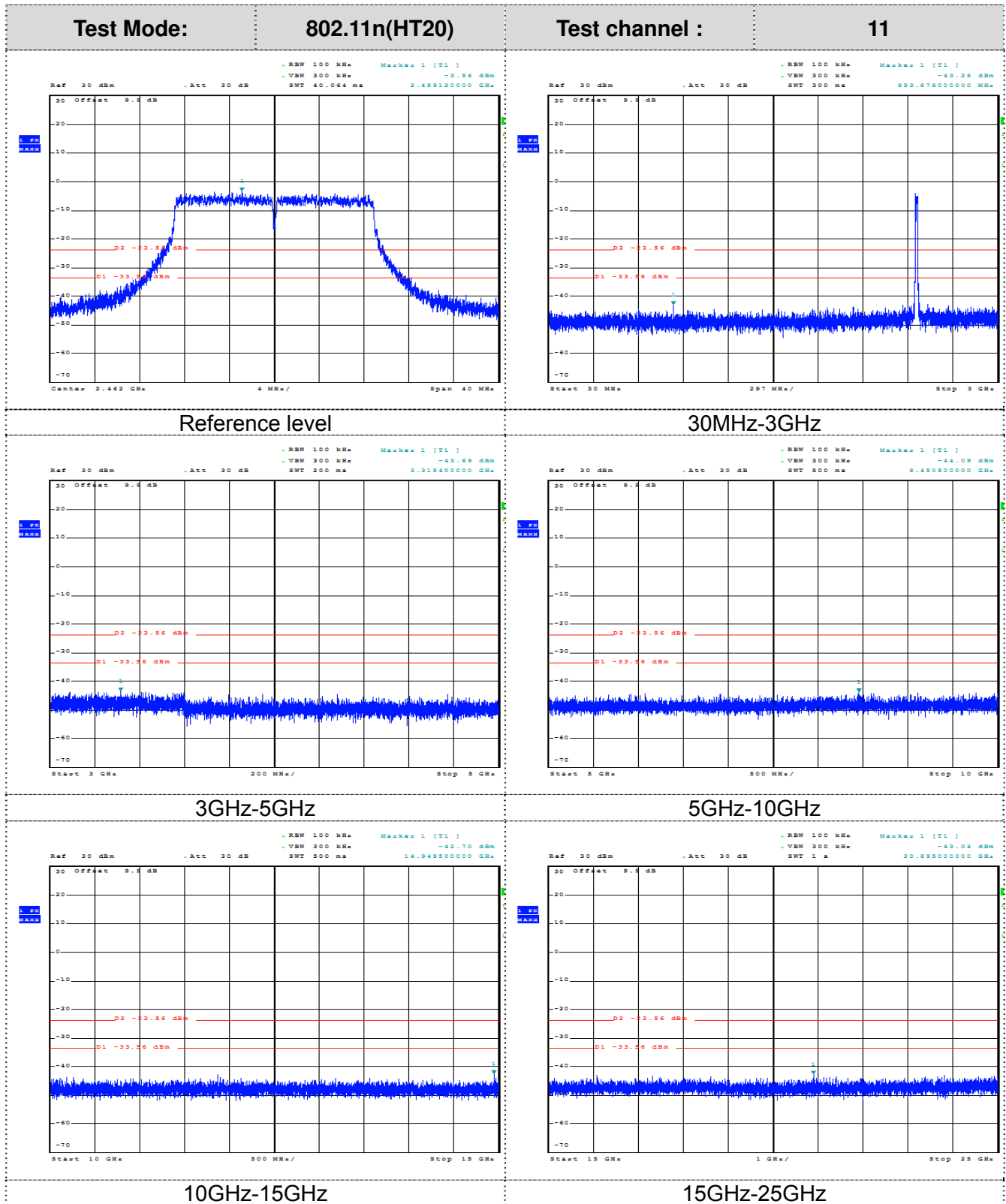

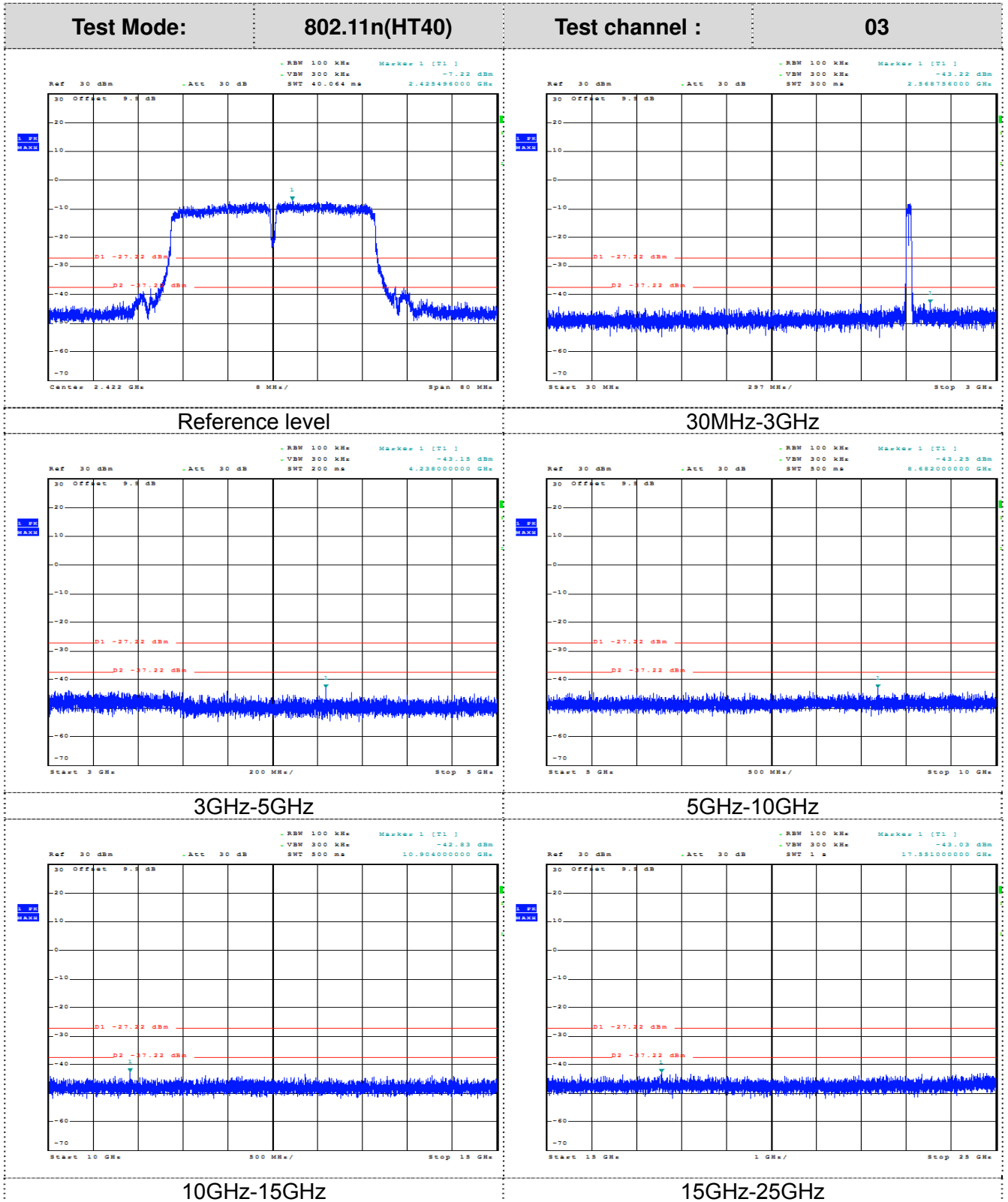

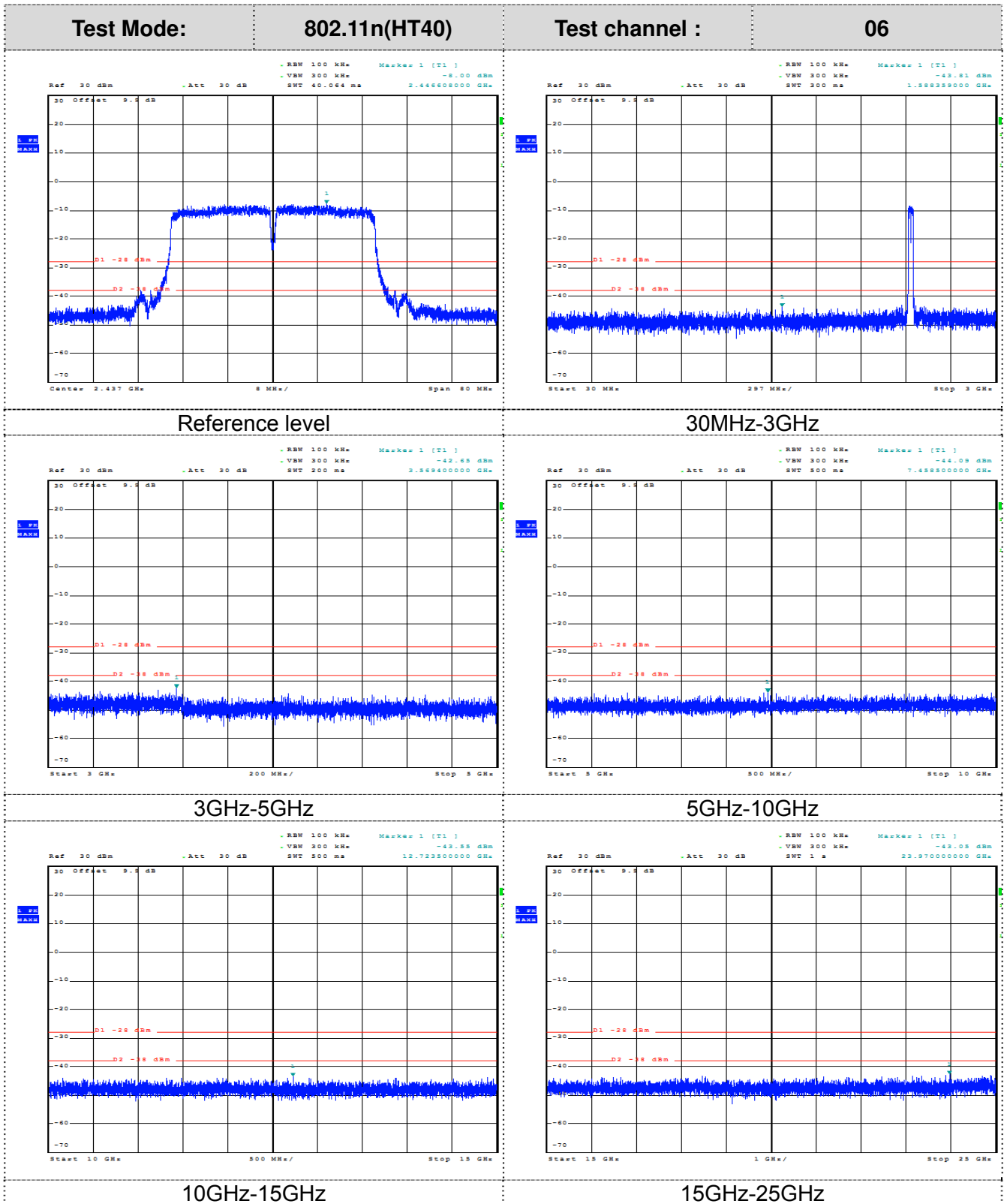

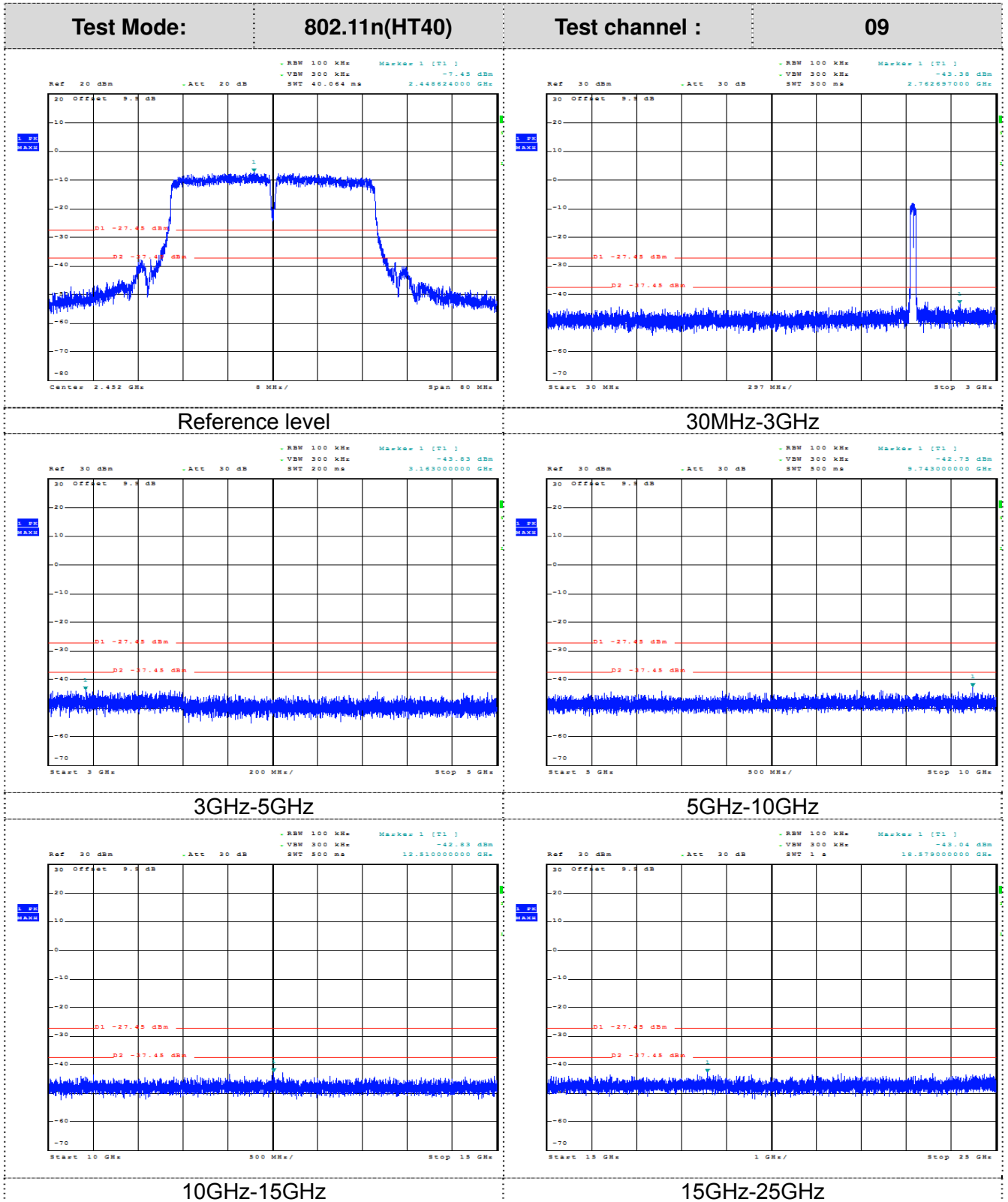

3.8 Antenna Requirement

Standard Applicable

For intentional device, according to FCC 47 CFR Section 15.203:

An intentional radiator shall be designed to ensure that no antenna other than that furnished by the responsible party shall be used with the device. The use of a permanently attached antenna or of an antenna that uses a unique coupling to the intentional radiator, the manufacturer may design the unit so that a broken antenna can be replaced by the user, but the use of a standard antenna jack or electrical connector is prohibited

FCC CFR Title 47 Part 15 Subpart C Section 15.247(c) (1) (I):

(i) Systems operating in the 2400-2483.5 MHz band that is used exclusively for fixed. Point-to-point operations may employ transmitting antennas with directional gain greater than 6dBi provided the maximum conducted output power of the intentional radiator is reduced by 1 dB for every 3 dB that the directional gain of the antenna exceeds 6dBi.

Test Result:

The maximum gain of WIFI antenna was 2.0dBi.

Antenna Style: Monopole Antenna, Antenna port: ipex

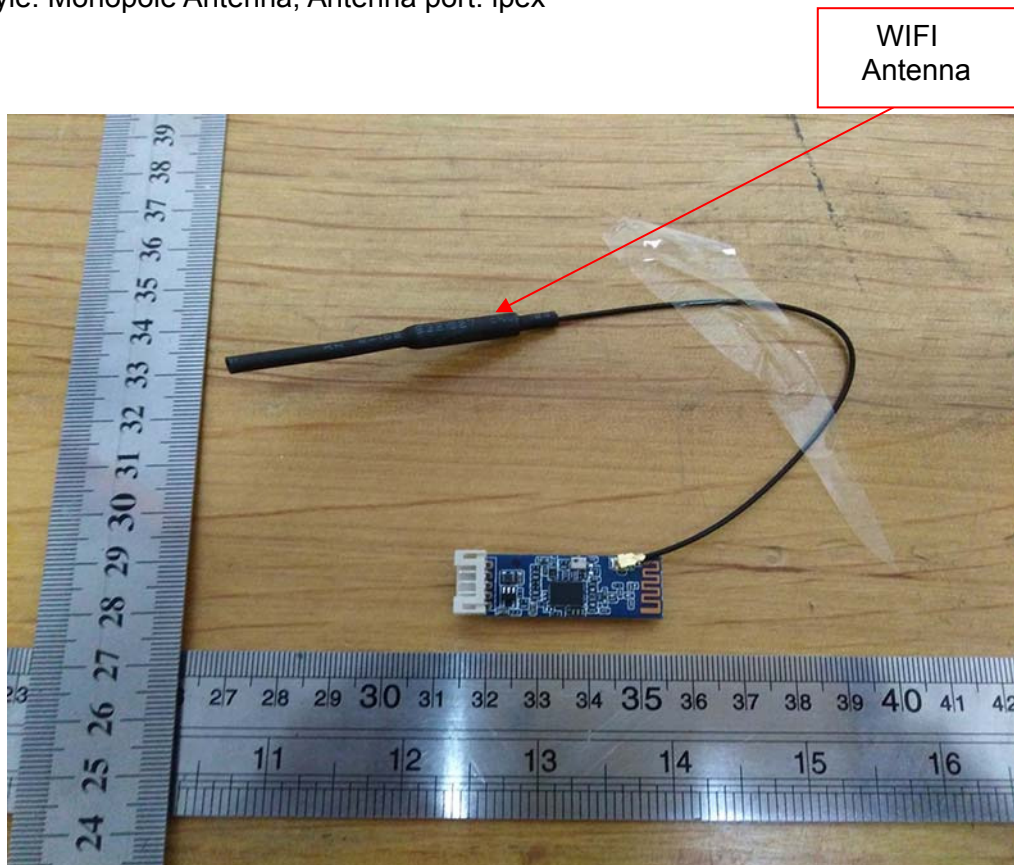

4 EUT TEST PHOTO

Radiated Emission (30MHz-1GHz)

Ancillary equipment

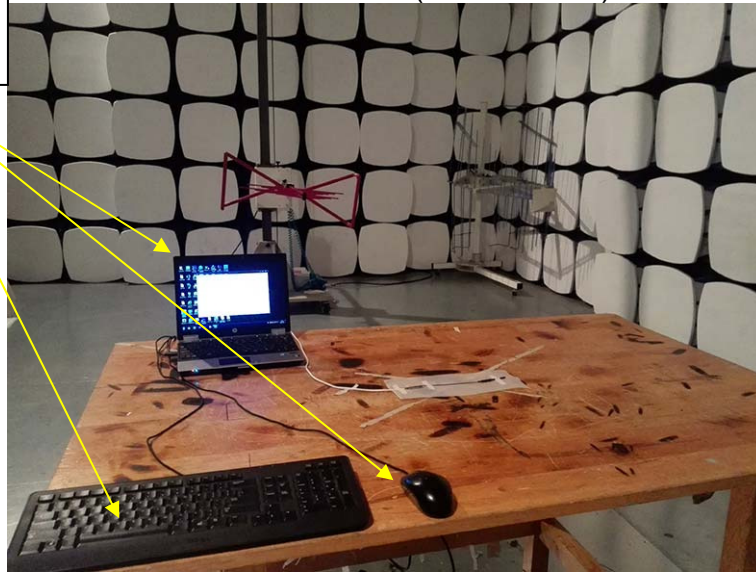

EUT

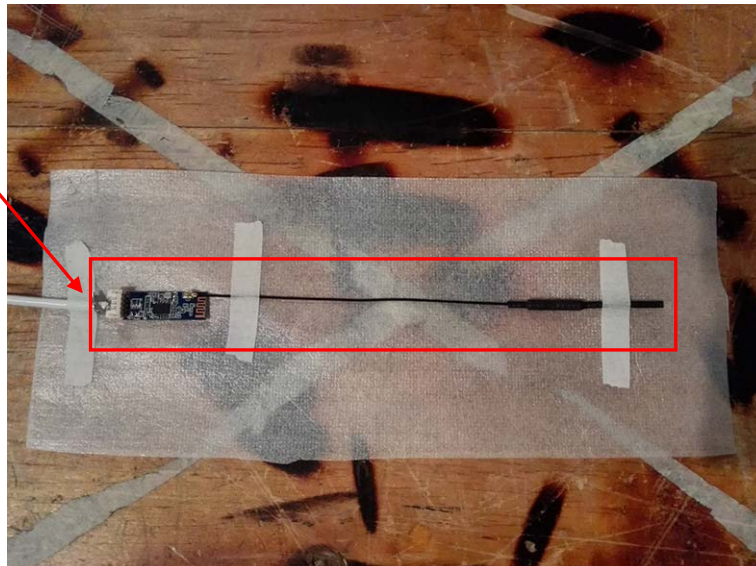

Radiated Emission (1GHz-25GHz)



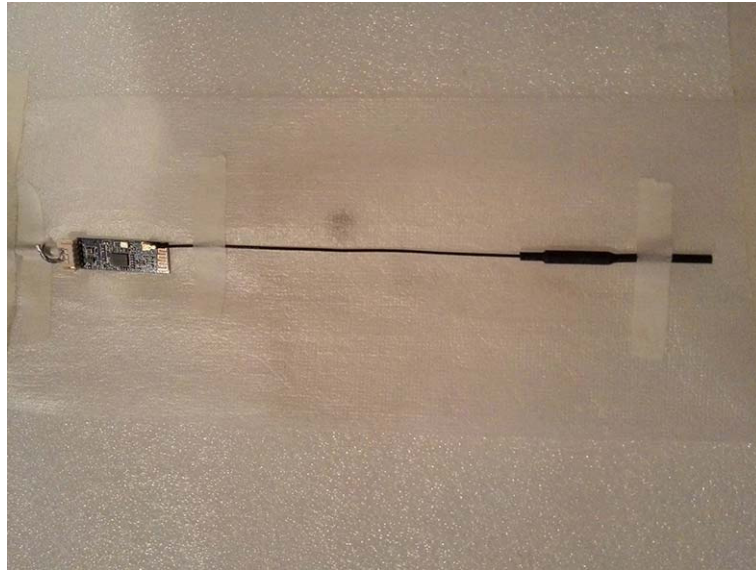

Conducted Emission

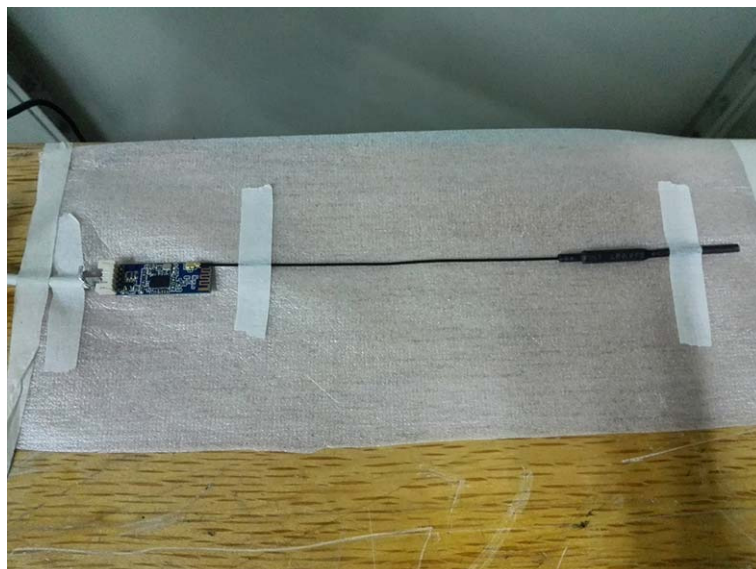

5 PHOTOGRAPHS OF EUT CONSTRUCTIONAL

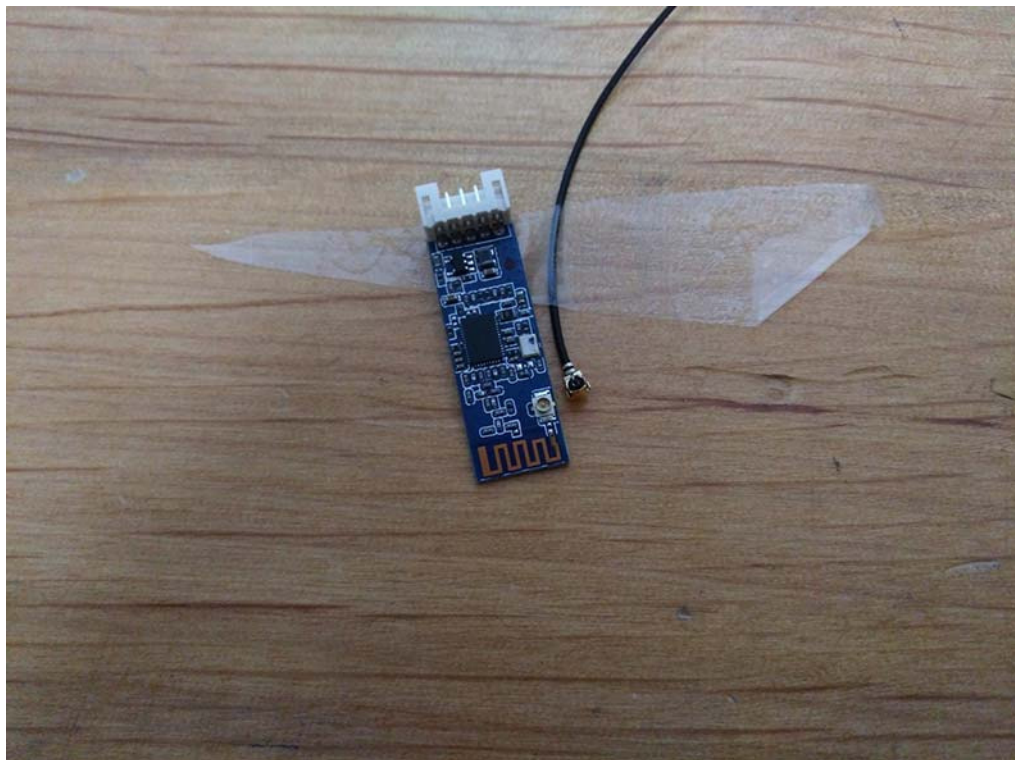
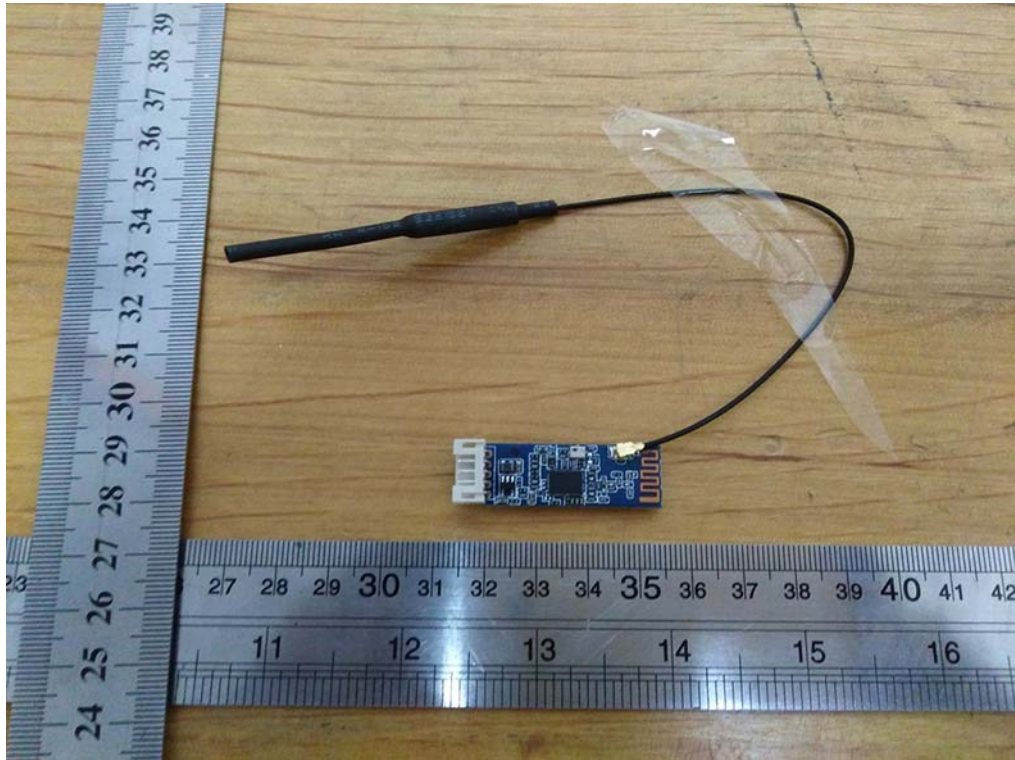

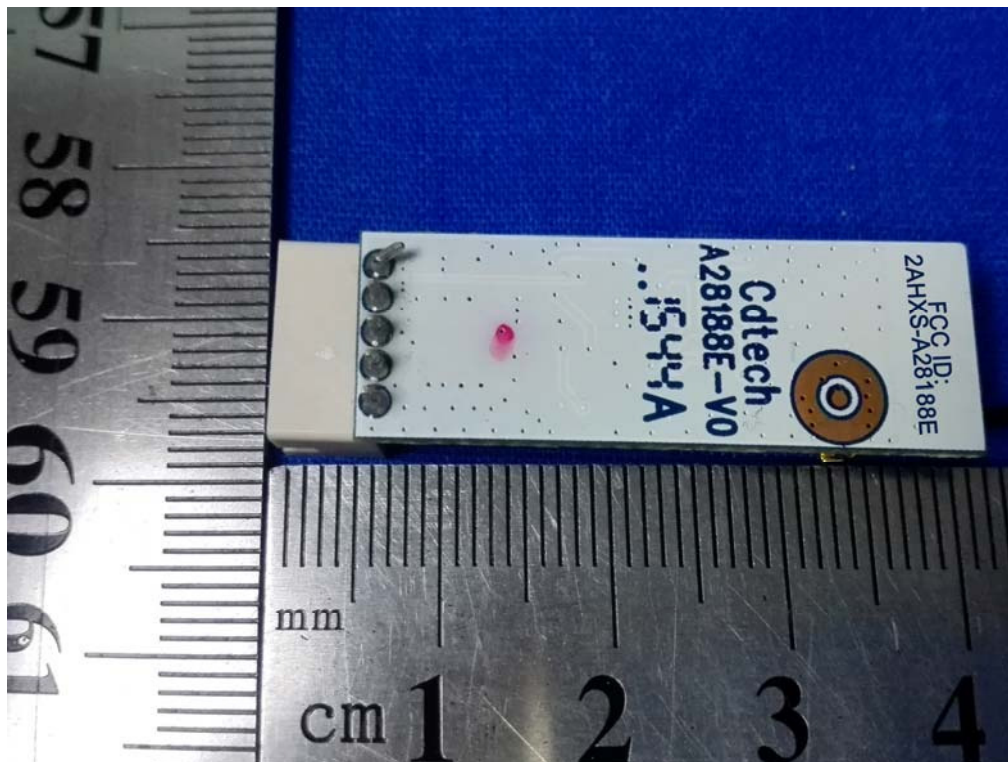
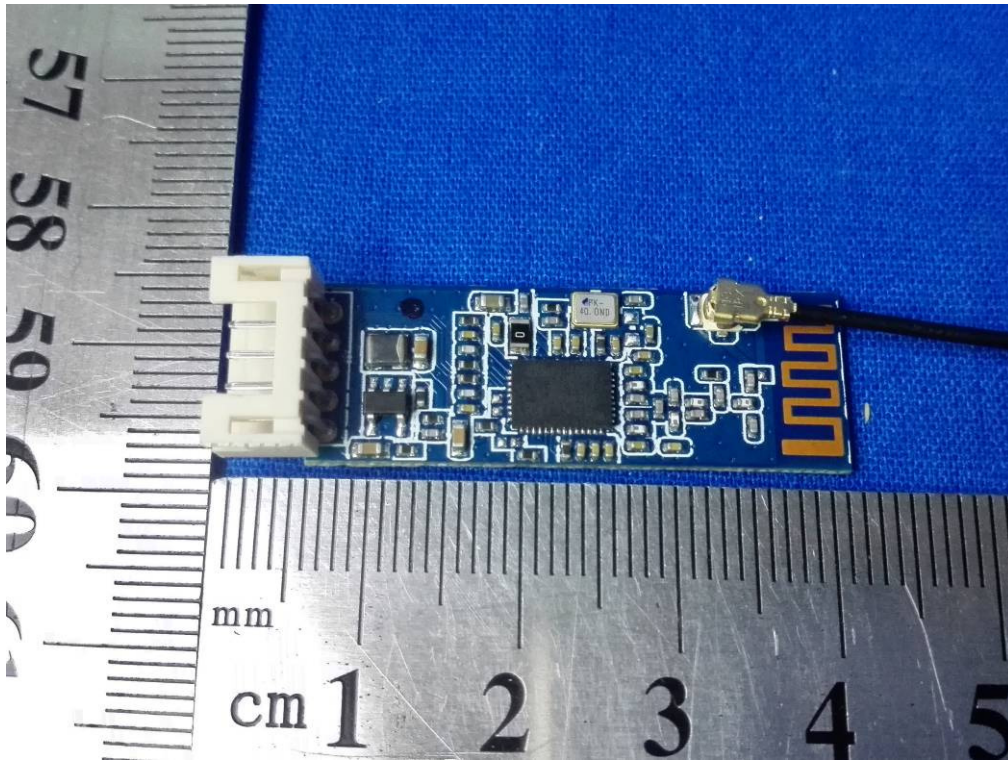

*****THE END*****