



RADIO TEST REPORT

FCC ID: 2AHXO-T4016

Product: 4inch 3G Dual SIM Smart phone

Trade Name: N/A

Model No.: T4016

Serial Model: RLTP4028-B-BLACK,A1,A2,A3,A4,A6,K2,
K3,K4,C1,C3,G4,G5,G6

Report No.: NTEK- 2016NT04155188F1

Issue Date: 07 May. 2016

Prepared for

SHENZHEN IDWELL TECHNOLOGY CO.,LTD.
BUILDING A2,ZHENG FENG INDUSTRIAL PARK, FENGTANG
ROAD, FUYONG, BAOAN, SHENZHEN, CHINA

Prepared by

NTEK TESTING TECHNOLOGY CO., LTD.
1/F, Building E, Fenda Science Park, Sanwei Community,
Xixiang Street Bao'an District, Shenzhen, P.R. China
Tel.: +86-0755-61156588
Fax.: +86-0755-61156599
Website: www.ntek.org.cn

TABLE OF CONTENTS

1	TEST RESULT CERTIFICATION	3
2	SUMMARY OF TEST RESULTS.....	4
3	FACILITIES AND ACCREDITATIONS	5
3.1	FACILITIES.....	5
3.2	LABORATORY ACCREDITATIONS AND LISTINGS	5
3.3	MEASUREMENT UNCERTAINTY	5
4	GENERAL DESCRIPTION OF EUT	6
5	DESCRIPTION OF TEST MODES	8
6	SETUP OF EQUIPMENT UNDER TEST	9
6.1	BLOCK DIAGRAM CONFIGURATION OF TEST SYSTEM.....	9
6.2	SUPPORT EQUIPMENT.....	10
6.3	EQUIPMENTS LIST FOR ALL TEST ITEMS.....	11
7	TEST REQUIREMENTS	12
7.1	CONDUCTED EMISSIONS TEST	12
7.2	RADIATED SPURIOUS EMISSION	13
7.3	6DB BANDWIDTH.....	25
7.4	DUTY CYCLE.....	28
7.5	PEAK OUTPUT POWER	30
7.6	POWER SPECTRAL DENSITY	33
7.7	CONDUCTED BAND EDGE MEASUREMENT.....	37
7.8	ANTENNA APPLICATION	39



1 TEST RESULT CERTIFICATION

Applicant's name	ShenZhen IDWELL Technology CO.,Ltd.
Address	Building A2,Zhengfeng Industrial Park, Fengtang Road, Fuyong, Baoan, Shenzhen, China
Manufacture's Name	ShenZhen IDWELL Technology CO.,Ltd.
Address	Building A2,Zhengfeng Industrial Park, Fengtang Road, Fuyong, Baoan, Shenzhen, China
Product description	
Product name	4inch 3G Dual SIM Smart phone
Model and/or type reference	T4016
Serial Model	RLTP4028-B-BLACK,A1,A2,A3,A4,A6,K2, K3,K4,C1,C3,G4,G5,G6

Measurement Procedure Used:

APPLICABLE STANDARDS	
APPLICABLE STANDARD/ TEST PROCEDURE	TEST RESULT
FCC 47 CFR Part 2, Subpart J:2015 FCC 47 CFR Part 15, Subpart C:2015 KDB 174176 D01 Line Conducted FAQ v01r01 ANSI C63.10-2013 FCC KDB 558074 D01 DTS Meas Guidance v03r04	Complied

This device described above has been tested by NTEK Testing Technology Co., Ltd., and the test results show that the equipment under test (EUT) is in compliance with the FCC requirements. And it is applicable only to the tested sample identified in the report.

This report shall not be reproduced except in full, without the written approval of NTEK Testing Technology Co., Ltd., this document may be altered or revised by NTEK Testing Technology Co., Ltd., personnel only, and shall be noted in the revision of the document.

The test results of this report relate only to the tested sample identified in this report.

Date of Test : 15 Apr. 2016 ~ 07 May.2016

Testing Engineer : Jack Li
(Jack Li)

Technical Manager : Jason Chen
(Jason Chen)

Authorized Signatory : Sam. Chen
(Sam Chen)

2 SUMMARY OF TEST RESULTS

FCC Part15 (15.247), Subpart C			
Standard Section	Test Item	Verdict	Remark
15.207	Conducted Emission	PASS	
15.247 (a)(2)	6dB Bandwidth	PASS	
15.247 (b)	Peak Output Power	PASS	
15.247 (c)	Radiated Spurious Emission	PASS	
15.247 (d)	Power Spectral Density	PASS	
15.205	Band Edge Emission	PASS	
15.203	Antenna Requirement	PASS	

Remark:

1. "N/A" denotes test is not applicable in this Test Report.
2. All test items were verified and recorded according to the standards and without any deviation during the test.
3. This EUT has also been tested and complied with the requirements of FCC Part 15, Subpart B, recorded in a separate test report.

3 FACILITIES AND ACCREDITATIONS

3.1 FACILITIES

All measurement facilities used to collect the measurement data are located at 1/F, Building E, Fenda Science Park, Sanwei Community, Xixiang Street, Bao'an District, Shenzhen P.R. China.

The sites are constructed in conformance with the requirements of ANSI C63.7, ANSI C63.10 and CISPR Publication 22.

3.2 LABORATORY ACCREDITATIONS AND LISTINGS

Site Description

EMC Lab. : Accredited by CNAS, 2014.09.04
 The certificate is valid until 2017.09.03
 The Laboratory has been assessed and proved to be in compliance with CNAS-CL01:2006 (identical to ISO/IEC 17025:2005)
 The Certificate Registration Number is L5516.

Accredited by Industry Canada, August 29, 2012
 The Certificate Registration Number is 9270A-1.

Accredited by FCC, September 6, 2013
 The Certificate Registration Number is 238937.

Name of Firm : NTEK Testing Technology Co., Ltd
 Site Location : 1/F, Building E, Fenda Science Park, Sanwei Community, Xixiang Street, Bao'an District, Shenzhen P.R. China.

3.3 MEASUREMENT UNCERTAINTY

The reported uncertainty of measurement $y \pm U$, where expanded uncertainty U is based on a standard uncertainty multiplied by a coverage factor of $k=2$, providing a level of confidence of approximately 95 %.

No.	Item	Uncertainty
1	Conducted Emission Test	$\pm 1.38\text{dB}$
2	RF power, conducted	$\pm 0.16\text{dB}$
3	Spurious emissions, conducted	$\pm 0.21\text{dB}$
4	All emissions, radiated(<1G)	$\pm 4.68\text{dB}$
5	All emissions, radiated(>1G)	$\pm 4.89\text{dB}$
6	Temperature	$\pm 0.5^\circ\text{C}$
7	Humidity	$\pm 2\%$

4 GENERAL DESCRIPTION OF EUT

Product Feature and Specification	
Equipment	4inch 3G Dual SIM Smart phone
Trade Name	N/A
FCC ID	2AHXO-T4016
Model No.	T4016
Serial Model	RLTP4028-B-BLACK,A1,A2,A3,A4,A6,K2, K3,K4,C1,C3,G4,G5,G6
Model Difference	All the model are the same circuit and RF module,except the model No.and colour.
Operating Frequency	2402MHz~2480MHz
Modulation	GFSK
Number of Channels	40 Channels
Antenna Type	FPCB Antenna
Antenna Gain	1 dBi
Power supply	<input checked="" type="checkbox"/> DC supply: DC 3.7V/1400mAh from Li-ion Battery or DC 5V from USB Port.
	<input checked="" type="checkbox"/> Adapter supply: Model: K-T50501000U1 Input: 100-240V~, 50/60Hz, 0.15A MAX Output: 5.0V---1000mA
HW Version	Y809_MB_V2
SW Version	Y809.JH.T4016.MINT.B1B2B5.4+4.5.1.2016.03.30

Note: Based on the application, features, or specification exhibited in User's Manual, the EUT is considered as an ITE/Computing Device. More details of EUT technical specification, please refer to the User's Manual.

5 DESCRIPTION OF TEST MODES

To investigate the maximum EMI emission characteristics generated from EUT, the test system was pre-scanning tested based on the consideration of following EUT operation mode or test configuration mode which possibly have effect on EMI emission level. Each of these EUT operation mode(s) or test configuration mode(s) mentioned above was evaluated respectively.

The Transmitter was operated in the normal operating mode. The TX frequency was fixed which was for the purpose of the measurements.

Test of channel included the lowest and middle and highest frequency to perform the test, then record on this report.

Those data rates (1Mbps for GFSK modulation) were used for all test.

The EUT was pretested with 3 orientations placed on the table for the radiated emission measurement –X, Y, and Z-plane. The Y-plane results were found as the worst case and were shown in this report.

Carrier Frequency and Channel list:

Channel	Frequency(MHz)
0	2402
1	2404
...	...
19	2440
20	2442
...	...
38	2478
39	2480

Note: $fc=2402MHz+k \times 2MHz$ $k=0$ to 39

The following summary table is showing all test modes to demonstrate in compliance with the standard.

Test Cases	
Test Item	Data Rate/ Modulation
	Bluetooth 4.0_LE / GFSK
AC Conducted Emission	Mode 1: normal link mode
Radiated Test Cases	Mode 2: Bluetooth Tx Ch00_2402MHz_1Mbps
	Mode 3: Bluetooth Tx Ch19_2440MHz_1Mbps
	Mode 4: Bluetooth Tx Ch39_2480MHz_1Mbps
Conducted Test Cases	Mode 2: Bluetooth Tx Ch00_2402MHz_1Mbps
	Mode 3: Bluetooth Tx Ch19_2440MHz_1Mbps
	Mode 4: Bluetooth Tx Ch39_2480MHz_1Mbps

Note:

1. The engineering test program was provided and the EUT was programmed to be in continuously transmitting mode.
2. AC power line Conducted Emission was tested under maximum output power.
3. For radiated test cases, the worst mode data rate 1Mbps was reported only, because this data rate has the highest RF output power at preliminary tests, and no other significantly frequencies found in conducted spurious emission.

6 SETUP OF EQUIPMENT UNDER TEST

6.1 BLOCK DIAGRAM CONFIGURATION OF TEST SYSTEM

For AC Conducted Emission Mode



For Radiated Test Cases

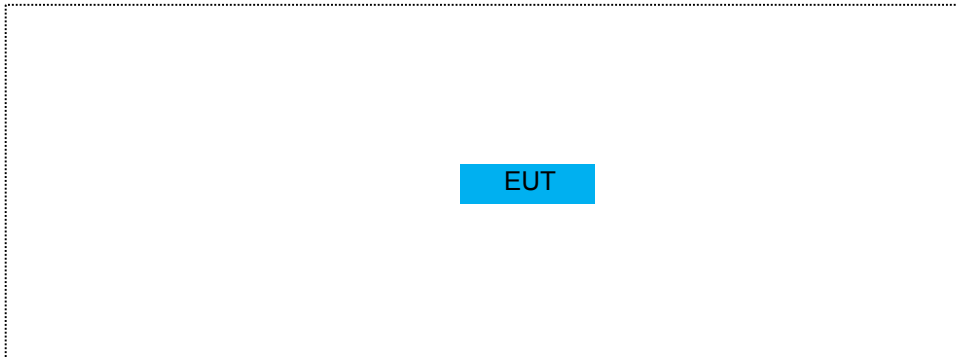

For Conducted Test Cases

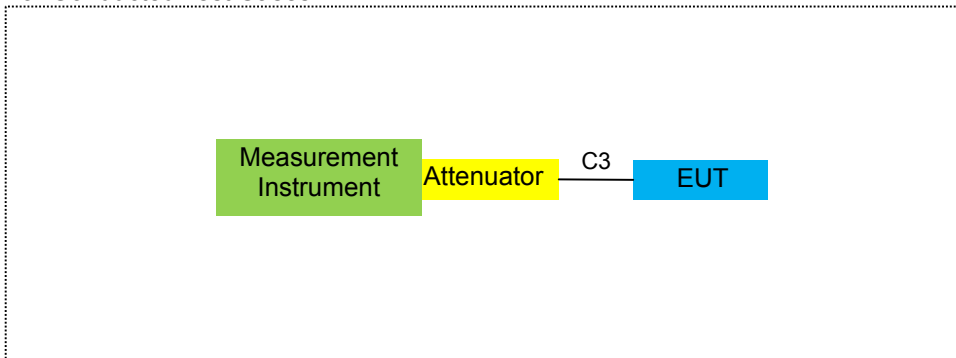

6.2 SUPPORT EQUIPMENT

The EUT has been tested as an independent unit together with other necessary accessories or support units. The following support units or accessories were used to form a representative test configuration during the tests.

Item	Equipment	Mfr/Brand	Model/Type No.	FCC ID	Note
E-1	4inch 3G Dual SIM Smart phone	N/A	T4016	2AHXO-T4016	EUT
E-2	Adapter	N/A	K-T50501000U1	N/A	Peripherals
E-3	Earphone	N/A	L662	N/A	Peripherals

Item	Cable Type	Shielded Type	Ferrite Core	Length
C-1	USB Cable	NO	NO	1.0m
C-2	Earphone	NO	NO	0.8m
C-3	RF Cable	NO	NO	0.5m

Notes:

- (1) The support equipment was authorized by Declaration of Confirmation.
- (2) For detachable type I/O cable should be specified the length in cm in 『Length』 column.
- (3) “YES” is means “shielded” “with core”; “NO” is means “unshielded” “without core”.

6.3 EQUIPMENTS LIST FOR ALL TEST ITEMS

Radiation Test equipment

Item	Kind of Equipment	Manufacturer	Type No.	Serial No.	Last calibration	Calibrated until	Calibration period
1	Spectrum Analyzer	Agilent	E4407B	MY45108040	2015.07.06	2016.07.05	1 year
2	Test Receiver	R&S	ESPI	101318	2015.06.07	2016.06.06	1 year
3	Bilog Antenna	TESEQ	CBL6111D	31216	2015.07.06	2016.07.05	1 year
4	50Ω Coaxial Switch	Anritsu	MP59B	6200264416	2015.06.07	2016.06.06	1 year
5	Spectrum Analyzer	ADVANTEST	R3132	150900201	2015.06.07	2016.06.06	1 year
6	Horn Antenna	EM	EM-AH-10180	2011071402	2015.07.06	2016.07.05	1 year
7	Horn Ant	Schwarzbeck	BBHA 9170	9170-181	2015.07.06	2016.07.05	1 year
8	Amplifier	EM	EM-30180	060538	2015.12.22	2016.12.21	1 year
9	Loop Antenna	ARA	PLA-1030/B	1029	2015.06.08	2016.06.07	1 year
10	Power Meter	R&S	NRVS	100696	2015.07.06	2016.07.05	1 year
11	Power Sensor	R&S	URV5-Z4	0395.1619.05	2015.07.06	2016.07.05	1 year
12	Test Cable	N/A	R-01	N/A	2015.07.06	2016.07.05	1 year
13	Test Cable	N/A	R-02	N/A	2015.07.06	2016.07.05	1 year

Conduction Test equipment

Item	Kind of Equipment	Manufacturer	Type No.	Serial No.	Last calibration	Calibrated until	Calibration period
1	Test Receiver	R&S	ESCI	101160	2015.06.06	2016.06.05	1 year
2	LISN	R&S	ENV216	101313	2015.08.24	2016.08.23	1 year
3	LISN	EMCO	3816/2	00042990	2015.08.24	2016.08.23	1 year
4	50Ω Coaxial Switch	Anritsu	MP59B	6200264417	2015.06.07	2016.06.06	1 year
5	Passive Voltage Probe	R&S	ESH2-Z3	100196	2015.06.07	2016.06.06	1 year
6	Absorbing clamp	R&S	MOS-21	100423	2015.06.08	2016.06.07	1 year
7	Test Cable	N/A	C01	N/A	2015.06.08	2016.06.07	1 year
8	Test Cable	N/A	C02	N/A	2015.06.08	2016.06.07	1 year
9	Test Cable	N/A	C03	N/A	2015.06.08	2016.06.07	1 year
1	Attenuation	MCE	24-10-34	BN9258	2015.06.08	2016.06.07	1 year

Note: Each piece of equipment is scheduled for calibration once a year.

7 TEST REQUIREMENTS

7.1 CONDUCTED EMISSIONS TEST

7.1.1 Applicable Standard

According to FCC Part 15.207(a) and KDB 174176 D01 Line Conducted FAQ v01r01

7.1.2 Conformance Limit

Frequency(MHz)	Conducted Emission Limit	
	Quasi-peak	Average
0.15-0.5	66-56*	56-46*
0.5-5.0	56	46
5.0-30.0	60	50

Note: 1. *Decreases with the logarithm of the frequency
 2. The lower limit shall apply at the transition frequencies
 3. The limit decreases in line with the logarithm of the frequency in the range of 0.15 to 0.50MHz.

7.1.3 Measuring Instruments

The Measuring equipment is listed in the section 6.3 of this test report.

7.1.4 Test Configuration

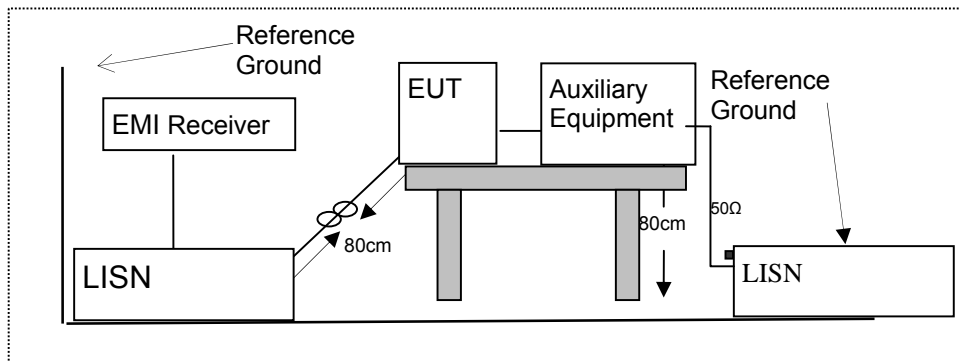

7.1.5 Test Procedure

According to the requirements in Section 13.1.4.1 of ANSI C63.10-2013 Conducted emissions the EUT measured in the frequency range between 0.15 MHz and 30 MHz using CISPR Quasi-Peak and average detector mode.

1. The EUT was placed 0.4 meter from the conducting wall of the shielding room.
2. The EUT was placed on a table which is 0.8m above ground plane.
3. Connect EUT to the power mains through a line impedance stabilization network (LISN). All other support equipments powered from additional LISN(s). The LISN provide 50 Ohm/ 50uH of coupling impedance for the measuring instrument.
4. Interconnecting cables that hang closer than 40 cm to the ground plane shall be folded back and forth in the center forming a bundle 30 to 40cm long.
5. I/O cables that are not connected to a peripheral shall be bundled in the center. The end of the cable may be terminated, if required, using the correct terminating impedance. The overall length shall not exceed 1 m.
6. LISN at least 80 cm from nearest part of EUT chassis.
7. The frequency range from 150KHz to 30MHz was searched.
8. Set the test-receiver system to Peak Detect Function and specified bandwidth(IF bandwidth=9KHz) with Maximum Hold Mode
9. For the actual test configuration, please refer to the related Item –EUT Test Photos.

7.1.6 Test Results

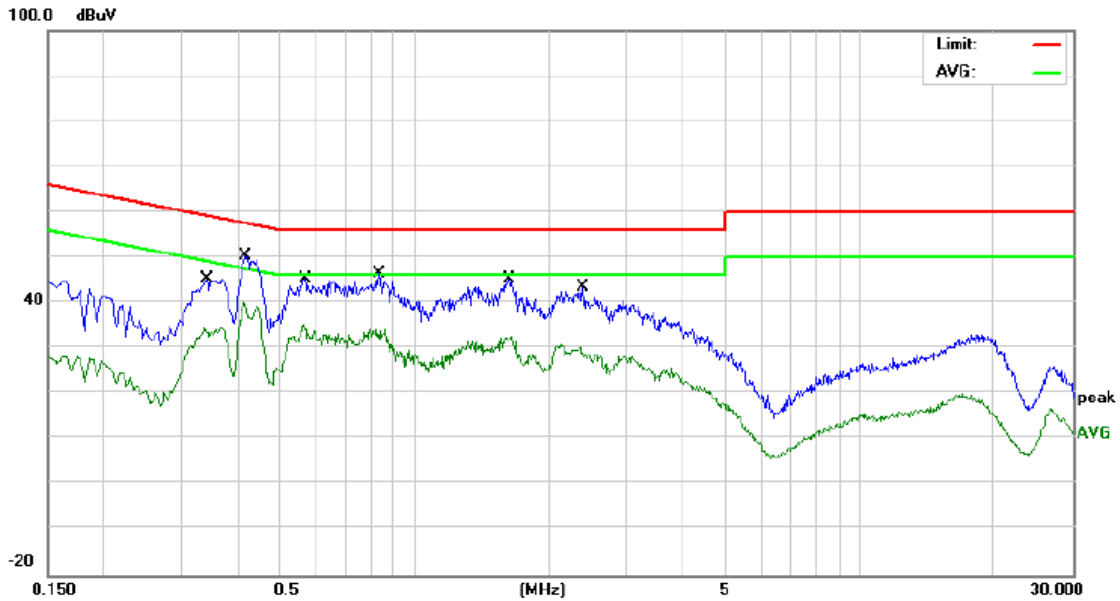

Site: Phase: **L1** Temperature: 22
 Limit: FCC Part 15B_(0.15-30MHz) _Main_QP Power: AC 120V/60Hz Humidity: 51 %
 Mode: Mode1
 Note:

No.	Mk.	Freq. MHz	Reading Level dBuV	Correct Factor dB	Measure- ment dBuV	Limit dBuV	Over dB	Detector	Comment
1		0.3420	35.21	10.10	45.31	59.15	-13.84	QP	
2		0.3420	24.39	10.10	34.49	49.15	-14.66	AVG	
3	*	0.4180	40.40	10.00	50.40	57.49	-7.09	QP	
4		0.4180	30.01	10.00	40.01	47.49	-7.48	AVG	
5		0.5700	35.48	9.79	45.27	56.00	-10.73	QP	
6		0.5700	25.62	9.79	35.41	46.00	-10.59	AVG	
7		0.8340	36.52	9.81	46.33	56.00	-9.67	QP	
8		0.8340	24.42	9.81	34.23	46.00	-11.77	AVG	
9		1.6340	35.39	9.77	45.16	56.00	-10.84	QP	
10		1.6340	22.74	9.77	32.51	46.00	-13.49	AVG	
11		2.3860	33.59	9.73	43.32	56.00	-12.68	QP	
12		2.3860	20.92	9.73	30.65	46.00	-15.35	AVG	

*:Maximum data x:Over limit !:over margin

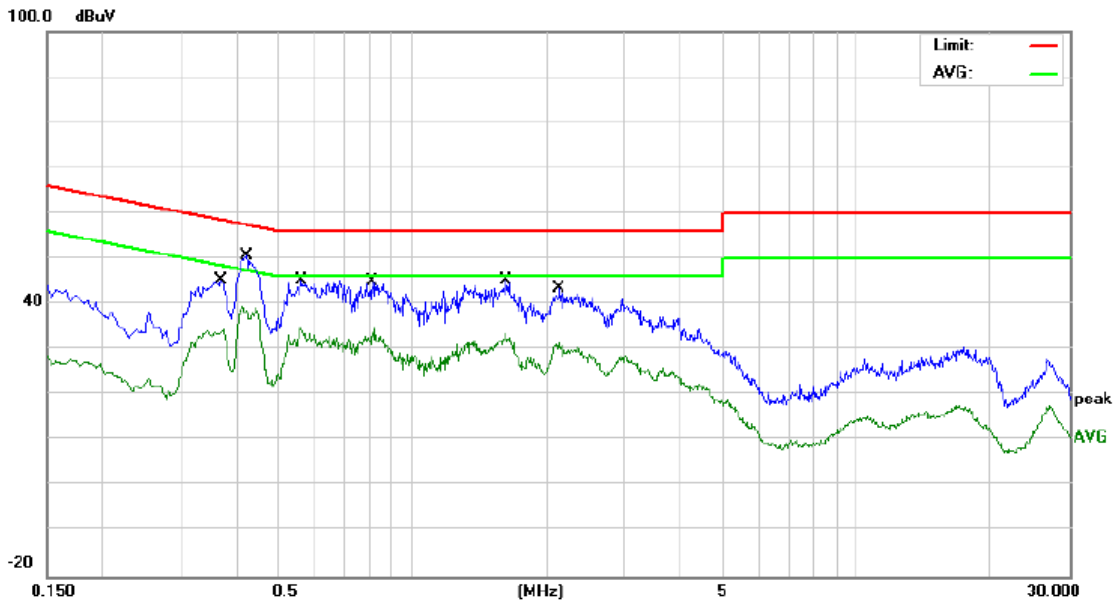

Site: Phase: *N* Temperature: 22
 Limit: FCC Part 15B_(0.15-30MHz) _Main_QP Power: AC 120V/60Hz Humidity: 51 %
 Mode: Mode1
 Note:

No.	Mk.	Freq. MHz	Reading Level dBuV	Correct Factor dB	Measure- ment dBuV	Limit dBuV	Over dB	Detector	Comment
1		0.3699	35.13	10.07	45.20	58.50	-13.30	QP	
2		0.3699	24.51	10.07	34.58	48.50	-13.92	AVG	
3	*	0.4219	40.74	9.99	50.73	57.41	-6.68	QP	
4		0.4219	29.47	9.99	39.46	47.41	-7.95	AVG	
5		0.5620	35.56	9.79	45.35	56.00	-10.65	QP	
6		0.5620	24.96	9.79	34.75	46.00	-11.25	AVG	
7		0.8100	35.03	9.81	44.84	56.00	-11.16	QP	
8		0.8100	24.79	9.81	34.60	46.00	-11.40	AVG	
9		1.6259	35.50	9.77	45.27	56.00	-10.73	QP	
10		1.6259	23.85	9.77	33.62	46.00	-12.38	AVG	
11		2.1339	33.68	9.73	43.41	56.00	-12.59	QP	
12		2.1339	21.59	9.73	31.32	46.00	-14.68	AVG	

*:Maximum data x:Over limit !:over margin

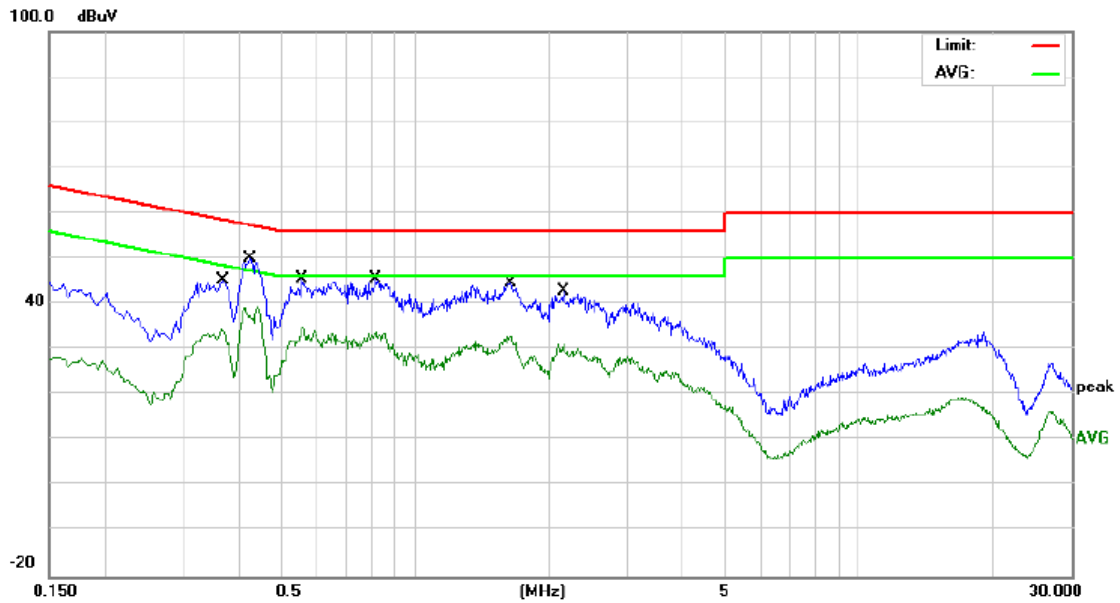

Site: Phase: **L1** Temperature: 22
 Limit: FCC Part 15B_(0.15-30MHz) _Main_QP Power: AC 240V/50Hz Humidity: 51 %
 Mode: Mode1
 Note:

No.	Mk.	Freq. MHz	Reading Level dBuV	Correct Factor dB	Measure- ment dBuV	Limit dBuV	Over dB	Detector	Comment
1		0.3700	35.05	10.07	45.12	58.50	-13.38	QP	
2		0.3700	24.25	10.07	34.32	48.50	-14.18	AVG	
3	*	0.4260	40.18	9.98	50.16	57.33	-7.17	QP	
4		0.4260	29.61	9.98	39.59	47.33	-7.74	AVG	
5		0.5580	35.80	9.79	45.59	56.00	-10.41	QP	
6		0.5580	25.29	9.79	35.08	46.00	-10.92	AVG	
7		0.8139	35.65	9.81	45.46	56.00	-10.54	QP	
8		0.8139	24.17	9.81	33.98	46.00	-12.02	AVG	
9		1.6380	34.79	9.77	44.56	56.00	-11.44	QP	
10		1.6380	23.30	9.77	33.07	46.00	-12.93	AVG	
11		2.1580	33.10	9.73	42.83	56.00	-13.17	QP	
12		2.1580	21.34	9.73	31.07	46.00	-14.93	AVG	

*:Maximum data x:Over limit !:over margin

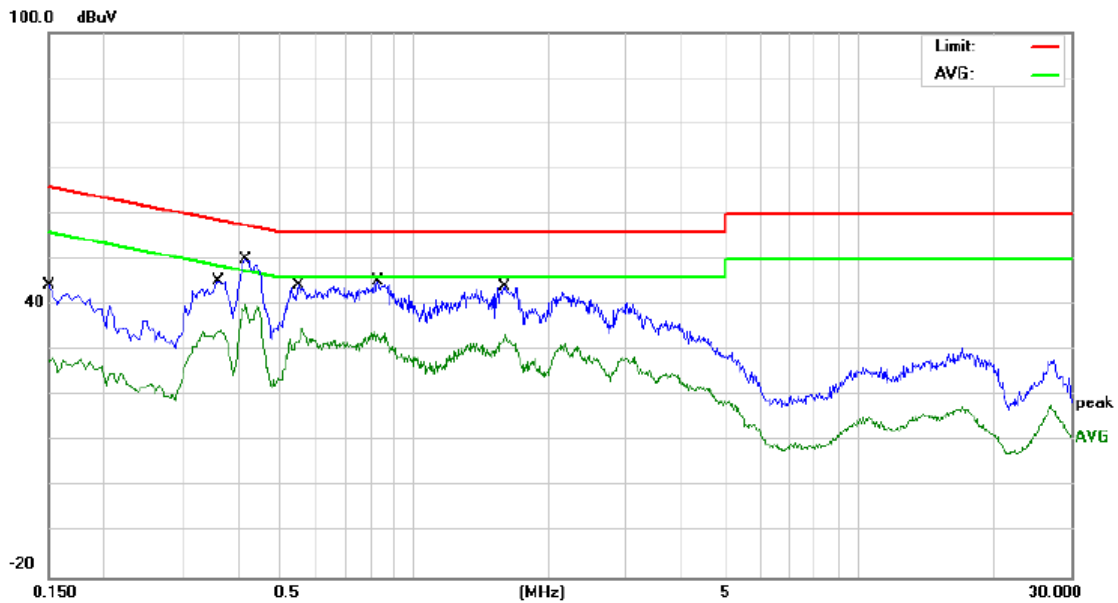

Site: Phase: **N** Temperature: 22
 Limit: FCC Part 15B_(0.15-30MHz) _Main_QP Power: AC 240V/50Hz Humidity: 51 %
 Mode: Mode1
 Note:

No.	Mk.	Freq. MHz	Reading Level dBuV	Correct Factor dB	Measure- ment dBuV	Limit dBuV	Over dB	Detector	Comment
1		0.1499	34.34	10.12	44.46	66.00	-21.54	QP	
2		0.1499	18.30	10.12	28.42	56.00	-27.58	AVG	
3		0.3620	35.25	10.08	45.33	58.68	-13.35	QP	
4		0.3620	24.25	10.08	34.33	48.68	-14.35	AVG	
5	*	0.4180	40.05	10.00	50.05	57.49	-7.44	QP	
6		0.4180	30.02	10.00	40.02	47.49	-7.47	AVG	
7		0.5500	34.52	9.79	44.31	56.00	-11.69	QP	
8		0.5500	25.26	9.79	35.05	46.00	-10.95	AVG	
9		0.8300	35.47	9.81	45.28	56.00	-10.72	QP	
10		0.8300	24.30	9.81	34.11	46.00	-11.89	AVG	
11		1.5980	34.14	9.78	43.92	56.00	-12.08	QP	
12		1.5980	23.81	9.78	33.59	46.00	-12.41	AVG	

*:Maximum data x:Over limit !:over margin

7.2 RADIATED SPURIOUS EMISSION

7.2.1 Applicable Standard

According to FCC Part 15.247(d) and 15.209 and DA 00-705

7.2.2 Conformance Limit

According to FCC Part 15.247(d): radiated emissions which fall in the restricted bands, as defined in §15.205(a), must also comply with the radiated emission limits specified in §15.209(a) (see §15.205(c)).
According to FCC Part 15.205, Restricted bands

MHz	MHz	MHz	GHz
0.090-0.110	16.42-16.423	399.9-410	4.5-5.15
10.495-0.505	16.69475-16.69525	608-614	5.35-5.46
2.1735-2.1905	16.80425-16.80475	960-1240	7.25-7.75
4.125-4.128	25.5-25.67	1300-1427	8.025-8.5
4.17725-4.17775	37.5-38.25	1435-1626.5	9.0-9.2
4.20725-4.20775	73-74.6	1645.5-1646.5	9.3-9.5
6.215-6.218	74.8-75.2	1660-1710	10.6-12.7
6.26775-6.26825	123-138	2200-2300	14.47-14.5
8.291-8.294	149.9-150.05	2310-2390	15.35-16.2
8.362-8.366	156.52475-156.52525	2483.5-2500	17.7-21.4
8.37625-8.38675	156.7-156.9	2690-2900	22.01-23.12
8.41425-8.41475	162.0125-167.17	3260-3267	23.6-24.0
12.29-12.293	167.72-173.2	3332-3339	31.2-31.8
12.51975-12.52025	240-285	3345.8-3358	36.43-36.5
12.57675-12.57725	322-335.4	3600-4400	(2)
13.36-13.41			

20dBc in any 100 kHz bandwidth outside the operating frequency band. In case the emission fall within the restricted band specified on 15.205(a), then the 15.209(a) limit in the table below has to be followed.

Restricted Frequency(MHz)	Field Strength (µV/m)	Field Strength (dBµV/m)	Measurement Distance
0.009~0.490	2400/F(KHz)	20 log (uV/m)	300
0.490~1.705	2400/F(KHz)	20 log (uV/m)	30
1.705~30.0	30	29.5	30
30-88	100	40	3
88-216	150	43.5	3
216-960	200	46	3
Above 960	500	54	3

Limits of Radiated Emission Measurement(Above 1000MHz)

Frequency(MHz)	Class B (dBuV/m) (at 3M)	
	PEAK	AVERAGE
Above 1000	74	54

Remark :1. Emission level in dBuV/m=20 log (uV/m)
2. Measurement was performed at an antenna to the closed point of EUT distance of meters.
3. Distance extrapolation factor =40log(Specific distance/ test distance)(dB);
Limit line=Specific limits(dBuV) + distance extrapolation factor.

7.2.3 Measuring Instruments

The Measuring equipment is listed in the section 6.3 of this test report.

7.2.4 Test Configuration

(a) For radiated emissions below 30MHz

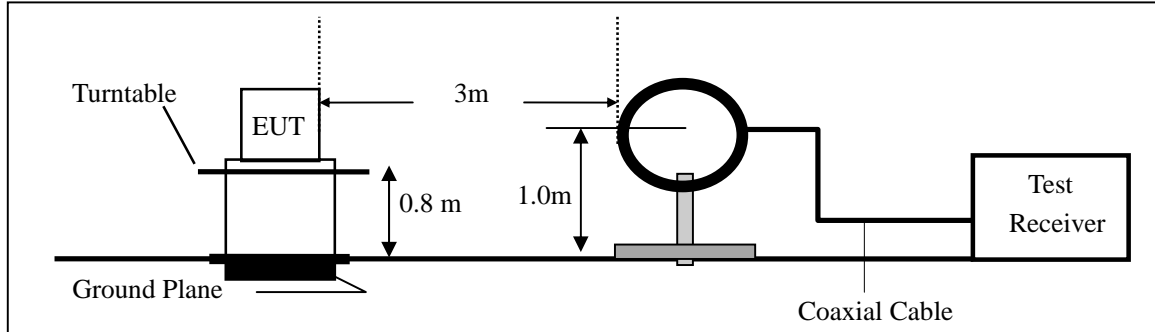

(b) For radiated emissions from 30MHz to 1000MHz

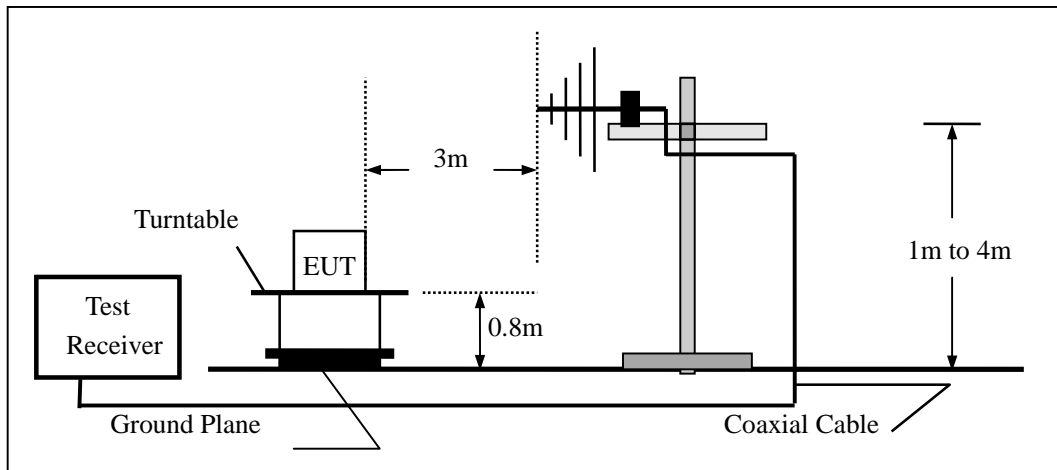

(c) For radiated emissions above 1000MHz

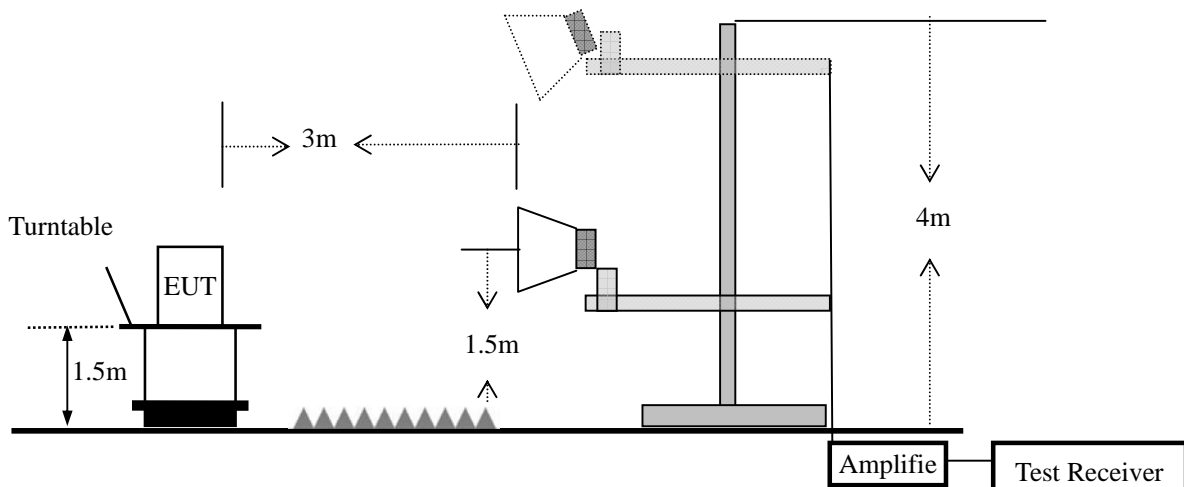

7.2.5 Test Procedure

The test site semi-anechoic chamber has met the requirement of NSA tolerance 4 dB according to the standards: ANSI C63.10-2013. The test distance is 3m. The setup is according to the requirements in Section 13.1.4.1 of ANSI C63.10-2013 and CAN/CSA-CEI/IEC CISPR 22.

This test is required for any spurious emission that falls in a Restricted Band, as defined in Section 15.205. It must be performed with the highest gain of each type of antenna proposed for use with the EUT.

Use the following spectrum analyzer settings:

Spectrum Parameter	Setting
Attenuation	Auto
Start Frequency	1000 MHz
Stop Frequency	10th carrier harmonic
RB / VB (emission in restricted band)	1 MHz / 1 MHz for Peak, 1 MHz / 10Hz for Average

Receiver Parameter	Setting
Attenuation	Auto
Start ~ Stop Frequency	9kHz~150kHz / RB 200Hz for QP
Start ~ Stop Frequency	150kHz~30MHz / RB 9kHz for QP
Start ~ Stop Frequency	30MHz~1000MHz / RB 120kHz for QP

- a. The measuring distance of at 3 m shall be used for measurements at frequency up to 1GHz. For frequencies above 1GHz, any suitable measuring distance may be used.
- b. The EUT was placed on the top of a rotating table 0.8 m for below 1GHz and 1.5m for above 1GHz the ground at a 3 meter. The table was rotated 360 degrees to determine the position of the highest radiation.
- c. The height of the equipment or of the substitution antenna shall be 0.8 m for below 1GHz and 1.5m for above 1GHz; the height of the test antenna shall vary between 1 m to 4 m. Both horizontal and vertical polarizations of the antenna are set to make the measurement.
- d. The initial step in collecting conducted emission data is a spectrum analyzer peak detector mode pre-scanning the measurement frequency range. Significant peaks are then marked and then Quasi Peak detector mode re-measured.
- e. If the Peak Mode measured value compliance with and lower than Quasi Peak Mode Limit, the EUT shall be deemed to meet QP Limits and then no additional QP Mode measurement performed.
- f. For the actual test configuration, please refer to the related Item –EUT Test Photos.

Note:

Both horizontal and vertical antenna polarities were tested and performed pretest to three orthogonal axis. The worst case emissions were reported

During the radiated emission test, the Spectrum Analyzer was set with the following configurations:

Frequency Band (MHz)	Function	Resolution bandwidth	Video Bandwidth
30 to 1000	QP	120 kHz	300 kHz
Above 1000	Peak	1 MHz	1 MHz
	Average	1 MHz	10 Hz

Note: for the frequency ranges below 30 MHz, a narrower RBW is used for these ranges but the measured value should add a RBW correction factor (RBWCF) where $RBWCF [dB] = 10 \cdot \lg(100 [kHz] / \text{narrower RBW [kHz]})$. , the narrower RBW is 1 kHz and RBWCF is 20 dB for the frequency 9 kHz to 150 kHz, and the narrower RBW is 10 kHz and RBWCF is 10 dB for the frequency 150 kHz to 30 MHz.

7.2.6 Test Results

■ Spurious Emission below 30MHz (9KHz to 30MHz)

EUT:	4inch 3G Dual SIM Smart phone	Model No.:	T4016
Temperature:	20 °C	Relative Humidity:	48%
Test Mode:	Mode2/Mode3/ Mode4	Test By:	Jack Li

Freq. (MHz)	Ant.Pol. H/V	Emission Level(dBuV/m)		Limit 3m(dBuV/m)		Over(dB)	
		PK	AV	PK	AV	PK	AV
--	--	--	--	--	--	--	--

Note: the amplitude of spurious emission that is attenuated by more than 20dB below the permissible limit has no need to be reported.

Distance extrapolation factor =20log(Specific distance/ test distance)(dB);

Limit line=Specific limits(dBuV) + distance extrapolation factor

- Spurious Emission below 1GHz (30MHz to 1GHz)
All the modulation modes have been tested, and the worst result was report as below:

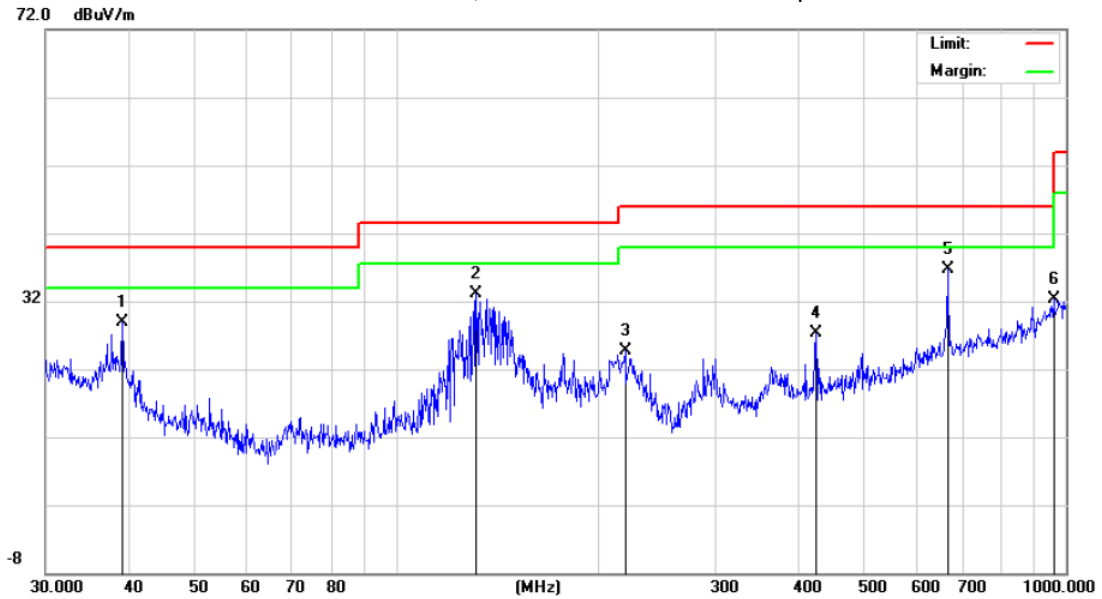

Site: Polarization: *Vertical* Temperature: 24
 Limit: FCC_PART15_B_03m_QP Power: AC 120V/60Hz Humidity: 50 %
 Mode: Mode 2
 Note:

No.	Mk.	Freq. MHz	Reading Level dBuV	Correct Factor dB	Measure- ment dBuV/m	Limit dBuV/m	Over dB	Antenna Height cm	Table Degree degree	Comment
1		39.0245	13.71	15.12	28.83	40.00	-11.17	QP		
2		131.7577	22.10	10.92	33.02	43.50	-10.48	QP		
3		219.8446	13.82	10.85	24.67	46.00	-21.33	QP		
4		423.5403	12.52	14.74	27.26	46.00	-18.74	QP		
5	*	665.8034	15.84	20.77	36.61	46.00	-9.39	QP		
6		958.7943	5.73	26.57	32.30	46.00	-13.70	QP		

*:Maximum data x:Over limit !:over margin

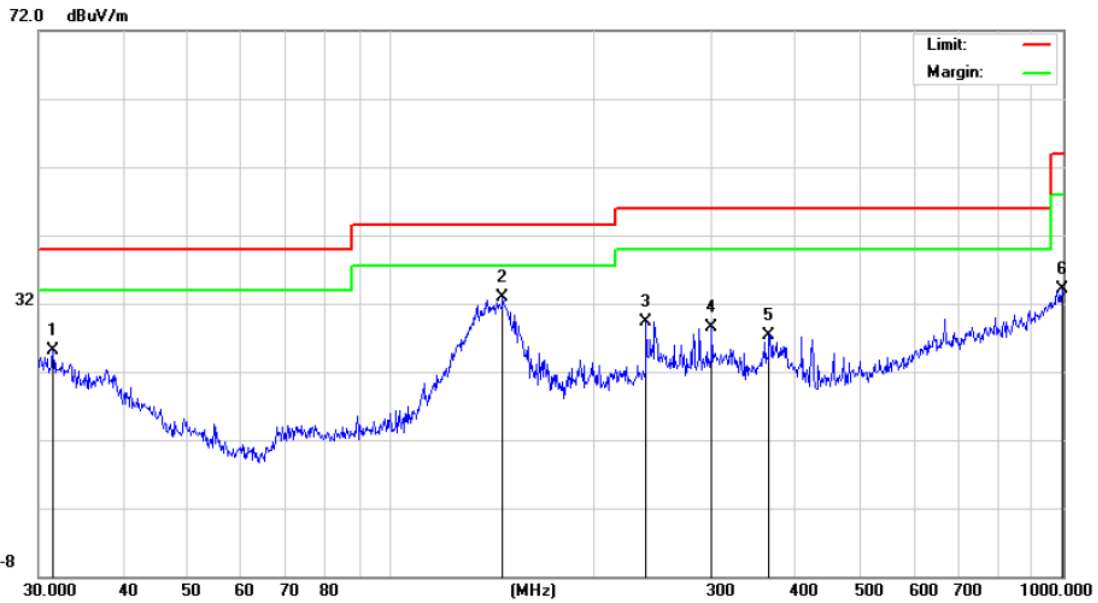

Site: Polarization: *Horizontal* Temperature: 24
 Limit: FCC_PART15_B_03m_QP Power: AC 120V/60Hz Humidity: 50 %
 Mode: Mode 2
 Note:

No.	Mk.	Freq.	Reading Level	Correct Factor	Measurement	Limit	Over	Antenna Height	Table Degree
		MHz	dBuV	dB	dBuV/m	dBuV/m	dB	cm	degree
1		31.5094	6.10	19.03	25.13	40.00	-14.87	QP	
2	*	146.8877	21.49	11.43	32.92	43.50	-10.58	QP	
3		239.9874	18.58	10.73	29.31	46.00	-16.69	QP	
4		300.3672	15.82	12.60	28.42	46.00	-17.58	QP	
5		365.5391	12.83	14.51	27.34	46.00	-18.66	QP	
6		996.4995	6.46	27.57	34.03	54.00	-19.97	QP	

*:Maximum data x:Over limit !:over margin

■ Spurious Emission Above 1GHz (1GHz to 25GHz)

EUT:	4inch 3G Dual SIM Smart phone	Model No.:	T4016
Temperature:	20 °C	Relative Humidity:	48%
Test Mode:	Mode2/Mode3/ Mode4	Test By:	Jack Li

All the modulation modes have been tested, and the worst result was report as below:

Frequency (MHz)	Meter Reading (dBμV)	Factor (dB)	Emission Level (dBμV/m)	Limits (dBμV/m)	Margin (dB)	Remark	Comment
Low Channel (2402 MHz)-Above 1G							
4804.77	56.47	-3.64	52.83	74.00	-21.17	Pk	Vertical
4804.77	40.47	-3.64	36.83	54.00	-17.17	AV	Vertical
7206.72	61.36	-0.95	60.41	74.00	-13.59	Pk	Vertical
7206.72	42.47	-0.95	41.52	54.00	-12.48	AV	Vertical
4804.88	59.69	-3.64	56.05	74.00	-17.95	Pk	Horizontal
4804.88	42.80	-3.64	39.16	54.00	-14.84	AV	Horizontal
7206.80	58.26	-0.95	57.31	74.00	-16.69	Pk	Horizontal
7206.80	42.44	-0.95	41.49	54.00	-12.51	AV	Horizontal
Mid Channel (2441 MHz)-Above 1G							
4880.82	61.36	-3.68	57.68	74.00	-16.32	Pk	Vertical
4880.82	39.69	-3.68	36.01	54.00	-17.99	AV	Vertical
7320.72	59.69	-0.82	58.87	74.00	-15.13	Pk	Vertical
7320.72	42.36	-0.82	41.54	54.00	-12.46	AV	Vertical
4880.80	59.44	-3.68	55.76	74.00	-18.24	Pk	Horizontal
4880.80	42.13	-3.68	38.45	54.00	-15.55	AV	Horizontal
7320.65	58.47	-0.82	57.65	74.00	-16.35	Pk	Horizontal
7320.65	42.36	-0.82	41.54	54.00	-12.46	AV	Horizontal
High Channel (2480 MHz)- Above 1G							
4961.13	58.26	-3.59	54.67	74.00	-19.33	Pk	Vertical
4961.13	41.13	-3.59	37.54	54.00	-16.46	AV	Vertical
7440.84	58.44	-0.68	57.76	74.00	-16.24	Pk	Vertical
7440.84	40.44	-0.68	39.76	54.00	-14.24	AV	Vertical
4960.72	58.69	-3.59	55.10	74.00	-18.90	Pk	Horizontal
4960.72	40.77	-3.59	37.18	54.00	-16.82	AV	Horizontal
7440.88	62.13	-0.68	61.45	74.00	-12.55	Pk	Horizontal
7440.88	41.58	-0.68	40.90	54.00	-13.10	AV	Horizontal

Note: (1) All Readings are Peak Value (VBW=3MHz) and Peak Value (VBW=10Hz).
 (2) Emission Level= Reading Level+Probe Factor +Cable Loss.
 (3)All other emissions more than 20dB below the limit.

■ Spurious Emission in Restricted Band 3260MHz- 18000MHz

EUT:	4inch 3G Dual SIM Smart phone	Model No.:	T4016
Temperature:	20 °C	Relative Humidity:	48%
Test Mode:	Mode2/Mode3/ Mode4	Test By:	Jack Li

All the modulation modes were tested, the data of the worst mode are described in the following table

Frequency (MHz)	Meter Reading (dBµV)	Factor (dB)	Emission Level (dBµV/m)	Limits (dBµV/m)	Margin (dB)	Detector Type	Comment
1Mbps							
2390	60.88	-13.06	47.82	74	-26.18	Pk	Vertical
2390	50.02	-13.06	36.96	54	-17.04	AV	Vertical
2390	60.76	-13.06	47.7	74	-26.3	Pk	Horizontal
2390	49.91	-13.06	36.85	54	-17.15	AV	Horizontal
2483.5	61.59	-12.78	48.81	74	-25.19	Pk	Vertical
2483.5	51.11	-12.78	38.33	54	-15.67	AV	Vertical
2483.5	61.31	-12.78	48.53	74	-25.47	Pk	Horizontal
2483.5	50.97	-12.78	38.19	54	-15.81	AV	Horizontal
17782	64.74	-12.24	52.5	74	-21.5	Pk	Vertical
17782	51.65	-12.24	39.41	54	-14.59	AV	Vertical
17724	64.59	-12.24	52.35	74	-21.65	Pk	Horizontal
17724	51.35	-12.24	39.11	54	-14.89	AV	Horizontal

Note: All other emissions more than 20dB below the limit.

■ Spurious Emission in Band Edge

Frequency (MHz)	Meter Reading (dBµV)	Factor (dB)	Emission Level (dBµV/m)	Limits (dBµV/m)	Margin (dB)	Detector Type	Comment
1Mbps							
2329.29	62.43	-13.06	49.37	74	-24.63	Pk	Vertical
2329.29	56.57	-13.06	43.51	54	-10.49	AV	Vertical
2400	65.61	-13.06	52.55	74	-21.45	Pk	Vertical
2400	56.08	-13.06	43.02	54	-10.98	AV	Vertical
2380.8	62.31	-13.06	49.25	74	-24.75	Pk	Horizontal
2380.8	57.46	-13.06	44.4	54	-9.6	AV	Horizontal
2400	66.06	-13.06	53	74	-21	Pk	Horizontal
2400	56.89	-13.06	43.83	54	-10.17	AV	Horizontal
2483.5	63.14	-12.78	50.36	74	-23.64	Pk	Vertical
2483.5	62.66	-12.78	49.88	54	-4.12	AV	Vertical
2483.5	62.86	-12.78	50.08	74	-23.92	Pk	Horizontal
2483.5	62.52	-12.78	49.74	54	-4.26	AV	Horizontal

Note: All other emissions more than 20dB below the limit.

7.3 6DB BANDWIDTH

7.3.1 Applicable Standard

According to FCC Part 15.247(a)(2) and KDB 558074 DTS 01 Meas. Guidance v03r04

7.3.2 Conformance Limit

The minimum permissible 6dB bandwidth is 500 kHz.

7.3.3 Measuring Instruments

The Measuring equipment is listed in the section 6.3 of this test report.

7.3.4 Test Setup

Please refer to Section 6.1 of this test report.

7.3.5 Test Procedure

The testing follows KDB 558074 DTS 01 Meas. Guidance v03r04
 The RF output of EUT was connected to the spectrum analyzer by RF cable and attenuator.
 The path loss was compensated to the results for each measurement.
 Set to the maximum power setting and enable the EUT transmit continuously.
 The EUT was operating in controlled its channel.
 Use the following spectrum analyzer settings:
 Span = the frequency band of operation
 RBW = 100KHz
 VBW ≥ 3*RBW
 Sweep = auto
 Detector function = peak
 Trace = max hold

7.3.6 Test Results

EUT:	4inch 3G Dual SIM Smart phone	Model No.:	T4016
Temperature:	20 °C	Relative Humidity:	48%
Test Mode:	Mode2/Mode3/ Mode4	Test By:	Jack Li

Channel	Frequency (MHz)	6dB bandwidth (kHz)	Limit (kHz)	Result
Low	2402	701.4	500	Pass
Middle	2440	701.0	500	Pass
High	2480	700.4	500	Pass

6dB Bandwidth plot on channel 00

1Mbps

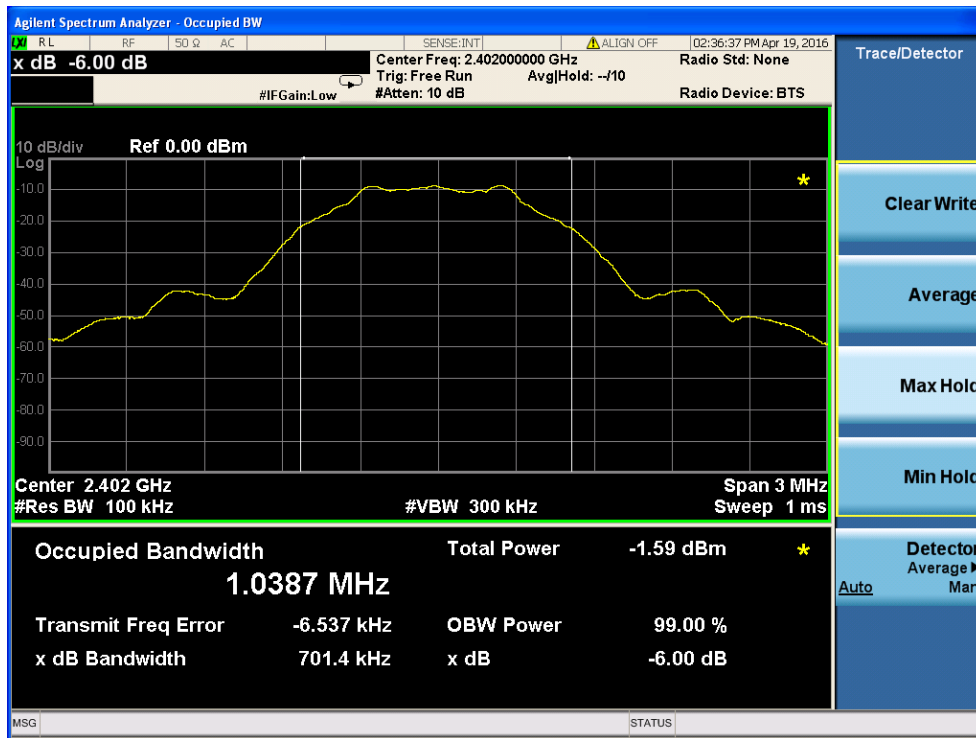

6dB Bandwidth plot on channel 19

1Mbps

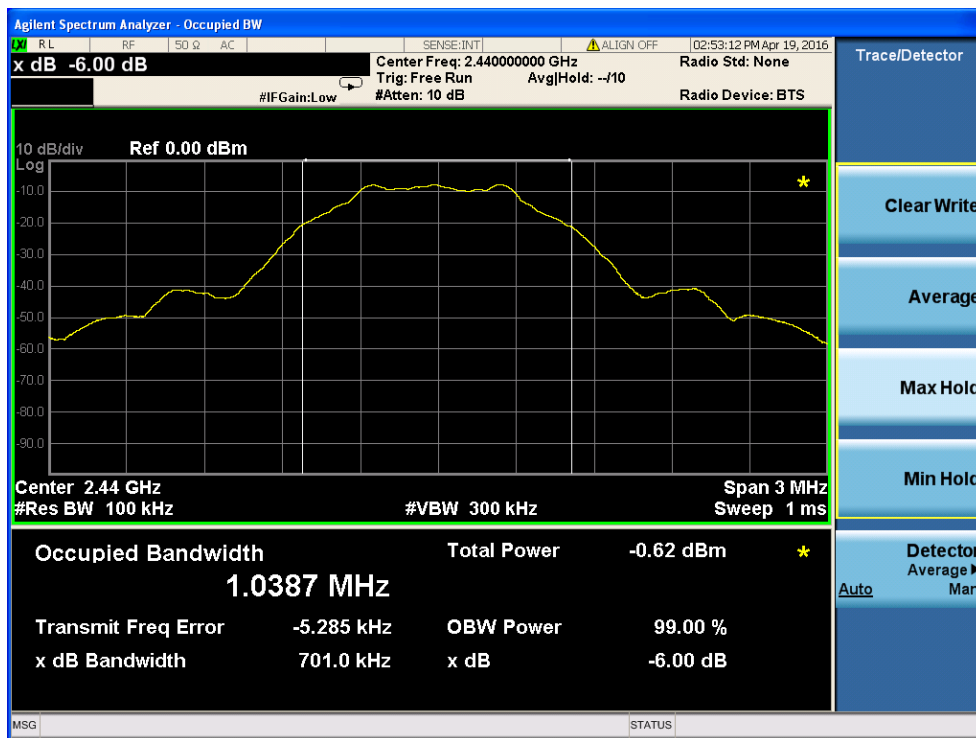

6dB Bandwidth plot on channel 39

1Mbps

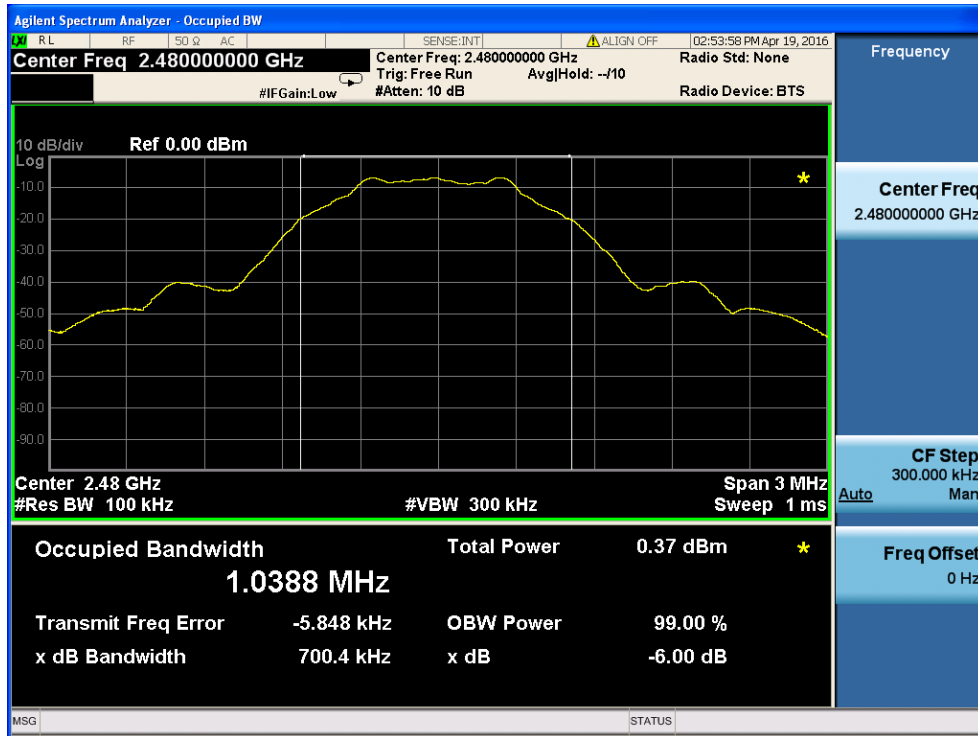

7.4 DUTY CYCLE

7.4.1 Applicable Standard

According to KDB 558074)6)b), issued 06/09/2015

7.4.2 Conformance Limit

No limit requirement.

7.4.3 Measuring Instruments

The Measuring equipment is listed in the section 6.3 of this test report.

7.4.4 Test Setup

Please refer to Section 6.1 of this test report.

7.4.5 Test Procedure

The zero-span mode on a spectrum analyzer or EMI receiver if the response time and spacing between bins on the sweep are sufficient to permit accurate measurements of the on and off times of the transmitted signal. Set the center frequency of the instrument to the center frequency of the transmission. Set $RBW \geq OBW$ if possible; otherwise, set RBW to the largest available value. Set $VBW \geq RBW$. Set detector = peak or average. The zero-span measurement method shall not be used unless both RBW and VBW are $> 50/T$ and the number of sweep points across duration T exceeds 100. (For example, if VBW and/or RBW are limited to 3 MHz, then the zero-span method of measuring duty cycle shall not be used if $T \leq 16.7$ microseconds.)

The transmitter output is connected to the Spectrum Analyzer. We tested according to the zero-span measurement method, 6.0)b) in KDB 558074(issued 06/09/2015)

The largest available value of RBW is 8 MHz and VBW is 50 MHz. The zero-span method of measuring duty cycle shall not be used if $T \leq 6.25$ microseconds. ($50/6.25 = 8$)

The zero-span method was used because all measured T data are > 6.25 microseconds and both RBW and VBW are $> 50/T$.

The RF output of EUT was connected to the spectrum analyzer by RF cable and attenuator.

The path loss was compensated to the results for each measurement.

Set to the maximum power setting and enable the EUT transmit continuously.

The EUT was operating in controlled its channel.

Use the following spectrum analyzer settings:

Span = Zero Span

RBW = 8MHz(the largest available value)

VBW = 8MHz (\geq RBW)

Number of points in Sweep > 100

Detector function = peak

Trace = Clear write

Measure T_{total} and T_{on}

Calculate Duty Cycle = T_{on} / T_{total} and Duty Cycle Factor = $10 \cdot \log(1/\text{Duty Cycle})$

7.4.6 Test Results

EUT:	4inch 3G Dual SIM Smart phone	Model No.:	T4016
Temperature:	20 °C	Relative Humidity:	48%
Test Mode:	Mode2/Mode3/ Mode4	Test By:	Jack Li

Modulation Mode	Data rate	T _{on}	T _{total}	Duty Cycle	Duty Cycle Factor (dB)
GFSK	1Mbps	400.0	624.0	0.6410	1.931

Duty Cycle plot on channel 19 1Mbps

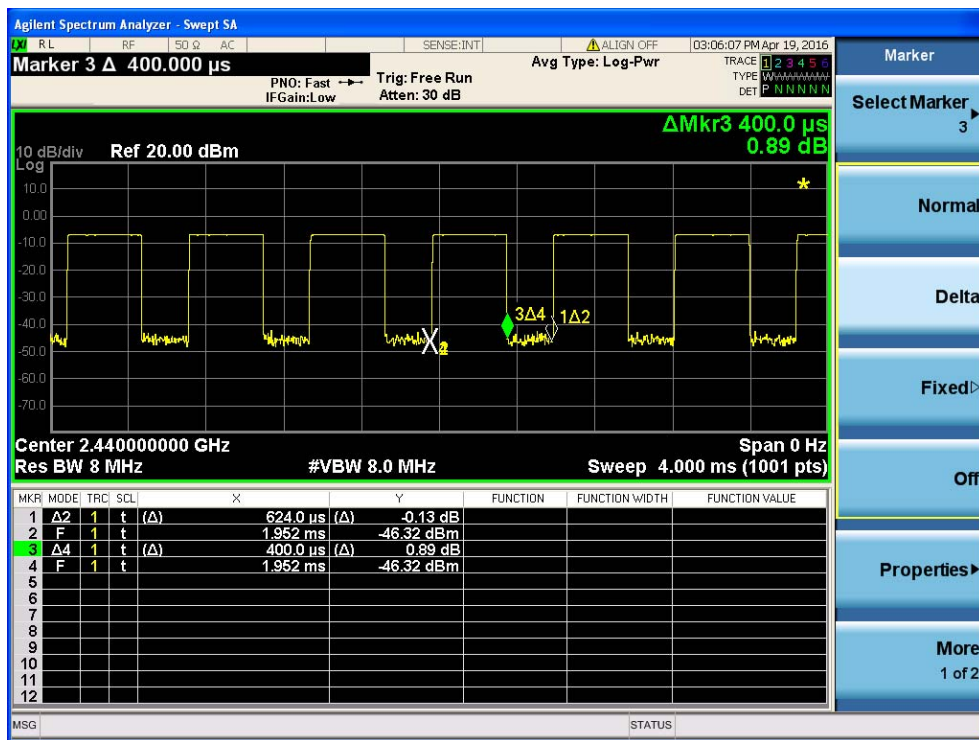

7.5 PEAK OUTPUT POWER

7.5.1 Applicable Standard

According to FCC Part 15.247(b)(3) and KDB 558074 DTS 01 Meas. Guidance v03r04

7.5.2 Conformance Limit

The maximum peak conducted output power of the intentional radiator for systems using digital modulation in the 2400 - 2483.5 MHz bands shall not exceed: 1 Watt (30dBm). If transmitting antenna of directional gain greater than 6dBi is used, the peak output power from the intentional radiator shall be reduced below the above stated value by the amount in dB that the directional gain of the antenna exceeds 6 dBi. In case of point-to-point operation, the limit has to be reduced by 1dB for every 3dB that the directional gain of the antenna exceeds 6dBi.

7.5.3 Measuring Instruments

The Measuring equipment is listed in the section 6.3 of this test report.

7.5.4 Test Setup

Please refer to Section 6.1 of this test report.

7.5.5 Test Procedure

The testing follows KDB 558074 DTS 01 Meas. Guidance v03r04
 The RF output of EUT was connected to the spectrum analyzer by RF cable and attenuator.
 The path loss was compensated to the results for each measurement.
 Set to the maximum power setting and enable the EUT transmit continuously.
 The EUT was operating in controlled its channel.
 Use the following spectrum analyzer settings:
 Set the RBW \cong DTS bandwidth(about 1MHz).
 Set VBW =3*RBW(about 3MHz)
 Set the span \cong 3*RBW
 Set Sweep time = auto couple.
 Set Detector = peak.
 Set Trace mode = max hold.
 Allow trace to fully stabilize.
 Use peak marker function to determine the peak amplitude level.

7.5.6 Test Results

EUT:	4inch 3G Dual SIM Smart phone	Model No.:	T4016
Temperature:	20 °C	Relative Humidity:	48%
Test Mode:	Mode2/Mode3/ Mode4	Test By:	Jack Li

Test Channel	Frequency (MHz)	Power Setting	Peak Output Power (dBm)	LIMIT (dBm)	Verdict
1Mbps					
00	2402	Default	-7.455	30	PASS
19	2440	Default	-6.894	30	PASS
39	2480	Default	-5.884	30	PASS

Peak output Power plot on channel 00

1Mbps

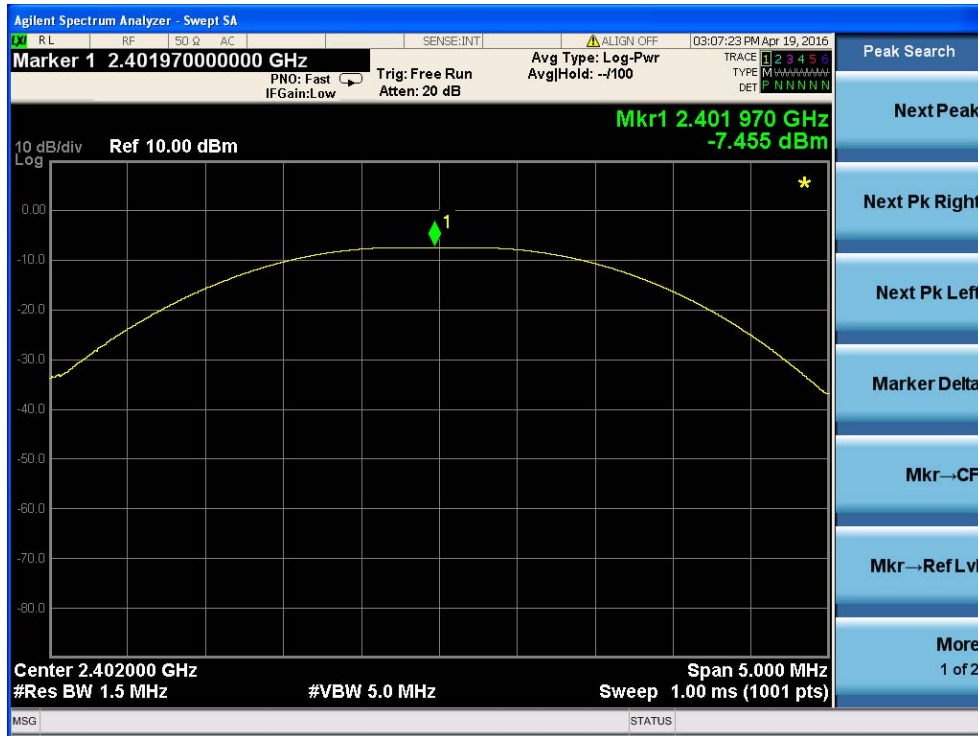

Peak output Power plot on channel 19

1Mbps

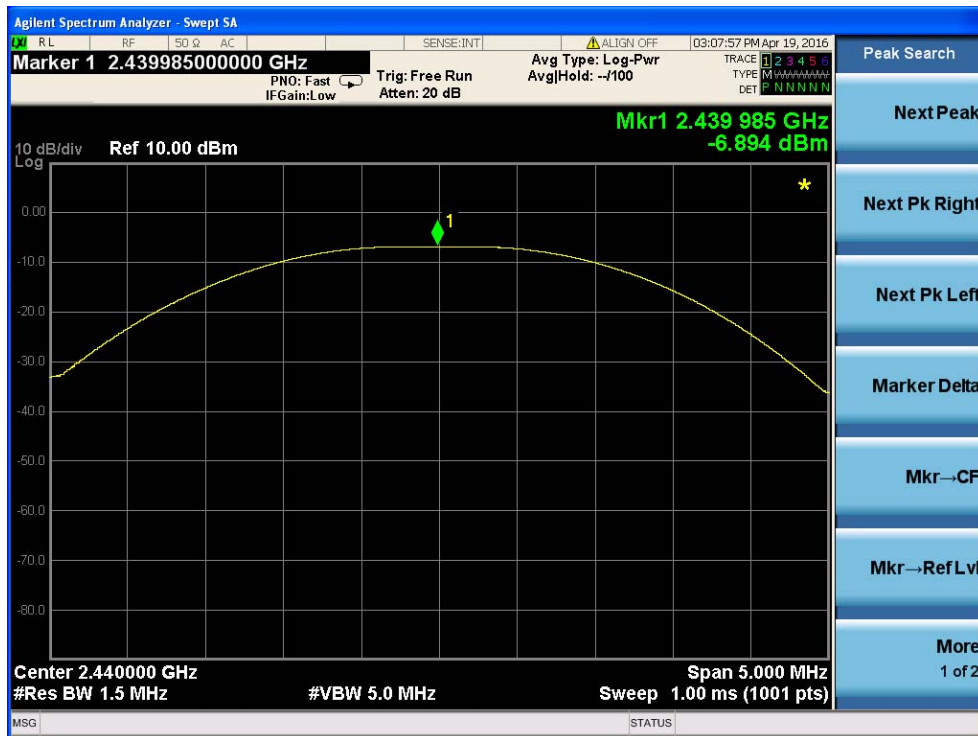

Peak output Power plot on channel 39

1Mbps



7.6 POWER SPECTRAL DENSITY

7.6.1 Applicable Standard

According to FCC Part 15.247(e) and KDB 558074 DTS 01 Meas. Guidance v03r04

7.6.2 Conformance Limit

The transmitter power spectral density conducted from the transmitter to the antenna shall not be greater than 8 dBm in any 3 kHz band during any time interval of continuous transmission.

7.6.3 Measuring Instruments

The Measuring equipment is listed in the section 6.3 of this test report.

7.6.4 Test Setup

Please refer to Section 6.1 of this test report.

7.6.5 Test Procedure

The testing follows Measurement Procedure 10.3 Method AVGPSD of FCC KDB Publication No. 558074 D01 DTS Meas. Guidance v03r04

This procedure may be used when the maximum (average) conducted output power was used to demonstrate compliance to the output power limit. This is the baseline method for determining the maximum (average) conducted PSD level. If the instrument has an RMS power averaging detector, it must be used; otherwise, use the sample detector. The EUT must be configured to transmit continuously (duty cycle $\geq 98\%$); otherwise sweep triggering/signal gating must be implemented to ensure that measurements are made only when the EUT is transmitting at its maximum power control level (no transmitter off time is to be considered).

The RF output of EUT was connected to the spectrum analyzer by RF cable and attenuator.

The path loss was compensated to the results for each measurement.

Set to the maximum power setting and enable the EUT transmit continuously.

The EUT was operating in controlled its channel.

a) Set instrument center frequency to DTS channel center frequency.

b) Set span to at least 1.5 times the OBW.

c) Set RBW to: $3 \text{ kHz} \leq \text{RBW} \leq 100 \text{ kHz}$.

d) Set VBW $\geq 3 \times \text{RBW}$.

e) Detector = power averaging (RMS) or sample detector (when RMS not available).

f) Ensure that the number of measurement points in the sweep $\geq 2 \times \text{span}/\text{RBW}$.

g) Sweep time = auto couple.

h) Employ trace averaging (RMS) mode over a minimum of 100 traces.

i) Use the peak marker function to determine the maximum amplitude level.

j) If measured value exceeds limit, reduce RBW (no less than 3 kHz) and repeat (note that this may require zooming in on the emission of interest and reducing

7.6.6 Test Results

EUT:	4inch 3G Dual SIM Smart phone	Model No.:	T4016
Temperature:	20 °C	Relative Humidity:	48%
Test Mode:	Mode2/Mode3/ Mode4	Test By:	Jack Li

Test Channel	Frequency (MHz)	Power Density (dBm/3KHz)	Limit (dBm/3KHz)	Verdict
1Mbps				
00	2402	-22.950	8	PASS
19	2440	-22.401	8	PASS
39	2480	-21.389	8	PASS

Power spectral density plot on channel 00

1Mbps

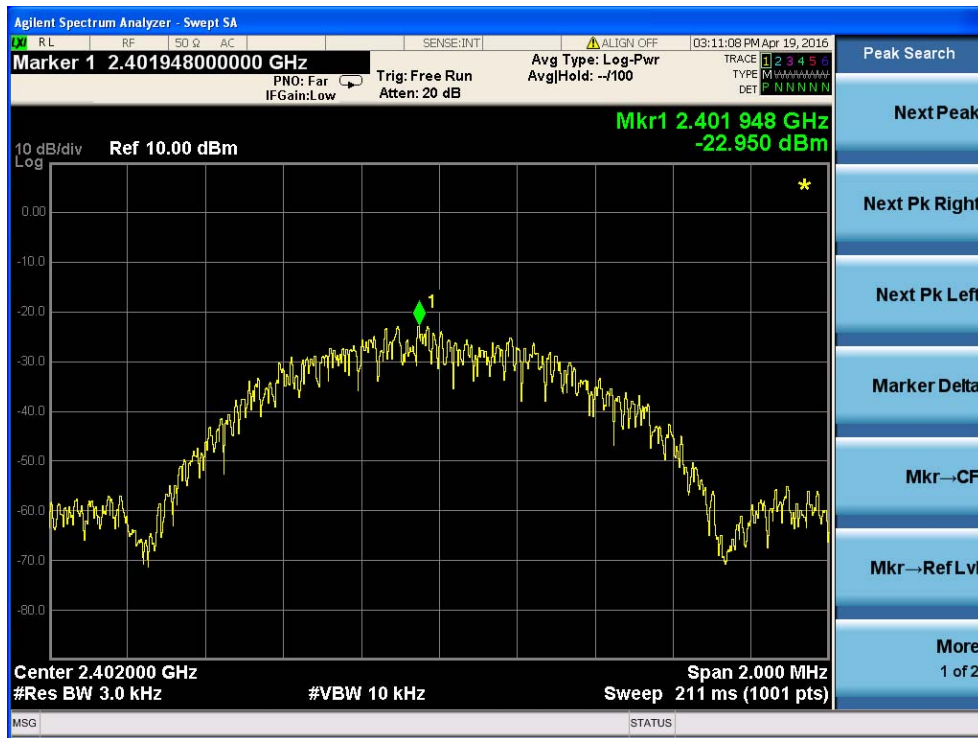

Power spectral density plot on channel 19

1Mbps

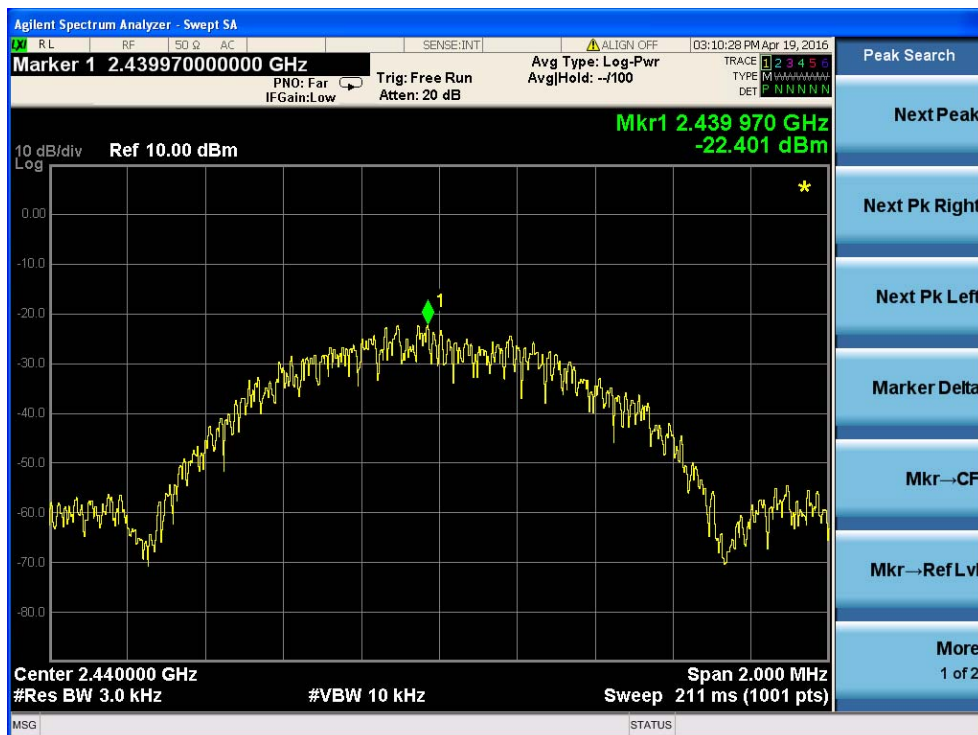

Power spectral density plot on channel 39

1Mbps

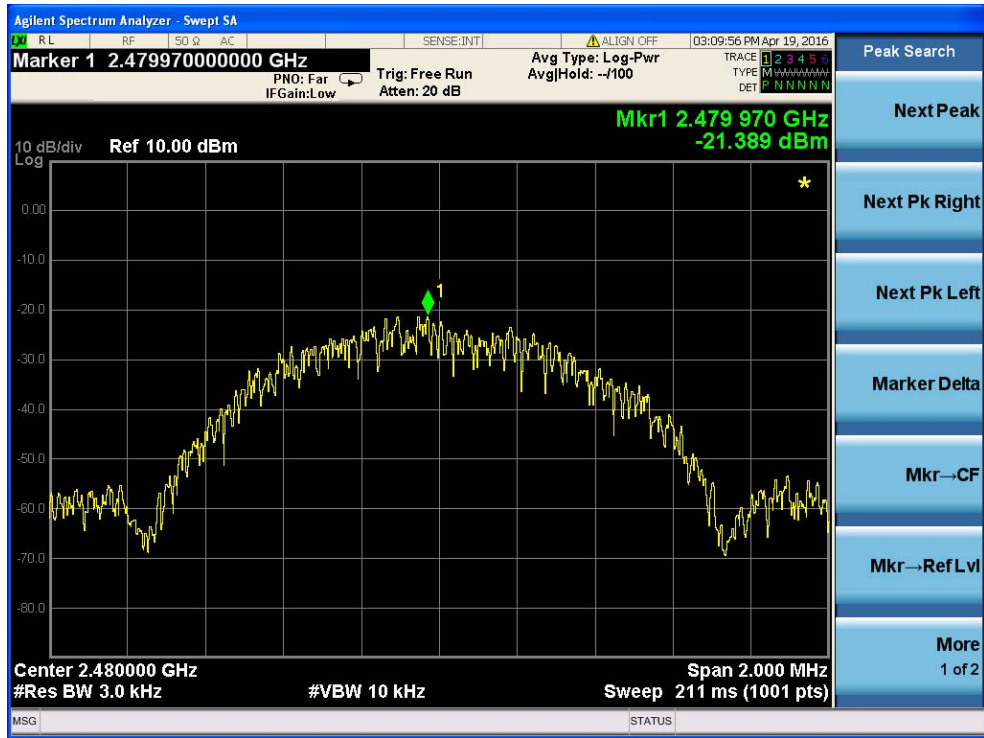

7.7 CONDUCTED BAND EDGE MEASUREMENT

7.7.1 Applicable Standard

According to FCC Part 15.247(d) and KDB 558074 DTS 01 Meas. Guidance v03r04

7.7.2 Conformance Limit

In any 100 kHz bandwidth outside the frequency band in which the spread spectrum or digitally modulated intentional radiator is operating, the radio frequency power that is produced by the intentional radiator shall be at least 20 dB below that in the 100 kHz bandwidth within the band that contains the highest level of the desired power, based on either an RF conducted or a radiated measurement, provided the transmitter demonstrates compliance with the peak conducted power limits. If the transmitter complies with the conducted power limits based on the use of RMS averaging over a time interval, as permitted under paragraph (b)(3) of this section, the attenuation required under this paragraph shall be 30 dB instead of 20 dB.

7.7.3 Measuring Instruments

The Measuring equipment is listed in the section 6.3 of this test report.

7.7.4 Test Setup

Please refer to Section 6.1 of this test report.

7.7.5 Test Procedure

The testing follows FCC KDB Publication No. 558074 D01 DTS Meas. Guidance v03r04.
 The RF output of EUT was connected to the spectrum analyzer by RF cable and attenuator.
 The path loss was compensated to the results for each measurement.
 Set to the maximum power setting and enable the EUT transmit continuously.
 The EUT was operating in controlled its channel.
 Set RBW to 100 kHz and VBW of spectrum analyzer to 300 kHz with a convenient frequency span including 100 kHz bandwidth from band edge.
 Measure the highest amplitude appearing on spectral display and set it as a reference level. Plot the graph with marking the highest point and edge frequency.
 Repeat above procedures until all measured frequencies were complete.

7.7.6 Test Results

EUT:	4inch 3G Dual SIM Smart phone	Model No.:	T4016
Temperature:	20 °C	Relative Humidity:	48%
Test Mode:	Mode2/Mode3/ Mode4	Test By:	Jack Li

Frequency Band	Delta Peak to band emission(dBc)	>Limit(dBc)	Verdict
Left-band	54.678	20	Pass
Right-band	58.864	20	Pass

7.8 ANTENNA APPLICATION

7.8.1 Antenna Requirement

15.203 requirement: For intentional device, according to 15.203: an intentional radiator shall be designed to ensure that no antenna other than that furnished by the responsible party shall be used with the device.

7.8.2 Result

The EUT antenna is permanent attached antenna. It comply with the standard requirement.

END OF REPORT