

December 23, 2020

Bluecats US LLC
6767 Old Madison Pike Suite 300
Huntsville, Alabama 35806
USA

Dear Kurt Nehrenz,

Enclosed is the EMC Wireless test report for compliance testing of the Bluecats US LLC, BC4520 ProxPoint as tested to the requirements of Title 47 of the CFR Part 15.407 Subpart E for Intentional Radiators.

Thank you for using the services of Eurofins E&E North America. If you have any questions regarding these results or if we can be of further service to you, please feel free to contact me.

Sincerely yours,
Eurofins MET LABORATORIES, INC.



Arsalan Hasan
Wireless Laboratory

Reference: (\Bluecats US LLC\WIRS109093-FCC-407 Rev 0)



Certificates and reports shall not be reproduced except in full, without the written permission of Eurofins E&E North America. While use of the A2LA logo in this report reflects Eurofins accreditation under these programs, the report must not be used by the client to claim product certification, approval, or endorsement by A2LA or any agency of the Federal Government. This letter of transmittal is not a part of the attached report.

Eurofins MET Laboratories Inc. (Eurofins E&E North America) is part of the Eurofins Electrical & Electronics (E&E) global compliance network.

Electromagnetic Compatibility Criteria Test Report

For the

**Bluecats US LLC
BC4520 ProxPoint**

Tested under
the FCC Certification Rules
contained in
15.407 Subpart E for Intentional Radiators

Report: WIRS109093-FCC-407 Rev 0

December 23, 2020

Prepared For:

**Bluecats US LLC
6767 Old Madison Pike Suite 300
Huntsville, Alabama 35806
USA**

Prepared By:
Eurofins E&E North America
3162 Belick Street
Santa Clara, CA 95054

Electromagnetic Compatibility Criteria Test Report

For the

Bluecats US LLC
BC4520 ProxPoint

Tested under
the FCC Certification Rules
contained in
15.407 Subpart E for Intentional Radiators

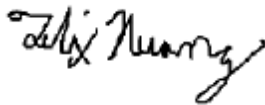

Felix Huang
Engineer, Wireless Laboratory



Arsalan Hasan
Manager, Wireless Laboratory

Engineering Statement: The measurements shown in this report were made in accordance with the procedures indicated, and the emissions from this equipment were found to be within the limits applicable. I assume full responsibility for the accuracy and completeness of these measurements, and for the qualifications of all persons taking them. It is further stated that upon the basis of the measurements made, the equipment tested is capable of operation in accordance with the requirements of Parts 15E, 15407, of the FCC Rules under normal use and maintenance.

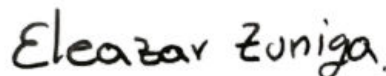

Eleazar Zuniga, PhD.
Director, Wireless Technologies

Report Status Sheet

Revision	Report Date	Reason for Revision
∅	December 23, 2020	Initial Issue.

Table of Contents

I.	Executive Summary	6
	1.1 Purpose of Test.....	7
	1.2 Executive Summary	7
II.	Equipment Configuration	8
	2.1 Overview.....	9
	2.2 References.....	10
	2.3 Test Site	10
	2.4 Measurement Uncertainty	10
	2.5 Description of Test Sample.....	10
	2.6 Equipment Configuration.....	11
	2.7 Support Equipment	11
	2.8 Ports and Cabling Information.....	11
	2.9 Mode of Operation.....	12
	2.10 Method of Monitoring EUT Operation	12
	2.11 Modifications	12
	2.11.1 Modifications to EUT.....	12
	2.11.2 Modifications to Test Standard.....	12
	2.12 Disposition of EUT	12
III.	Electromagnetic Compatibility Criteria for Intentional Radiators.....	13
	§ 15.203 Antenna Requirement.....	14
	§ 15.407(b)(6) Conducted Emissions	15
	§ 15.407(b) & (6 - 7) Undesirable Emissions	19
IV.	Test Equipment	58

List of Terms and Abbreviations

AC	Alternating Current
ACF	Antenna Correction Factor
Cal	Calibration
<i>d</i>	Measurement Distance
dB	Decibels
dB μ A	Decibels above one microamp
dB μ V	Decibels above one microvolt
dB μ A/m	Decibels above one microamp per meter
dB μ V/m	Decibels above one microvolt per meter
DC	Direct Current
E	Electric Field
DSL	Digital Subscriber Line
ESD	Electrostatic Discharge
EUT	Equipment Under Test
<i>f</i>	Frequency
FCC	Federal Communications Commission
GRP	Ground Reference Plane
H	Magnetic Field
HCP	Horizontal Coupling Plane
Hz	Hertz
IEC	International Electrotechnical Commission
kHz	Kilohertz
kPa	Kilopascal
kV	Kilovolt
LISN	Line Impedance Stabilization Network
MHz	Megahertz
μ H	Microhenry
μ	Microfarad
μ s	Microseconds
PRF	Pulse Repetition Frequency
RF	Radio Frequency
RMS	Root-Mean-Square
TWT	Traveling Wave Tube
V/m	Volts per meter
VCP	Vertical Coupling Plane

I. Executive Summary

1.1 Purpose of Test

An EMC evaluation was performed to determine compliance of the Bluecats US LLC BC4520 ProxPoint, with the requirements of Part 15, §15.407. All references are to the most current version of Title 47 of the Code of Federal Regulations in effect. In accordance with §2.1033, the following data is presented in support of the Certification of the BC4520 ProxPoint. Trimble should retain a copy of this document which should be kept on file for at least two years after the manufacturing of the BC4520 ProxPoint, has been **permanently** discontinued.

1.2 Executive Summary

The following tests were conducted on a sample of the equipment for the purpose of demonstrating compliance with Part 15, §15.407, in accordance with Trimble Jena GmbH, purchase order number PO-BCUS-00608. All tests were conducted using measurement procedure ANSI C63.10-2013.

FCC Reference	Description	Results
§15.203	Antenna Requirement	Compliant
§15.403(i)	26dB Occupied Bandwidth	Data valid from module original certification FCC ID: XF6-M7DB6t
§15.407 (a)(1)	Maximum Conducted Output Power	Data valid from module original certification FCC ID: XF6-M7DB6
§15.407 (a)(1)	Maximum Power Spectral Density	Data valid from module original certification FCC ID: XF6-M7DB6
§15.407 (b)(1)& (6 - 7)	Undesirable Emissions	Compliant
§15.407(b)(6)	Conducted Emission Limits	Compliant
§15.407(g)	Frequency Stability	Data valid from module original certification FCC ID: XF6-M7DB6

Table 1. Executive Summary of EMC Part 15.407 Compliance Testing

Rationale: Per KDB KDB 996369 D04 “Modular Transmitter Integration Guide – Guidance for Host Product Manufacturers” only worst-case radiated measurements are reported in this filing.

II. Equipment Configuration

2.1 Overview

Eurofins MET Laboratories, Inc. was contracted by Trimble Jena GmbH to perform testing on the Bluecats US LLC, under Trimble’s purchase order number PO-BCUS-00608.

This document describes the test setups, test methods, required test equipment, and the test limit criteria used to perform compliance testing of the Bluecats US LLC BC4520 ProxPoint.

The results obtained relate only to the item(s) tested.

Model(s) Tested:	BC4520 ProxPoint	
Model(s) Covered:	BC4520 ProxPoint	
Filing Status:	Original	
EUT Specifications:	Primary Power: 120V (AC/DC Adaptor)	
	FCC ID: 2AHXCBC4520	
	Module Original Report Number(s): Report: 1901FR17 Note: BT, BLE & ZigBee have been disabled in the RedPine module.	
	Type of Modulations:	BPSK, QPSK, 16QAM
	Equipment Code:	NII
	Max. RF Output Power:	14 dBm
	EUT Frequency Ranges:	5180 MHz – 5825 MHz
Analysis:	The results obtained relate only to the item(s) tested.	
Environmental Test Conditions:	Temperature: 15-35° C	
	Relative Humidity: 30-60%	
	Barometric Pressure: 860-1060 mbar	
Evaluated by:	Arsalan Hasan	
Report Date(s):	December 23, 2020	

Table 2. EUT Summary

2.2 References

CFR 47, Part 15, Subpart E	Unlicensed National Information Infrastructure Devices (UNII)
ANSI C63.4:2014	Methods and Measurements of Radio-Noise Emissions from Low-Voltage Electrical And Electronic Equipment in the Range of 9 kHz to 40 GHz
ISO/IEC 17025:2005	General Requirements for the Competence of Testing and Calibration Laboratories
ANSI C63.10-2013	American National Standard for Testing Unlicensed Wireless Devices
789033 D02 General UNII Test Procedures New Rules v02	Guidelines for Compliance Testing of Unlicensed National Information Infrastructure (U-NII) Devices Part 15, Subpart E
KDB 662911	Guidance for Measurement of Transmitters with Multiple Output MIMO.

Table 3. References

2.3 Test Site

All testing was performed at Eurofins MET Labs, 3162 Belick St., Santa Clara, CA 95054. All equipment used in making physical determinations is accurate and bears recent traceability to the National Institute of Standards and Technology.

Eurofins MET Labs is a ISO/IEC 17025 accredited site by A2LA, California #0591.02.

2.4 Measurement Uncertainty

Test Method	Typical Expanded Uncertainty	K	Confidence Level
RF Frequencies	±4.52 Hz	2	95%
RF Power Conducted Emissions	±2.32 dB	2	95%
RF Power Conducted Spurious Emissions	±2.25 dB	2	95%
RF Power Radiated Emissions	±3.01 dB	2	95%

Table 4. Measurement Uncertainty

2.5 Description of Test Sample

The Bluecats US LLC BC4520 ProxPoint is an RTLS gateway that receives Bluetooth transmissions from beacons and tags, filters and processes location and sensor information, and forwards to a server via Ethernet, Wi-Fi, or LTE.

2.6 Equipment Configuration

The EUT was set up as outlined in **Error! Reference source not found.**, Block Diagram of Test Setup. All cards, racks, etc., incorporated as part of the EUT is included in the following list.

Ref. ID	Slot #	Name / Description	Model Number	Part Number	Serial Number	Revision
	NA	BC4520 ProxPoint	BC4520	NA	NA	NA
	BT1, BT4	Bluetooth Stick Antenna, Right Angle	W5029	NA	NA	NA
	BT2, BT3	Bluetooth Stick Antenna, Straight	W5029RPGT	NA	NA	NA
	LTE	LTE Flat Bar Antenna, 2m cable	ANT-LTE-VDP-2000-SMA	NA	NA	NA
	GNSS	GPS GLONASS SMA, 3m cable	ANT-GPS-SH2-SMA	NA	NA	NA
	PWR	Power Adapter	GST25A12-P1J	NA	NA	NA
	ETH	M12 X-Coded to RJ45 10m cable	ETH	NA	NA	NA

Table 5: Equipment Configuration

2.7 Support Equipment

Support equipment necessary for the operation and testing of the EUT is included in the following list.

Ref. ID	Name / Description	Manufacturer	Model Number	*Customer Supplied Calibration Data
	Laptop with Windows 10	HP	NA	N/A

Table 6: Support Equipment

2.8 Ports and Cabling Information

Ref. ID	Port name on EUT	Cable Description or reason for no cable	Qty	Length as tested (m)	Max Length (m)	Shielded? (Y/N)	Termination Box ID & Port Name
	BT1	W5029 Antenna	1	NA	NA	NA	NA
	BT2	W5029RPGT Antenna	1	NA	NA	NA	NA
	BT3	W5029RPGT Antenna	1	NA	NA	NA	NA
	BT4	W5029 Antenna	1	NA	NA	NA	NA
	LTE	ANT-LTE-VDP-2000-SMA Antenna	1	2m	NA	Yes	NA
	GNSS	ANT-GPS-SH2-SMA Antenna	1	3m	NA	Yes	NA
	ETH	M12 X-Coded connector to RJ45	1	10m	NA	Yes	NA
	PWR	M12 A-Coded terminated GST25A12-P1J Power Adapter	1	NA	NA	NA	(120v/60hz)

Table 7: Ports and Cabling Information

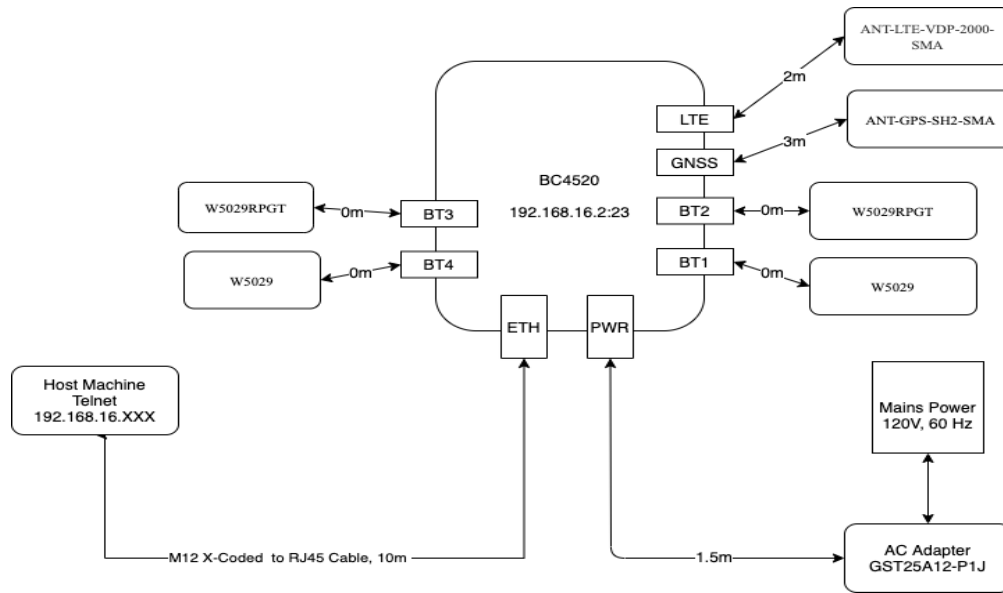

Figure 1: EUT configuration

2.9 Mode of Operation During Testing

Standard test mode was used. Allows independent activation of all radios in their various test modes, as well as methods to generate traffic similar to normal operation on all digital busses.

2.10 Method of Monitoring EUT Operation

The signal will be displayed on a spectrum analyzer.

2.11 Modifications

2.11.1 Modifications to EUT

No modifications were made to the EUT.

2.11.2 Modifications to Test Standard

No modifications were made to the test standard.

2.12 Disposition of EUT

The test sample including all support equipment submitted to the Electro-Magnetic Compatibility Lab for testing was returned to Bluecats US LLC upon completion of testing.

III. Electromagnetic Compatibility Criteria for Intentional Radiators

Electromagnetic Compatibility Criteria for Intentional Radiators

§ 15.203 Antenna Requirement

Test Requirement: § 15.203: An intentional radiator shall be designed to ensure that no antenna other than that furnished by the responsible party shall be used with the device. The use of a permanently attached antenna or of an antenna that uses a unique coupling to the intentional radiator shall be considered sufficient to comply with the provisions of this section. The manufacturer may design the unit so that a broken antenna can be replaced by the user, but the use of a standard antenna jack or electrical connector is prohibited.

The structure and application of the EUT were analyzed to determine compliance with Section 15.203 of the Rules. Section 15.203 states that the subject device must meet at least one of the following criteria:

- a.) Antenna must be permanently attached to the unit.
- b.) Antenna must use a unique type of connector to attach to the EUT.
- c.) Unit must be professionally installed. Installer shall be responsible for verifying that the correct antenna is employed with the unit.

Results: The EUT as tested is compliant the criteria of §15.203.

Antenna are permanently attached.

Test Engineer(s): Felix Huang

Test Date(s): 11/25/2020

Gain	Type	Manufacturer
1.250 dBi	PCB Trace	RedPine Signals

Table 8: Antenna Requirement, Antenna List

Electromagnetic Compatibility Criteria for Intentional Radiators

§ 15.407(b)(6) Conducted Emissions

Test Requirement(s): § 15.407 (b)(6): Any U-NII devices using an AC power line are required to comply also with the conducted limits set forth in §15.207.

§ 15.207 (a): For an intentional radiator that is designed to be connected to the public utility (AC) power line, the radio frequency voltage that is conducted back onto the AC power line on any frequency or frequencies, within the band 150 kHz to 30MHz, shall not exceed the limits in the following table, as measured using a 50 $\mu\Omega$ /50 Σ line impedance stabilization network (LISN). Compliance with the provisions of this paragraph shall be based on the measurement of the radio frequency voltage between each power line and ground at the power terminal. The lower limit applies at the boundary between the frequency ranges.

Frequency range (MHz)	§ 15.207(a), Conducted Limit (dB μ V)	
	Quasi-Peak	Average
* 0.15- 0.45	66 – 56	56 - 46
0.45 - 0.5	56	46
0.5 - 30	60	50

Table 4. Conducted Limits for Intentional Radiators from FCC Part 15 § 15.207(a)

Test Procedure: The EUT was placed on a non-metallic table 80 cm tall inside a screen room. The EUT was situated such that the back of the EUT was 0.4 m from one wall of the vertical ground plane, and the remaining sides of the EUT were no closer than 0.8 m from any other conductive surface. The EUT was powered from a 50 Ω /50 μ H Line Impedance Stabilization Network (LISN). The EMC receiver scanned the frequency range from 150 kHz to 30 MHz. Conducted Emissions measurements were made in accordance with *ANSI C63.10-2013 "American National Standard of Procedures for Compliance Testing of Unlicensed Wireless Devices"*. Scans were performed with the transmitter on.

Test Results: The EUT **completed testing** to this requirement. Measured emissions were below applicable limits.

Test Engineer(s): Felix Huang

Test Date(s): 11/24/2020

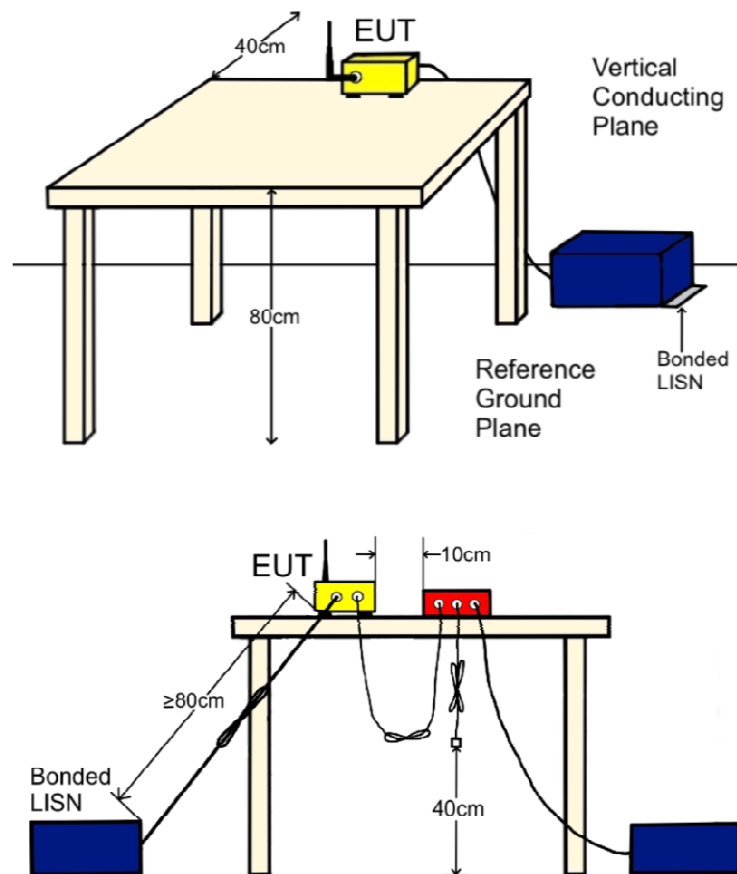
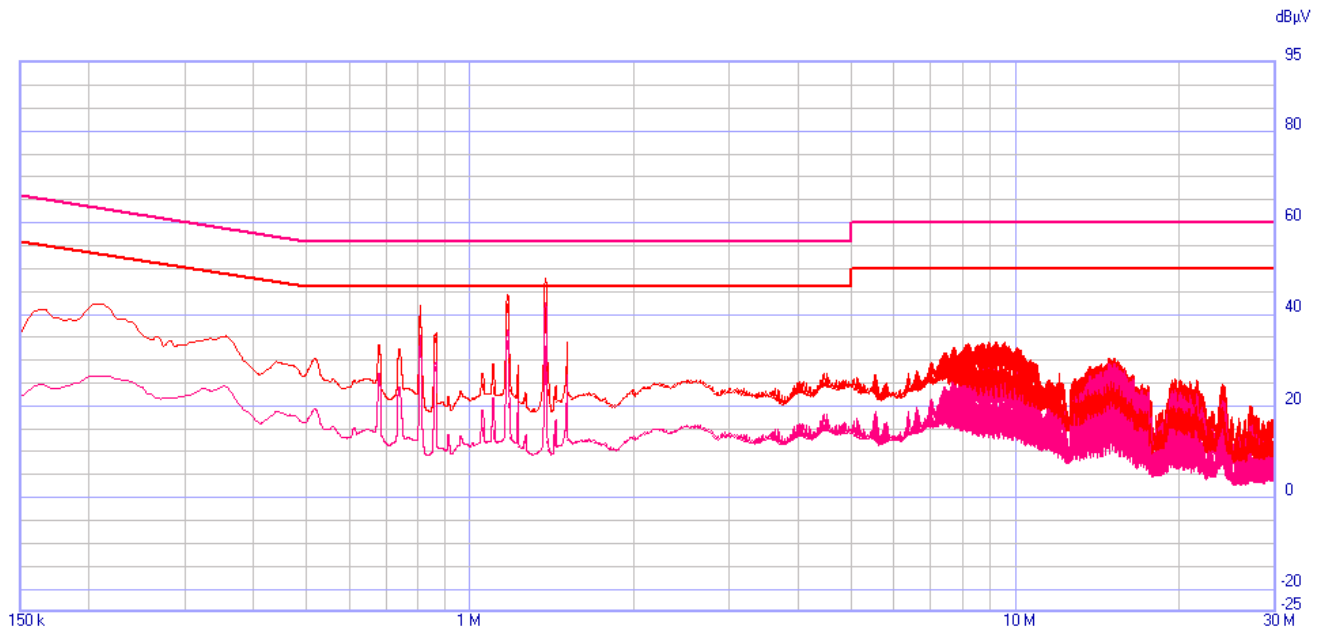

Figure 2: Conducted Emissions Voltage, Test Setup

LISN Ground Connection	VCP Ground Connection (<2.5mΩ)
1.4mΩ	1.4mΩ

	Freq (MHz)	QP Amplitude	QP Limit	Delta	Pass	Average Amplitude	Average Limit	Delta	Pass
Line	0.152045	39.33	65.888	-26.558	Pass	23.4	55.888	-32.488	Pass
Line	0.205215	50.51	63.404	-12.894	Pass	25.84	53.404	-27.564	Pass
Line	0.810535	43.25	56	-12.75	Pass	35.76	46	-10.24	Pass
Line	0.859615	37.86	56	-18.14	Pass	29.97	46	-16.03	Pass
Line	1.170455	45.5	56	-10.5	Pass	37.05	46	-8.95	Pass
Line	1.370865	46.85	56	-9.15	Pass	40.87	46	-5.13	Pass

Table 10: Conducted Emissions Limits, Line, Test Data



Plot 1: Conducted Emissions Limits, Line

	Freq (MHz)	QP Amplitude	QP Limit	Delta	Pass	Average Amplitude	Average Limit	Delta	Pass
Neutral	0.20726	37.7	63.322	-25.622	Pass	16.19	53.322	-37.132	Pass
Neutral	0.810535	36.09	56	-19.91	Pass	20.06	46	-25.94	Pass
Neutral	0.86166	30.74	56	-25.26	Pass	16.73	46	-29.27	Pass
Neutral	1.170455	38.77	56	-17.23	Pass	22.41	46	-23.59	Pass
Neutral	1.370865	42.56	56	-13.44	Pass	27.13	46	-18.87	Pass
Neutral	15.04373	30.63	60	-29.37	Pass	24.3	50	-25.7	Pass

Table 11: Conducted Emissions Limits, Neutral, Test Data

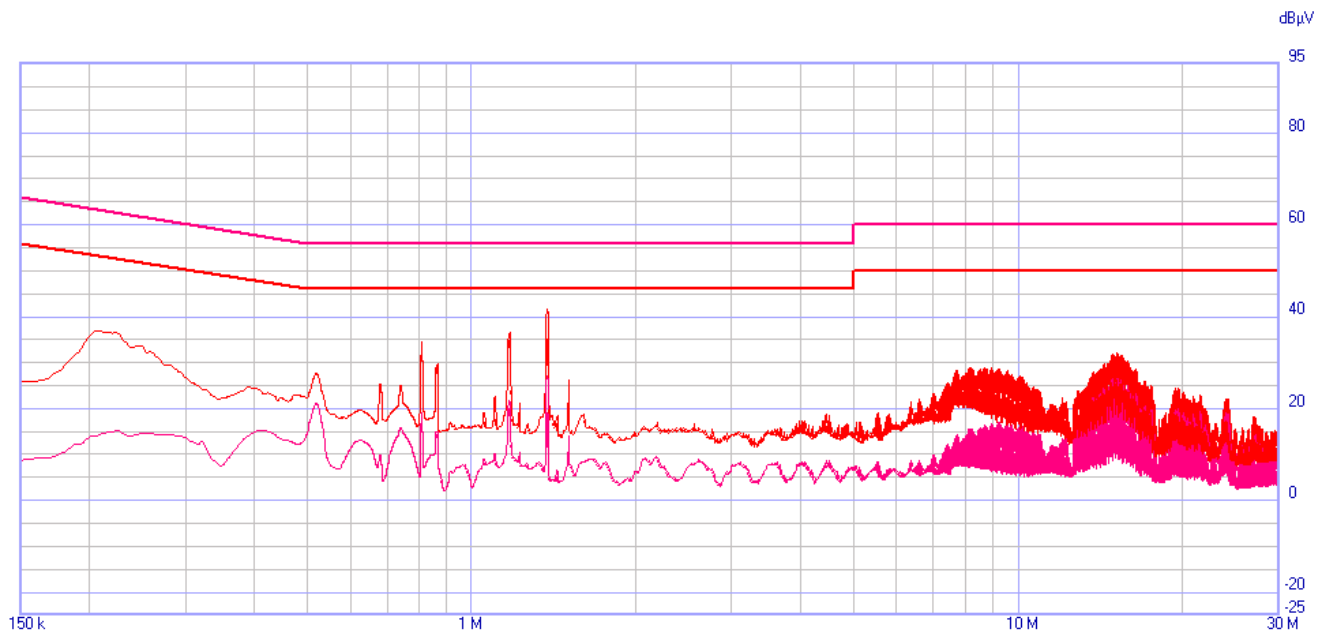

Plot 2: Conducted Emissions Limits, Neutral

Electromagnetic Compatibility Criteria for Intentional Radiators

§15.407(b)(1) & (6 – 7) Undesirable Emissions

Test Requirements: § 15.407(b)(1): For transmitters operating in the 5.15-5.25 GHz band: all emissions outside of the 5.15-5.35 GHz band shall not exceed an EIRP of -27 dBm/MHz.

§ 15.407(b)(6): Unwanted emissions below 1 GHz must comply with the general field strength limits set forth in Section 15.209. Further, any U-NII devices using an AC power line are required to comply also with the conducted limits set forth in Section 15.207.

§ 15.407(b)(7): The provisions of Section 15.205 of this part apply to intentional radiators operating under this section.

Test Procedure: The EUT was placed on a non-conducting stand on a turntable in a chamber. To find the maximum emission the EUT was set to transmit on low, mid, and high channels. Additionally, the turntable was rotated 360 degrees, the EUT was oriented through its three orthogonal axes, and the receive antenna height was varied in order to maximize emissions.

For frequencies from 30 MHz to 1 GHz, measurements were first made using a peak detector with a 100 kHz resolution bandwidth. Emissions which exceeded the limits were re-measured using a quasi-peak detector with a 120 kHz resolution bandwidth.

Above 1 GHz, measurements were made pursuant the method described in FCC KDB 789033 D02 General UNII Test Procedure New Rules v02. The equation, $EIRP = E + 20 \log D - 104.8$ was used to convert field strength to EIRP (E = field strength (dBμV/m) and D = Reference measurement distance).

For emissions above 1 GHz and in restricted bands, measurements of the field strength were made with a peak detector and an average detector and compared with the limits of 15.209.

As an alternative, according to FCC KDB 789033 D02 General UNII Test Procedure New Rules v02, all emissions that comply with the peak and average limits of 15.209 satisfy the requirements of unwanted emissions in 15.407.

Test Results: EUT was compliant with the requirements of this section. Only noise was observed above 18 GHz and below 30 MHz. Emissions were investigated upto 10th harmonics. Only worst data are presented in this report except band edges.

Measured emissions were within applicable limits.

Test Engineer(s): Felix Huang

Test Date(s): 11/24/2020

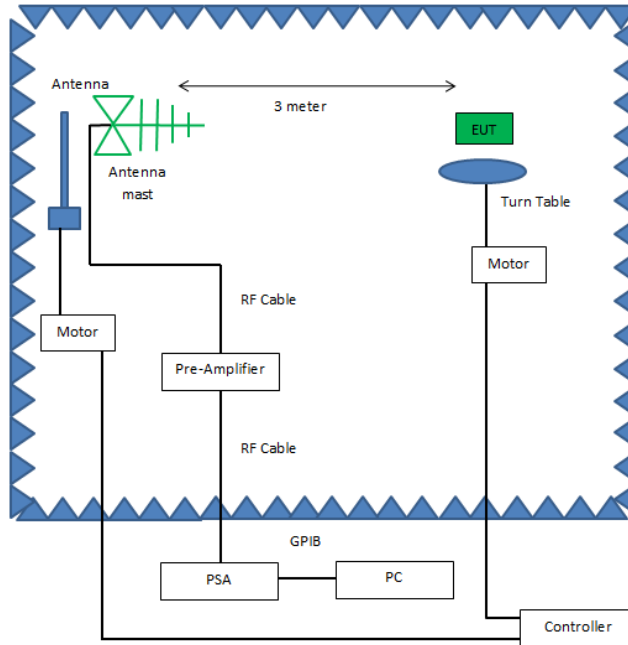

Figure 3: Radiated Emissions, Below 1GHz, Test Setup

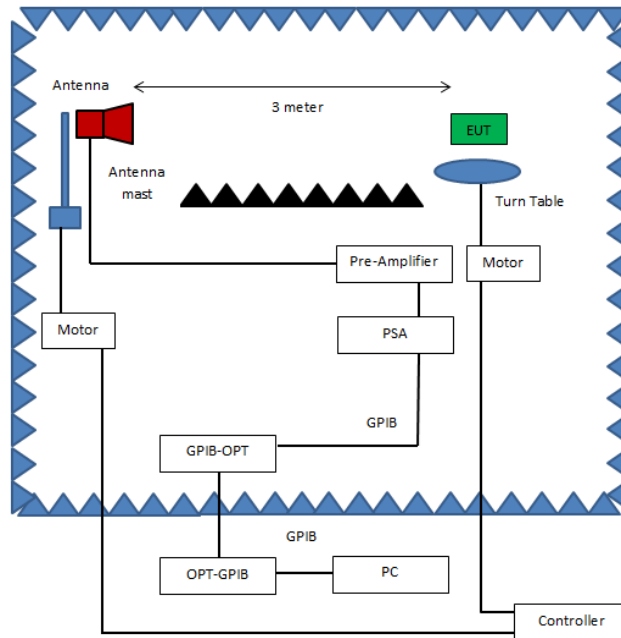
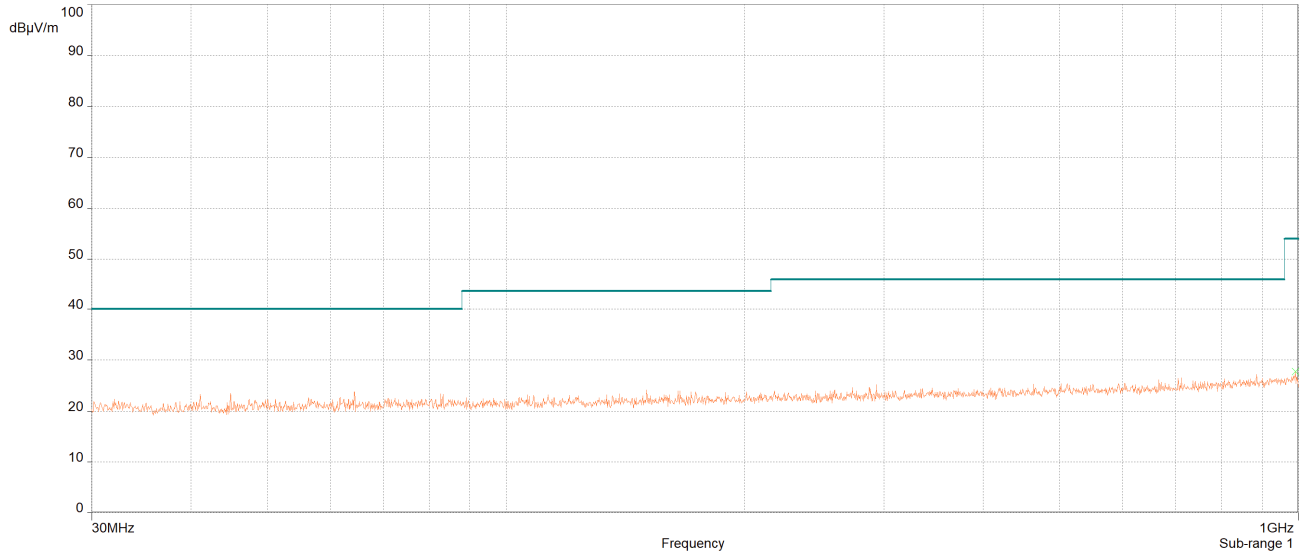
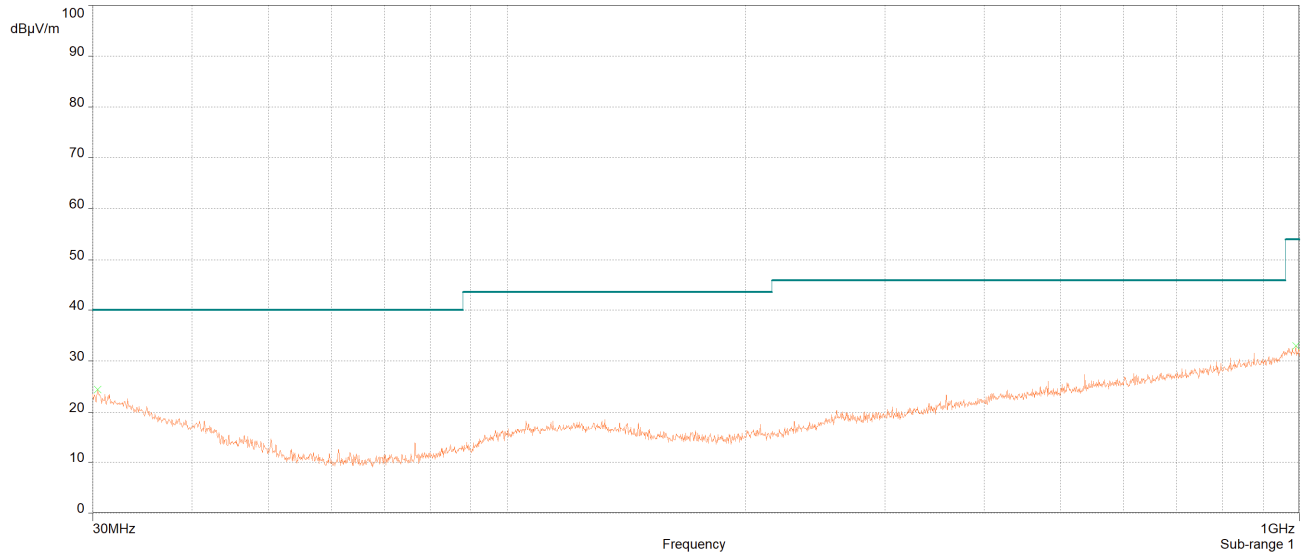

Figure 4: Radiated Emissions, Above 1GHz, Test Setup



Vertical



Horizontal

Plot 3: Radiated Emissions, 30 MHz - 1 GHz, (worst case)

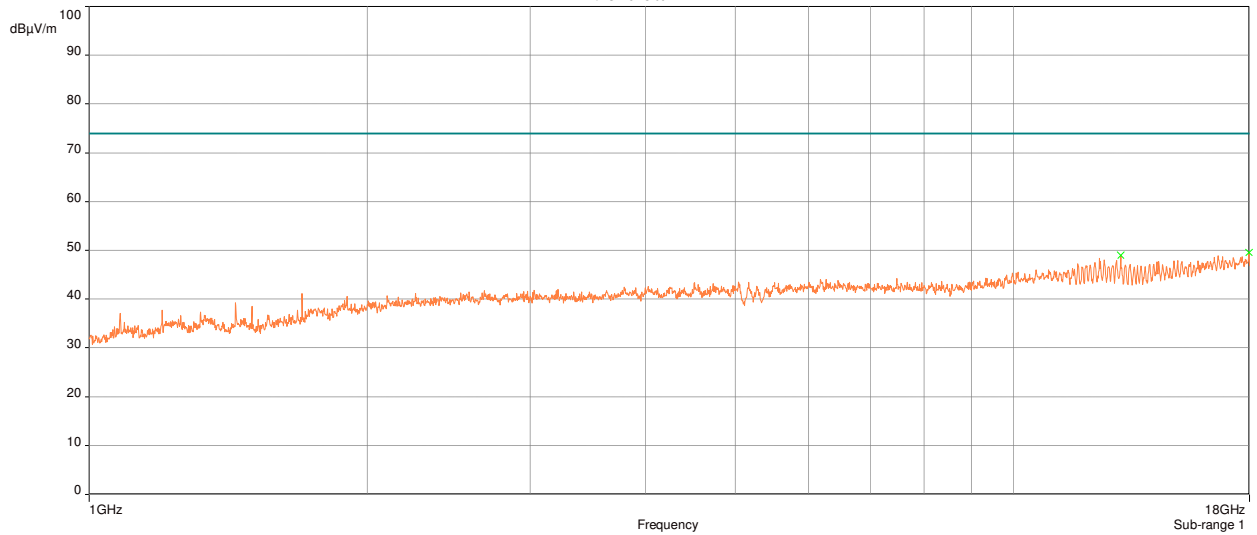
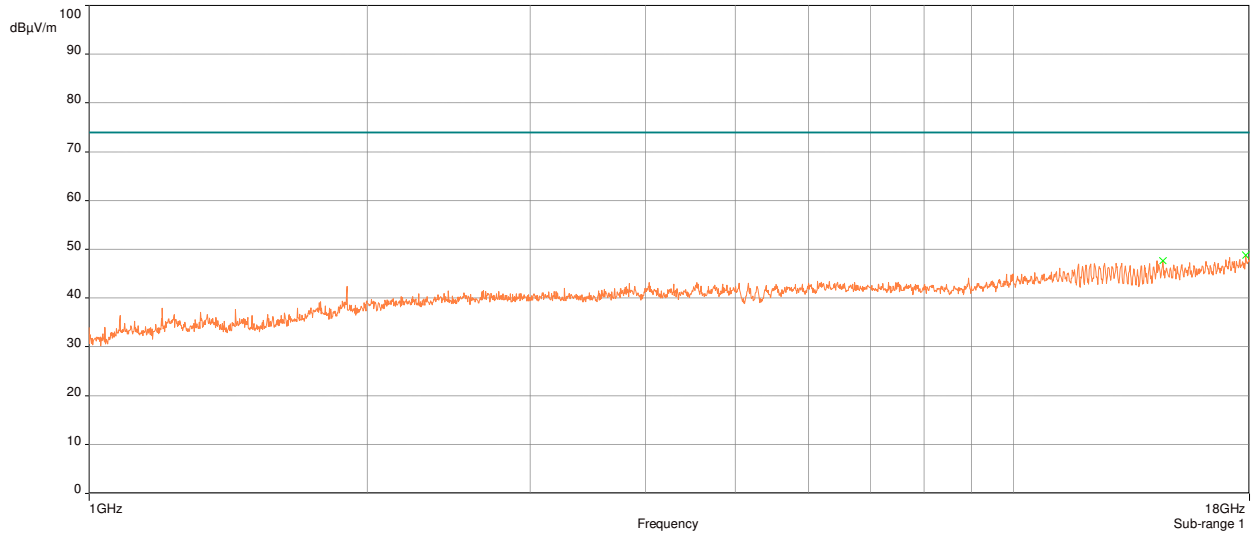

Plot 4: Radiated Spurious Emissions Requirements, 802.11a, Low Channel UNII-1, Peak

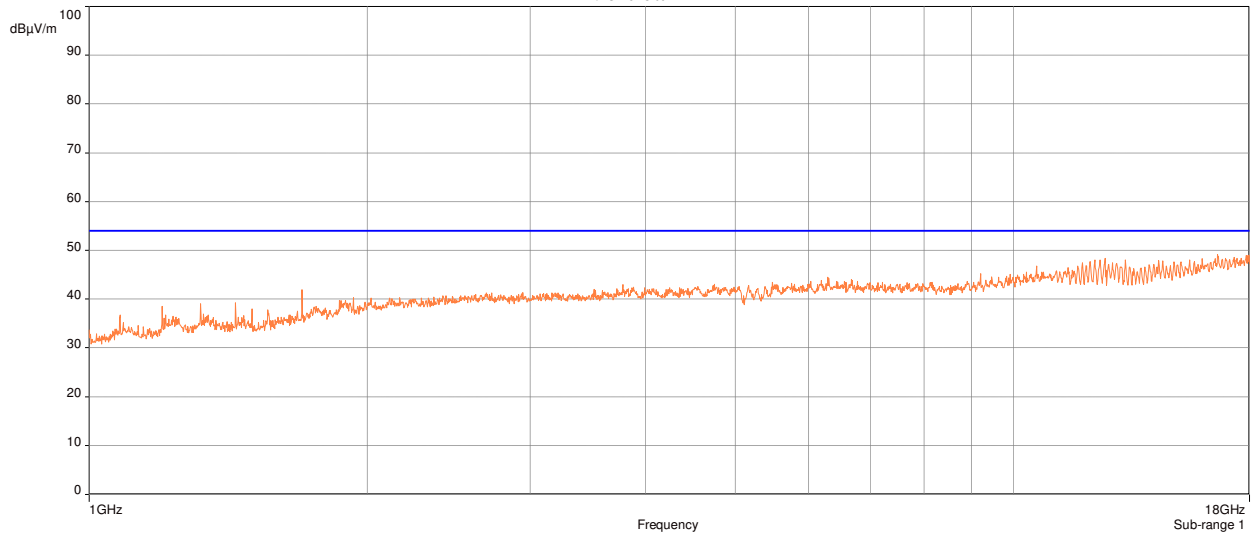
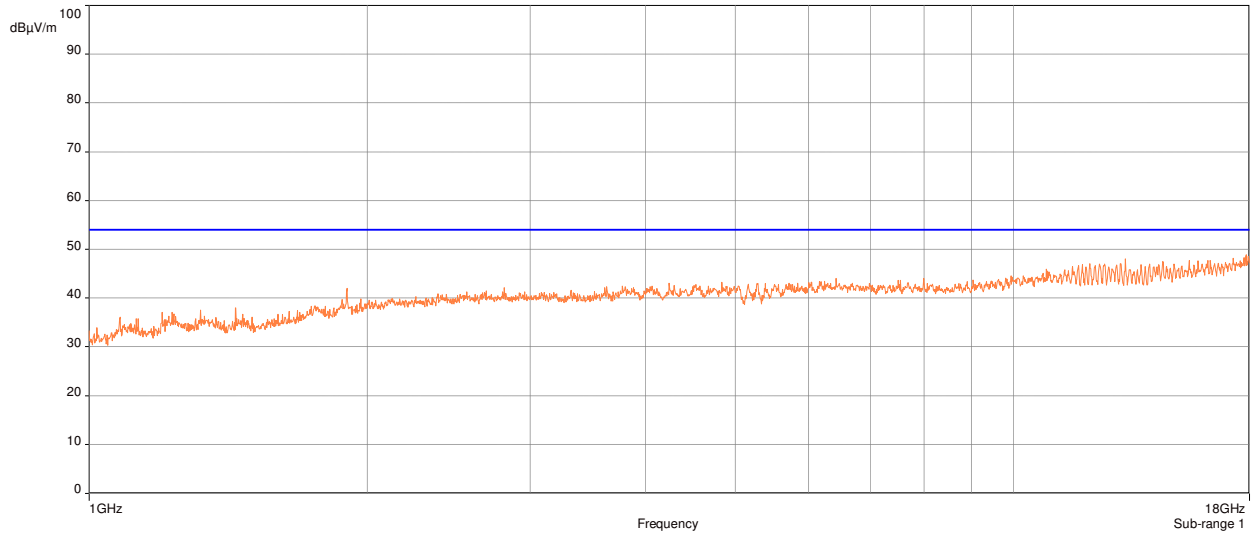

Plot 5: Radiated Spurious Emissions Requirements, 802.11a, Low Channel UNII-1, Average

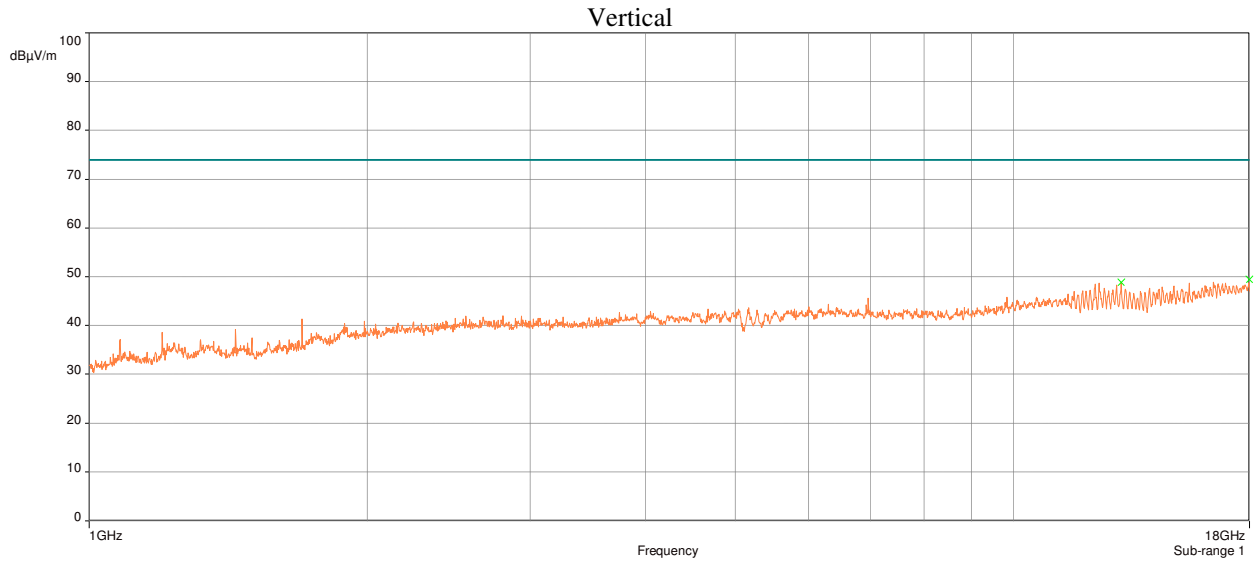
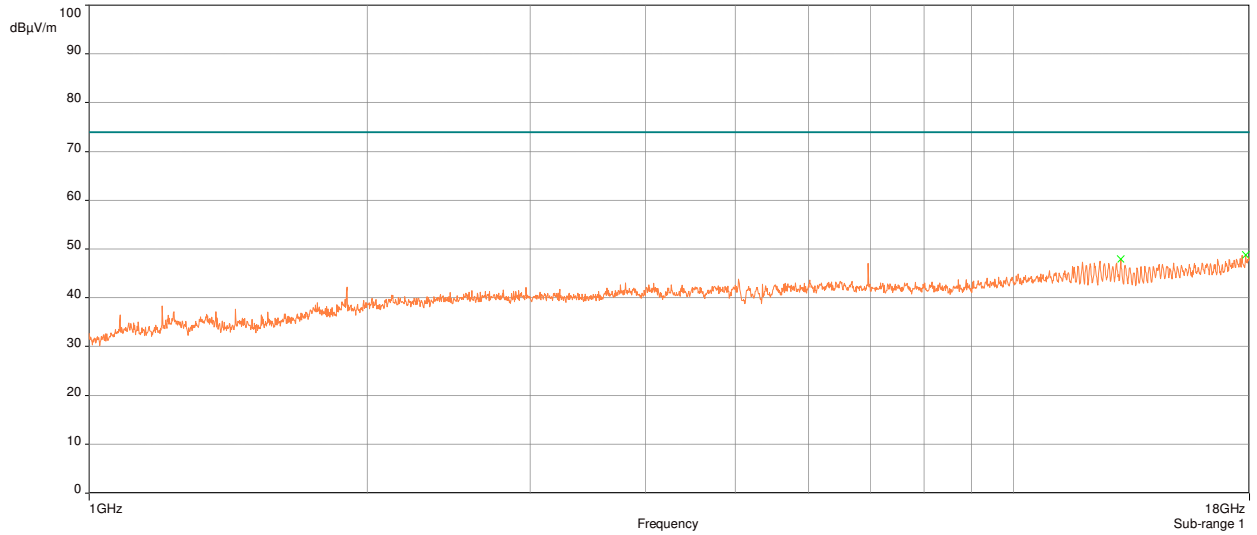

Plot 6: Radiated Spurious Emissions Requirements, 802.11a, Mid Channel UNII-1, Peak

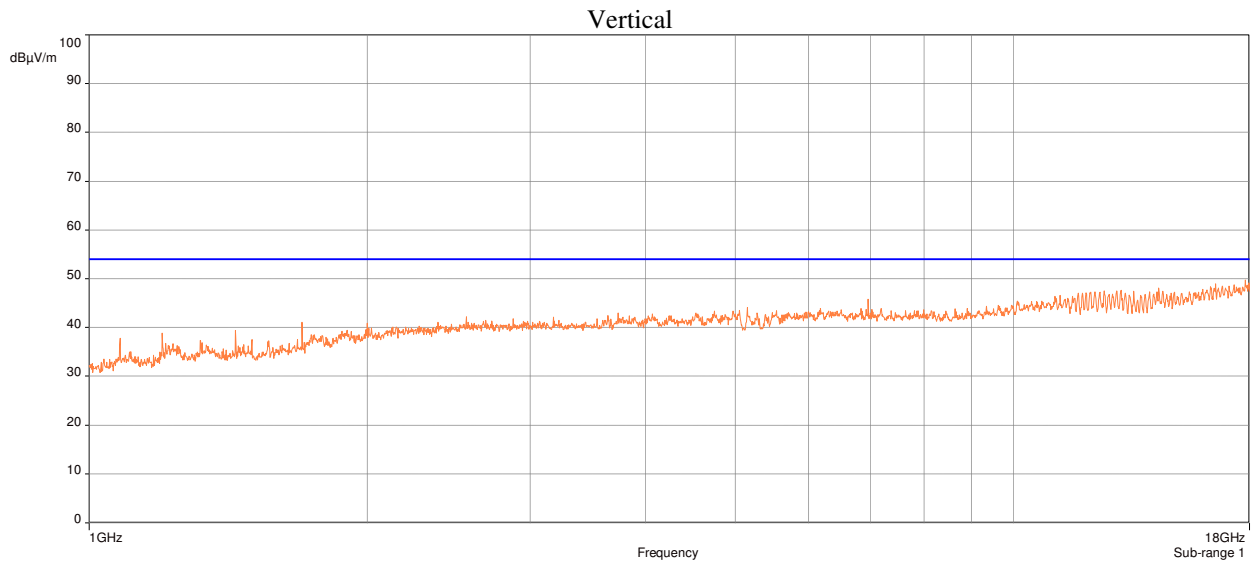
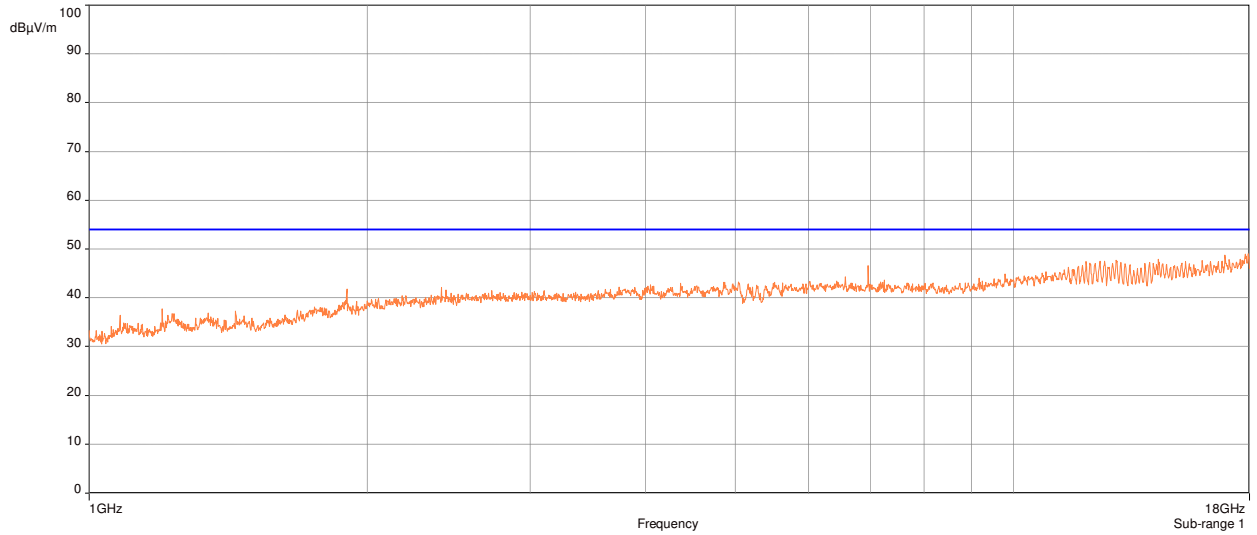

Plot 7: Radiated Spurious Emissions Requirements, 802.11a, Mid Channel UNII-1, Average

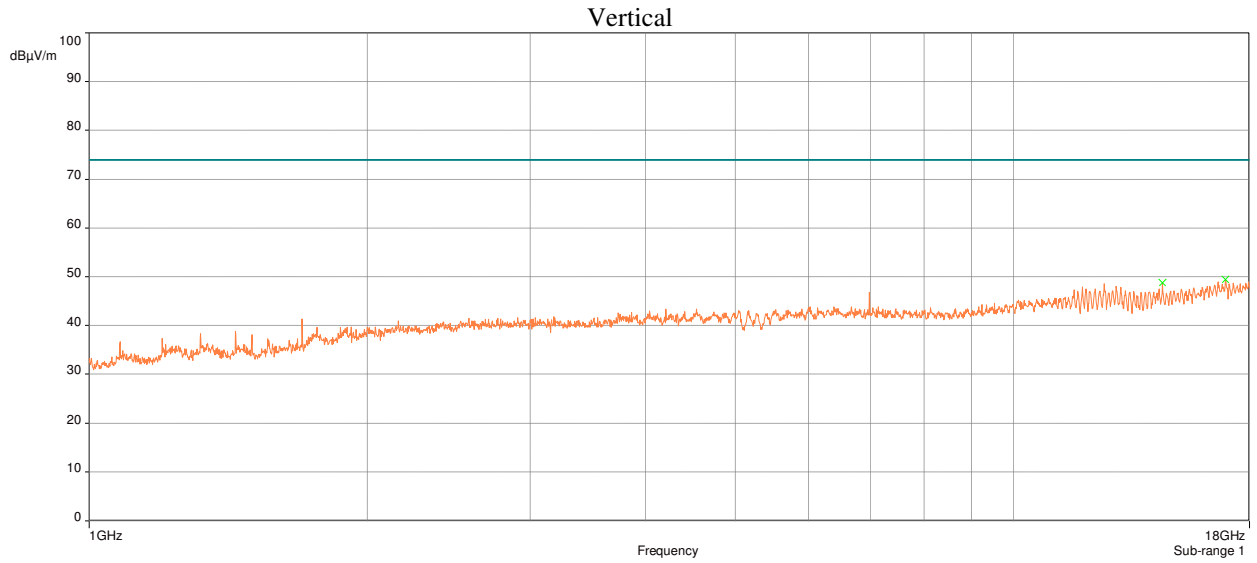
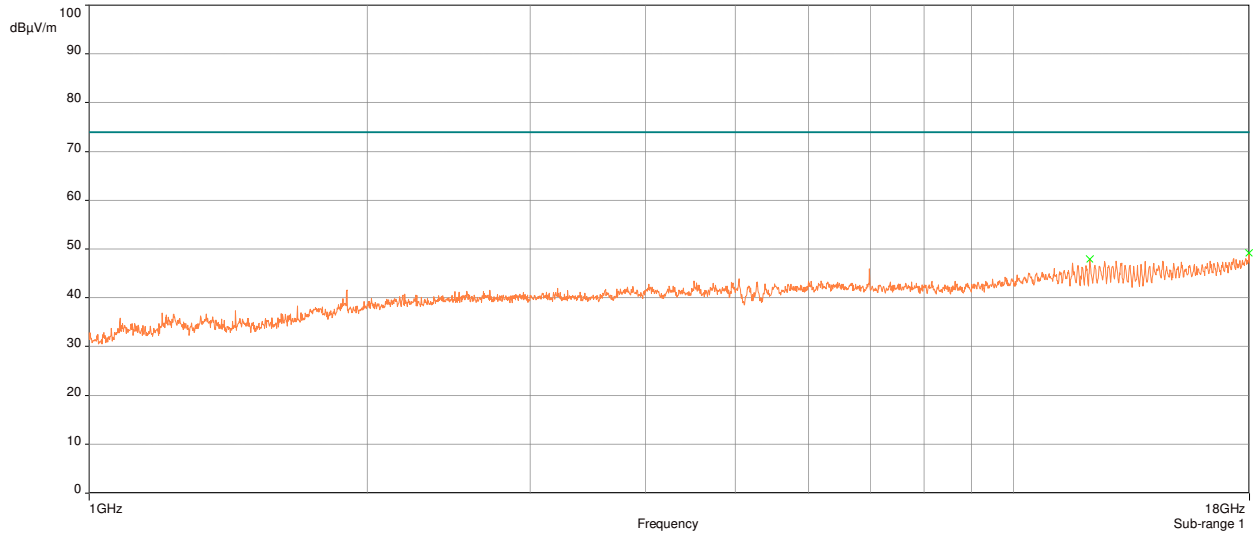

Plot 8: Radiated Spurious Emissions Requirements, 802.11a, High Channel UNII-1, Peak

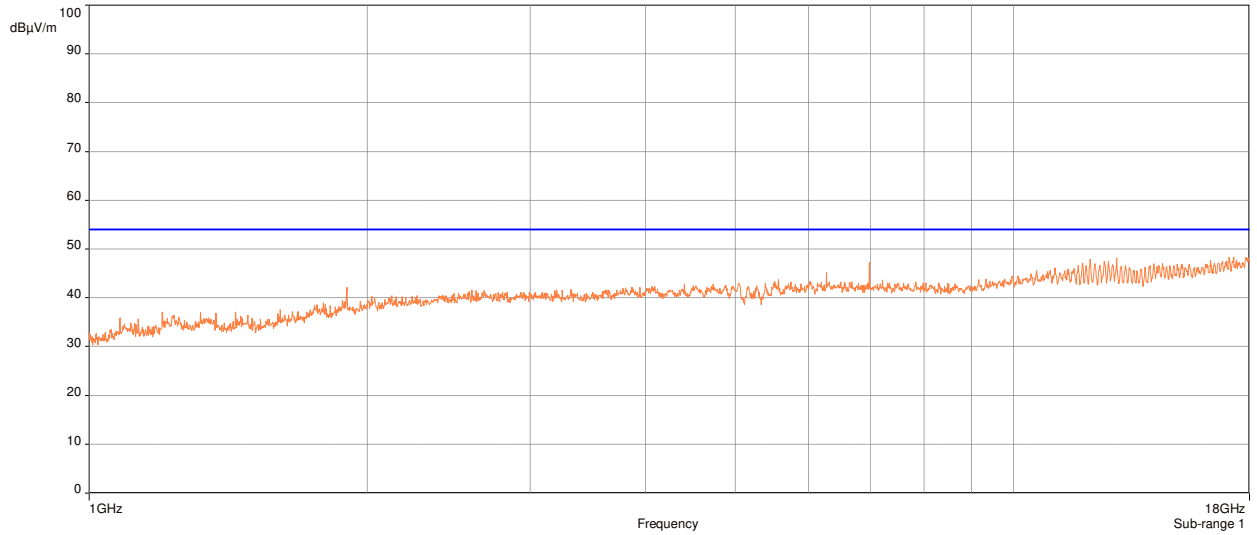

Vertical

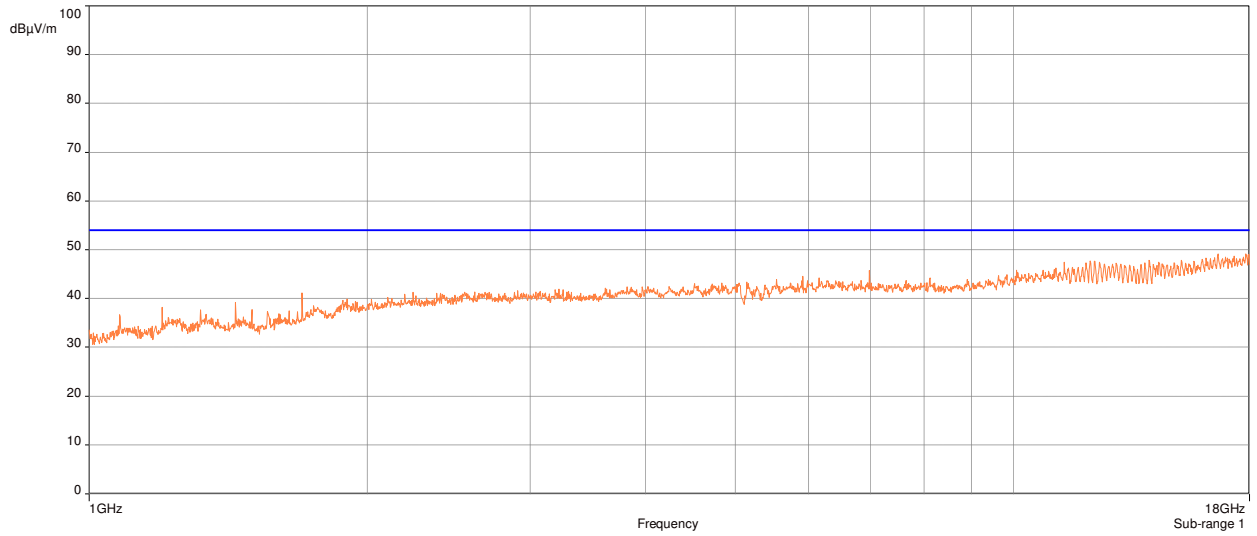

Horizontal

Plot 9: Radiated Spurious Emissions Requirements, 802.11a, High Channel UNII-1, Average

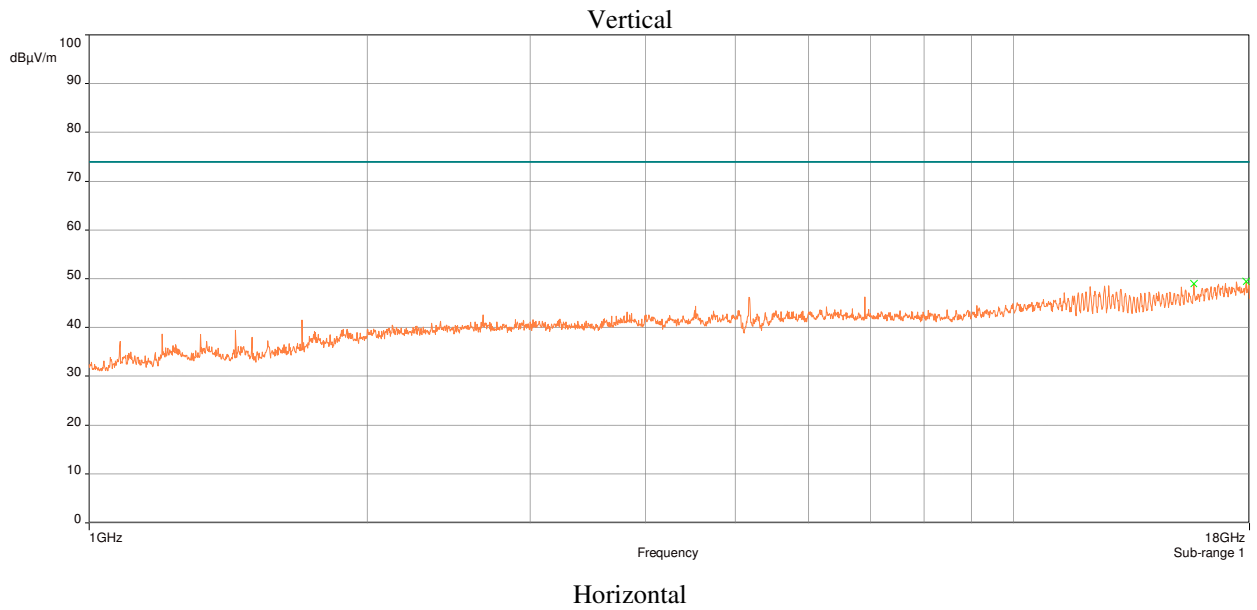
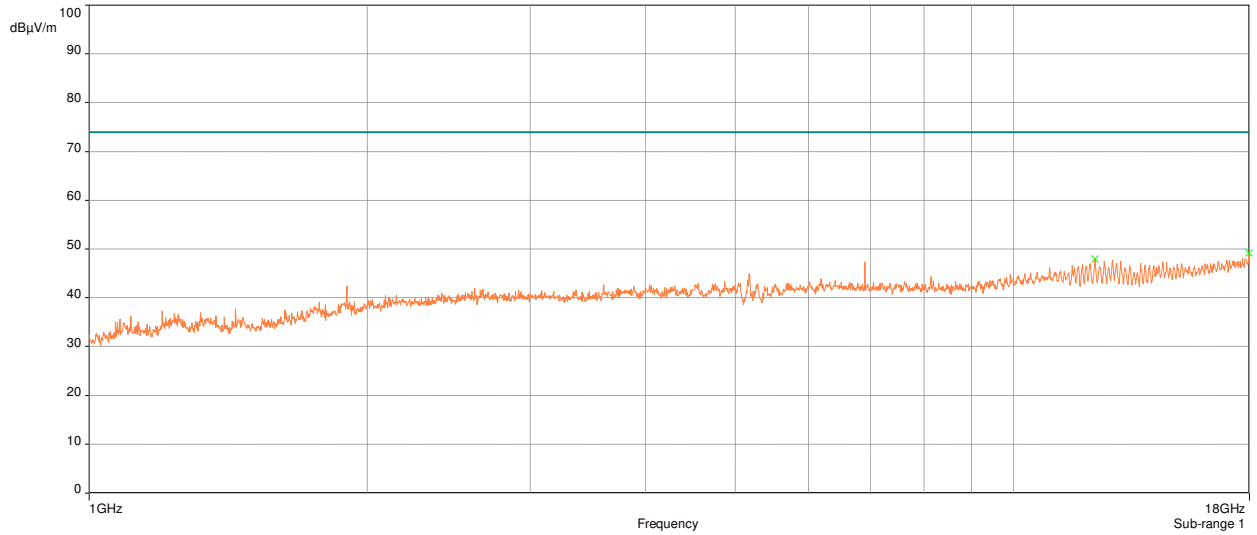

Plot 10: Radiated Spurious Emissions Requirements, 802.11n, Low Channel UNII-1, Peak

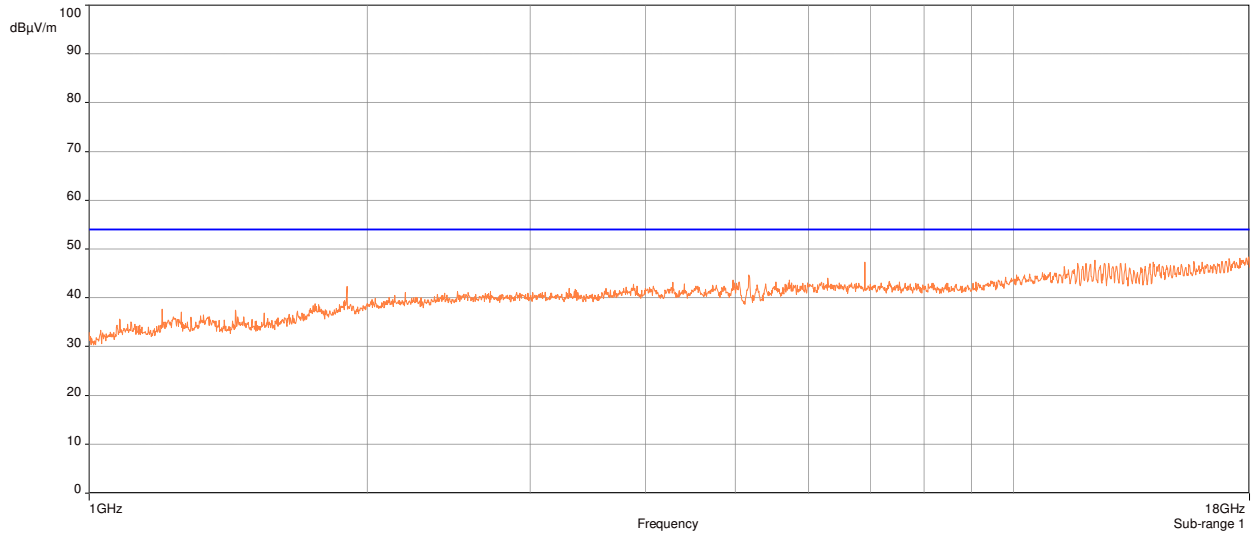

Vertical

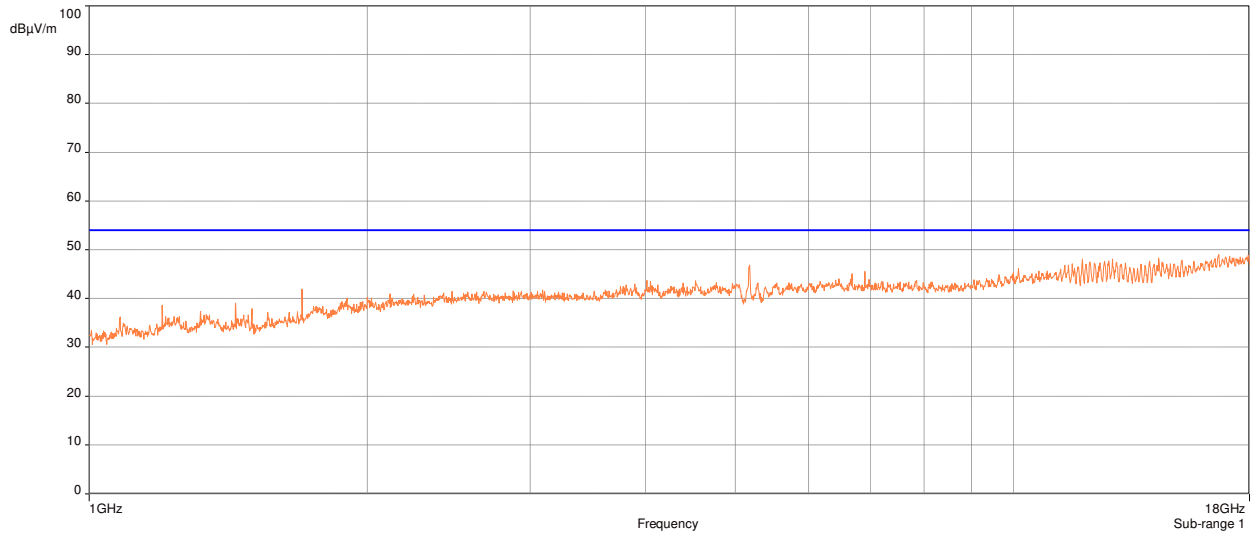

Horizontal

Plot 11: Radiated Spurious Emissions Requirements, 802.11n, Low Channel UNII-1, Average

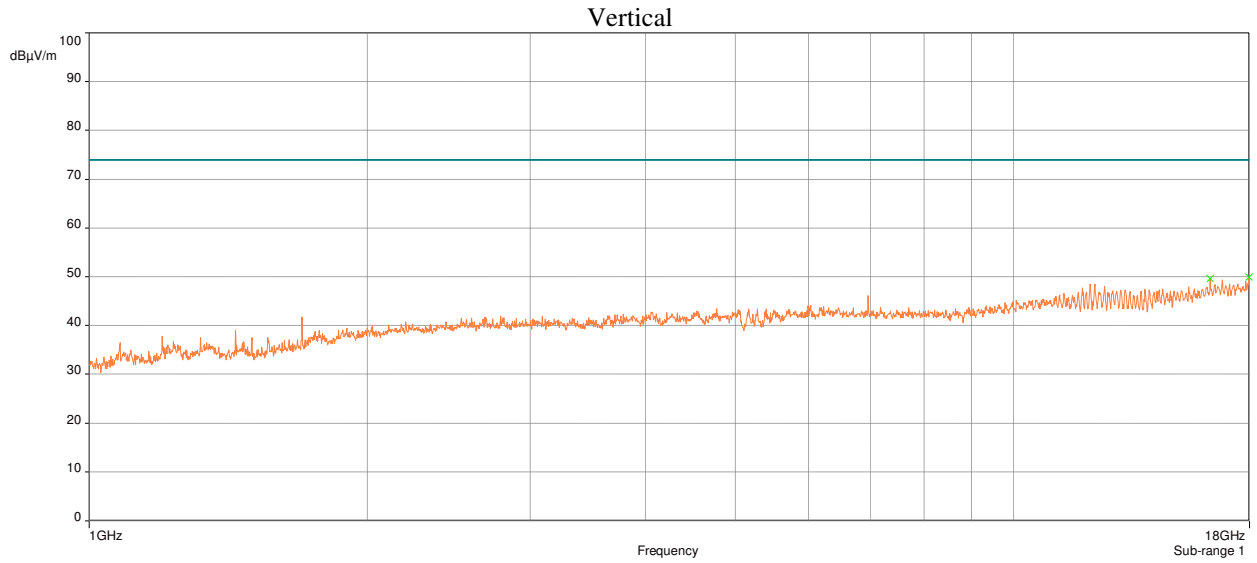
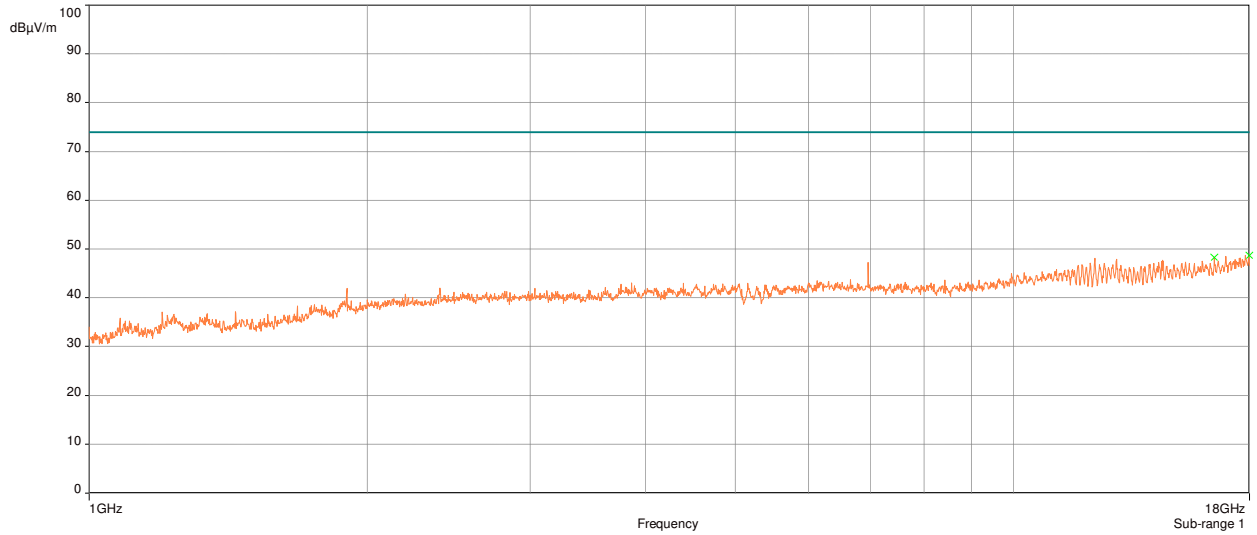

Plot 12: Radiated Spurious Emissions Requirements, 802.11n, Mid Channel UNII-1, Peak

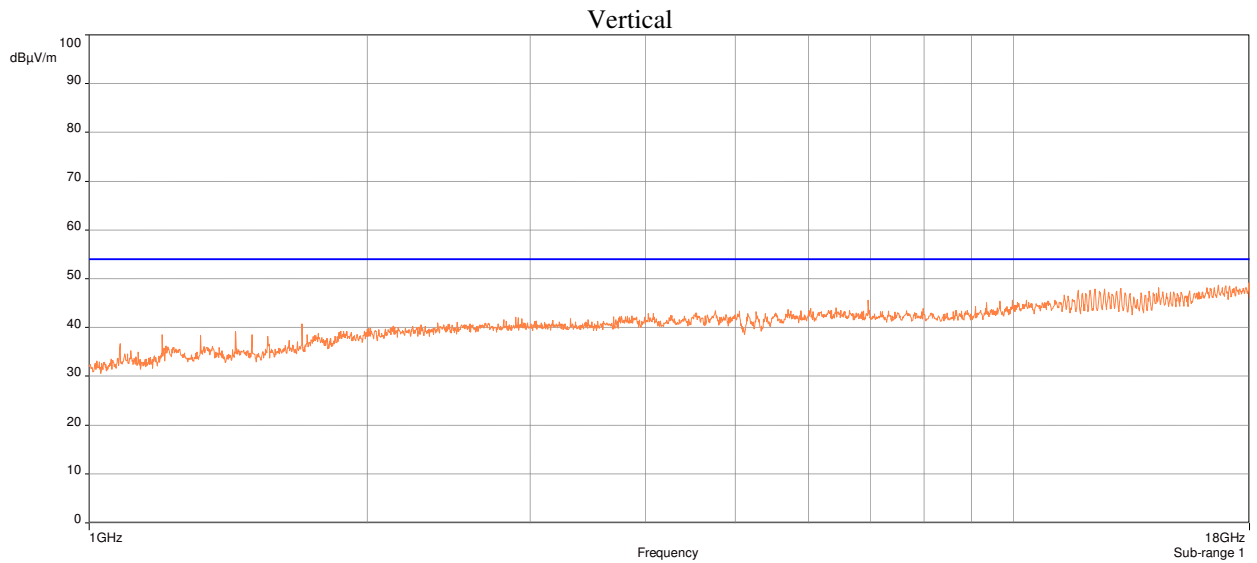
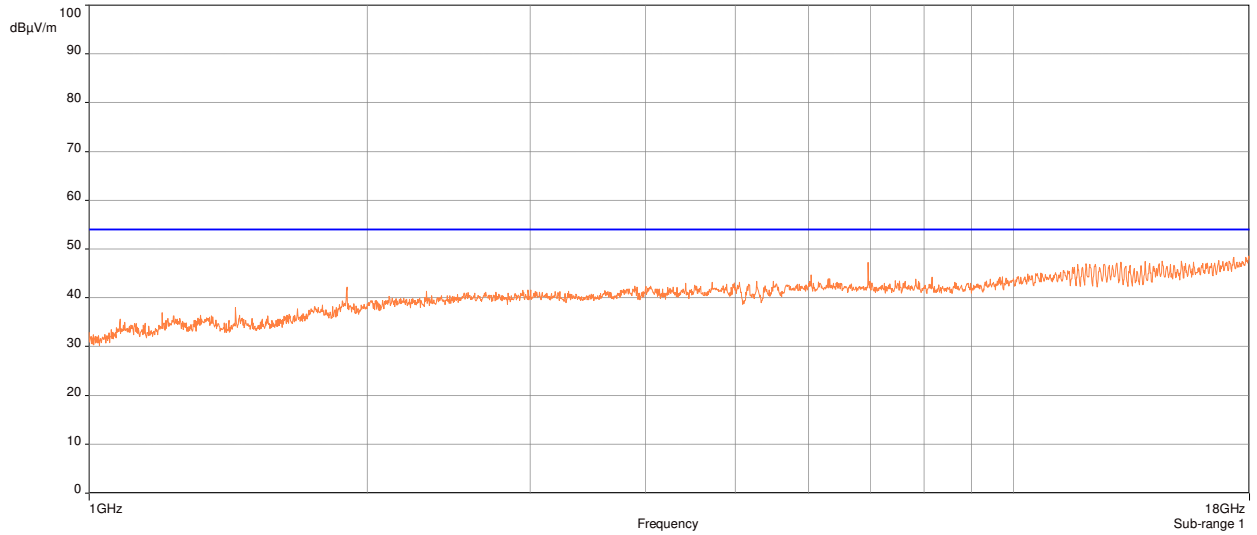

Plot 13: Radiated Spurious Emissions Requirements, 802.11n, Mid Channel UNII-1, Average

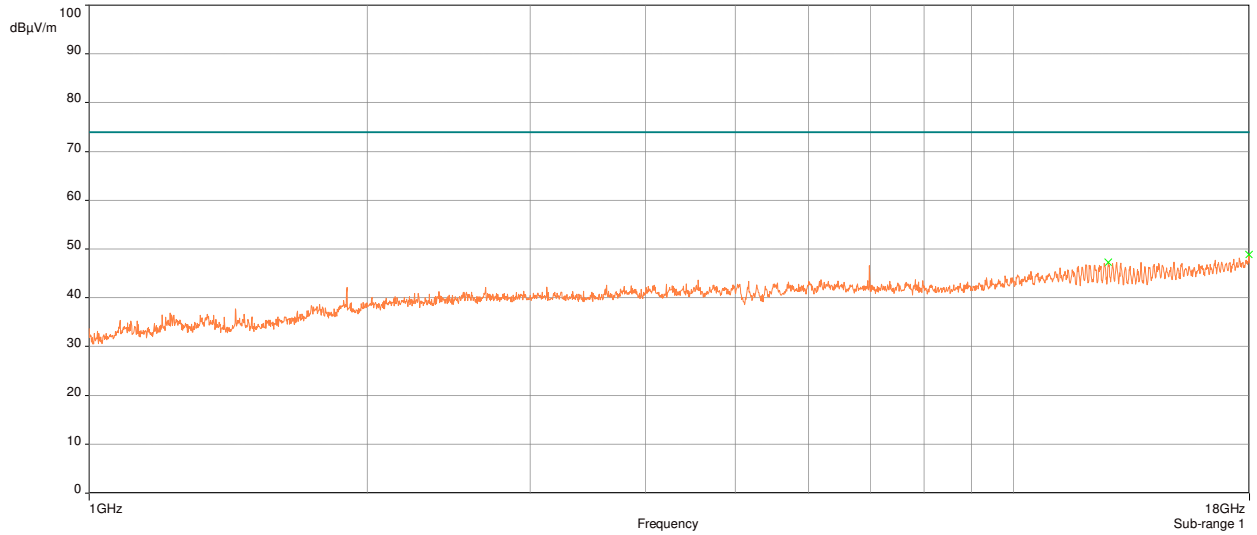

Vertical

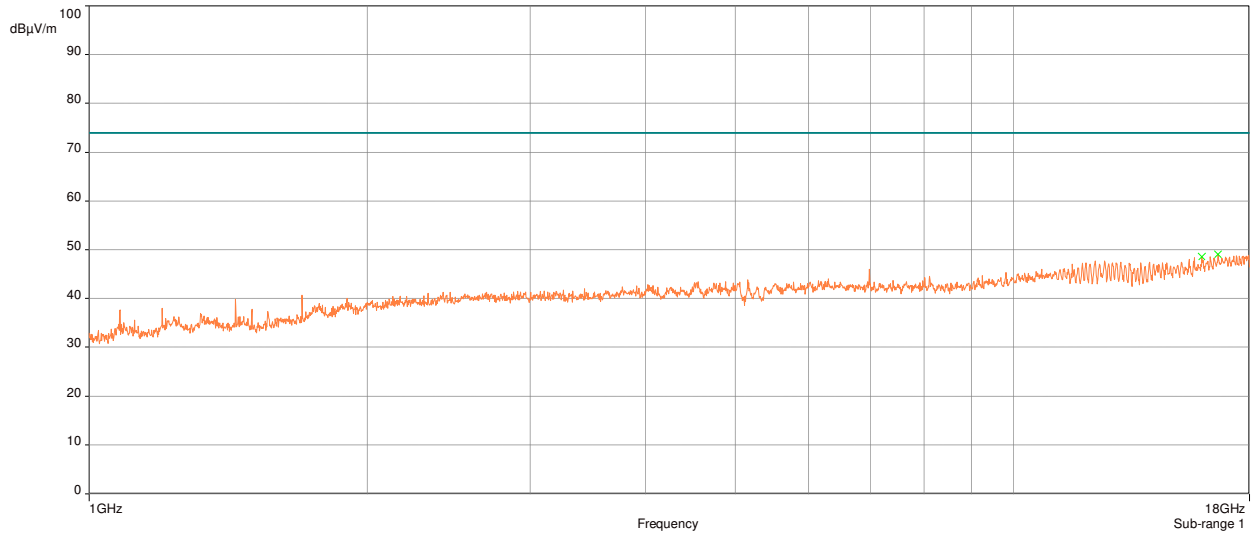

Horizontal

Plot 14: Radiated Spurious Emissions Requirements, 802.11n, High Channel UNII-1, Peak

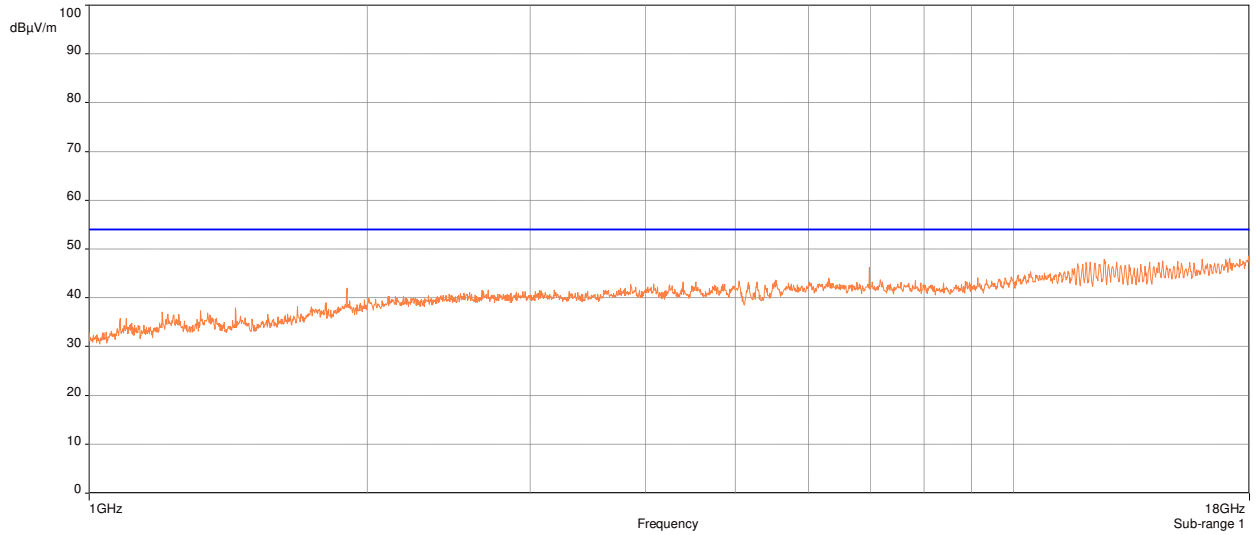

Vertical

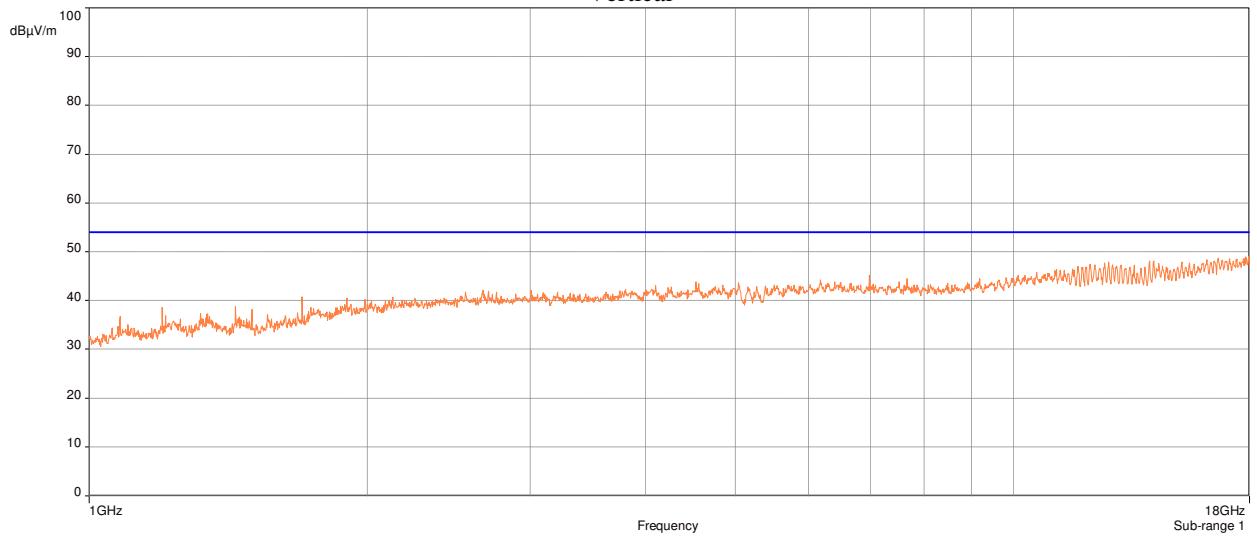

Horizontal

Plot 15: Radiated Spurious Emissions Requirements, 802.11n, High Channel UNII-1, Average

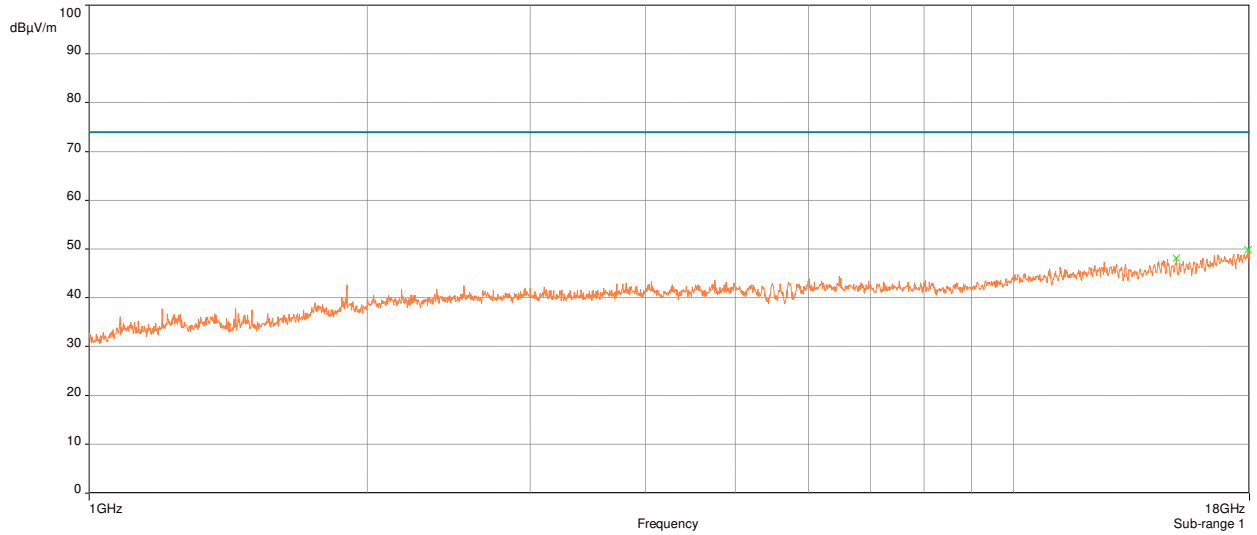

Vertical

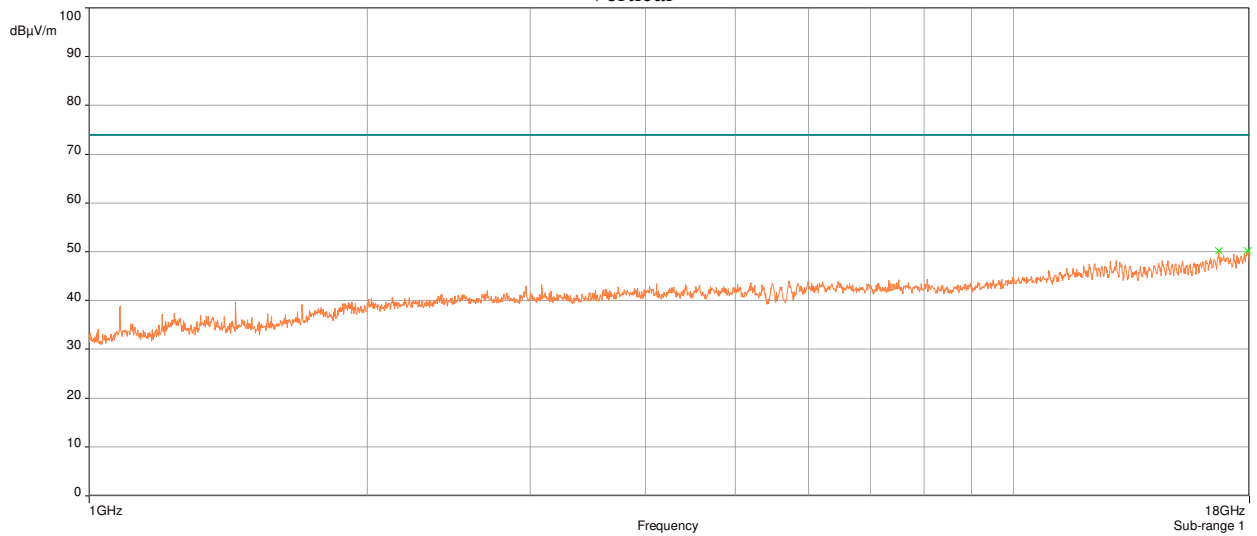

Horizontal

Plot 16: Radiated Spurious Emissions Requirements, 802.11a, Low Channel UNII-2, Peak

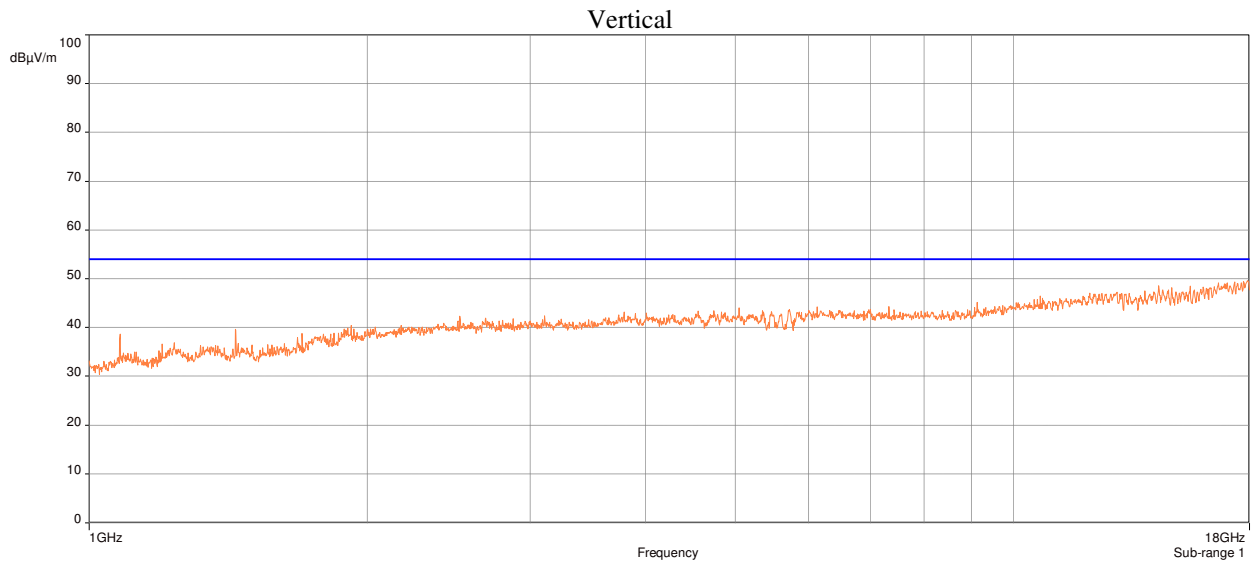
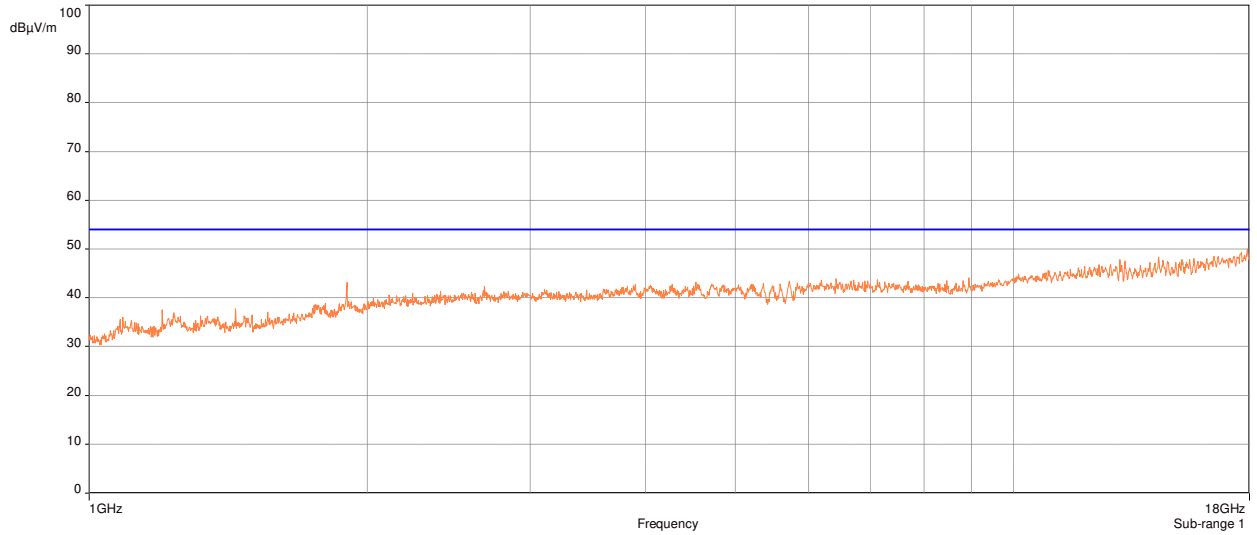

Plot 17: Radiated Spurious Emissions Requirements, 802.11a, Low Channel UNII-2, Average

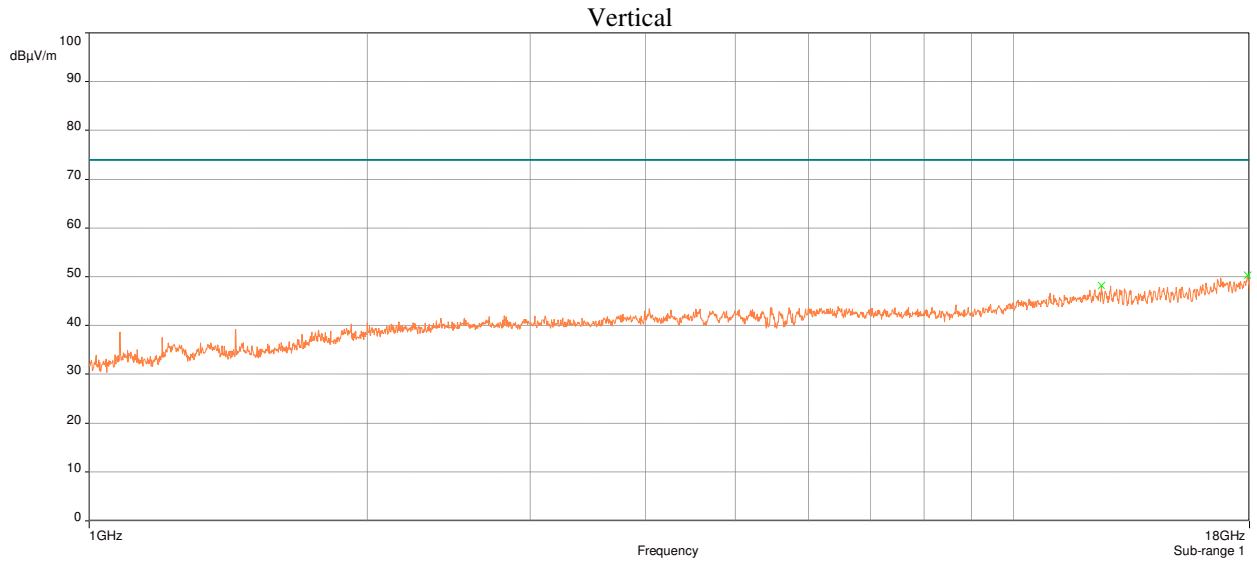
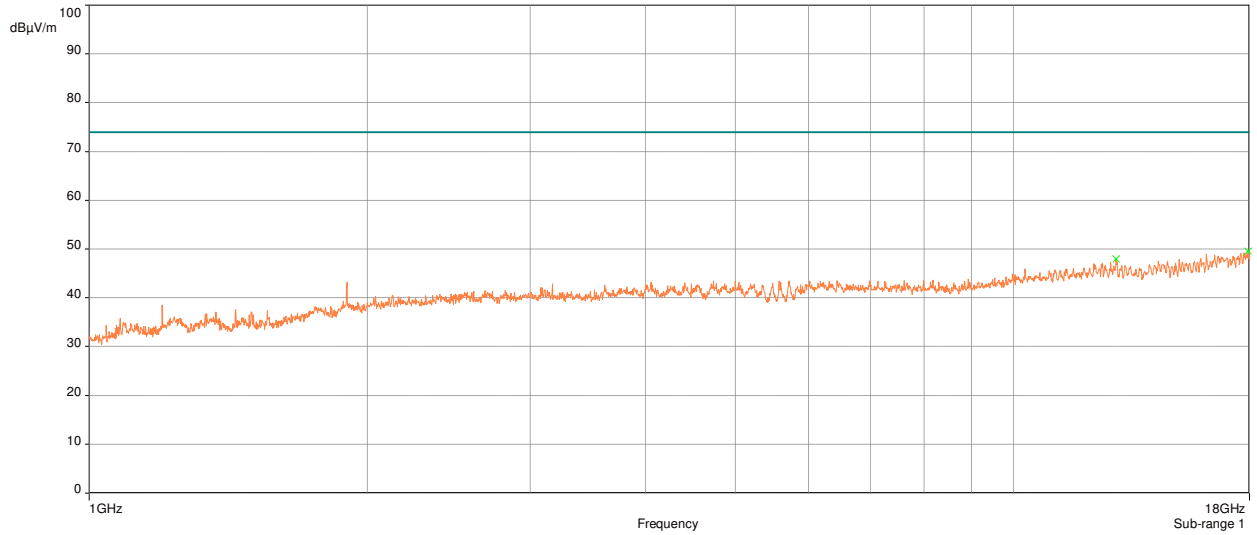

Plot 18: Radiated Spurious Emissions Requirements, 802.11a, Mid Channel UNII-2, Peak

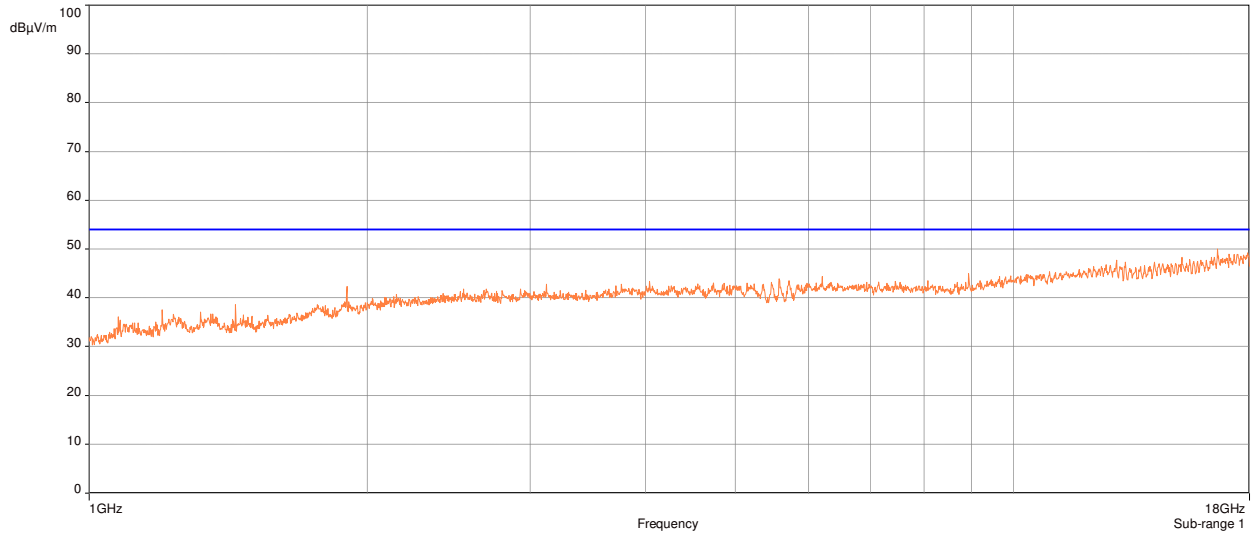

Vertical

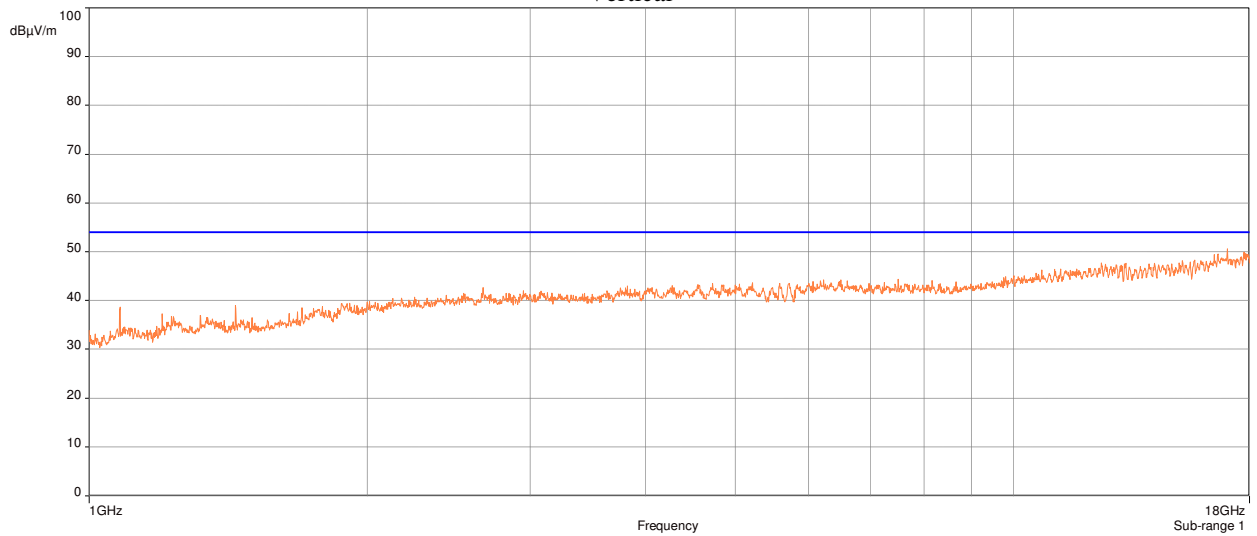

Horizontal

Plot 19: Radiated Spurious Emissions Requirements, 802.11a, Mid Channel UNII-2, Average

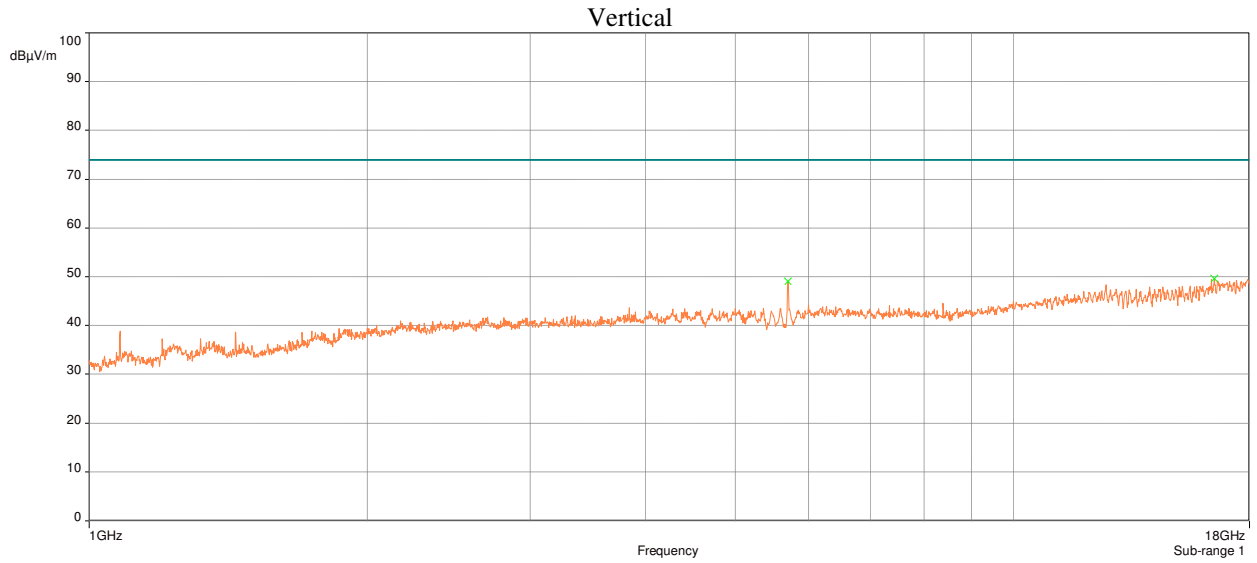
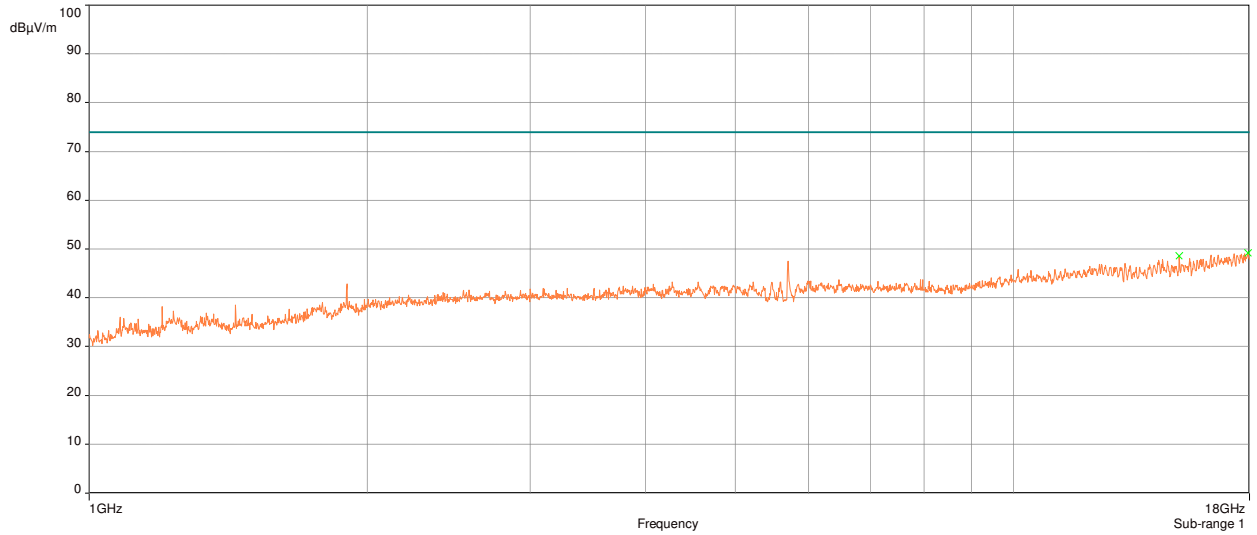

Plot 20: Radiated Spurious Emissions Requirements, 802.11a, High Channel UNII-2, Peak

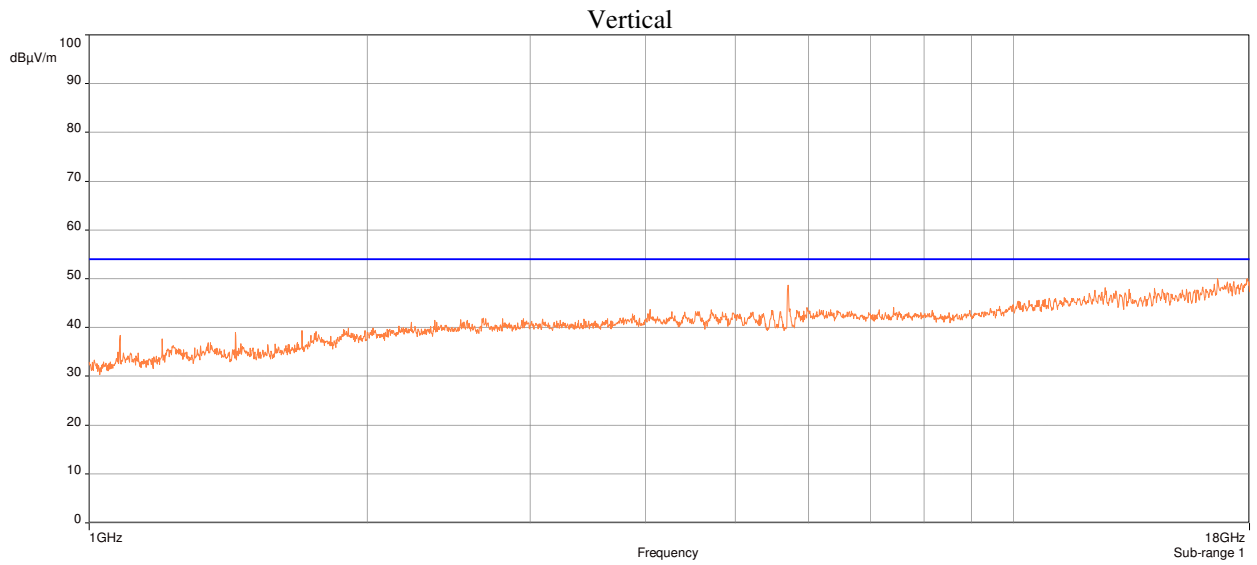
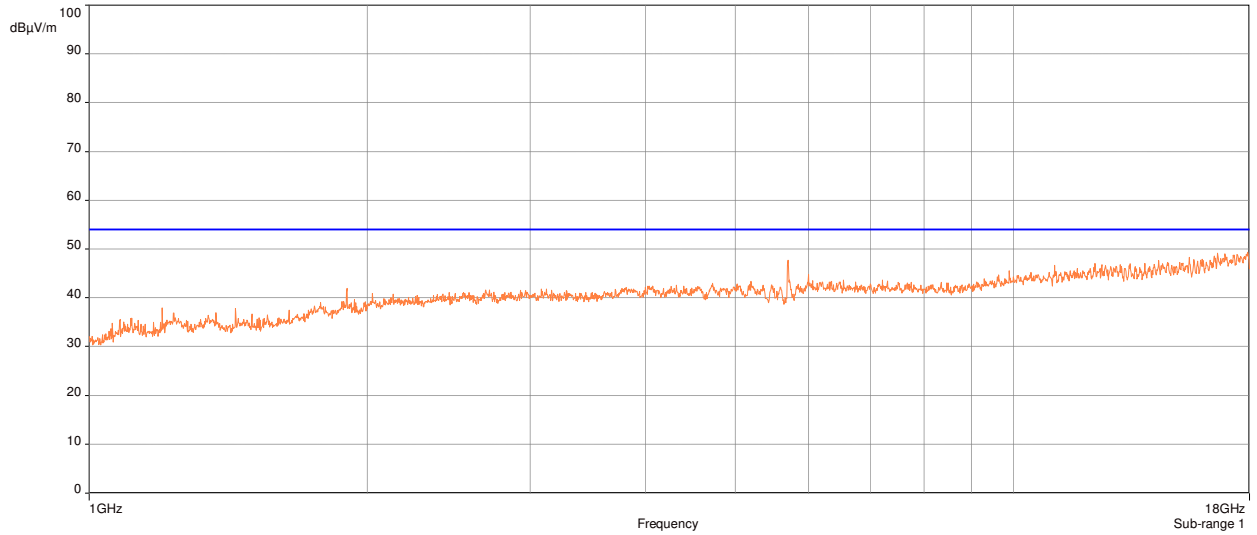

Plot 21: Radiated Spurious Emissions Requirements, 802.11a, High Channel UNII-2, Average

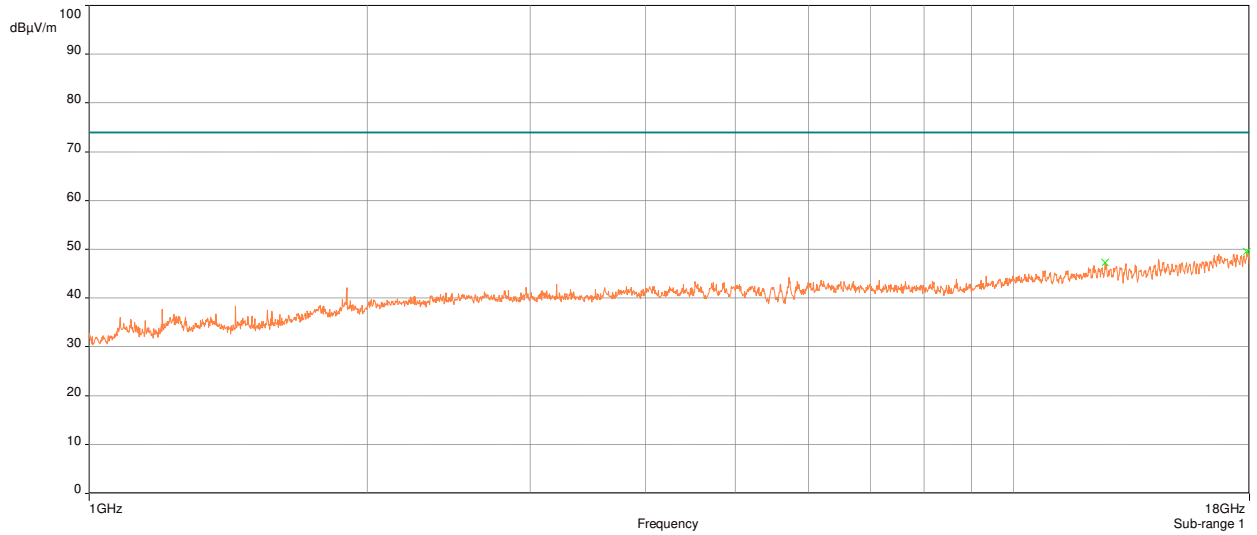

Vertical

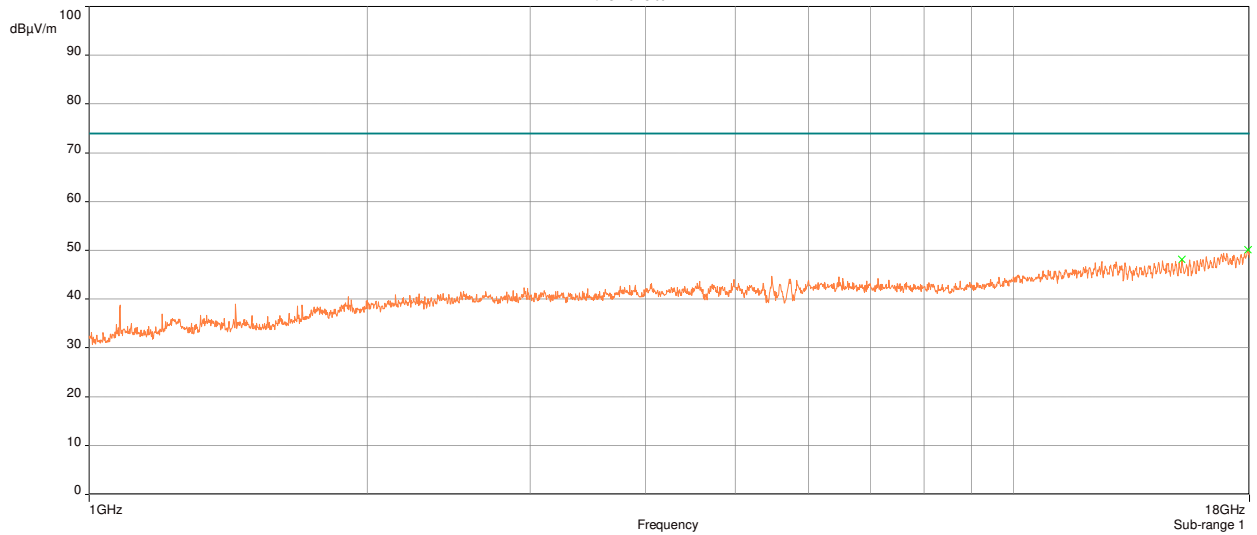

Horizontal

Plot 22: Radiated Spurious Emissions Requirements, 802.11n, Low Channel UNII-2, Peak

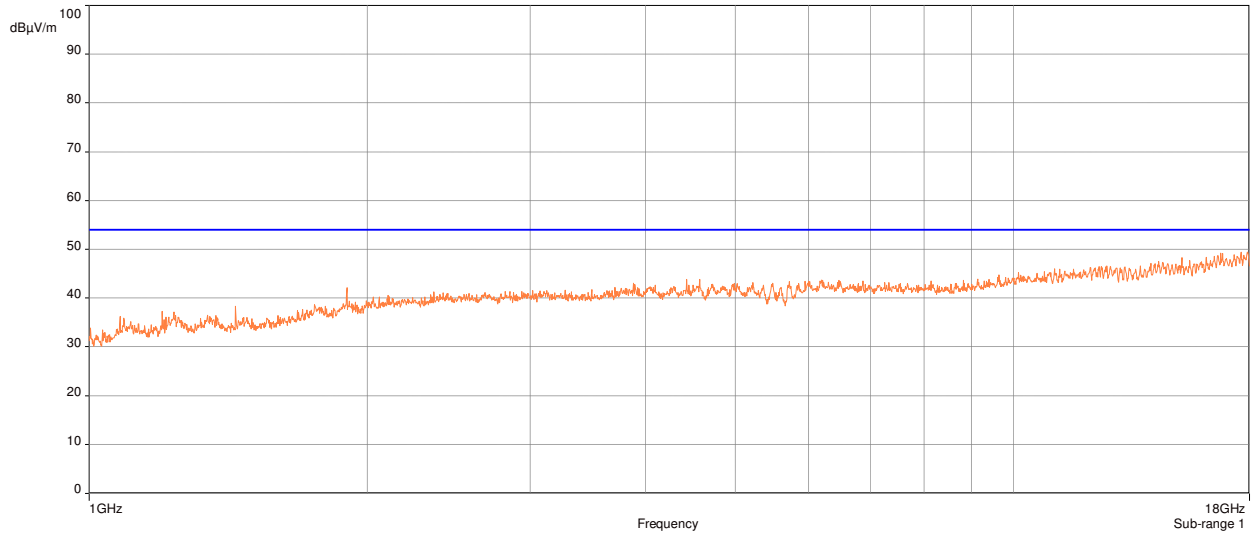

Vertical

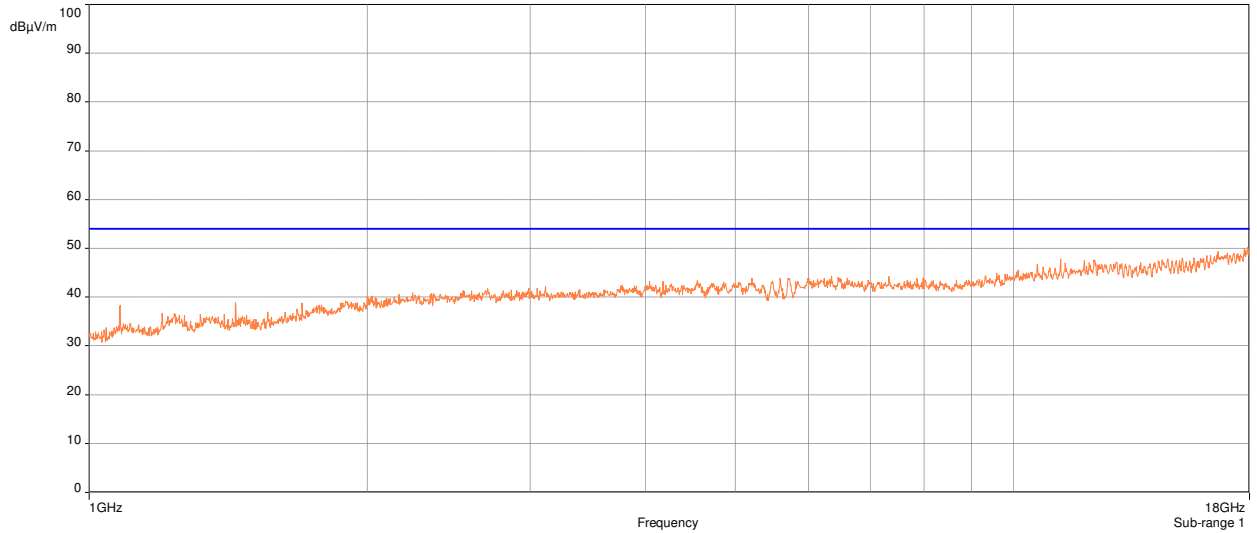

Horizontal

Plot 23: Radiated Spurious Emissions Requirements, 802.11n, Low Channel UNII-2, Average

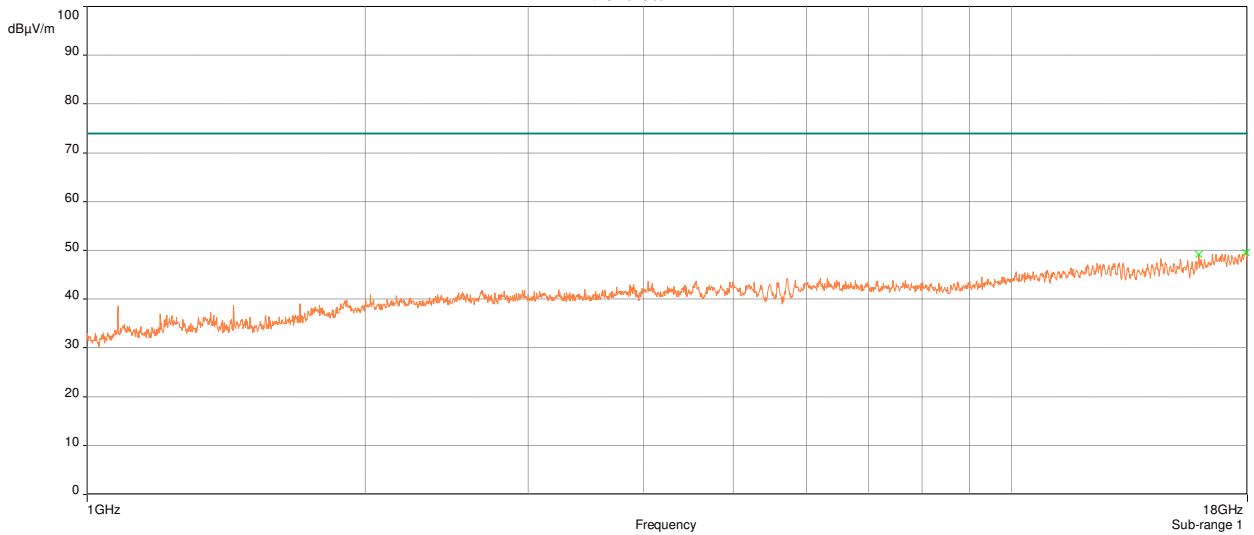
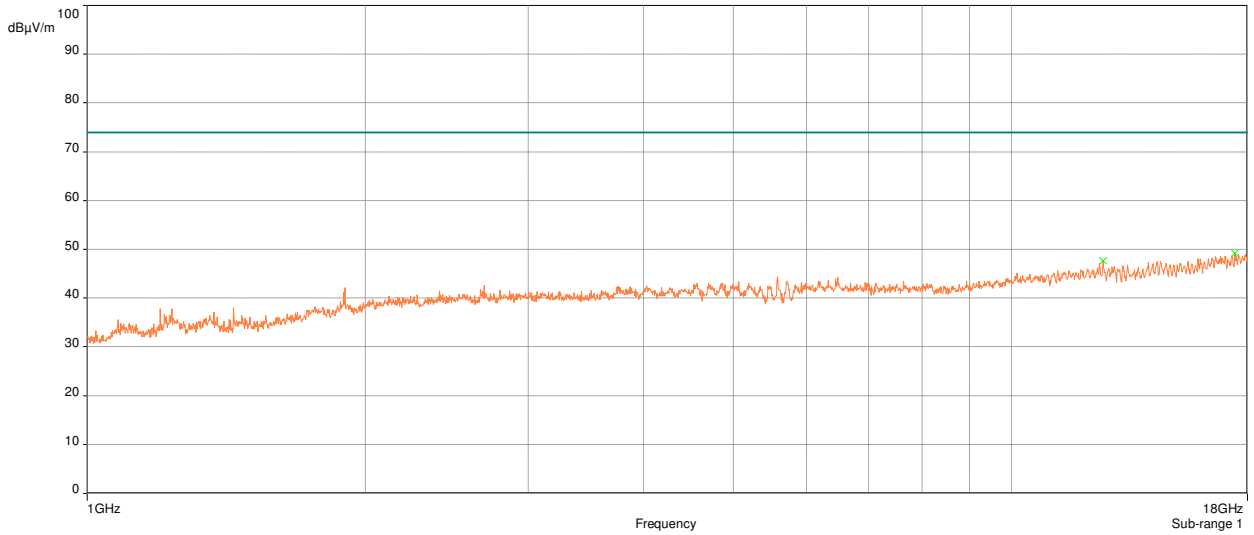

Plot 24: Radiated Spurious Emissions Requirements, 802.11n, Mid Channel UNII-2, Peak

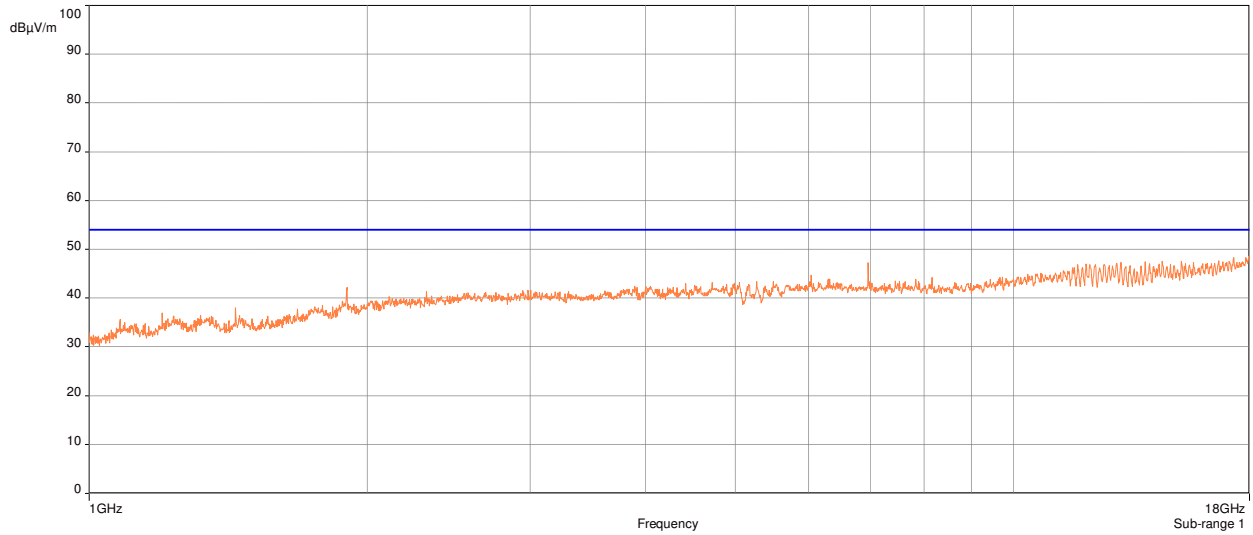

Vertical

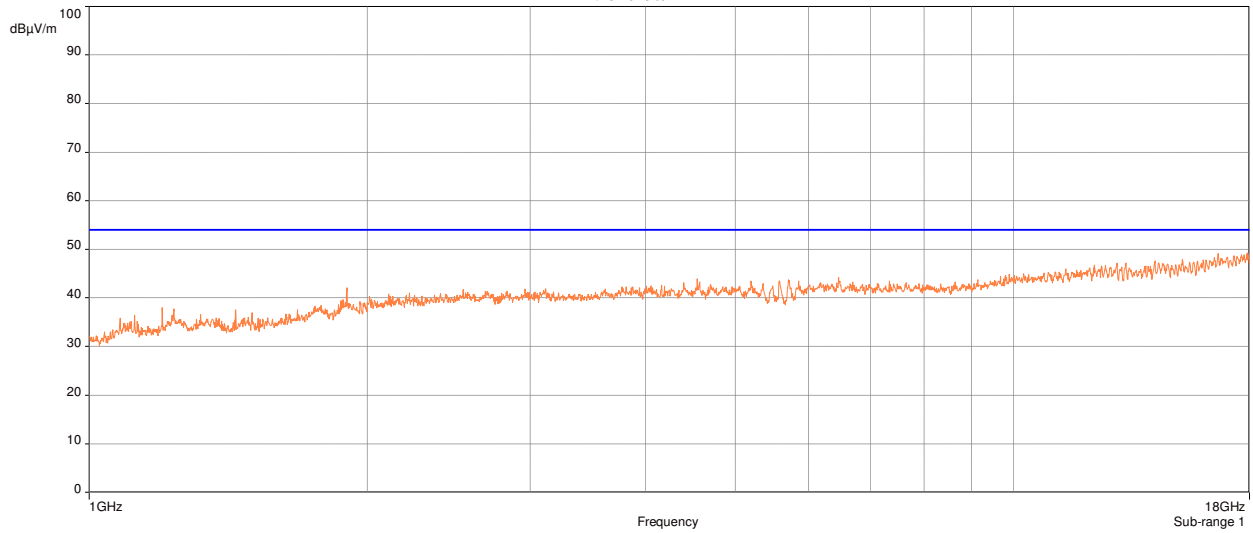

Horizontal

Plot 25: Radiated Spurious Emissions Requirements, 802.11n, Mid Channel UNII-2, Average

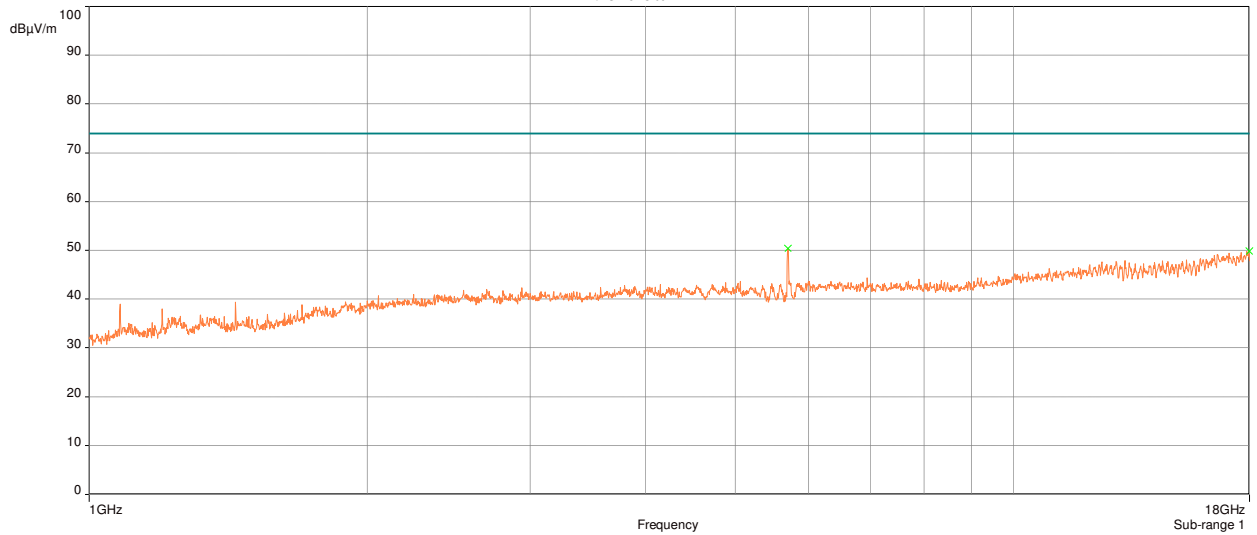
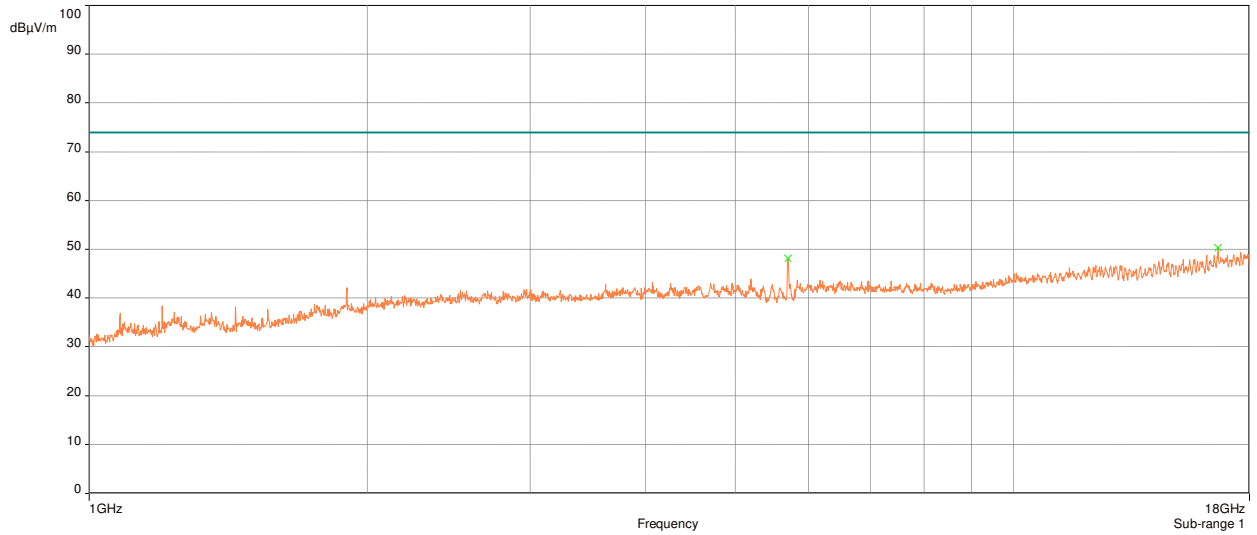

Plot 26: Radiated Spurious Emissions Requirements, 802.11n, High Channel UNII-2, Peak

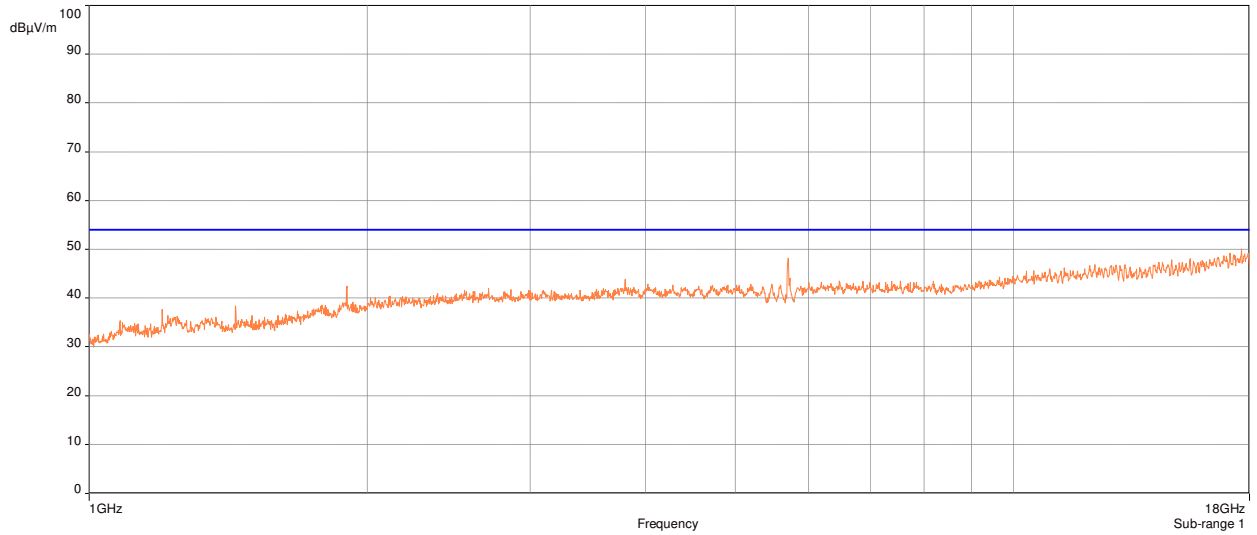

Vertical

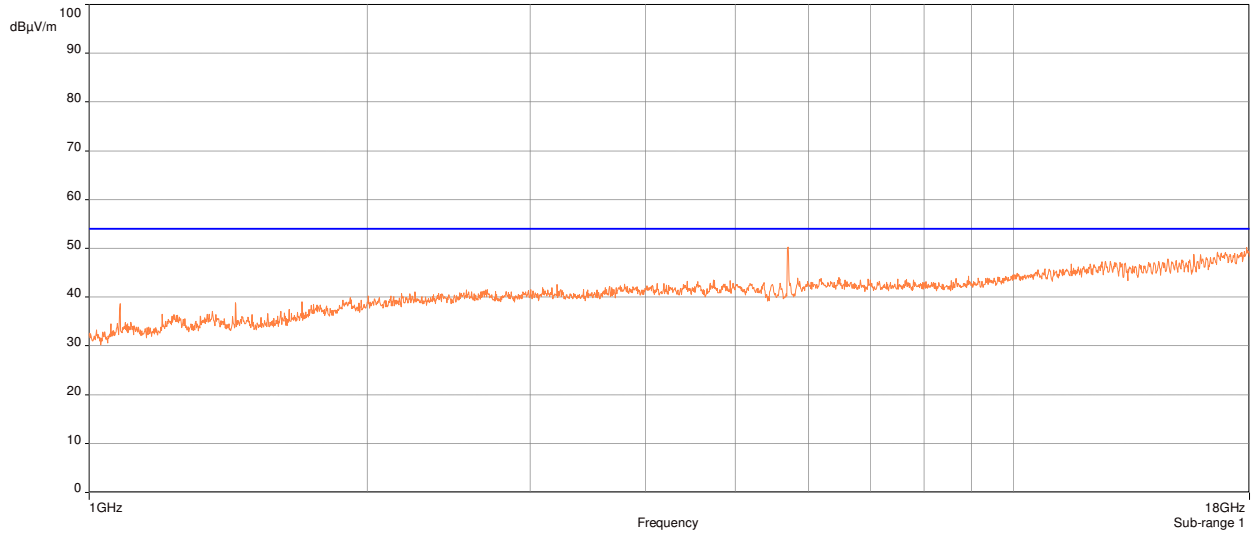

Horizontal

Plot 27: Radiated Spurious Emissions Requirements, 802.11n, High Channel UNII-2, Average

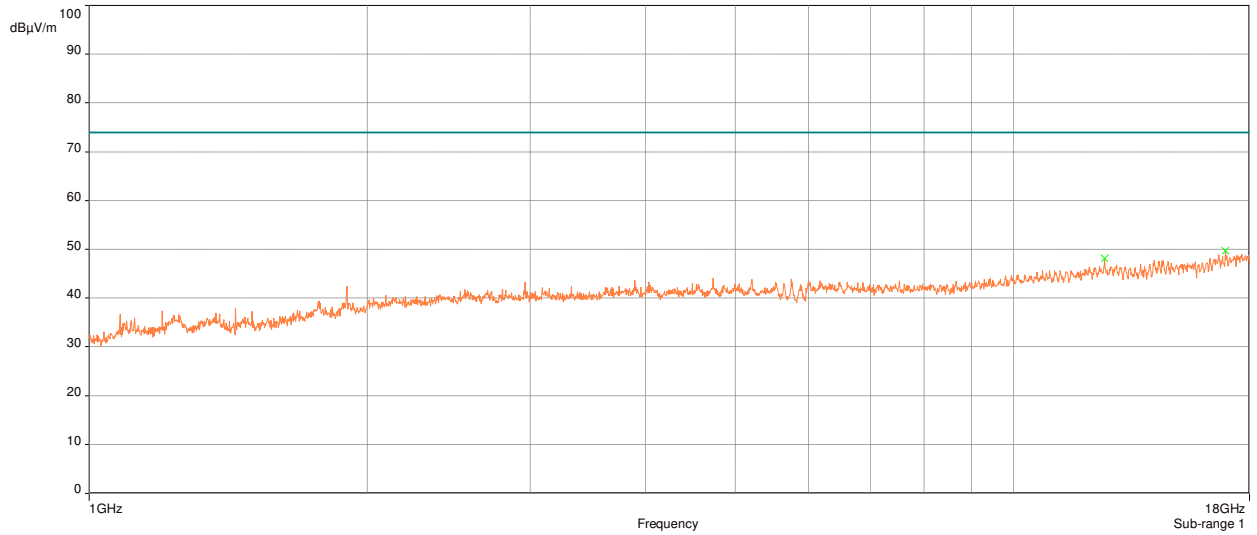

Vertical

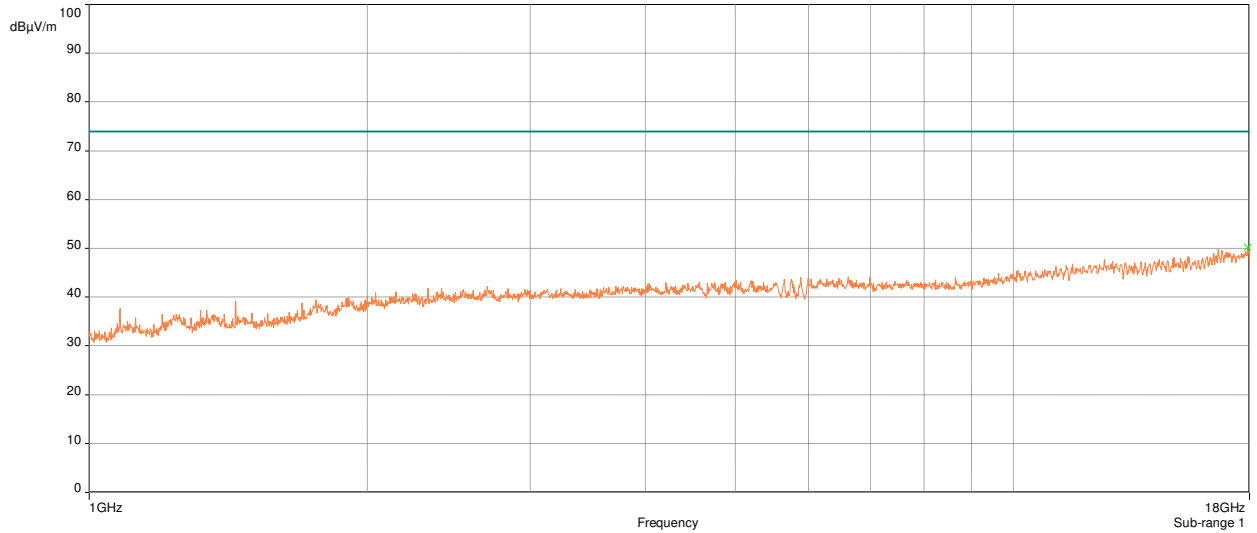

Horizontal

Plot 28: Radiated Spurious Emissions Requirements, 802.11a, Low Channel UNII-3, Peak

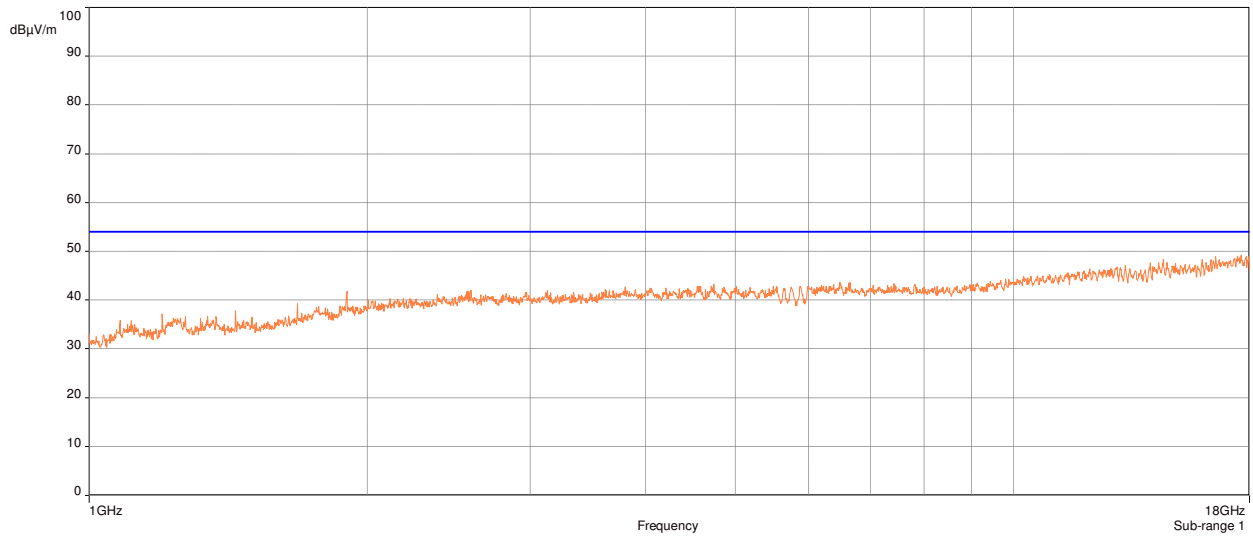

Vertical

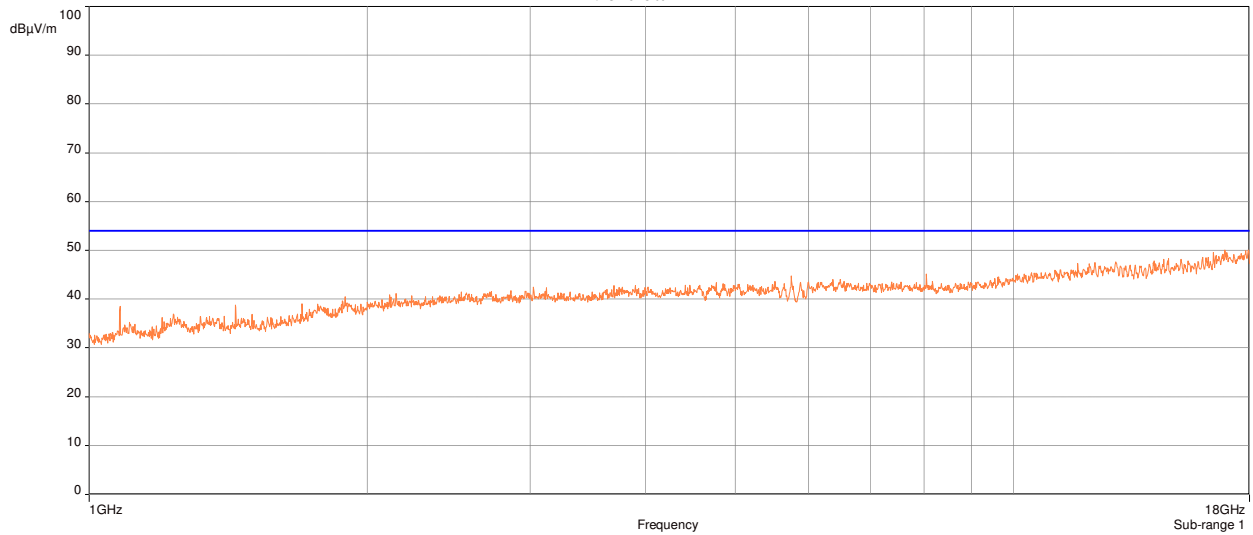

Horizontal

Plot 29: Radiated Spurious Emissions Requirements, 802.11a, Low Channel UNII-3, Average

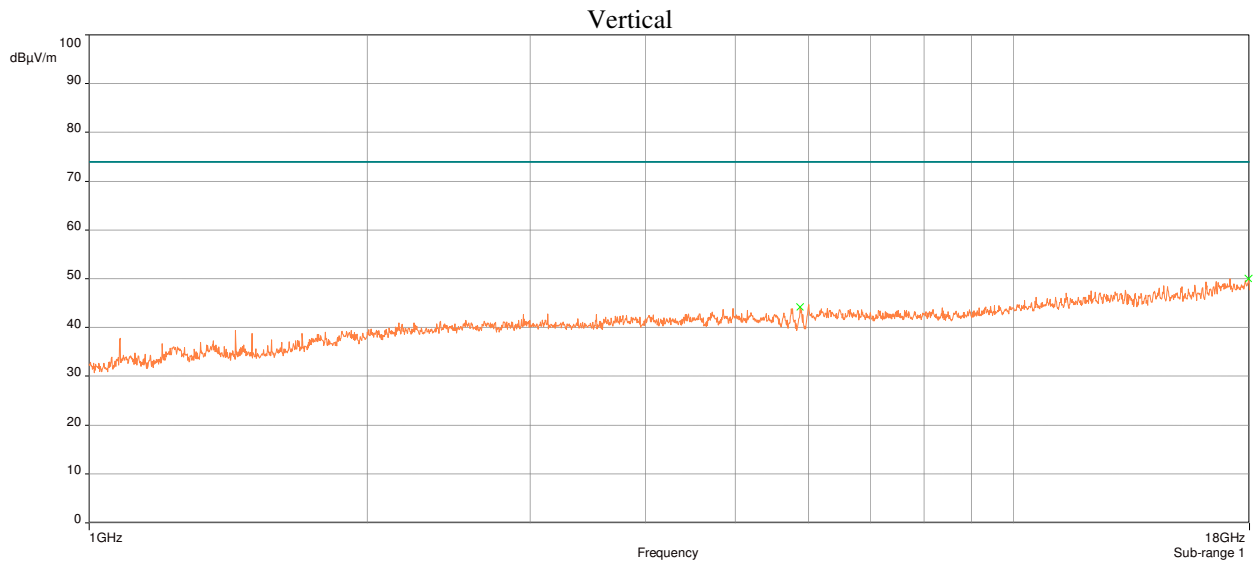
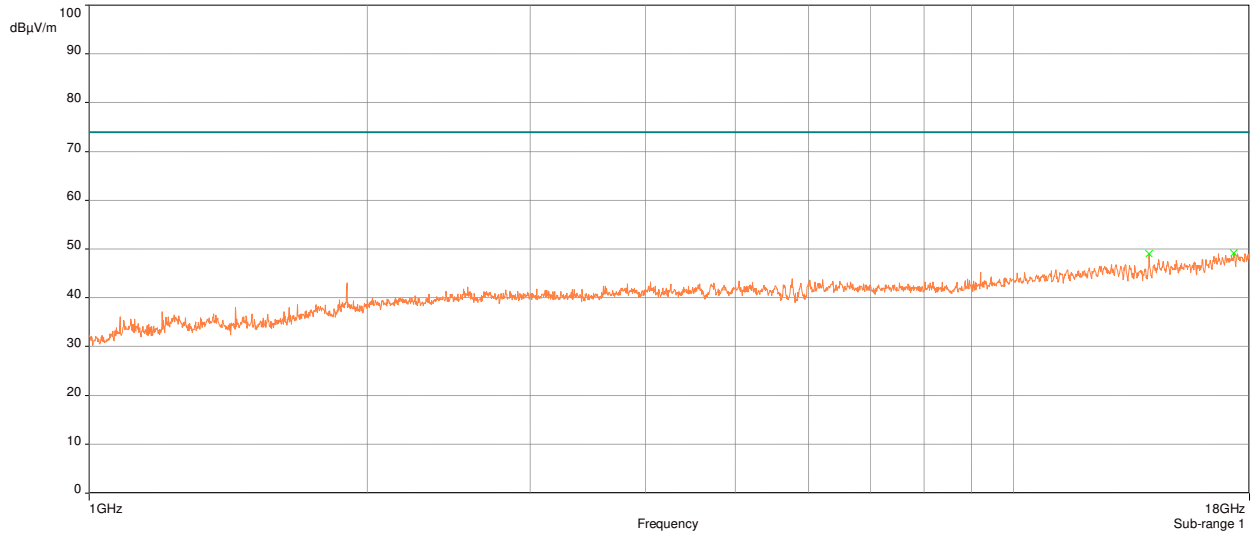

Plot 30: Radiated Spurious Emissions Requirements, 802.11a, Mid Channel UNII-3, Peak

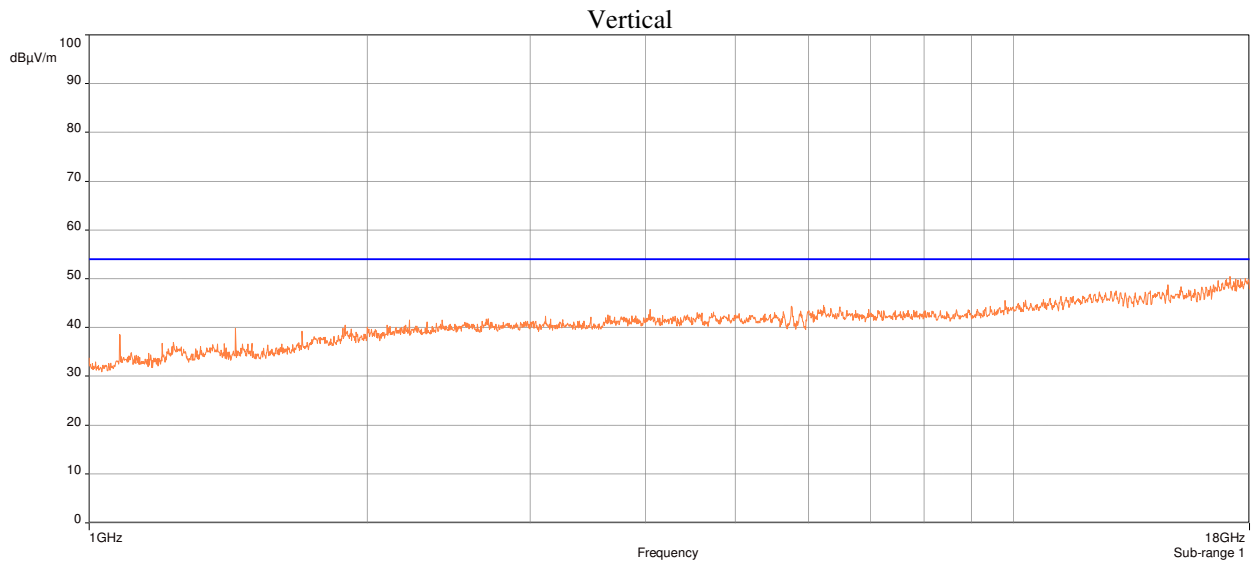
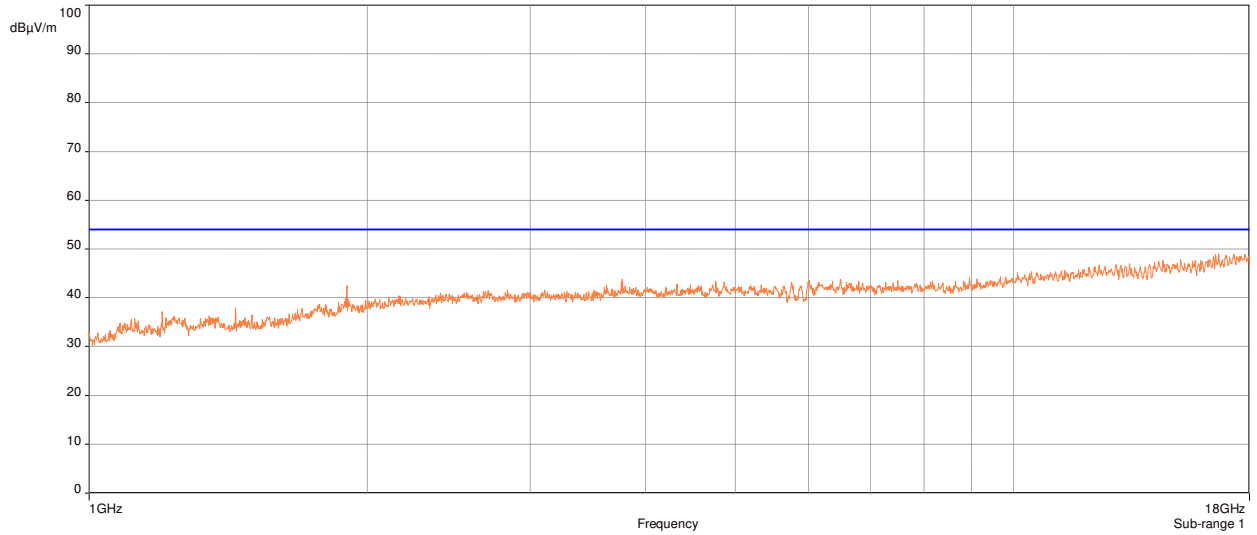

Plot 31: Radiated Spurious Emissions Requirements, 802.11a, Mid Channel UNII-3, Average

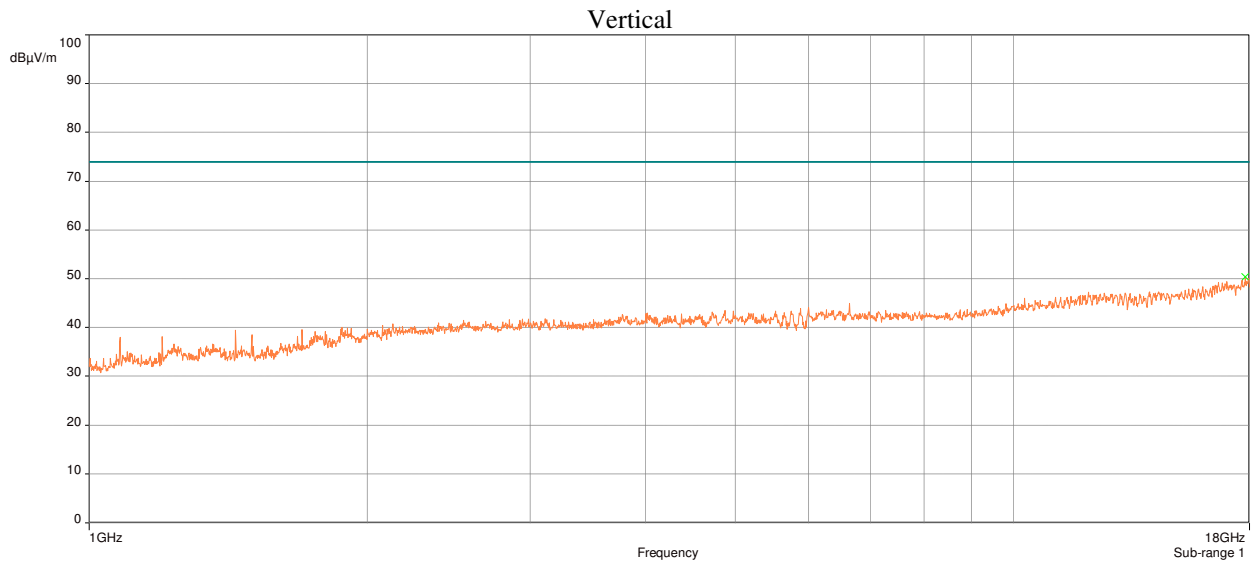
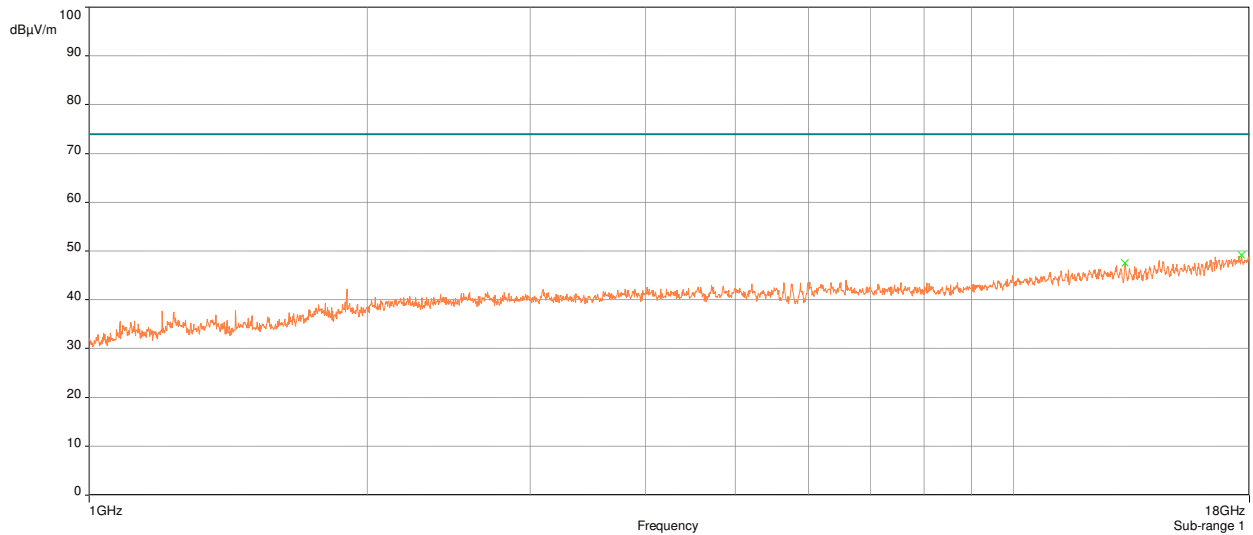

Plot 32: Radiated Spurious Emissions Requirements, 802.11a, High Channel UNII-3, Peak

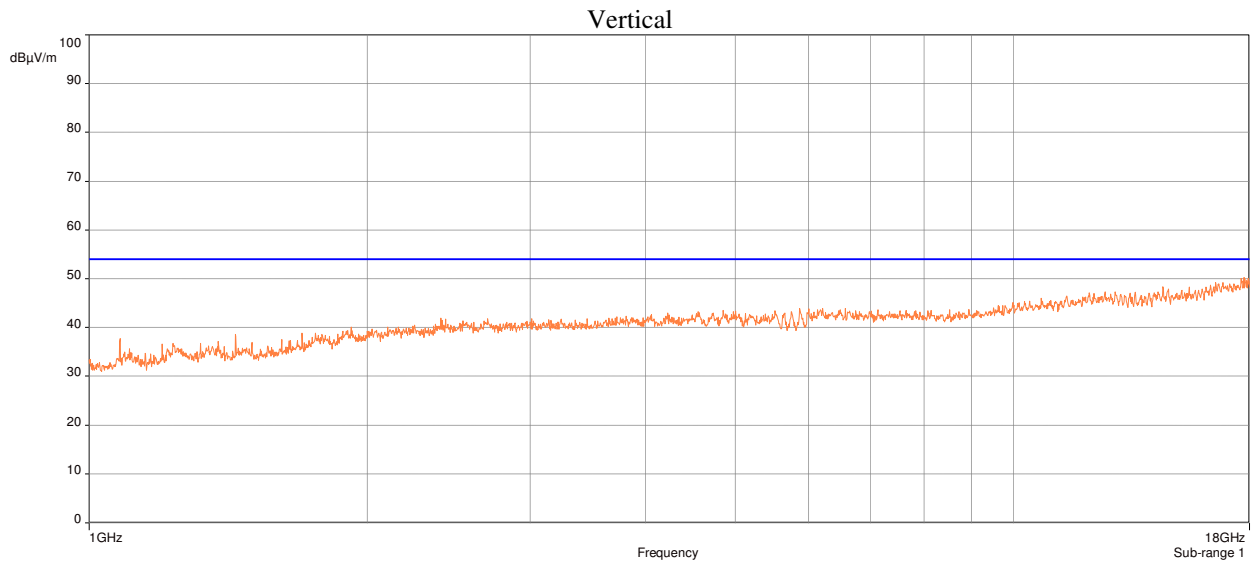
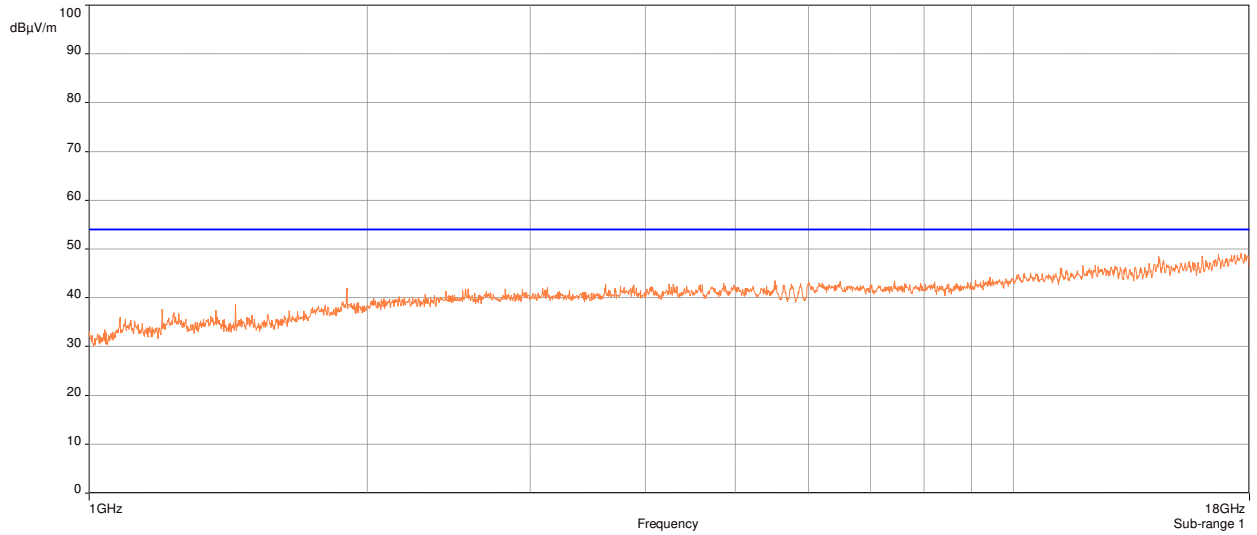

Plot 33: Radiated Spurious Emissions Requirements, 802.11a, High Channel UNII-3, Average

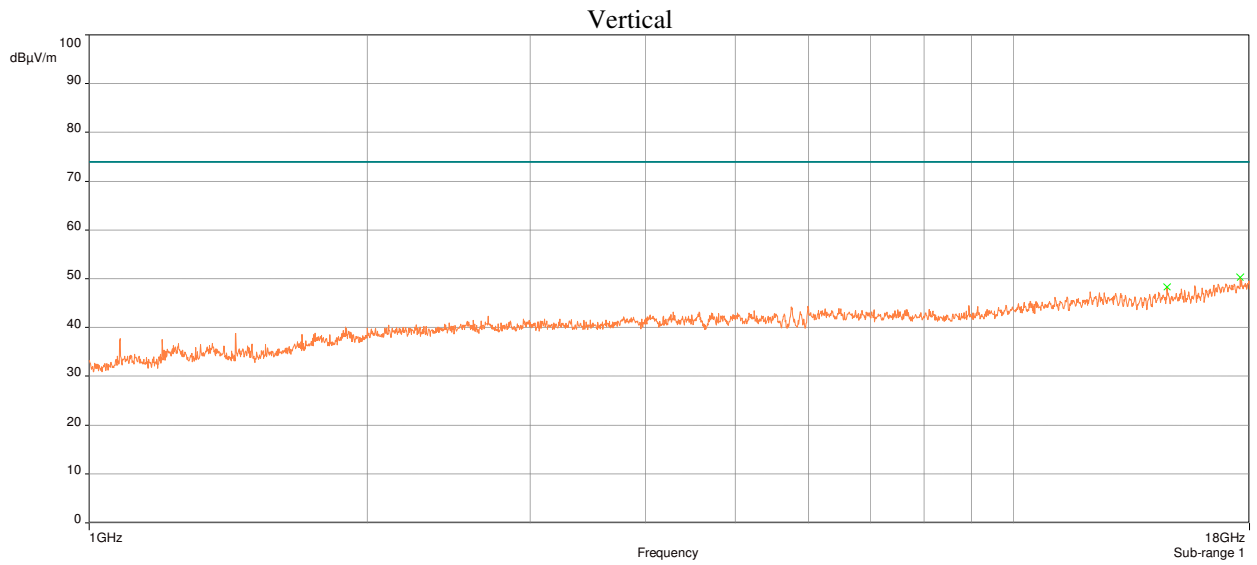
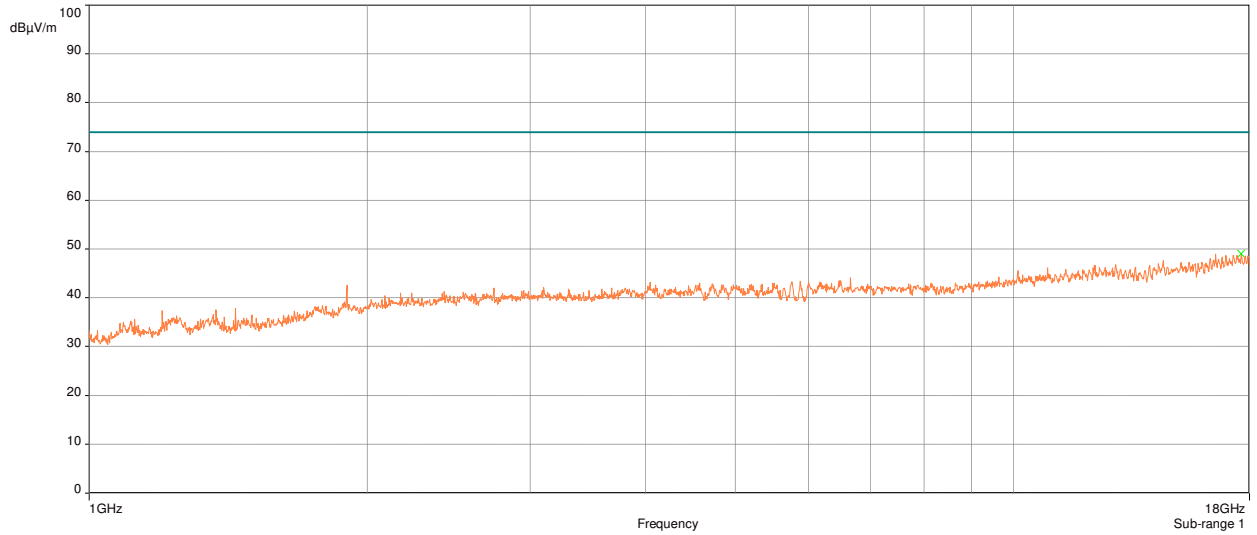

Plot 34: Radiated Spurious Emissions Requirements, 802.11n, Low Channel UNII-3, Peak

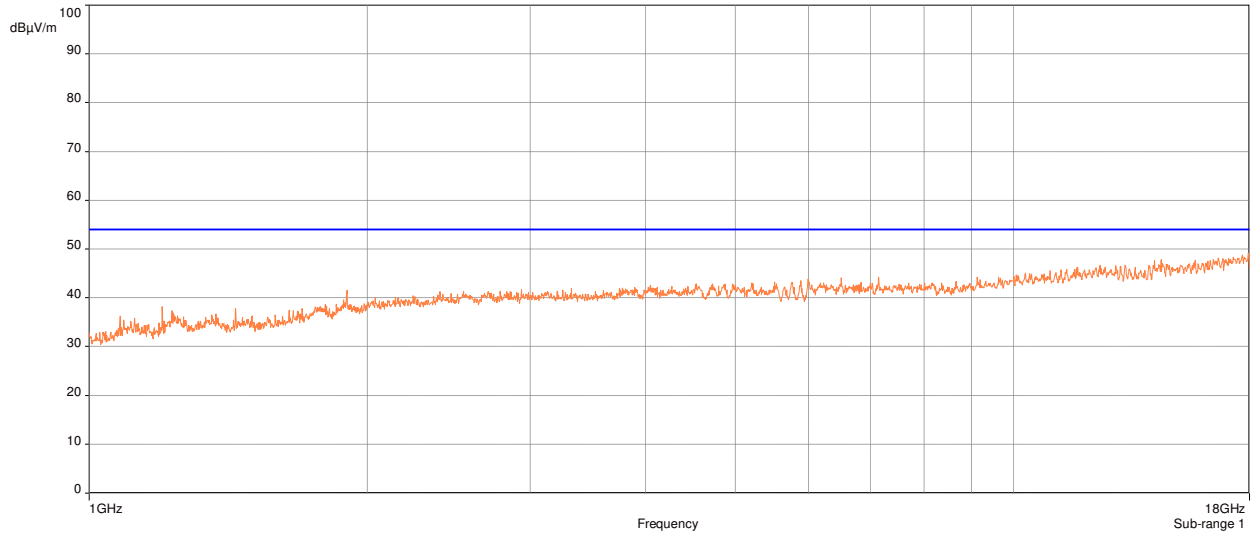

Vertical

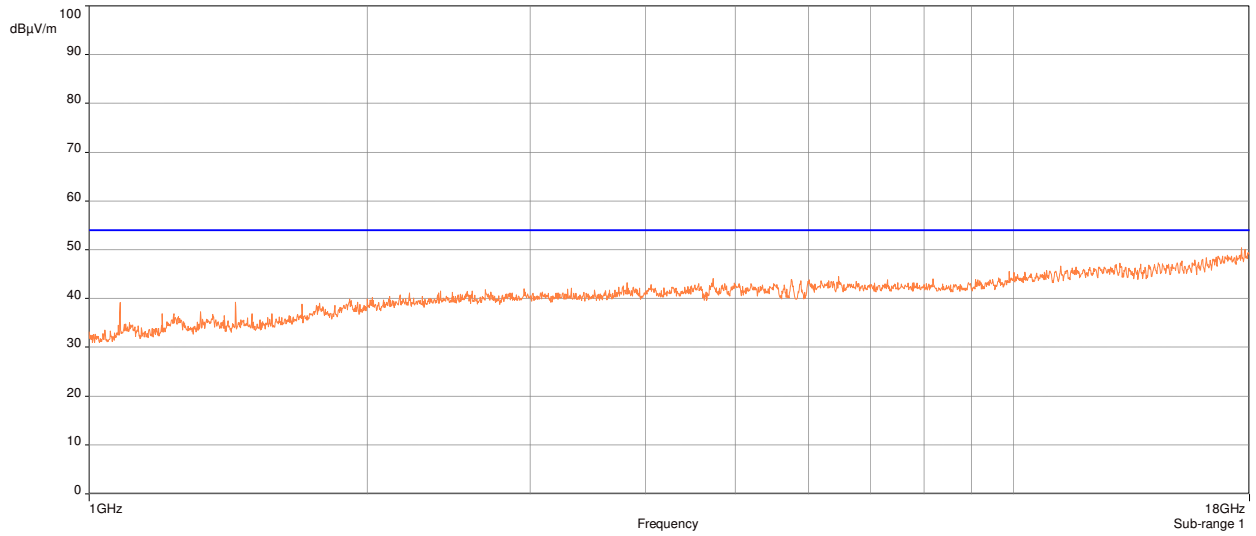

Horizontal

Plot 35: Radiated Spurious Emissions Requirements, 802.11n, Low Channel UNII-3, Average

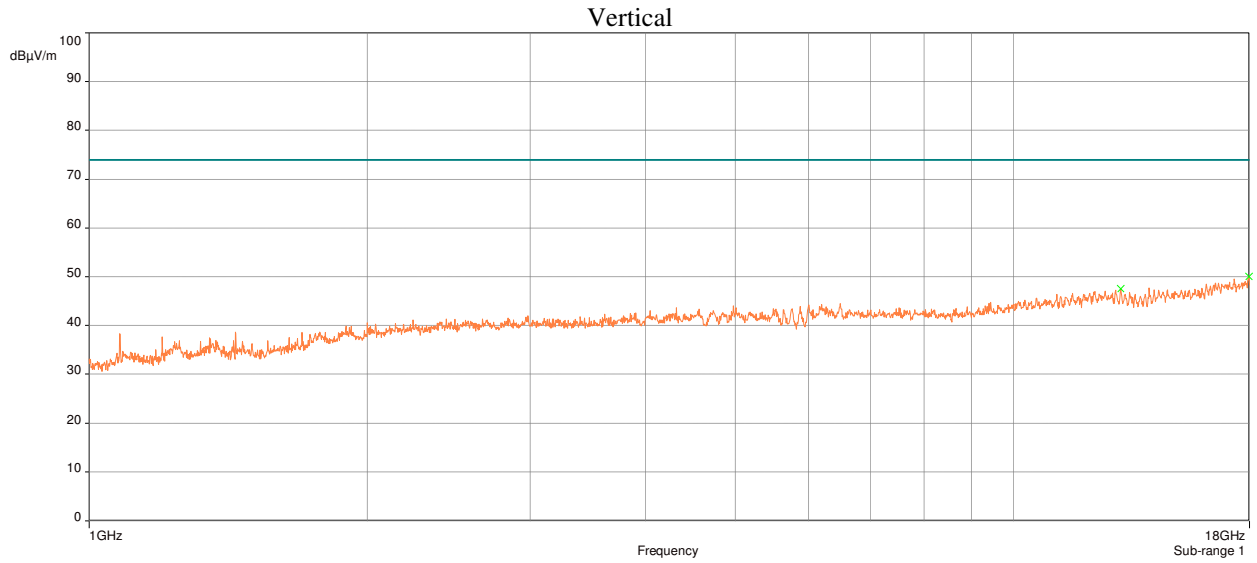
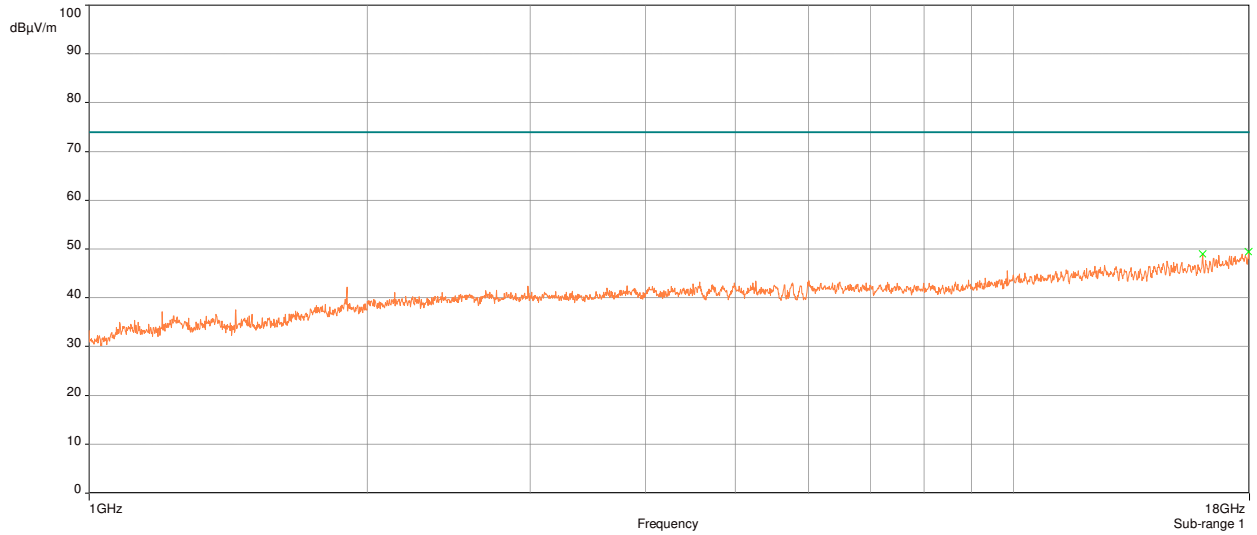

Plot 36: Radiated Spurious Emissions Requirements, 802.11n, Mid Channel UNII-3, Peak

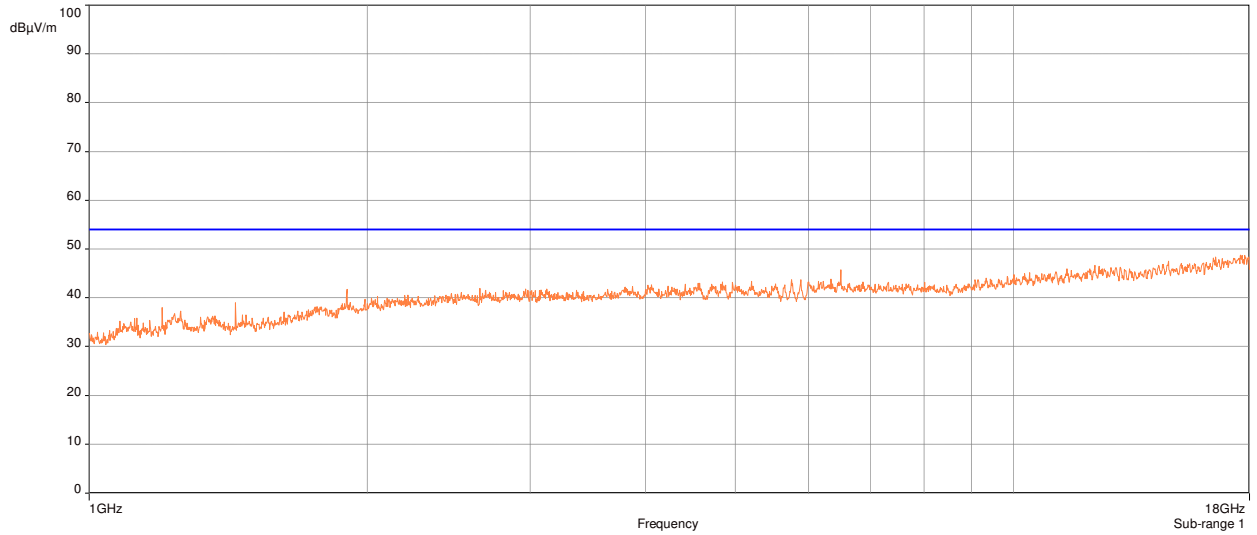

Vertical

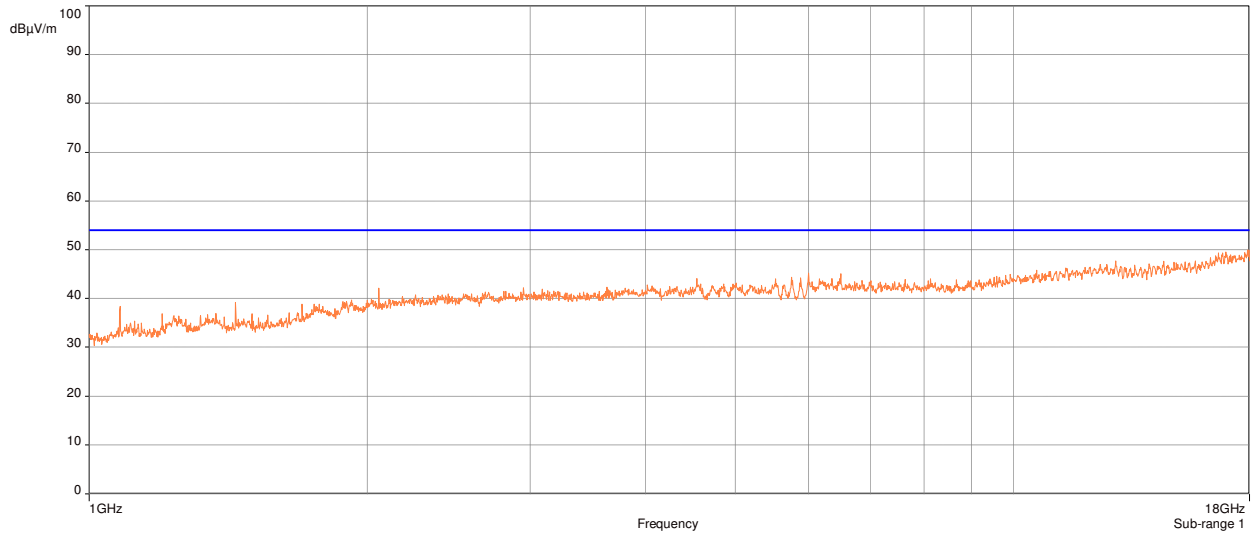

Horizontal

Plot 37: Radiated Spurious Emissions Requirements, 802.11n, Mid Channel UNII-3, Average

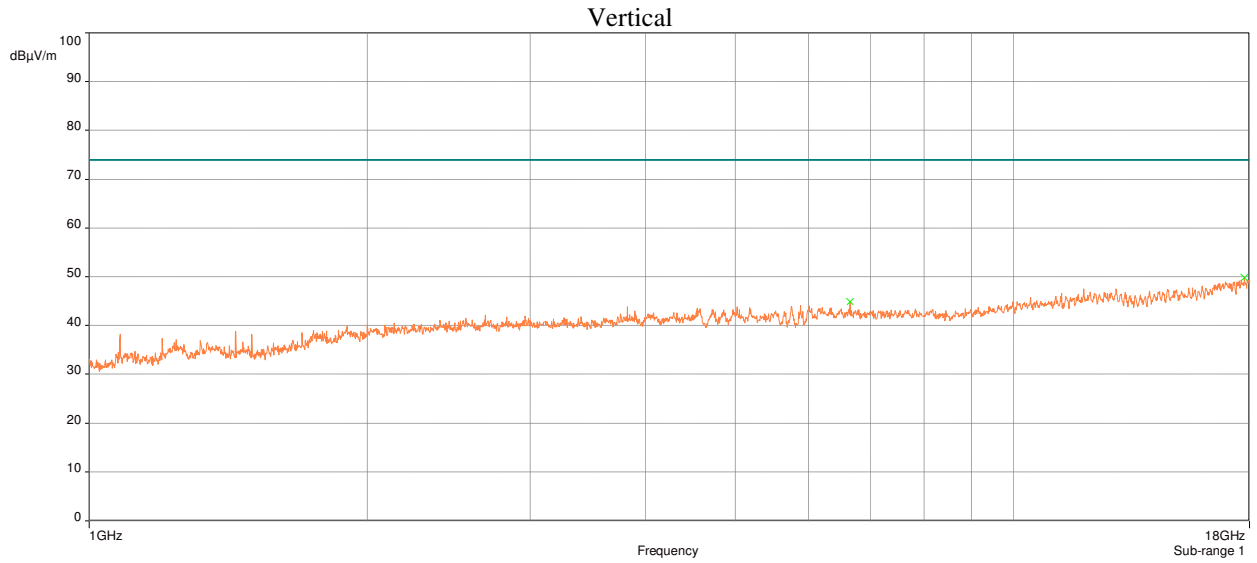
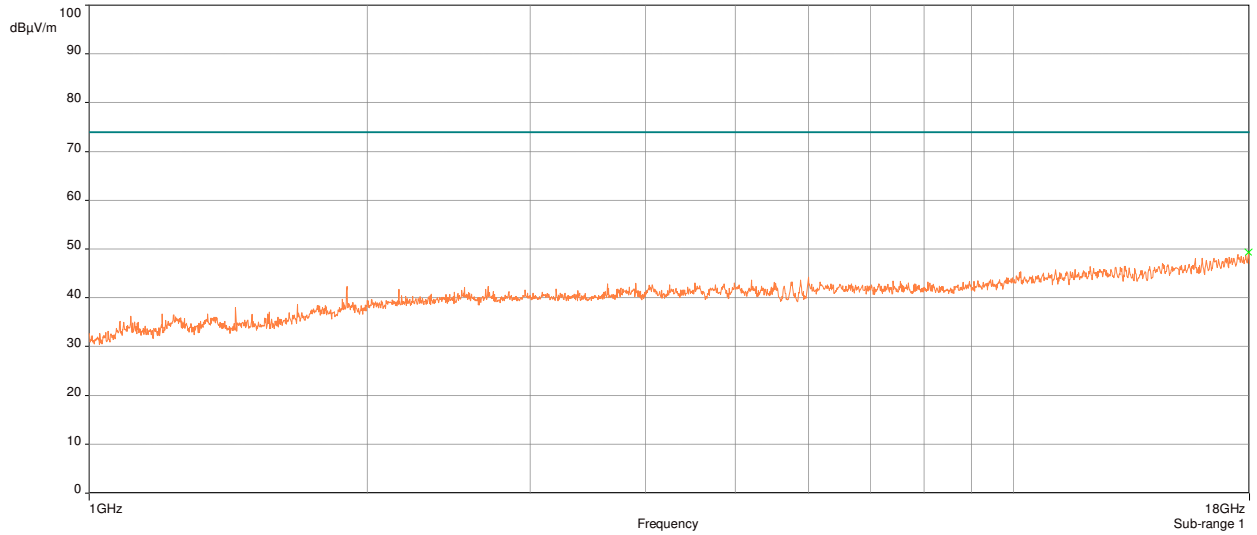

Plot 38: Radiated Spurious Emissions Requirements, 802.11n, High Channel UNII-3, Peak

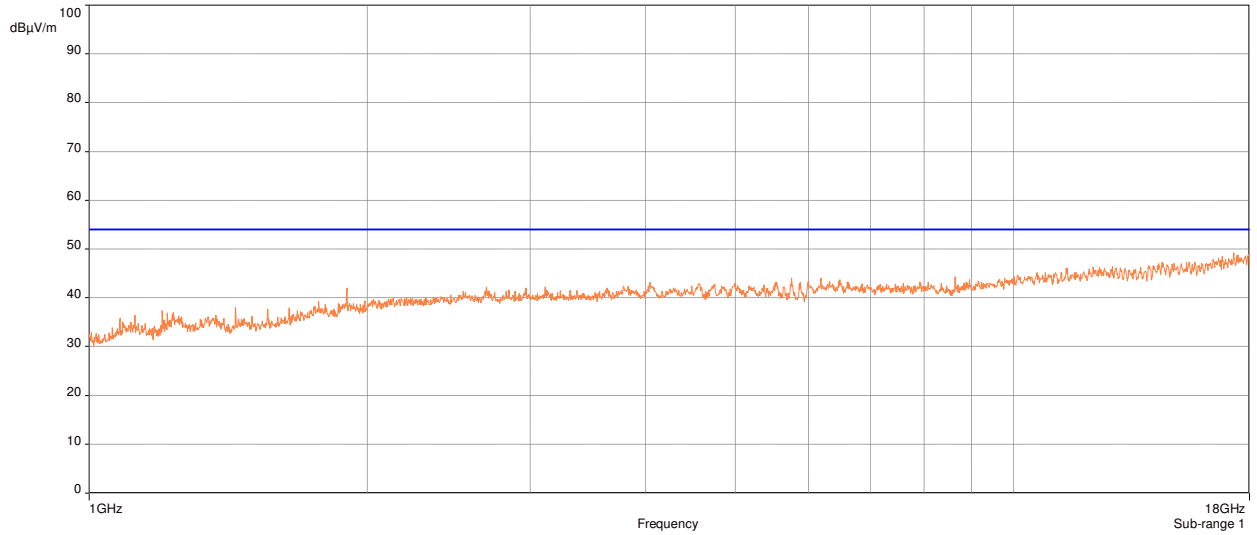

Vertical

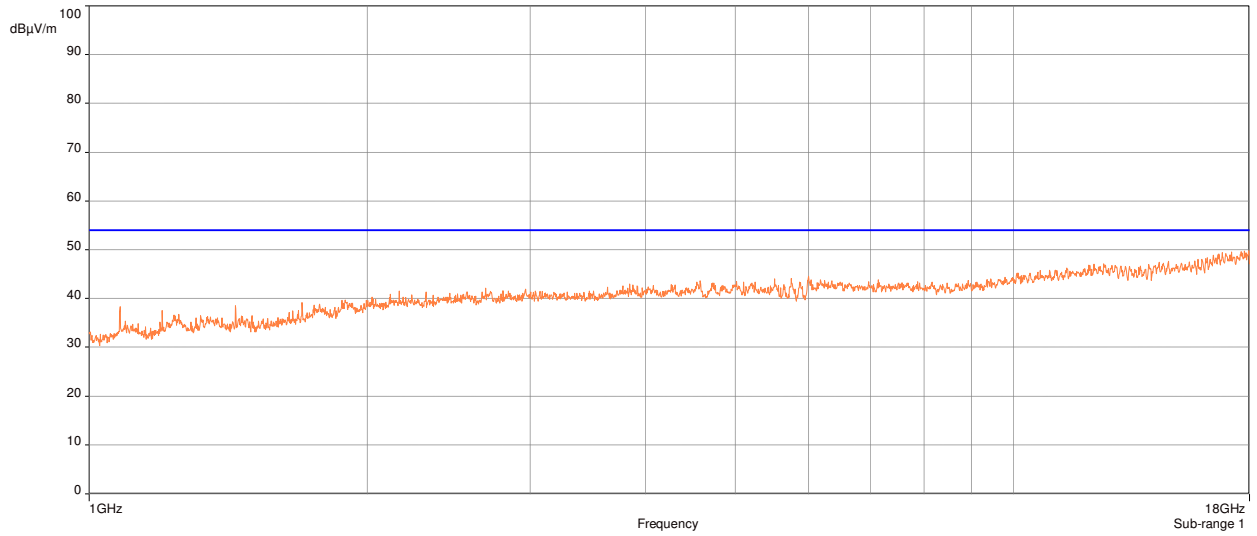

Horizontal

Plot 39: Radiated Spurious Emissions Requirements, 802.11n, High Channel UNII-3, Average

IV. Test Equipment

Test Equipment

Calibrated test equipment utilized during testing was maintained in a current state of calibration per the requirements of ISO/IEC 17025:2005.

ASSET #	NOMENCLATURE	MANUFACTURER	MODEL	LAST CAL	CAL DUE
1S2399	TURNTABLE CONTROLLER	SUNOL SCIENCE	SC99V	FUNCTIONAL VERIFY	
1S3928	EMI TESTER RECEIVER	ROHDE & SCHWARZ	ESR26	03/04/2020	03/04/2021
1S2600	BILOG ANTENNA	TESEQ	CBL6112D	03/19/2019	03/19/2021
1S2486	5 METER CHAMBER CONTROL ROOM	PANASHIELD	5 METER CONTROL ROOM	FUNCTIONAL VERIFY	
1S3926	1MHZ STEP, 1GHZ COMBO GENERATOR	COM-POWER CORP	CGO-501	FUNCTIONAL VERIFY	
1S4067	DIGITAL BAROMETER	CONTROL CO	6530	06/22/2020	06/22/2022
1S2481	10 METER CHAMBER	ETS-LINGREN	DKE-8X8 DBL	FUNCTIONAL VERIFY	
1S380	EMI RECEIVER	NARDA SAFETY TEST SOLUTIONS	PMM 9010F	8/23/2020	8/23/2021
1S245	COMB GENERATOR (RADIATED)	COM-POWER	GG510	FUNCTIONAL VERIFY	
1S2599	LASER PROBE INTERFACE	AMPLIFIER RESEARCH	F1700	FUNCTIONAL VERIFY	
1S2603	DOUBLE RIDGED WAVEGUIDE HORN	ETS-LINDGREN	3117	09/18/2020	09/18/2022
1S2000	SPECTRUM ANALYZER	AGILENT	E4448A	11/06/2020	11/06/2022
1S3818	DRG HORN ANTENNA	A.H. SYSTEMS, INC	SAS-574	09/24/2020	09/24/2022

Table 12: Test Equipment List

Note: Functionally tested equipment is verified using calibrated instrumentation at the time of testing.

End of Report