

TEST REPORT

Applicant: Guilin Feiyu Technology Incorporated Company
Address: Feiyu Intelligent Industry Park, No.2, Chuangyou Road, Information Industry Park, Qixing District, Guilin, Guangxi, 541004, China
Equipment Type: Feiyu SCORP-Mini 2 3-Axis Handheld Gimbal for Camera
Model Name: FeiyuF1-2
Brand Name: FeiyuTech
FCC ID: 2AHW7-FEYUF1-2
Test Standard: 47 CFR Part 15 Subpart C (refer to section 3.1)
Sample Arrival Date: Jul. 26, 2023
Test Date: Aug. 03, 2023 - Aug. 23, 2023
Date of Issue: Oct. 18, 2023

ISSUED BY:

Shenzhen BALUN Technology Co., Ltd.

Tested by: Julie zhu

Checked by: Ye Hongji

Approved by: Liao Jianming
(Technical Director)

Julie zhu

Ye Hongji

Liao Jianming

Revision History		
Version	Issue Date	Revisions
Rev. 01	Oct. 09, 2023	Initial Issue
Rev. 02	Oct. 18, 2023	Update section 4.2 Test Equipment List

TABLE OF CONTENTS

1	GENERAL INFORMATION	4
1.1	Test Laboratory	4
1.2	Test Location	4
2	PRODUCT INFORMATION	5
2.1	Applicant Information	5
2.2	Manufacturer Information	5
2.3	General Description for Equipment under Test (EUT)	5
2.4	Technical Information	6
3	SUMMARY OF TEST RESULTS	8
3.1	Test Standards	8
3.2	Test Verdict	8
4	GENERAL TEST CONFIGURATIONS	9
4.1	Test Environments	9
4.2	Test Equipment List	9
4.3	Test Software List	9
4.4	Measurement Uncertainty	10
4.5	Description of Test Setup	10
4.6	Measurement Results Explanation Example	13
5	TEST ITEMS	14
5.1	Antenna Requirements	14
5.2	Output Power	15
5.3	Occupied Bandwidth	17
5.4	Conducted Spurious Emission	18

5.5	Band Edge (Authorized-band band-edge).....	20
5.6	Conducted Emission	22
5.7	Radiated Spurious Emission	23
5.8	Band Edge (Restricted-band band-edge).....	28
5.9	Power Spectral density (PSD).....	29
ANNEX A	TEST RESULT	30
A.1	Output Power	30
A.2	Occupied Bandwidth	32
A.3	Conducted Spurious Emissions	37
A.4	Band Edge (Authorized-band band-edge).....	44
A.5	Conducted Emissions.....	47
A.6	Radiated Emission	49
A.7	Band Edge (Restricted-band band-edge).....	60
A.8	Power Spectral Density (PSD)	66
ANNEX B	TEST SETUP PHOTOS	69
ANNEX C	EUT EXTERNAL PHOTOS	69
ANNEX D	EUT INTERNAL PHOTOS	69

1 GENERAL INFORMATION

1.1 Test Laboratory

Name	Shenzhen BALUN Technology Co., Ltd.
Address	Block B, 1/F, Baisha Science and Technology Park, Shahe Xi Road, Nanshan District, Shenzhen, Guangdong Province, P. R. China
Phone Number	+86 755 6685 0100

1.2 Test Location

Name	Shenzhen BALUN Technology Co., Ltd.
Location	<input checked="" type="checkbox"/> Block B, 1/F, Baisha Science and Technology Park, Shahe Xi Road, Nanshan District, Shenzhen, Guangdong Province, P. R. China
	<input type="checkbox"/> 1/F, Building B, Ganghongji High-tech Intelligent Industrial Park, No. 1008, Songbai Road, Yangguang Community, Xili Sub-district, Nanshan District, Shenzhen, Guangdong Province, P. R. China
Accreditation Certificate	The laboratory is a testing organization accredited by FCC as a accredited testing laboratory. The designation number is CN1196.

2 PRODUCT INFORMATION

2.1 Applicant Information

Applicant	Guilin Feiyu Technology Incorporated Company
Address	Feiyu Intelligent Industry Park, No.2, Chuangyou Road, Information Industry Park, Qixing District, Guilin, Guangxi, 541004, China

2.2 Manufacturer Information

Manufacturer	Guilin Feiyu Technology Incorporated Company
Address	Feiyu Intelligent Industry Park, No.2, Chuangyou Road, Information Industry Park, Qixing District, Guilin, Guangxi, 541004, China

2.3 General Description for Equipment under Test (EUT)

EUT Name	Feiyu SCORP-Mini 2 3-Axis Handheld Gimbal for Camera
Model Name Under Test	FeiyuF1-2
Series Model Name	N/A
Description of Model name differentiation	N/A
Serial Number	N/A
Hardware Version	V1.0
Software Version	V1.0
Dimensions (Approx.)	N/A
Weight (Approx.)	N/A

2.4 Technical Information

Network and Wireless connectivity	Bluetooth BLE 2.4G WIFI 802.11b, 802.11g, 802.11n(HT20)
-----------------------------------	--

The requirement for the following technical information of the EUT was tested in this report:

Frequency Range	802.11b/g/n(20 MHz): 2.412 GHz - 2.462 GHz $f_c = 2412 \text{ MHz} + (N-1)*5 \text{ MHz}$, where - f_c = "Operating Frequency" in MHz, - N = "Channel Number" with the range from 1 to 11.
Modulation Type	DSSS, OFDM
Product Type	<input type="checkbox"/> Mobile <input checked="" type="checkbox"/> Portable <input type="checkbox"/> Fix Location
Antenna System (eg., MIMO, Smart Antenna)	N/A
Categorization as Correlated or Completely Uncorrelated	N/A
Antenna Type	PCB Antenna
Antenna Gain	1.58 dBi
About the Product	Only the WIFI 802.11b, 802.11g, 802.11n (HT20) was tested in this report.

Modulation technology	Modulation Type	Transfer Rate (Mbps)(Single RF path)
DSSS (802.11b)	DBPSK	1
	DQPSK	2
	CCK	5.5/11
OFDM (802.11g)	BPSK	6/9
	QPSK	12/18
	16QAM	24/36
	64QAM	48/54
OFDM (802.11n-20 MHz)	BPSK	6.5/7.2
	QPSK	13/19.5/14.4/21.7
	16QAM	26/39/28.9/43.3
	64QAM	52/58.5/65/57.8/65/72.2

Note: Preliminary tests were performed in different data rate in above table to find the worst radiated emission. The data rate shown in the table below is the worst-case rate with respect to the specific test item. Investigation has been done on all the possible configurations for searching the worst cases. The following table is a list of the test modes shown in this test report.

Test Items	Mode	Data Rate	Channel
Output Power	11b/11g/11n20	1/6/6.5 Mbps	1/6/11
Occupied Bandwidth	11b/11g/11n20	1/6/6.5 Mbps	1/6/11
Conducted Spurious Emission	11b/11g/11n20	1/6/6.5 Mbps	1/6/11
Conducted Emission	11b/11g/11n20	1/6/6.5 Mbps	1/6/11
Radiated Spurious Emission	11b/11g/11n20	1/6/6.5 Mbps	1/6/11
Band Edge	11b/11g/11n20	1/6/6.5 Mbps	1/6/11
Power spectral density (PSD)	11b/11g/11n20	1/6/6.5 Mbps	1/6/11

Note: The above EUT information in section 2.3 was declared by manufacturer and for more detailed features description, please refer to the manufacturer's specifications or user's manual.

3 SUMMARY OF TEST RESULTS

3.1 Test Standards

No.	Identity	Document Title
1	47 CFR Part 15, Subpart C	Intentional radiators of radio frequency equipment
2	ANSI C63.10-2013	American National Standard of Procedures for Compliance Testing of Unlicensed Wireless Devices
3	KDB Publication 558074 D01v05r02	GUIDANCE FOR COMPLIANCE MEASUREMENTS ON DIGITAL TRANSMISSION SYSTEM, FREQUENCY HOPPING SPREAD SPECTRUM SYSTEM, AND HYBRID SYSTEM DEVICES OPERATING UNDER SECTION 15.247 OF THE FCC RULES

3.2 Test Verdict

No.	Description	FCC PART No.	Test Result	Verdict
1	Antenna Requirement	15.203	N/A	Pass ^{Note 1}
2	Output Power	15.247 (b)	ANNEX A.1	Pass
3	Occupied Bandwidth	15.247 (a)	ANNEX A.2	Pass
4	Conducted Spurious Emission	15.247 (d)	ANNEX A.3	Pass
5	Band Edge(Authorized-band band-edge)	15.247 (d)	ANNEX A.4	Pass
6	Conducted Emission	15.207	ANNEX A.5	Pass
7	Radiated Spurious Emission	15.209; 15.247 (d)	ANNEX A.6	Pass
8	Band Edge(Restricted-band band-edge)	15.209; 15.247 (d)	ANNEX A.7	Pass
9	Power spectral density (PSD)	15.247 (e)	ANNEX A.8	Pass

Note 1: The EUT has a permanently and irreplaceable attached antenna, which complies with the requirement FCC 15.203.

4 GENERAL TEST CONFIGURATIONS

4.1 Test Environments

During the measurement, the normal environmental conditions were within the listed ranges:

Relative Humidity	39% to 64%	
Atmospheric Pressure	100 kPa to 102 kPa	
Temperature	NT (Normal Temperature)	+20.0°C to +24.8°C
Working Voltage of the EUT	NV (Normal Voltage)	7.4V

4.2 Test Equipment List

Description	Manufacturer	Model	Serial No.	Cal. Date	Cal. Due
Spectrum Analyzer	KEYSIGHT	N9020A	MY50330200	2023.05.16	2024.05.15
Power Sensor	KEYSIGHT	U2063XA	MY58000251	2023.07.12	2024.07.11
Spectrum Analyzer	KEYSIGHT	N9020A	MY52510065	2022.09.06	2023.09.05
Test Antenna-Horn	SCHWARZBECK	BBHA 9120D	01631	2022.02.03	2025.02.02
Test Antenna-Horn	A-INFO	LB- 180400KF	J211060273	2021.07.02	2024.07.01
Anechoic Chamber	RAINFORD	9m*6m*6m	144	2022.02.19	2024.09.03
EMI Receiver	ROHDE&SCHWARZ	ESRP	101036	2022.09.09	2023.09.08
Test Antenna-Bi-Log	SCHWARZBECK	VULB 9168	00883	2022.04.01	2025.03.31
Test Antenna-Loop	SCHWARZBECK	FMZB 1519	1519-037	2021.04.16	2024.04.15
Anechoic Chamber	EMC Electronic Co., Ltd	20.10*11.60 *7.35m	130	2021.08.15	2024.08.14
EMI Receiver	KEYSIGHT	N9010B	MY57110309	2022.09.09	2023.09.08
LISN	SCHWARZBECK	NSLK 8127	8127-687	2023.05.16	2024.05.15
Shielded Enclosure	YiHeng Electronic Co., Ltd	3.5m*3.1m* 2.8m	112	2022.02.19	2025.02.18
Amplifier	COM-MV	LSCX_LNA 1-12G-01	180602	2020.09.08	2023.09.07
Amplifier	COM-MV	XKu_LNA7- 18G-01	180601	2020.09.08	2023.09.07
Amplifier	COM-MV	KA_LNA18- 40G-01	18050001	2020.09.08	2023.09.07
Amplifier	COM-MV	ZT30- 1000M	B2017119082	2022.12.07	2023.12.06

4.3 Test Software List

Description	Manufacturer	Software Version	Serial No.	Applicable test Setup
BL410R	BALUN	V2.1.1.488	N/A	The section 4.5.1
BL410E	BALUN	V22.930	N/A	The section 4.5.2&4.5.3&4.5.4&4.5.5

4.4 Measurement Uncertainty

The following measurement uncertainty levels have been estimated for tests performed on the EUT as specified in CISPR 16-4-2.

This uncertainty represents an expanded uncertainty expressed at approximately the 95% confidence level using a coverage factor of k=2.

Parameters	Uncertainty
Occupied Channel Bandwidth	2.8%
RF output power, conducted	1.28 dB
Power Spectral Density, conducted	1.30 dB
Unwanted Emissions, conducted	1.84 dB
All emissions, radiated	5.36 dB
Temperature	0.8°C
Humidity	4%

4.5 Description of Test Setup

4.5.1 For Antenna Port Test

$$\text{Conducted value (dBm)} = \text{Measurement value (dBm)} + \text{cable loss (dB)}$$

For example: the measurement value is 10 dBm and the cable 0.5dBm used, then the final result of EUT:

$$\text{Conducted value (dBm)} = 10 \text{ dBm} + 0.5 \text{ dB} = 10.5 \text{ dBm}$$

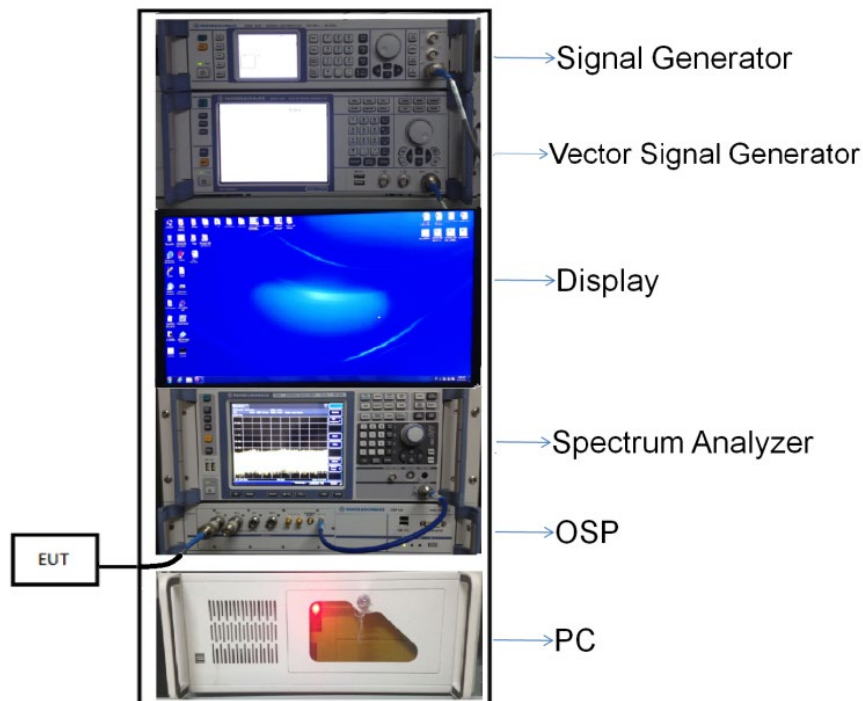

(Diagram 1)

4.5.2 For AC Power Supply Port Test



(Diagram 2)

4.5.3 For Radiated Test (Below 30 MHz)

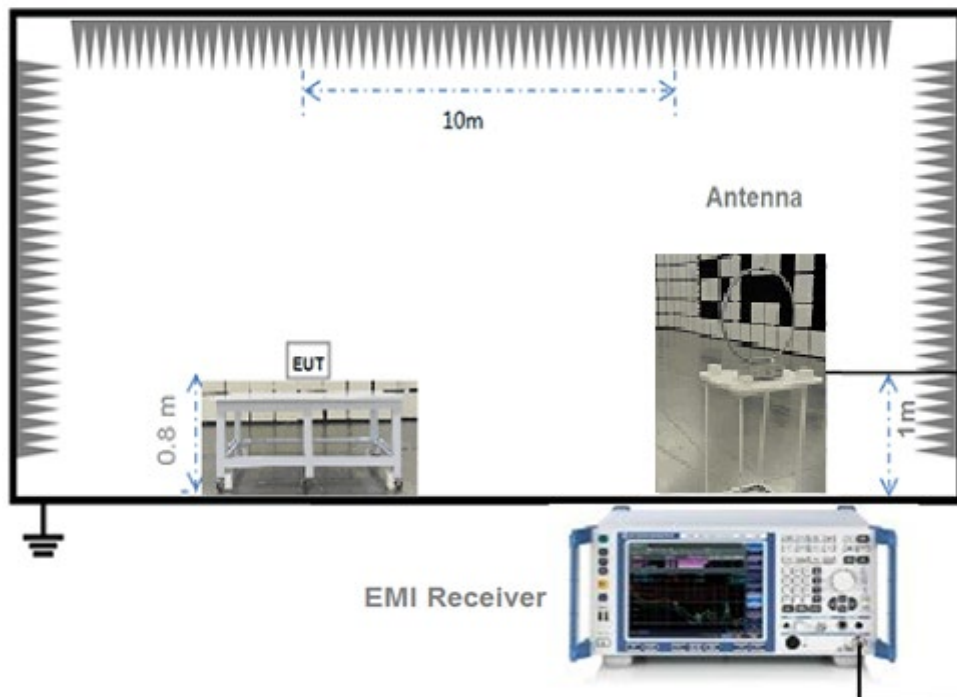

(Diagram 3)

4.5.4 For Radiated Test (30 MHz-1 GHz)

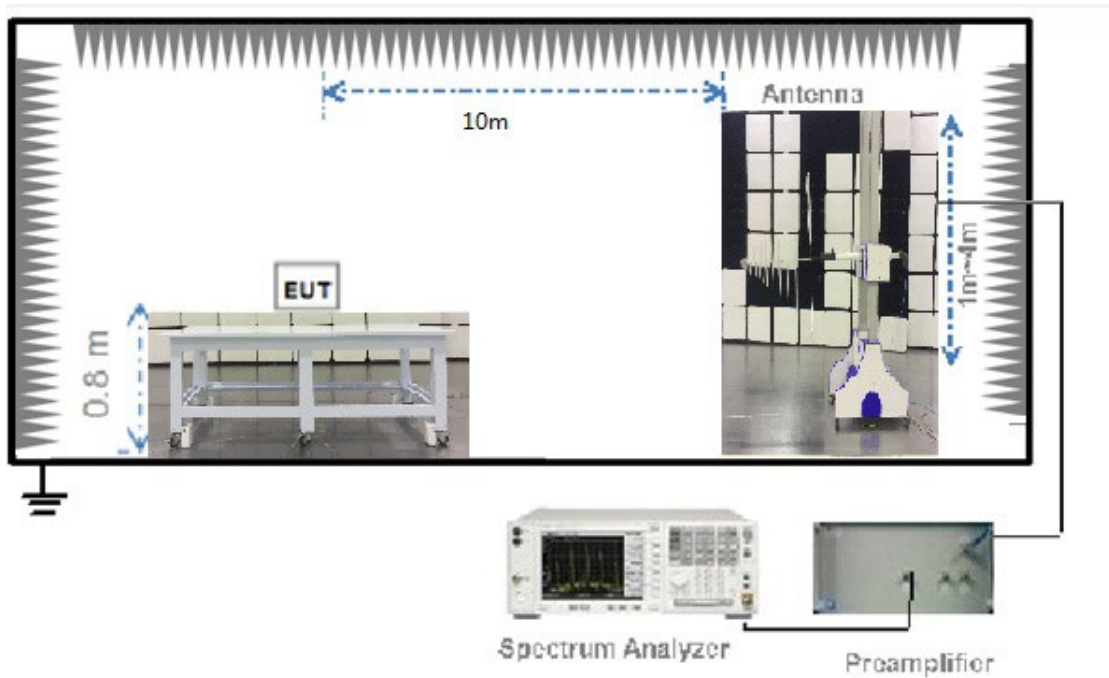

(Diagram 4)

4.5.5 For Radiated Test (Above 1 GHz)

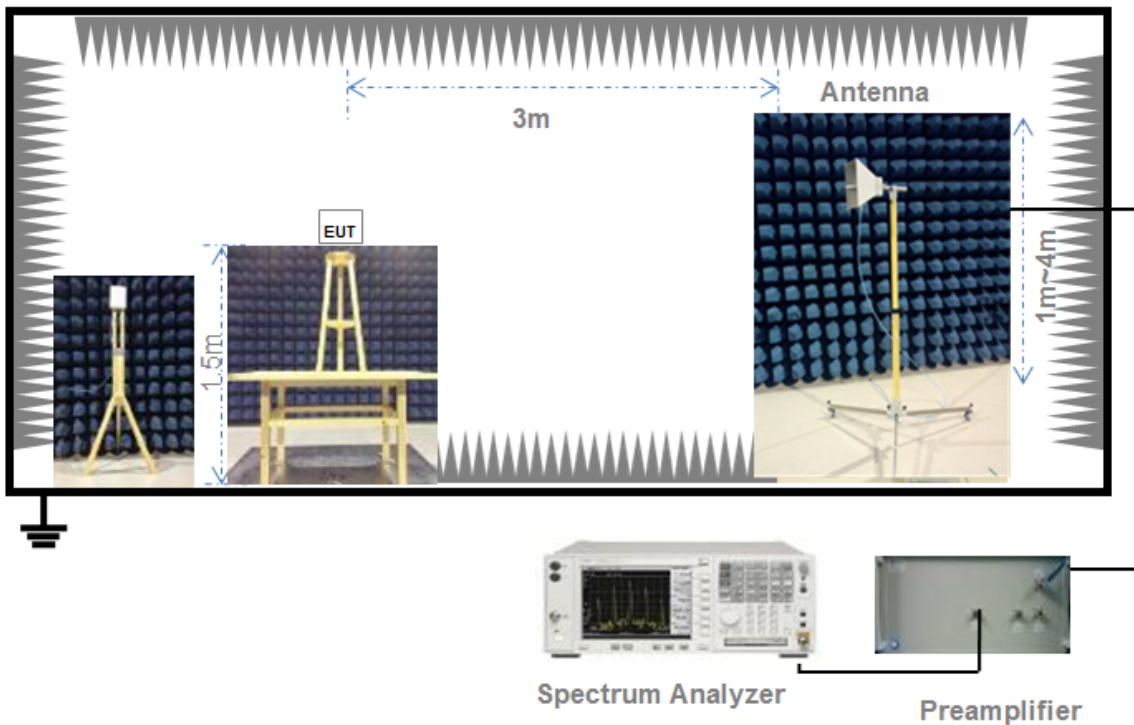

(Diagram 5)

4.6 Measurement Results Explanation Example

4.6.1 For conducted test items:

The offset level is set in the spectrum analyzer to compensate the RF cable loss and attenuator between EUT conducted output port and spectrum analyzer. With the offset compensation, the spectrum analyzer reading level is exactly the EUT RF output level.

The spectrum analyzer offset is derived from RF cable loss and attenuator factor.

Offset = RF cable loss + attenuator factor.

4.6.2 For radiated band edges and spurious emission test:

$$E = \text{EIRP} - 20 \log D + 104.8$$

where:

E = electric field strength in dB μ V/m,

EIRP = equivalent isotropic radiated power in dBm

D = specified measurement distance in meters.

EIRP = Measure Conducted output power Value (dBm) + Maximum transmit antenna gain (dBi) + the appropriate maximum ground reflection factor (dB)

5 TEST ITEMS

5.1 Antenna Requirements

5.1.1 Relevant Standards

FCC §15.203

An intentional radiator shall be designed to ensure that no antenna other than that furnished by the responsible party shall be used with the device. The use of a permanently attached antenna or of an antenna that uses a unique coupling to the intentional radiator shall be considered sufficient to comply with the provisions of this section. The manufacturer may design the unit so that a broken antenna can be replaced by the user, but the use of a standard antenna jack or electrical connector is prohibited. This requirement does not apply to carrier current devices or to devices operated under the provisions of § 15.211, § 15.213, § 15.217, § 15.219, or § 15.221. Further, this requirement does not apply to intentional radiators that must be professionally installed, such as perimeter protection systems and some field disturbance sensors, or to other intentional radiators which, in accordance with § 15.31(d), must be measured at the installation site. However, the installer shall be responsible for ensuring that the proper antenna is employed so that the limits in this part are not exceeded.

If directional gain of transmitting antennas is greater than 6 dBi, the power shall be reduced by the same level in dB comparing to gain minus 6 dBi. For the fixed point-to-point operation, the power shall be reduced by one dB for every 3 dB that the directional gain of the antenna exceeds 6 dBi. The use of a permanently attached antenna or of an antenna that uses a unique coupling to the intentional radiator shall be considered sufficient to comply with the FCC rule.

5.1.2 Antenna Anti-Replacement Construction

The Antenna Anti-Replacement as following method:

Protected Method	Description
The antenna is embedded in the product.	An embedded-in antenna design is used.

Reference Documents	Item
Photo	Please refer to the EUT Photo documents.

5.1.3 Antenna Gain

The antenna peak gain of EUT is less than 6 dBi. Therefore, it is not necessary to reduce maximum peak output power limit.

5.2 Output Power

5.2.1 Test Limit

FCC § 15.247(b)

For systems using digital modulation in the 902-928 MHz, 2400-2483.5 MHz, and 5725-5850 MHz bands: 1 Watt. As an alternative to a peak power measurement, compliance with the one Watt limit can be based on a measurement of the maximum conducted output power. Maximum Conducted Output Power is defined as the total transmit power delivered to all antennas and antenna elements averaged across all symbols in the signaling alphabet when the transmitter is operating at its maximum power control level. Power must be summed across all antennas and antenna elements.

5.2.2 Test Setup

See section 4.5.1 for test setup description for the antenna port. The photo of test setup please refer to ANNEX B.

5.2.3 Test Procedure

Maximum peak conducted output power

The maximum peak conducted output power may be measured using a broadband peak RF power meter. The power meter shall have a video bandwidth that is greater than or equal to the DTS bandwidth and shall utilize a fast-responding diode detector.

Maximum conducted (average) output power (Reporting Only)

a) As an alternative to spectrum analyzer or EMI receiver measurements, measurements may be performed

using a wideband RF power meter with a thermocouple detector or equivalent if all of the conditions listed below are satisfied.

- 1) The EUT is configured to transmit continuously, or to transmit with a constant duty factor.
- 2) At all times when the EUT is transmitting, it shall be transmitting at its maximum power control level.
- 3) The integration period of the power meter exceeds the repetition period of the transmitted signal by at least a factor of five.

b) If the transmitter does not transmit continuously, measure the duty cycle (x) of the transmitter output signal as

described in Section 6.0.

c) Measure the average power of the transmitter. This measurement is an average over both the on and off periods of the transmitter.

d) Adjust the measurement in dBm by adding $10\log(1/x)$, where x is the duty cycle to the measurement result.

Measurements of duty cycle

The zero-span mode on a spectrum analyzer or EMI receiver if the response time and spacing between bins on the sweep are sufficient to permit accurate measurements of the on and off times of the transmitted signal.

Set the center frequency of the instrument to the center frequency of the transmission.

Set $RBW \geq OBW$ if possible; otherwise, set RBW to the largest available value.

Set $VBW \geq RBW$. Set detector = peak or average.

The zero-span measurement method shall not be used unless both RBW and VBW are $> 50/T$ and the number of sweep points across duration T exceeds 100. (For example, if VBW and/or RBW are limited to 3 MHz, then the zero-span method of measuring duty cycle shall not be used if $T \leq 16.7$ microseconds.)

5.2.4 Test Result

Please refer to ANNEX A.1.

5.3 Occupied Bandwidth

5.3.1 Limit

FCC §15.247(a)

Make the measurement with the spectrum analyzer's resolution bandwidth (RBW) = 100 kHz. In order to make an accurate measurement, set the span greater than RBW. The 6 dB bandwidth must be greater than 500 kHz.

5.3.2 Test Setup

See section 4.5.1 for test setup description for the antenna port. The photo of test setup please refer to ANNEX B.

5.3.3 Test Procedure

Use the following spectrum analyzer settings:

Set RBW = 100 kHz.

Set the video bandwidth (VBW) \geq 3 RBW.

Detector = Peak.

Trace mode = max hold.

Sweep = auto couple.

Allow the trace to stabilize.

Measure the maximum width of the emission that is constrained by the frequencies associated with the two outermost amplitude points (upper and lower frequencies) that are attenuated by 6 dB relative to the maximum level measured in the fundamental emission.

5.3.4 Test Result

Please refer to ANNEX A.2.

5.4 Conducted Spurious Emission

5.4.1 Limit

FCC §15.247(d)

In any 100 kHz bandwidth outside the frequency band in which the spread spectrum or digitally modulated intentional radiator is operating, the radio frequency power that is produced by the intentional radiator shall be at least 20 dB below that in the 100 kHz bandwidth within the band that contains the highest level of the desired power, based on either an RF conducted or a radiated measurement.

5.4.2 Test Setup

See section 4.5.1 for test setup description for the antenna port. The photo of test setup please refer to ANNEX B.

5.4.3 Test Procedure

The DTS rules specify that in any 100 kHz bandwidth outside of the authorized frequency band, the power shall be attenuated according to the following conditions:

- a) If the maximum peak conducted output power procedure was used to demonstrate compliance as described in 9.1, then the peak output power measured in any 100 kHz bandwidth outside of the authorized frequency band shall be attenuated by at least 20 dB relative to the maximum in-band peak PSD level in 100 kHz (i.e., 20 dBc).
- b) If maximum conducted (average) output power was used to demonstrate compliance as described in 9.2, then the peak power in any 100 kHz bandwidth outside of the authorized frequency band shall be attenuated by at least 30 dB relative to the maximum in-band peak PSD level in 100 kHz (i.e., 30 dBc).
- c) In either case, attenuation to levels below the 15.209 general radiated emissions limits is not required.

The following procedures shall be used to demonstrate compliance to these limits. Note that these procedures can be used in either an antenna-port conducted or radiated test set-up. Radiated tests must conform to the test site requirements and utilize maximization procedures defined herein.

Reference level measurement

Establish a reference level by using the following procedure:

Set instrument center frequency to DTS channel center frequency.

Set the span to ≥ 1.5 times the DTS bandwidth.

Set the RBW = 100 kHz.

Set the VBW $\geq 3 \times$ RBW.

Detector = peak.

Sweep time = auto couple.

Trace mode = max hold.

Allow trace to fully stabilize.

Use the peak marker function to determine the maximum PSD level.

Emission level measurement

Use the following spectrum analyzer settings:

Span = wide enough to capture the peak level of the in-band emission and all spurious emissions (e.g., harmonics) from the lowest frequency generated in the EUT up through the 10th harmonic. Typically, several plots are required to cover this entire span.

Set the RBW = 100 kHz.

Set the VBW $\geq 3 \times$ RBW.

Detector = peak.

Sweep time = auto couple.

Trace mode = max hold.

Allow trace to fully stabilize.

Use the peak marker function to determine the maximum amplitude level.

Ensure that the amplitude of all unwanted emissions outside of the authorized frequency band (excluding restricted frequency bands) are attenuated by at least the minimum requirements specified in 11.1 a) or 11.1 b). Report the three highest emissions relative to the limit.

5.4.4 Test Result

Please refer to ANNEX A.3.

5.5 Band Edge (Authorized-band band-edge)

5.5.1 Limit

FCC §15.247(d)

In any 100 kHz bandwidth outside the frequency band in which the spread spectrum or digitally modulated intentional radiator is operating, the radio frequency power that is produced by the intentional radiator shall be at least 20 dB below that in the 100 kHz bandwidth within the band that contains the highest level of the desired power, based on either an RF conducted or a radiated measurement.

5.5.2 Test Setup

See section 4.5.1 for test setup description for the antenna port. The photo of test setup please refer to ANNEX B.

5.5.3 Test Procedure

The following procedures may be used to determine the peak or average field strength or power of an unwanted emission that is within 2 MHz of the authorized band edge. If a peak detector is utilized, use the procedure described in 13.2.1. Use the procedure described in 13.2.2 when using an average detector and the EUT can be configured to transmit continuously (i.e., duty cycle $\geq 98\%$). Use the procedure described in 13.2.3 when using an average detector and the EUT cannot be configured to transmit continuously but the duty cycle is constant (i.e., duty cycle variations are less than ± 2 percent). Use the procedure described in 13.2.4 when using an average detector for those cases where the EUT cannot be configured to transmit continuously and the duty cycle is not constant (duty cycle variations equal or exceed 2 percent).

When using a peak detector to measure unwanted emissions at or near the band edge (within 2 MHz of the authorized band), the following integration procedure can be used.

Set instrument center frequency to the frequency of the emission to be measured (must be within 2 MHz of the authorized band edge).

Set span to 2 MHz

RBW = 100 kHz.

VBW $\geq 3 \times$ RBW.

Detector = peak.

Sweep time = auto.

Trace mode = max hold.

Allow sweep to continue until the trace stabilizes (required measurement time may increase for low duty cycle applications)

Compute the power by integrating the spectrum over 1 MHz using the analyzer's band power measurement function with band limits set equal to the emission frequency (femission) ± 0.5 MHz. If the instrument does not have a band power function, then sum the amplitude levels (in power units) at 100 kHz intervals extending across the 1 MHz spectrum defined by femission ± 0.5 MHz.

Standard method(The 99% OBW of the fundamental emission is without 2 MHz of the authorized band):

Span: Wide enough to capture the peak level of the emission operating on the channel closest to the band edge, as well as any modulation products that fall outside of the authorized band of operation.

Reference level: As required to keep the signal from exceeding the maximum instrument input mixer level for linear operation. In general, the peak of the spectral envelope shall be more than $[10 \log (\text{OBW}/\text{RBW})]$ below the reference level. Specific guidance is given in 4.1.5.2.

Attenuation: Auto (at least 10 dB preferred).

Sweep time: Coupled.

Resolution bandwidth: 100 kHz.

Video bandwidth: 300 kHz.

Detector: Peak.

Trace: Max hold.

5.5.4 Test Result

Please refer to ANNEX A.4.

5.6 Conducted Emission

5.6.1 Limit

FCC §15.207

For an intentional radiator that is designed to be connected to the public utility (AC) power line, the radio frequency voltage that is conducted back onto the AC power line on any frequency within the band 150 kHz to 30 MHz shall not exceed the limits in the following table, as measured using a 50 μ H/50 Ω line impedance stabilization network (LISN).

Frequency range (MHz)	Conducted Limit (dB μ V)	
	Quai-peak	Average
0.15 - 0.50	66 to 56	56 to 46
0.50 - 5	56	46
0.50 - 30	60	50

5.6.2 Test Setup

See section 4.5.2 for test setup description for the AC power supply port. The photo of test setup please refer to ANNEX B.

5.6.3 Test Procedure

The maximum conducted interference is searched using Peak (PK), if the emission levels more than the AV and QP limits, and that have narrow margins from the AV and QP limits will be re-measured with AV and QP detectors. Tests for both L phase and N phase lines of the power mains connected to the EUT are performed. Refer to recorded points and plots below.

Devices subject to Part 15 must be tested for all available U.S. voltages and frequencies (such as a nominal 120 VAC, 50/60 Hz and 240 VAC, 50/60 Hz) for which the device is capable of operation. A device rated for 50/60 Hz operation need not be tested at both frequencies provided the radiated and line conducted emissions are the same at both frequencies.

5.6.4 Test Result

Please refer to ANNEX A.5.

5.7 Radiated Spurious Emission

5.7.1 Limit

FCC §15.209&15.247(d)

Radiated emission outside the frequency band attenuation below the general limits specified in FCC section 15.209(a) is not required. In addition, radiated emissions which fall in the restricted bands, as defined in FCC section 15.205(a), must also comply with the radiated emission limits specified in FCC section 15.209(a).

According to FCC section 15.209 (a), except as provided elsewhere in this subpart, the emissions from an intentional radiator shall not exceed the field strength levels specified in the following table:

Frequency (MHz)	Field Strength ($\mu\text{V}/\text{m}$)	Measurement Distance (m)
0.009 - 0.490	2400/F(kHz)	300
0.490 - 1.705	24000/F(kHz)	30
1.705 - 30.0	30	30
30 - 88	100	3
88 - 216	150	3
216 - 960	200	3
Above 960	500	3

Note:

1. For Above 1000 MHz, the emission limit in this paragraph is based on measurement instrumentation employing an average detector, measurement using instrumentation with a peak detector function, corresponding to 20dB above the maximum permitted average limit.
2. For above 1000 MHz, limit field strength of harmonics: 54dBuV/m@3m (AV) and 74dBuV/m@3m (PK).

5.7.2 Test Setup

See section 4.5.3 to 4.5.5 for test setup description for the antenna port. The photo of test setup please refer to ANNEX B.

5.7.3 Test Procedure

Since the emission limits are specified in terms of radiated field strength levels, measurements performed to demonstrate compliance have traditionally relied on a radiated test configuration. Radiated measurements remain the principal method for demonstrating compliance to the specified limits; however antenna-port conducted measurements are also now acceptable to demonstrate compliance (see below for details). When radiated measurements are utilized, test site requirements and procedures for maximizing and measuring radiated emissions that are described in ANSI C63.10 shall be followed.

Antenna-port conducted measurements may also be used as an alternative to radiated measurements for demonstrating compliance in the restricted frequency bands. If conducted measurements are performed, then proper impedance matching must be ensured and an additional radiated test for cabinet/case spurious emissions is required.

General Procedure for conducted measurements in restricted bands

- a) Measure the conducted output power (in dBm) using the detector specified (see guidance regarding measurement procedures for determining quasi-peak, peak, and average conducted output power, respectively).
- b) Add the maximum transmit antenna gain (in dBi) to the measured output power level to determine the EIRP level (see guidance on determining the applicable antenna gain)
- c) Add the appropriate maximum ground reflection factor to the EIRP level (6 dB for frequencies ≤ 30 MHz, 4.7 dB for frequencies between 30 MHz and 1000 MHz, inclusive and 0 dB for frequencies > 1000 MHz).
- d) For devices with multiple antenna-ports, measure the power of each individual chain and sum the EIRP of all chains in linear terms (e.g., Watts, mW).
- e) Convert the resultant EIRP level to an equivalent electric field strength using the following relationship:

$$E = \text{EIRP} - 20\log D + 104.8$$

where:

E = electric field strength in dB μ V/m,

EIRP = equivalent isotropic radiated power in dBm

D = specified measurement distance in meters.

- f) Compare the resultant electric field strength level to the applicable limit.
- g) Perform radiated spurious emission test.

Quasi-Peak measurement procedure

The specifications for measurements using the CISPR quasi-peak detector can be found in Publication 16 of the International Special Committee on Radio Frequency Interference (CISPR) of the International Electrotechnical Commission.

As an alternative to CISPR quasi-peak measurement, compliance can be demonstrated to the applicable emission limits using a peak detector.

Peak power measurement procedure

Peak emission levels are measured by setting the instrument as follows:

- a) RBW = as specified in Table 1.
- b) VBW $\geq 3 \times$ RBW.
- c) Detector = Peak.
- d) Sweep time = auto.
- e) Trace mode = max hold.
- f) Allow sweeps to continue until the trace stabilizes. (Note that the required measurement time may be

longer for low duty cycle applications).

Table 1—RBW as a function of frequency

Frequency	RBW
9-150 kHz	200-300 Hz
0.15-30 MHz	9-10 kHz
30-1000 MHz	100-120 kHz
> 1000 MHz	1 MHz

If the peak-detected amplitude can be shown to comply with the average limit, then it is not necessary to perform a separate average measurement.

Trace averaging across on and off times of the EUT transmissions followed by duty cycle correction

If continuous transmission of the EUT (i.e., duty cycle ≥ 98 percent) cannot be achieved and the duty cycle is constant (i.e., duty cycle variations are less than ± 2 percent), then the following procedure shall be used:

- a) The EUT shall be configured to operate at the maximum achievable duty cycle.
- b) Measure the duty cycle, x , of the transmitter output signal as described in section 6.0.
- c) RBW = 1 MHz (unless otherwise specified).
- d) VBW $\geq 3 \times$ RBW.
- e) Detector = RMS, if $\text{span}/(\# \text{ of points in sweep}) \leq (\text{RBW}/2)$. Satisfying this condition may require increasing the number of points in the sweep or reducing the span. If this condition cannot be satisfied, then the detector mode shall be set to peak.
- f) Averaging type = power (i.e., RMS).
 - 1) As an alternative, the detector and averaging type may be set for linear voltage averaging.
 - 2) Some instruments require linear display mode in order to use linear voltage averaging. Log or dB averaging shall not be used.
- g) Sweep time = auto.
- h) Perform a trace average of at least 100 traces.
- i) A correction factor shall be added to the measurement results prior to comparing to the emission limit in order to compute the emission level that would have been measured had the test been performed at 100 percent duty cycle. The correction factor is computed as follows:
 - 1) If power averaging (RMS) mode was used in step f), then the applicable correction factor is $10 \log(1/x)$, where x is the duty cycle.
 - 2) If linear voltage averaging mode was used in step f), then the applicable correction factor is $20 \log(1/x)$, where x is the duty cycle.
 - 3) If a specific emission is demonstrated to be continuous (≥ 98 percent duty cycle) rather than turning on and off with the transmit cycle, then no duty cycle correction is required for that emission.

NOTE: Reduction of the measured emission amplitude levels to account for operational duty factor is not permitted. Compliance is based on emission levels occurring during transmission - not on an average across on and off times of the transmitter.

Determining the applicable transmit antenna gain

A conducted power measurement will determine the maximum output power associated with a restricted band emission; however, in order to determine the associated EIRP level, the gain of the transmitting antenna (in dBi) must be added to the measured output power (in dBm).

Since the out-of-band characteristics of the EUT transmit antenna will often be unknown, the use of a conservative antenna gain value is necessary. Thus, when determining the EIRP based on the measured conducted power, the upper bound on antenna gain for a device with a single RF output shall be selected as the maximum in-band gain of the antenna across all operating bands, or 2 dBi, whichever is greater. However, for devices that operate in multiple frequency bands while using the same transmit antenna, the highest gain of the antenna within the operating band nearest in frequency to the restricted band emission being measured may be used in lieu of the overall highest gain when the emission is at a frequency that is within 20 percent of the nearest band edge frequency, but in no case shall a value less than 2 dBi be used.

See KDB 662911 for guidance on calculating the additional array gain term when determining the effective antenna gain for a EUT with multiple outputs occupying the same or overlapping frequency ranges in the same band.

Radiated spurious emission test

An additional consideration when performing conducted measurements of restricted band emissions is that unwanted emissions radiating from the EUT cabinet, control circuits, power leads, or intermediate circuit elements will likely go undetected in a conducted measurement configuration. To address this concern, a radiated test shall be performed to ensure that emissions emanating from the EUT cabinet (rather than the antenna port) also comply with the applicable limits.

For these cabinet radiated spurious emission measurements the EUT transmit antenna may be replaced with a termination matching the nominal impedance of the antenna. Procedures for performing radiated measurements are specified in ANSI C63.10. All detected emissions shall comply with the applicable limits.

The measurement frequency range is from 30 MHz to the 10th harmonic of the fundamental frequency. The Turn Table is actuated to turn from 0° to 360°, and both horizontal and vertical polarizations of the Test Antenna are used to find the maximum radiated power. Mid channels on all channel bandwidth verified. Only the worst RB size/offset presented.

The power of the EUT transmitting frequency should be ignored.

All Spurious Emission tests were performed in X, Y, Z axis direction. And only the worst axis test condition was recorded in this test report.

Use the following spectrum analyzer settings:

Span = wide enough to fully capture the emission being measured

RBW = 1 MHz for $f \geq 1$ GHz, 100 kHz for $f < 1$ GHz

VBW \geq RBW

Sweep = auto

Detector function = peak

Trace = max hold

5.7.4 Test Result

Please refer to ANNEX A.6.

5.8 Band Edge (Restricted-band band-edge)

5.8.1 Limit

FCC §15.209&15.247(d)

Radiated emission outside the frequency band attenuation below the general limits specified in FCC section 15.209(a) is not required. In addition, radiated emissions which fall in the restricted bands, as defined in FCC section 15.205(a), must also comply with the radiated emission limits specified in FCC section 15.209(a).

5.8.2 Test Setup

See section 4.5.1 for test setup description for the antenna port. The photo of test setup please refer to ANNEX B.

5.8.3 Test Procedure

The measurement frequency range is from 9 kHz to the 10th harmonic of the fundamental frequency. The Turn Table is actuated to turn from 0° to 360°, and both horizontal and vertical polarizations of the Test Antenna are used to find the maximum radiated power. Mid channels on all channel bandwidth verified. Only the worst RB size/offset presented.

The power of the EUT transmitting frequency should be ignored.

All Spurious Emission tests were performed in X, Y, Z axis direction. And only the worst axis test condition was recorded in this test report.

Use the following spectrum analyzer settings:

Span = wide enough to fully capture the emission being measured

RBW = 1 MHz for $f \geq 1$ GHz, 100 kHz for $f < 1$ GHz

VBW \geq RBW

Sweep = auto

Detector function = peak

Trace = max hold

For measurement below 1GHz, If the emission level of the EUT measured by the peak detector is 3 dB lower than the applicable limit, the peak emission level will be reported, Otherwise, the emission measurement will be repeated using the quasi-peak detector and reported.

For transmitters operating above 1 GHz repeat the measurement with an average detector.

5.8.4 Test Result

Please refer to ANNEX A.7.

5.9 Power Spectral density (PSD)

5.9.1 Limit

FCC §15.247(e)

The same method of determining the conducted output power shall be used to determine the power spectral density. If a peak output power is measured, then a peak power spectral density measurement is required. If an average output power is measured, then an average power spectral density measurement should be used.

5.9.2 Test Setup

See section 4.5.1 for test setup description for the antenna port. The photo of test setup please refer to ANNEX B.

5.9.3 Test Procedure

Set analyzer center frequency to DTS channel center frequency.

Set the span to 1.5 times the DTS bandwidth.

Set the RBW to: $3 \text{ kHz} \leq \text{RBW} \leq 100 \text{ kHz}$.

Set the VBW $\geq 3 \text{ RBW}$.

Detector = peak.

Sweep time = auto couple.

Trace mode = max hold.

Allow trace to fully stabilize.

Use the peak marker function to determine the maximum amplitude level within the RBW.

If measured value exceeds limit, reduce RBW (no less than 3 kHz) and repeat.

5.9.4 Test Result

Please refer to ANNEX A.8.

ANNEX A TEST RESULT

A.1 Output Power

Duty Cycle

Test Mode	On Time (ms)	On+Off time (ms)	Duty Cycle
802.11b	50	50	100.00%
802.11g	50	50	100.00%
802.11n-20 MHz	50	50	100.00%

Peak Power Test Data

802.11b Mode:

Channel	Measured Output Peak Power		Limit		Verdict
	dBm	mW	dBm	mW	
Low	5.75	3.76	30	1000	Pass
Middle	5.79	3.79			Pass
High	5.62	3.65			Pass

802.11g Mode:

Channel	Measured Output Peak Power		Limit		Verdict
	dBm	mW	dBm	mW	
Low	7.44	5.55	30	1000	Pass
Middle	7.65	5.82			Pass
High	7.55	5.69			Pass

802.11n-20 MHz Mode:

Channel	Measured Output Peak Power		Limit		Verdict
	dBm	mW	dBm	mW	
Low	7.87	6.12	30	1000	Pass
Middle	8.07	6.41			Pass
High	8.16	6.55			Pass

Average Power Test Data

802.11b Mode:

Channel	Measured Output Average Power		Limit		Verdict
	dBm	mW	dBm	mW	
Low	1.67	1.47	30	1000	Pass
Middle	1.76	1.50			Pass
High	1.72	1.49			Pass

802.11g Mode:

Channel	Measured Output Average Power		Limit		Verdict
	dBm	mW	dBm	mW	
Low	1.81	1.52	30	1000	Pass
Middle	1.85	1.53			Pass
High	1.77	1.50			Pass

802.11n-20 MHz Mode:

Channel	Measured Output Average Power		Limit		Verdict
	dBm	mW	dBm	mW	
Low	1.90	1.55	30	1000	Pass
Middle	1.86	1.53			Pass
High	1.93	1.56			Pass

A.2 Occupied Bandwidth

Test Data

802.11b Mode:

Channel	6 dB Bandwidth (MHz)	99% Bandwidth (MHz)	6 dB Bandwidth Limits (kHz)
Low	10.150000	13.098000	≥500
Middle	10.150000	13.113000	≥500
High	10.150000	13.131000	≥500

802.11g Mode:

Channel	6 dB Bandwidth (MHz)	99% Bandwidth (MHz)	6 dB Bandwidth Limits (kHz)
Low	16.500000	17.079000	≥500
Middle	16.550000	17.108000	≥500
High	16.600000	17.082000	≥500

802.11n-20MHz Mode:

Channel	6 dB Bandwidth (MHz)	99% Bandwidth (MHz)	6 dB Bandwidth Limits (kHz)
Low	17.750000	17.788000	≥500
Middle	17.700000	17.787000	≥500
High	17.750000	17.793000	≥500

Test Plots

6 dB Bandwidth

802.11b LOW CHANNEL

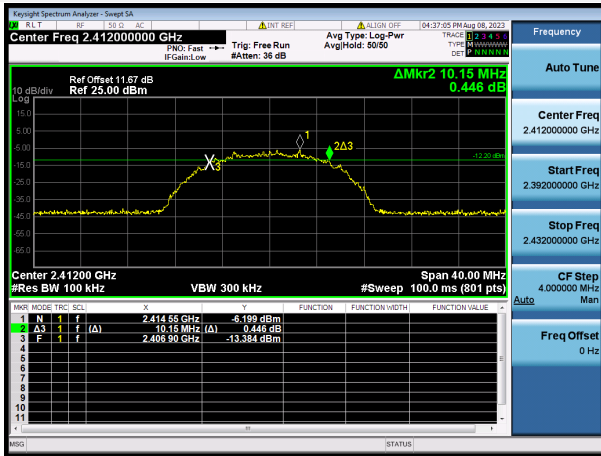

802.11b MIDDLE CHANNEL

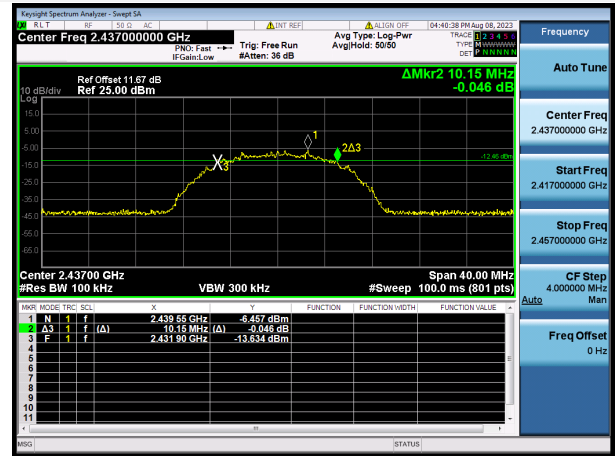

802.11b HIGH CHANNEL

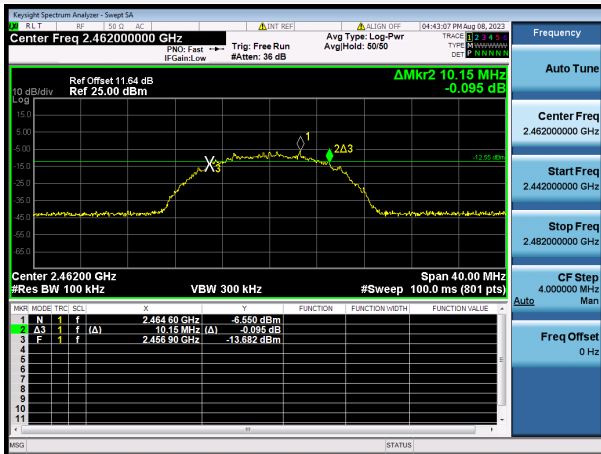

802.11g LOW CHANNEL

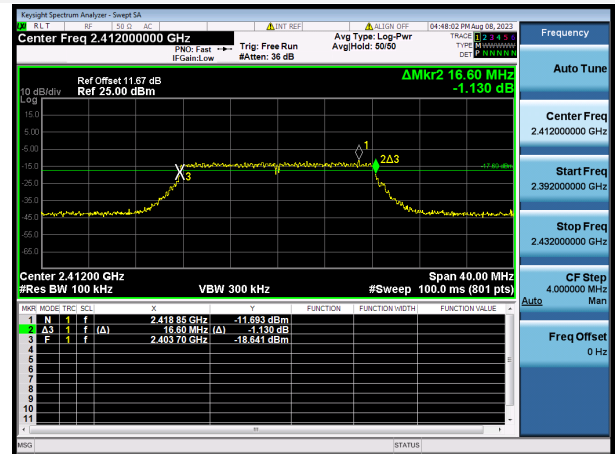

802.11g MIDDLE CHANNEL

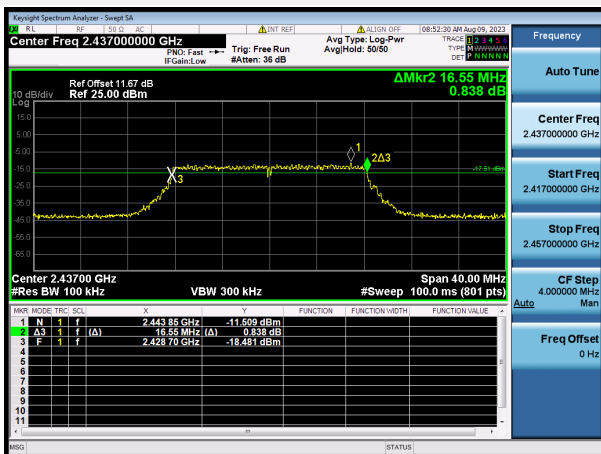

802.11g HIGH CHANNEL

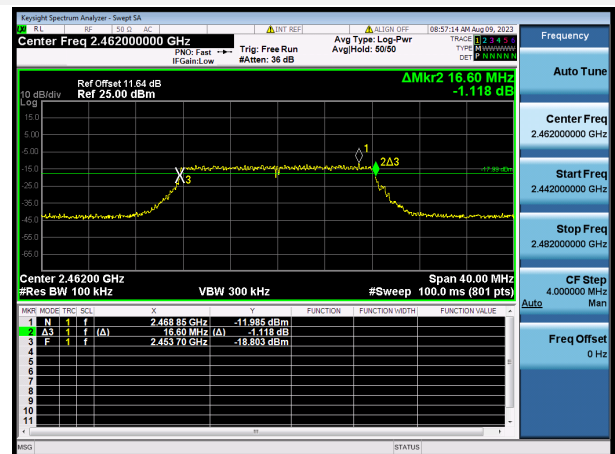

802.11n-20 MHz LOW CHANNEL

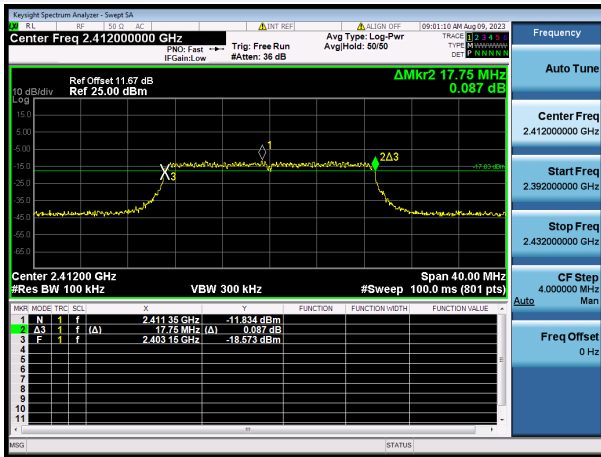

802.11n-20 MHz MIDDLE CHANNEL

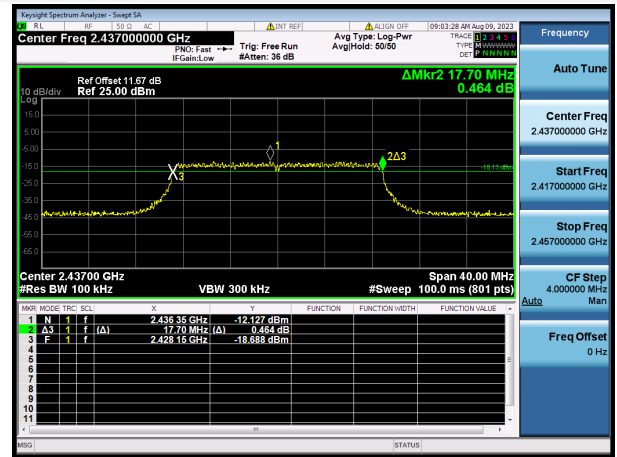

802.11n-20 MHz HIGH CHANNEL

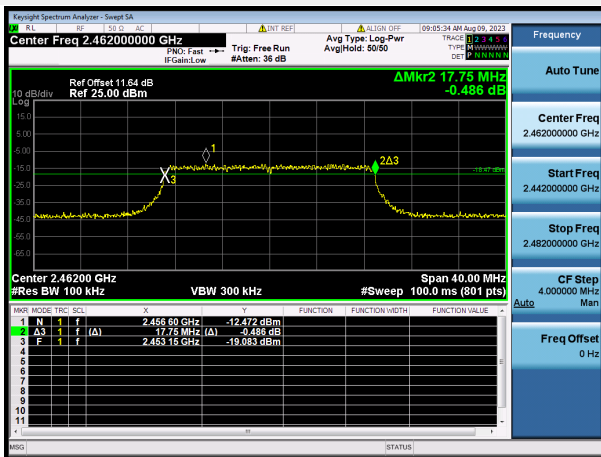

99% Bandwidth

802.11b LOW CHANNEL

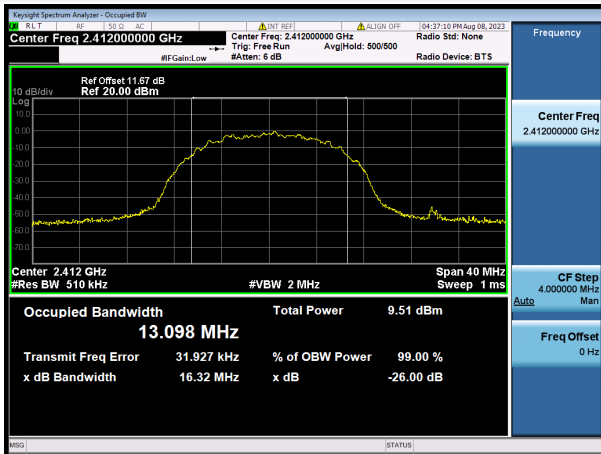

802.11b MIDDLE CHANNEL

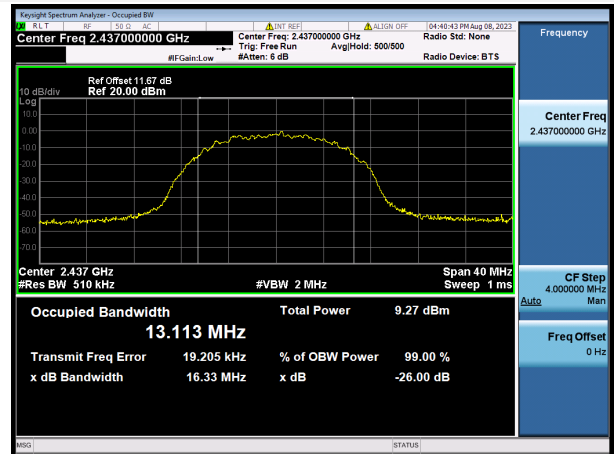

802.11b HIGH CHANNEL

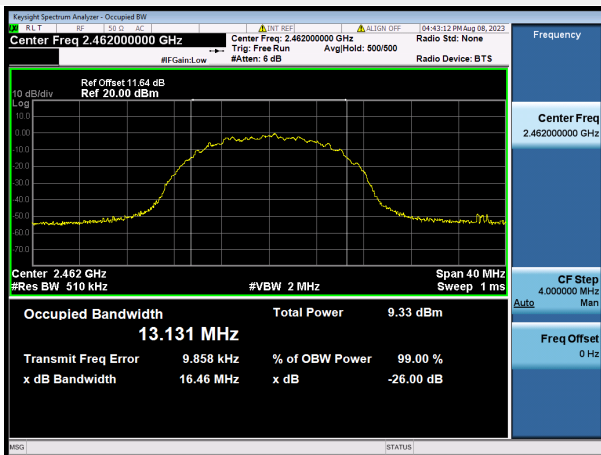

802.11g LOW CHANNEL

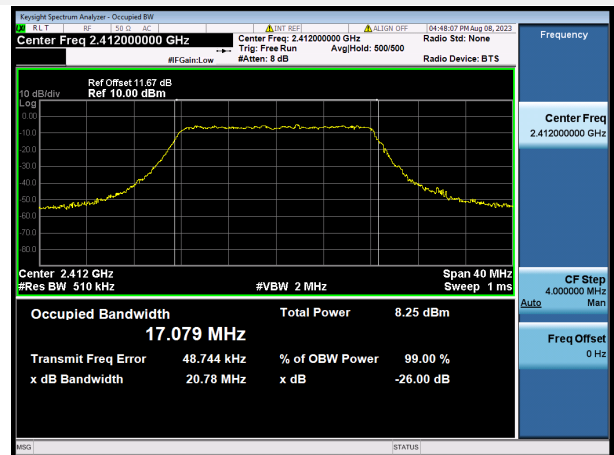

802.11g MIDDLE CHANNEL

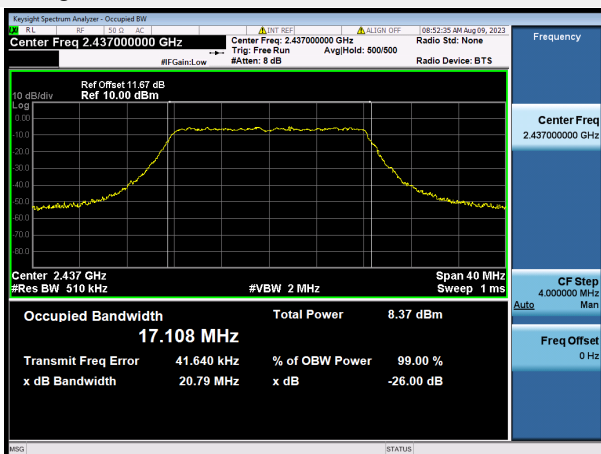

802.11g HIGH CHANNEL

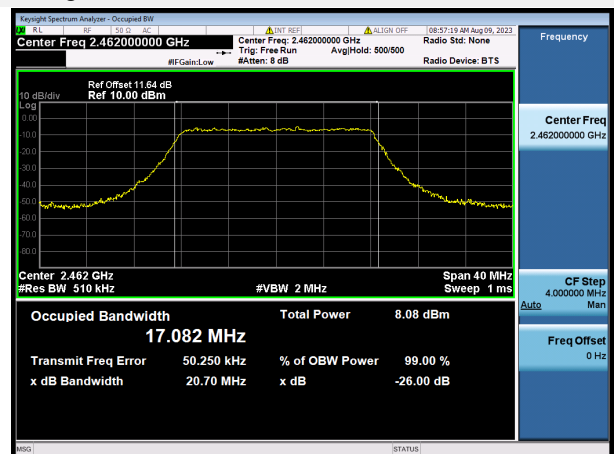

802.11n-20 MHz LOW CHANNEL

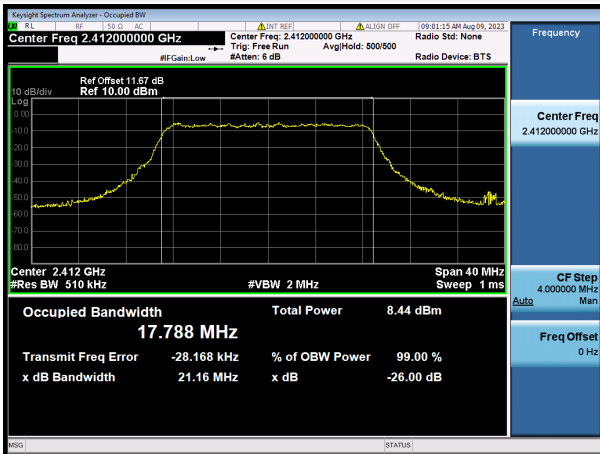

802.11n-20 MHz MIDDLE CHANNEL

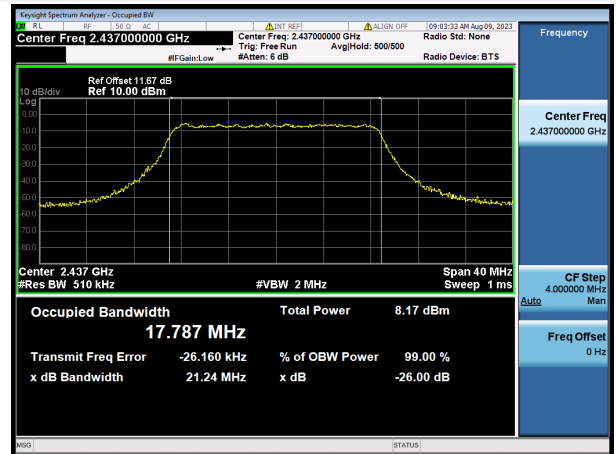

802.11n-20 MHz HIGH CHANNEL

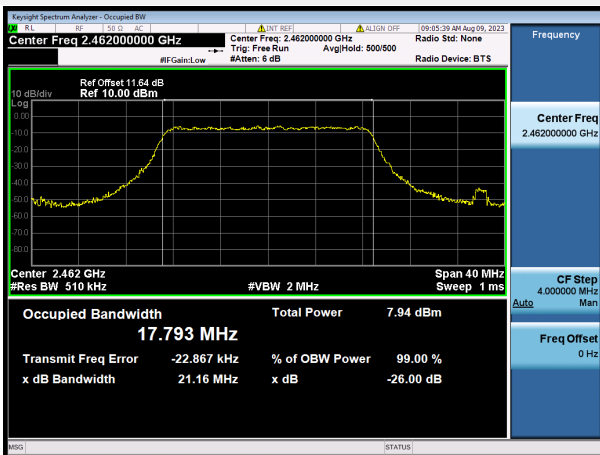

A.3 Conducted Spurious Emissions

Test Data

802.11b Mode:

Channel	Measured Max. Out of Band Emission (dBm)	Limit (dBm)		Verdict
		Carrier Level	Calculated 20 dBc Limit	
Low	-35.02	-5.67	-25.67	Pass
Middle	-35.90	-5.36	-25.36	Pass
High	-35.62	-5.53	-25.53	Pass

802.11g Mode:

Channel	Measured Max. Out of Band Emission (dBm)	Limit (dBm)		Verdict
		Carrier Level	Calculated 20 dBc Limit	
Low	-35.36	-11.01	-31.01	Pass
Middle	-35.99	-11.08	-31.08	Pass
High	-36.54	-11.04	-31.04	Pass

802.11n-20MHz Mode:

Channel	Measured Max. Out of Band Emission (dBm)	Limit (dBm)		Verdict
		Carrier Level	Calculated 20 dBc Limit	
Low	-35.09	-11.03	-31.03	Pass
Middle	-35.98	-11.14	-31.14	Pass
High	-36.06	-11.07	-31.07	Pass

Test Plots

802.11b LOW CHANNEL CARRIER LEVEL

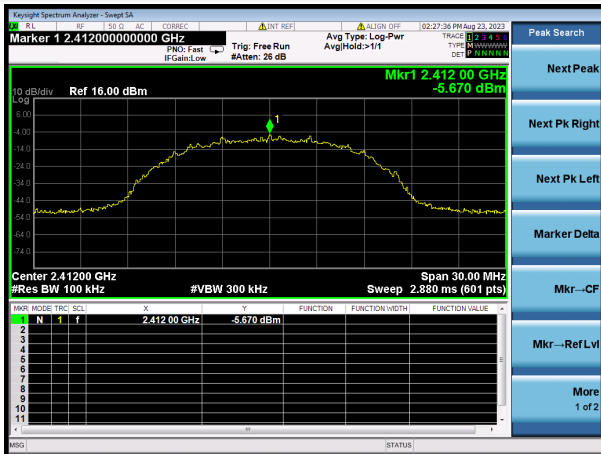

802.11b LOW CHANNEL, SPURIOUS 30 MHz ~ 3 GHz

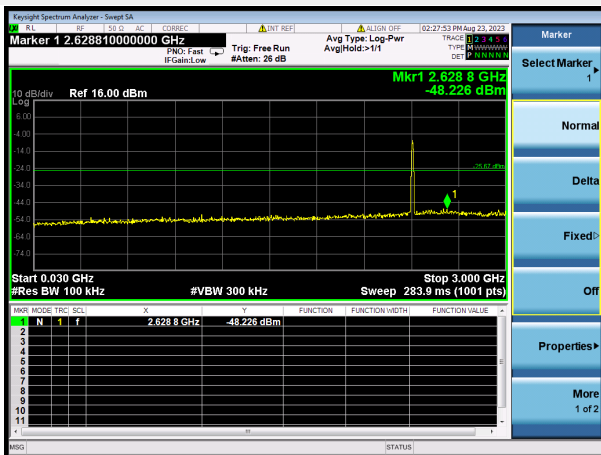

802.11b LOW CHANNEL, SPURIOUS 2 GHz ~ 25 GHz



802.11b MIDDLE CHANNEL CARRIER LEVEL

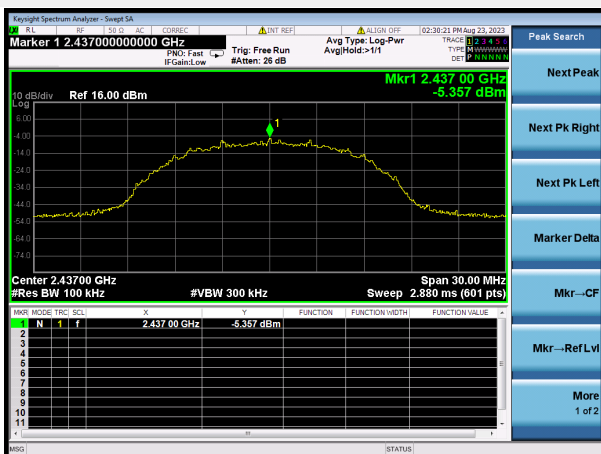

802.11b MIDDLE CHANNEL, SPURIOUS
30 MHz ~ 3 GHz

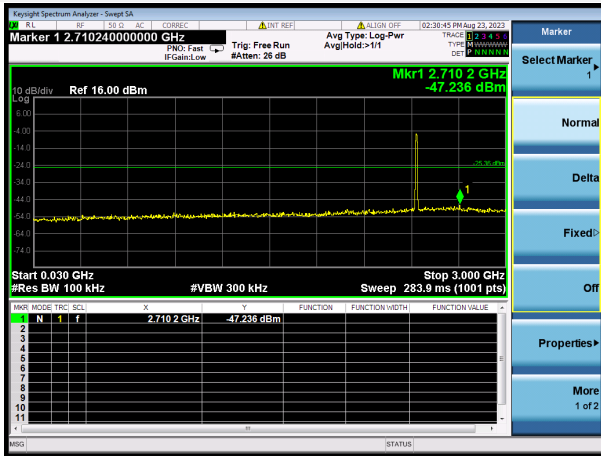

802.11b MIDDLE CHANNEL, SPURIOUS
2 GHz ~ 25 GHz

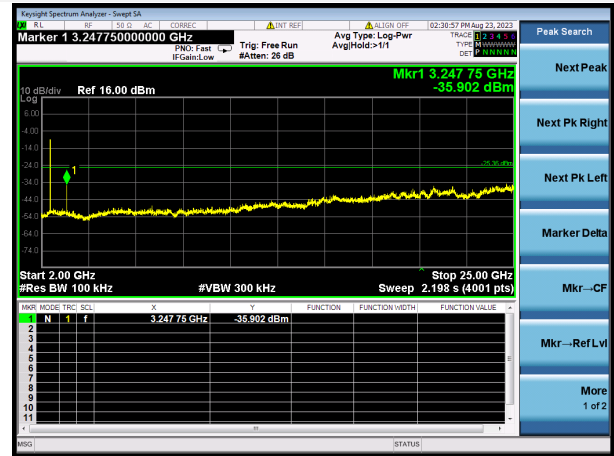

802.11b HIGH CHANNEL CARRIER LEVEL

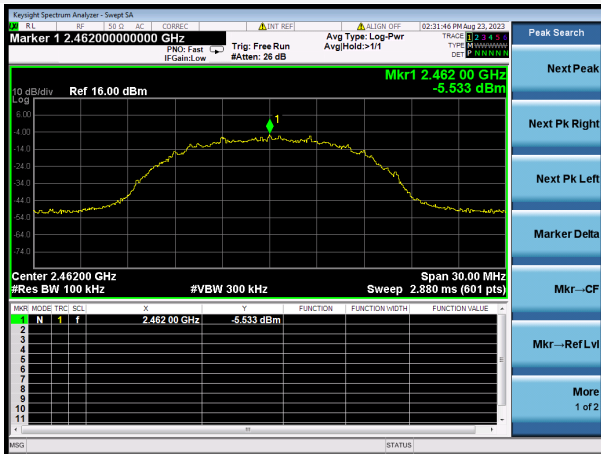

802.11b HIGH CHANNEL, SPURIOUS
30 MHz ~ 3 GHz

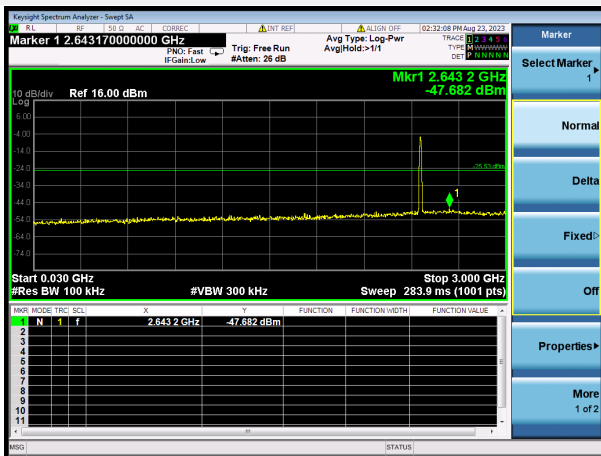

802.11b HIGH CHANNEL, SPURIOUS
2 GHz ~ 25 GHz



802.11g LOW CHANNEL CARRIER LEVEL

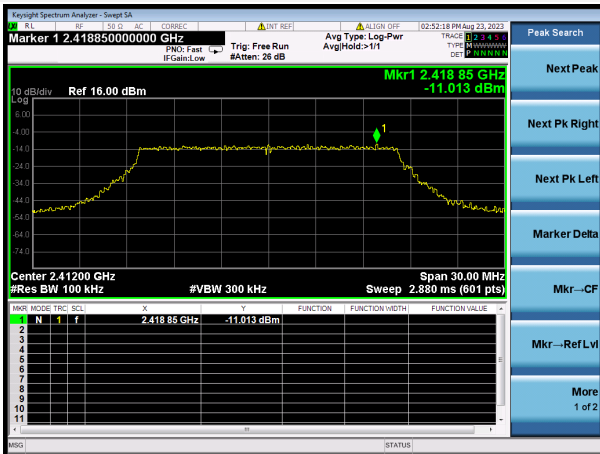

802.11g LOW CHANNEL, SPURIOUS 30 MHz ~ 3 GHz

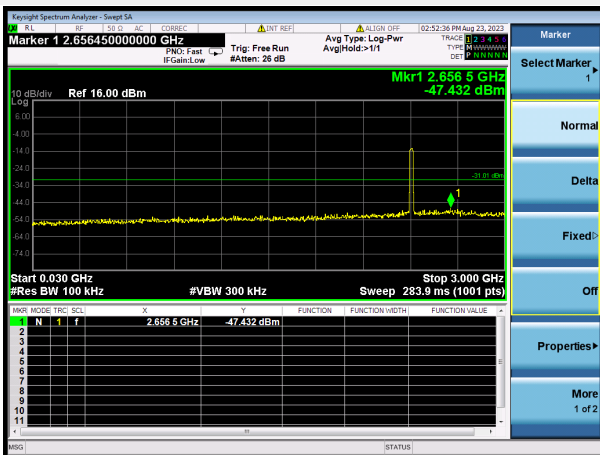

802.11g LOW CHANNEL, SPURIOUS 2 GHz ~ 25 GHz



802.11g MIDDLE CHANNEL CARRIER LEVEL

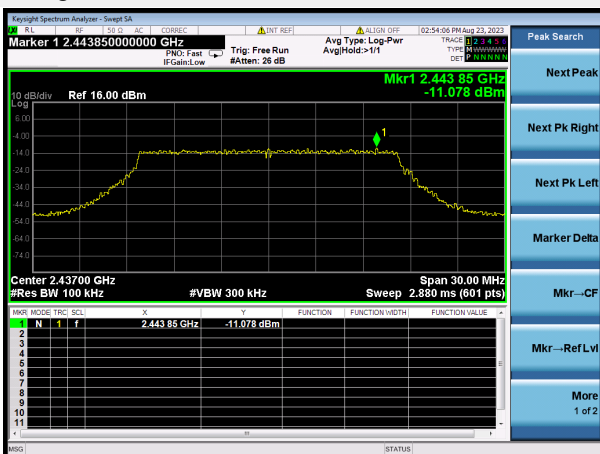

802.11g MIDDLE CHANNEL, SPURIOUS
30 MHz ~ 3 GHz

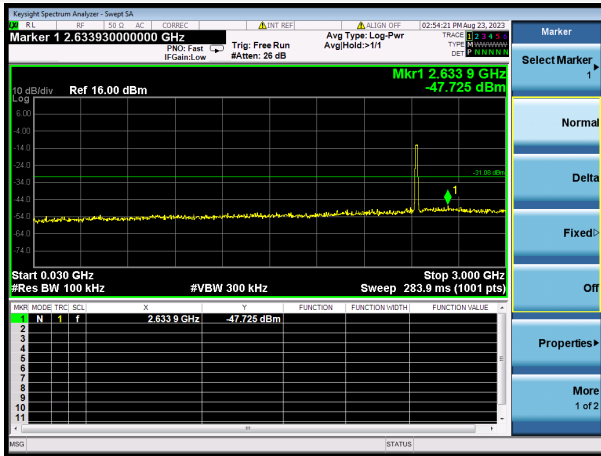

802.11g MIDDLE CHANNEL, SPURIOUS
2 GHz ~ 25 GHz

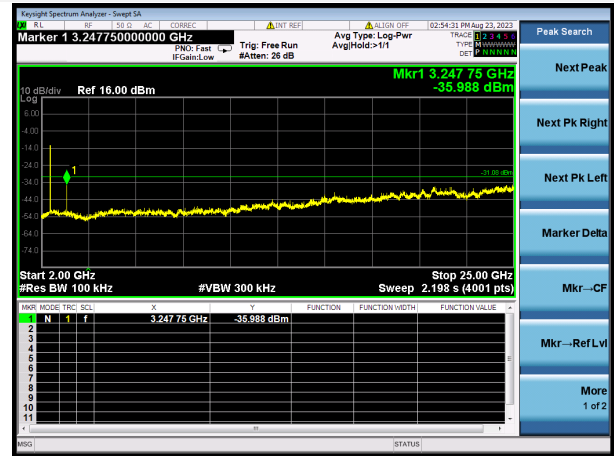

802.11g HIGH CHANNEL CARRIER LEVEL

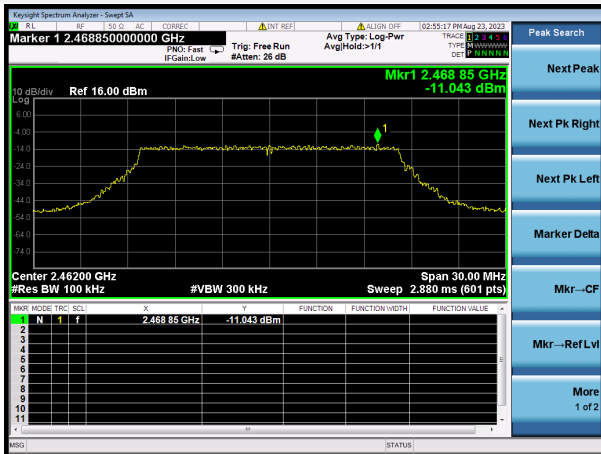

802.11g HIGH CHANNEL, SPURIOUS
30 MHz ~ 3 GHz

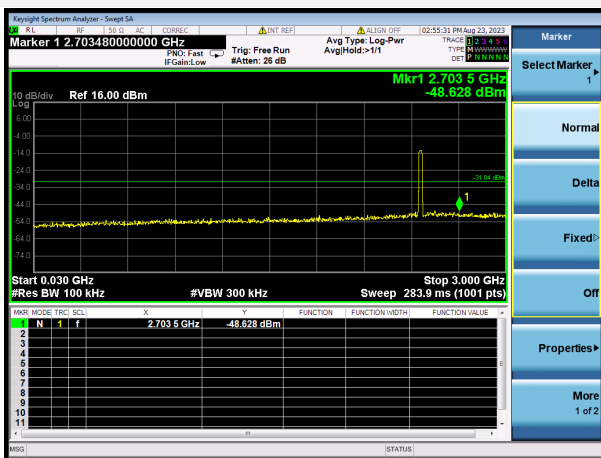

802.11g HIGH CHANNEL, SPURIOUS
2 GHz ~ 25 GHz

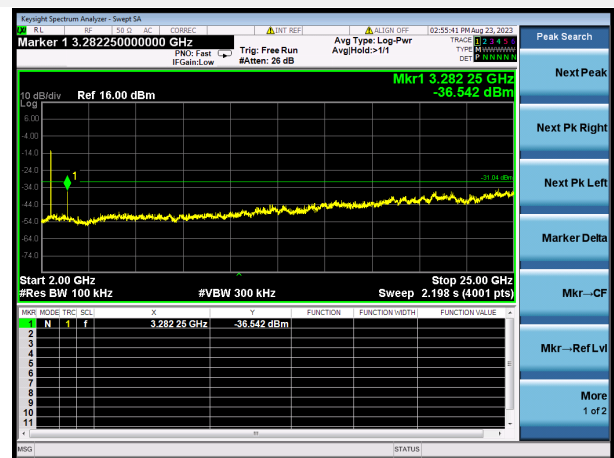

802.11n-20 MHz LOW CHANNEL CARRIER LEVEL

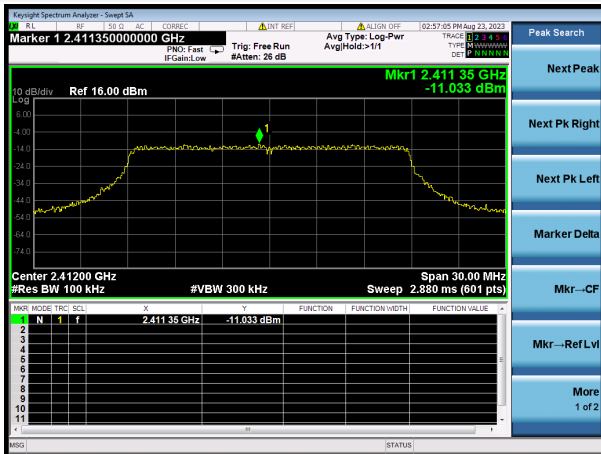

802.11n-20 MHz LOW CHANNEL, SPURIOUS
30 MHz ~ 3 GHz

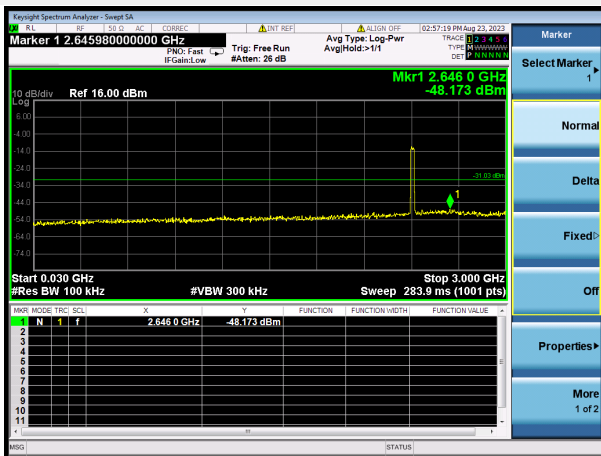

802.11n-20 MHz LOW CHANNEL, SPURIOUS
2 GHz ~ 25 GHz

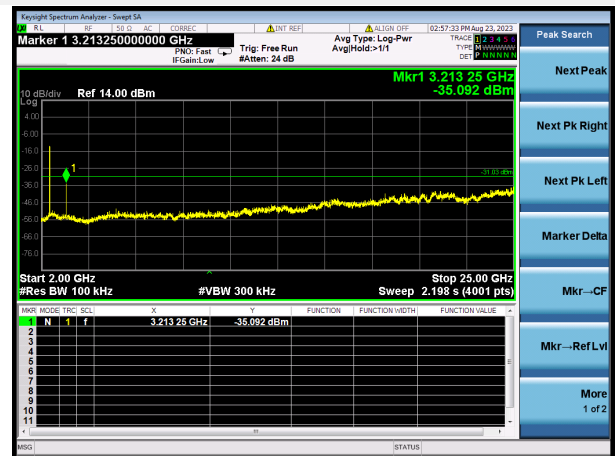

802.11n-20 MHz MIDDLE CHANNEL WIDTH CARRIER LEVEL

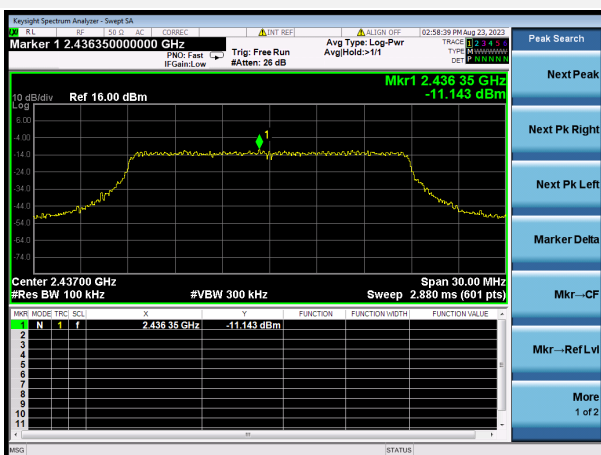

802.11n-20 MHz MIDDLE CHANNEL, SPURIOUS
30 MHz ~ 3 GHz

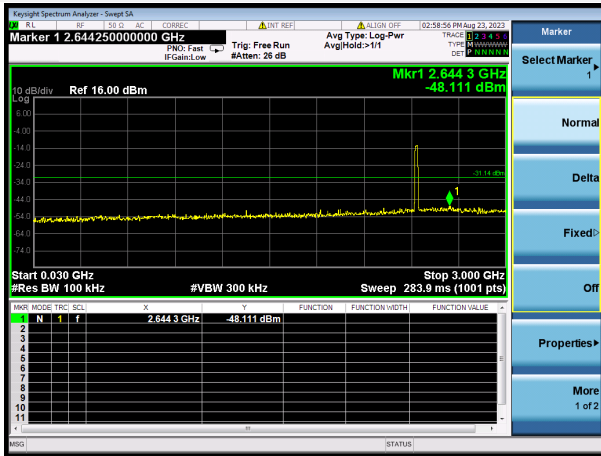

802.11n-20 MHz MIDDLE CHANNEL, SPURIOUS
2 GHz ~ 25 GHz

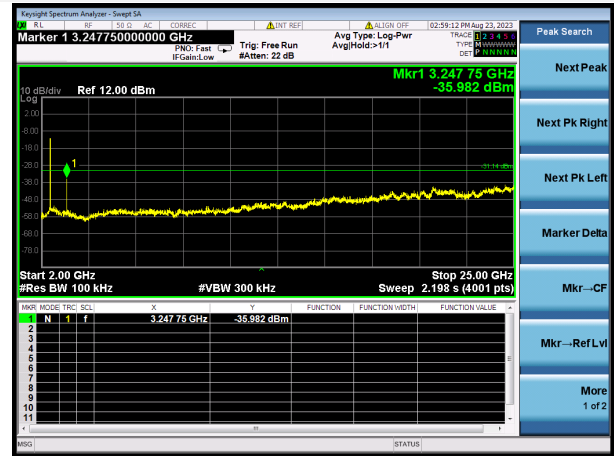

802.11n-20 MHz HIGH CHANNEL CARRIER LEVEL

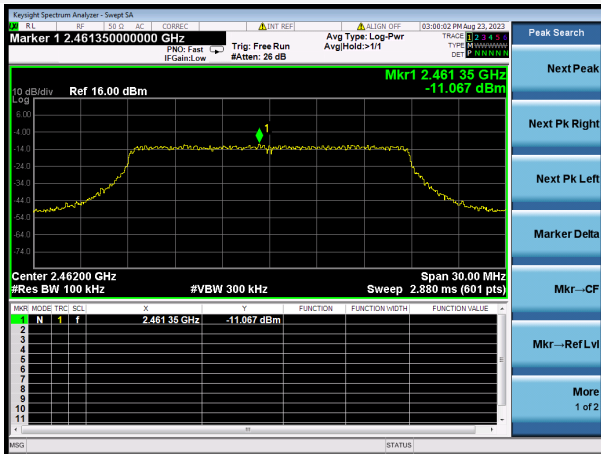

802.11n-20 MHz HIGH CHANNEL, SPURIOUS
30 MHz ~ 3 GHz

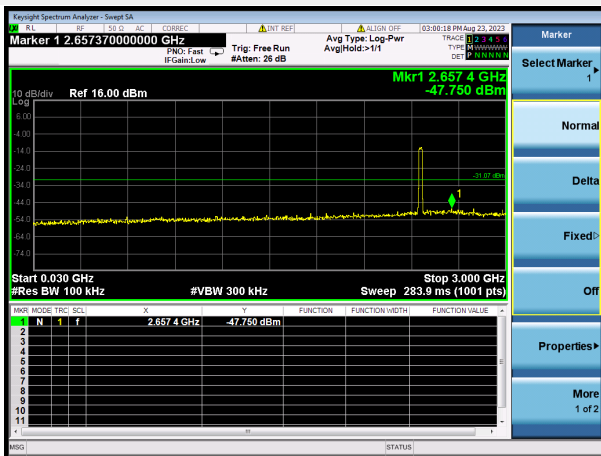

802.11n-20 MHz HIGH CHANNEL, SPURIOUS
2 GHz ~ 25 GHz

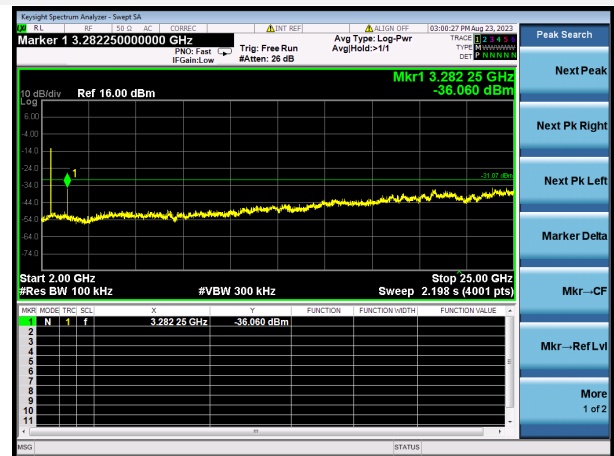

A.4 Band Edge (Authorized-band band-edge)

Note 1: The 99% OBW of the fundamental emission is without 2 MHz of the authorized band.

Note 2: All the configurations were pre tested, only the worst configuration has been reported in this report.

Test Data

802.11b Mode:

Channel	Measured Max. Band Edge Emission (dBm)	Limit (dBm)		Verdict
		Carrier Level	Calculated 20 dBc Limit	
Low Channel	-45.57	-5.67	-25.67	Pass
High Channel	-45.60	-5.53	-25.53	Pass

802.11g Mode:

Channel	Measured Max. Band Edge Emission (dBm)	Limit (dBm)		Verdict
		Carrier Level	Calculated 20 dBc Limit	
Low Channel	-43.86	-11.01	-31.01	Pass
High Channel	-44.72	-11.04	-31.04	Pass

802.11n-20 MHz Mode:

Channel	Measured Max. Band Edge Emission (dBm)	Limit (dBm)		Verdict
		Carrier Level	Calculated 20 dBc Limit	
Low Channel	-43.08	-11.03	-31.03	Pass
High Channel	-45.80	-11.07	-31.07	Pass

Test Plots

802.11b LOW CHANNEL, CARRIER LEVEL

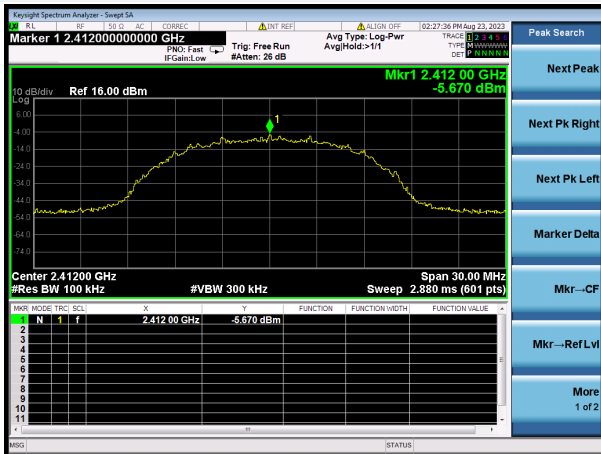

802.11b LOW CHANNEL, BAND EDGE

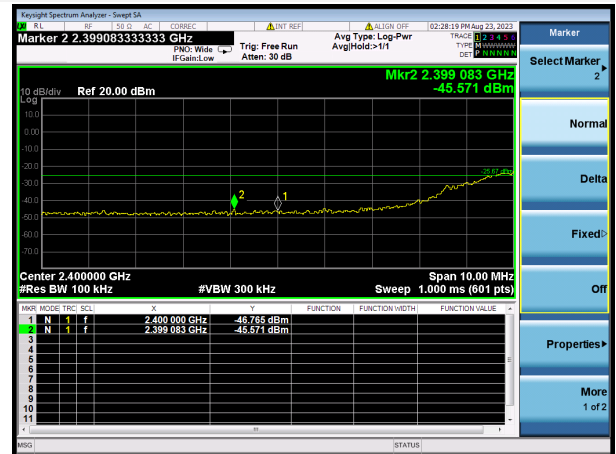

802.11b HIGH CHANNEL, CARRIER LEVEL

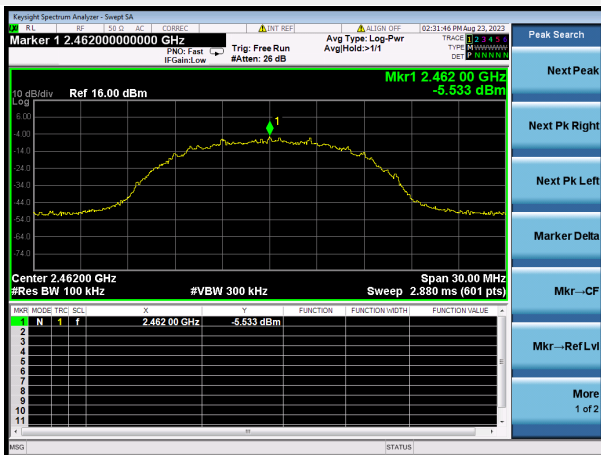

802.11b HIGH CHANNEL, BAND EDGE

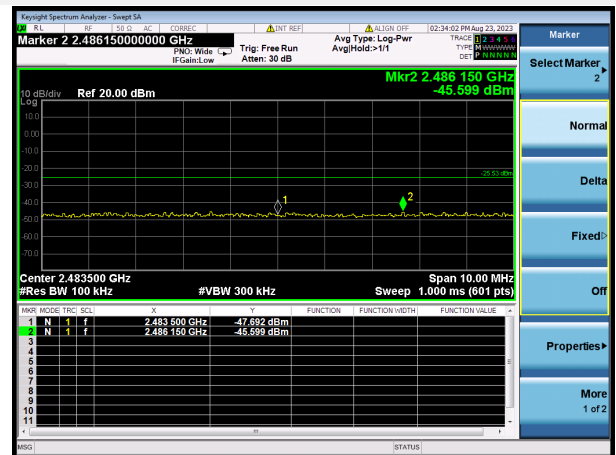

802.11g LOW CHANNEL, CARRIER LEVEL

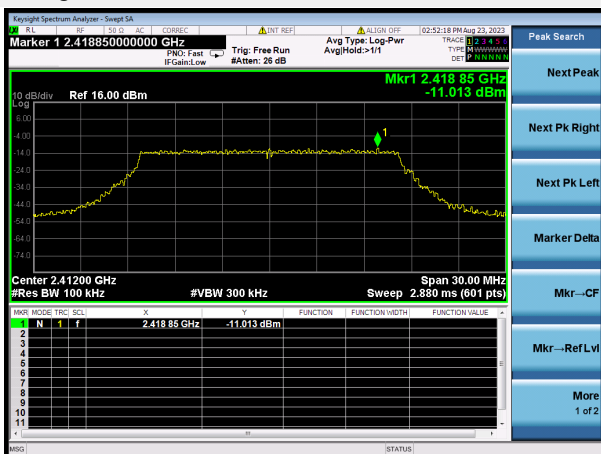

802.11g LOW CHANNEL, BAND EDGE

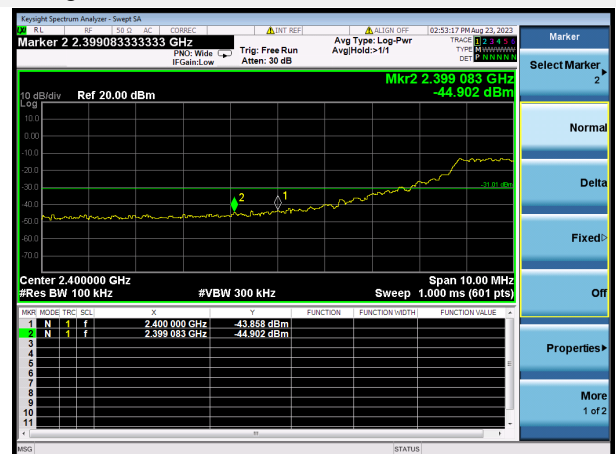

802.11g HIGH CHANNEL, CARRIER LEVEL

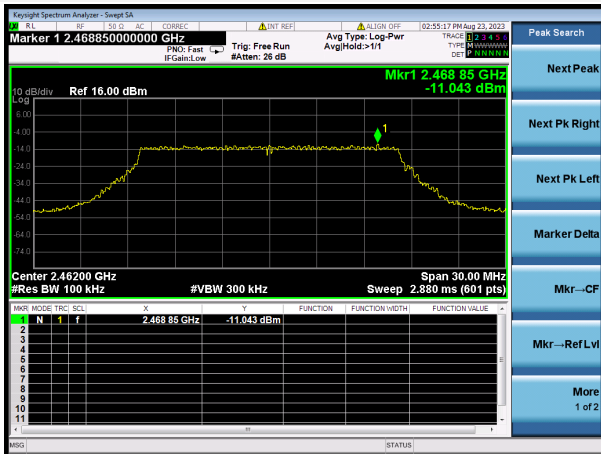

802.11g HIGH CHANNEL, BAND EDGE

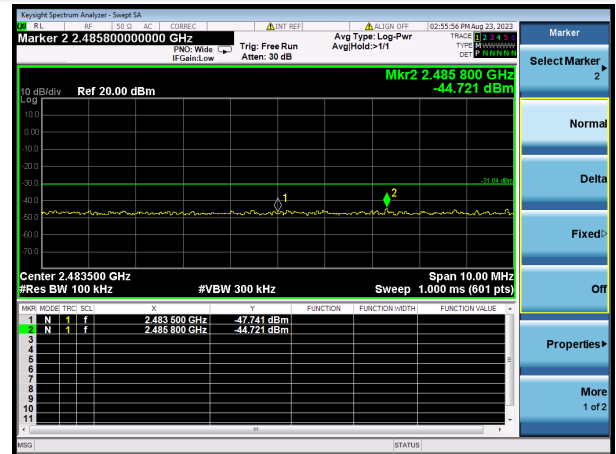

802.11n-20 MHz LOW CHANNEL, CARRIER LEVEL

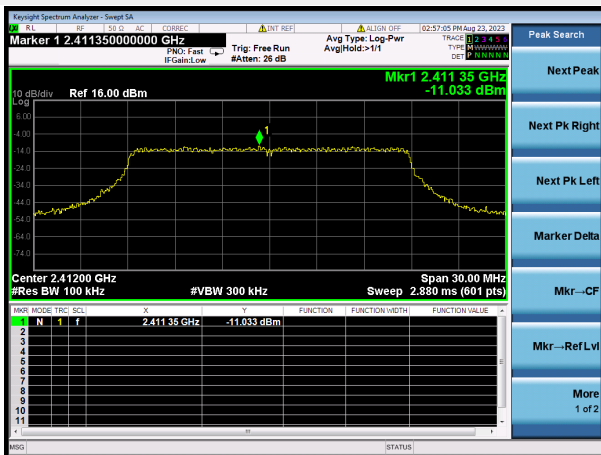

802.11n-20 MHz LOW CHANNEL, BAND EDGE

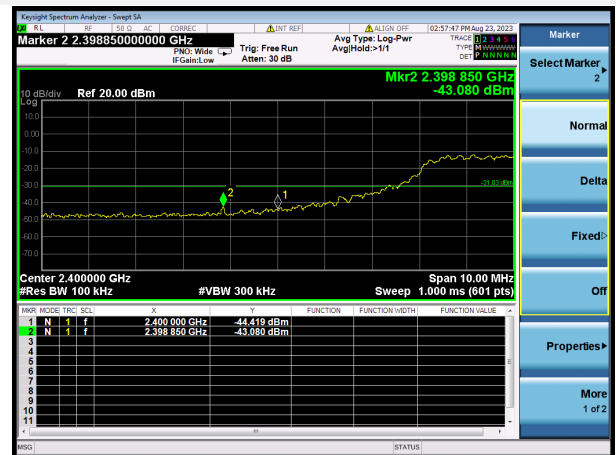

802.11n-20 MHz HIGH CHANNEL, CARRIER LEVEL

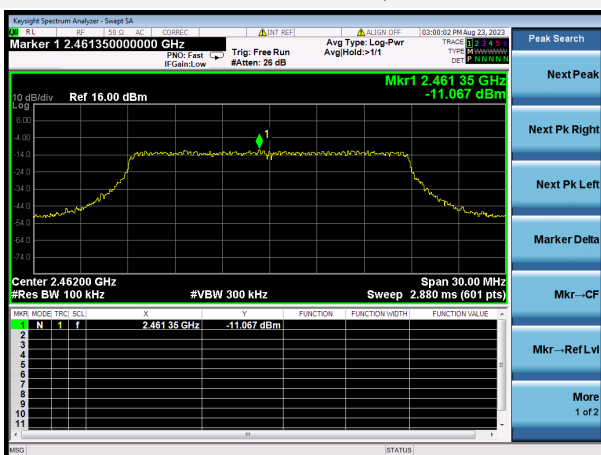

802.11n-20 MHz HIGH CHANNEL, BAND EDGE

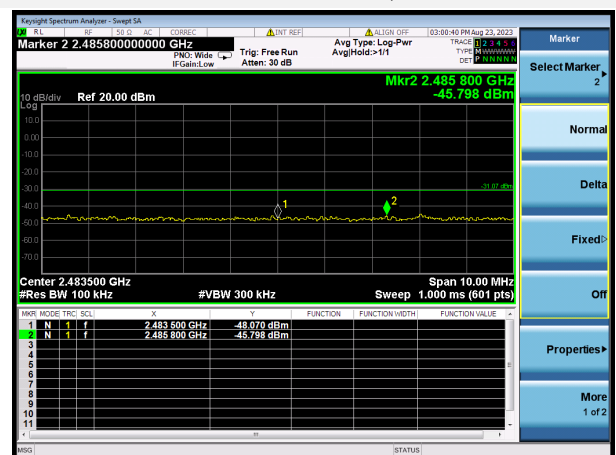

A.5 Conducted Emissions

Note ¹: The EUT is working in the Normal link mode. All modes have been tested and normal link mode is worst.

Note ²: Devices subject to Part 15 must be tested for all available U.S. voltages and frequencies (such as a nominal 120 VAC, 60 Hz and 240 VAC, 50 Hz) for which the device is capable of operation. So, The configuration 120 VAC, 60 Hz and 240 VAC, 50 Hz were tested respectively, but only the worst configuration (120 VAC, 60 Hz) shown here.

Test Data and Plots

PHASE L

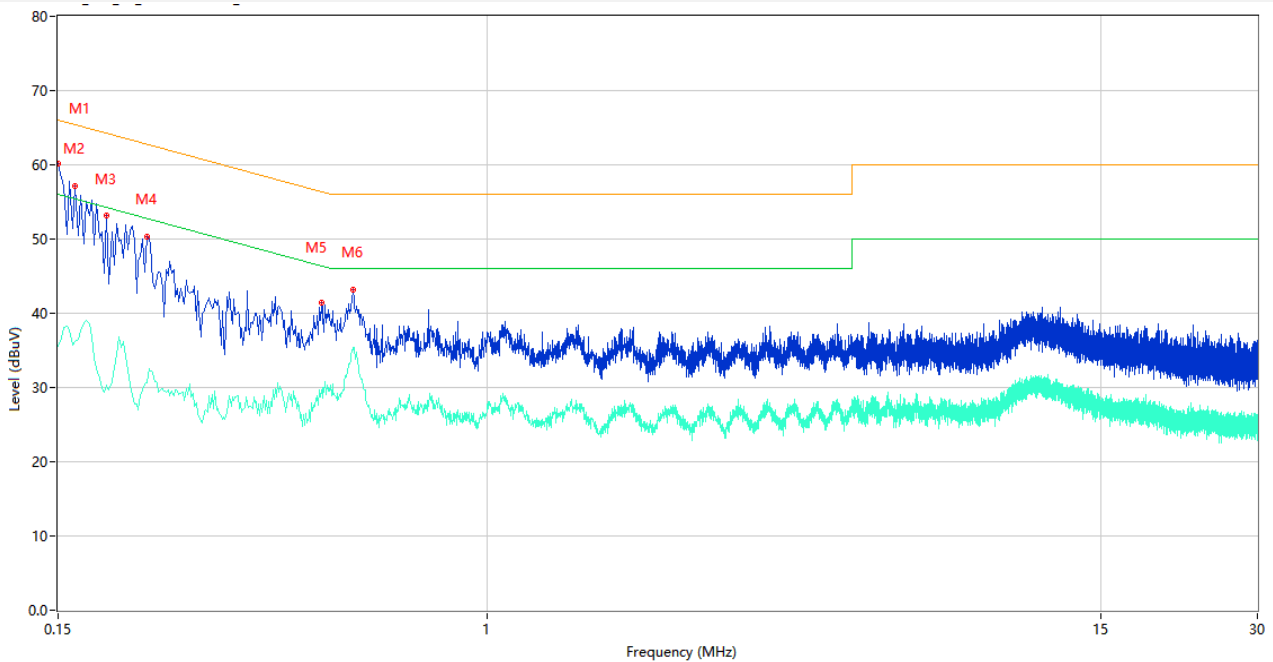

No.	Frequency (MHz)	Results (dBuV)	Factor (dB)	Limit (dBuV)	Margin (dB)	Detector	Line	Verdict
1	0.150	60.16	9.78	66.00	5.84	Peak	L	Pass
1**	0.150	35.49	9.78	56.00	20.51	AV	L	Pass
2	0.162	57.20	9.78	65.36	8.16	Peak	L	Pass
2**	0.162	36.13	9.78	55.36	19.23	AV	L	Pass
3	0.186	53.12	9.78	64.21	11.09	Peak	L	Pass
3**	0.186	30.35	9.78	54.21	23.86	AV	L	Pass
4	0.222	50.34	9.77	62.74	12.40	Peak	L	Pass
4**	0.222	30.64	9.77	52.74	22.10	AV	L	Pass
5	0.480	41.45	10.00	56.34	14.89	Peak	L	Pass
5**	0.480	29.63	10.00	46.34	16.71	AV	L	Pass
6	0.552	43.20	10.04	56.00	12.80	Peak	L	Pass
6**	0.552	35.40	10.04	46.00	10.60	AV	L	Pass

PHASE N

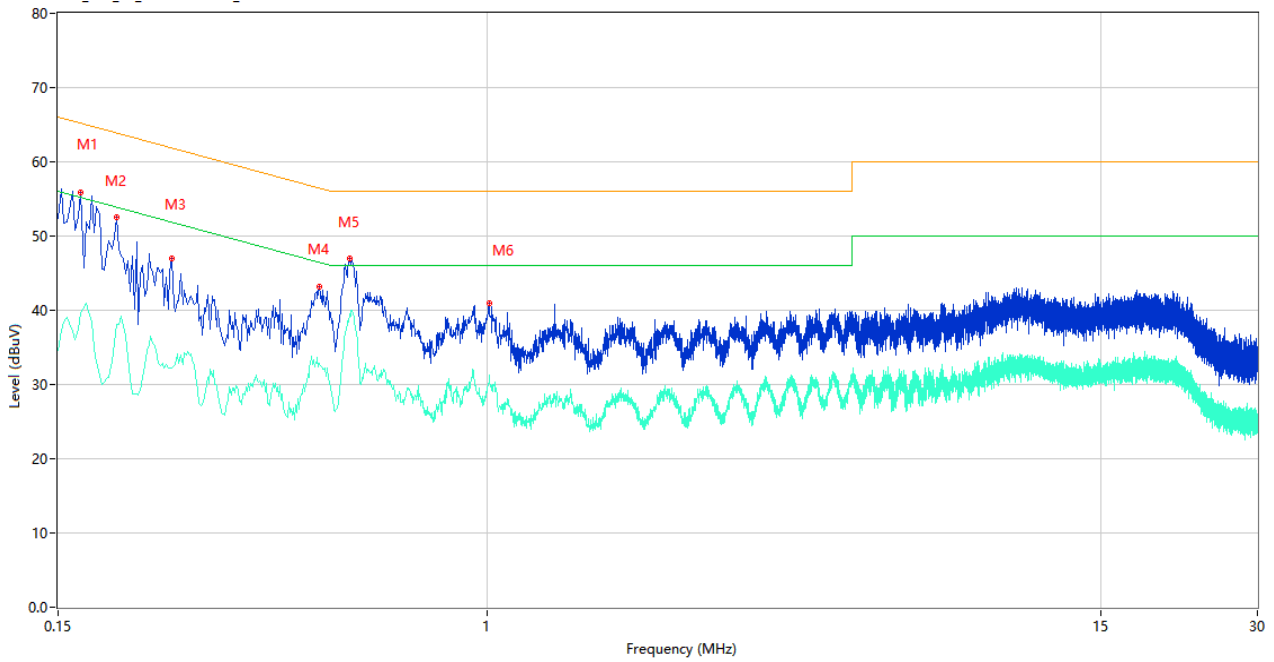

No.	Frequency (MHz)	Results (dBuV)	Factor (dB)	Limit (dBuV)	Margin (dB)	Detector	Line	Verdict
1	0.166	55.89	9.78	65.16	9.27	Peak	N	Pass
1**	0.166	39.70	9.78	55.16	15.46	AV	N	Pass
2	0.194	52.51	9.77	63.86	11.35	Peak	N	Pass
2**	0.194	38.05	9.77	53.86	15.81	AV	N	Pass
3	0.248	47.01	9.77	61.82	14.81	Peak	N	Pass
3**	0.248	32.20	9.77	51.82	19.62	AV	N	Pass
4	0.476	43.18	10.01	56.41	13.23	Peak	N	Pass
4**	0.476	32.92	10.01	46.41	13.49	AV	N	Pass
5	0.544	46.91	10.02	56.00	9.09	Peak	N	Pass
5**	0.544	39.55	10.02	46.00	6.45	AV	N	Pass
6	1.006	40.94	10.00	56.00	15.06	Peak	N	Pass
6**	1.006	30.48	10.00	46.00	15.52	AV	N	Pass

A.6 Radiated Emission

Note 1: The symbol of "--" in the table which means not application.

Note 2: For the test data above 1 GHz, According the ANSI C63.10-2013, where limits are specified for both average and peak (or quasi-peak) detector functions, if the peak (or quasi-peak) measured value complies with the average limit, it is unnecessary to perform an average measurement.

Note 3: The low frequency, which started from 9 kHz to 30 MHz, was pre-scanned and the result which was 20 dB lower than the limit line per 15.31(o) was not reported.

Note 4: The EUT is working in the Normal link mode below 1 GHz. All modes have been tested and normal link mode is worst.

Test Data and Plots

30 MHz to 1 GHz, ANT H

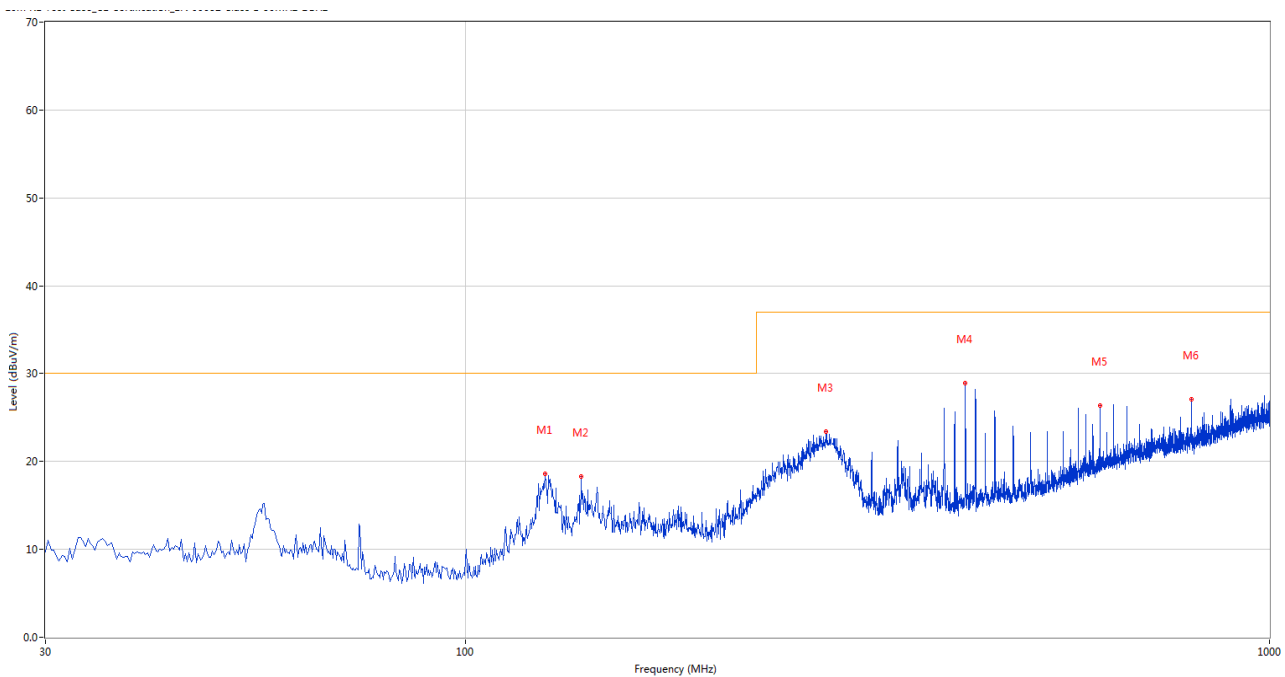

No.	Frequency (MHz)	Results (dBuV/m)	Factor (dB)	Limit (dBuV/m)	Margin (dB)	Detector	Table (Degree)	Height (cm)	Antenna	Verdict
1	125.521	18.62	-27.36	30.0	11.38	Peak	163.00	100	Horizontal	Pass
2	139.340	18.25	-26.39	30.0	11.75	Peak	0.00	200	Horizontal	Pass
3	280.682	23.42	-26.29	37.0	13.58	Peak	130.00	200	Horizontal	Pass
4	418.388	28.89	-22.37	37.0	8.11	Peak	109.00	200	Horizontal	Pass
5	615.249	26.33	-17.66	37.0	10.67	Peak	321.00	100	Horizontal	Pass
6	799.988	27.11	-13.84	37.0	9.89	Peak	138.00	100	Horizontal	Pass

30 MHz to 1 GHz, ANT V

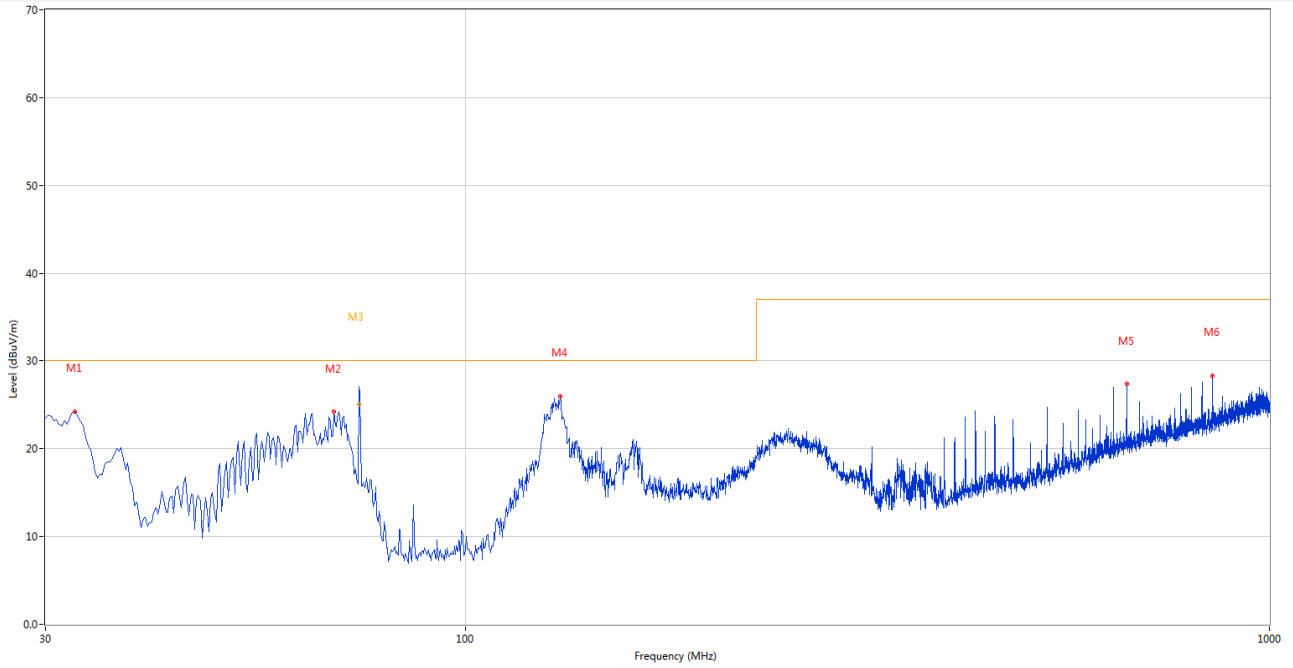

No.	Frequency (MHz)	Results (dBuV/m)	Factor (dB)	Limit (dBuV/m)	Margin (dB)	Detector	Table (Degree)	Height (cm)	Antenna	Verdict
1	32.667	24.25	-27.17	30.0	5.75	Peak	134.00	100	Vertical	Pass
2	68.548	24.24	-29.17	30.0	5.76	Peak	13.00	200	Vertical	Pass
3	73.639	27.10	-30.03	30.0	2.90	Peak	322.00	200	Vertical	N/A
3*	73.639	25.07	-30.03	30.0	4.93	QP	322.00	200	Vertical	Pass
4	131.097	25.96	-27.19	30.0	4.04	Peak	4.00	100	Vertical	Pass
5	664.464	27.34	-16.38	37.0	9.66	Peak	236.00	200	Vertical	Pass
6	848.718	28.34	-13.12	37.0	8.66	Peak	155.00	200	Vertical	Pass

Note 1: The marked spikes near 2400 MHz with circle should be ignored because they are Fundamental signal.

Note 2: The spurious above 18G is noise only, do not show on the report.

1 GHz to 18 GHz, ANT H 802.11b Low Channel

No.	Frequency (MHz)	Results (dBuV/m)	Factor (dB)	Limit (dBuV/m)	Over Limit (dB)	Detector	Table (Degree)	Height (cm)	Antenna	Verdict
1	1166.500	40.09	-18.06	74.0	33.91	Peak	126.00	400	Horizontal	Pass
1**	1166.500	28.14	-18.06	54.0	25.86	AV	126.00	400	Horizontal	Pass
2	2413.500	96.88	-12.52	74.0	-22.88	Peak	239.00	200	Horizontal	N/A
2**	2413.500	89.54	-12.52	54.0	-35.54	AV	239.00	200	Horizontal	N/A
3	3216.200	51.45	-7.30	74.0	22.55	Peak	222.00	150	Horizontal	Pass
3**	3216.200	50.21	-7.30	54.0	3.79	AV	222.00	150	Horizontal	N/A
4	4824.200	54.22	-3.42	74.0	19.78	Peak	31.00	150	Horizontal	Pass
4**	4824.200	47.22	-3.42	54.0	6.78	AV	31.00	150	Horizontal	Pass
5	12872.849	53.42	1.47	74.0	20.58	Peak	239.00	400	Horizontal	Pass
5**	12872.849	44.09	1.47	54.0	9.91	AV	239.00	400	Horizontal	Pass
6	17416.200	56.12	3.67	74.0	17.88	Peak	97.00	100	Horizontal	Pass
6**	17416.200	48.19	3.67	54.0	5.81	AV	97.00	100	Horizontal	Pass

1 GHz to 18 GHz, ANT V 802.11b Low Channel

No.	Frequency (MHz)	Results (dBuV/m)	Factor (dB)	Limit (dBuV/m)	Over Limit (dB)	Detector	Table (Degree)	Height (cm)	Antenna	Verdict
1	1164.000	47.54	-17.97	74.0	26.46	Peak	35.00	100	Vertical	Pass
1**	1164.000	33.37	-17.97	54.0	20.63	AV	35.00	100	Vertical	Pass
2	2411.800	96.25	-12.53	74.0	-22.25	Peak	304.00	100	Vertical	N/A
2**	2411.800	89.49	-12.53	54.0	-35.49	AV	304.00	100	Vertical	N/A
3	3216.200	53.59	-7.30	74.0	20.41	Peak	127.00	150	Vertical	Pass
3**	3216.200	52.23	-7.30	54.0	1.77	AV	127.00	150	Vertical	N/A
4	4823.200	56.12	-3.37	74.0	17.88	Peak	116.00	150	Vertical	Pass
4**	4823.200	50.38	-3.37	54.0	3.62	AV	116.00	150	Vertical	Pass
5	12990.451	53.24	1.13	74.0	20.76	Peak	112.00	300	Vertical	Pass
5**	12990.451	43.78	1.13	54.0	10.22	AV	112.00	300	Vertical	Pass
6	17394.412	55.89	2.99	74.0	18.11	Peak	0.00	150	Vertical	Pass
6**	17394.412	46.21	2.99	54.0	7.79	AV	0.00	150	Vertical	Pass

1 GHz to 18 GHz, ANT H 802.11b Middle Channel

No.	Frequency (MHz)	Results (dBuV/m)	Factor (dB)	Limit (dBuV/m)	Over Limit (dB)	Detector	Table (Degree)	Height (cm)	Antenna	Verdict
1	1332.100	40.49	-17.51	74.0	33.51	Peak	360.00	200	Horizontal	Pass
1**	1332.100	30.41	-17.51	54.0	23.59	AV	360.00	200	Horizontal	Pass
2	2436.500	96.98	-12.50	74.0	-22.98	Peak	241.00	200	Horizontal	N/A
2**	2436.500	90.30	-12.50	54.0	-36.30	AV	241.00	200	Horizontal	N/A
3	3249.400	50.97	-8.71	74.0	23.03	Peak	246.00	150	Horizontal	Pass
3**	3249.400	49.37	-8.71	54.0	4.63	AV	246.00	150	Horizontal	N/A
4	4875.000	52.06	-3.26	74.0	21.94	Peak	331.00	150	Horizontal	Pass
4**	4875.000	46.84	-3.26	54.0	7.16	AV	331.00	150	Horizontal	Pass
5	12768.900	53.09	1.05	74.0	20.91	Peak	343.00	400	Horizontal	Pass
5**	12768.900	43.56	1.05	54.0	10.44	AV	343.00	400	Horizontal	Pass
6	17413.839	56.24	3.59	74.0	17.76	Peak	115.00	200	Horizontal	Pass
6**	17413.839	47.87	3.59	54.0	6.13	AV	115.00	200	Horizontal	Pass

1 GHz to 18 GHz, ANT V 802.11b Middle Channel

No.	Frequency (MHz)	Results (dBuV/m)	Factor (dB)	Limit (dBuV/m)	Over Limit (dB)	Detector	Table (Degree)	Height (cm)	Antenna	Verdict
1	1166.300	47.43	-18.06	74.0	26.57	Peak	80.00	100	Vertical	Pass
1**	1166.300	30.02	-18.06	54.0	23.98	AV	80.00	100	Vertical	Pass
2	2436.500	96.21	-12.50	74.0	-22.21	Peak	329.00	150	Vertical	N/A
2**	2436.500	90.20	-12.50	54.0	-36.20	AV	329.00	150	Vertical	N/A
3	3249.600	52.91	-8.72	74.0	21.09	Peak	74.00	150	Vertical	Pass
3**	3249.600	51.57	-8.72	54.0	2.43	AV	74.00	150	Vertical	N/A
4	4874.600	55.34	-3.26	74.0	18.66	Peak	182.00	150	Vertical	Pass
4**	4874.600	50.74	-3.26	54.0	3.26	AV	182.00	150	Vertical	Pass
5	12311.850	54.04	1.38	74.0	19.96	Peak	97.00	200	Vertical	Pass
5**	12311.850	43.91	1.38	54.0	10.09	AV	97.00	200	Vertical	Pass
6	17414.363	56.55	3.61	74.0	17.45	Peak	76.00	200	Vertical	Pass
6**	17414.363	47.28	3.61	54.0	6.72	AV	76.00	200	Vertical	Pass

1 GHz to 18 GHz, ANT H 802.11b High Channel

No.	Frequency (MHz)	Results (dBuV/m)	Factor (dB)	Limit (dBuV/m)	Over Limit (dB)	Detector	Table (Degree)	Height (cm)	Antenna	Verdict
1	1333.000	41.38	-17.51	74.0	32.62	Peak	3.00	100	Horizontal	Pass
1**	1333.000	31.69	-17.51	54.0	22.31	AV	3.00	100	Horizontal	Pass
2	2461.400	95.93	-12.53	74.0	-21.93	Peak	241.00	150	Horizontal	N/A
2**	2461.400	89.86	-12.53	54.0	-35.86	AV	241.00	150	Horizontal	N/A
3	3283.000	50.45	-8.21	74.0	23.55	Peak	74.00	150	Horizontal	Pass
3**	3283.000	49.87	-8.21	54.0	4.13	AV	74.00	150	Horizontal	N/A
4	4924.600	53.39	-2.35	74.0	20.61	Peak	331.00	150	Horizontal	Pass
4**	4924.600	46.93	-2.35	54.0	7.07	AV	331.00	150	Horizontal	Pass
5	12890.174	53.27	1.59	74.0	20.73	Peak	324.00	300	Horizontal	Pass
5**	12890.174	44.38	1.59	54.0	9.62	AV	324.00	300	Horizontal	Pass
6	17401.762	56.68	3.23	74.0	17.32	Peak	284.00	400	Horizontal	Pass
6**	17401.762	47.10	3.23	54.0	6.90	AV	284.00	400	Horizontal	Pass

1 GHz to 18 GHz, ANT V 802.11b High Channel

No.	Frequency (MHz)	Results (dBuV/m)	Factor (dB)	Limit (dBuV/m)	Over Limit (dB)	Detector	Table (Degree)	Height (cm)	Antenna	Verdict
1	1166.400	46.28	-18.06	74.0	27.72	Peak	74.00	300	Vertical	Pass
1**	1166.400	32.51	-18.06	54.0	21.49	AV	74.00	300	Vertical	Pass
2	2461.700	95.74	-12.53	74.0	-21.74	Peak	301.00	100	Vertical	N/A
2**	2461.700	89.64	-12.53	54.0	-35.64	AV	301.00	100	Vertical	N/A
3	3282.800	53.15	-8.24	74.0	20.85	Peak	191.00	150	Vertical	Pass
3**	3282.800	51.70	-8.24	54.0	2.30	AV	191.00	150	Vertical	N/A
4	4924.800	54.91	-2.36	74.0	19.09	Peak	10.00	150	Vertical	Pass
4**	4924.800	50.49	-2.36	54.0	3.51	AV	10.00	150	Vertical	Pass
5	12826.387	53.30	1.06	74.0	20.70	Peak	228.00	200	Vertical	Pass
5**	12826.387	43.49	1.06	54.0	10.51	AV	228.00	200	Vertical	Pass
6	17175.489	56.04	0.52	74.0	17.96	Peak	306.00	200	Vertical	Pass
6**	17175.489	45.65	0.52	54.0	8.35	AV	306.00	200	Vertical	Pass

1 GHz to 18 GHz, ANT H 802.11g Low Channel

No.	Frequency (MHz)	Results (dBuV/m)	Factor (dB)	Limit (dBuV/m)	Over Limit (dB)	Detector	Table (Degree)	Height (cm)	Antenna	Verdict
1	1557.300	39.42	-17.36	74.0	34.58	Peak	213.00	400	Horizontal	Pass
1**	1557.300	29.62	-17.36	54.0	24.38	AV	213.00	400	Horizontal	Pass
2	2406.400	95.50	-12.38	74.0	-21.50	Peak	236.00	150	Horizontal	N/A
2**	2406.400	87.70	-12.38	54.0	-33.70	AV	236.00	150	Horizontal	N/A
3	3216.200	51.30	-7.30	74.0	22.70	Peak	248.00	150	Horizontal	Pass
3**	3216.200	50.04	-7.30	54.0	3.96	AV	248.00	150	Horizontal	N/A
4	4825.600	49.90	-3.48	74.0	24.10	Peak	159.00	150	Horizontal	Pass
4**	4825.600	45.91	-3.48	54.0	8.09	AV	159.00	150	Horizontal	Pass
5	12281.088	52.92	1.80	74.0	21.08	Peak	0.00	300	Horizontal	Pass
5**	12281.088	44.80	1.80	54.0	9.20	AV	0.00	300	Horizontal	Pass
6	15248.474	56.22	0.81	74.0	17.78	Peak	285.00	300	Horizontal	Pass
6**	15248.474	46.98	0.81	54.0	7.02	AV	285.00	300	Horizontal	Pass

1 GHz to 18 GHz, ANT V 802.11g Low Channel

No.	Frequency (MHz)	Results (dBuV/m)	Factor (dB)	Limit (dBuV/m)	Over Limit (dB)	Detector	Table (Degree)	Height (cm)	Antenna	Verdict
1	1165.000	47.14	-18.01	74.0	26.86	Peak	49.00	100	Vertical	Pass
1**	1165.000	34.74	-18.01	54.0	19.26	AV	49.00	100	Vertical	Pass
2	2404.300	94.93	-12.25	74.0	-20.93	Peak	288.00	150	Vertical	N/A
2**	2404.300	86.37	-12.25	54.0	-32.37	AV	288.00	150	Vertical	N/A
3	3216.200	53.90	-7.30	74.0	20.10	Peak	179.00	150	Vertical	Pass
3**	3216.200	52.47	-7.30	54.0	1.53	AV	179.00	150	Vertical	N/A
4	4824.400	55.07	-3.43	74.0	18.93	Peak	352.00	150	Vertical	Pass
4**	4824.400	50.26	-3.43	54.0	3.74	AV	352.00	150	Vertical	Pass
5	12797.776	53.84	1.12	74.0	20.16	Peak	190.00	300	Vertical	Pass
5**	12797.776	44.20	1.12	54.0	9.80	AV	190.00	300	Vertical	Pass
6	17448.489	55.76	2.84	74.0	18.24	Peak	0.00	300	Vertical	Pass
6**	17448.489	46.86	2.84	54.0	7.14	AV	0.00	300	Vertical	Pass

1 GHz to 18 GHz, ANT H 802.11g Middle Channel

No.	Frequency (MHz)	Results (dBuV/m)	Factor (dB)	Limit (dBuV/m)	Over Limit (dB)	Detector	Table (Degree)	Height (cm)	Antenna	Verdict
1	1330.600	40.11	-17.48	74.0	33.89	Peak	0.00	200	Horizontal	Pass
1**	1330.600	30.87	-17.48	54.0	23.13	AV	0.00	200	Horizontal	Pass
2	2439.300	94.28	-12.41	74.0	-20.28	Peak	241.00	150	Horizontal	N/A
2**	2439.300	86.70	-12.41	54.0	-32.70	AV	241.00	150	Horizontal	N/A
3	3249.600	50.45	-8.72	74.0	23.55	Peak	82.00	150	Horizontal	Pass
3**	3249.600	49.34	-8.72	54.0	4.66	AV	82.00	150	Horizontal	N/A
4	4876.400	50.58	-3.42	74.0	23.42	Peak	360.00	150	Horizontal	Pass
4**	4876.400	45.31	-3.42	54.0	8.69	AV	360.00	150	Horizontal	Pass
5	12840.300	54.50	1.33	74.0	19.50	Peak	73.00	200	Horizontal	Pass
5**	12840.300	43.82	1.33	54.0	10.18	AV	73.00	200	Horizontal	Pass
6	17342.437	55.76	1.61	74.0	18.24	Peak	343.00	200	Horizontal	Pass
6**	17342.437	45.80	1.61	54.0	8.20	AV	343.00	200	Horizontal	Pass

1 GHz to 18 GHz, ANT V 802.11g Middle Channel

No.	Frequency (MHz)	Results (dBuV/m)	Factor (dB)	Limit (dBuV/m)	Over Limit (dB)	Detector	Table (Degree)	Height (cm)	Antenna	Verdict
1	1161.400	46.94	-17.98	74.0	27.06	Peak	32.00	200	Vertical	Pass
1**	1161.400	33.11	-17.98	54.0	20.89	AV	32.00	200	Vertical	Pass
2	2438.100	93.89	-12.45	74.0	-19.89	Peak	319.00	200	Vertical	N/A
2**	2438.100	86.30	-12.45	54.0	-32.30	AV	319.00	200	Vertical	N/A
3	3249.600	52.45	-8.72	74.0	21.55	Peak	70.00	150	Vertical	Pass
3**	3249.600	51.80	-8.72	54.0	2.20	AV	70.00	150	Vertical	N/A
4	4875.000	56.42	-3.26	74.0	17.58	Peak	360.00	150	Vertical	Pass
4**	4875.000	49.49	-3.26	54.0	4.51	AV	360.00	150	Vertical	Pass
5	12999.638	54.17	1.38	74.0	19.83	Peak	74.00	100	Vertical	Pass
5**	12999.638	43.88	1.38	54.0	10.12	AV	74.00	100	Vertical	Pass
6	17352.411	55.58	1.99	74.0	18.42	Peak	74.00	400	Vertical	Pass
6**	17352.411	46.31	1.99	54.0	7.69	AV	74.00	400	Vertical	Pass

1 GHz to 18 GHz, ANT H 802.11g High Channel

No.	Frequency (MHz)	Results (dBuV/m)	Factor (dB)	Limit (dBuV/m)	Over Limit (dB)	Detector	Table (Degree)	Height (cm)	Antenna	Verdict
1	1329.600	41.12	-17.57	74.0	32.88	Peak	0.00	200	Horizontal	Pass
1**	1329.600	29.09	-17.57	54.0	24.91	AV	0.00	200	Horizontal	Pass
2	2462.700	92.99	-12.51	74.0	-18.99	Peak	261.00	200	Horizontal	N/A
2**	2462.700	85.38	-12.51	54.0	-31.38	AV	261.00	200	Horizontal	N/A
3	3282.800	50.73	-8.24	74.0	23.27	Peak	87.00	150	Horizontal	Pass
3**	3282.800	49.47	-8.24	54.0	4.53	AV	87.00	150	Horizontal	N/A
4	4923.800	50.22	-2.34	74.0	23.78	Peak	17.00	150	Horizontal	Pass
4**	4923.800	45.36	-2.34	54.0	8.64	AV	17.00	150	Horizontal	Pass
5	12783.600	53.38	1.24	74.0	20.62	Peak	270.00	200	Horizontal	Pass
5**	12783.600	44.80	1.24	54.0	9.20	AV	270.00	200	Horizontal	Pass
6	17408.588	56.11	3.41	74.0	17.89	Peak	252.00	400	Horizontal	Pass
6**	17408.588	47.43	3.41	54.0	6.57	AV	252.00	400	Horizontal	Pass

1 GHz to 18 GHz, ANT V 802.11g High Channel

No.	Frequency (MHz)	Results (dBuV/m)	Factor (dB)	Limit (dBuV/m)	Over Limit (dB)	Detector	Table (Degree)	Height (cm)	Antenna	Verdict
1	1165.900	47.17	-18.04	74.0	26.83	Peak	0.00	200	Vertical	Pass
1**	1165.900	33.53	-18.04	54.0	20.47	AV	0.00	200	Vertical	Pass
2	2462.900	92.79	-12.51	74.0	-18.79	Peak	342.00	100	Vertical	N/A
2**	2462.900	85.49	-12.51	54.0	-31.49	AV	342.00	100	Vertical	N/A
3	3282.800	53.23	-8.24	74.0	20.77	Peak	203.00	150	Vertical	Pass
3**	3282.800	51.59	-8.24	54.0	2.41	AV	203.00	150	Vertical	N/A
4	4924.600	53.39	-2.35	74.0	20.61	Peak	353.00	150	Vertical	Pass
4**	4924.600	49.08	-2.35	54.0	4.92	AV	353.00	150	Vertical	Pass
5	12821.925	53.57	0.96	74.0	20.43	Peak	82.00	200	Vertical	Pass
5**	12821.925	44.04	0.96	54.0	9.96	AV	82.00	200	Vertical	Pass
6	15231.150	56.29	0.92	74.0	17.71	Peak	118.00	300	Vertical	Pass
6**	15231.150	48.01	0.92	54.0	5.99	AV	118.00	300	Vertical	Pass

1 GHz to 18 GHz, ANT H 802.11n20 Low Channel

No.	Frequency (MHz)	Results (dBuV/m)	Factor (dB)	Limit (dBuV/m)	Over Limit (dB)	Detector	Table (Degree)	Height (cm)	Antenna	Verdict
1	1332.100	40.73	-17.51	74.0	33.27	Peak	145.00	100	Horizontal	Pass
1**	1332.100	30.90	-17.51	54.0	23.10	AV	145.00	100	Horizontal	Pass
2	2413.900	94.98	-12.52	74.0	-20.98	Peak	260.00	100	Horizontal	N/A
2**	2413.900	86.34	-12.52	54.0	-32.34	AV	260.00	100	Horizontal	N/A
3	3216.200	50.44	-7.30	74.0	23.56	Peak	267.00	150	Horizontal	Pass
3**	3216.200	48.80	-7.30	54.0	5.20	AV	267.00	150	Horizontal	N/A
4	4821.800	53.81	-3.30	74.0	20.19	Peak	1.00	150	Horizontal	Pass
4**	4821.800	45.64	-3.30	54.0	8.36	AV	1.00	150	Horizontal	Pass
5	12805.650	53.08	0.92	74.0	20.92	Peak	124.00	400	Horizontal	Pass
5**	12805.650	45.24	0.92	54.0	8.76	AV	124.00	400	Horizontal	Pass
6	17361.863	56.12	2.26	74.0	17.88	Peak	326.00	100	Horizontal	Pass
6**	17361.863	46.35	2.26	54.0	7.65	AV	326.00	100	Horizontal	Pass

1 GHz to 18 GHz, ANT V 802.11n20 Low Channel

No.	Frequency (MHz)	Results (dBuV/m)	Factor (dB)	Limit (dBuV/m)	Over Limit (dB)	Detector	Table (Degree)	Height (cm)	Antenna	Verdict
1	1164.400	46.73	-17.99	74.0	27.27	Peak	51.00	300	Vertical	Pass
1**	1164.400	32.23	-17.99	54.0	21.77	AV	51.00	300	Vertical	Pass
2	2416.600	94.78	-12.30	74.0	-20.78	Peak	304.00	100	Vertical	N/A
2**	2416.600	87.00	-12.30	54.0	-33.00	AV	304.00	100	Vertical	N/A
3	3216.200	54.04	-7.30	74.0	19.96	Peak	99.00	150	Vertical	Pass
3**	3216.200	53.60	-7.30	54.0	0.40	AV	99.00	150	Vertical	N/A
4	4828.800	56.51	-3.33	74.0	17.49	Peak	169.00	150	Vertical	Pass
4**	4828.800	50.01	-3.33	54.0	3.99	AV	169.00	150	Vertical	Pass
5	12919.050	53.58	1.24	74.0	20.42	Peak	124.00	300	Vertical	Pass
5**	12919.050	43.29	1.24	54.0	10.71	AV	124.00	300	Vertical	Pass
6	16067.474	56.00	1.24	74.0	18.00	Peak	234.00	400	Vertical	Pass
6**	16067.474	45.60	1.24	54.0	8.40	AV	234.00	400	Vertical	Pass

1 GHz to 18 GHz, ANT H 802.11n20 Middle Channel

No.	Frequency (MHz)	Results (dBuV/m)	Factor (dB)	Limit (dBuV/m)	Over Limit (dB)	Detector	Table (Degree)	Height (cm)	Antenna	Verdict
1	1327.400	39.62	-17.59	74.0	34.38	Peak	112.00	300	Horizontal	Pass
1**	1327.400	29.96	-17.59	54.0	24.04	AV	112.00	300	Horizontal	Pass
2	2432.700	94.17	-12.69	74.0	-20.17	Peak	260.00	200	Horizontal	N/A
2**	2432.700	86.18	-12.69	54.0	-32.18	AV	260.00	200	Horizontal	N/A
3	3249.400	50.24	-8.71	74.0	23.76	Peak	93.00	150	Horizontal	Pass
3**	3249.400	48.72	-8.71	54.0	5.28	AV	93.00	150	Horizontal	N/A
4	4874.800	50.76	-3.25	74.0	23.24	Peak	186.00	150	Horizontal	Pass
4**	4874.800	45.31	-3.25	54.0	8.69	AV	186.00	150	Horizontal	Pass
5	12857.625	53.18	1.44	74.0	20.82	Peak	254.00	400	Horizontal	Pass
5**	12857.625	43.67	1.44	54.0	10.33	AV	254.00	400	Horizontal	Pass
6	17420.136	55.89	3.75	74.0	18.11	Peak	217.00	200	Horizontal	Pass
6**	17420.136	46.77	3.75	54.0	7.23	AV	217.00	200	Horizontal	Pass

1 GHz to 18 GHz, ANT V 802.11n20 Middle Channel

No.	Frequency (MHz)	Results (dBuV/m)	Factor (dB)	Limit (dBuV/m)	Over Limit (dB)	Detector	Table (Degree)	Height (cm)	Antenna	Verdict
1	1162.000	43.97	-17.95	74.0	30.03	Peak	55.00	300	Vertical	Pass
1**	1162.000	32.41	-17.95	54.0	21.59	AV	55.00	300	Vertical	Pass
2	2441.200	94.27	-12.44	74.0	-20.27	Peak	331.00	200	Vertical	N/A
2**	2441.200	86.97	-12.44	54.0	-32.97	AV	331.00	200	Vertical	N/A
3	3249.400	52.88	-8.71	74.0	21.12	Peak	36.00	150	Vertical	Pass
3**	3249.400	51.64	-8.71	54.0	2.36	AV	36.00	150	Vertical	N/A
4	4872.800	53.23	-3.35	74.0	20.77	Peak	36.00	150	Vertical	Pass
4**	4872.800	48.46	-3.35	54.0	5.54	AV	36.00	150	Vertical	Pass
5	12908.026	53.32	1.40	74.0	20.68	Peak	345.00	200	Vertical	Pass
5**	12908.026	44.19	1.40	54.0	9.81	AV	345.00	200	Vertical	Pass
6	17413.313	56.32	3.57	74.0	17.68	Peak	326.00	300	Vertical	Pass
6**	17413.313	46.85	3.57	54.0	7.15	AV	326.00	300	Vertical	Pass

1 GHz to 18 GHz, ANT H 802.11n20 High Channel

No.	Frequency (MHz)	Results (dBuV/m)	Factor (dB)	Limit (dBuV/m)	Over Limit (dB)	Detector	Table (Degree)	Height (cm)	Antenna	Verdict
1	1330.500	39.61	-17.47	74.0	34.39	Peak	0.00	100	Horizontal	Pass
1**	1330.500	29.85	-17.47	54.0	24.15	AV	0.00	100	Horizontal	Pass
2	2463.400	93.17	-12.49	74.0	-19.17	Peak	256.00	150	Horizontal	N/A
2**	2463.400	84.94	-12.49	54.0	-30.94	AV	256.00	150	Horizontal	N/A
3	3282.800	51.36	-8.24	74.0	22.64	Peak	83.00	150	Horizontal	Pass
3**	3282.800	49.47	-8.24	54.0	4.53	AV	83.00	150	Horizontal	N/A
4	4921.400	51.73	-2.33	74.0	22.27	Peak	105.00	150	Horizontal	Pass
4**	4921.400	45.24	-2.33	54.0	8.76	AV	105.00	150	Horizontal	Pass
5	12877.312	53.38	1.53	74.0	20.62	Peak	217.00	200	Horizontal	Pass
5**	12877.312	43.76	1.53	54.0	10.24	AV	217.00	200	Horizontal	Pass
6	16080.075	55.52	1.64	74.0	18.48	Peak	0.00	200	Horizontal	Pass
6**	16080.075	46.01	1.64	54.0	7.99	AV	0.00	200	Horizontal	Pass

1 GHz to 18 GHz, ANT V 802.11n20 High Channel

No.	Frequency (MHz)	Results (dBuV/m)	Factor (dB)	Limit (dBuV/m)	Over Limit (dB)	Detector	Table (Degree)	Height (cm)	Antenna	Verdict
1	1161.700	46.44	-17.96	74.0	27.56	Peak	31.00	300	Vertical	Pass
1**	1161.700	35.91	-17.96	54.0	18.09	AV	31.00	300	Vertical	Pass
2	2463.300	92.68	-12.50	74.0	-18.68	Peak	124.00	200	Vertical	N/A
2**	2463.300	85.02	-12.50	54.0	-31.02	AV	124.00	200	Vertical	N/A
3	3282.800	53.12	-8.24	74.0	20.88	Peak	33.00	150	Vertical	Pass
3**	3282.800	51.38	-8.24	54.0	2.62	AV	33.00	150	Vertical	N/A
4	4928.000	53.80	-2.50	74.0	20.20	Peak	343.00	150	Vertical	Pass
4**	4928.000	47.78	-2.50	54.0	6.22	AV	343.00	150	Vertical	Pass
5	12837.937	53.43	1.30	74.0	20.57	Peak	327.00	400	Vertical	Pass
5**	12837.937	43.95	1.30	54.0	10.05	AV	327.00	400	Vertical	Pass
6	16058.025	55.86	0.88	74.0	18.14	Peak	51.00	300	Vertical	Pass
6**	16058.025	45.86	0.88	54.0	8.14	AV	51.00	300	Vertical	Pass

A.7 Band Edge (Restricted-band band-edge)

Note ¹: The lowest and highest channels are tested to verify the band edge emissions. Please refer to the following the plots for emissions values.

Note ²: The test data all are tested in the vertical and horizontal antenna which the trace is max hold. So these plots have shown the worst case.

Note ³: According the ANSI C63.10-2013, where limits are specified for both average and peak (or quasi-peak) detector functions, if the peak (or quasi-peak) measured value complies with the average limit, it is unnecessary to perform an average measurement.

Note ⁴: All the configurations were pre tested, only the worst configuration has been reported in this report.

Test Data and Plots

802.11b LOW CHANNEL

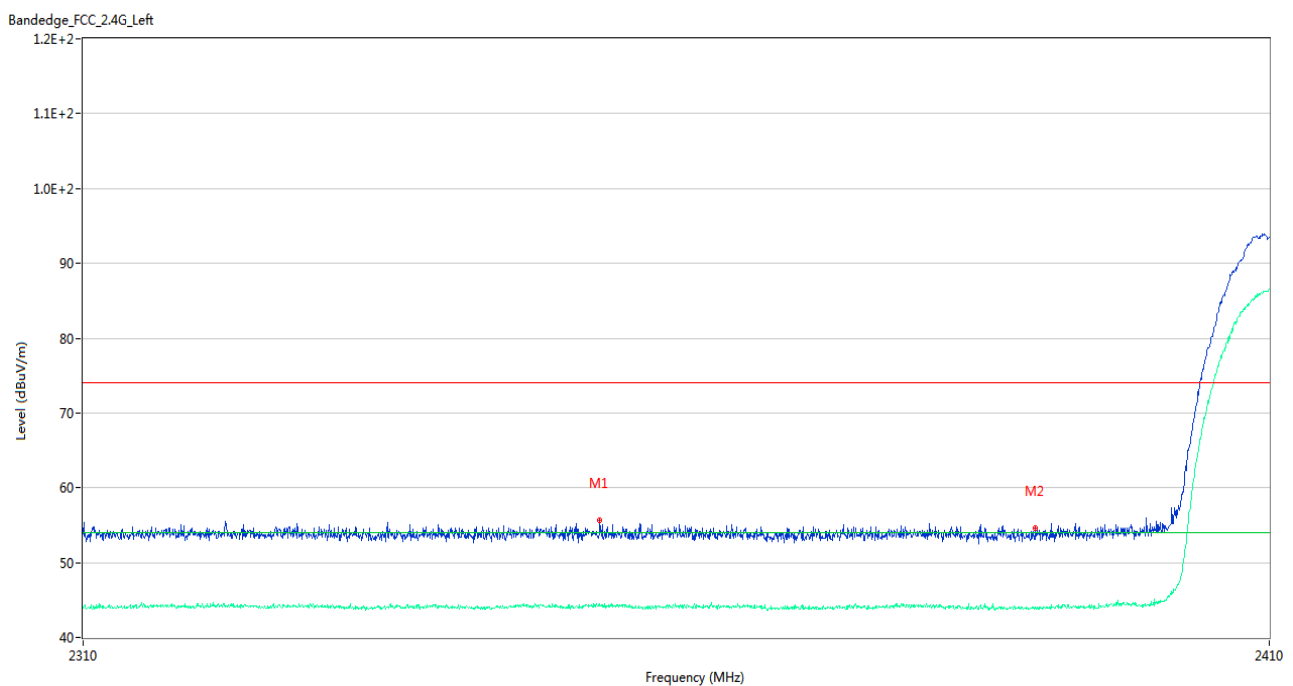

No.	Frequency (MHz)	Results (dBuV/m)	Factor (dB)	Limit (dBuV/m)	Margin (dB)	Detector	Table (Degree)	Height (cm)	Antenna	Verdict
1	2353.050	55.62	-0.22	74.0	18.38	Peak	200.00	200	Vertical	Pass
1**	2353.050	44.22	-0.22	54.0	9.78	AV	200.00	200	Vertical	Pass
2	2389.950	54.57	-0.59	74.0	19.43	Peak	303.00	150	Vertical	Pass
2**	2389.950	43.94	-0.59	54.0	10.06	AV	303.00	150	Vertical	Pass

802.11b HIGH CHANNEL

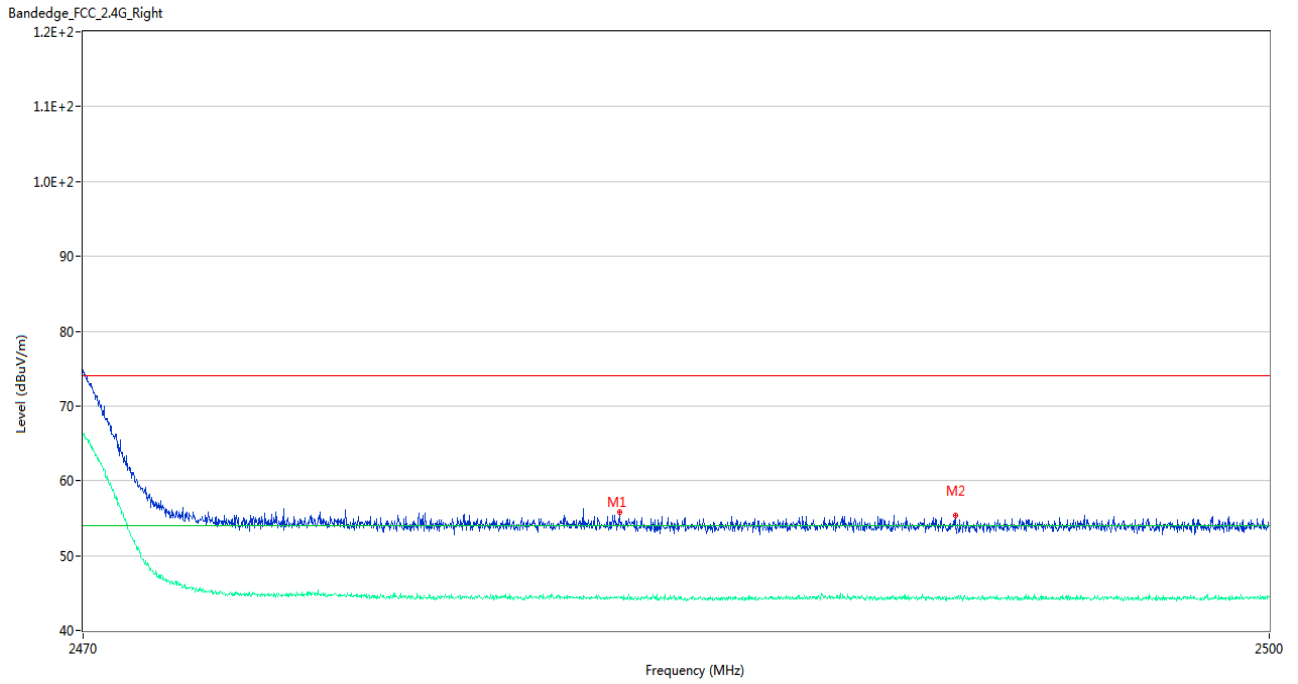

No.	Frequency (MHz)	Results (dBuV/m)	Factor (dB)	Limit (dBuV/m)	Margin (dB)	Detector	Table (Degree)	Height (cm)	Antenna	Verdict
1	2483.515	55.85	-0.05	74.0	18.15	Peak	315.00	100	Vertical	Pass
1**	2483.515	44.30	-0.05	54.0	9.70	AV	315.00	100	Vertical	Pass
2	2492.020	55.39	-0.23	74.0	18.61	Peak	315.00	100	Vertical	Pass
2**	2492.020	44.36	-0.23	54.0	9.64	AV	315.00	100	Vertical	Pass

802.11g LOW CHANNEL

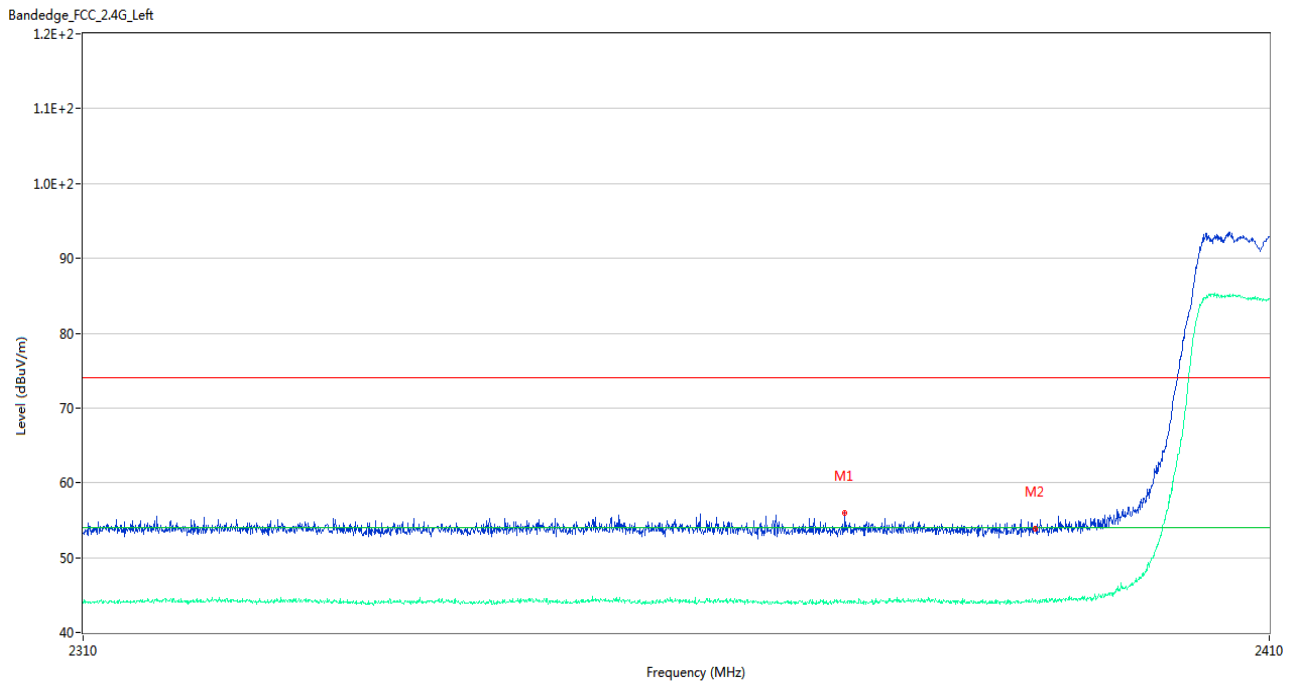

No.	Frequency (MHz)	Results (dBuV/m)	Factor (dB)	Limit (dBuV/m)	Margin (dB)	Detector	Table (Degree)	Height (cm)	Antenna	Verdict
1	2373.750	55.91	-0.61	74.0	18.09	Peak	360.00	200	Vertical	Pass
1**	2373.750	44.28	-0.61	54.0	9.72	AV	360.00	200	Vertical	Pass
2	2389.950	53.84	-0.59	74.0	20.16	Peak	360.00	100	Vertical	Pass
2**	2389.950	44.37	-0.59	54.0	9.63	AV	360.00	100	Vertical	Pass

802.11g HIGH CHANNEL

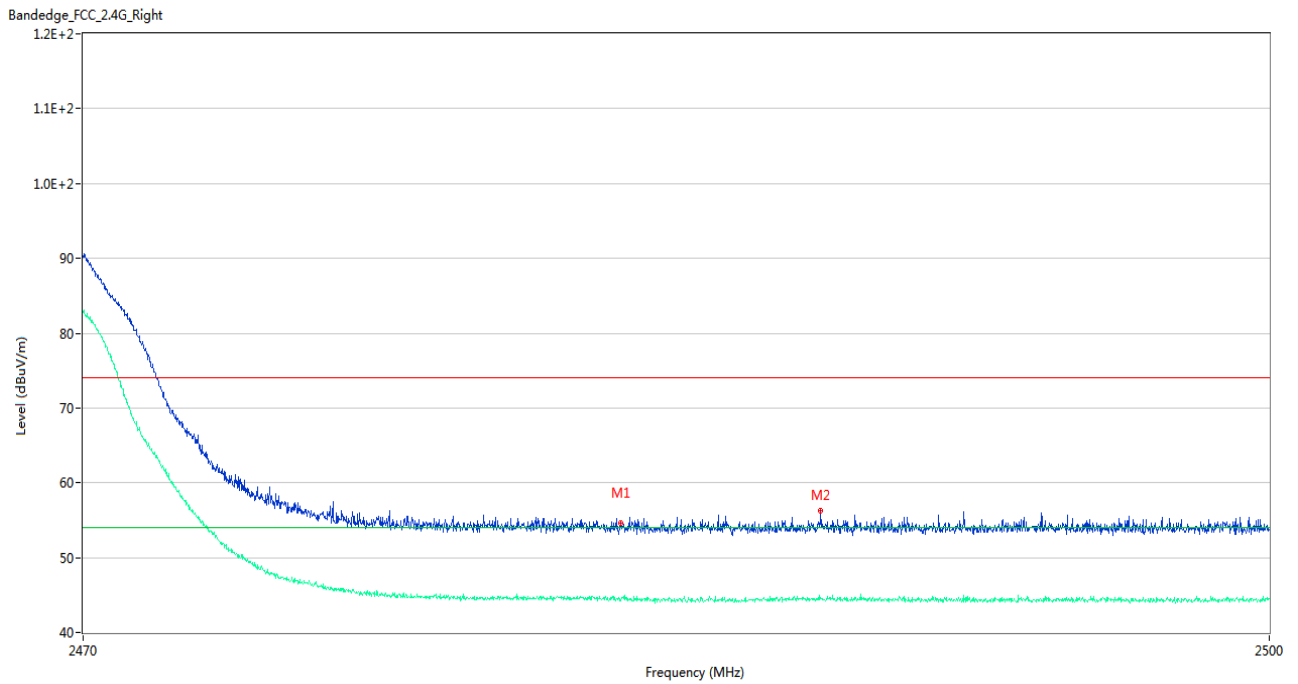

No.	Frequency (MHz)	Results (dBuV/m)	Factor (dB)	Limit (dBuV/m)	Margin (dB)	Detector	Table (Degree)	Height (cm)	Antenna	Verdict
1	2483.545	54.65	-0.06	74.0	19.35	Peak	37.00	100	Vertical	Pass
1**	2483.545	44.29	-0.06	54.0	9.71	AV	37.00	100	Vertical	Pass
2	2488.615	56.20	-0.07	74.0	17.80	Peak	64.00	200	Vertical	Pass
2**	2488.615	44.66	-0.07	54.0	9.34	AV	64.00	200	Vertical	Pass

802.11n20 LOW CHANNEL

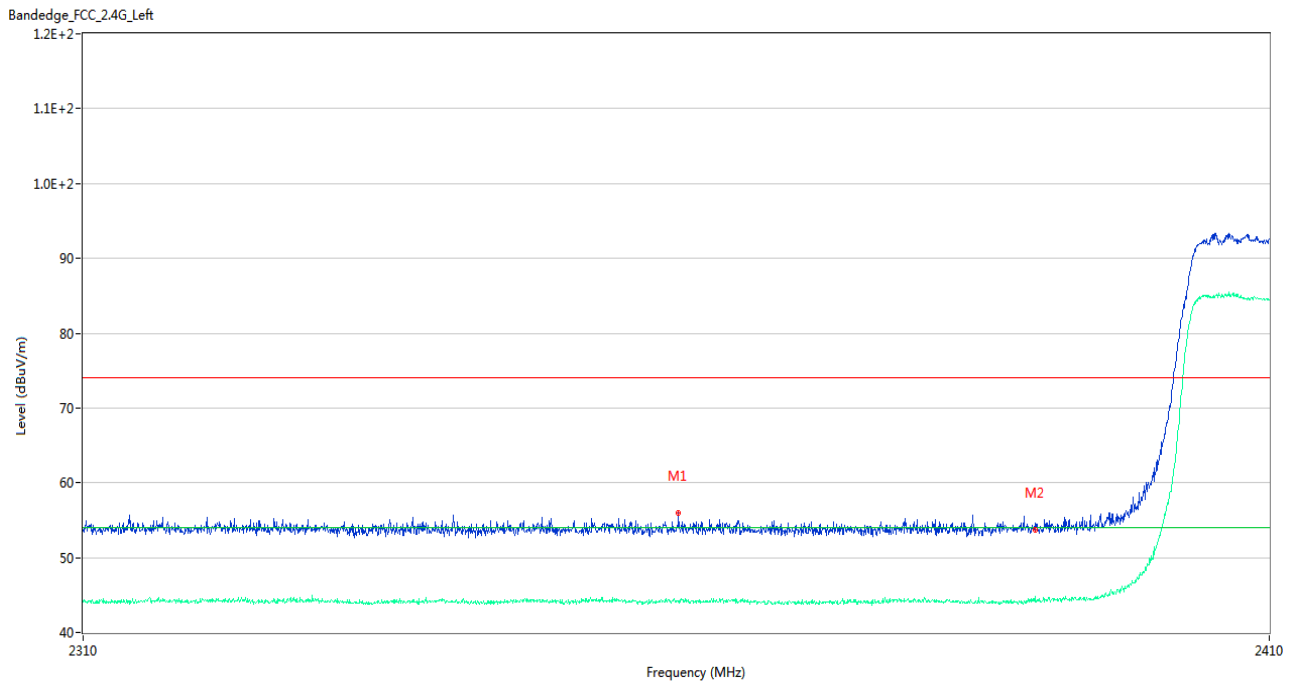

No.	Frequency (MHz)	Results (dBuV/m)	Factor (dB)	Limit (dBuV/m)	Margin (dB)	Detector	Table (Degree)	Height (cm)	Antenna	Verdict
1	2359.650	56.00	-0.23	74.0	18.00	Peak	346.00	200	Vertical	Pass
1**	2359.650	44.13	-0.23	54.0	9.87	AV	346.00	200	Vertical	Pass
2	2389.950	53.71	-0.59	74.0	20.29	Peak	360.00	200	Vertical	Pass
2**	2389.950	44.12	-0.59	54.0	9.88	AV	360.00	200	Vertical	Pass

802.11n20 HIGH CHANNEL

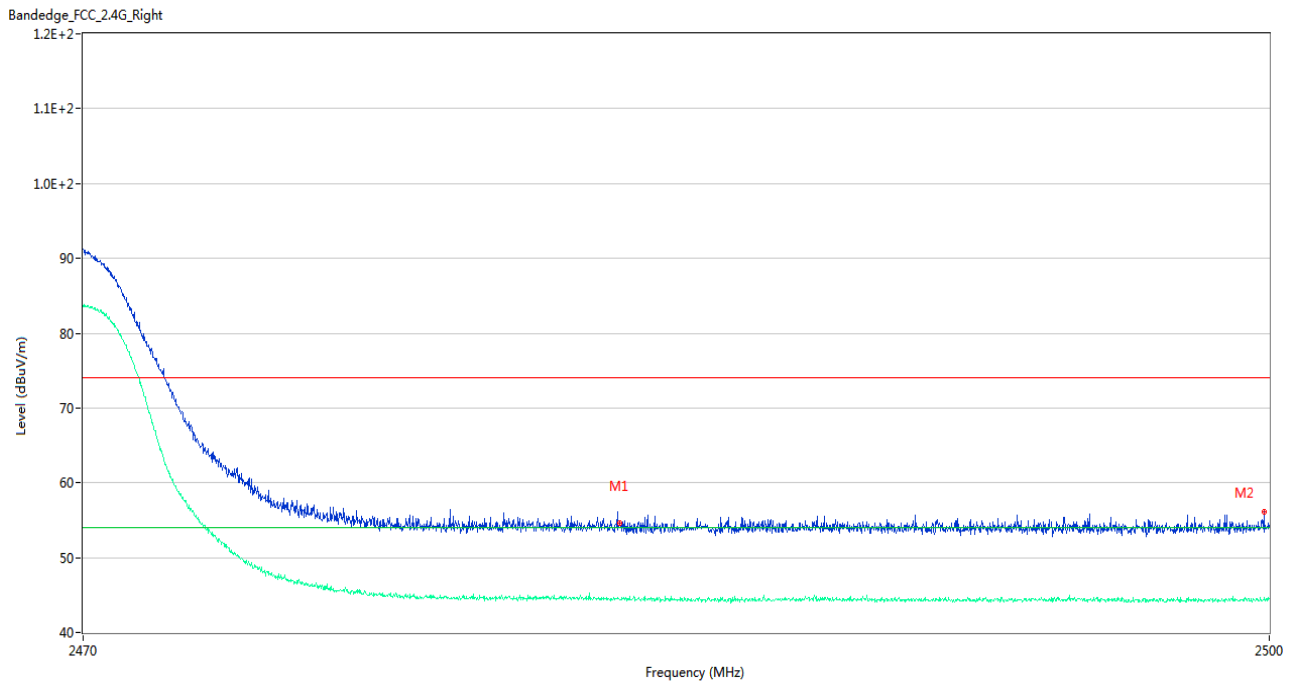

No.	Frequency (MHz)	Results (dBuV/m)	Factor (dB)	Limit (dBuV/m)	Margin (dB)	Detector	Table (Degree)	Height (cm)	Antenna	Verdict
1	2483.530	54.58	-0.05	74.0	19.42	Peak	360.00	150	Vertical	Pass
1**	2483.530	44.32	-0.05	54.0	9.68	AV	360.00	150	Vertical	Pass
2	2499.865	56.09	-0.11	74.0	17.91	Peak	329.00	100	Vertical	Pass
2**	2499.865	44.43	-0.11	54.0	9.57	AV	329.00	100	Vertical	Pass

A.8 Power Spectral Density (PSD)

Test Data

802.11b Mode:

Channel	Spectral power density (dBm/3kHz)	Limit (dBm/3kHz)
Low	-17.37	8
Middle	-13.80	8
High	-13.36	8

802.11g Mode:

Channel	Spectral power density (dBm/3kHz)	Limit (dBm/3kHz)
Low	-16.74	8
Middle	-18.20	8
High	-15.06	8

802.11n-20 MHz Mode:

Channel	Spectral power density (dBm/3kHz)	Limit (dBm/3kHz)
Low	-16.49	8
Middle	-16.83	8
High	-15.85	8

Test Plots

802.11b LOW CHANNEL

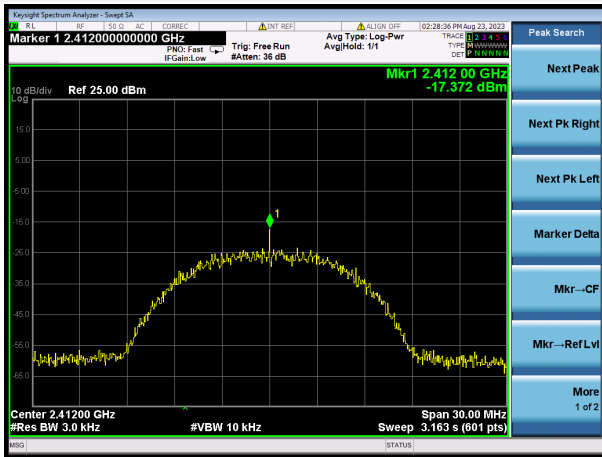

802.11b MIDDLE CHANNEL

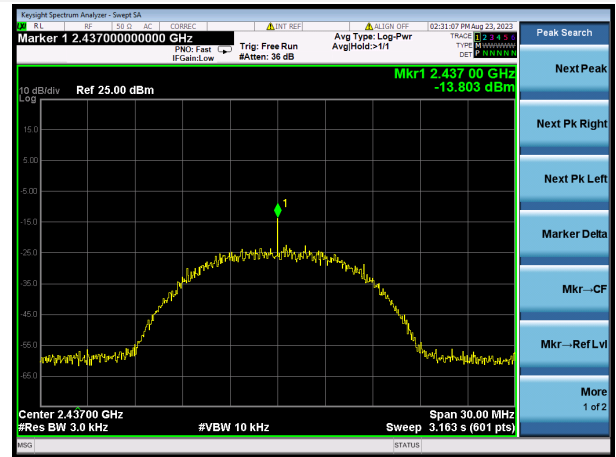

802.11b HIGH CHANNEL

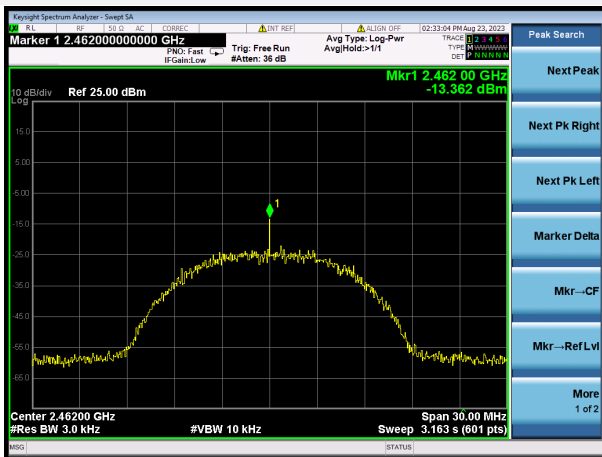

802.11g LOW CHANNEL

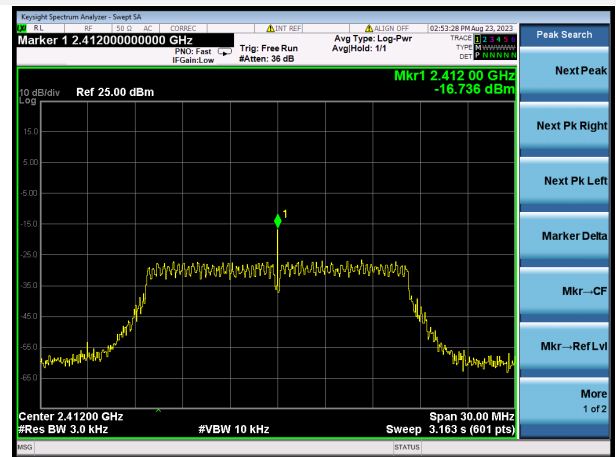

802.11g MIDDLE CHANNEL

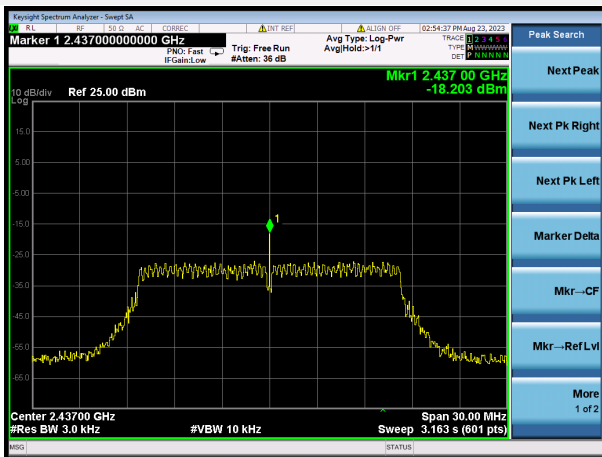

802.11g HIGH CHANNEL

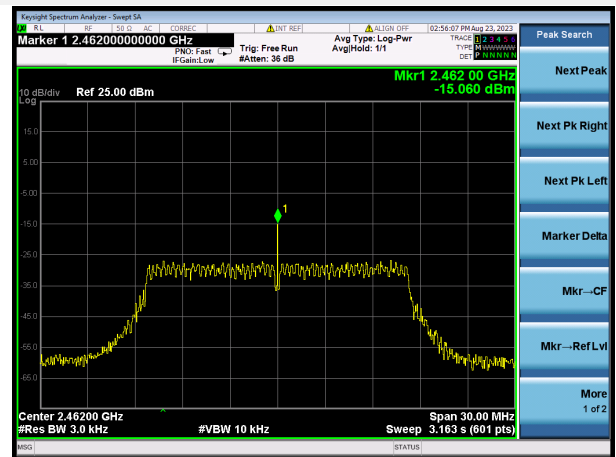

802.11n-20 MHz LOW CHANNEL

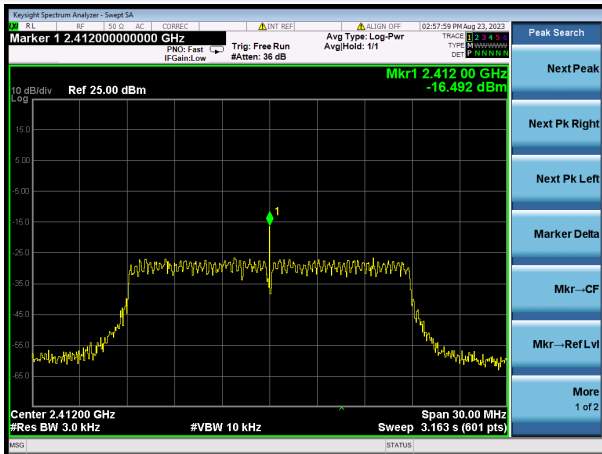

802.11n-20 MHz MIDDLE CHANNEL

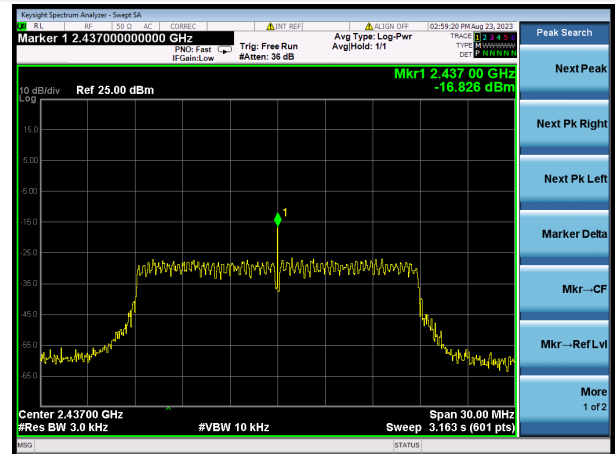

802.11n-20 MHz HIGH CHANNEL

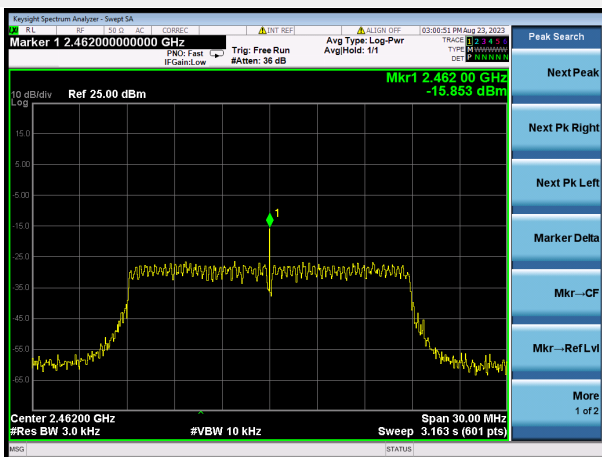

ANNEX B TEST SETUP PHOTOS

Please refer the document “BL-SZ2371201-AR.PDF”.

ANNEX C EUT EXTERNAL PHOTOS

Please refer the document “BL-SZ2371201-AW.PDF”.

ANNEX D EUT INTERNAL PHOTOS

Please refer the document “BL-SZ2371201-AI.PDF”.

Statement

1. The laboratory guarantees the scientificity, accuracy and impartiality of the test, and is responsible for all the information in the report, except the information provided by the customer. The customer is responsible for the impact of the information provided on the validity of the results.
2. The report without China inspection body and laboratory Mandatory Approval (CMA) mark has no effect of proving to the society.
3. For the report with CNAS mark or A2LA mark, the items marked with "☆" are not within the accredited scope.
4. This report is invalid if it is altered, without the signature of the testing and approval personnel, or without the "inspection and testing dedicated stamp" or test report stamp.
5. The test data and results are only valid for the tested samples provided by the customer.
6. This report shall not be partially reproduced without the written permission of the laboratory.
7. Any objection shall be raised to the laboratory within 30 days after receiving the report.

--END OF REPORT--