

## Warning Statement

This equipment has been tested and found to comply with the limits for a Class B digital device, pursuant to part 15 of the FCC Rules. These limits are designed to provide reasonable protection against harmful interference in a residential installation. This equipment generates, uses and can radiate radio frequency energy and, if not installed and used in accordance with the instructions, may cause harmful interference to radio communications. However, there is no guarantee that interference will not occur in a particular installation. If this equipment does cause harmful interference to radio or television reception, which can be determined by turning the equipment off and on, the user is encouraged to try to correct the interference by one or more of the following measures:

Reorient or relocate the receiving antenna.

Increase the separation between the equipment and receiver.

Connect the equipment into an outlet on a circuit different from that to which the receiver is connected.

Consult the dealer or an experienced radio/TV technician for help.

Caution: Any changes or modifications to this device not explicitly approved by manufacturer could void your authority to operate this equipment.

This device complies with part 15 of the FCC Rules. Operation is subject to the following two conditions:

- (1) This device may not cause harmful interference, and
- (2) this device must accept any interference received, including interference that may cause undesired operation.

The device has been evaluated to meet general RF exposure requirement. The device can be used in portable exposure condition without restriction.

### RF warning for Portable device:

The device has been evaluated to meet general RF exposure requirement. The device can be used in portable exposure can be used in portable exposure condition without restriction.

# QFX<sup>®</sup>

## SBX-106

OPERATING INSTRUCTIONS

INSTRUCCIONES DE FUNCIONAMIENTO



## Content

Content .....	1
Technical specifications .....	1
Safety Precaution .....	2
Top panel functions and control .....	3
Back panel functions and control .....	4
Remote functions .....	4
System connection .....	5
Instructions .....	5
Operation & Bluetooth Operation .....	6
Operation wireless microphone .....	6

## Technical specifications

- Impedance: 4  $\Omega$
- Frequency response: 55-20KHz
- S/N Ratio:  $\geq 71$ dB
- Harmonic distortion:  $\leq 1\%$
- Drive Unit : 6X10"
- Voltage: ~120V/240V 50/60Hz

## Operation

1. Turn on the unit, connect to sound sources and play.
2. Insert USB/SD card to read Mp3 tracks "MODE" key to select USB/SD/FM/BT/LINE INPUT. FM programmes scan & save automatically

## Bluetooth Operation

1. Turning on the power, press the "MODE" key or "INPUT" key on the panel or remote control, switch the speaker to Bluetooth channel. Then turn on the mobile phone Bluetooth function.
2. Search the Bluetooth device list and select the Bluetooth name "QFX SBX-106". The speaker will make a notification tone when the connection is successful.
3. Play the music on your mobile phone by music player. The music will be transferred via Bluetooth and sound comes out through the speaker.
4. To disconnect the Bluetooth device, the user can turn off Bluetooth function on the mobile phone, or press the "MODE" key or "INPUT" key on the speaker panel or remote control to change the playing mode.

## Operation wireless microphone

- Open the battery compartment, use the correct polarity. Turn on the microphone, the power LED is on, turn off the microphone, the power LED is off. When you turn on the microphone but the LED is off, please check whether the batteries are dead or in reversed polarity.
- Adjust the microphone volume knob to the appropriate location at the presentation.
- Make sure there are no obstructions between the unit and the wireless microphones at the demonstration. Keep them away from metal or antenna to avoid the deterioration in performance of wireless Microphone.
- To avoid to effect the reception, please use the wireless microphone in the efficient range. When battery's power is low, or disturbed a lot, it will be reduced the performance.
- In order to get the best performance, please keep your mouth to the microphone distance in 5-15 cm, and the tilt angle of 45 degrees with the microphone.
- When the battery power is low, the LED turns to red. Please replace the battery in time.
- Do not use the same frequency within a short distance of the microphone to sing, the microphone will be silent or disturbed.
- If you buy more than two sets of speakers with wireless microphone, and want to use at the same time. Please choose different varieties of standard frequency. Otherwise, the distance between two groups of the same frequency speakers must be at least 100 meters.

## System connection

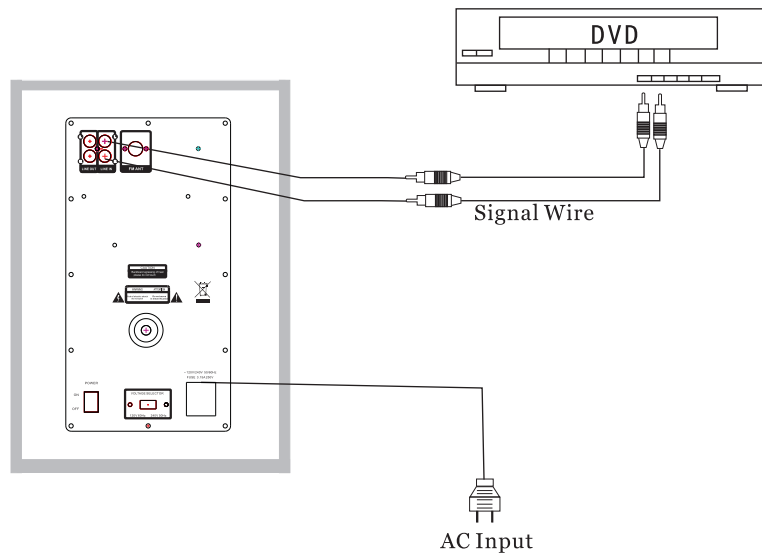

## Instructions

1. The white RCA socket L is for LEFT channel input, the red RCA socket R is for RIGHT channel input.
2. The 3.5 line-in socket is for audio source from PC through 3.5 JACK input.
3. Please connect the system according to the diagram above and refer to component instruction when connecting.
4. Please do not plug the power cable before the connecting is finished.
5. Please raise the volume to what will be needed before starting the system.
6. Please make sure all cables are firmly connected, in case any looses, no sound or noise may takes place.
7. Please make sure the power is off when plug or unplug the power cord to or from AC outlet.

## Safety Precaution

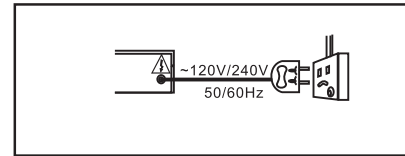

1. Power:  
When working/recharging under AC power, please operate only under power indicated in the instruction or marked on device.

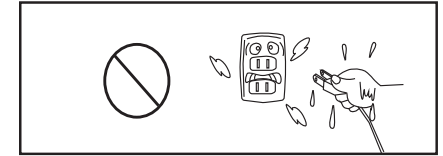

2. Caution for Electrical Shock:  
Wet hands are unallowable to plug in or out power plug to avoid electrical shock. Don't suffer raining or watering! Vases or other vessels containing water cannot be placed on the main unit.



3. This machine cannot bear heavy load:  
Avoid sunray hitting directly, and stays away from various heating sources such as stove, radiator and so on. Don't be close to the environments with much dust, high temperature, strong light and strong magnetic field etc.

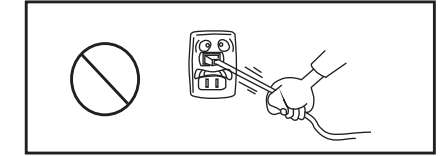

4. Power line protection:  
Prevent power line from being stepped on or pinched by heavy objects. Special attention should be paid to plug of power Cord, outlets on backboard and sockets on wall. Never pull or drag power line.

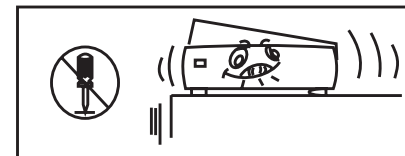

5. Do not dismantle the casing: Serious electric shock may occur if touching internal parts carelessly. Prevent metal pieces or liquid from dropping inside the machine from openings.

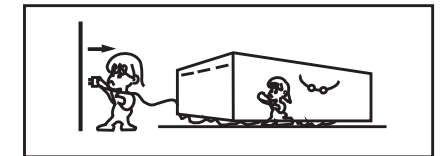

6. The plug as the device completely cut off from the power supply, It should keep easy operation.  
If the unit will not be used for a longtime, Please un plug the power cord from AC power Outlet.

## Top panel functions and control

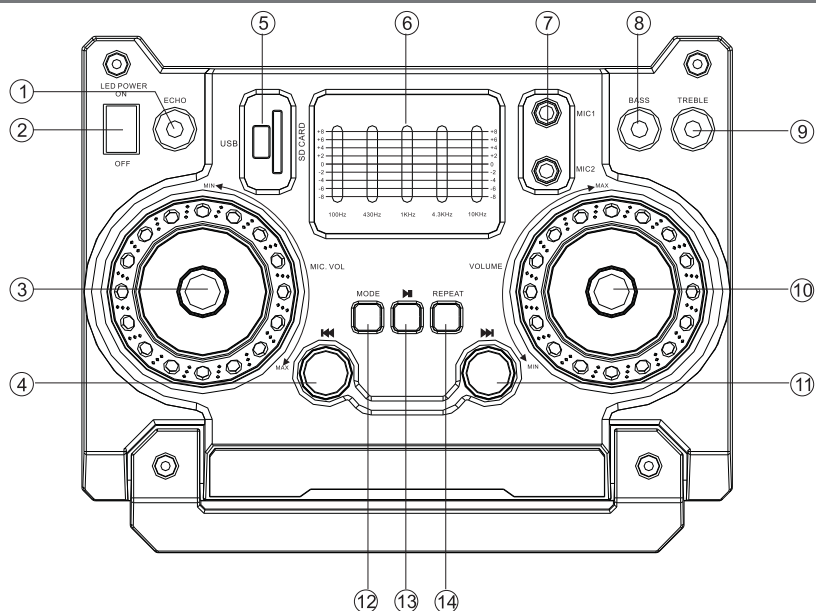

1. Echo control
2. Led switch
3. MIC volume control
4. Previous & vol- key
5. USB & SD jack
6. Equalizer for left and right channels
7. MIC jack
8. Bass control
9. Treble control
10. Master volume control
11. Next & vol+ key
12. Mode key -To select input signal source.
13. Play/ Pause & FM scan key
14. Repeat key

## Back panel functions and control

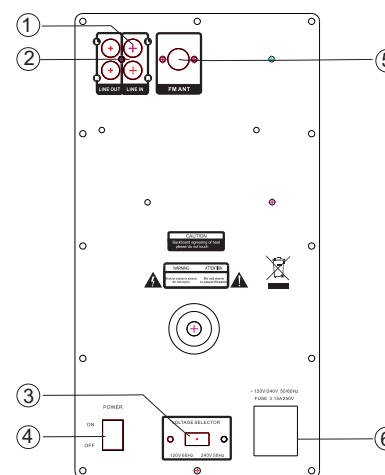

1. Line input
2. Line output
3. Voltage selector
4. ON/OFF switch
5. FM antenna
6. Power supply socket

## Remote functions

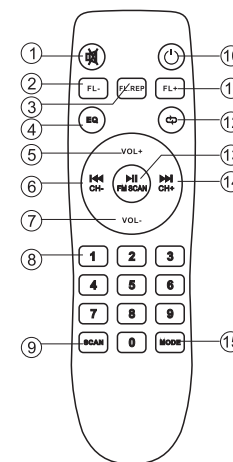

1. Mute key
2. Prev folder key
3. Folder Repeat key
4. EQ mode key
5. Volume increase key
6. Previous/Fm ch- key
7. Volume decrease key
8. Tracks select key
9. Scan key
10. Standby key
11. Next folder key
12. Repeat key
13. Play/pause/Fm scan key
14. Next/Fm ch+ key
15. Mode key -To select Input signal source