

## **EMC Test Report**

### **Application for FCC Grant of Equipment Authorization Canada Certification**

### **Innovation, Science and Economic Development Canada RSS-Gen Issue 4 / RSS 247 Issue 1 FCC Part 15 Subpart C**

#### **Model: BNHW028**

IC CERTIFICATION #: 21331-BCE130OD3  
FCC ID: 2AHVQBCE130OD3

APPLICANT: Barracuda Networks, Inc.  
5710 Fontanoso Way  
San Jose, CA 95138

TEST SITE(S): National Technical Systems - Silicon Valley  
41039 Boyce Road.  
Fremont, CA. 94538-2435

IC SITE REGISTRATION #: 2845B-4, 2845B-5, 2845B-7

REPORT DATE: May 4, 2016

RE-ISSUED DATE: June 3, 2016

FINAL TEST DATES: February 12 and April 6, 2016

TOTAL NUMBER OF PAGES: 81

PROGRAM MGR /  
TECHNICAL REVIEWER:

QUALITY ASSURANCE DELEGATE /  
FINAL REPORT PREPARER:

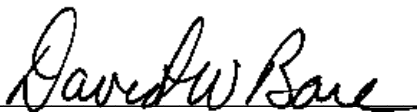

David W. Bare  
Chief Engineer

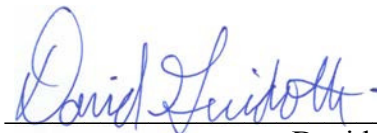

David Guidotti  
Senior Technical Writer



National Technical Systems - Silicon Valley is accredited by the A2LA, certificate number 0214.26, to perform the test(s) listed in this report, except where noted otherwise. This report and the information contained herein represent the results of testing test articles identified and selected by the client performed to specifications and/or procedures selected by the client. National Technical Systems (NTS) makes no representations, expressed or implied, that such testing is adequate (or inadequate) to demonstrate efficiency, performance, reliability, or any other characteristic of the articles being tested, or similar products. This report should not be relied upon as an endorsement or certification by NTS of the equipment tested, nor does it represent any statement whatsoever as to its merchantability or fitness of the test article, or similar products, for a particular purpose. This report shall not be reproduced except in full

**REVISION HISTORY**

Rev#	Date	Comments	Modified By
-	May 4, 2016	First release	
1	June 3, 2016	Revised to correct typographical error on page 41	dwb

**TABLE OF CONTENTS**

<b>REVISION HISTORY</b> .....	<b>2</b>
<b>TABLE OF CONTENTS</b> .....	<b>3</b>
<b>SCOPE</b> .....	<b>4</b>
<b>OBJECTIVE</b> .....	<b>4</b>
<b>STATEMENT OF COMPLIANCE</b> .....	<b>5</b>
<b>DEVIATIONS FROM THE STANDARDS</b> .....	<b>5</b>
<b>TEST RESULTS SUMMARY</b> .....	<b>6</b>
DIGITAL TRANSMISSION SYSTEMS (2400 – 2483.5MHZ) .....	6
MEASUREMENT UNCERTAINTIES .....	7
<b>EQUIPMENT UNDER TEST (EUT) DETAILS</b> .....	<b>8</b>
GENERAL.....	8
OTHER EUT DETAILS.....	8
ANTENNA SYSTEM .....	8
ENCLOSURE.....	8
MODIFICATIONS.....	8
SUPPORT EQUIPMENT .....	8
EUT INTERFACE PORTS .....	9
EUT OPERATION .....	9
<b>TEST SITE</b> .....	<b>10</b>
GENERAL INFORMATION .....	10
CONDUCTED EMISSIONS CONSIDERATIONS .....	10
RADIATED EMISSIONS CONSIDERATIONS .....	10
<b>MEASUREMENT INSTRUMENTATION</b> .....	<b>11</b>
RECEIVER SYSTEM .....	11
INSTRUMENT CONTROL COMPUTER .....	11
LINE IMPEDANCE STABILIZATION NETWORK (LISN).....	11
FILTERS/ATTENUATORS .....	12
ANTENNAS.....	12
ANTENNA MAST AND EQUIPMENT TURNTABLE .....	12
INSTRUMENT CALIBRATION.....	12
<b>TEST PROCEDURES</b> .....	<b>13</b>
EUT AND CABLE PLACEMENT .....	13
CONDUCTED EMISSIONS.....	13
RADIATED EMISSIONS.....	13
CONDUCTED EMISSIONS FROM ANTENNA PORT .....	17
BANDWIDTH MEASUREMENTS .....	17
SPECIFICATION LIMITS AND SAMPLE CALCULATIONS .....	18
CONDUCTED EMISSIONS SPECIFICATION LIMITS: FCC 15.207; FCC 15.107(A), RSS GEN .....	18
GENERAL TRANSMITTER RADIATED EMISSIONS SPECIFICATION LIMITS .....	19
OUTPUT POWER LIMITS – DIGITAL TRANSMISSION SYSTEMS .....	20
TRANSMIT MODE SPURIOUS RADIATED EMISSIONS LIMITS – FHSS AND DTS SYSTEMS.....	20
SAMPLE CALCULATIONS - CONDUCTED EMISSIONS .....	21
SAMPLE CALCULATIONS - RADIATED EMISSIONS.....	21
SAMPLE CALCULATIONS - FIELD STRENGTH TO EIRP CONVERSION.....	22
<b>APPENDIX A TEST EQUIPMENT CALIBRATION DATA</b> .....	<b>23</b>
<b>APPENDIX B TEST DATA</b> .....	<b>25</b>
<b>END OF REPORT</b> .....	<b>81</b>

## **SCOPE**

An electromagnetic emissions test has been performed on the Barracuda Networks, Inc. model BNHW028, pursuant to the following rules:

RSS-Gen Issue 4 “General Requirements for Compliance of Radio Apparatus”

RSS 247 Issue 1 “Digital Transmission Systems (DTSs), Frequency Hopping Systems (FHSS) and Licence-Exempt Local Area Network (LE-LAN) Devices”

FCC Part 15 Subpart C

Conducted and radiated emissions data has been collected, reduced, and analyzed within this report in accordance with measurement guidelines set forth in the following reference standards and as outlined in National Technical Systems - Silicon Valley test procedures:

ANSI C63.10-2013

FCC DTS Measurement Guidance KDB558074

The intentional radiator above has been tested in a simulated typical installation to demonstrate compliance with the relevant Industry Canada performance and procedural standards.

Final system data was gathered in a mode that tended to maximize emissions by varying orientation of EUT, orientation of power and I/O cabling, antenna search height, and antenna polarization.

Every practical effort was made to perform an impartial test using appropriate test equipment of known calibration. All pertinent factors have been applied to reach the determination of compliance.

## **OBJECTIVE**

The primary objective of the manufacturer is compliance with the regulations outlined in the previous section.

Prior to marketing in the USA, all unlicensed transmitters and transceivers require certification. Receive-only devices operating between 30 MHz and 960 MHz are subject to either certification or a manufacturer’s declaration of conformity, with all other receive-only devices exempt from the technical requirements.

Prior to marketing in Canada, Class I transmitters, receivers and transceivers require certification. Class II devices are required to meet the appropriate technical requirements but are exempt from certification requirements.

Certification is a procedure where the manufacturer submits test data and technical information to a certification body and receives a certificate or grant of equipment authorization upon successful completion of the certification body’s review of the submitted documents. Once the equipment authorization has been obtained, the label indicating compliance must be attached to all identical units, which are subsequently manufactured.

Maintenance of compliance is the responsibility of the manufacturer. Any modification of the product which may result in increased emissions should be checked to ensure compliance has been maintained (i.e., printed circuit board layout changes, different line filter, different power supply, harnessing or I/O cable changes, etc.).

### **STATEMENT OF COMPLIANCE**

The tested sample of Barracuda Networks, Inc. model BNHW028 complied with the requirements of the following regulations:

RSS-Gen Issue 4 “ General Requirements for Compliance of Radio Apparatus”

RSS 247 Issue 1 “Digital Transmission Systems (DTSs), Frequency Hopping Systems (FHSS) and Licence-Exempt Local Area Network (LE-LAN) Devices”

FCC Part 15 Subpart C

Maintenance of compliance is the responsibility of the manufacturer. Any modifications to the product should be assessed to determine their potential impact on the compliance status of the device with respect to the standards detailed in this test report.

The test results recorded herein are based on a single type test of Barracuda Networks, Inc. model BNHW028 and therefore apply only to the tested sample. The sample was selected and prepared by Gary Liu of Barracuda Networks, Inc..

### **DEVIATIONS FROM THE STANDARDS**

No deviations were made from the published requirements listed in the scope of this report.

## TEST RESULTS SUMMARY

### DIGITAL TRANSMISSION SYSTEMS (2400 – 2483.5MHz)

FCC Rule Part	RSS Rule Part	Description	Measured Value / Comments	Limit / Requirement	Result
15.247(a)	RSS 247 5.2	Digital Modulation	Systems uses OFDM / DSSS techniques	System must utilize a digital transmission technology	Complies
15.247 (a) (2)	RSS 247 5.2 (1)	6dB Bandwidth	b: 9.80 MHz g: 16.33 MHz n20: 17.13 MHz	>500kHz	Complies
15.247 (b) (3)	RSS 247 5.4 (4)	Output Power (multipoint systems)	b: 17.0 dBm g: 17.6 dBm n20: 17.6 dBm  EIRP = 0.0 W <sup>Note 1</sup>	1Watt, EIRP limited to 4 Watts.	Complies
15.247(e)	RSS 247 5.2 (2)	Power Spectral Density	b: -1.4 dBm / 10 kHz g: -3.2 dBm / 10 kHz n20: -2.8 dBm / 10 kHz	8dBm/3kHz	Complies
15.247(d)	RSS 247 5.5	Antenna Port Spurious Emissions 30MHz – 25 GHz	All emissions < 30 dBc	< -30dBc <sup>Note 2</sup>	Complies
15.247(d) / 15.209	RSS 247 5.5	Radiated Spurious Emissions 30MHz – 25 GHz	53.9 dBμV/m @ 2390.0 MHz (-0.1 dB)	Refer to the limits section (p19) for restricted bands, all others <-30dBc <sup>Note 2</sup>	Complies
<p>Note 1: EIRP calculated using antenna gains of 3.2 dBi for the highest EIRP system.</p> <p>Note 2: Limit of -30dBc used because the power was measured using maximum power averaged over a transmission burst.</p>					

### GENERAL REQUIREMENTS APPLICABLE TO ALL BANDS

FCC Rule Part	RSS Rule part	Description	Measured Value / Comments	Limit / Requirement	Result (margin)
15.203	-	RF Connector	Reverse Polarity SMA	Unique or integral antenna required	Complies
15.407 (b) (6)	RSS-Gen Table 3	AC Conducted Emissions	48.4 dBμV @ 0.516 MHz (-7.6 dB)	Refer to page 18	Complies
15.247 (i) 15.407 (f)	RSS 102	RF Exposure Requirements	Refer to MPE calculations in separate exhibit, RSS 102 declaration and User Manual statements.	Refer to OET 65, FCC Part 1 and RSS 102	Complies
-	RSS-Gen 8.3	User Manual		Statement for products with detachable antenna	Complies
-	RSS-Gen 8.4	User Manual		Statement for all products	Complies
-	RSP-100 RSS-Gen 6.6	Occupied Bandwidth	b: 12.13 MHz g: 17.04 MHz n20: 17.97 MHz	Information only	N/A

**MEASUREMENT UNCERTAINTIES**

ISO/IEC 17025 requires that an estimate of the measurement uncertainties associated with the emissions test results be included in the report. The measurement uncertainties given below are based on a 95% confidence level and were calculated in accordance with UKAS document LAB 34.

Measurement Type	Measurement Unit	Frequency Range	Expanded Uncertainty
RF power, conducted (power meter)	dBm	25 to 7000 MHz	$\pm 0.52$ dB
RF power, conducted (Spectrum analyzer)	dBm	25 to 7000 MHz	$\pm 0.7$ dB
Conducted emission of transmitter	dBm	25 to 26500 MHz	$\pm 0.7$ dB
Conducted emission of receiver	dBm	25 to 26500 MHz	$\pm 0.7$ dB
Radiated emission (substitution method)	dBm	25 to 26500 MHz	$\pm 2.5$ dB
Radiated emission (field strength)	dB $\mu$ V/m	25 to 1000 MHz	$\pm 3.6$ dB
		1000 to 40000 MHz	$\pm 6.0$ dB
Conducted Emissions (AC Power)	dB $\mu$ V	0.15 to 30 MHz	$\pm 2.4$ dB

## EQUIPMENT UNDER TEST (EUT) DETAILS

### GENERAL

The Barracuda Networks, Inc. model BNHW028 is a camera that is designed for cloud-based video surveillance. Since the EUT could be placed in any position during operation, the EUT was treated as tabletop equipment during testing to simulate the end-user environment. The electrical rating of the EUT is 44-57 Volts DC, 0.4 Watts via POE.

The sample was received on February 12, 2016 and tested on February 12 and April 6, 2016. The EUT consisted of the following component(s):

Company	Model	Description	Serial Number	FCC ID
Barracuda Networks	BNHW028	Security Camera	00:25:19:06:99:20	2AHVQBCE130OD3

### OTHER EUT DETAILS

The following EUT details should be noted: The Camera can be connected via wired Ethernet or Wi-Fi.

### ANTENNA SYSTEM

The antenna system consists of RP SMA whip antenna.

### ENCLOSURE

The EUT enclosure is primarily constructed of metal with a plastic dome. It measures approximately 13 cm diameter by 10 cm high.

### MODIFICATIONS

No modifications were made to the EUT during the time the product was at NTS Silicon Valley.

### SUPPORT EQUIPMENT

The following equipment was used as support equipment for testing:

#### Test Configuration #1

Company	Model	Description	Serial Number	FCC ID
MSI	MS-1352	Laptop	None	-
Barracuda Networks	-	USB to Serial test port adapter	None	-
Pihong	POE16R-1AF	POE adapter	None	-
ASUS	RT-N12	Network Switch	F9IADQ000339	-

#### Test Configuration #2

Company	Model	Description	Serial Number	FCC ID
MSI	MS-1352	Laptop	None	-
Barracuda Networks	-	USB to Serial test port adapter	None	-
Netgear	FSM7236P	POE Network Switch	11V2565M000BE	-



The following equipment was used as remote support equipment for emissions testing:

**Test Configuration #1**

Company	Model	Description	Serial Number	FCC ID
None				

**Test Configuration #2**

Company	Model	Description	Serial Number	FCC ID
ASUS	RT-N12	Network Switch	F9IADQ000339	-

**EUT INTERFACE PORTS**

The I/O cabling configuration during testing was as follows:

**Test Configuration #1 EUT**

Port	Connected To	Description	Cable(s)	
			Shielded or Unshielded	Length(m)
POE	POE Adapter	Cat 5	Unshielded	2
USB Serial Test Port adapter	Laptop	USB	Shielded	2

**Test Configuration #1 Additional on Support Equipment**

Port	Connected To	Description	Cable(s)	
			Shielded or Unshielded	Length(m)
POE Adapter In	Network switch	Cat 5	Unshielded	2
Laptop Ethernet	Network switch	Cat 5	Unshielded	2

**Test Configuration #2 EUT**

Port	Connected To	Description	Cable(s)	
			Shielded or Unshielded	Length(m)
POE	POE Network Switch	Cat 5	Unshielded	2
USB Serial Test Port adapter	Laptop	USB	Shielded	2

**Test Configuration #2 Additional on Support Equipment**

Port	Connected To	Description	Cable(s)	
			Shielded or Unshielded	Length(m)
Laptop Ethernet	POE Network switch	Cat 5	Unshielded	2
POE Network Switch	Remote Network switch	Cat 5	Unshielded	15

**EUT OPERATION**

During emissions testing the EUT was configured to transmit continuously on the selected channel, in the selected mode, at the chosen power setting.

**TEST SITE****GENERAL INFORMATION**

Final test measurements were taken at the test sites listed below. Pursuant to section 2.948 of the FCC's Rules and section 3.3 of RSP-100, construction, calibration, and equipment data has been filed with the Commission and with industry Canada.

Site	Designation / Registration Numbers		Location
	FCC	Canada	
Chamber 4	US0027	2845B-4	41039 Boyce Road Fremont, CA 94538-2435
Chamber 5	US0027	2845B-5	
Chamber 7	US0027	2845B-7	

ANSI C63.4 recommends that ambient noise at the test site be at least 6 dB below the allowable limits. Ambient levels are below this requirement. The test site(s) contain separate areas for radiated and conducted emissions testing. Considerable engineering effort has been expended to ensure that the facilities conform to all pertinent requirements of ANSI C63.4.

**CONDUCTED EMISSIONS CONSIDERATIONS**

Conducted emissions testing is performed in conformance with ANSI C63.10. Measurements are made with the EUT connected to the public power network through a nominal, standardized RF impedance, which is provided by a line impedance stabilization network, known as a LISN. A LISN is inserted in series with each current-carrying conductor in the EUT power cord.

**RADIATED EMISSIONS CONSIDERATIONS**

The FCC has determined that radiation measurements made in a shielded enclosure are not suitable for determining levels of radiated emissions. Radiated measurements are performed in an open field environment or in a semi-anechoic chamber. The test sites are maintained free of conductive objects within the CISPR defined elliptical area incorporated in ANSI C63.4 guidelines and meet the Normalized Site Attenuation (NSA) requirements of ANSI C63.4.

## **MEASUREMENT INSTRUMENTATION**

### **RECEIVER SYSTEM**

An EMI receiver as specified in CISPR 16-1-1 is used for emissions measurements. The receivers used can measure over the frequency range of 9 kHz up to 2000 MHz. These receivers allow both ease of measurement and high accuracy to be achieved. The receivers have Peak, Average, and CISPR (Quasi-peak) detectors built into their design so no external adapters are necessary. The receiver automatically sets the required bandwidth for the CISPR detector used during measurements. If the repetition frequency of the signal being measured is below 20Hz, peak measurements are made in lieu of Quasi-Peak measurements.

For measurements above the frequency range of the receivers, a spectrum analyzer is utilized because it provides visibility of the entire spectrum along with the precision and versatility required to support engineering analysis. Average measurements above 1000MHz are performed on the spectrum analyzer using the linear-average method with a resolution bandwidth of 1 MHz and a video bandwidth of 10 Hz, unless the signal is pulsed in which case the average (or video) bandwidth of the measuring instrument is reduced to onset of pulse desensitization and then increased.

### **INSTRUMENT CONTROL COMPUTER**

Software is used to view and convert receiver measurements to the field strength at an antenna or voltage developed at the LISN measurement port, which is then compared directly with the appropriate specification limit. This provides faster, more accurate readings by performing the conversions described under Sample Calculations within the Test Procedures section of this report. Results are printed in a graphic and/or tabular format, as appropriate. A personal computer is used to record all measurements made with the receivers. The software used for radiated and conducted emissions measurements is NTS EMI Test Software (rev 2.10)

### **LINE IMPEDANCE STABILIZATION NETWORK (LISN)**

Line conducted measurements utilize a fifty microhenry Line Impedance Stabilization Network as the monitoring point. The LISN used also contains a 250 uH CISPR adapter. This network provides for calibrated radio frequency noise measurements by the design of the internal low pass and high pass filters on the EUT and measurement ports, respectively.

**FILTERS/ATTENUATORS**

External filters and precision attenuators are often connected between the receiving antenna or LISN and the receiver. This eliminates saturation effects and non-linear operation due to high amplitude transient events.

**ANTENNAS**

A loop antenna is used below 30 MHz. For the measurement range 30 MHz to 1000 MHz either a combination of a biconical antenna and a log periodic or a bi-log antenna is used. Above 1000 MHz, horn antennas are used. The antenna calibration factors to convert the received voltage to an electric field strength are included with appropriate cable loss and amplifier gain factors to determine an overall site factor, which is then programmed into the test receivers or incorporated into the test software.

**ANTENNA MAST AND EQUIPMENT TURNTABLE**

The antennas used to measure the radiated electric field strength are mounted on a non-conductive antenna mast equipped with a motor-drive to vary the antenna height. Measurements below 30 MHz are made with the loop antenna at a fixed height of 1m above the ground plane.

ANSI C63.10 specifies that the test height above ground for table mounted devices shall be 80 centimeters. Floor mounted equipment shall be placed on the ground plane if the device is normally used on a conductive floor or separated from the ground plane by insulating material from 3 to 12 mm if the device is normally used on a non-conductive floor as specified in ANSI C63.4. During radiated measurements, the EUT is positioned on a motorized turntable in conformance with this requirement.

**INSTRUMENT CALIBRATION**

All test equipment is regularly checked to ensure that performance is maintained in accordance with the manufacturer's specifications. All antennas are calibrated at regular intervals with respect to tuned half-wave dipoles. An exhibit of this report contains the list of test equipment used and calibration information.

## TEST PROCEDURES

### EUT AND CABLE PLACEMENT

The regulations require that interconnecting cables be connected to the available ports of the unit and that the placement of the unit and the attached cables simulate the worst case orientation that can be expected from a typical installation, so far as practicable. To this end, the position of the unit and associated cabling is varied within the guidelines of ANSI C63.10, and the worst-case orientation is used for final measurements.

### CONDUCTED EMISSIONS

Conducted emissions are measured at the plug end of the power cord supplied with the EUT. Excess power cord length is wrapped in a bundle between 30 and 40 centimeters in length near the center of the cord. Preliminary measurements are made to determine the highest amplitude emission relative to the specification limit for all the modes of operation. Placement of system components and varying of cable positions are performed in each mode. A final peak mode scan is then performed in the position and mode for which the highest emission was noted on all current carrying conductors of the power cord.

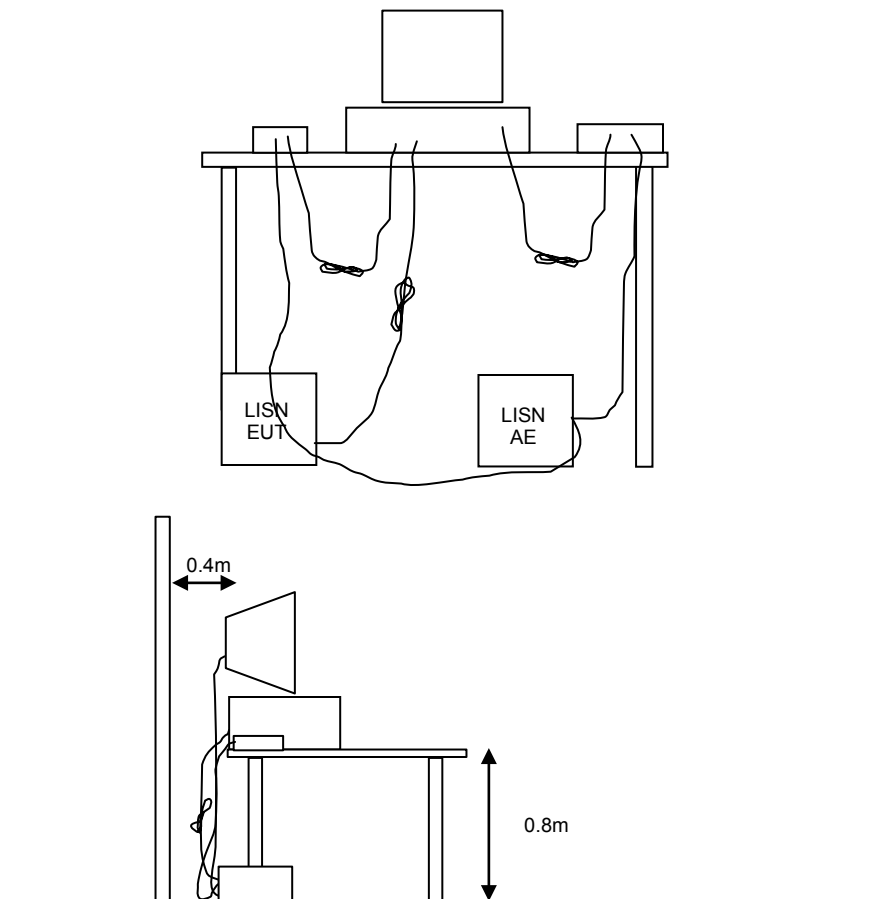

**Figure 1 Typical Conducted Emissions Test Configuration**

**RADIATED EMISSIONS**

A preliminary scan of the radiated emissions is performed in which all significant EUT frequencies are identified with the system in a nominal configuration. At least two scans are performed, one scan for each antenna polarization (horizontal and vertical; loop parallel and perpendicular to the EUT). During the preliminary scans, the EUT is rotated through 360°, the antenna height is varied (for measurements above 30 MHz) and cable positions are varied to determine the highest emission relative to the limit. Preliminary scans may be performed in a fully anechoic chamber for the purposes of identifying the frequencies of the highest emissions from the EUT.

A speaker is provided in the receiver to aid in discriminating between EUT and ambient emissions. Other methods used during the preliminary scan for EUT emissions involve scanning with near field magnetic loops, monitoring I/O cables with RF current clamps, and cycling power to the EUT.

Final maximization is a phase in which the highest amplitude emissions identified in the spectral search are viewed while the EUT azimuth angle is varied from 0 to 360 degrees relative to the receiving antenna. The azimuth, which results in the highest emission is then maintained while varying the antenna height from one to four meters (for measurements above 30 MHz, measurements below 30 MHz are made with the loop antenna at a fixed height of 1m). The result is the identification of the highest amplitude for each of the highest peaks. Each recorded level is corrected in the receiver using appropriate factors for cables, connectors, antennas, and preamplifier gain.

When testing above 18 GHz, the receive antenna is located at 1 meter from the EUT and the antenna height is restricted to a maximum of 2.5 meters.

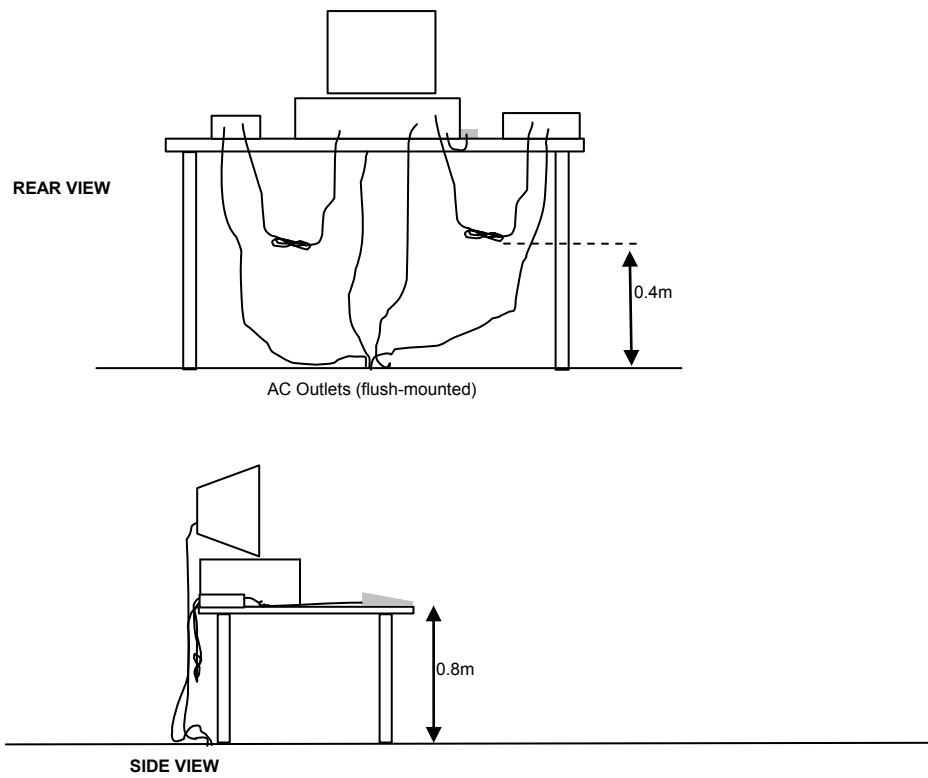

Typical Test Configuration for Radiated Field Strength Measurements

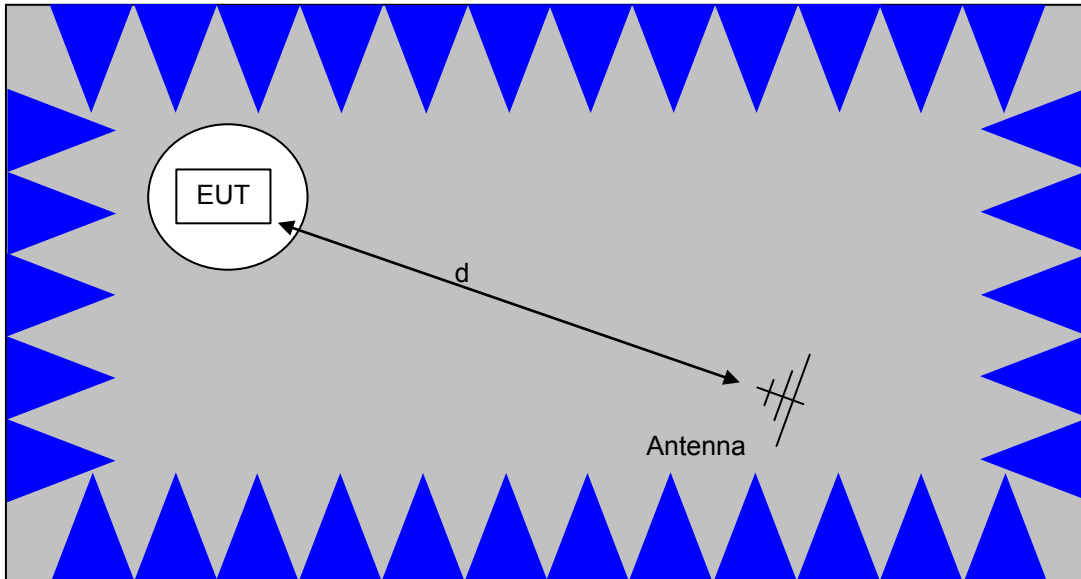

The anechoic materials on the walls and ceiling ensure compliance with the normalized site attenuation requirements of CISPR 16 / CISPR 22 / ANSI C63.4 for an alternate test site at the measurement distances used.

Floor-standing equipment is placed on the floor with insulating supports between the unit and the ground plane.

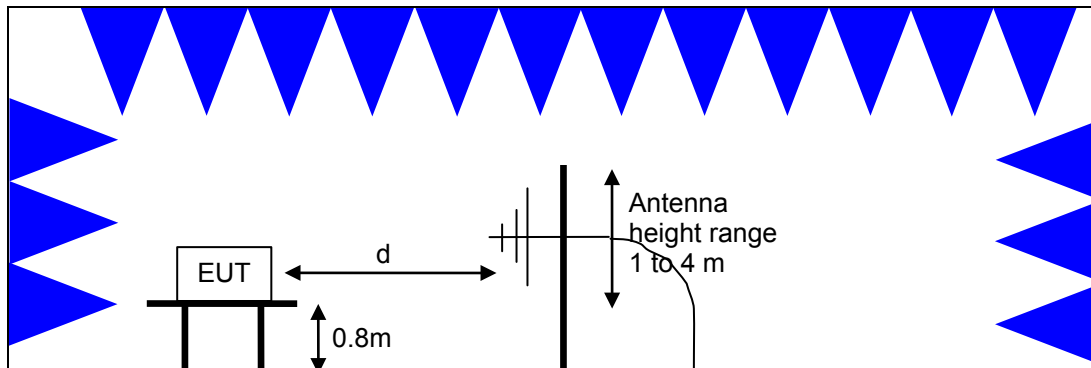

Test Configuration for Radiated Field Strength Measurements  
Semi-Anechoic Chamber, Plan and Side Views



**CONDUCTED EMISSIONS FROM ANTENNA PORT**

Direct measurements of power, bandwidth and power spectral density are performed, where possible, with the antenna port of the EUT connected to either the power meter or spectrum analyzer via a suitable attenuator and/or filter. These are used to ensure that the front end of the measurement instrument is not overloaded by the fundamental transmission.

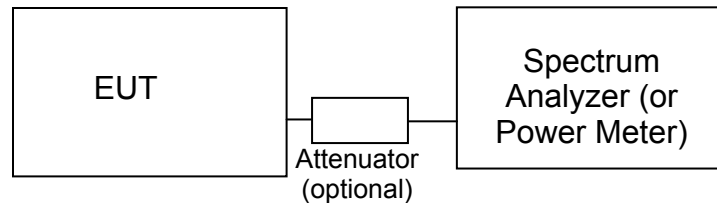
Test Configuration for Antenna Port Measurements

Measurement bandwidths (video and resolution) are set in accordance with the relevant standards and NTS Silicon Valley's test procedures for the type of radio being tested. When power measurements are made using a resolution bandwidth less than the signal bandwidth the power is calculated by summing the power across the signal bandwidth using either the analyzer channel power function or by capturing the trace data and calculating the power using software. In both cases the summed power is corrected to account for the equivalent noise bandwidth (ENBW) of the resolution bandwidth used.

If power averaging is used (typically for certain digital modulation techniques), the EUT is configured to transmit continuously. Power averaging is performed using either the built-in function of the analyzer or, if the analyzer does not feature power averaging, using external software. In both cases the average power is calculated over a number of sweeps (typically 100). When the EUT cannot be configured to continuously transmit then either the analyzer is configured to perform a gated sweep to ensure that the power is averaged over periods that the device is transmitting or power averaging is disabled and a max-hold feature is used.

If a power meter is used to make output power measurements the sensor head type (peak or average) is stated in the test data table.

**BANDWIDTH MEASUREMENTS**

The 6dB, 20dB, 26dB and/or 99% signal bandwidth are measured using the bandwidths recommended by ANSI C63.10 and RSS GEN.

**SPECIFICATION LIMITS AND SAMPLE CALCULATIONS**

The limits for conducted emissions are given in units of microvolts, and the limits for radiated emissions are given in units of microvolts per meter at a specified test distance. Data is measured in the logarithmic form of decibels relative to one microvolt, or dB microvolts (dBuV). For radiated emissions, the measured data is converted to the field strength at the antenna in dB microvolts per meter (dBuV/m). The results are then converted to the linear forms of uV and uV/m for comparison to published specifications.

For reference, converting the specification limits from linear to decibel form is accomplished by taking the base ten logarithm, then multiplying by 20. These limits in both linear and logarithmic form are as follows:

**CONDUCTED EMISSIONS SPECIFICATION LIMITS: FCC 15.207; FCC 15.107(a), RSS GEN**

The table below shows the limits for the emissions on the AC power line from an intentional radiator and a receiver.

Frequency (MHz)	Average Limit (dBuV)	Quasi Peak Limit (dBuV)
0.150 to 0.500	Linear decrease on logarithmic frequency axis between 56.0 and 46.0	Linear decrease on logarithmic frequency axis between 66.0 and 56.0
0.500 to 5.000	46.0	56.0
5.000 to 30.000	50.0	60.0

**GENERAL TRANSMITTER RADIATED EMISSIONS SPECIFICATION LIMITS**

The table below shows the limits for the spurious emissions from transmitters that fall in restricted bands<sup>1</sup>.

Frequency Range (MHz)	Limit (uV/m)	Limit (dBuV/m @ 3m)
0.009-0.490	$2400/F_{\text{KHz}} @ 300\text{m}$	$67.6-20*\log_{10}(F_{\text{KHz}}) @ 300\text{m}$
0.490-1.705	$24000/F_{\text{KHz}} @ 30\text{m}$	$87.6-20*\log_{10}(F_{\text{KHz}}) @ 30\text{m}$
1.705 to 30	30 @ 30m	29.5 @ 30m
30 to 88	100 @ 3m	40 @ 3m
88 to 216	150 @ 3m	43.5 @ 3m
216 to 960	200 @ 3m	46.0 @ 3m
Above 960	500 @ 3m	54.0 @ 3m

<sup>1</sup> The restricted bands are detailed in FCC 15.205 and RSS-Gen Table 6

**OUTPUT POWER LIMITS – DIGITAL TRANSMISSION SYSTEMS**

The table below shows the limits for output power and output power density. Where the signal bandwidth is less than 20 MHz the maximum output power is reduced to the power spectral density limit plus 10 times the log of the bandwidth (in MHz).

Operating Frequency (MHz)	Output Power	Power Spectral Density
902 – 928	1 Watt (30 dBm)	8 dBm/3kHz
2400 – 2483.5	1 Watt (30 dBm)	8 dBm/3kHz
5725 – 5850	1 Watt (30 dBm)	8 dBm/3kHz

The maximum permitted output power is reduced by 1dB for every dB the antenna gain exceeds 6dBi. Fixed point-to-point applications using the 5725 – 5850 MHz band are not subject to this restriction.

**TRANSMIT MODE SPURIOUS RADIATED EMISSIONS LIMITS – FHSS and DTS SYSTEMS**

The limits for unwanted (spurious) emissions from the transmitter falling in the restricted bands are those specified in the general limits sections of FCC Part 15 and RSS 210. All other unwanted (spurious) emissions shall be at least 20dB below the level of the highest in-band signal level (30dB if the power is measured using the sample detector/power averaging method).

**SAMPLE CALCULATIONS - CONDUCTED EMISSIONS**

Receiver readings are compared directly to the conducted emissions specification limit (decibel form) as follows:

$$R_r - S = M$$

where:

$R_r$  = Receiver Reading in dBuV

S = Specification Limit in dBuV

M = Margin to Specification in +/- dB

**SAMPLE CALCULATIONS - RADIATED EMISSIONS**

Receiver readings are compared directly to the specification limit (decibel form). The receiver internally corrects for cable loss, preamplifier gain, and antenna factor. The calculations are in the reverse direction of the actual signal flow, thus cable loss is added and the amplifier gain is subtracted. The Antenna Factor converts the voltage at the antenna coaxial connector to the field strength at the antenna elements.

A distance factor, when used for electric field measurements above 30MHz, is calculated by using the following formula:

$$F_d = 20 * \text{LOG}_{10} (D_m/D_s)$$

where:

$F_d$  = Distance Factor in dB

$D_m$  = Measurement Distance in meters

$D_s$  = Specification Distance in meters

For electric field measurements below 30MHz the extrapolation factor is either determined by making measurements at multiple distances or a theoretical value is calculated using the formula:

$$F_d = 40 * \text{LOG}_{10} (D_m/D_s)$$

Measurement Distance is the distance at which the measurements were taken and Specification Distance is the distance at which the specification limits are based. The antenna factor converts the voltage at the antenna coaxial connector to the field strength at the antenna elements.

The margin of a given emission peak relative to the limit is calculated as follows:

$$R_c = R_r + F_d$$

and

$$M = R_c - L_s$$

where:

$R_r$  = Receiver Reading in dBuV/m

$F_d$  = Distance Factor in dB

$R_c$  = Corrected Reading in dBuV/m

$L_s$  = Specification Limit in dBuV/m

M = Margin in dB Relative to Spec

**SAMPLE CALCULATIONS - FIELD STRENGTH TO EIRP CONVERSION**

Where the radiated electric field strength is expressed in terms of the equivalent isotropic radiated power (eirp), or where a field strength measurement of output power is made in lieu of a direct measurement, the following formula is used to convert between eirp and field strength at a distance of d (meters) from the equipment under test:

$$E = \frac{1000000 \sqrt{30 P}}{d} \quad \text{microvolts per meter}$$

where P is the eirp (Watts)

For a measurement at 3m the conversion from a logarithmic value for field strength (dBuV/m) to an eirp power (dBm) is -95.3dB.

## Appendix A Test Equipment Calibration Data

<u>Manufacturer</u>	<u>Description</u>	<u>Model</u>	<u>Asset #</u>	<u>Calibrated</u>	<u>Cal Due</u>
<b>Radio Antenna Port (Power and Duty Cycle), 12-Feb-16</b>					
Rohde & Schwarz	Power Meter, Single Channel	NRVS	1290	12/17/2015	12/17/2016
Agilent Technologies	3Hz -44GHz PSA Spectrum Analyzer	E4446A	2796	3/31/2015	3/31/2016
Rohde & Schwarz	Peak Power Sensor 100 uW - 2 Watts use with 20dB attenuator sn:1031.6959.00 only	NRV-Z32	3225	9/24/2015	9/24/2016
<b>Radio Antenna Port, 06-Apr-16</b>					
Agilent Technologies	PSA, Spectrum Analyzer, (installed options, 111, 115, 123, 1DS, B7J, HX,	E4446A	2139	6/22/2015	6/22/2016
<b>Radiated Emissions, Band Edge, 11-Apr-16</b>					
EMCO	Antenna, Horn, 1-18 GHz	3115	1561	6/27/2014	6/27/2016
Rohde & Schwarz	EMI Test Receiver, 20 Hz-7 GHz	ESIB7	1756	6/20/2015	6/20/2016
<b>Radiated Emissions, 1000 - 25,000 MHz, 11-Apr-16</b>					
Hewlett Packard	Microwave Preamplifier, 1-26.5GHz	8449B	870	1/21/2016	1/21/2017
HP / Miteq	SA40 Head (Red)	TTA1840-45-5P-HG-S	1145	7/17/2015	7/17/2016
Hewlett Packard	Spectrum Analyzer (SA40) Red 30 Hz -40 GHz	8564E (84125C)	1148	10/17/2015	10/17/2016
Hewlett Packard	High Pass filter, 8.2 GHz	P/N 84300-80039	1152	7/10/2015	7/10/2016
EMCO	Antenna, Horn, 1-18 GHz	3115	1561	6/27/2014	6/27/2016
Micro-Tronics	Band Reject Filter, 2400-2500 MHz	BRM50702-02	1683	7/13/2015	7/13/2016
A. H. Systems	Purple System Horn, 18-40GHz	SAS-574, p/n: 2581	2160	8/28/2014	8/28/2017
<b>Conducted Emissions - AC Power Ports, 12-Apr-16</b>					
Rohde & Schwarz	EMI Test Receiver, 20 Hz-7 GHz	ESIB7	1538	12/19/2015	12/19/2016
Rohde & Schwarz	Pulse Limiter	ESH3 Z2	1594	5/14/2015	5/14/2016
Fischer Custom Comm	LISN, 25A, 150kHz to 30MHz, 25 Amp,	FCC-LISN-50-25-2-09	2000	8/18/2015	9/18/2016
Fischer Custom Comm	LISN, 25A, 150kHz to 30MHz, 25 Amp,	FCC-LISN-50-25-2-09	2001	7/24/2015	7/24/2016
<b>Radiated Emissions, 30 - 1,000 MHz, 12-Apr-16</b>					
Rohde & Schwarz	EMI Test Receiver, 20 Hz-7 GHz	ESIB7	1538	12/19/2015	12/19/2016
Sunol Sciences	Biconilog, 30-3000 MHz	JB3	1549	6/2/2015	6/2/2017
Hewlett Packard	9KHz-1300MHz pre-amp	8447F	2777	1/26/2016	1/26/2017
<b>Radio Antenna Port (Power and Spurious Emissions), 13-Apr-16</b>					
Agilent Technologies	PSA, Spectrum Analyzer, (installed options, 111, 115, 123, 1DS, B7J, HX,	E4446A	2139	6/22/2015	6/22/2016



<u>Manufacturer</u>	<u>Description</u>	<u>Model</u>	<u>Asset #</u>	<u>Calibrated</u>	<u>Cal Due</u>
Agilent Technologies	USB Average Power Sensor	U2001A	2442	1/6/2016	1/6/2017
<b>Conducted Emissions - AC Power Ports, 19-Apr-16</b>					
EMCO	LISN, 10 kHz-100 MHz	3825/2	1292	7/24/2015	7/24/2016
Rohde & Schwarz	Pulse Limiter	ESH3 Z2	1594	5/14/2015	5/14/2016
Rohde & Schwarz	EMI Test Receiver, 20 Hz-7 GHz	ESIB7	1756	6/20/2015	6/20/2016
Fischer Custom Comm	LISN, 25A, 150kHz to 30MHz, 25 Amp,	FCC-LISN-50-25-2-09	2001	7/24/2015	7/24/2016



## **Appendix B Test Data**

T101416 Pages 26 – 80



## ***EMC Test Data***

Client:	Barracuda Networks	Job Number:	JD99428
Product	BNHW028 (Dome)	T-Log Number:	T101416
System Configuration:	-	Project Manager:	Christine Krebill
Contact:	Gary Liu	Project Coordinator:	
Emissions Standard(s):	FCC part 15, RSS-247	Class:	N/A
Immunity Standard(s):		Environment:	Radio

# **EMC Test Data**

For The

## **Barracuda Networks**

Product

**BNHW028 (Dome)**

Date of Last Test: 6/2/2016



# EMC Test Data

Client: Barracuda Networks	Job Number: JD99428
Model: BNHW028 (Dome)	T-Log Number: T101416
	Project Manager: Christine Krebill
Contact: Gary Liu	Project Coordinator: -
Standard: FCC part 15, RSS-247	Class: N/A

## Power vs. Data Rate

In normal operating modes the card uses power settings stored on EEPROM to set the output power. For a given nominal output power the actual transmit power normally is reduced as the data rate increases, therefore testing was performed at the data rate in the mode with highest power to determine compliance with the requirements.

The following power measurements were made using a spectrum analyzer power measurement mode and with the device configured in a continuous transmit mode on Chain 1 at the various data rates in each mode to verify the highest power mode:

### Sample Notes

Sample S/N: 00:25:19:06:99:20

Driver: iwpriv

Date of Test: 4/6/2016

Test Engineer: David Bare

Test Location: Fremont EMC lab #4B

3.2 dBi antenna

Mode	Data Rate	Power (dBm)	Power setting
802.11b	1	16.6	21.0
	2	16.5	
	5.5	16.7	
	11	<b>16.7</b>	
802.11g	6	<b>17.9</b>	21.0
	9	17.7	
	12	17.8	
	18	17.7	
	24	16.9	
	36	16.6	
	48	16.4	
	54	16.2	



# EMC Test Data

Client: Barracuda Networks	Job Number: JD99428
Model: BNHW028 (Dome)	T-Log Number: T101416
	Project Manager: Christine Krebill
Contact: Gary Liu	Project Coordinator: -
Standard: FCC part 15, RSS-247	Class: N/A

Mode	Data Rate	Power (dBm)	Power setting
802.11n 20MHz	6.5	<b>17.9</b>	21.0
	13	17.6	
	19.5	17.5	
	26	17.4	
	39	16.5	
	52	16.2	
	58.5	16.1	
	65	15.9	
	78	N/A	

<<-11ac mode only

Note : Power setting - the software power setting used during testing, included for reference only.

## Duty Cycle

Date of Test: 2/12/2016  
 Test Engineer: David Bare  
 Test Location: Fremont EMC Lab #4A

Duty cycle measurements performed on the worse case data rate for power.

Notes: Measurements taken with maximum RBW/VBW settings allowed.

Mode	Data Rate	Duty Cycle (x)	Constant DC?	T (ms)	Pwr Cor Factor*	Lin Volt Cor Factor**	Min VBW for FS (Hz)
11b	1 Mbps	0.99	Yes	18.677	0	0	54
11b	11 Mbps	0.90	Yes	1.878	0.5	0.9	532
11g	6 Mbps	0.94	Yes	3.095	0.3	0.6	323
11g	54 Mbps	0.64	Yes	0.357	1.9	3.8	2801
n20	6.5 Mbps	0.93	Yes	2.857	0.3	0.6	350
n20	65 Mbps	0.62	Yes	0.317	2.1	4.2	3155

\* Correction factor when using RMS/Power averaging -  $10 \cdot \log(1/x)$

\*\* Correction factor when using linear voltage average -  $20 \cdot \log(1/x)$

T = Minimum transmission duration

Client: Barracuda Networks	Job Number: JD99428
Model: BNHW028 (Dome)	T-Log Number: T101416
Contact: Gary Liu	Project Manager: Christine Krebill
Standard: FCC part 15, RSS-247	Project Coordinator: -
	Class: N/A

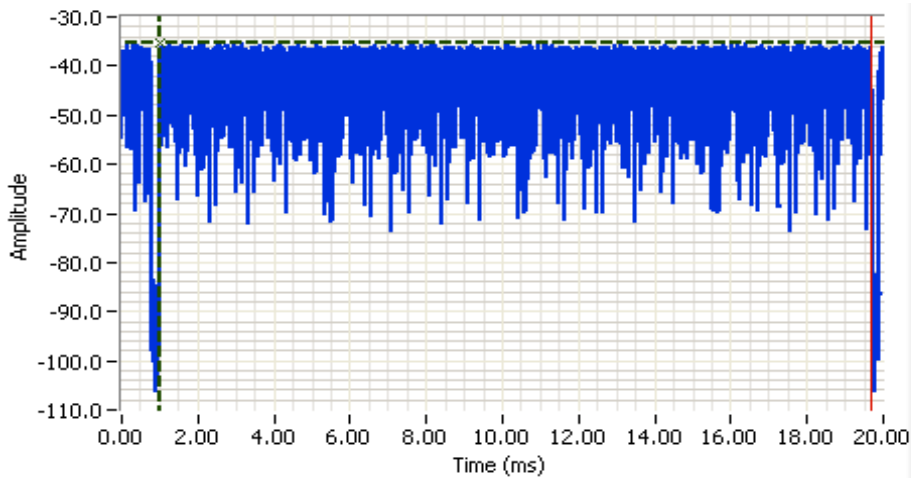

**Analyzer Settings**

Agilent Technologies, E4446A  
 CF: 2412.000 MHz  
 SPAN: 0.000 MHz  
 RB: 180 kHz  
 VB: 180 kHz  
 Detector: Normal  
 Attn: 10 DB  
 RL Offset: 0.0 DB  
 Sweep Time: 20.0ms  
 Ref Lvl: 0.0 DBM

**Comments**

802.11b 1 Mbps duty cycle

Cursor 1 1.0053 -35.5  Delta Time (ms) 18.677

Cursor 1 19.6825 0.0  Delta Amplitude 35.5

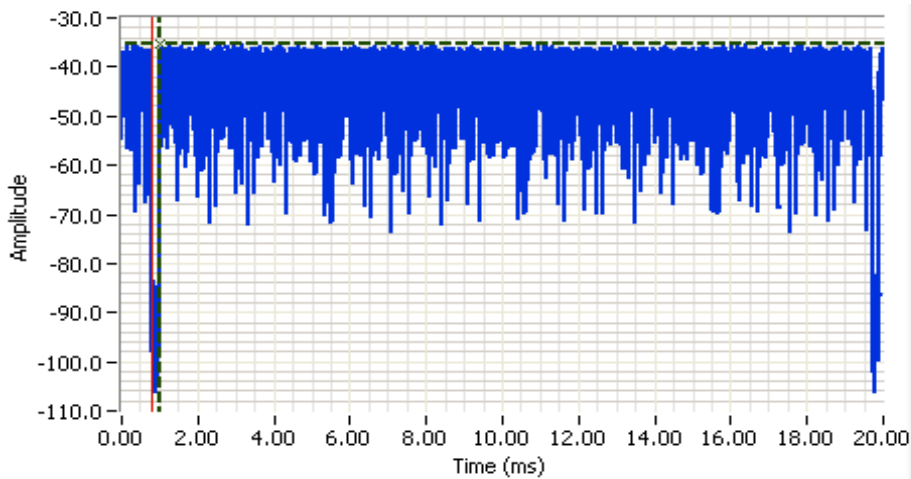

**Analyzer Settings**

Agilent Technologies, E4446A  
 CF: 2412.000 MHz  
 SPAN: 0.000 MHz  
 RB: 180 kHz  
 VB: 180 kHz  
 Detector: Normal  
 Attn: 10 DB  
 RL Offset: 0.0 DB  
 Sweep Time: 20.0ms  
 Ref Lvl: 0.0 DBM

**Comments**

802.11b 1 Mbps duty cycle

Cursor 1 0.9841 -35.5  Delta Time (ms) 0.190

Cursor 1 0.7937 0.0  Delta Amplitude 35.5



Client: Barracuda Networks	Job Number: JD99428
Model: BNHW028 (Dome)	T-Log Number: T101416
Contact: Gary Liu	Project Manager: Christine Krebill
Standard: FCC part 15, RSS-247	Project Coordinator: -
	Class: N/A

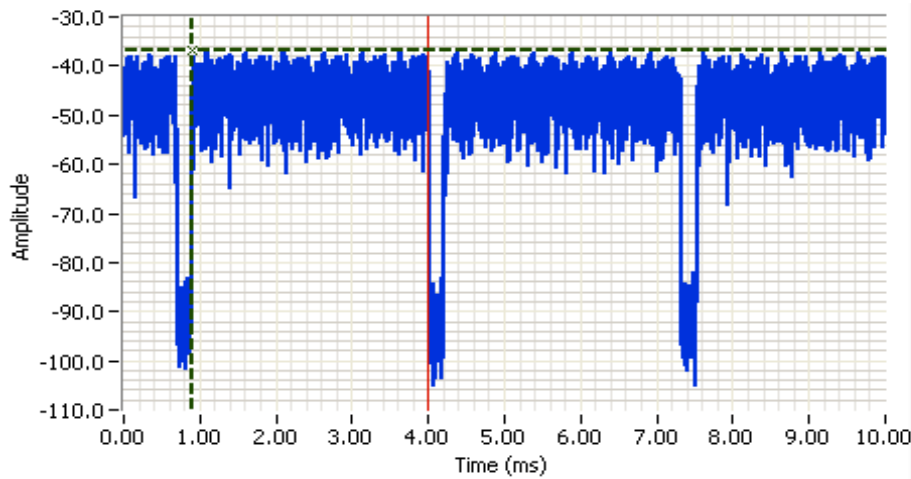

**Analyzer Settings**

Agilent Technologies, E4446A  
 CF: 2412.000 MHz  
 SPAN: 0.000 MHz  
 RB: 180 kHz  
 VB: 180 kHz  
 Detector: Normal  
 Attn: 10 DB  
 RL Offset: 0.0 DB  
 Sweep Time: 10.0ms  
 Ref Lvl: 0.0 DBM

**Comments**

802.11g 6 Mbps duty cycle

Cursor 1 0.8995 -37.0  Delta Time (ms) 3.095

Cursor 1 3.9947 0.0  Delta Amplitude 37.0

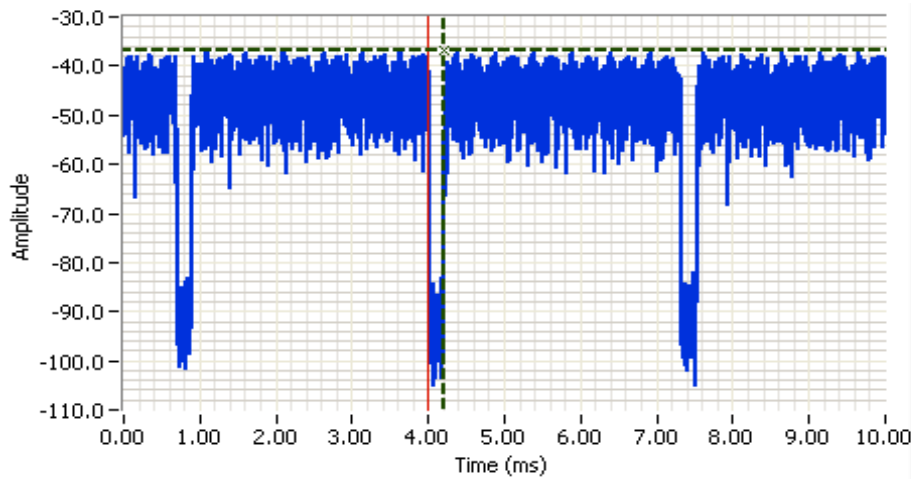

**Analyzer Settings**

Agilent Technologies, E4446A  
 CF: 2412.000 MHz  
 SPAN: 0.000 MHz  
 RB: 180 kHz  
 VB: 180 kHz  
 Detector: Normal  
 Attn: 10 DB  
 RL Offset: 0.0 DB  
 Sweep Time: 10.0ms  
 Ref Lvl: 0.0 DBM

**Comments**

802.11g 6 Mbps duty cycle

Cursor 1 4.2063 -37.0  Delta Time (ms) 0.212

Cursor 1 3.9947 0.0  Delta Amplitude 37.0



Client: Barracuda Networks	Job Number: JD99428
Model: BNHW028 (Dome)	T-Log Number: T101416
Contact: Gary Liu	Project Manager: Christine Krebill
Standard: FCC part 15, RSS-247	Project Coordinator: -
	Class: N/A

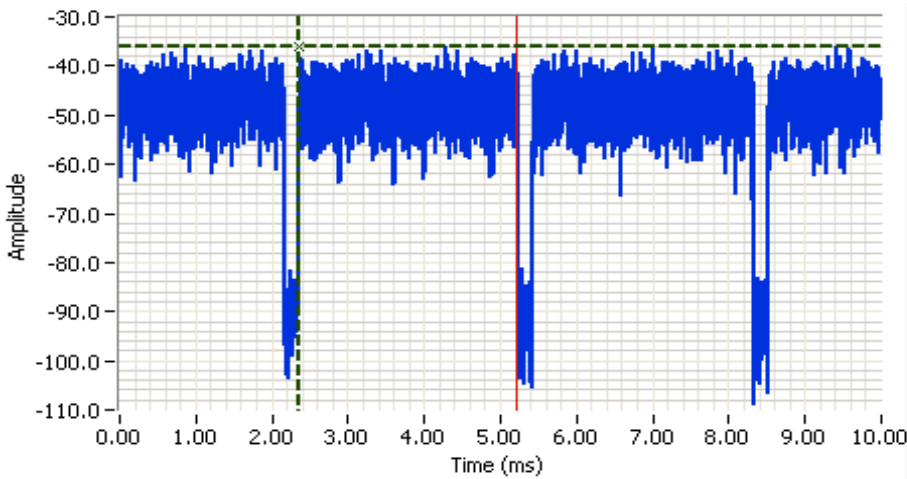

**Analyzer Settings**  
 Agilent Technologies, E4446A  
 CF: 2412.000 MHz  
 SPAN: 0.000 MHz  
 RB: 180 kHz  
 VB: 180 kHz  
 Detector: Normal  
 Attn: 10 DB  
 RL Offset: 0.0 DB  
 Sweep Time: 10.0ms  
 Ref Lvl: 0.0 DBM

**Comments**  
 802.11n 6.5 Mbps duty cycle

Cursor 1 2.3545 -36.1 Delta Time (ms) 2.857

Cursor 1 5.2116 0.0 Delta Amplitude 36.1

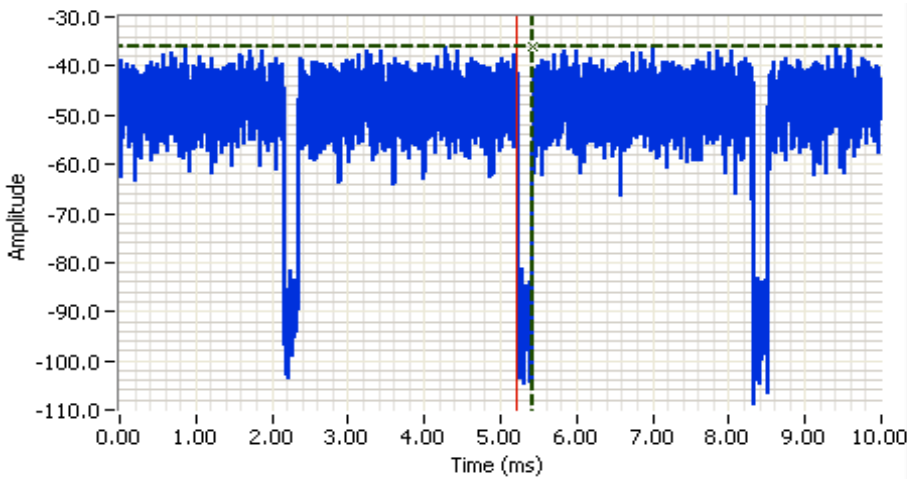

**Analyzer Settings**  
 Agilent Technologies, E4446A  
 CF: 2412.000 MHz  
 SPAN: 0.000 MHz  
 RB: 180 kHz  
 VB: 180 kHz  
 Detector: Normal  
 Attn: 10 DB  
 RL Offset: 0.0 DB  
 Sweep Time: 10.0ms  
 Ref Lvl: 0.0 DBM

**Comments**  
 802.11n 6.5 Mbps duty cycle

Cursor 1 5.4233 -36.1 Delta Time (ms) 0.212

Cursor 1 5.2116 0.0 Delta Amplitude 36.1



Client: Barracuda Networks	Job Number: JD99428
Model: BNHW028 (Dome)	T-Log Number: T101416
Contact: Gary Liu	Project Manager: Christine Krebill
Standard: FCC part 15, RSS-247	Project Coordinator: -
	Class: N/A

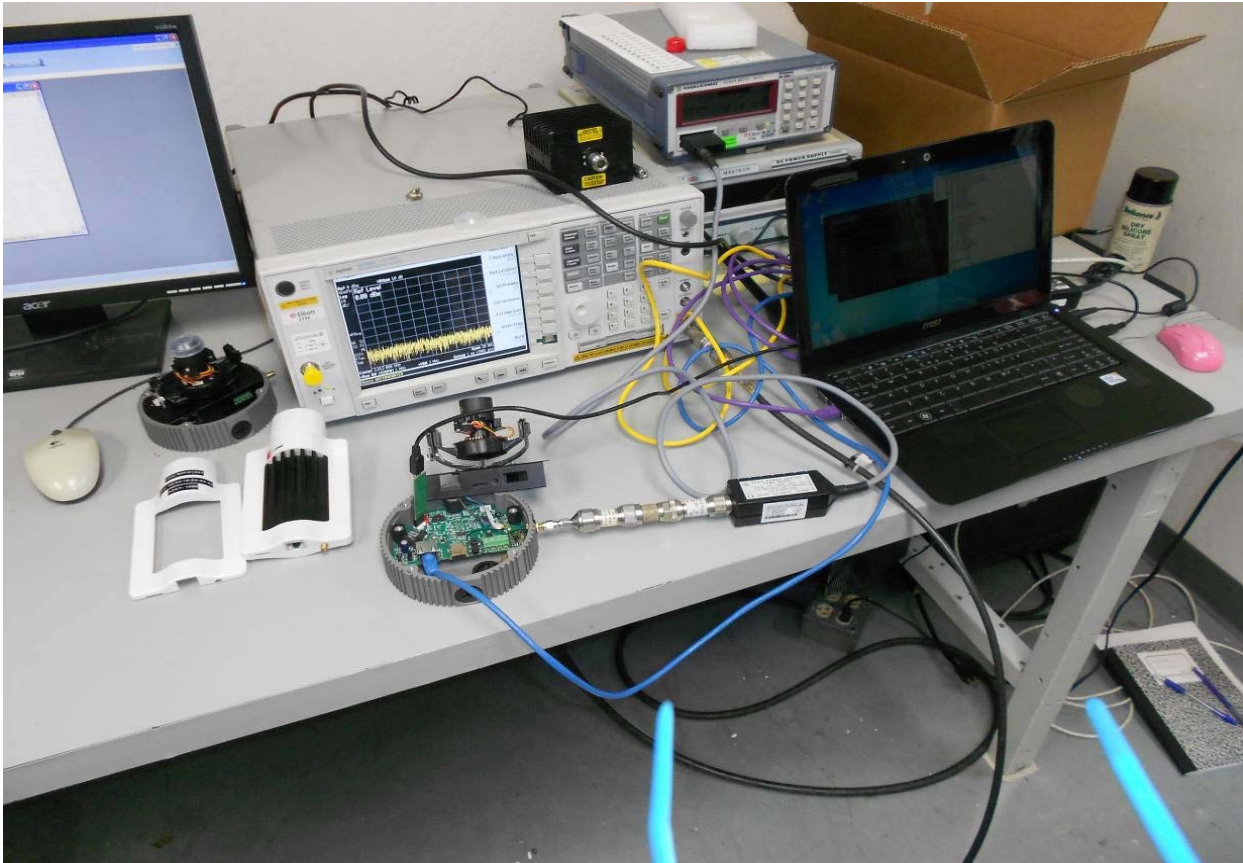





# EMC Test Data

Client: Barracuda Networks	Job Number: JD99428
Model: BNHW028 (Dome)	T-Log Number: T101416
	Project Manager: Christine Krebill
Contact: Gary Liu	Project Coordinator: -
Standard: FCC part 15, RSS-247	Class: N/A

## Conducted Emissions

*(NTS Silicon Valley, Fremont Facility, Semi-Anechoic Chamber)*

### Test Specific Details

Objective: The objective of this test session is to perform final qualification testing of the EUT with respect to the specification listed above.

Date of Test: 4/19/2016	Config. Used: 2
Test Engineer: David Bare	Config Change: None
Test Location: Fremont Chamber #5	Host Unit Voltage 120V/60Hz

### General Test Configuration

For tabletop equipment, the EUT was located on a table inside the semi-anechoic chamber, 40 cm from a vertical coupling plane and 80cm from the LISN. A second LISN was used for all local support equipment. Remote support equipment was located outside of the semi-anechoic chamber. Any cables running to remote support equipment were routed through metal conduit and when possible passed through a ferrite clamp upon exiting the chamber.

**Ambient Conditions:**

Temperature:	23 °C
Rel. Humidity:	35 %

### Summary of Results

Run #	Test Performed	Limit	Result	Margin
1	CE, AC Power, 120V/60Hz	FCC 15.207	Pass	48.4 dB $\mu$ V @ 0.516 MHz (-7.6 dB)

### Modifications Made During Testing

No modifications were made to the EUT during testing

### Deviations From The Standard

No deviations were made from the requirements of the standard.

Client: Barracuda Networks	Job Number: JD99428
Model: BNHW028 (Dome)	T-Log Number: T101416
Contact: Gary Liu	Project Manager: Christine Krebill
Standard: FCC part 15, RSS-247	Project Coordinator: -
	Class: N/A

**Run #1: AC Power Port Conducted Emissions, 0.15 - 30MHz, 120V/60Hz, 802.11g, channel 6**

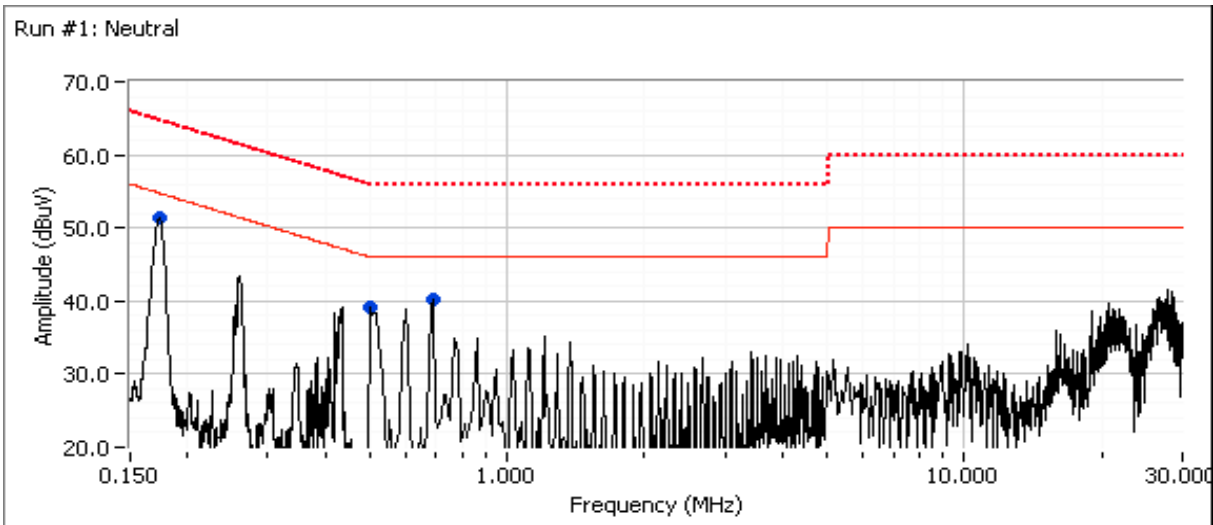
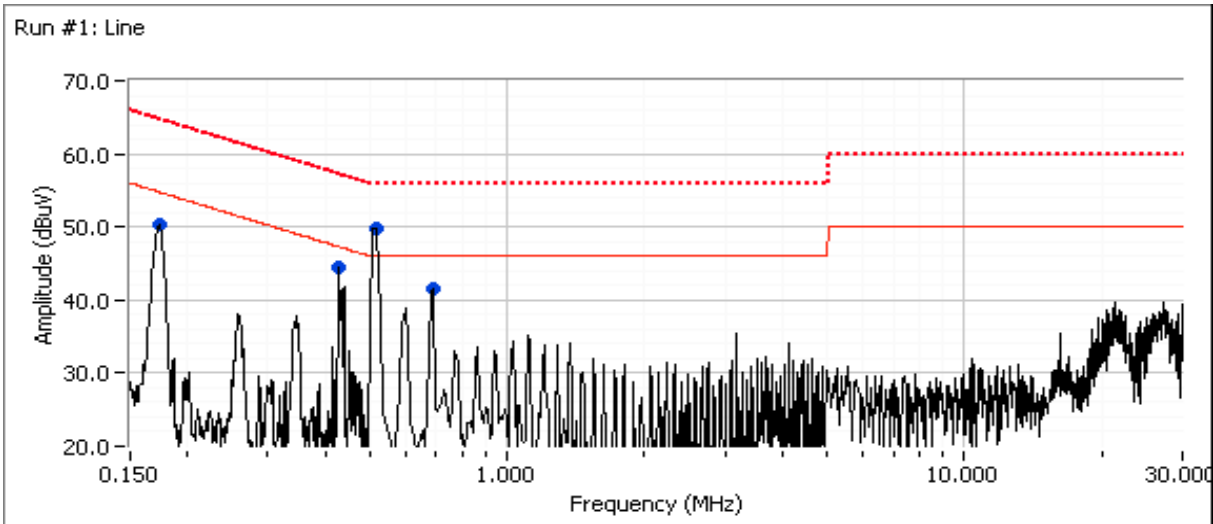



# EMC Test Data

Client: Barracuda Networks	Job Number: JD99428
Model: BNHW028 (Dome)	T-Log Number: T101416
	Project Manager: Christine Krebill
Contact: Gary Liu	Project Coordinator: -
Standard: FCC part 15, RSS-247	Class: N/A

### Final quasi-peak and average readings

Frequency MHz	Level dB $\mu$ V	AC Line	FCC 15.207		Detector QP/Ave	Comments
			Limit	Margin		
0.173	45.4	Neutral	54.8	-9.4	AVG	AVG (0.10s)
0.173	50.0	Neutral	64.8	-14.8	QP	QP (1.00s)
0.516	35.4	Neutral	46.0	-10.6	AVG	AVG (0.10s)
0.516	48.4	Neutral	56.0	-7.6	QP	QP (1.00s)
0.688	34.8	Neutral	46.0	-11.2	AVG	AVG (0.10s)
0.688	39.8	Neutral	56.0	-16.2	QP	QP (1.00s)
0.172	45.5	Line 1	54.9	-9.4	AVG	AVG (0.10s)
0.172	50.3	Line 1	64.9	-14.6	QP	QP (1.00s)
0.429	32.9	Line 1	47.3	-14.4	AVG	AVG (0.10s)
0.429	45.1	Line 1	57.3	-12.2	QP	QP (1.00s)
0.513	34.2	Line 1	46.0	-11.8	AVG	AVG (0.10s)
0.513	47.2	Line 1	56.0	-8.8	QP	QP (1.00s)
0.688	36.3	Line 1	46.0	-9.7	AVG	AVG (0.10s)
0.688	41.2	Line 1	56.0	-14.8	QP	QP (1.00s)

Note 1: -



# EMC Test Data

Client:	Barracuda Networks	Job Number:	JD99428
Model:	BNHW028 (Dome)	T-Log Number:	T101416
		Project Manager:	Christine Krebill
Contact:	Gary Liu	Project Coordinator:	-
Standard:	FCC part 15, RSS-247	Class:	N/A

## Radiated Emissions

(NTS Silicon Valley, Fremont Facility, Semi-Anechoic Chamber)

### Test Specific Details

Objective: The objective of this test session is to perform final qualification testing of the EUT with respect to the specification listed above.

Date of Test: 4/12/2016	Config. Used: 1
Test Engineer: Rafael Varelas	Config Change: Yes
Test Location: Fremont Chamber #7	EUT Voltage: 120V/60Hz

### General Test Configuration

The EUT and any local support equipment were located on the turntable for radiated emissions testing. Any remote support equipment was located outside the semi-anechoic chamber. Any cables running to remote support equipment were routed through metal conduit and when possible passed through a ferrite clamp upon exiting the chamber.

Radiated emissions tests above 1 GHz to FCC Part 15 were performed with floor absorbers in place in accordance with the test methods of ANSI C63.4 and CISPR 16-1-4.

The test distance and extrapolation factor (if applicable) are detailed under each run description.

Note, preliminary testing indicates that the emissions were maximized by orientation of the EUT and elevation of the measurement antenna. Maximized testing indicated that the emissions were maximized by orientation of the EUT, elevation of the measurement antenna, and manipulation of the EUT's interface cables.

### Ambient Conditions:

Temperature:	21.8 °C
Rel. Humidity:	36 %

### Summary of Results

Run #	Test Performed	Limit	Result	Margin
2 - ch 1, b mode	Radiated Emissions 30 - 1000 MHz, Maximized	Class B	Pass	45.5 dBµV/m @ 250.01 MHz (-0.5 dB)
4 - ch6, n20 mode	Radiated Emissions 30 - 1000 MHz, Maximized	Class B	Pass	45.2 dBµV/m @ 250.00 MHz (-0.8 dB)

### Modifications Made During Testing

No modifications were made to the EUT during testing

### Deviations From The Standard

No deviations were made from the requirements of the standard.

Client: Barracuda Networks	Job Number: JD99428
Model: BNHW028 (Dome)	T-Log Number: T101416
Contact: Gary Liu	Project Manager: Christine Krebill
Standard: FCC part 15, RSS-247	Project Coordinator: -
	Class: N/A

### Run #1: Preliminary Radiated Emissions, 30 - 1000 MHz

Test Parameters for Preliminary Scan(s)			
Frequency Range (MHz)	Prescan Distance (meters)	Limit Distance (meters)	Extrapolation Factor (dB, applied to data)
30 - 1000	3	3	0.0

Channel: 1                      Mode: b                      Power setting = 21  
 Tx Chain: Main                Data Rate: 11mbps

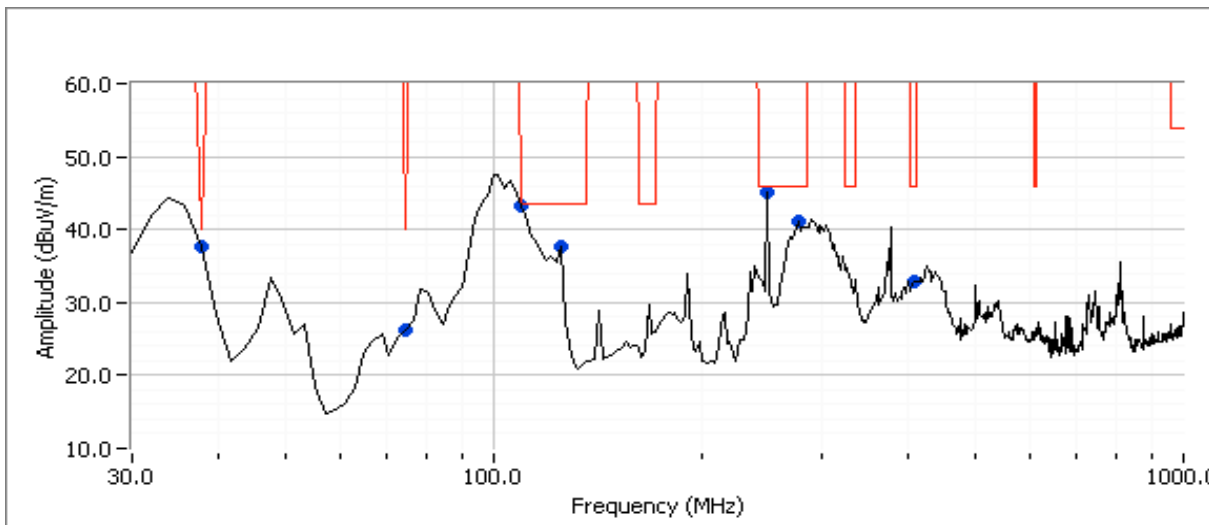

### Preliminary peak readings captured during pre-scan

Frequency MHz	Level dB $\mu$ V/m	Pol v/h	Class B		Detector Pk/QP/Avg	Azimuth degrees	Height meters	Comments
			Limit	Margin				
37.662	37.7	V	40.0	-2.3	Peak	32	1.0	
109.072	43.2	V	43.5	-0.3	Peak	182	1.0	
125.008	37.6	V	43.5	-5.9	Peak	353	1.0	
250.006	45.1	V	46.0	-0.9	Peak	17	1.0	
277.585	41.2	V	46.0	-4.8	Peak	17	1.0	
75.082	26.3	V	40.0	-13.7	Peak	333	1.0	
405.959	32.8	V	46.0	-13.2	Peak	243	1.5	

Client:	Barracuda Networks	Job Number:	JD99428
Model:	BNHW028 (Dome)	T-Log Number:	T101416
Contact:	Gary Liu	Project Manager:	Christine Krebill
Standard:	FCC part 15, RSS-247	Project Coordinator:	-
		Class:	N/A

**Preliminary quasi-peak readings (no manipulation of EUT interface cables)**

Frequency MHz	Level dB $\mu$ V/m	Pol v/h	Class B		Detector Pk/QP/Avg	Azimuth degrees	Height meters	Comments
			Limit	Margin				
250.006	45.5	V	46.0	-0.5	QP	17	1.0	QP (1.00s)
277.585	38.3	V	46.0	-7.7	QP	17	1.2	QP (1.00s)
37.662	32.2	V	40.0	-7.8	QP	32	1.0	QP (1.00s)
109.072	39.7	V	43.5	-3.8	QP	170	1.0	QP (1.00s)
405.959	32.8	V	46.0	-13.2	QP	232	1.4	QP (1.00s)
75.082	21.2	V	40.0	-18.8	QP	333	1.0	QP (1.00s)
125.008	35.1	V	43.5	-8.4	QP	360	1.0	QP (1.00s)

**Run #2: Maximized Readings From Run #1**

Test Parameters for Maximized Reading(s)			
Frequency Range (MHz)	Test Distance (meters)	Limit Distance (meters)	Extrapolation Factor (dB, applied to data)
30 - 1000	3	3	0.0

**Maximized quasi-peak readings (includes manipulation of EUT interface cables)**

Frequency MHz	Level dB $\mu$ V/m	Pol v/h	Class B		Detector Pk/QP/Avg	Azimuth degrees	Height meters	Comments
			Limit	Margin				
<b>250.006</b>	<b>45.5</b>	V	46.0	<b>-0.5</b>	QP	17	1.0	QP (1.00s)
109.072	39.7	V	43.5	-3.8	QP	170	1.0	QP (1.00s)
277.585	38.3	V	46.0	-7.7	QP	17	1.2	QP (1.00s)
37.662	32.2	V	40.0	-7.8	QP	32	1.0	QP (1.00s)
125.008	35.1	V	43.5	-8.4	QP	360	1.0	QP (1.00s)
405.959	32.8	V	46.0	-13.2	QP	232	1.4	QP (1.00s)

Client: Barracuda Networks	Job Number: JD99428
Model: BNHW028 (Dome)	T-Log Number: T101416
Contact: Gary Liu	Project Manager: Christine Krebill
Standard: FCC part 15, RSS-247	Project Coordinator: -
	Class: N/A

### Run #3: Preliminary Radiated Emissions, 30 - 1000 MHz

Test Parameters for Preliminary Scan(s)			
Frequency Range (MHz)	Prescan Distance (meters)	Limit Distance (meters)	Extrapolation Factor (dB, applied to data)
30 - 1000	3	3	0.0

Channel: 6                      Mode: n20                      Power setting = 21  
 Tx Chain: Main                Data Rate: 6.5 mbps

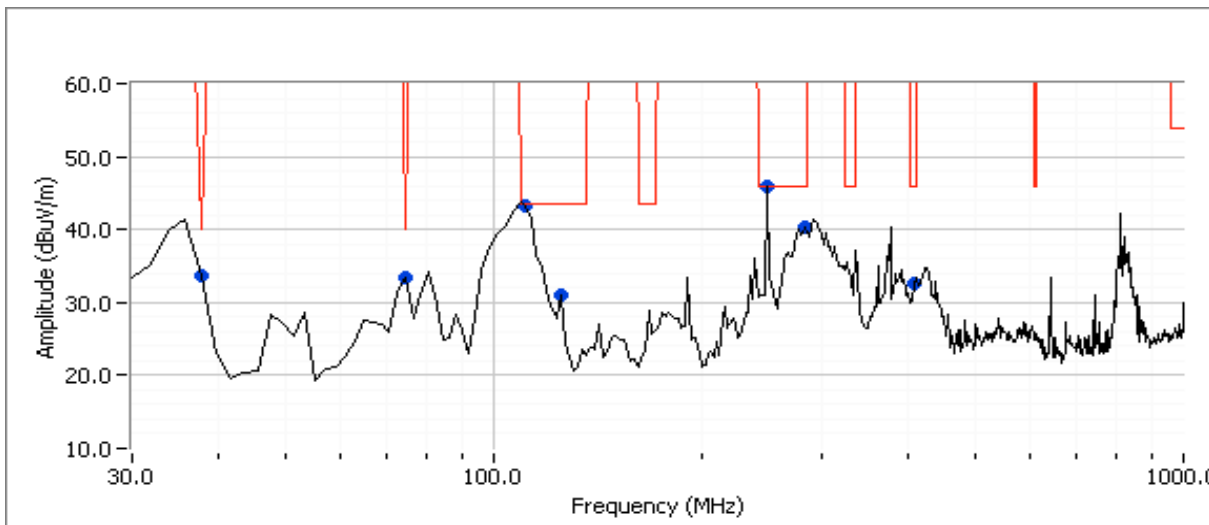

### Preliminary peak readings captured during pre-scan

Frequency MHz	Level dB $\mu$ V/m	Pol v/h	Class B		Detector Pk/QP/Avg	Azimuth degrees	Height meters	Comments
			Limit	Margin				
37.669	33.6	V	40.0	-6.4	Peak	258	1.0	
74.576	33.4	V	40.0	-6.6	Peak	187	1.0	
110.049	43.3	V	43.5	-0.2	Peak	273	1.0	
125.008	31.1	V	43.5	-12.4	Peak	360	1.0	
250.000	45.9	V	46.0	-0.1	Peak	102	1.0	
282.702	40.4	V	46.0	-5.6	Peak	97	1.0	
407.429	32.6	V	46.0	-13.4	Peak	232	1.0	

Client:	Barracuda Networks	Job Number:	JD99428
Model:	BNHW028 (Dome)	T-Log Number:	T101416
Contact:	Gary Liu	Project Manager:	Christine Krebill
Standard:	FCC part 15, RSS-247	Project Coordinator:	-
		Class:	N/A

**Preliminary quasi-peak readings (no manipulation of EUT interface cables)**

Frequency MHz	Level dB $\mu$ V/m	Pol v/h	Class B		Detector Pk/QP/Avg	Azimuth degrees	Height meters	Comments
			Limit	Margin				
125.008	30.6	V	43.5	-12.9	QP	360	1.0	QP (1.00s)
110.049	41.0	V	43.5	-2.5	QP	273	1.0	QP (1.00s)
37.669	29.9	V	40.0	-10.1	QP	258	1.0	QP (1.00s)
407.429	29.3	V	46.0	-16.7	QP	232	1.4	QP (1.00s)
74.576	32.1	V	40.0	-7.9	QP	187	1.0	QP (1.00s)
250.000	45.2	V	46.0	-0.8	QP	120	1.0	QP (1.00s)
282.702	39.1	V	46.0	-6.9	QP	97	1.0	QP (1.00s)

**Run #4: Maximized Readings From Run #3**

Test Parameters for Maximized Reading(s)			
Frequency Range (MHz)	Test Distance (meters)	Limit Distance (meters)	Extrapolation Factor (dB, applied to data)
30 - 1000	3	3	0.0

**Maximized quasi-peak readings (includes manipulation of EUT interface cables)**

Frequency MHz	Level dB $\mu$ V/m	Pol v/h	Class B		Detector Pk/QP/Avg	Azimuth degrees	Height meters	Comments
			Limit	Margin				
<b>250.000</b>	<b>45.2</b>	V	46.0	<b>-0.8</b>	QP	120	1.0	QP (1.00s)
110.049	41.0	V	43.5	-2.5	QP	273	1.0	QP (1.00s)
282.702	39.1	V	46.0	-6.9	QP	97	1.0	QP (1.00s)
74.576	32.1	V	40.0	-7.9	QP	187	1.0	QP (1.00s)
37.669	29.9	V	40.0	-10.1	QP	258	1.0	QP (1.00s)
125.008	30.6	V	43.5	-12.9	QP	360	1.0	QP (1.00s)
407.429	29.3	V	46.0	-16.7	QP	232	1.4	QP (1.00s)

Based on the results above, there are no differences in emissions from the radio on different frequencies or modes from 30-1000 MHz



Client: Barracuda Networks	Job Number: JD99428
Model: BNHW028 (Dome)	T-Log Number: T101416
	Project Manager: Christine Krebill
Contact: Gary Liu	Project Coordinator: -
Standard: FCC part 15, RSS-247	Class: N/A

## RSS-247 and FCC 15.247 (DTS) Radiated Spurious Emissions

### Test Specific Details

Objective: The objective of this test session is to perform final qualification testing of the EUT with respect to the specification listed above.

### General Test Configuration

The EUT and all local support equipment were located on the turntable for radiated spurious emissions testing. For radiated emissions testing the measurement antenna was located 3 meters from the EUT, unless otherwise noted.

### Ambient Conditions:

Temperature: 20-21 °C  
Rel. Humidity: 35-40 %

### Summary of Results - Device Operating in the 2400-2483.5 MHz Band

Run #	Mode	Channel	Target Power	Power Setting	Test Performed	Limit	Result / Margin
1	b	1 - 2412MHz	21	21	Restricted Band Edge (2390 MHz)	FCC Part 15.209 / 15.247( c)	45.3 dBµV/m @ 2389.3 MHz (-8.7 dB)
	b	11 - 2462MHz	21	21	Restricted Band Edge (2483.5 MHz)	FCC Part 15.209 / 15.247( c)	45.6 dBµV/m @ 2483.6 MHz (-8.4 dB)
2	g	1 - 2412MHz	21	13	Restricted Band Edge (2390 MHz)	FCC Part 15.209 / 15.247( c)	53.9 dBµV/m @ 2390.0 MHz (-0.1 dB)
	g	2 - 2417MHz	21	17	Restricted Band Edge (2390 MHz)	FCC Part 15.209 / 15.247( c)	53.9 dBµV/m @ 2389.8 MHz (-0.1 dB)
	g	3 - 2422MHz	21	21	Restricted Band Edge (2390 MHz)	FCC Part 15.209 / 15.247( c)	53.3 dBµV/m @ 2390.0 MHz (-0.7 dB)
	g	10 - 2457MHz	21	19	Restricted Band Edge (2483.5 MHz)	FCC Part 15.209 / 15.247( c)	53.6 dBµV/m @ 2484.0 MHz (-0.4 dB)
	g	11 - 2462MHz	21	16	Restricted Band Edge (2483.5 MHz)	FCC Part 15.209 / 15.247( c)	53.7 dBµV/m @ 2483.8 MHz (-0.3 dB)
3	n20	1 - 2412MHz	21	11	Restricted Band Edge (2390 MHz)	FCC Part 15.209 / 15.247( c)	73.9 dBµV/m @ 2389.8 MHz (-0.1 dB)
	n20	2 - 2417MHz	21	17	Restricted Band Edge (2390 MHz)	FCC Part 15.209 / 15.247( c)	53.7 dBµV/m @ 2390.0 MHz (-0.3 dB)
	n20	3 - 2422MHz	21	20	Restricted Band Edge (2390 MHz)	FCC Part 15.209 / 15.247( c)	53.3 dBµV/m @ 2390.0 MHz (-0.7 dB)
	n20	10 - 2457MHz	21	19	Restricted Band Edge (2483.5 MHz)	FCC Part 15.209 / 15.247( c)	53.9 dBµV/m @ 2483.8 MHz (-0.1 dB)
	n20	11 - 2462MHz	21	13	Restricted Band Edge (2483.5 MHz)	FCC Part 15.209 / 15.247( c)	73.2 dBµV/m @ 2483.6 MHz (-0.8 dB)

### Modifications Made During Testing

No modifications were made to the EUT during testing

### Deviations From The Standard

No deviations were made from the requirements of the standard.

### Sample Notes

Sample S/N: 00:25:19:06:99:20

Driver: iwpriv

Antenna: 3.2 dBi whip

### Procedure Comments:

Measurements performed in accordance with FCC KDB 558074

Peak measurements performed with: RBW=1MHz, VBW=3MHz, peak detector, max hold, auto sweep time

Unless otherwise stated/noted, emission has a duty cycle  $\geq 98\%$  and was measured using RBW=1MHz, VBW=10Hz, peak detector, linear average mode, auto sweep time, max hold.

Mode	Data Rate	Duty Cycle (x)	Constant DC?	T (ms)	Pwr Cor Factor*	Lin Volt Cor Factor**	Min VBW for FS (Hz)	VBW	# of Max Hold
11b	11 Mbps	0.90	Yes	1.878	0.5	0.9	532	1 kHz	65
11g	6 Mbps	0.94	Yes	3.095	0.3	0.6	323	500 Hz	62
n20	6.5 Mbps	0.93	Yes	2.857	0.3	0.6	350	500 Hz	62

### Measurement Specific Notes:

Note 1:	Emission in non-restricted band, but limit of 15.209 used.
Note 2:	Emission in non-restricted band, the limit was set 30dB below the level of the fundamental and measured in 100kHz.
Note 3:	Emission has a duty cycle $\geq 98\%$ , average measurement performed: RBW=1MHz, VBW=3MHz, RMS, Power averaging, auto sweep, trace average 100 traces
Note 4:	Emission has constant duty cycle $< 98\%$ , average measurement performed: RBW=1MHz, VBW $> 1/T$ , peak detector, linear averaging, auto sweep, max hold for at least 50 times (1/duty cycle) measurement corrected by Linear voltage correction factor.
Note 5:	Emission has constant duty cycle $< 98\%$ , average measurement performed: RBW=1MHz, VBW=3MHz, RMS, Power averaging, auto sweep, trace average 100 traces, measurement corrected by Pwr correction factor
Note 6:	Emission has non constant duty cycle $< 98\%$ , average measurement performed: RBW=1MHz, VBW $> 1/T$ , peak detector, linear average mode, sweep time auto, max hold. Max hold for $50*(1/DC)$ traces
Note 7:	Emission has non constant duty cycle $< 98\%$ , average measurement performed: RBW=1MHz, VBW $> 1/T$ , RMS detector, sweep time auto, max hold. Max hold for $50*(1/DC)$ traces
Note 8:	Plots of the average and peak bandedge do not account for any duty cycle correction. Refer to the tabular results for final measurements.

**Run #1: Radiated Bandedge Measurements**

Date of Test: 4/11/2015  
 Test Engineer: Deniz Demirci  
 Test Location: FT CH #5

Config. Used: 1  
 Config Change: None  
 EUT Voltage: POE

Channel: 1 Mode: b  
 Tx Chain: Main Data Rate: 11 Mbps

**Band Edge Signal Field Strength - Direct measurement of field strength**

Frequency	Level	Pol	15.209 / 15.247		Detector	Azimuth	Height	Comments
MHz	dB $\mu$ V/m	v/h	Limit	Margin	Pk/QP/Avg	degrees	meters	Note 4 for average (0.9 dB)
<b>2389.330</b>	<b>45.3</b>	V	54.0	<b>-8.7</b>	Avg	29	1.6	POS; RB 1 MHz; VB: 1 kHz
2385.560	56.7	V	74.0	-17.3	PK	29	1.6	POS; RB 1 MHz; VB: 3 MHz
2389.150	37.2	H	54.0	-16.8	Avg	33	1.4	POS; RB 1 MHz; VB: 1 kHz
2386.930	48.0	H	74.0	-26.0	PK	33	1.4	POS; RB 1 MHz; VB: 3 MHz

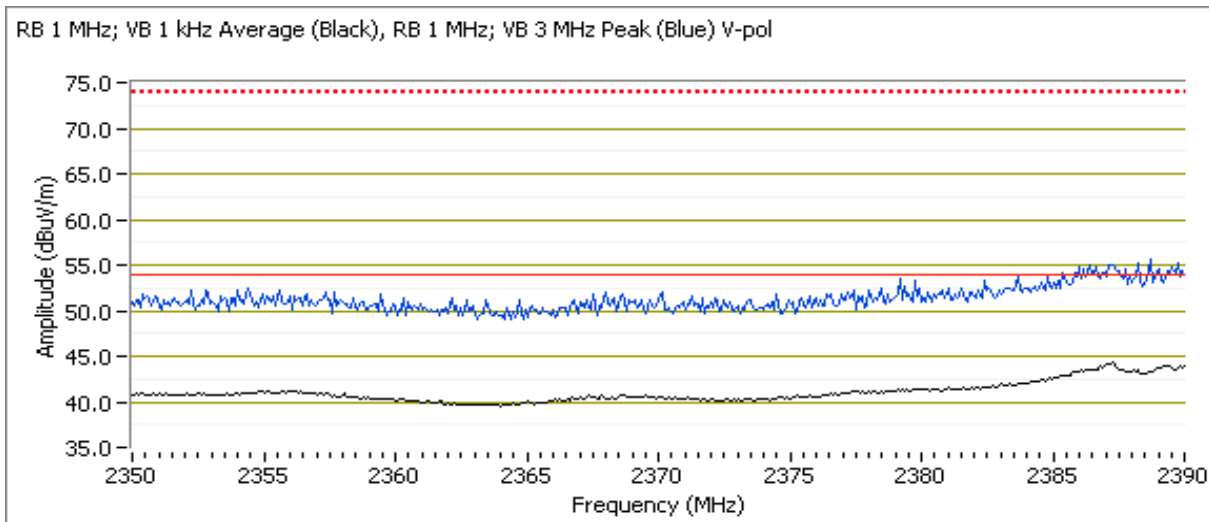

Channel: 11 Mode: b  
 Tx Chain: Main Data Rate: 11 Mbps

**Band Edge Signal Field Strength - Direct measurement of field strength**

Frequency	Level	Pol	15.209 / 15.247		Detector	Azimuth	Height	Comments
MHz	dB $\mu$ V/m	v/h	Limit	Margin	Pk/QP/Avg	degrees	meters	Note 4 for average (0.9 dB)
<b>2483.620</b>	<b>45.6</b>	V	54.0	<b>-8.4</b>	Avg	268	2.0	POS; RB 1 MHz; VB: 1 kHz
2483.860	57.1	V	74.0	-16.9	PK	268	2.0	POS; RB 1 MHz; VB: 3 MHz
2483.660	38.3	H	54.0	-15.7	Avg	70	1.8	POS; RB 1 MHz; VB: 1 kHz
2483.540	49.1	H	74.0	-24.9	PK	70	1.8	POS; RB 1 MHz; VB: 3 MHz

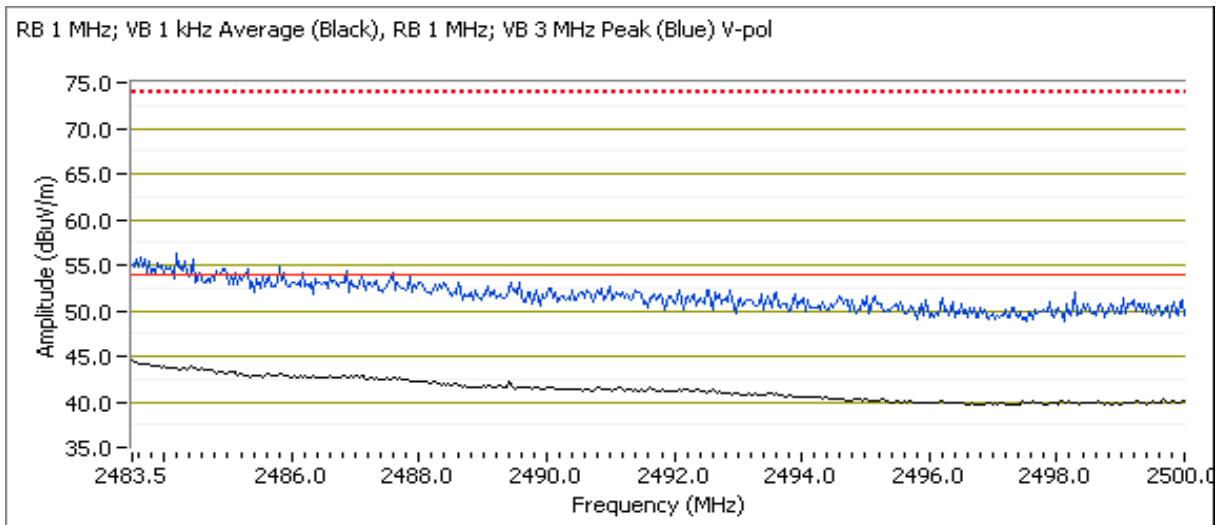

**Run #2: Radiated Bandedge Measurements**

Date of Test: 4/11/2015  
 Test Engineer: Deniz Demirci  
 Test Location: FT CH #5

Config. Used: 1  
 Config Change: None  
 EUT Voltage: POE

Channel: 1 Mode: g  
 Tx Chain: Main Data Rate: 6 Mbps

**Band Edge Signal Field Strength - Direct measurement of field strength**

Frequency	Level	Pol	15.209 / 15.247		Detector	Azimuth	Height	Comments
MHz	dB $\mu$ V/m	v/h	Limit	Margin	Pk/QP/Avg	degrees	meters	Note 4 for average (0.6 dB)
2390.000	53.9	V	54.0	-0.1	Avg	32	1.6	POS; RB 1 MHz; VB: 500 Hz
2389.600	70.5	V	74.0	-3.5	PK	32	1.6	POS; RB 1 MHz; VB: 3 MHz
2390.000	43.9	H	54.0	-10.1	Avg	49	1.7	POS; RB 1 MHz; VB: 500 Hz
2387.340	60.6	H	74.0	-13.4	PK	49	1.7	POS; RB 1 MHz; VB: 3 MHz

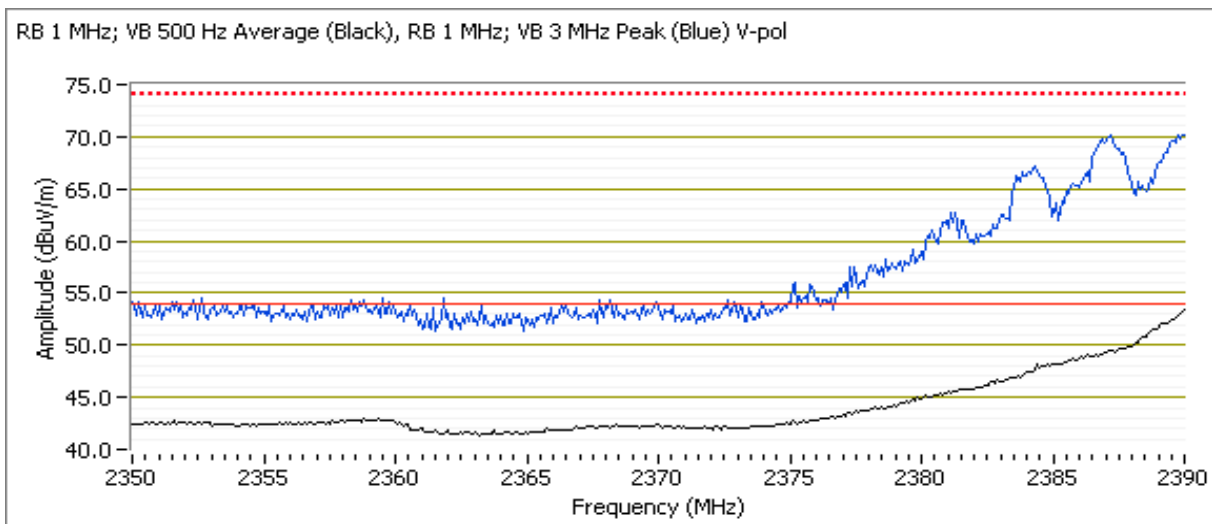

Channel: 2                      Mode: g  
 Tx Chain: Main                Data Rate: 6 Mbps

**Band Edge Signal Field Strength - Direct measurement of field strength**

Frequency MHz	Level dB $\mu$ V/m	Pol v/h	15.209 / 15.247		Detector PK/QP/Avg	Azimuth degrees	Height meters	Comments
			Limit	Margin				
2389.830	53.9	V	54.0	-0.1	Avg	32	1.2	Note 4 for average (0.6 dB) POS; RB 1 MHz; VB: 500 Hz
2389.540	68.9	V	74.0	-5.1	PK	32	1.2	POS; RB 1 MHz; VB: 3 MHz
2389.620	45.1	H	54.0	-8.9	Avg	43	1.4	POS; RB 1 MHz; VB: 500 Hz
2389.810	61.3	H	74.0	-12.7	PK	43	1.4	POS; RB 1 MHz; VB: 3 MHz

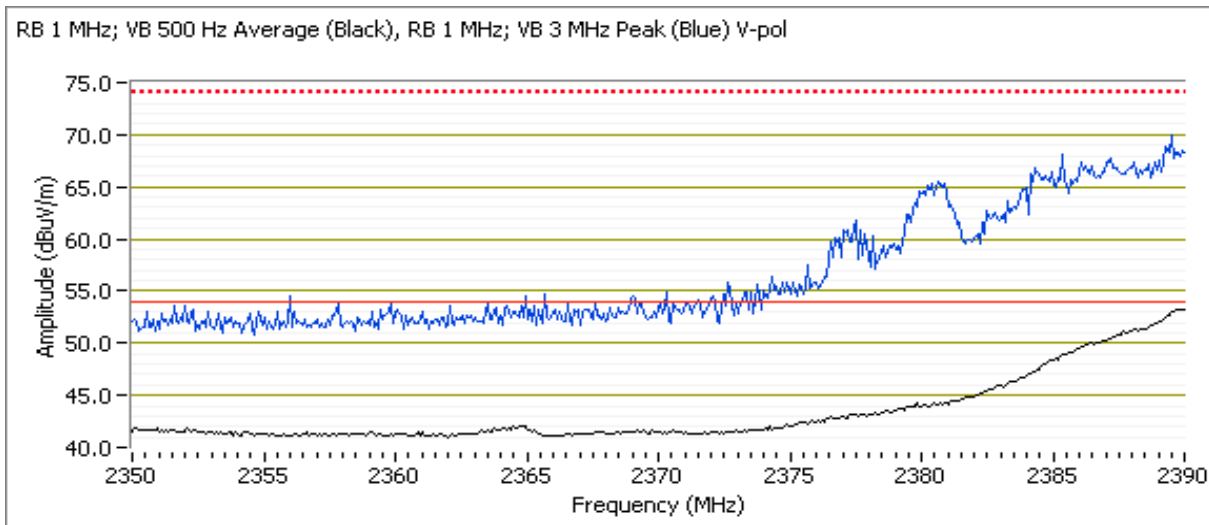

Channel: 3                      Mode: g  
 Tx Chain: Main                Data Rate: 6 Mbps

**Band Edge Signal Field Strength - Direct measurement of field strength**

Frequency	Level	Pol	15.209 / 15.247		Detector	Azimuth	Height	Comments
MHz	dB $\mu$ V/m	v/h	Limit	Margin	PK/QP/Avg	degrees	meters	Note 4 for average (0.6 dB)
2390.000	53.3	V	54.0	-0.7	Avg	35	1.6	POS; RB 1 MHz; VB: 500 Hz
2389.350	71.1	V	74.0	-2.9	PK	35	1.6	POS; RB 1 MHz; VB: 3 MHz
2389.990	41.9	H	54.0	-12.1	Avg	85	1.3	POS; RB 1 MHz; VB: 500 Hz
2389.380	59.7	H	74.0	-14.3	PK	85	1.3	POS; RB 1 MHz; VB: 3 MHz

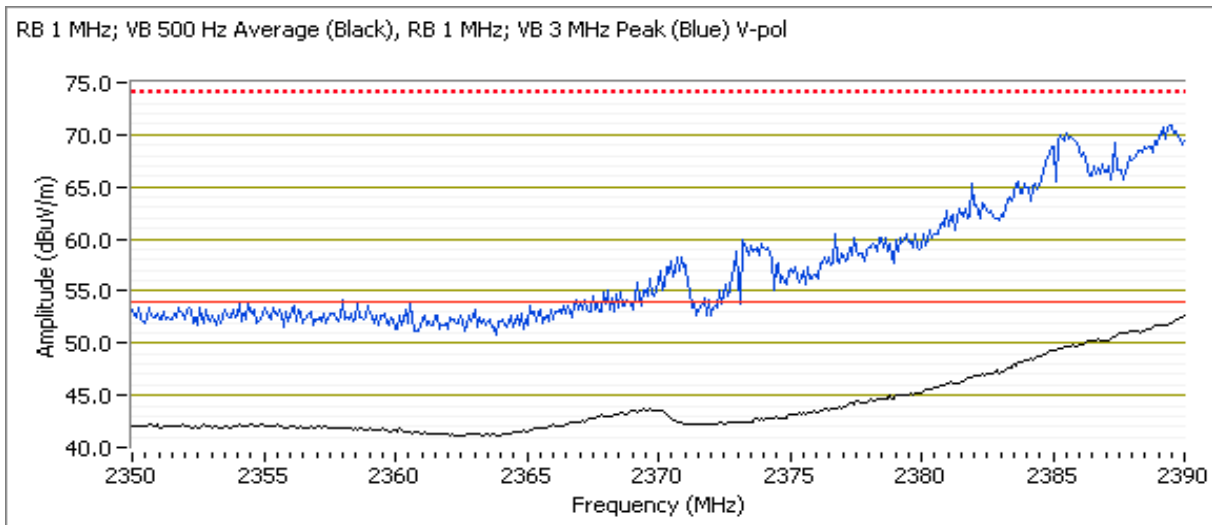

Channel: 10                      Mode: g  
 Tx Chain: Main                Data Rate: 6 Mbps

**Band Edge Signal Field Strength - Direct measurement of field strength**

Frequency MHz	Level dB $\mu$ V/m	Pol v/h	15.209 / 15.247		Detector Pk/QP/Avg	Azimuth degrees	Height meters	Comments
			Limit	Margin				
<b>2484.030</b>	<b>53.6</b>	V	54.0	<b>-0.4</b>	Avg	56	1.6	Note 4 for average (0.6 dB) POS; RB 1 MHz; VB: 500 Hz
2483.810	70.4	V	74.0	-3.6	PK	56	1.6	POS; RB 1 MHz; VB: 3 MHz
2483.870	43.5	H	54.0	-10.5	Avg	49	1.6	POS; RB 1 MHz; VB: 500 Hz
2484.780	60.1	H	74.0	-13.9	PK	49	1.6	POS; RB 1 MHz; VB: 3 MHz

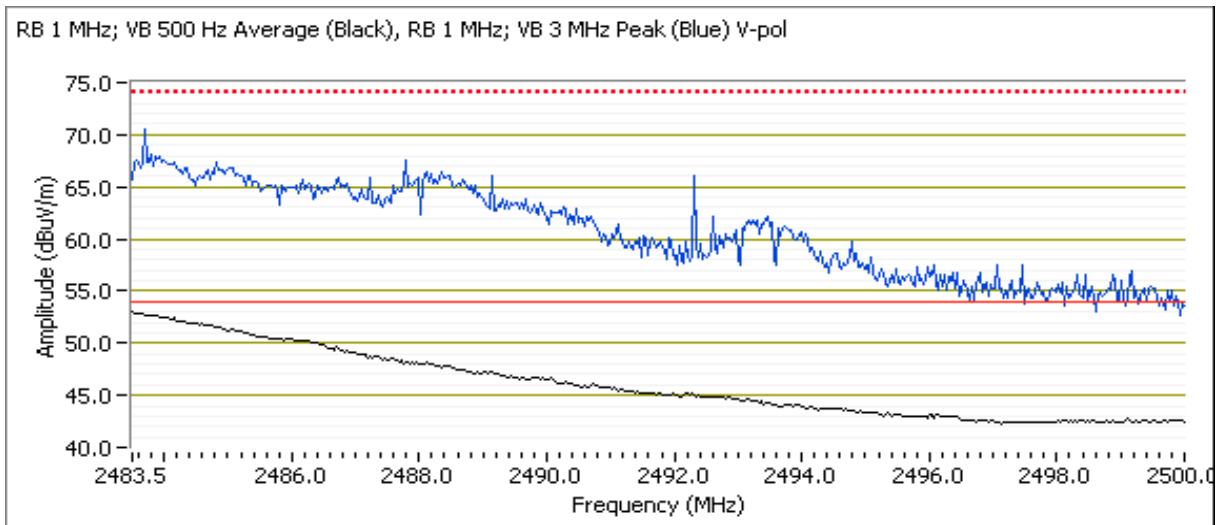



Channel: 11                      Mode: g  
 Tx Chain: Main                Data Rate: 6 Mbps

**Band Edge Signal Field Strength - Direct measurement of field strength**

Frequency	Level	Pol	15.209 / 15.247		Detector	Azimuth	Height	Comments
MHz	dB $\mu$ V/m	v/h	Limit	Margin	PK/QP/Avg	degrees	meters	Note 4 for average (0.6 dB)
2483.830	53.7	V	54.0	-0.3	Avg	267	1.6	POS; RB 1 MHz; VB: 500 Hz
2483.550	72.4	V	74.0	-1.6	PK	267	1.6	POS; RB 1 MHz; VB: 3 MHz
2483.570	45.8	H	54.0	-8.2	Avg	75	1.3	POS; RB 1 MHz; VB: 500 Hz
2484.240	64.1	H	74.0	-9.9	PK	75	1.3	POS; RB 1 MHz; VB: 3 MHz

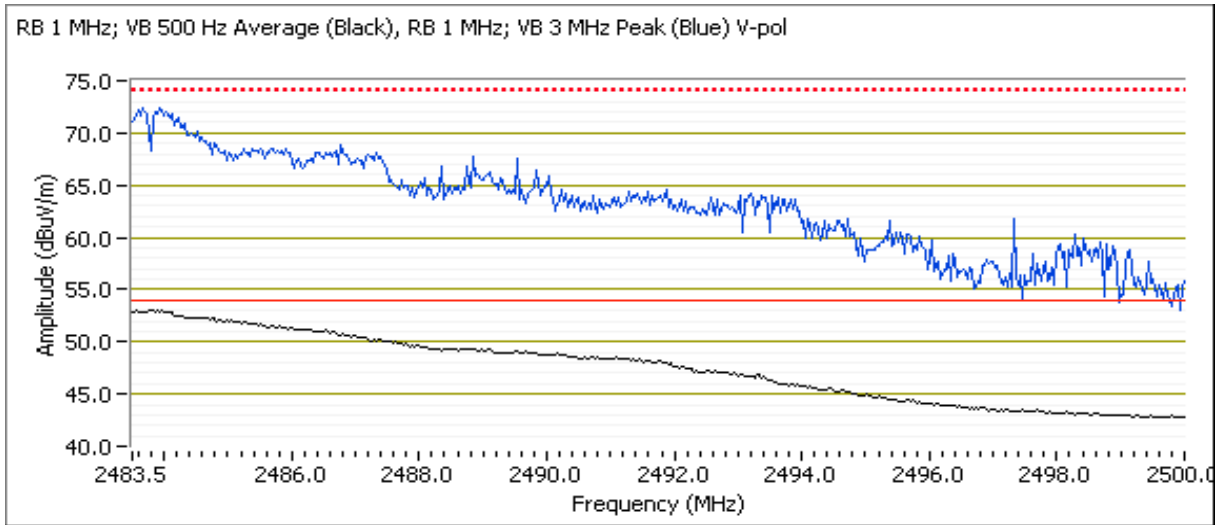

**Run #3: Radiated Bandedge Measurements**

Date of Test: 4/11/2015, 4/12/2015  
 Test Engineer: Deniz Demirci  
 Test Location: FT CH #5

Config. Used: 1  
 Config Change: None  
 EUT Voltage: POE

Channel: 1 Mode: n20  
 Tx Chain: Main Data Rate: 6.5 Mbps

**Band Edge Signal Field Strength - Direct measurement of field strength**

Frequency	Level	Pol	15.209 / 15.247		Detector	Azimuth	Height	Comments
MHz	dB $\mu$ V/m	v/h	Limit	Margin	Pk/QP/Avg	degrees	meters	Note 4 for average (0.6 dB)
<b>2389.830</b>	<b>73.9</b>	V	74.0	<b>-0.1</b>	PK	24	1.6	POS; RB 1 MHz; VB: 3 MHz
2389.810	53.5	V	54.0	-0.5	Avg	24	1.6	POS; RB 1 MHz; VB: 500 Hz
2389.820	42.9	H	54.0	-11.1	Avg	40	1.5	POS; RB 1 MHz; VB: 500 Hz
2389.570	63.3	H	74.0	-10.7	PK	40	1.5	POS; RB 1 MHz; VB: 3 MHz

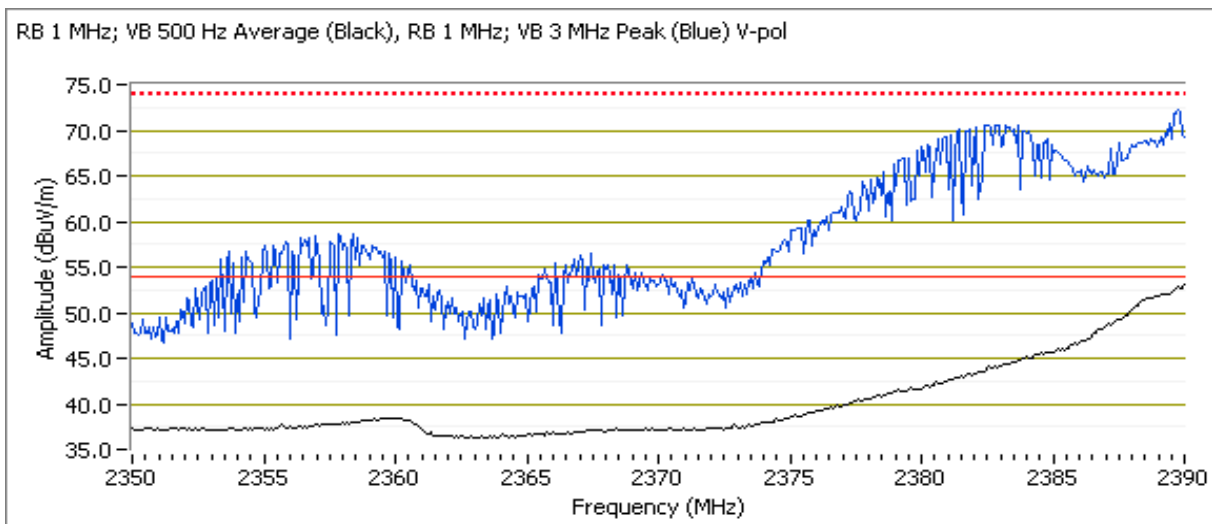

Channel: 2 Mode: n20  
 Tx Chain: Main Data Rate: 6.5 Mbps

**Band Edge Signal Field Strength - Direct measurement of field strength**

Frequency	Level	Pol	15.209 / 15.247		Detector	Azimuth	Height	Comments
MHz	dB $\mu$ V/m	v/h	Limit	Margin	PK/QP/Avg	degrees	meters	Note 4 for average
2389.990	53.7	V	54.0	-0.3	Avg	27	1.6	POS; RB 1 MHz; VB: 500 Hz
2388.350	73.6	V	74.0	-0.4	PK	27	1.6	POS; RB 1 MHz; VB: 3 MHz
2389.680	44.6	H	54.0	-9.4	Avg	47	1.4	POS; RB 1 MHz; VB: 500 Hz
2388.180	62.9	H	74.0	-11.1	PK	47	1.4	POS; RB 1 MHz; VB: 3 MHz

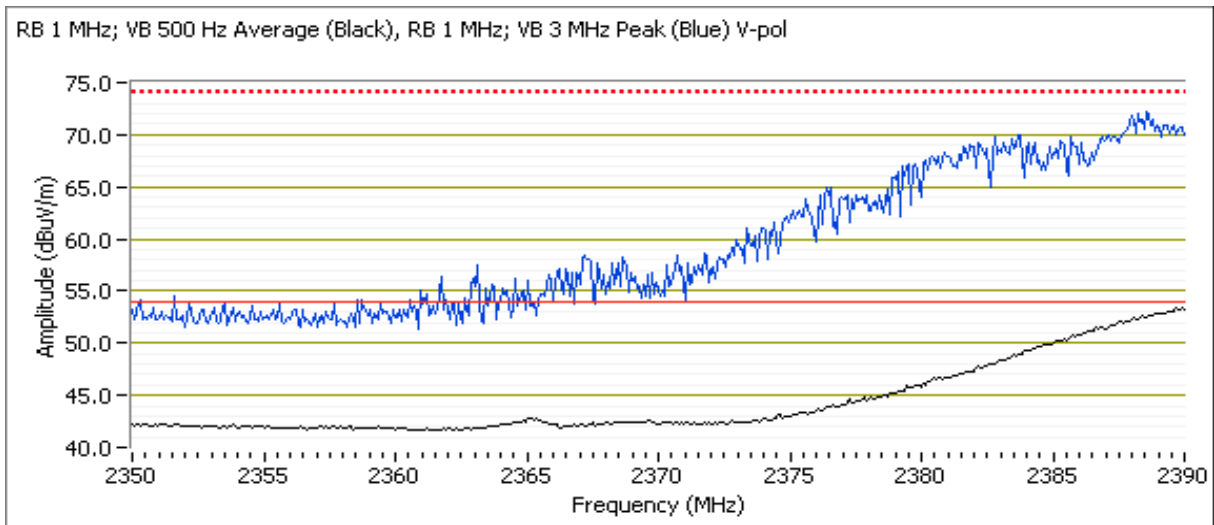

Channel: 3 Mode: n20  
 Tx Chain: Main Data Rate: 6.5 Mbps

**Band Edge Signal Field Strength - Direct measurement of field strength**

Frequency MHz	Level dB $\mu$ V/m	Pol v/h	15.209 / 15.247		Detector Pk/QP/Avg	Azimuth degrees	Height meters	Comments
			Limit	Margin				
<b>2389.960</b>	<b>53.3</b>	V	54.0	<b>-0.7</b>	Avg	32	1.6	Note 4 for average (0.6 dB) POS; RB 1 MHz; VB: 500 Hz
2389.830	72.6	V	74.0	-1.4	PK	32	1.6	POS; RB 1 MHz; VB: 3 MHz
2389.600	43.0	H	54.0	-11.0	Avg	44	1.4	POS; RB 1 MHz; VB: 500 Hz
2389.860	61.6	H	74.0	-12.4	PK	44	1.4	POS; RB 1 MHz; VB: 3 MHz

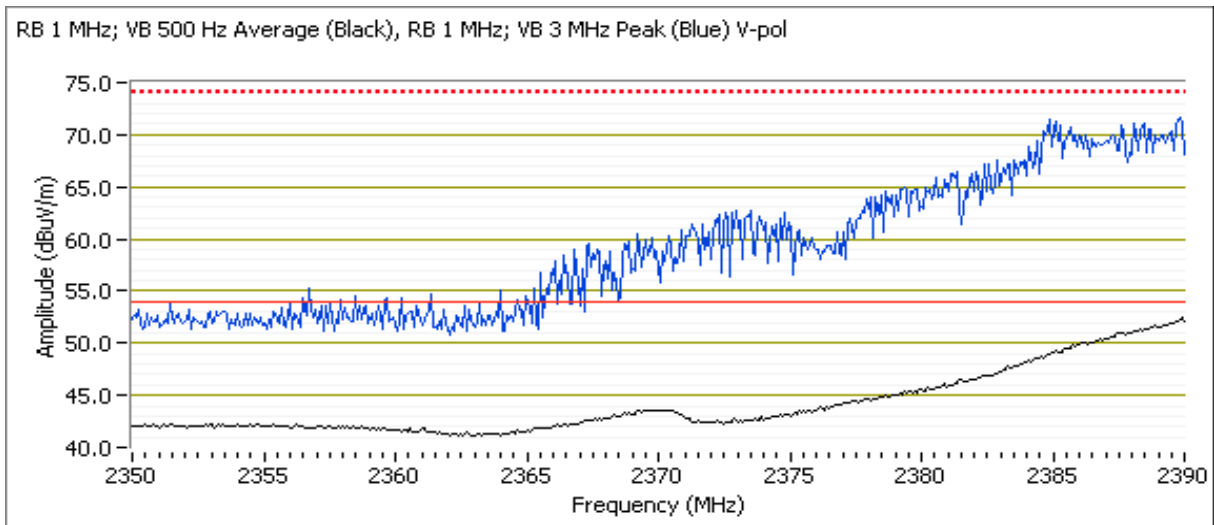

Channel: 10 Mode: n20  
 Tx Chain: Main Data Rate: 6.5 Mbps

**Band Edge Signal Field Strength - Direct measurement of field strength**

Frequency MHz	Level dB $\mu$ V/m	Pol v/h	15.209 / 15.247		Detector Pk/QP/Avg	Azimuth degrees	Height meters	Comments
			Limit	Margin				
<b>2483.840</b>	<b>53.9</b>	V	54.0	<b>-0.1</b>	Avg	267	1.9	Note 4 for average POS; RB 1 MHz; VB: 500 Hz
2483.630	73.7	V	74.0	-0.3	PK	267	1.9	POS; RB 1 MHz; VB: 3 MHz
2483.740	42.3	H	54.0	-11.7	Avg	297	1.7	POS; RB 1 MHz; VB: 500 Hz
2483.510	63.0	H	74.0	-11.0	PK	297	1.7	POS; RB 1 MHz; VB: 3 MHz

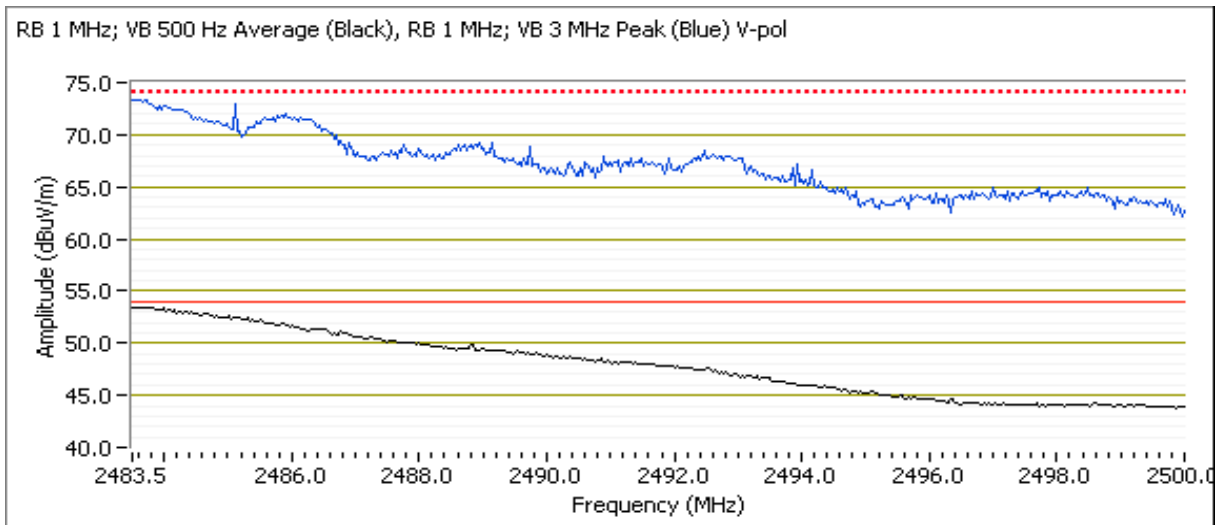

Channel: 11 Mode: n20  
 Tx Chain: Main Data Rate: 6.5 Mbps

**Band Edge Signal Field Strength - Direct measurement of field strength**

Frequency MHz	Level dB $\mu$ V/m	Pol v/h	15.209 / 15.247		Detector Pk/QP/Avg	Azimuth degrees	Height meters	Comments
			Limit	Margin				
<b>2483.600</b>	<b>73.2</b>	V	74.0	<b>-0.8</b>	PK	281	2.0	Note 4 for average POS; RB 1 MHz; VB: 3 MHz
2483.510	49.7	V	54.0	-4.3	Avg	281	2.0	POS; RB 1 MHz; VB: 500 Hz
2483.680	42.1	H	54.0	-11.9	Avg	80	1.9	POS; RB 1 MHz; VB: 500 Hz
2483.640	64.2	H	74.0	-9.8	PK	80	1.9	POS; RB 1 MHz; VB: 3 MHz

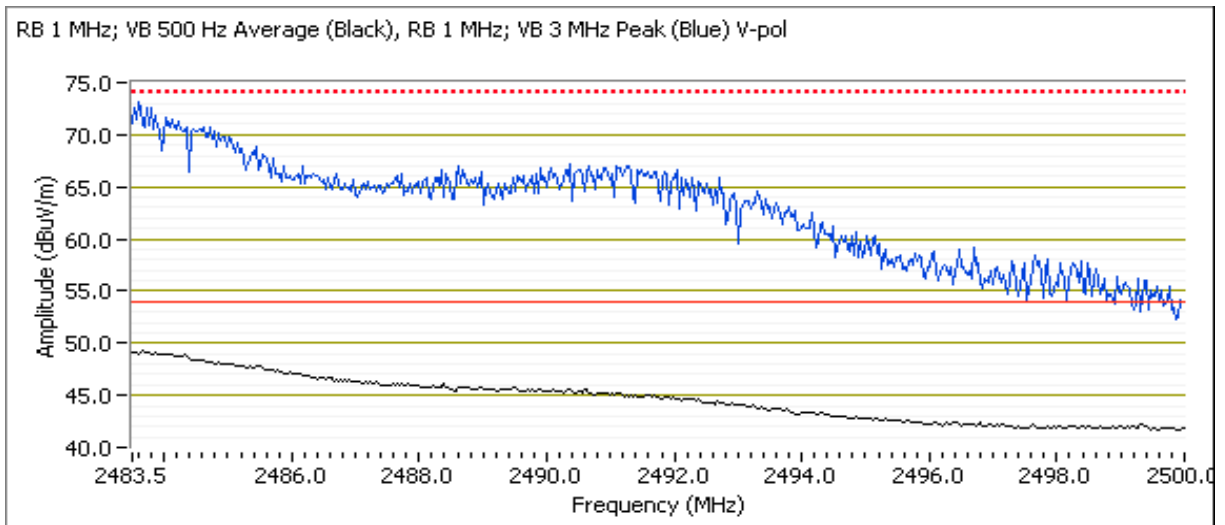



# EMC Test Data

Client: Barracuda Networks	Job Number: JD99428
Model: BNHW028 (Dome)	T-Log Number: T101416
	Project Manager: Christine Krebill
Contact: Gary Liu	Project Coordinator: -
Standard: FCC part 15, RSS-247	Class: N/A

## RSS-247 and FCC 15.247 (DTS) Radiated Spurious Emissions

### Test Specific Details

Objective: The objective of this test session is to perform final qualification testing of the EUT with respect to the specification listed above.

### General Test Configuration

The EUT and all local support equipment were located on the turntable for radiated spurious emissions testing.

For radiated emissions testing the measurement antenna was located 3 meters from the EUT, unless otherwise noted.

### Ambient Conditions:

Temperature: 22.4 °C  
Rel. Humidity: 36 %

### Summary of Results - Device Operating in the 2400-2483.5 MHz Band

Run #	Mode	Channel	Target Power	Power Setting	Test Performed	Limit	Result / Margin
1	b	1 - 2412MHz	21	18	Radiated Emissions, 1 - 25 GHz	FCC Part 15.209 / 15.247( c)	53.8 dBµV/m @ 4824.1 MHz (-0.2 dB)
	b	6 - 2437MHz	21	21	Radiated Emissions, 1 - 25 GHz	FCC Part 15.209 / 15.247( c)	53.6 dBµV/m @ 4874.0 MHz (-0.4 dB)
	b	11 - 2462MHz	21	19	Radiated Emissions, 1 - 25 GHz	FCC Part 15.209 / 15.247( c)	53.5 dBµV/m @ 4924.1 MHz (-0.5 dB)
Scans on center channel in all three OFDM modes to determine the worst case mode.							
2	g	6 - 2437MHz	21	21	Radiated Emissions, 1 - 25 GHz	FCC Part 15.209 / 15.247( c)	46.5 dBµV/m @ 4874.1 MHz (-7.5 dB)
	n20	6 - 2437MHz	21	21	Radiated Emissions, 1 - 25 GHz	FCC Part 15.209 / 15.247( c)	46.7 dBµV/m @ 4873.9 MHz (-7.3 dB)
Measurements on low and high channels in worst-case OFDM mode.							
3	n20	1 - 2412MHz	21	21	Radiated Emissions, 1 - 25 GHz	FCC Part 15.209 / 15.247( c)	46.0 dBµV/m @ 1125.1 MHz (-8.0 dB)
	n20	11 - 2462MHz	21	21	Radiated Emissions, 1 - 25 GHz	FCC Part 15.209 / 15.247( c)	45.5 dBµV/m @ 1125.1 MHz (-8.5 dB)



# EMC Test Data

Client: Barracuda Networks	Job Number: JD99428
Model: BNHW028 (Dome)	T-Log Number: T101416
	Project Manager: Christine Krebill
Contact: Gary Liu	Project Coordinator: -
Standard: FCC part 15, RSS-247	Class: N/A

## Modifications Made During Testing

No modifications were made to the EUT during testing

## Deviations From The Standard

No deviations were made from the requirements of the standard.

## Sample Notes

Sample S/N: 00:25:19:06:99:20

Driver: iwpriv

Antenna: 3.2 dBi whip

## Procedure Comments:

Measurements performed in accordance with FCC KDB 558074

Peak measurements performed with: RBW=1MHz, VBW=3MHz, peak detector, max hold, auto sweep time

Unless otherwise stated/noted, emission has duty cycle  $\geq 98\%$  and was measured using RBW=1MHz, VBW=10Hz, peak detector, linear average mode, auto sweep time, max hold.

2.4GHz band reject filter used

Mode	Data Rate	Duty Cycle (x)	Constant DC?	T (ms)	Pwr Cor Factor*	Lin Volt Cor Factor**	Min VBW for FS (Hz)	VBW	# of Max Hold
11b	11 Mbps	0.90	Yes	1.878	0.5	0.9	532	1 kHz	65
11g	6 Mbps	0.94	Yes	3.095	0.3	0.6	323	500 Hz	62
n20	6.5 Mbps	0.93	Yes	2.857	0.3	0.6	350	500 Hz	62

## Measurement Specific Notes:

Note 1:	Emission in non-restricted band, but limit of 15.209 used.
Note 2:	Emission in non-restricted band, the limit was set 30dB below the level of the fundamental and measured in 100kHz.
Note 3:	Emission has a duty cycle $\geq 98\%$ , average measurement performed: RBW=1MHz, VBW=3MHz, RMS, Power averaging, auto sweep, trace average 100 traces
Note 4:	Emission has constant duty cycle $< 98\%$ , average measurement performed: RBW=1MHz, VBW> $> 1/T$ but not less than 10Hz, peak detector, linear averaging, auto sweep, trace average 100 traces, measurement corrected by Linear voltage correction factor
Note 5:	Emission has constant duty cycle $< 98\%$ , average measurement performed: RBW=1MHz, VBW=3MHz, RMS, Power averaging, auto sweep, trace average 100 traces, measurement corrected by Pwr correction factor
Note 6:	Emission has non constant duty cycle $< 98\%$ , average measurement performed: RBW=1MHz, VBW> $> 1/T$ , peak detector, linear average mode, sweep time auto, max hold. Max hold for $50*(1/DC)$ traces
Note 7:	Emission has non constant duty cycle $< 98\%$ , average measurement performed: RBW=1MHz, VBW> $> 1/T$ , RMS detector, sweep time auto, max hold. Max hold for $50*(1/DC)$ traces





# EMC Test Data

Client: Barracuda Networks	Job Number: JD99428
Model: BNHW028 (Dome)	T-Log Number: T101416
	Project Manager: Christine Krebill
Contact: Gary Liu	Project Coordinator: -
Standard: FCC part 15, RSS-247	Class: N/A

### Run #1: Radiated Spurious Emissions, 1,000 - 25000 MHz. Operating Mode: 802.11b

Date of Test: 4/11/2015      Config. Used: 1  
 Test Engineer: Rafael Varelas      Config Change: None  
 Test Location: FT CH #5      EUT Voltage: POE

#### Run #1a: Low Channel

Channel: 1      Mode: b  
 Tx Chain: Main      Data Rate: 11 Mbps

Frequency	Level	Pol	15.209 / 15.247		Detector	Azimuth	Height	Comments
MHz	dB $\mu$ V/m	v/h	Limit	Margin	Pk/QP/Avg	degrees	meters	
<b>power setting = 18</b>								
4824.120	53.8	V	54.0	-0.2	Avg	257	1.6	Note 4 for average RB 1 MHz;VB 1 kHz;Peak 18
4824.050	57.3	V	74.0	-16.7	PK	257	1.6	RB 1 MHz;VB 3 MHz;Peak
1125.070	44.8	V	54.0	-9.2	Avg	94	1.5	RB 1 MHz;VB 1 kHz;Peak
1124.960	50.9	V	74.0	-23.1	PK	94	1.5	RB 1 MHz;VB 3 MHz;Peak

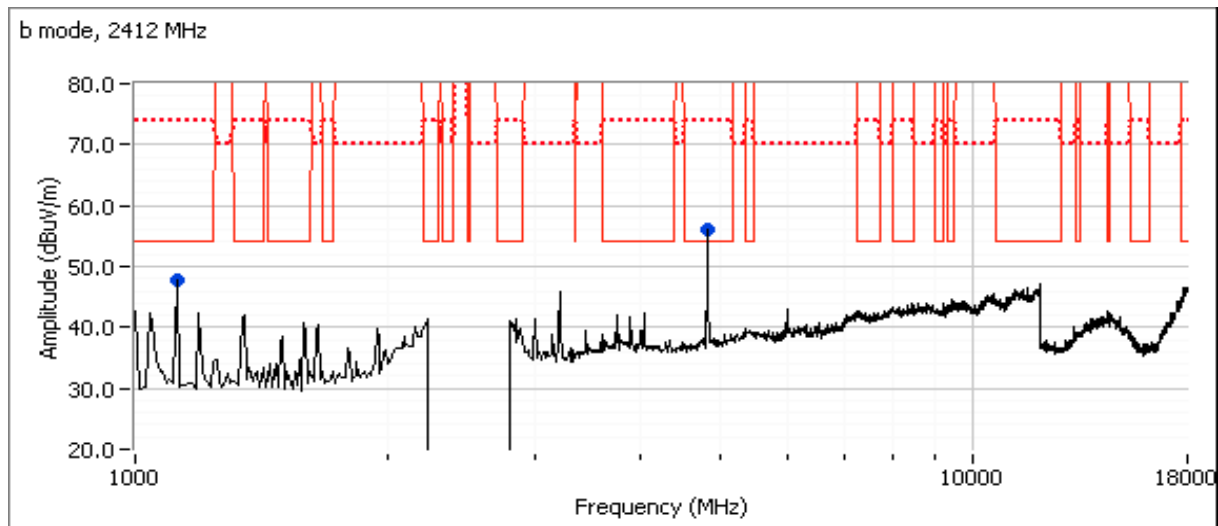

Client: Barracuda Networks	Job Number: JD99428
Model: BNHW028 (Dome)	T-Log Number: T101416
Contact: Gary Liu	Project Manager: Christine Krebill
Standard: FCC part 15, RSS-247	Project Coordinator: -
	Class: N/A

### Run #1b: Center Channel

Channel: 6                      Mode: b  
 Tx Chain: Main                Data Rate: 11 Mbps

Frequency	Level	Pol	15.209 / 15.247		Detector	Azimuth	Height	Comments
MHz	dB $\mu$ V/m	v/h	Limit	Margin	Pk/QP/Avg	degrees	meters	Note 4 for average
4874.040	53.6	V	54.0	-0.4	Avg	258	1.6	Note 4, RB 1 MHz; VB 1 kHz; Peak
4873.830	57.3	V	74.0	-16.7	PK	258	1.6	RB 1 MHz; VB 3 MHz; Peak
1125.070	44.8	V	54.0	-9.2	Avg	55	1.2	RB 1 MHz; VB 1 kHz; Peak
1124.950	50.8	V	74.0	-23.2	PK	55	1.2	RB 1 MHz; VB 3 MHz; Peak

Note: Scans made between 18 - 25 GHz with the measurement antenna moved around the card and its antennas 20-50cm from the device indicated there were no significant emissions in this frequency range

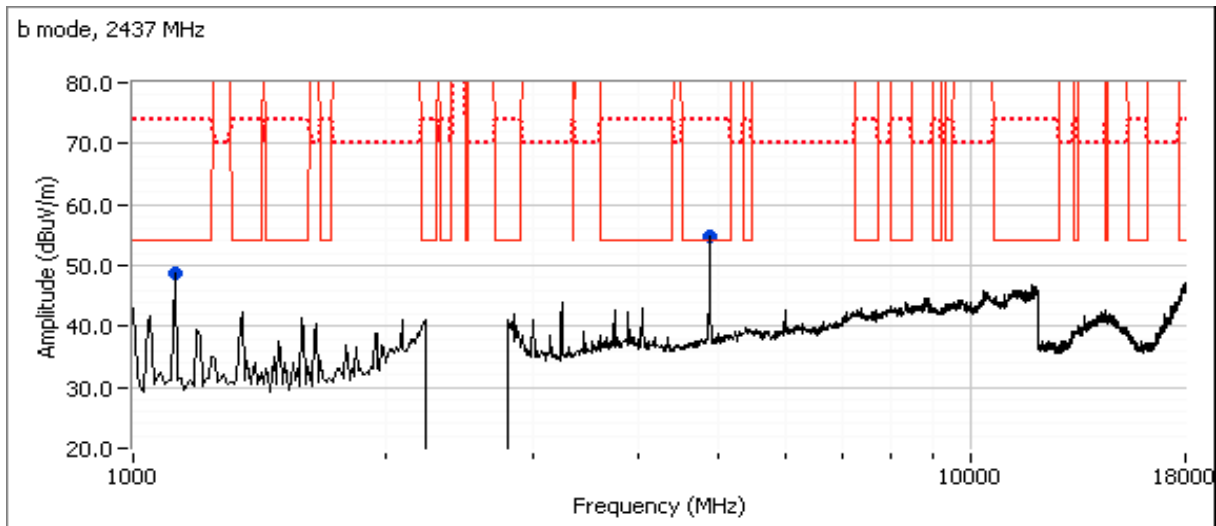

Client: Barracuda Networks	Job Number: JD99428
Model: BNHW028 (Dome)	T-Log Number: T101416
Contact: Gary Liu	Project Manager: Christine Krebill
Standard: FCC part 15, RSS-247	Project Coordinator: -
	Class: N/A

### Run #1c: High Channel

Channel: 11                      Mode: b  
 Tx Chain: Main                 Data Rate: 11 Mbps

Frequency	Level	Pol	15.209 / 15.247		Detector	Azimuth	Height	Comments
MHz	dB $\mu$ V/m	v/h	Limit	Margin	Pk/QP/Avg	degrees	meters	Note 4 for average
<b>power setting = 19</b>								
4924.080	53.5	V	54.0	-0.5	Avg	200	1.8	Note 4, RB 1 MHz; VB 1 kHz; Peak
4923.980	56.9	V	74.0	-17.1	PK	200	1.8	RB 1 MHz; VB 3 MHz; Peak
1125.040	45.5	V	54.0	-8.5	Avg	55	1.6	RB 1 MHz; VB 1 kHz; Peak
1125.060	51.6	V	74.0	-22.4	PK	55	1.6	RB 1 MHz; VB 3 MHz; Peak

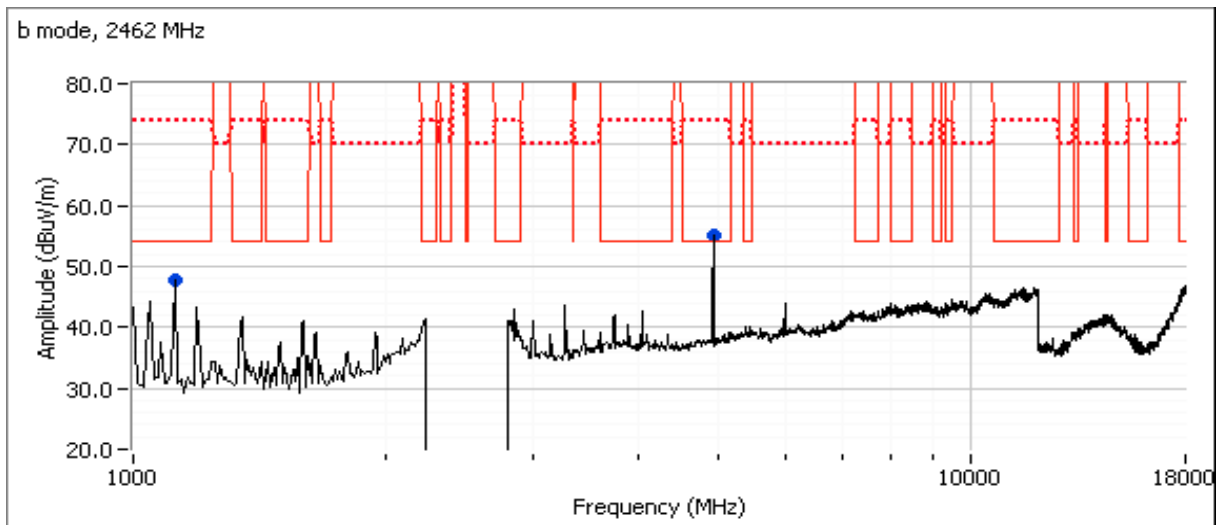

Client: Barracuda Networks	Job Number: JD99428
Model: BNHW028 (Dome)	T-Log Number: T101416
Contact: Gary Liu	Project Manager: Christine Krebill
Standard: FCC part 15, RSS-247	Project Coordinator: -
	Class: N/A

**Run #2: Radiated Spurious Emissions, 1,000 - 25000 MHz. Operating Mode: OFDM**

Date of Test: 4/11/2015  
 Test Engineer: Rafael Varelas  
 Test Location: FT CH #5  
 Config. Used: 1  
 Config Change: None  
 EUT Voltage: POE

**Run #2a: Center Channel**

Channel: 6  
 Tx Chain: Main  
 Mode: g  
 Data Rate: 6 Mbps

Frequency	Level	Pol	15.209 / 15.247		Detector	Azimuth	Height	Comments
MHz	dB $\mu$ V/m	v/h	Limit	Margin	Pk/QP/Avg	degrees	meters	Note 4 for average
4874.120	46.5	V	54.0	-7.5	Avg	202	1.8	RB 1 MHz;VB 1 kHz;Peak
4871.690	58.1	V	74.0	-15.9	PK	202	1.8	RB 1 MHz;VB 3 MHz;Peak
1125.040	45.0	V	54.0	-9.0	Avg	95	1.5	RB 1 MHz;VB 1 kHz;Peak
1124.900	50.4	V	74.0	-23.6	PK	95	1.5	RB 1 MHz;VB 3 MHz;Peak

Note: Scans made between 18 - 25 GHz with the measurement antenna moved around the card and its antennas 20-50cm from the device indicated there were no significant emissions in this frequency range

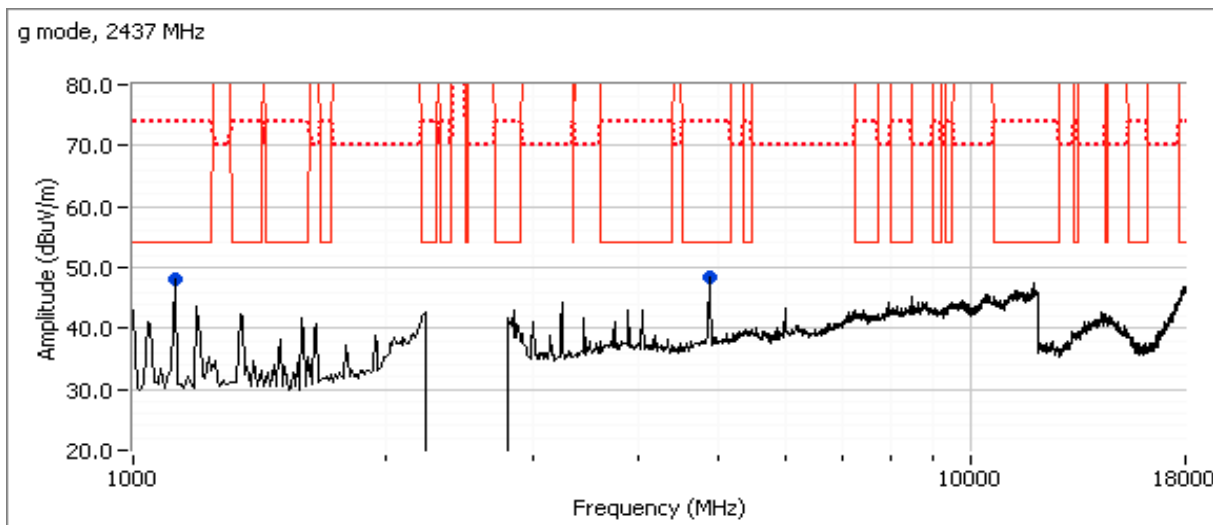

Client: Barracuda Networks	Job Number: JD99428
Model: BNHW028 (Dome)	T-Log Number: T101416
Contact: Gary Liu	Project Manager: Christine Krebill
Standard: FCC part 15, RSS-247	Project Coordinator: -
	Class: N/A

### Run #2b: Center Channel

Channel: 6                      Mode: n20  
 Tx Chain: Main                Data Rate: 6.5 Mbps

Frequency	Level	Pol	15.209 / 15.247		Detector	Azimuth	Height	Comments
MHz	dB $\mu$ V/m	v/h	Limit	Margin	Pk/QP/Avg	degrees	meters	Note 4 for average
4873.850	46.7	V	54.0	-7.3	Avg	200	1.8	RB 1 MHz;VB 1 kHz;Peak
4874.780	59.2	V	74.0	-14.8	PK	200	1.8	RB 1 MHz;VB 3 MHz;Peak
1125.150	45.4	V	54.0	-8.6	Avg	64	1.6	RB 1 MHz;VB 1 kHz;Peak
1124.910	51.6	V	74.0	-22.4	PK	64	1.6	RB 1 MHz;VB 3 MHz;Peak

Note: Scans made between 18 - 25 GHz with the measurement antenna moved around the card and its antennas 20-50cm from the device indicated there were no significant emissions in this frequency range

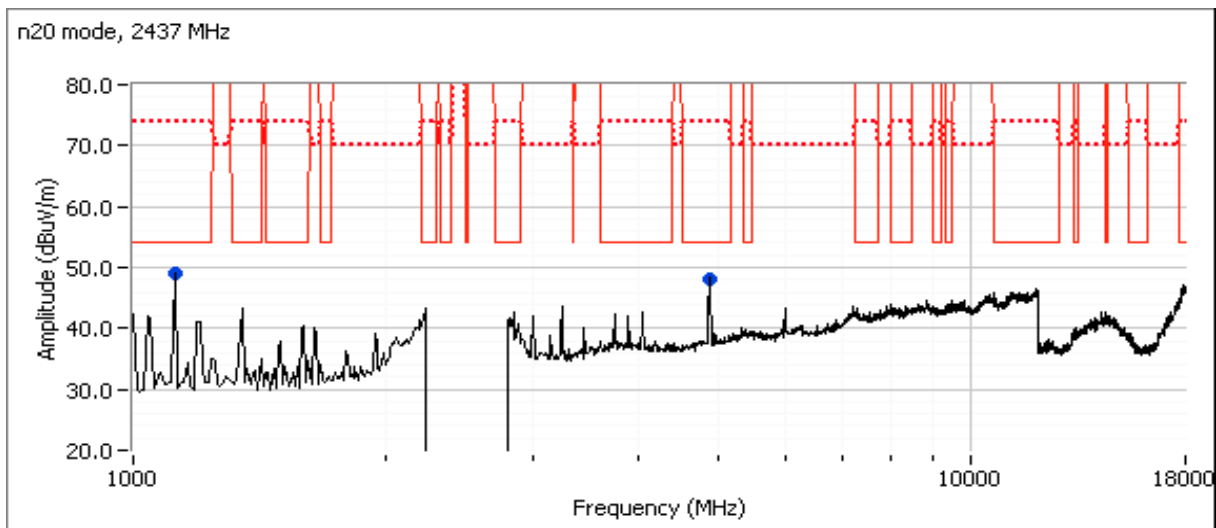



# EMC Test Data

Client: Barracuda Networks	Job Number: JD99428
Model: BNHW028 (Dome)	T-Log Number: T101416
	Project Manager: Christine Krebill
Contact: Gary Liu	Project Coordinator: -
Standard: FCC part 15, RSS-247	Class: N/A

### Run #3: Radiated Spurious Emissions, 1,000 - 25000 MHz. Operating Mode: Worse case from Run #2

Date of Test: 4/11/2015      Config. Used: 1  
 Test Engineer: Rafael Varelas      Config Change: None  
 Test Location: FT CH #5      EUT Voltage: POE

#### Run #3a: Low Channel

Channel: 1      Mode: n20  
 Tx Chain: Main      Data Rate: 6.5 Mbps

Frequency	Level	Pol	15.209 / 15.247		Detector	Azimuth	Height	Comments
MHz	dB $\mu$ V/m	v/h	Limit	Margin	Pk/QP/Avg	degrees	meters	Note 4 for average
1125.100	46.0	V	54.0	-8.0	Avg	61	1.6	RB 1 MHz;VB 1 kHz;Peak
1125.000	51.5	V	74.0	-22.5	PK	61	1.6	RB 1 MHz;VB 3 MHz;Peak
4824.320	45.7	V	54.0	-8.3	Avg	333	1.8	Note 4, RB 1 MHz;VB 1 kHz;Peak
4824.740	58.6	V	74.0	-15.4	PK	333	1.8	RB 1 MHz;VB 3 MHz;Peak

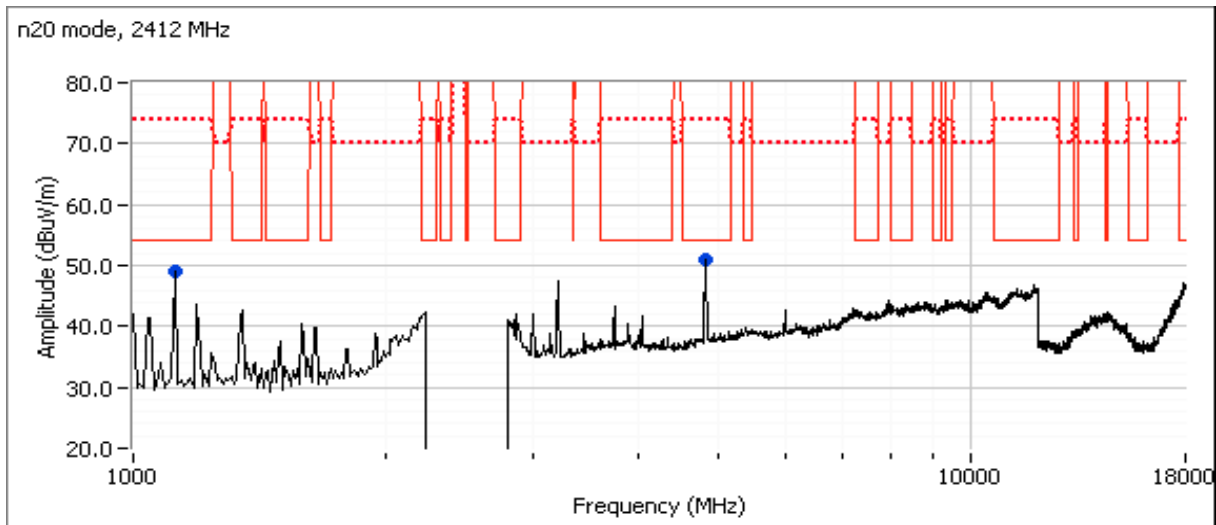



# EMC Test Data

Client: Barracuda Networks	Job Number: JD99428
Model: BNHW028 (Dome)	T-Log Number: T101416
	Project Manager: Christine Krebill
Contact: Gary Liu	Project Coordinator: -
Standard: FCC part 15, RSS-247	Class: N/A

## Run #3b: High Channel

Channel: 11                      Mode: n20  
 Tx Chain: Main                Data Rate: 6.5 Mbps

Frequency	Level	Pol	15.209 / 15.247		Detector	Azimuth	Height	Comments
MHz	dB $\mu$ V/m	v/h	Limit	Margin	Pk/QP/Avg	degrees	meters	Note 4 for average
1125.100	45.5	V	54.0	-8.5	Avg	61	1.6	RB 1 MHz;VB 1 kHz;Peak
1125.060	50.9	V	74.0	-23.1	PK	61	1.6	RB 1 MHz;VB 3 MHz;Peak
4924.060	43.3	V	54.0	-10.7	Avg	231	1.5	Note 4, RB 1 MHz;VB 1 kHz;Peak
4924.390	55.8	V	74.0	-18.2	PK	231	1.5	RB 1 MHz;VB 3 MHz;Peak

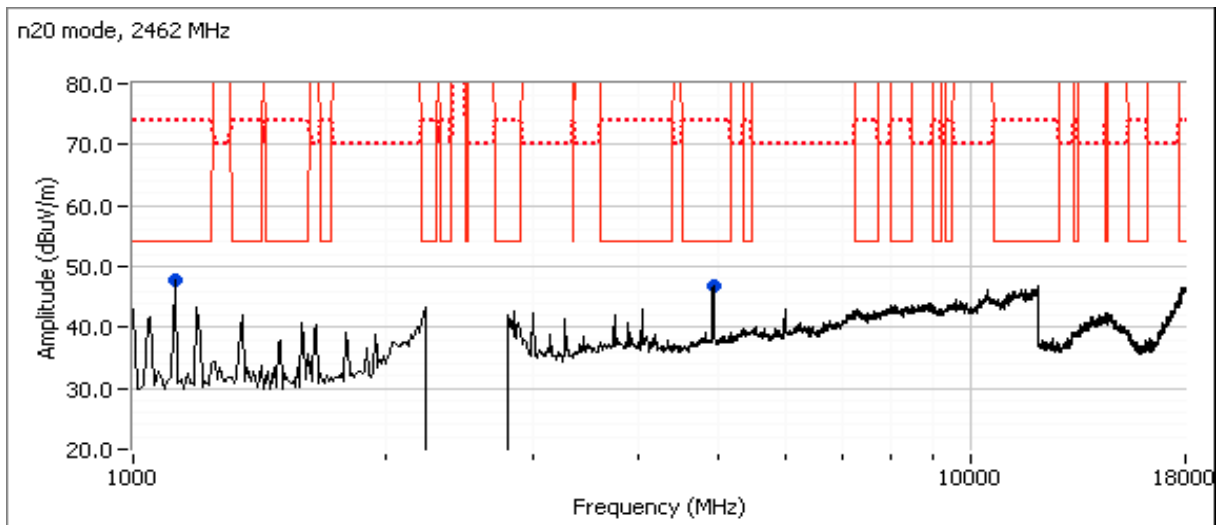



# EMC Test Data

Client: Barracuda Networks	Job Number: JD99428
Model: BNHW028 (Dome)	T-Log Number: T101416
	Project Manager: Christine Krebill
Contact: Gary Liu	Project Coordinator: -
Standard: FCC part 15, RSS-247	Class: N/A

## RSS-247 and FCC 15.247 (DTS) Antenna Port Measurements Power, PSD, Bandwidth and Spurious Emissions

### Test Specific Details

Objective: The objective of this test session is to perform final qualification testing of the EUT with respect to the specification listed above.

Date of Test: 4/13/2016  
 Test Engineer: Deniz Demirci  
 Test Location: FT Lab #4a

Config. Used: 1  
 Config Change: None  
 EUT Voltage: POE

### General Test Configuration

The EUT was connected to the spectrum analyzer or power meter via a suitable attenuator. All measurements were made on a single chain.

All measurements have been corrected to allow for the external attenuators used.

### Ambient Conditions:

Temperature: 20-21 °C  
 Rel. Humidity: 30-35 %

### Summary of Results

Run #	Pwr setting	Avg Pwr	Test Performed	Limit	Pass / Fail	Result / Margin
1	-	-	Output Power	15.247(b)	Pass	b: 17.0 dBm g: 17.6 dBm n20: 17.6 dBm
2	-	-	Power spectral Density (PSD)	15.247(d)	Pass	b: -1.4 dBm / 10 kHz g: -3.2 dBm / 10 kHz n20: -2.8 dBm / 10 kHz
3	-	-	Minimum 6 dB Bandwidth	15.247(a)	Pass	b: 9.80 MHz g: 16.33 MHz n20: 17.13 MHz
3	-	-	99% Bandwidth	RSS GEN	-	b: 12.13 MHz g: 17.04 MHz n20: 17.97 MHz
4	-	-	Spurious emissions	15.247(b)	Pass	All emissions < 30 dBc

### Modifications Made During Testing

No modifications were made to the EUT during testing

### Deviations From The Standard

No deviations were made from the requirements of the standard.





# EMC Test Data

Client: Barracuda Networks	Job Number: JD99428
Model: BNHW028 (Dome)	T-Log Number: T101416
	Project Manager: Christine Krebill
Contact: Gary Liu	Project Coordinator: -
Standard: FCC part 15, RSS-247	Class: N/A

## Procedure Comments:

Measurements performed in accordance with FCC KDB 558074

Mode	Data Rate	Duty Cycle (x)	Constant DC?	T (ms)	Pwr Cor Factor*	Lin Volt Cor Factor**	Min VBW for FS (Hz)
11b	11 Mbps	0.90	Yes	1.878	0.5	0.9	532
11g	6 Mbps	0.94	Yes	3.095	0.3	0.6	323
n20	6.5 Mbps	0.93	Yes	2.857	0.3	0.6	350

## Sample Notes

Sample S/N: 00:25:19:06:99:20

Driver: iwpriv

Antenna: 3.2 dBi whip



# EMC Test Data

Client: Barracuda Networks	Job Number: JD99428
Model: BNHW028 (Dome)	T-Log Number: T101416
	Project Manager: Christine Krebill
Contact: Gary Liu	Project Coordinator: -
Standard: FCC part 15, RSS-247	Class: N/A

## Run #1: Output Power

### Mode: 11b

Power Setting <sup>2</sup>	Frequency (MHz)	Output Power		Antenna Gain (dBi)	Result	EIRP		Output Power	
		(dBm) <sup>1</sup>	mW			dBm	W	(dBm) <sup>3</sup>	mW
18	2412	15.3	33.9	3.2	Pass	18.5	0.071		
21	2437	17.0	50.1	3.2	Pass	20.2	0.105		
19	2462	16.0	39.8	3.2	Pass	19.2	0.083		

### Mode: 11g

Power Setting <sup>2</sup>	Frequency (MHz)	Output Power		Antenna Gain (dBi)	Result	EIRP		Output Power	
		(dBm) <sup>1</sup>	mW			dBm	W	(dBm) <sup>3</sup>	mW
13	2412	13.2	20.9	3.2	Pass	16.4	0.044		
21	2437	17.6	57.5	3.2	Pass	20.8	0.120		
16	2462	14.9	30.9	3.2	Pass	18.1	0.065		

### Mode: n20

Power Setting <sup>2</sup>	Frequency (MHz)	Output Power		Antenna Gain (dBi)	Result	EIRP		Output Power	
		(dBm) <sup>1</sup>	mW			dBm	W	(dBm) <sup>3</sup>	mW
11	2412	12.9	19.5	3.2	Pass	16.1	0.041		
21	2437	17.6	57.5	3.2	Pass	20.8	0.120		
13	2462	13.2	20.9	3.2	Pass	16.4	0.044		

Note 1:	Output power measured using gated average power meter. (option AVGPM-G in ANSI C63.10). Spurious limit becomes -30 dBc.
Note 2:	Power setting - the software power setting used during testing, included for reference only.
Note 3:	Power measured using average power meter (non-gated) and is included for reference only.



# EMC Test Data

Client: Barracuda Networks	Job Number: JD99428
Model: BNHW028 (Dome)	T-Log Number: T101416
	Project Manager: Christine Krebill
Contact: Gary Liu	Project Coordinator: -
Standard: FCC part 15, RSS-247	Class: N/A

## Run #2: Power spectral Density

### Mode: 11b

Power Setting	Frequency (MHz)	PSD	Limit dBm/3kHz	Result
		(dBm/10 kHz) <sup>Note 1</sup>		
18	2412	-2.7	8.0	Pass
21	2437	-1.4	8.0	Pass
19	2462	-2.4	8.0	Pass

### Mode: 11g

Power Setting	Frequency (MHz)	PSD	Limit dBm/3kHz	Result
		(dBm/10 kHz) <sup>Note 1</sup>		
13	2412	-6.5	8.0	Pass
21	2437	-3.2	8.0	Pass
16	2462	-6.1	8.0	Pass

### Mode: n20

Power Setting	Frequency (MHz)	PSD	Limit dBm/3kHz	Result
		(dBm/10 kHz) <sup>Note 1</sup>		
11	2412	-7.2	8.0	Pass
21	2437	-2.8	8.0	Pass
13	2462	-7.2	8.0	Pass

Note 1: Test performed per method PKSPD, in KDB 558074. Power spectral density measured using:  $3\text{kHz} \leq \text{RBW} \leq 100\text{kHz}$ ,  $\text{VBW}=3*\text{RBW}$ , peak detector, span =  $1.5*\text{DTS BW}$ , auto sweep time, max hold.

Client: Barracuda Networks	Job Number: JD99428
Model: BNHW028 (Dome)	T-Log Number: T101416
Contact: Gary Liu	Project Manager: Christine Krebill
Standard: FCC part 15, RSS-247	Project Coordinator: -
	Class: N/A

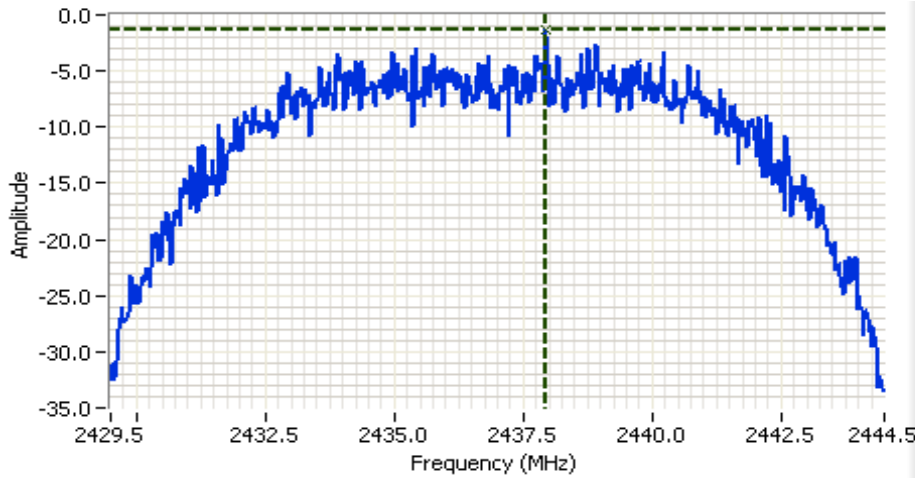

**Analyzer Settings**  
 Agilent Technologies, E4446A  
 CF: 2437.000 MHz  
 SPAN: 15.000 MHz  
 RB: 10.0 kHz  
 VB: 30.0 kHz  
 Detector: POS  
 Attn: 30 DB  
 RL Offset: 10.0 DB  
 Sweep Time: 143.4ms  
 Ref Lvl: 30.0 DBM

**Comments**  
 PSD: -1.4 dBm/10 kHz  
 802.11b Ch #6

Cursor 1 2437.9250 -1.4

0.0000 0.0

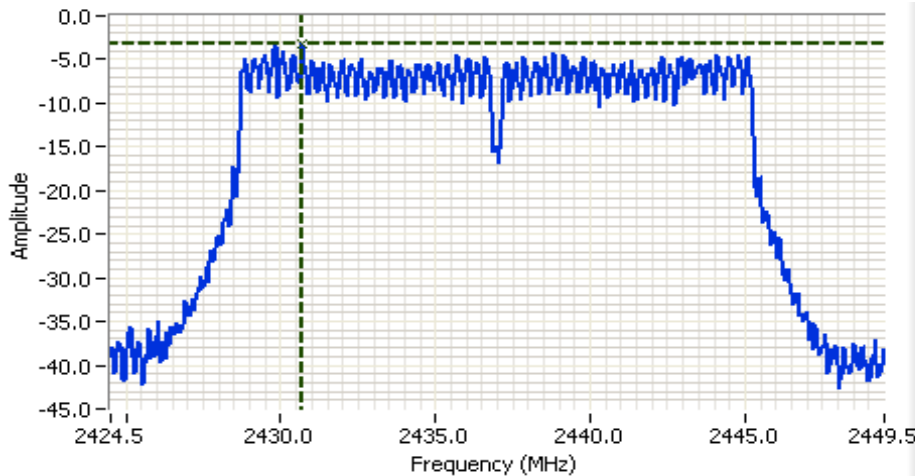

**Analyzer Settings**  
 Agilent Technologies, E4446A  
 CF: 2437.000 MHz  
 SPAN: 25.000 MHz  
 RB: 10.0 kHz  
 VB: 30.0 kHz  
 Detector: POS  
 Attn: 30 DB  
 RL Offset: 10.0 DB  
 Sweep Time: 239.0ms  
 Ref Lvl: 30.0 DBM

**Comments**  
 PSD: -3.2 dBm/10 kHz  
 802.11g Ch #6

Cursor 1 2430.7083 -3.2

0.0000 0.0





# EMC Test Data

Client: Barracuda Networks	Job Number: JD99428
Model: BNHW028 (Dome)	T-Log Number: T101416
Contact: Gary Liu	Project Manager: Christine Krebill
Standard: FCC part 15, RSS-247	Project Coordinator: -
	Class: N/A

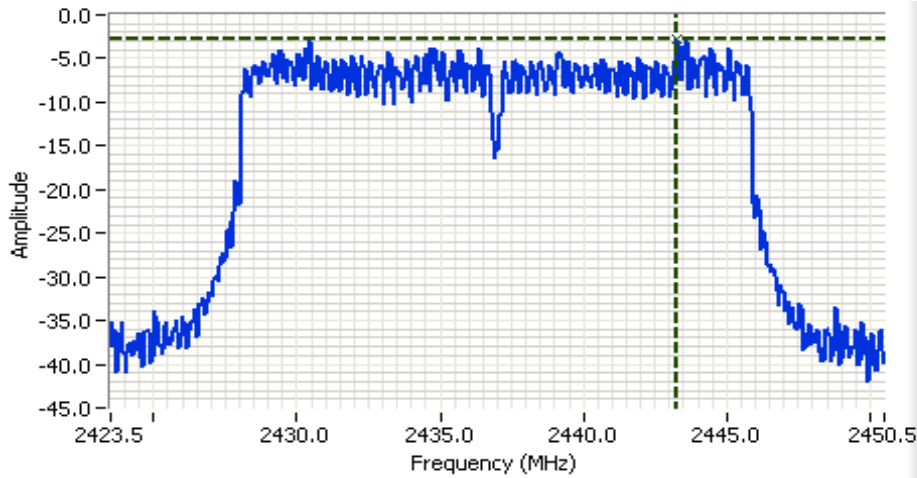

**Analyzer Settings**  
Agilent Technologies, E4446A  
CF: 2437.000 MHz  
SPAN: 27.000 MHz  
RB: 10.0 kHz  
VB: 30.0 kHz  
Detector: POS  
Attn: 30 DB  
RL Offset: 10.0 DB  
Sweep Time: 258.0ms  
Ref Lvl: 30.0 DBM

**Comments**  
PSD: -2.8 dBm/10 kHz  
802.11n20 Ch #6

Cursor 1 2443.2550 -2.8 [icons]  
0.0000 0.0 [icons]





# EMC Test Data

Client: Barracuda Networks	Job Number: JD99428
Model: BNHW028 (Dome)	T-Log Number: T101416
	Project Manager: Christine Krebill
Contact: Gary Liu	Project Coordinator: -
Standard: FCC part 15, RSS-247	Class: N/A

## Run #3: Signal Bandwidth

### Mode: 11b

Power Setting	Frequency (MHz)	Bandwidth (MHz)		RBW Setting (kHz)	
		6dB	99%	6dB	99%
18	2412	9.85	12.13	100	300
21	2437	9.85	12.13	100	300
19	2462	9.80	12.13	100	300

### Mode: 11g

Power Setting	Frequency (MHz)	Bandwidth (MHz)		RBW Setting (kHz)	
		6dB	99%	6dB	99%
13	2412	16.40	16.97	100	300
21	2437	16.33	17.04	100	300
16	2462	16.33	16.97	100	300

### Mode: n20

Power Setting	Frequency (MHz)	Bandwidth (MHz)		RBW Setting (kHz)	
		6dB	99%	6dB	99%
11	2412	17.77	17.53	100	300
21	2437	17.13	17.97	100	300
13	2462	17.53	17.77	100	300

Note 1: DTS BW: RBW=100kHz, VBW ≥ 3\*RBW, peak detector, max hold, auto sweep time, Span 2-5 times measured BW.  
 99% BW: RBW=1-5% of 99%BW, VBW ≥ 3\*RBW, peak detector, max hold, auto sweep time. Span 1.5-5 times OBW.

Client: Barracuda Networks	Job Number: JD99428
Model: BNHW028 (Dome)	T-Log Number: T101416
Contact: Gary Liu	Project Manager: Christine Krebill
Standard: FCC part 15, RSS-247	Project Coordinator: -
	Class: N/A

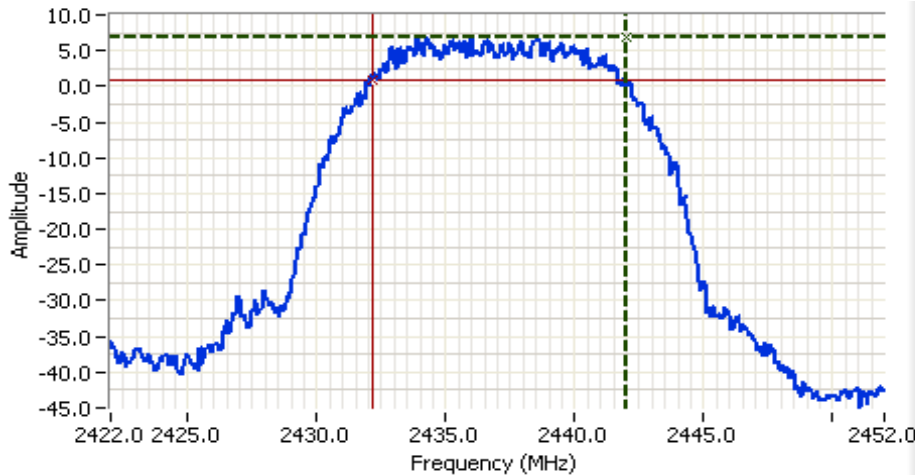

**Analyzer Settings**  
 Agilent Technologies, E4446A  
 CF: 2437.000 MHz  
 SPAN: 30.000 MHz  
 RB: 100 kHz  
 VB: 300 kHz  
 Detector: POS  
 Attn: 30 DB  
 RL Offset: 10.0 DB  
 Sweep Time: 2.9ms  
 Ref Lvl: 30.0 DBM

**Comments**  
 6dB BW: 9.850 MHz  
 802.11b Ch #6

Cursor 1 2442.0000 7.0 

Cursor 2 2432.1500 1.0 

Delta Freq. 9.850

Delta Amplitude 6.0

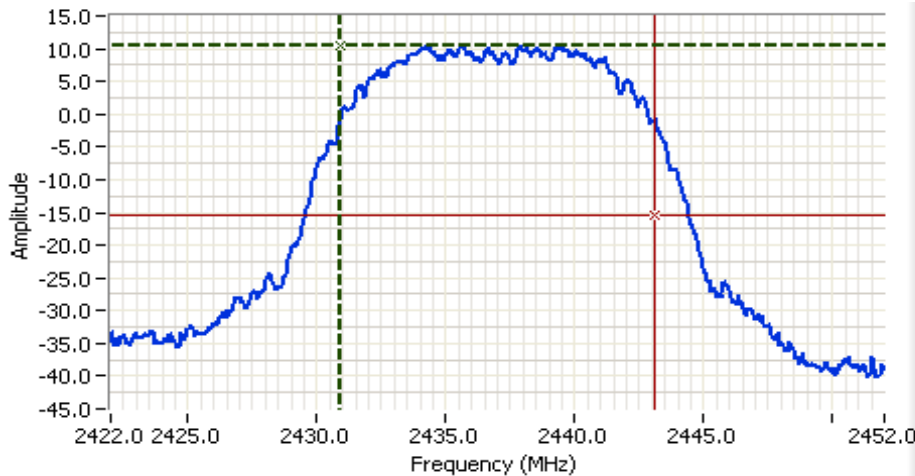

**Analyzer Settings**  
 Agilent Technologies, E4446A  
 CF: 2437.000 MHz  
 SPAN: 30.000 MHz  
 RB: 300 kHz  
 VB: 1.000 MHz  
 Detector: POS  
 Attn: 30 DB  
 RL Offset: 10.0 DB  
 Sweep Time: 1.0ms  
 Ref Lvl: 30.0 DBM

**Comments**  
 99% power BW: 12.130 MHz  
 802.11b Ch #6

Cursor 1 2430.9351 10.4 

Cursor 2 2443.0649 -15.6 

Delta Freq. 12.130

Delta Amplitude 26.0



Client: Barracuda Networks	Job Number: JD99428
Model: BNHW028 (Dome)	T-Log Number: T101416
Contact: Gary Liu	Project Manager: Christine Krebill
Standard: FCC part 15, RSS-247	Project Coordinator: -
	Class: N/A

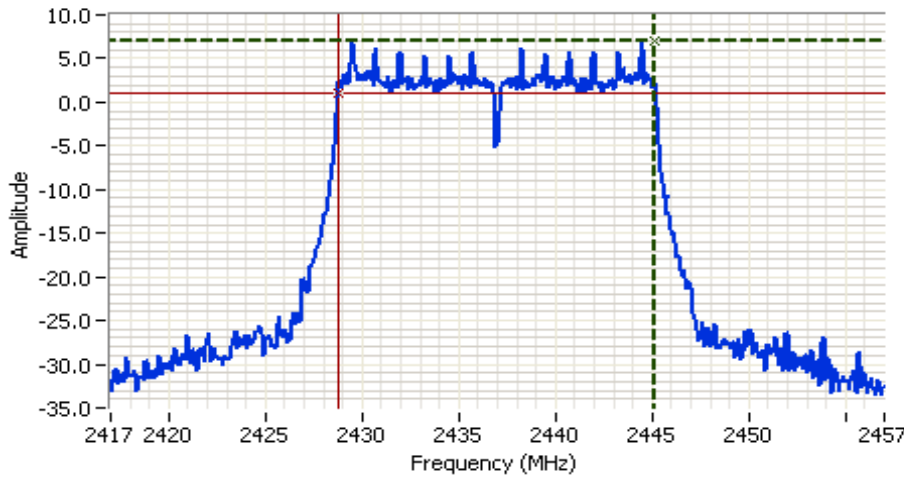

**Analyzer Settings**

Agilent Technologies, E4446A  
 CF: 2437.000 MHz  
 SPAN: 40.000 MHz  
 RB: 100 kHz  
 VB: 300 kHz  
 Detector: POS  
 Attn: 30 DB  
 RL Offset: 10.0 DB  
 Sweep Time: 3.8ms  
 Ref Lvl: 30.0 DBM

**Comments**

6dB BW: 16.333 MHz  
 802.11g Ch #6

Cursor 1 2445.1333 6.9

Cursor 2 2428.8000 0.9

Delta Freq. 16.333

Delta Amplitude 6.0

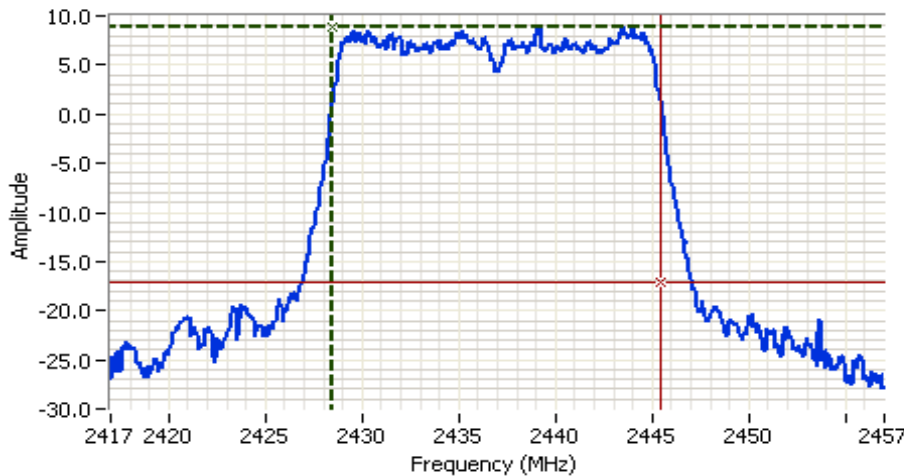

**Analyzer Settings**

Agilent Technologies, E4446A  
 CF: 2437.000 MHz  
 SPAN: 40.000 MHz  
 RB: 300 kHz  
 VB: 1.000 MHz  
 Detector: POS  
 Attn: 30 DB  
 RL Offset: 10.0 DB  
 Sweep Time: 1.0ms  
 Ref Lvl: 30.0 DBM

**Comments**

99% power BW: 17.038 MHz  
 802.11g Ch #6

Cursor 1 2428.4476 8.8

Cursor 2 2445.4859 -17.2

Delta Freq. 17.038

Delta Amplitude 26.0





Client: Barracuda Networks	Job Number: JD99428
Model: BNHW028 (Dome)	T-Log Number: T101416
Contact: Gary Liu	Project Manager: Christine Krebill
Standard: FCC part 15, RSS-247	Project Coordinator: -
	Class: N/A

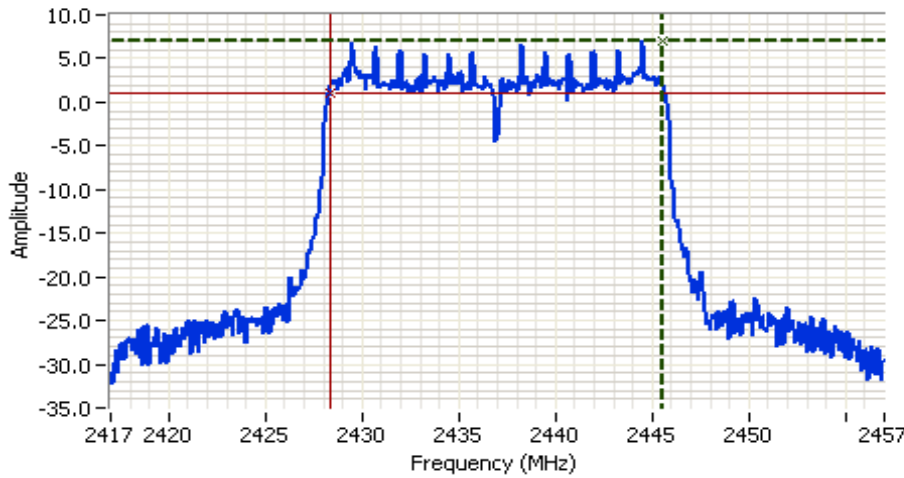

**Analyzer Settings**

Agilent Technologies, E4446A  
 CF: 2437.000 MHz  
 SPAN: 40.000 MHz  
 RB: 100 kHz  
 VB: 300 kHz  
 Detector: POS  
 Attn: 30 DB  
 RL Offset: 10.0 DB  
 Sweep Time: 3.8ms  
 Ref Lvl: 30.0 DBM

**Comments**

6dB BW: 17.133 MHz  
 802.11n20 Ch #6

Cursor 1 2445.5333 7.1

Cursor 2 2428.4000 1.1

Delta Freq. 17.133

Delta Amplitude 6.0

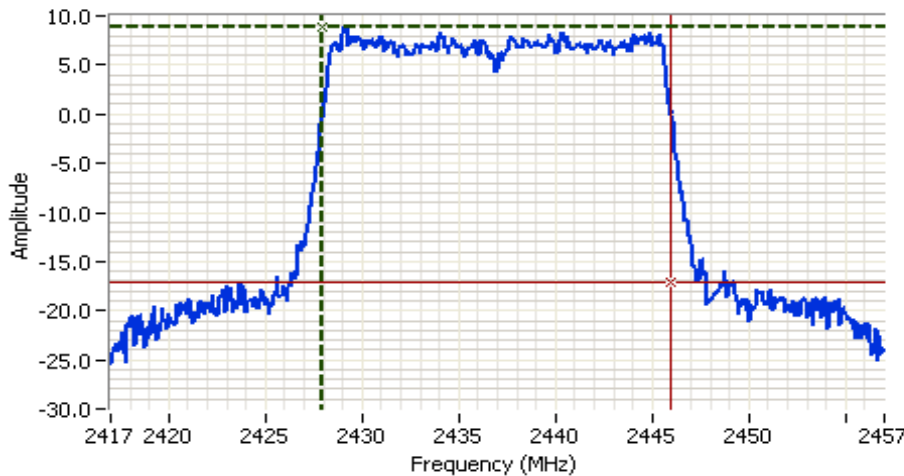

**Analyzer Settings**

Agilent Technologies, E4446A  
 CF: 2437.000 MHz  
 SPAN: 40.000 MHz  
 RB: 300 kHz  
 VB: 1.000 MHz  
 Detector: POS  
 Attn: 30 DB  
 RL Offset: 10.0 DB  
 Sweep Time: 1.0ms  
 Ref Lvl: 30.0 DBM

**Comments**

99% power BW: 17.970 MHz  
 802.11n20 Ch #6

Cursor 1 2427.9817 8.9

Cursor 2 2445.9517 -17.1

Delta Freq. 17.970

Delta Amplitude 26.0





# EMC Test Data

Client: Barracuda Networks	Job Number: JD99428
Model: BNHW028 (Dome)	T-Log Number: T101416
	Project Manager: Christine Krebill
Contact: Gary Liu	Project Coordinator: -
Standard: FCC part 15, RSS-247	Class: N/A

## Run #4a: Out of Band Spurious Emissions

Frequency MHz	Level dBm	Pol v/h	15.209 / 15.247		Detector Pk/QP/Avg	Mode / Channel	Power setting	Comments
			Limit	Margin				
2411.870	5.5	RF Port	-	-	Peak	b/1	18	RB 100 kHz;VB 300 kHz;Peak
803.001	-56.6	RF Port	-24.5	-32.1	Peak	b/1	18	RB 100 kHz;VB 300 kHz;Peak
451.250	-56.9	RF Port	-24.5	-32.4	Peak	b/1	18	RB 100 kHz;VB 300 kHz;Peak
3214.740	-47.6	RF Port	-24.5	-23.1	Peak	b/1	18	RB 100 kHz;VB 300 kHz;Peak
4823.270	-32.8	RF Port	-24.5	-8.3	Peak	b/1	18	RB 100 kHz;VB 300 kHz;Peak
3214.740	-47.6	RF Port	-24.5	-23.1	Peak	b/1	18	RB 100 kHz;VB 300 kHz;Peak
2410.470	-0.4	RF Port	-	-	Peak	g/1	13	RB 100 kHz;VB 300 kHz;Peak
799.500	-59.9	RF Port	-30.4	-29.5	Peak	g/1	13	RB 100 kHz;VB 300 kHz;Peak
3214.740	-44.1	RF Port	-30.4	-13.7	Peak	g/1	13	RB 100 kHz;VB 300 kHz;Peak
4823.270	-41.7	RF Port	-30.4	-11.3	Peak	g/1	13	RB 100 kHz;VB 300 kHz;Peak
2404.470	2.3	RF Port	-	-	Peak	n20/1	11	RB 100 kHz;VB 300 kHz;Peak
810.237	-60.4	RF Port	-27.7	-32.7	Peak	n20/1	11	RB 100 kHz;VB 300 kHz;Peak
3214.740	-46.9	RF Port	-27.7	-19.2	Peak	n20/1	11	RB 100 kHz;VB 300 kHz;Peak
4823.270	-46.0	RF Port	-27.7	-18.3	Peak	n20/1	11	RB 100 kHz;VB 300 kHz;Peak
2434.480	6.0	RF Port	-	-	Peak	b/6	21	RB 100 kHz;VB 300 kHz;Peak
476.225	-54.6	RF Port	-24.0	-30.6	Peak	b/6	21	RB 100 kHz;VB 300 kHz;Peak
815.138	-55.7	RF Port	-24.0	-31.7	Peak	b/6	21	RB 100 kHz;VB 300 kHz;Peak
4874.290	-32.2	RF Port	-24.0	-8.2	Peak	b/6	21	RB 100 kHz;VB 300 kHz;Peak
2440.480	5.0	RF Port	-	-	Peak	g/6	21	RB 100 kHz;VB 300 kHz;Peak
4874.290	-40.6	RF Port	-25.0	-15.6	Peak	g/6	21	RB 100 kHz;VB 300 kHz;Peak
3250.750	-52.0	RF Port	-25.0	-27.0	Peak	g/6	21	RB 100 kHz;VB 300 kHz;Peak
2428.480	6.6	RF Port	-	-	Peak	n20/6	21	RB 100 kHz;VB 300 kHz;Peak
3250.750	-52.1	RF Port	-23.4	-28.7	Peak	n20/6	21	RB 100 kHz;VB 300 kHz;Peak
4871.290	-38.6	RF Port	-23.4	-15.2	Peak	n20/6	21	RB 100 kHz;VB 300 kHz;Peak
2458.490	5.8	RF Port	-	-	Peak	b/11	19	RB 100 kHz;VB 300 kHz;Peak
3283.760	-50.2	RF Port	-24.2	-26.0	Peak	b/11	19	RB 100 kHz;VB 300 kHz;Peak
4925.310	-34.4	RF Port	-24.2	-10.2	Peak	b/11	19	RB 100 kHz;VB 300 kHz;Peak
2470.490	4.3	RF Port	-	-	Peak	g/11	16	RB 100 kHz;VB 300 kHz;Peak
4925.310	-46.4	RF Port	-25.7	-20.7	Peak	g/11	16	RB 100 kHz;VB 300 kHz;Peak
3283.760	-49.0	RF Port	-25.7	-23.3	Peak	g/11	16	RB 100 kHz;VB 300 kHz;Peak
2464.490	1.7	RF Port	-	-	Peak	n20/11	13	RB 100 kHz;VB 300 kHz;Peak
3283.760	-47.8	RF Port	-28.3	-19.5	Peak	n20/11	13	RB 100 kHz;VB 300 kHz;Peak
4922.310	-48.0	RF Port	-28.3	-19.7	Peak	n20/11	13	RB 100 kHz;VB 300 kHz;Peak

RBW = 100 kHz and VBW = 300 kHz for all plots.

Client: Barracuda Networks	Job Number: JD99428
Model: BNHW028 (Dome)	T-Log Number: T101416
Contact: Gary Liu	Project Manager: Christine Krebill
Standard: FCC part 15, RSS-247	Project Coordinator: -
	Class: N/A

Plots for low channel

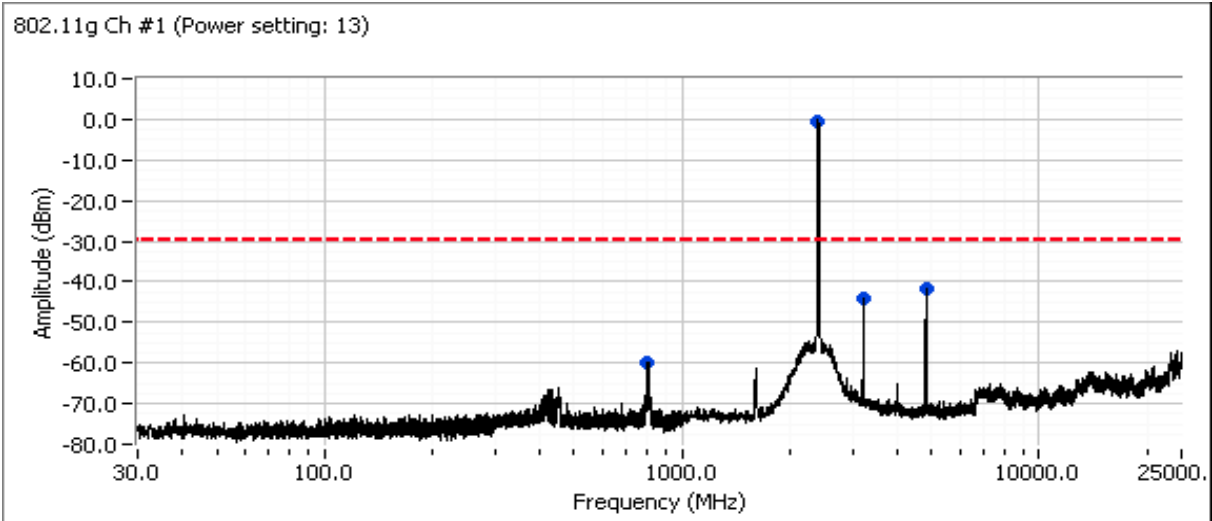
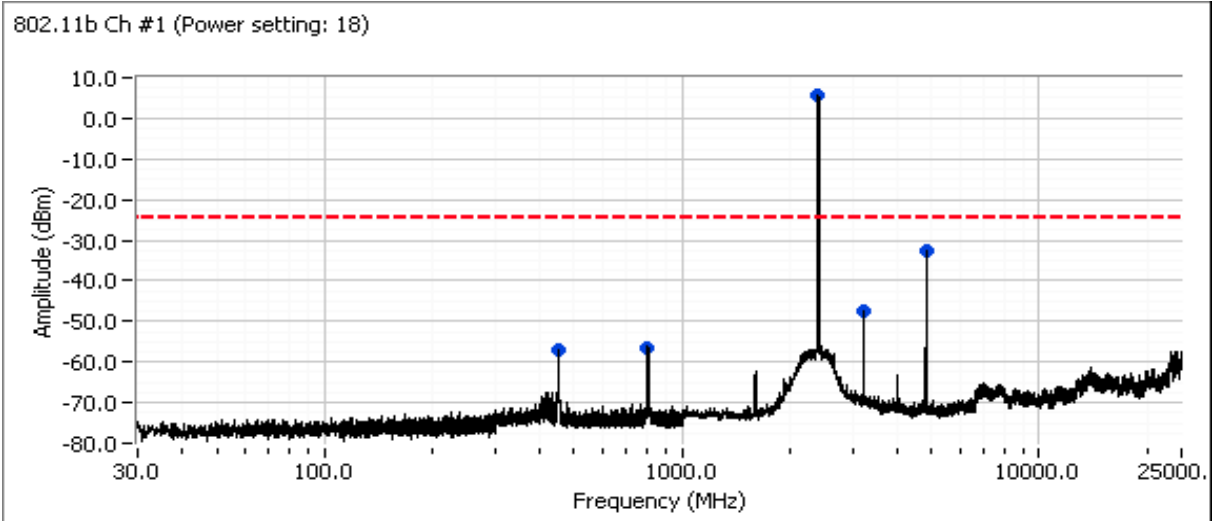

Client: Barracuda Networks	Job Number: JD99428
Model: BNHW028 (Dome)	T-Log Number: T101416
Contact: Gary Liu	Project Manager: Christine Krebill
Standard: FCC part 15, RSS-247	Project Coordinator: -
	Class: N/A

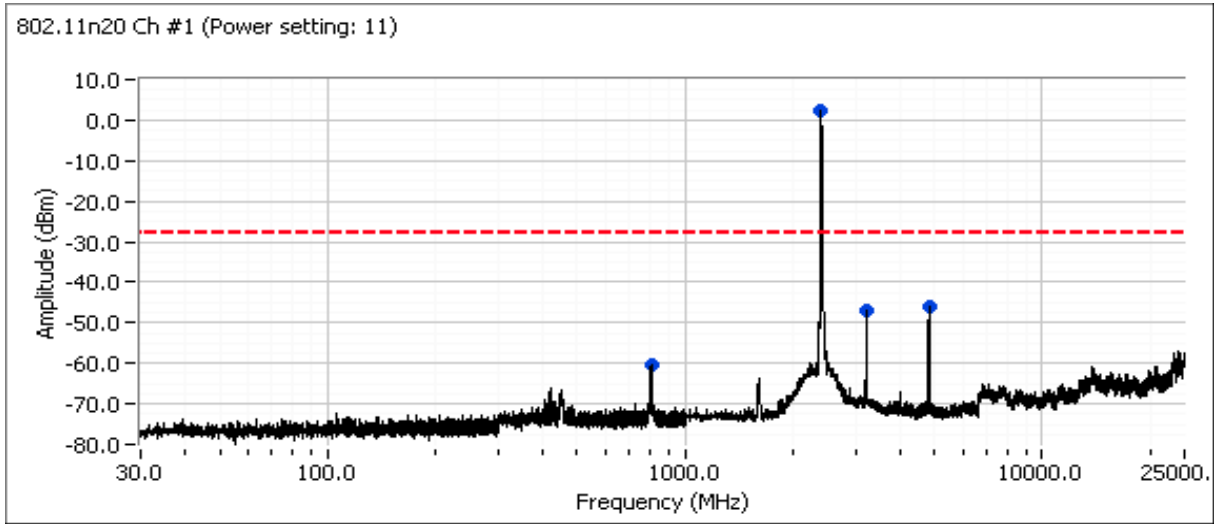

Additional plot showing compliance with -30 dBc limit from 2390 MHz to 2400 MHz. Radiated measurements used to show compliance with the limits in the restricted band below 2390 MHz.

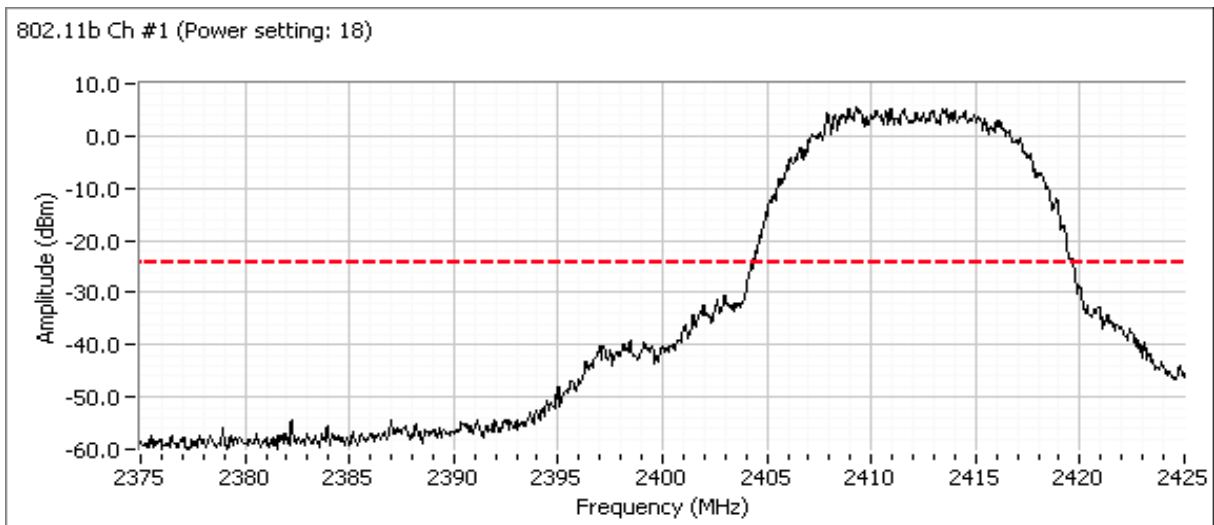

Client: Barracuda Networks	Job Number: JD99428
Model: BNHW028 (Dome)	T-Log Number: T101416
	Project Manager: Christine Krebill
Contact: Gary Liu	Project Coordinator: -
Standard: FCC part 15, RSS-247	Class: N/A

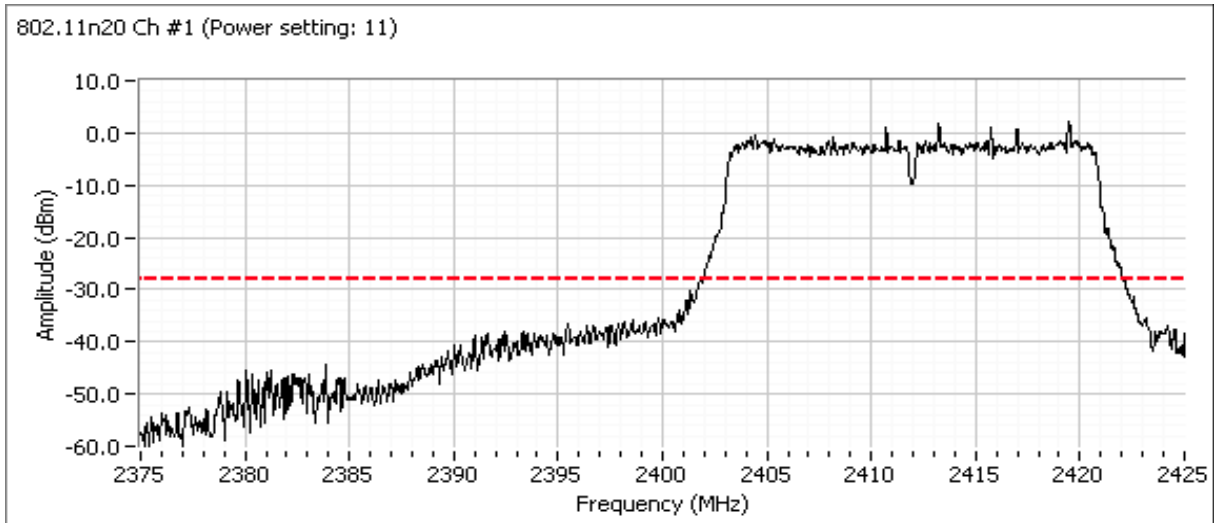
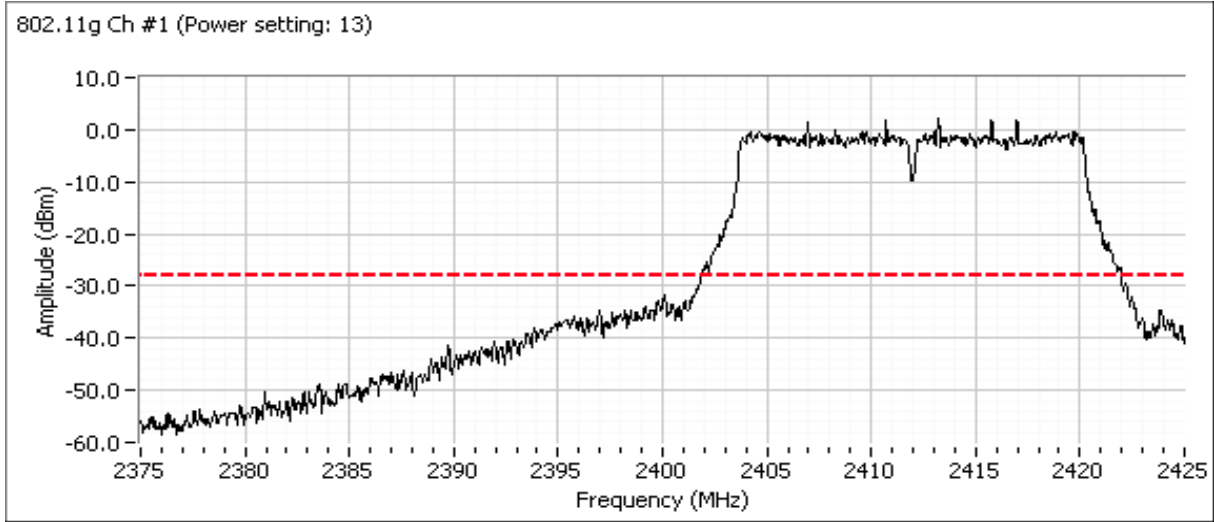

Client: Barracuda Networks	Job Number: JD99428
Model: BNHW028 (Dome)	T-Log Number: T101416
Contact: Gary Liu	Project Manager: Christine Krebill
Standard: FCC part 15, RSS-247	Project Coordinator: -
	Class: N/A

Plots for center channel

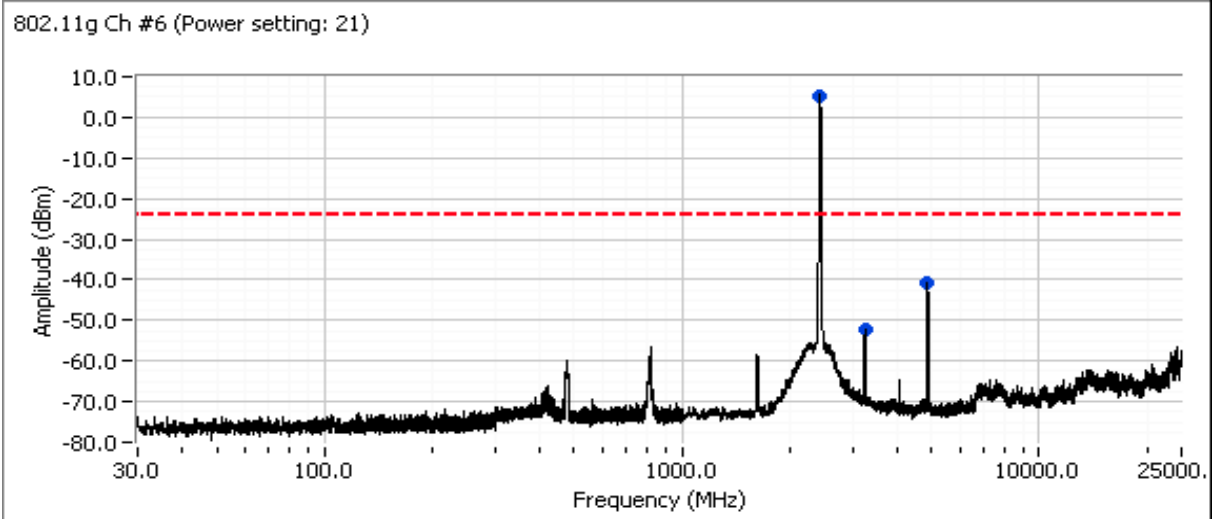
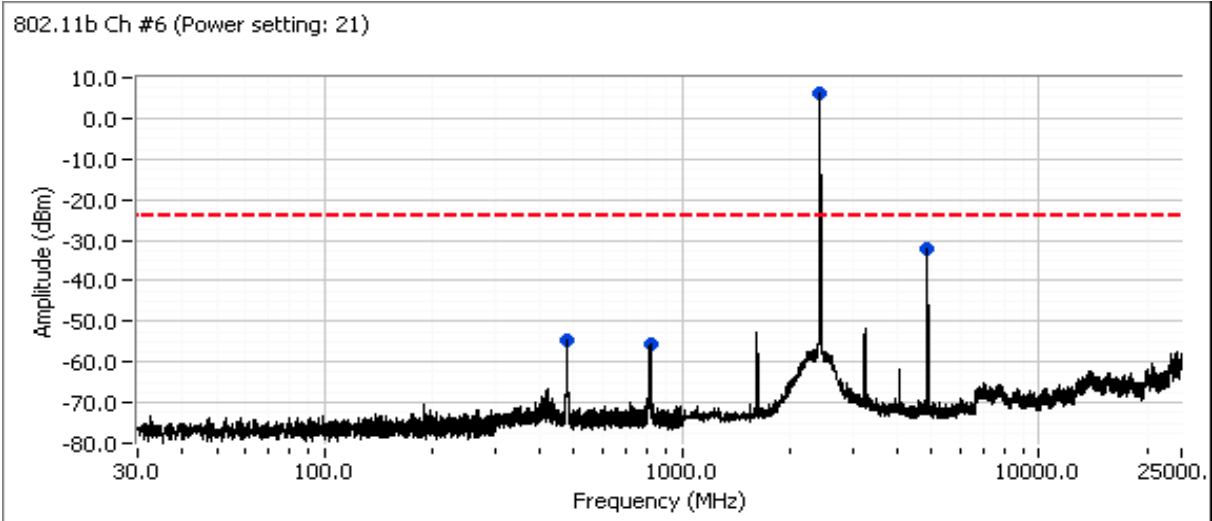

Client: Barracuda Networks	Job Number: JD99428
Model: BNHW028 (Dome)	T-Log Number: T101416
Contact: Gary Liu	Project Manager: Christine Krebill
Standard: FCC part 15, RSS-247	Project Coordinator: -
	Class: N/A

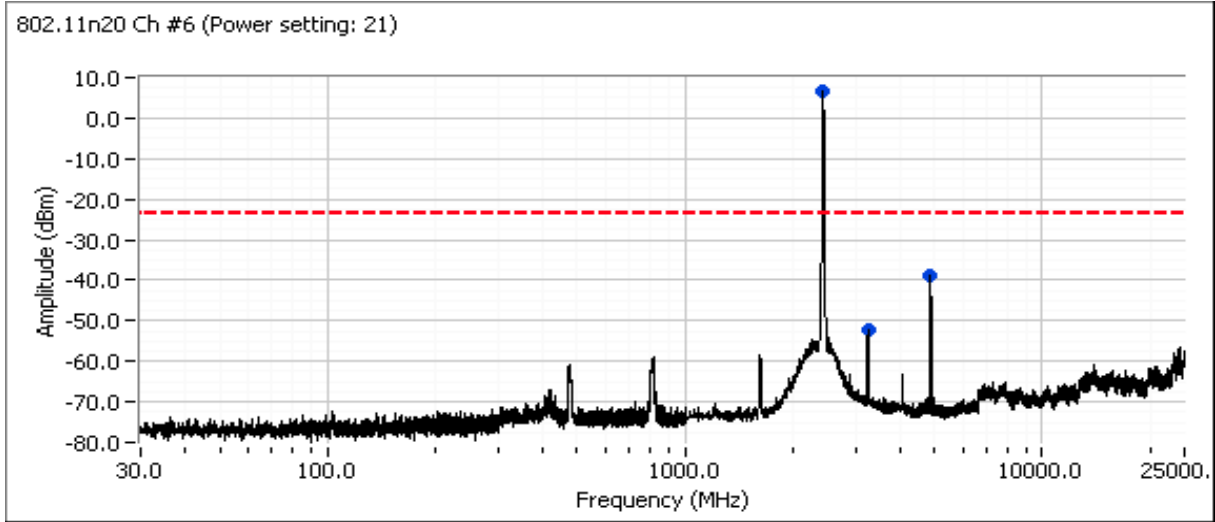

Plots for high channel

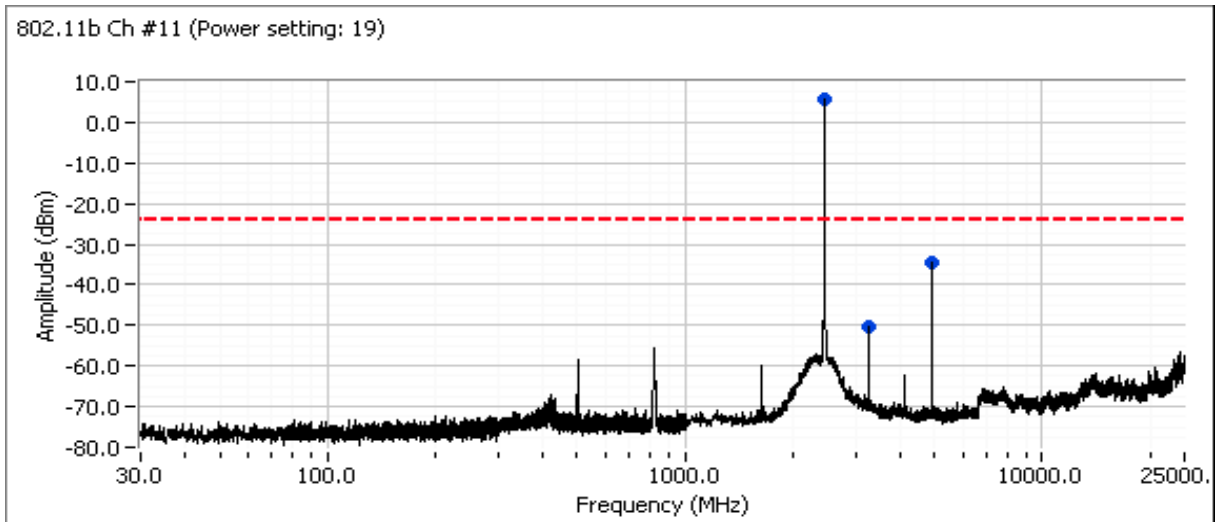

Client: Barracuda Networks	Job Number: JD99428
Model: BNHW028 (Dome)	T-Log Number: T101416
Contact: Gary Liu	Project Manager: Christine Krebill
Standard: FCC part 15, RSS-247	Project Coordinator: -
	Class: N/A

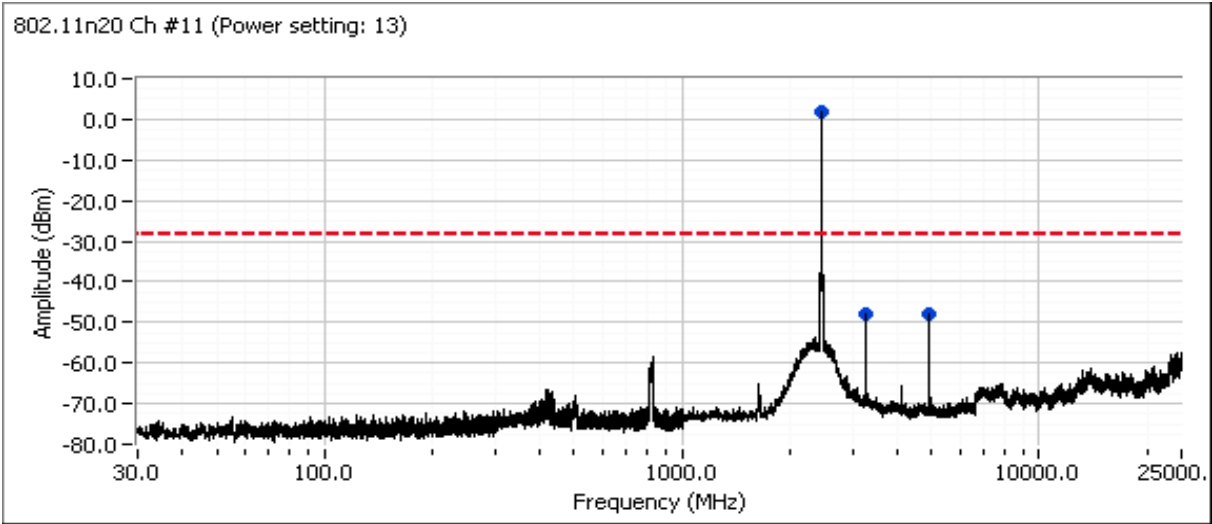
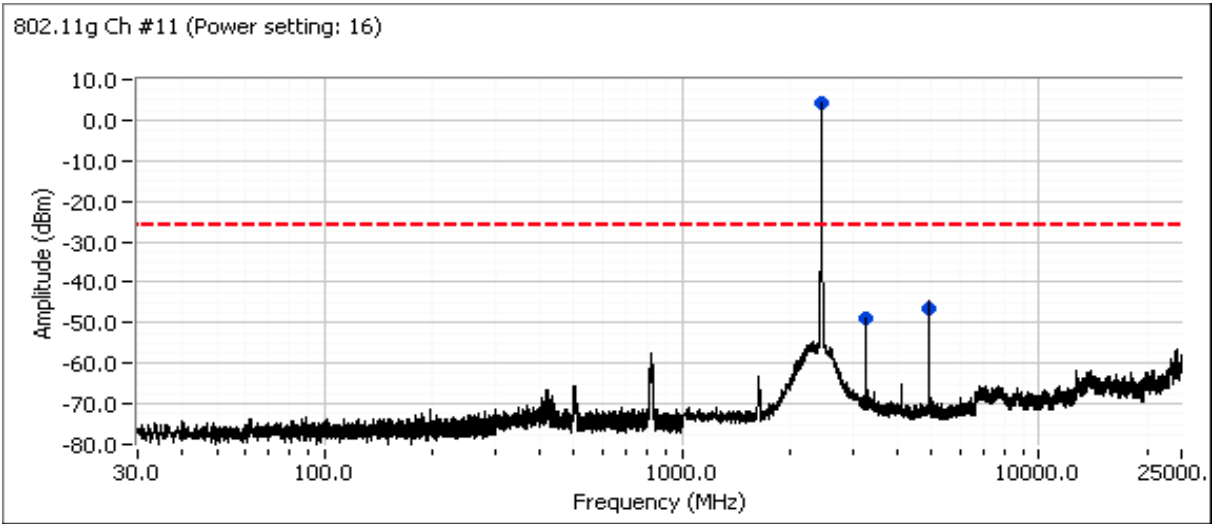



***End of Report***

This page is intentionally blank and marks the last page of this test report.