

**FCC 47 CFR PART 15 SUBPART C &  
INDUSTRY CANADA RSS-247**

**TEST REPORT**

**For**

**Network Appliance**

**Model: BNHW029-SC1**

**Trade Name:**  Barracuda

*Issued to*

**Barracuda Networks, Inc.  
5710 Fontanoso Way, San Jose, CA 95138, United States**

*Issued by*

**Compliance Certification Services Inc.  
No.11, Wugong 6th Rd., Wugu Dist.,  
New Taipei City 24891, Taiwan. (R.O.C.)  
<http://www.ccsrf.com>  
[service@ccsrf.com](mailto:service@ccsrf.com)  
Issued Date: March 23, 2016**



---

*Note: This report shall not be reproduced except in full, without the written approval of Compliance Certification Services Inc. This document may be altered or revised by Compliance Certification Services Inc. personnel only, and shall be noted in the revision section of the document.*

**Revision History**

Rev.	Issue Date	Revisions	Effect Page	Revised By
00	March 23, 2016	Initial Issue	ALL	Doris Chu
01	May 4, 2016	1. Modify company name. 2. Removed band edges fundamental frequency's limit and margin. 3. Modify density's test procedure.	P.1, P.4, P.48 ~ P.79, P.80	Doris Chu

## TABLE OF CONTENTS

<b>1. TEST RESULT CERTIFICATION .....</b>	<b>4</b>
<b>2. EUT DESCRIPTION.....</b>	<b>5</b>
<b>3. TEST METHODOLOGY.....</b>	<b>6</b>
3.1 EUT CONFIGURATION .....	6
3.2 EUT EXERCISE .....	6
3.3 GENERAL TEST PROCEDURES.....	6
3.4 FCC PART 15.205 RESTRICTED BANDS OF OPERATIONS .....	7
3.5 DESCRIPTION OF TEST MODES.....	8
<b>4. INSTRUMENT CALIBRATION .....</b>	<b>9</b>
4.1 MEASURING INSTRUMENT CALIBRATION .....	9
4.2 MEASUREMENT EQUIPMENT USED .....	9
4.3 MEASUREMENT UNCERTAINTY .....	10
<b>5. FACILITIES AND ACCREDITATIONS .....</b>	<b>11</b>
5.1 FACILITIES .....	11
5.2 EQUIPMENT .....	11
5.3 LABORATORY ACCREDITATIONS AND LISTING.....	11
5.4 TABLE OF ACCREDITATIONS AND LISTINGS.....	12
<b>6. SETUP OF EQUIPMENT UNDER TEST .....</b>	<b>13</b>
6.1 SETUP CONFIGURATION OF EUT .....	13
6.2 SUPPORT EQUIPMENT.....	13
<b>7. FCC PART 15.247 REQUIREMENTS &amp; RSS-247 REQUIREMENTS.....</b>	<b>14</b>
7.1 99% BANDWIDTH .....	14
7.2 6DB BANDWIDTH.....	28
7.3 PEAK POWER .....	42
7.4 AVERAGE POWER .....	44
7.5 BAND EDGES MEASUREMENT .....	46
7.6 PEAK POWER SPECTRAL DENSITY .....	80
7.7 RADIATED EMISSIONS .....	94
7.8 POWERLINE CONDUCTED EMISSIONS.....	124
<b>APPENDIX II PHOTOGRAPHS OF TEST SETUP .....</b>	<b>127</b>

# 1. TEST RESULT CERTIFICATION

**Applicant:** Barracuda Networks, Inc.  
5710 Fontanoso Way, San Jose, CA 95138, United States

**Manufacturer:** Barracuda Networks, Inc.  
5710 Fontanoso Way, San Jose, CA 95138, United States

**Equipment Under Test:** Network Appliance

**Model Number:** BNHW029-SC1



**Trade Name:**

**Date of Test:** March 14 ~ 18, 2016

APPLICABLE STANDARDS	
STANDARD	TEST RESULT
FCC 47 CFR Part 15 Subpart C Industry Canada RSS-247 Issue 1	No non-compliance noted

**We hereby certify that:**

The above equipment was tested by Compliance Certification Services Inc. The test data, data evaluation, test procedures, and equipment configurations shown in this report were made in accordance with the procedures given in ANSI C63.10: 2013 and the energy emitted by the sample EUT tested as described in this report is in compliance with the requirements of FCC Rules Part 15.203, 15.207, 15.209, 15.247 and Industry Canada RSS-247.

The test results of this report relate only to the tested sample EUT identified in this report.

*Approved by:*

*Reviewed by:*

---

Miller Lee  
Manager  
Compliance Certification Services Inc.

---

Angel Cheng  
Section Manager  
Compliance Certification Services Inc.

## 2. EUT DESCRIPTION

<b>Product</b>	Network Appliance			
<b>Model Number</b>	BNHW029-SC1			
<b>Trade Name</b>				
<b>Model Discrepancy</b>	N/A			
<b>Received Date</b>	December 10, 2015			
<b>Power supply</b>	Power form Power adapter. 1. PHIHONG / PSA05F-050QAL6 I/P: 100-240V, ~0.18A, 50-60 Hz O/P: 5V, 1A 2. PHIHONG / PSAI05R-050QL6 I/P: 100-240V, ~0.3A, 50-60 Hz O/P: 5V, 1A			
<b>Frequency Range</b>	2412 ~ 2462 MHz			
<b>Transmit Power</b>	<b>Mode</b>	<b>Frequency Range</b>	<b>Output Power (dBm)</b>	<b>Output Power (W)</b>
	IEEE 802.11b	2412 - 2462	19.97	0.0993
	IEEE 802.11g	2412 - 2462	21.14	0.1300
	IEEE 802.11n HT 20 MHz	2412 - 2462	24.36	0.2731
	IEEE 802.11n HT 40 MHz	2422 - 2452	24.48	0.2809
<b>Number of Channels</b>	IEEE 802.11b/g mode: 11 Channels IEEE 802.11n HT 20 MHz mode: 11 Channels IEEE 802.11n HT 40 MHz mode: 7 Channels			
<b>Antenna Specification</b>	Print Antenna Model: UD92C02-1V0 A: Gain: 0.9 dBi B: Gain: 3 dBi			

**Remark:**

1. The sample selected for test was engineering sample that approximated to production product and was provided by manufacturer.
2. This submittal(s) (test report) is intended for FCC ID: **2AHVQ-SC1** & IC: **21331-SC1** filing to comply with FCC Part 15C, Section 15.203, 15.207, 15.209 and IC RSS-247 & RSS-Gen Issue 4.

### **3. TEST METHODOLOGY**

The tests documented in this report were performed in accordance with ANSI C63.10: 2009 and FCC CFR 47 Part 15.207, 15.209, 15.247, KDB558074.

The tests documented in this report were performed in accordance with IC RSS-247, IC RSS-Gen Issue 4 and ANSI C63.10:2013.

This submittal(s) (test report) is intended for IC Certification with Industry Canada RSS-247.

#### **3.1 EUT CONFIGURATION**

The EUT configuration for testing is installed on RF field strength measurement to meet the Commissions requirement and operating in a manner that intends to maximize its emission characteristics in a continuous normal application.

#### **3.2 EUT EXERCISE**

The EUT was operated in the engineering mode to fix the TX frequency that was for the purpose of the measurements.

According to its specifications, the EUT must comply with the requirements of the Section 15.207, 15.209 and 15.247 under the FCC Rules Part 15 Subpart C.

The tests documented in this report were performed in accordance with IC RSS-247, IC RSS-Gen Issue 4, IC RSS-102, and ANSI C63.10: 2013.

#### **3.3 GENERAL TEST PROCEDURES**

##### **Conducted Emissions**

According to the requirements in ANSI C63.10: 2013 Conducted emissions from the EUT measured in the frequency range between 0.15 MHz and 30MHz using CISPR Quasi-peak and average detector modes.

##### **Radiated Emissions**

The EUT is placed on a turn table, which is 1.5 m above ground plane. The turntable shall rotate 360 degrees to determine the position of maximum emission level. EUT is set 3m away from the receiving antenna, which varied from 1m to 4m to find out the highest emission. And also, each emission was to be maximized by changing the polarization of receiving antenna both horizontal and vertical. In order to find out the maximum emissions, exploratory radiated emission measurements were made according to the requirements in ANSI C63.10: 2013.

### 3.4 FCC PART 15.205 RESTRICTED BANDS OF OPERATIONS

(a) Except as shown in paragraph (d) of this section, only spurious emissions are permitted in any of the frequency bands listed below:

MHz	MHz	MHz	GHz
0.090 - 0.110	16.42 - 16.423	399.9 - 410	4.5 - 5.15
<sup>1</sup> 0.495 - 0.505	16.69475 - 16.69525	608 - 614	5.35 - 5.46
2.1735 - 2.1905	16.80425 - 16.80475	960 - 1240	7.25 - 7.75
4.125 - 4.128	25.5 - 25.67	1300 - 1427	8.025 - 8.5
4.17725 - 4.17775	37.5 - 38.25	1435 - 1626.5	9.0 - 9.2
4.20725 - 4.20775	73 - 74.6	1645.5 - 1646.5	9.3 - 9.5
6.215 - 6.218	74.8 - 75.2	1660 - 1710	10.6 - 12.7
6.26775 - 6.26825	108 - 121.94	1718.8 - 1722.2	13.25 - 13.4
6.31175 - 6.31225	123 - 138	2200 - 2300	14.47 - 14.5
8.291 - 8.294	149.9 - 150.05	2310 - 2390	15.35 - 16.2
8.362 - 8.366	156.52475 -	2483.5 - 2500	17.7 - 21.4
8.37625 - 8.38675	156.52525	2655 - 2900	22.01 - 23.12
8.41425 - 8.41475	156.7 - 156.9	3260 - 3267	23.6 - 24.0
12.29 - 12.293	162.0125 - 167.17	3332 - 3339	31.2 - 31.8
12.51975 - 12.52025	167.72 - 173.2	3345.8 - 3358	36.43 - 36.5
12.57675 - 12.57725	240 - 285	3600 - 4400	( <sup>2</sup> )
13.36 - 13.41	322 - 335.4		

<sup>1</sup> Until February 1, 1999, this restricted band shall be 0.490-0.510 MHz.

<sup>2</sup> Above 38.6

(b) Except as provided in paragraphs (d) and (e), the field strength of emissions appearing within these frequency bands shall not exceed the limits shown in Section 15.209. At frequencies equal to or less than 1000 MHz, compliance with the limits in Section 15.209 shall be demonstrated using measurement instrumentation employing a CISPR quasi-peak detector. Above 1000 MHz, compliance with the emission limits in Section 15.209 shall be demonstrated based on the average value of the measured emissions. The provisions in Section 15.35 apply to these measurements.

### 3.5 DESCRIPTION OF TEST MODES

The EUT (model: BNHW029-SC1) had been tested under operating condition.

The EUT is a 2x2 configuration spatial MIMO (2Tx & 2Rx) without beam forming function that operate in double TX chains and double RX chains. The 2x2 configuration is implemented with two outside TX & RX chains (Chain 0 and 1).

Software used to control the EUT for staying in continuous transmitting and receiving mode was programmed.

After verification, all tests carried out are with the worst-case test modes as shown below except radiated spurious emission below 1GHz and power line conducted emissions below 30MHz, which worst case was in normal link mode and receiving radiated spurious emission above 1GHz, which worst case was in CH Mid mode only.

**IEEE 802.11b mode:**

Channel Low (2412MHz), Channel Mid (2437MHz) and Channel High (2462MHz) with 1Mbps data rate were chosen for full testing.

**IEEE 802.11g mode:**

Channel Low (2412MHz), Channel Mid (2437MHz) and Channel High (2462MHz) with 6Mbps data rate were chosen for full testing.

**IEEE 802.11n HT 20 MHz mode:**

Channel Low (2412MHz), Channel Mid (2437MHz) and Channel High (2462MHz) with 6.5Mbps data rate were chosen for full testing.

**IEEE 802.11n HT 40 MHz mode:**

Channel Low (2422MHz), Channel Mid (2437MHz) and Channel High (2452MHz) with 13.5Mbps data rate were chosen for full testing.

The field strength of spurious emission was measured in the following position: EUT stand-up position (Z axis), lie-down position (X, Y axis). The worst emission was found in lie-down position (X axis) and the worst case was recorded.



## 4. INSTRUMENT CALIBRATION

### 4.1 MEASURING INSTRUMENT CALIBRATION

The measuring equipment, which was utilized in performing the tests documented herein, has been calibrated in accordance with the manufacturer's recommendations for utilizing calibration equipment, which is traceable to recognized national standards.

### 4.2 MEASUREMENT EQUIPMENT USED

#### Equipment Used for Emissions Measurement

*Remark: Each piece of equipment is scheduled for calibration once a year and Loop Antenna is scheduled for calibration once three years.*

Conducted Emissions Test Site				
Name of Equipment	Manufacturer	Model	Serial Number	Calibration Due
Spectrum Analyzer	Agilent	E4446A	US42510252	12/07/2016
Thermostatic/Humidity Chamber	TAICHY	MHG-150LF	930619	10/07/2016
AC Power Source	EXTECH	6205	1140845	N.C.R
DC Power Supply	ABM	8301HD	D011531	N.C.R
Power Meter	Anritsu	ML2495A	1012009	07/07/2016
Power Sensor	Anritsu	MA2411A	0917072	07/07/2016
Spectrum Analyzer	ROHDE&SCHWARZ	FSV40	101073	07/19/2016

Wugu 966 Chamber A				
Name of Equipment	Manufacturer	Model	Serial Number	Calibration Due
Spectrum Analyzer	Agilent	E4446A	US42510268	02/14/2017
EMI Test Receiver	R&S	ESCI	100064	06/03/2016
Bilog Antenna	Sunol Sciences	JB3	A030105	08/05/2016
Horn Antenna	EMCO	3117	00055165	02/23/2017
Horn Antenna	EMCO	3116	26370	01/14/2017
Turn Table	CCS	CC-T-1F	N/A	N.C.R
Antenna Tower	CCS	CC-A-1F	N/A	N.C.R
Controller	CCS	CC-C-1F	N/A	N.C.R
Pre-Amplifier	MITEQ	1652-3000	1490939	08/09/2016
Pre-Amplifier	EMC	EMC 012635	980151	06/04/2016
Pre-Amplifier	MITEQ	AMF-6F-260400-40-8P	985646	01/13/2017
Coaxial Cable	Huber+Suhner	102	29212/2	01/11/2017
Coaxial Cable	Huber+Suhner	102	29406/2	01/11/2017
Test S/W	EZ-EMC (CCS-3A1RE)			

Conducted Emission room # B				
Name of Equipment	Manufacturer	Model	Serial Number	Calibration Due
EMI Test Receiver	R&S	ESCI	101073	09/08/2016
LISN	R&S	ENV216	101054	06/06/2016
LISN	SCHWARZBECK	NSLK 8127	8127-541	11/22/2016
Capacitive Voltage Probe	FCC	F-CVP-1	100185	03/08/2017
Test S/W	CCS-3A1-CE			

### 4.3 MEASUREMENT UNCERTAINTY

PARAMETER	UNCERTAINTY
Powerline Conducted Emission	+/- 1.2575
3M Semi Anechoic Chamber / 30M~200M	+/- 4.0138
3M Semi Anechoic Chamber / 200M~1000M	+/- 3.9483
3M Semi Anechoic Chamber / 1G~8G	+/- 2.5975
3M Semi Anechoic Chamber / 8G~18G	+/- 2.6112
3M Semi Anechoic Chamber / 18G~26G	+/- 2.7389
3M Semi Anechoic Chamber / 26G~40G	+/- 2.9683

**Remark:** This uncertainty represents an expanded uncertainty expressed at approximately the 95% confidence level using a coverage factor of  $k=2$ .

## 5. FACILITIES AND ACCREDITATIONS

### 5.1 FACILITIES

All measurement facilities used to collect the measurement data are located at

- No.199, Chungsen Road, Hsintien City, Taipei Hsien, Taiwan, R.O.C.  
Tel: 886-2-2217-0894 / Fax: 886-2-2217-1029
- No.11, Wugong 6th Rd., Wugu Dist., New Taipei City 24891, Taiwan. (R.O.C.)  
Tel: 886-2-2299-9720 / Fax: 886-2-2298-4045
- No.81-1, Lane 210, Bade 2nd Rd., Lujhu Township, Taoyuan County 33841, TAIWAN, R.O.C.  
Tel: 886-3-324-0332 / Fax: 886-3-324-5235

The sites are constructed in conformance with the requirements of ANSI C63.7, ANSI C63.10: 2013 and CISPR Publication 22.

### 5.2 EQUIPMENT

Radiated emissions are measured with one or more of the following types of linearly polarized antennas: tuned dipole, biconical, log periodic, bi-log, ridged waveguide, horn and/or Loop. Spectrum analyzers with pre-selectors and quasi-peak detectors are used to perform radiated measurements.

Conducted emissions are measured with Line Impedance Stabilization Networks and EMI Test Receivers.



Calibrated wideband preamplifiers, coaxial cables, and coaxial attenuators are also used for making measurements.

All receiving equipment conforms to CISPR Publication 16-1, "Radio Interference Measuring Apparatus and Measurement Methods."

### 5.3 LABORATORY ACCREDITATIONS AND LISTING

The test facilities used to perform radiated and conducted emissions tests are accredited by American Association for Laboratory Accreditation Program for the specific scope accreditation under Lab Code: 0824-01 to perform Electromagnetic Interference tests according to FCC Part 15 and CISPR 22 requirements. In addition, the test facilities are listed with Industry Canada, Certification and Engineering Bureau, IC 2324G-1 for 3M Semi Anechoic Chamber A, 2324G-2 for 3M Semi Anechoic Chamber B.

### 5.4 TABLE OF ACCREDITATIONS AND LISTINGS

Country	Agency	Scope of Accreditation	Logo
USA	FCC	3M Semi Anechoic Chamber (FCC MRA: TW1039) to perform FCC Part 15 measurements	 FCC MRA: TW1039
Taiwan	TAF	LP0002, RTTE01, FCC Method-47 CFR Part 15 Subpart C, D, E, RSS-210, RSS-310 IDA TS SRD, AS/NZS 4268, AS/NZS 4771, TS 12.1 & 12.2, ETSI EN 300 440-1, ETSI EN 300 440-2, ETSI EN 300 328, ETSI EN 300 220-1, ETSI EN 300 220-2, ETSI EN 301 893, ETSI EN 301 489-1/3/7/17 FCC OET Bulletin 65 + Supplement C, EN 50360, EN 50361, EN 50371, RSS 102, EN 50383, EN 50385, EN 50392, IEC 62209, CNS 14958-1, CNS 14959 FCC Method -47 CFR Part 15 Subpart B IEC / EN 61000-3-2, IEC / EN 61000-3-3, IEC / EN 61000-4-2/3/4/5/6/8/11	
Canada	Industry Canada	3M Semi Anechoic Chamber (IC 2324G-1 / IC 2324G-2) to perform	 IC 2324G-1 IC 2324G-2

\* No part of this report may be used to claim or imply product endorsement by A2LA or any agency of the US Government.

## 6. SETUP OF EQUIPMENT UNDER TEST

### 6.1 SETUP CONFIGURATION OF EUT

See test photographs attached in Appendix II for the actual connections between EUT and support equipment.

### 6.2 SUPPORT EQUIPMENT

No	Equipment	Brand	Model	Series No.	FCC ID	Data Cable	Power Cord
	N/A						

**Remark:**

1. *All the equipment/cables were placed in the worst-case configuration to maximize the emission during the test.*
2. *Grounding was established in accordance with the manufacturer's requirements and conditions for the intended use.*

## 7. FCC PART 15.247 REQUIREMENTS & RSS-247 REQUIREMENTS

### 7.1 99% BANDWIDTH

#### Test Configuration

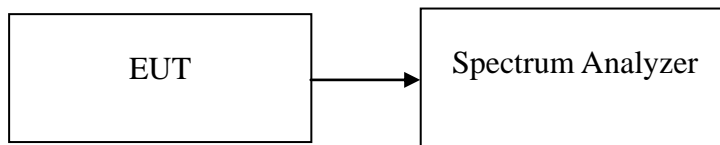

#### TEST PROCEDURE

The resolution bandwidth shall be set to as close to 1% of the selected span as is possible without being below 1%. The video bandwidth shall be set to 3 times the resolution bandwidth. Video averaging is not permitted. Where practical, a sampling detector shall be used since a peak or, peak hold.

**Test Data**

**IEEE 802.11b mode**

Channel	Frequency (MHz)	99% Bandwidth (MHz)
Low	2412	15.0000
Mid	2437	15.8173
High	2462	15.1923

**IEEE 802.11g mode**

Channel	Frequency (MHz)	99% Bandwidth (MHz)
Low	2412	17.2115
Mid	2437	17.2596
High	2462	17.3557

**IEEE 802.11n HT 20 MHz mode / Chain 0**

Channel	Frequency (MHz)	99% Bandwidth (MHz)
Low	2412	18.1250
Mid	2437	18.1250
High	2462	18.1250

**IEEE 802.11n HT 20 MHz mode / Chain 1**

Channel	Frequency (MHz)	99% Bandwidth (MHz)
Low	2412	18.0769
Mid	2437	18.0769
High	2462	18.0769

**IEEE 802.11n HT 40 MHz mode / Chain 0**

Channel	Frequency (MHz)	99% Bandwidth (MHz)
Low	2422	36.6666
Mid	2437	36.6666
High	2452	36.6666

**IEEE 802.11n HT 40 MHz mode / Chain 1**

Channel	Frequency (MHz)	99% Bandwidth (MHz)
Low	2422	36.9230
Mid	2437	36.9230
High	2452	36.9230

**Test Plot**

**IEEE 802.11b mode  
99% Bandwidth (CH Low)**

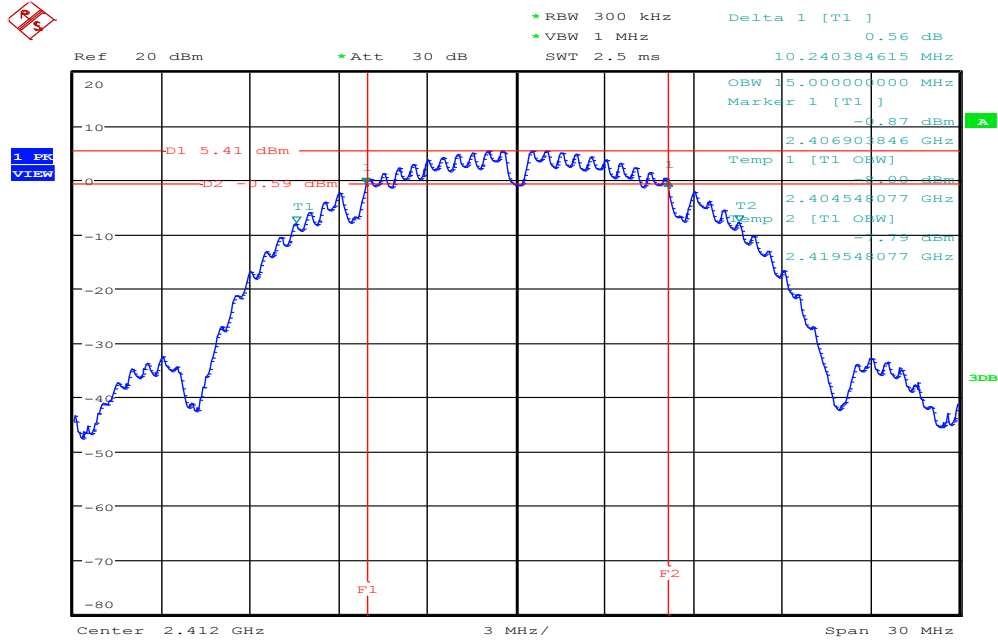

Date: 18.MAR.2016 16:56:55

**99% Bandwidth (CH Mid)**

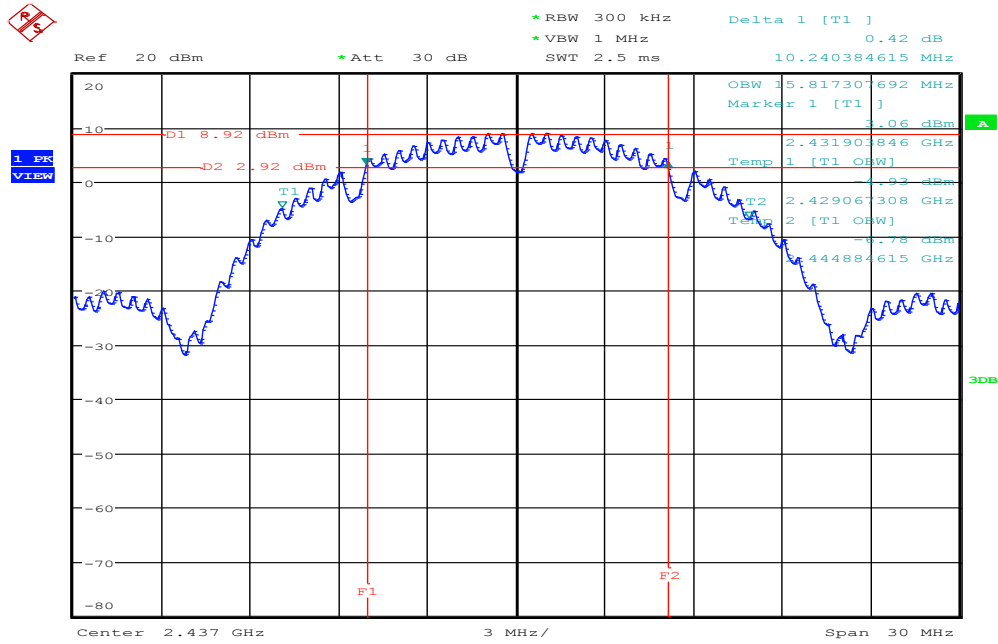

Date: 18.MAR.2016 16:58:35



### 99% Bandwidth (CH High)

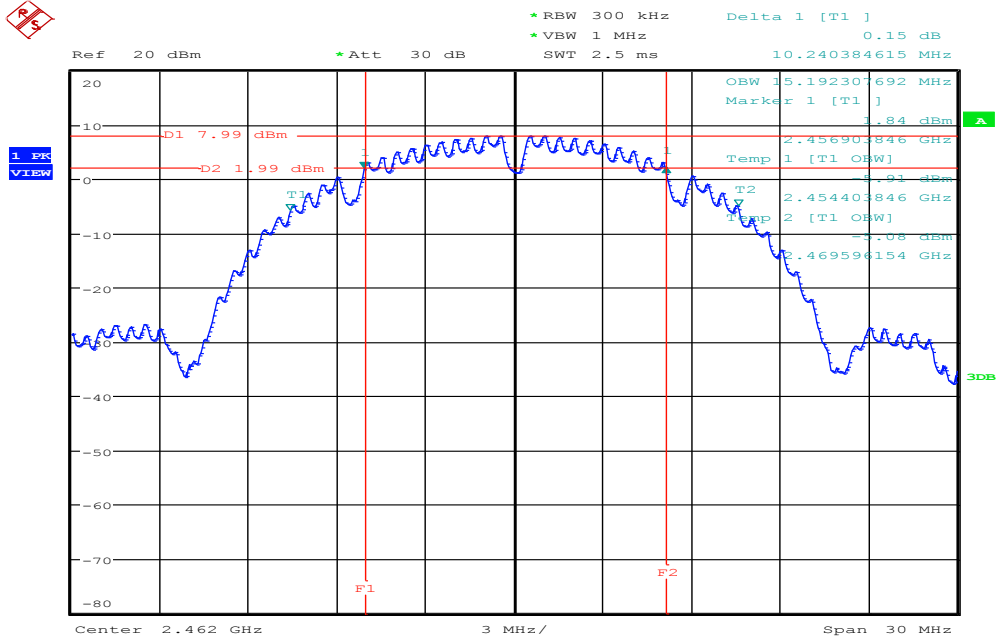

Date: 18.MAR.2016 16:59:42

**IEEE 802.11g mode  
99% Bandwidth (CH Low)**

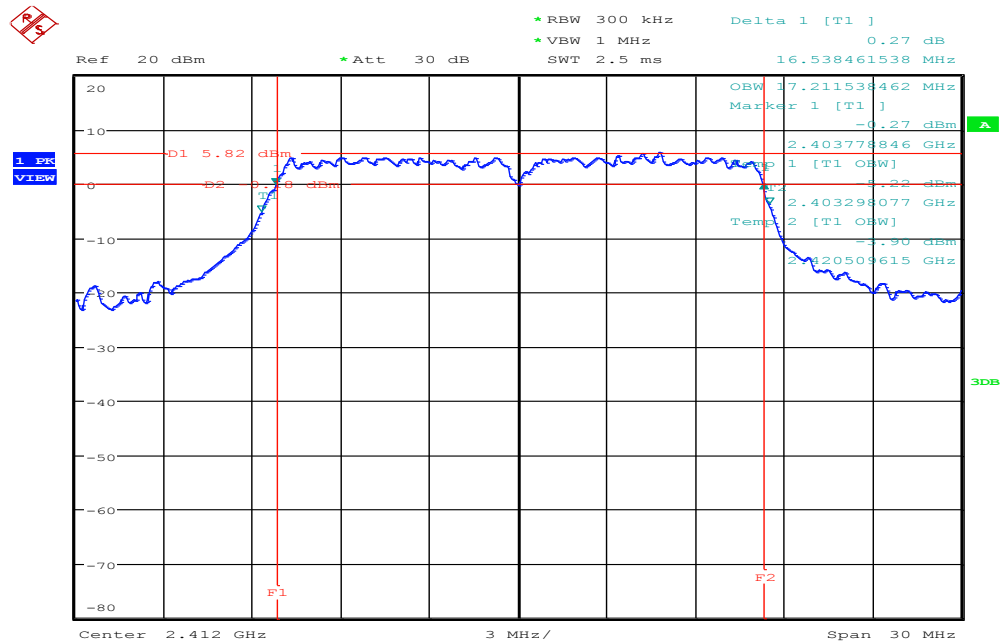

Date: 18.MAR.2016 17:02:01

**99% Bandwidth (CH Mid)**

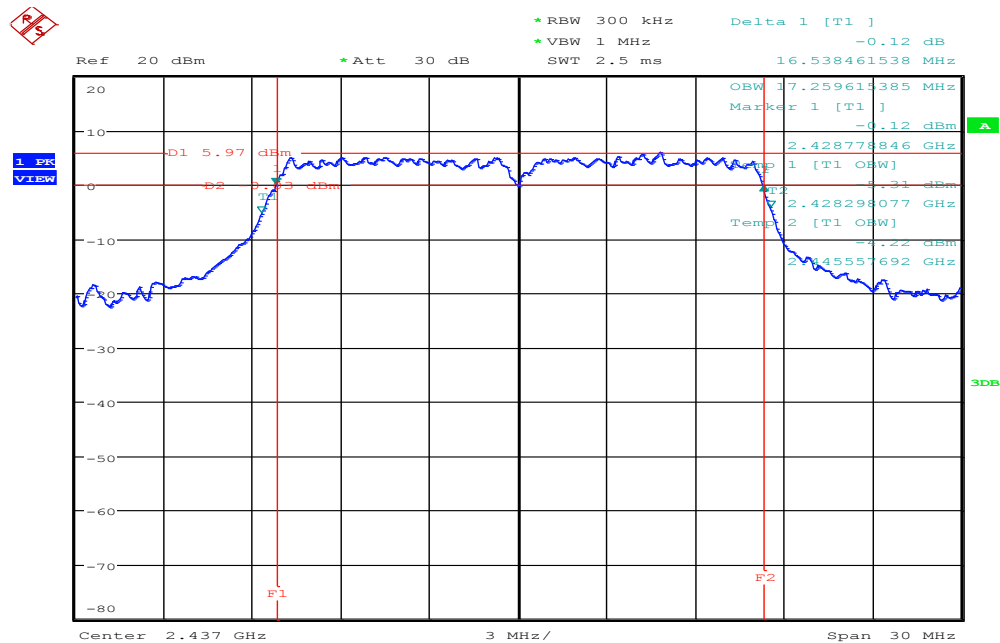

Date: 18.MAR.2016 17:03:18

### 99% Bandwidth (CH High)

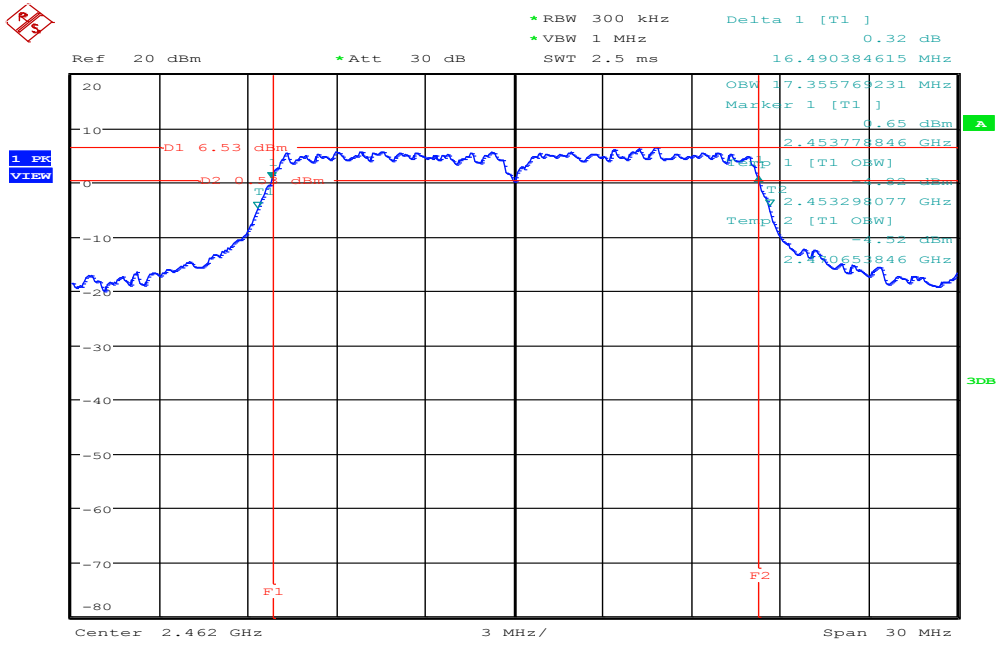

Date: 18.MAR.2016 17:04:31

**IEEE 802.11n HT 20 MHz mode / Chain 0**

**99% Bandwidth (CH Low)**

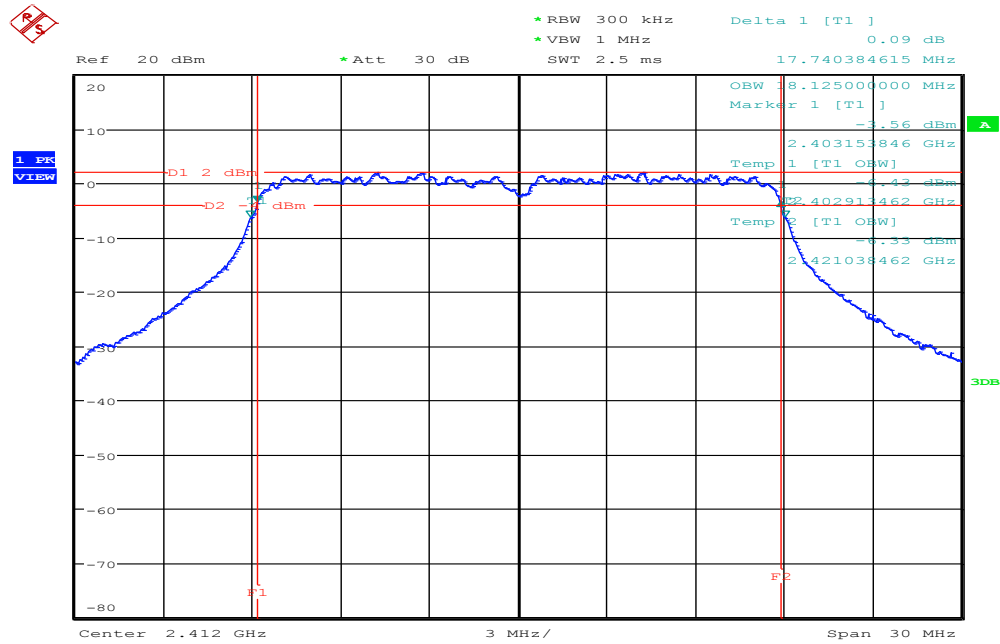

Date: 18.MAR.2016 17:14:35

**99% Bandwidth (CH Mid)**

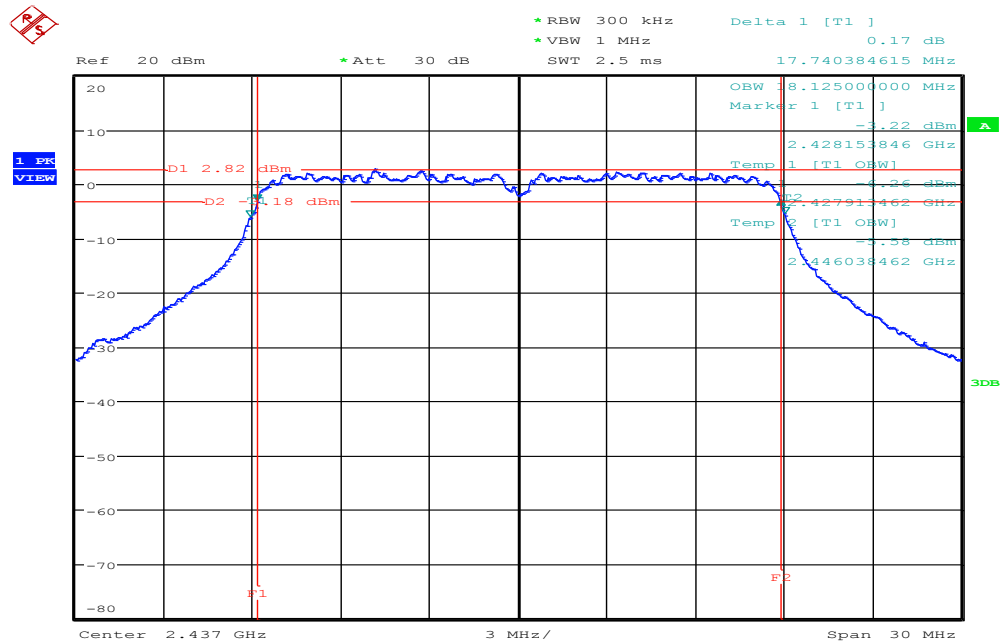

Date: 18.MAR.2016 17:13:16

### 99% Bandwidth (CH High)

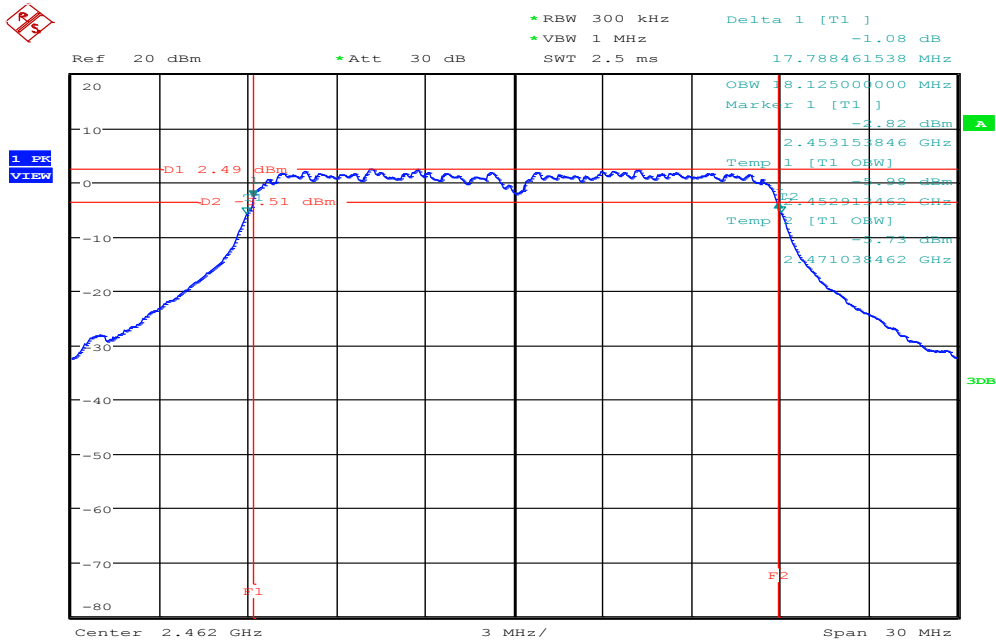

Date: 18.MAR.2016 17:11:34

### IEEE 802.11n HT 20 MHz mode / Chain 1

### 99% Bandwidth (CH Low)

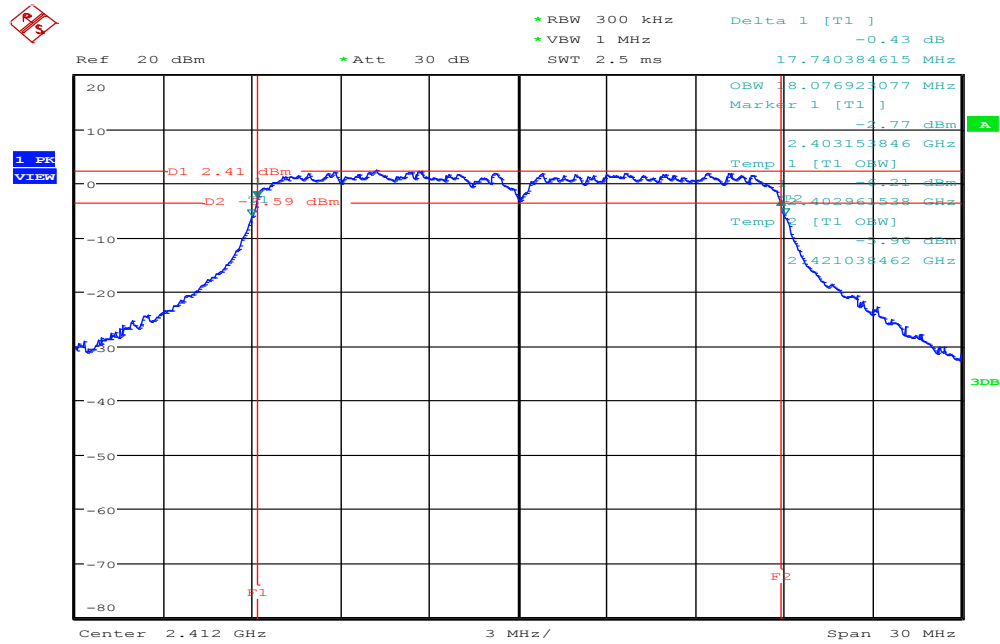

Date: 18.MAR.2016 17:06:58

### 99% Bandwidth (CH Mid)

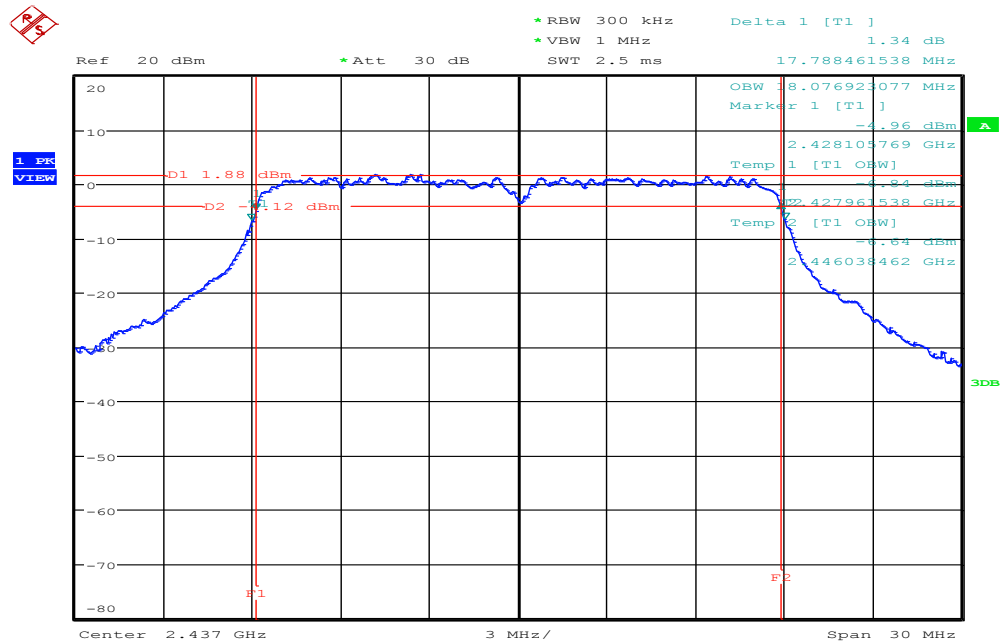

Date: 18.MAR.2016 17:08:19

### 99% Bandwidth (CH High)

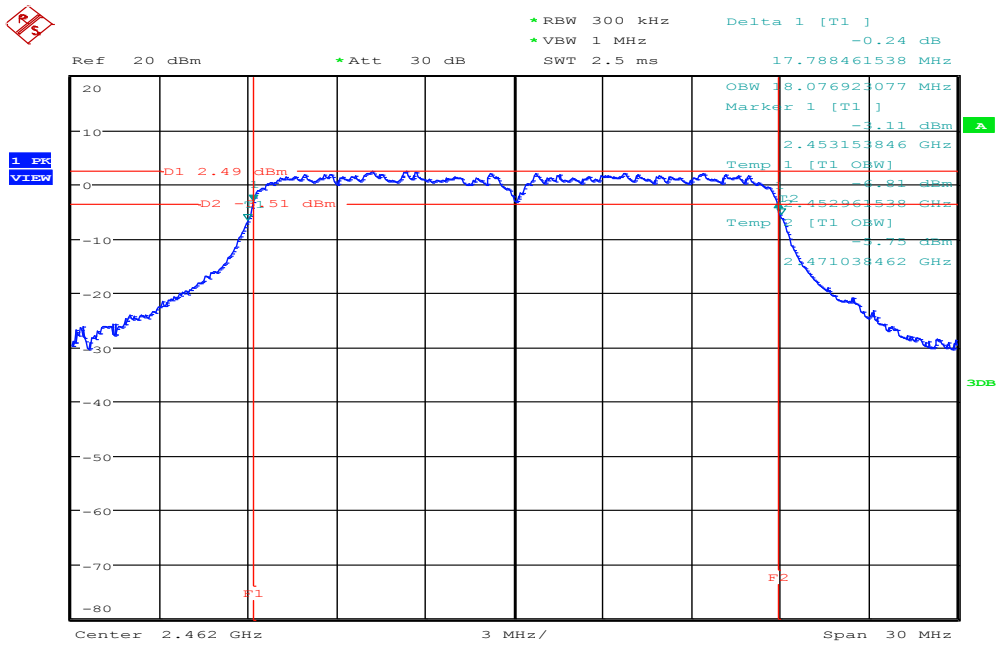

Date: 18.MAR.2016 17:09:44

### IEEE 802.11n HT 40 MHz mode / Chain 0

### 99% Bandwidth (CH Low)

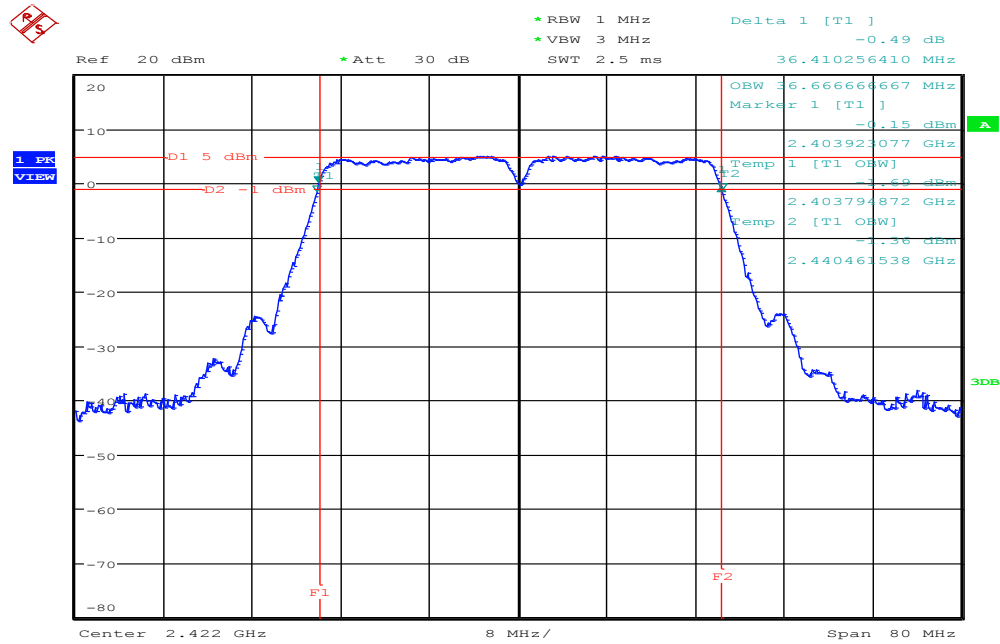

Date: 18.MAR.2016 17:18:33

### 99% Bandwidth (CH Mid)

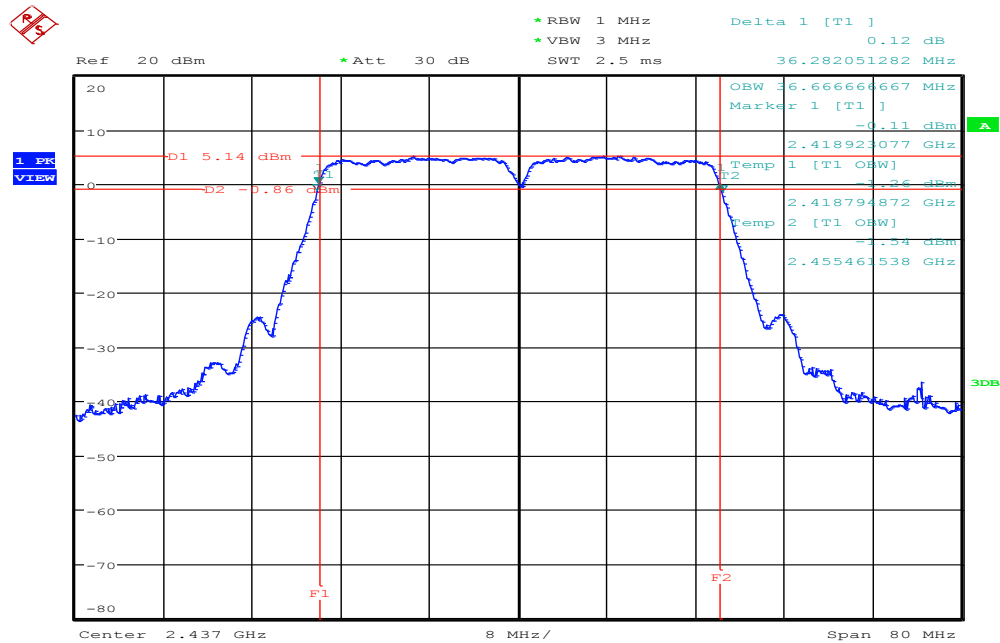

Date: 18.MAR.2016 17:19:51



### 99% Bandwidth (CH High)

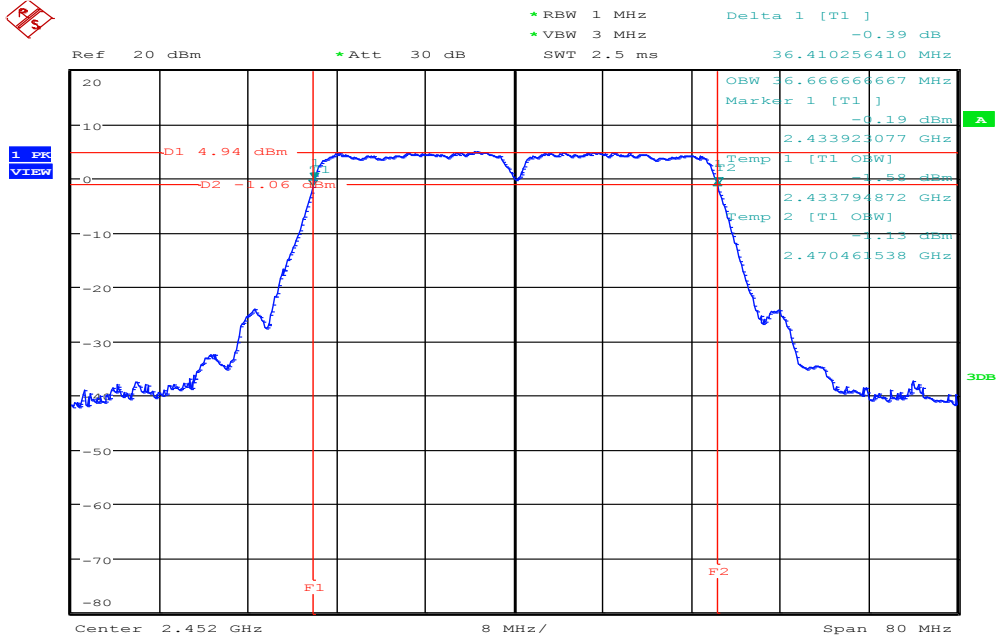

Date: 18.MAR.2016 17:21:09

**IEEE 802.11n HT 40 MHz mode / Chain 1**

**99% Bandwidth (CH Low)**

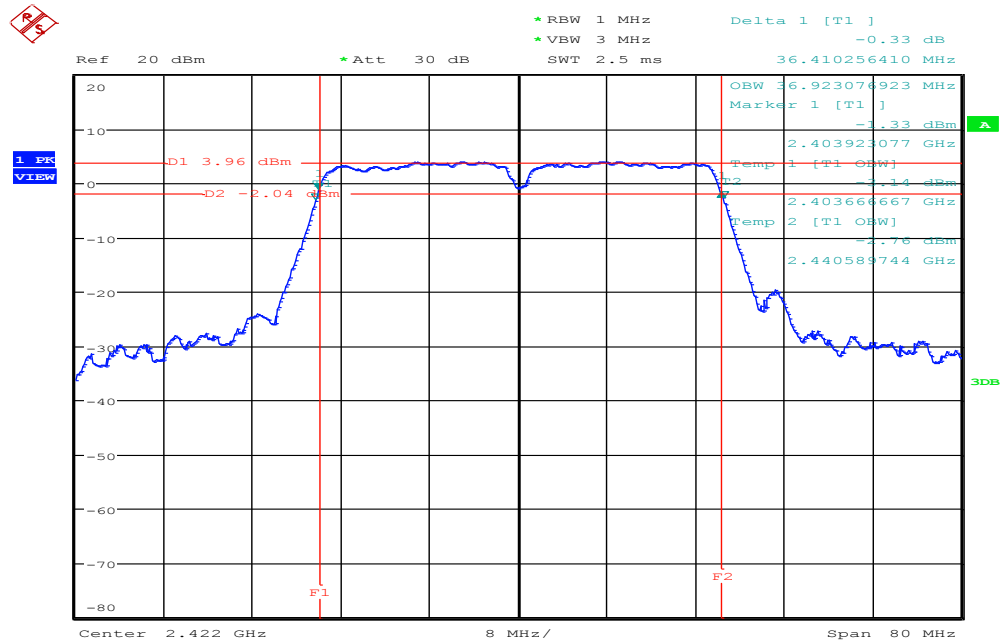

Date: 18.MAR.2016 17:27:12

**99% Bandwidth (CH Mid)**

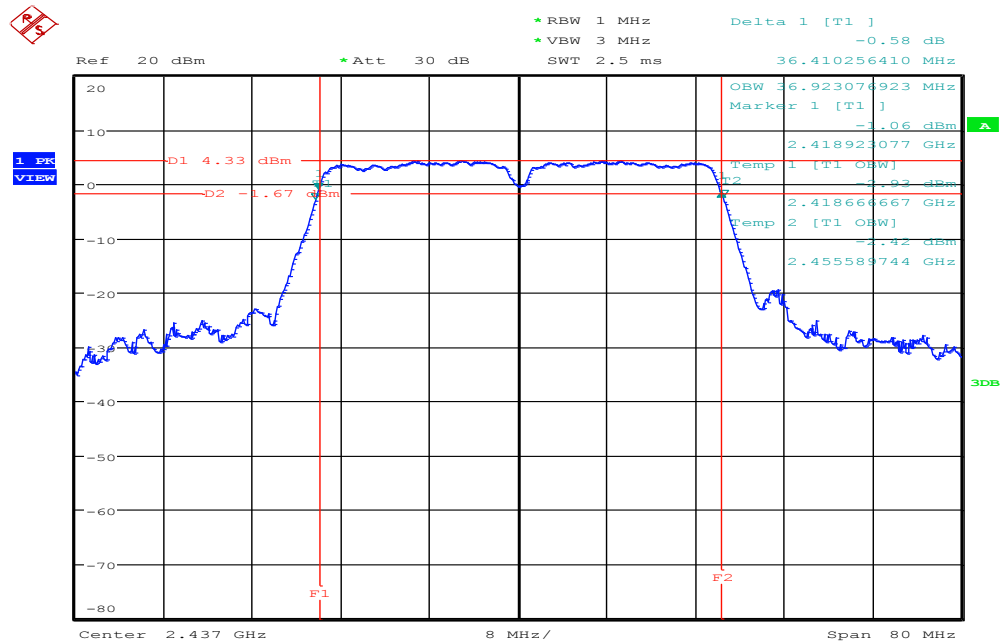

Date: 18.MAR.2016 17:25:39

### 99% Bandwidth (CH High)

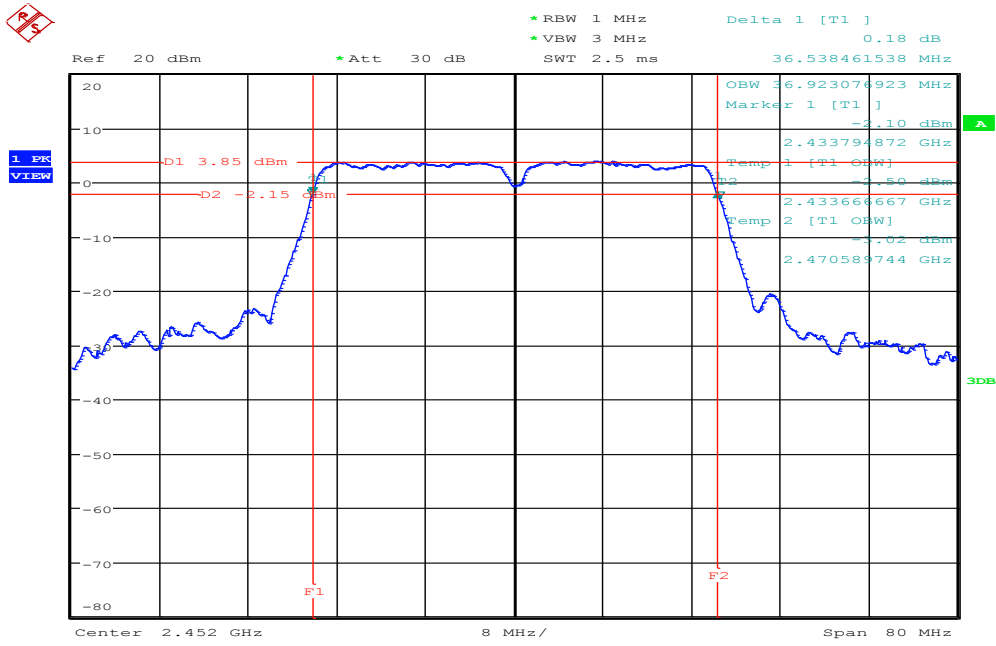

Date: 18.MAR.2016 17:23:52

## 7.2 6DB BANDWIDTH

### LIMIT

According to §15.247(a)(2) & RSS-247, systems using digital modulation techniques may operate in the 902 - 928 MHz, 2400 - 2483.5 MHz, and 5725 - 5850 MHz bands. The minimum 6dB bandwidth shall be at least 500 kHz.

### Test Configuration

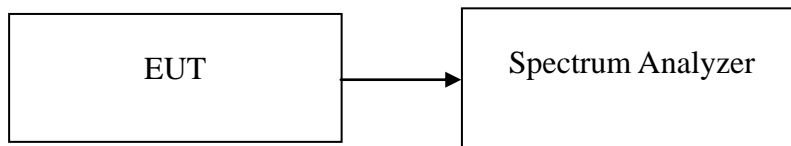

### TEST PROCEDURE

1. Place the EUT on the table and set it in the transmitting mode.
2. Remove the antenna from the EUT and then connect a low loss RF cable from the antenna port to the spectrum analyzer.
3. Set the spectrum analyzer as RBW = 100 kHz, VBW= 300kHz, Span = 50 MHz, Sweep = auto.
4. Mark the peak frequency and -6dB (upper and lower) frequency.
5. Repeat until all the rest channels are investigated.

### TEST RESULTS

*No non-compliance noted*

**Test Data**

**IEEE 802.11b mode**

Channel	Frequency (MHz)	6dB Bandwidth (MHz)	Limit (kHz)	Result
Low	2412	10.0961	>500	PASS
Mid	2437	10.0961		PASS
High	2462	10.0961		PASS

**IEEE 802.11g mode**

Channel	Frequency (MHz)	6dB Bandwidth (MHz)	Limit (kHz)	Result
Low	2412	16.6346	>500	PASS
Mid	2437	16.6346		PASS
High	2462	16.6346		PASS

**IEEE 802.11n HT 20 MHz mode / Chain 0**

Channel	Frequency (MHz)	6dB Bandwidth (MHz)	Limit (kHz)	Result
Low	2412	17.8365	>500	PASS
Mid	2437	17.8365		PASS
High	2462	17.7884		PASS

**IEEE 802.11n HT 20 MHz mode / Chain 1**

Channel	Frequency (MHz)	6dB Bandwidth (MHz)	Limit (kHz)	Result
Low	2412	17.7884	>500	PASS
Mid	2437	17.8365		PASS
High	2462	17.8365		PASS

**IEEE 802.11n HT 40 MHz mode / Chain 0**

Channel	Frequency (MHz)	6dB Bandwidth (MHz)	Limit (kHz)	Result
Low	2422	36.6666	>500	PASS
Mid	2437	36.6666		PASS
High	2452	36.6666		PASS

**IEEE 802.11n HT 40 MHz mode / Chain 1**

Channel	Frequency (MHz)	6dB Bandwidth (MHz)	Limit (kHz)	Result
Low	2422	36.6666	>500	PASS
Mid	2437	36.6666		PASS
High	2452	36.6666		PASS

**Test Plot**

**IEEE 802.11b mode**

**6dB Bandwidth (CH Low)**

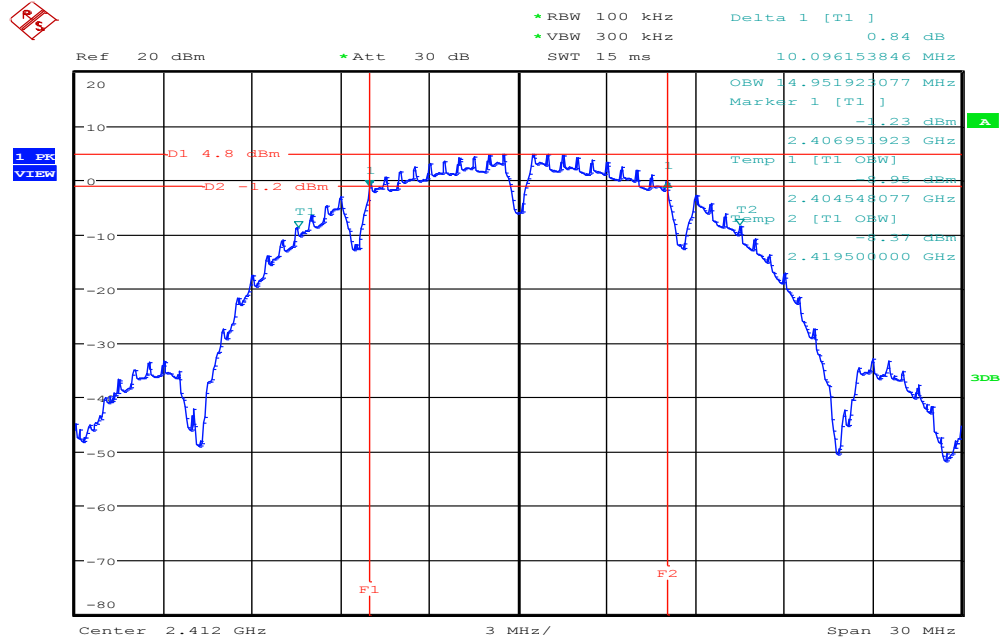

Date: 18.MAR.2016 14:07:23

**6dB Bandwidth (CH Mid)**

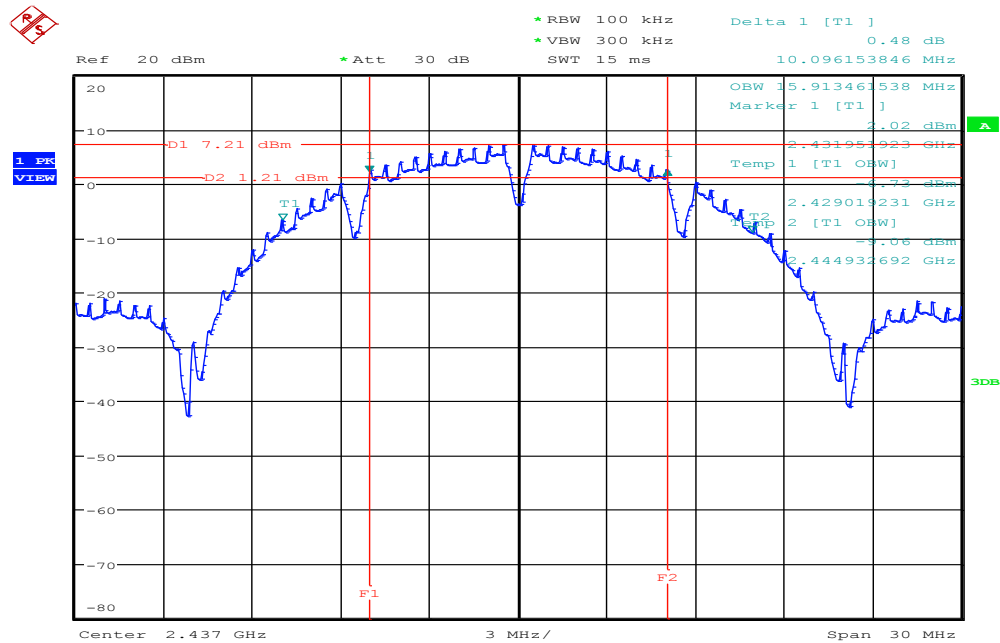

Date: 18.MAR.2016 14:09:57

### 6dB Bandwidth (CH High)

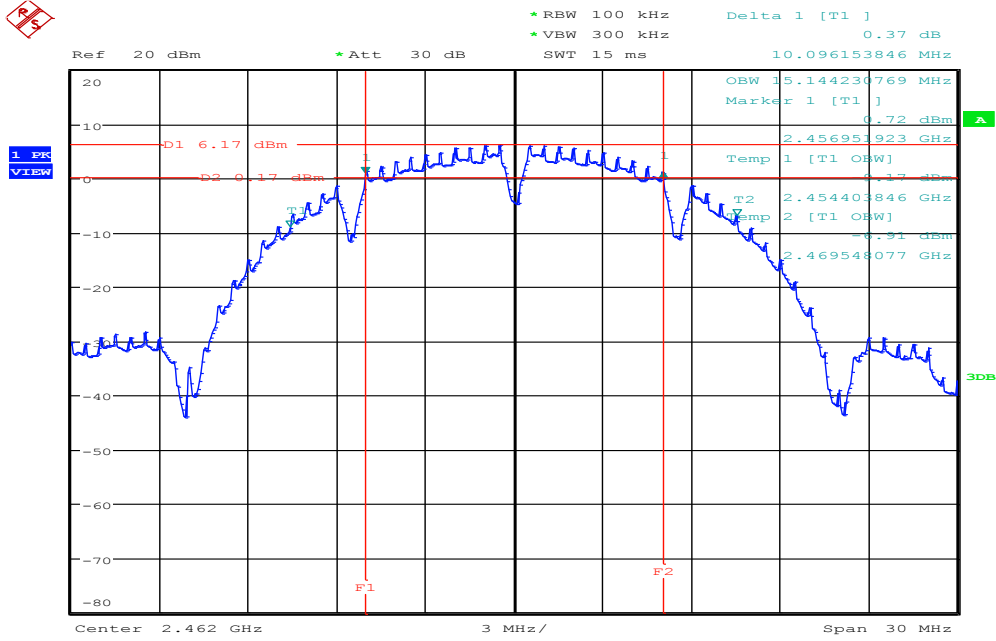

Date: 18.MAR.2016 14:14:45

IEEE 802.11g mode

6dB Bandwidth (CH Low)

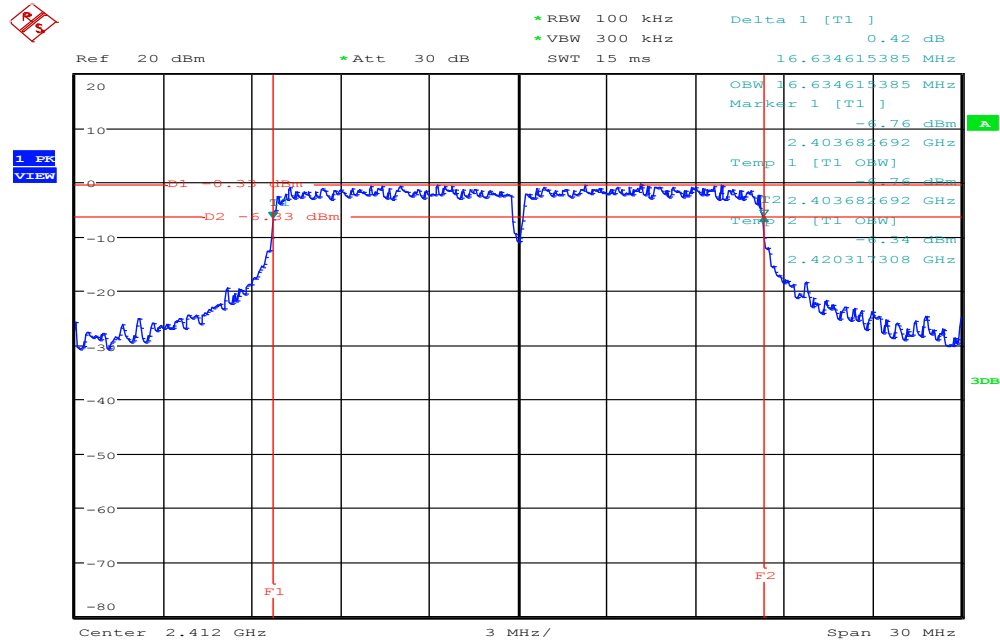

Date: 18.MAR.2016 14:24:35

6dB Bandwidth (CH Mid)

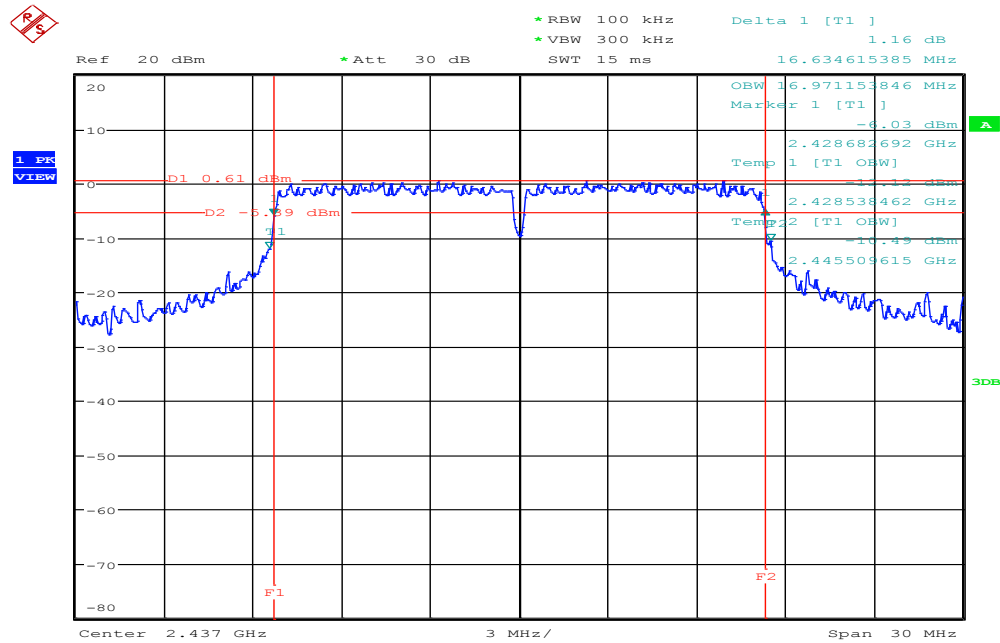

Date: 22.MAR.2016 14:21:41



### 6dB Bandwidth (CH High)

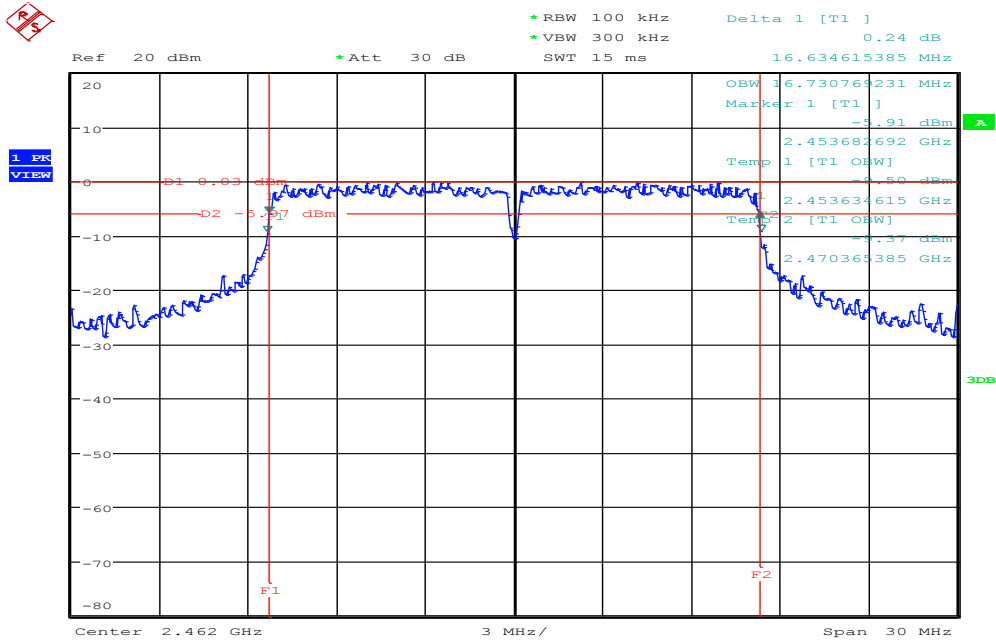

Date: 18.MAR.2016 14:27:56

**IEEE 802.11n HT 20 MHz mode / Chain 0**

**6dB Bandwidth (CH Low)**

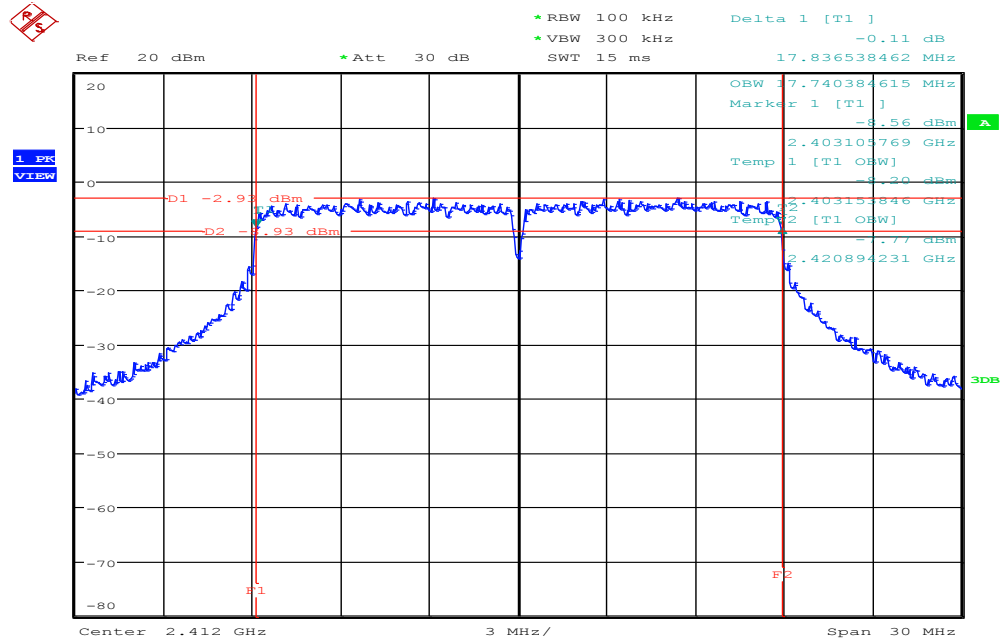

Date: 18.MAR.2016 14:40:31

**6dB Bandwidth (CH Mid)**

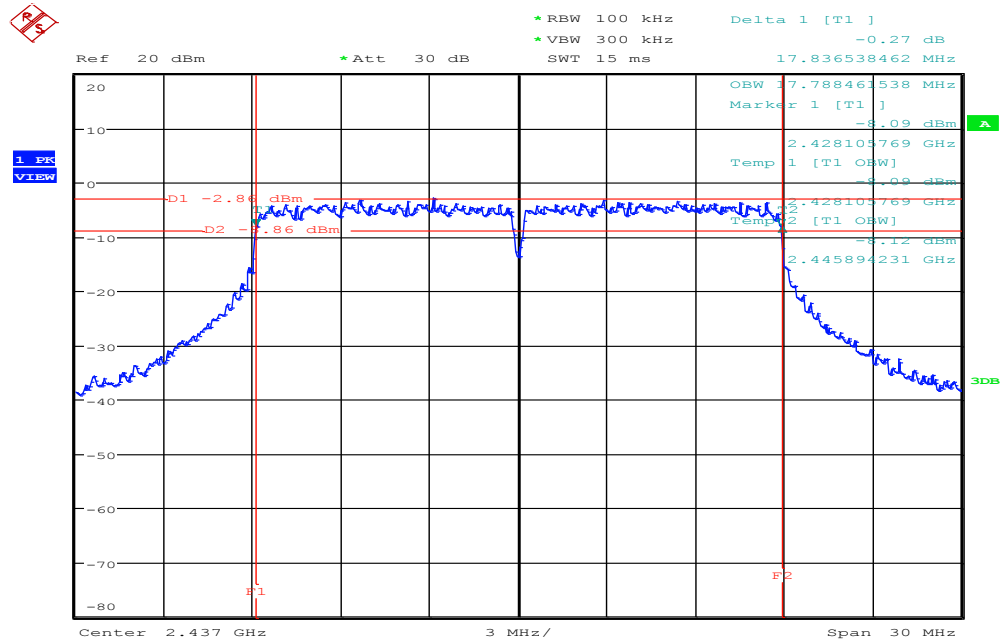

Date: 18.MAR.2016 14:42:09

### 6dB Bandwidth (CH High)

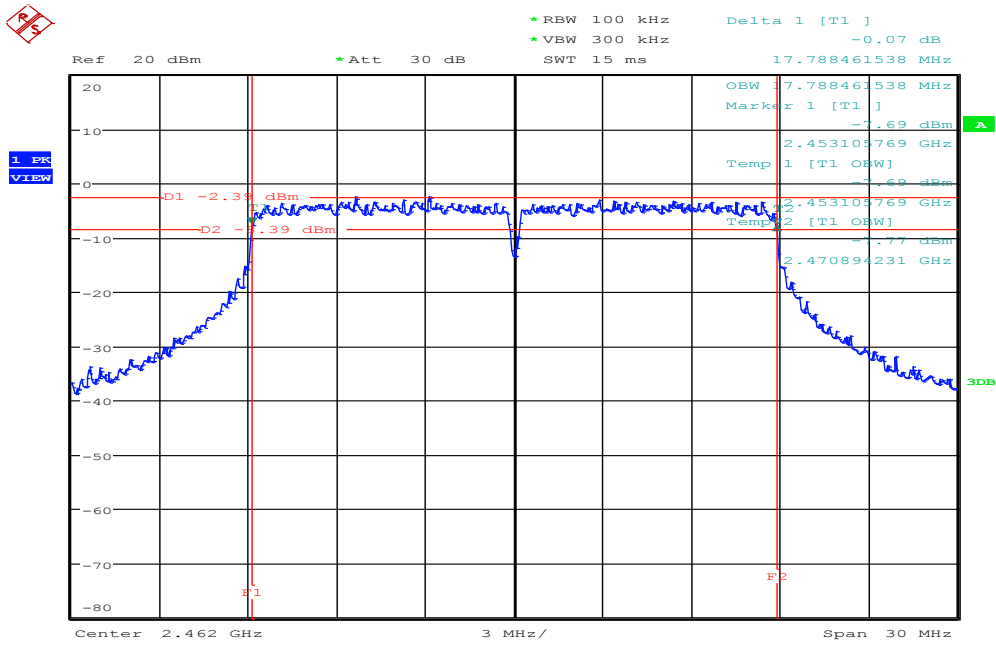

Date: 18.MAR.2016 14:45:35

**IEEE 802.11n HT 20 MHz mode / Chain 1**  
**6dB Bandwidth (CH Low)**

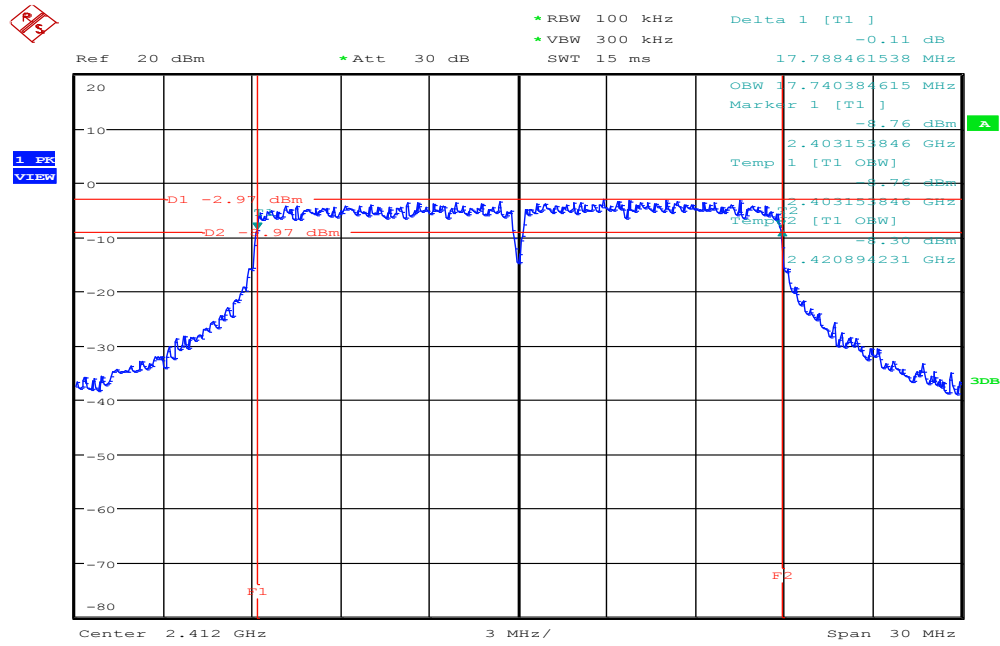

Date: 18.MAR.2016 16:05:06

**6dB Bandwidth (CH Mid)**

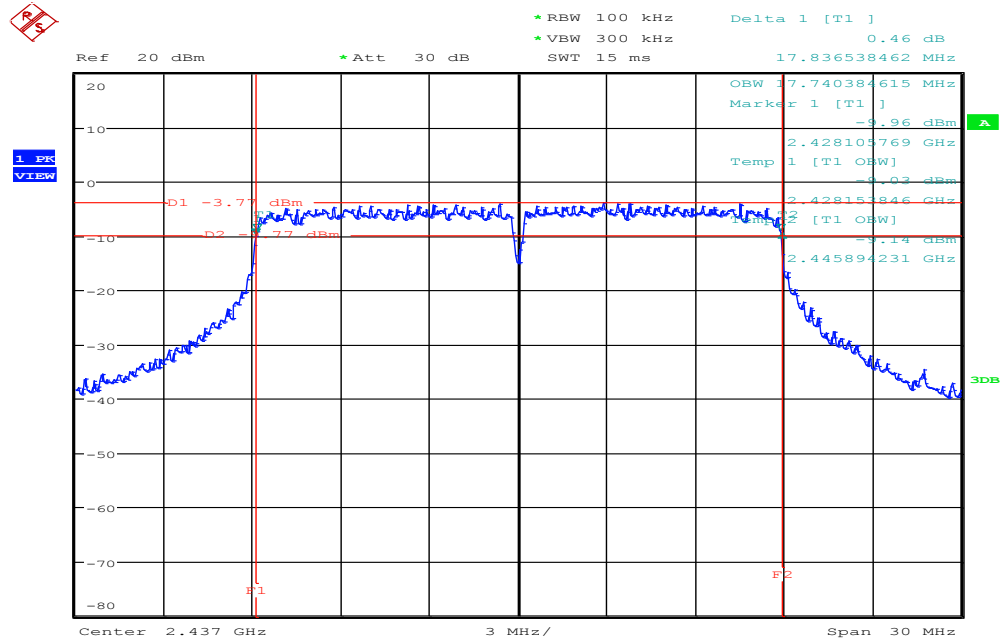

Date: 18.MAR.2016 16:06:52

### 6dB Bandwidth (CH High)

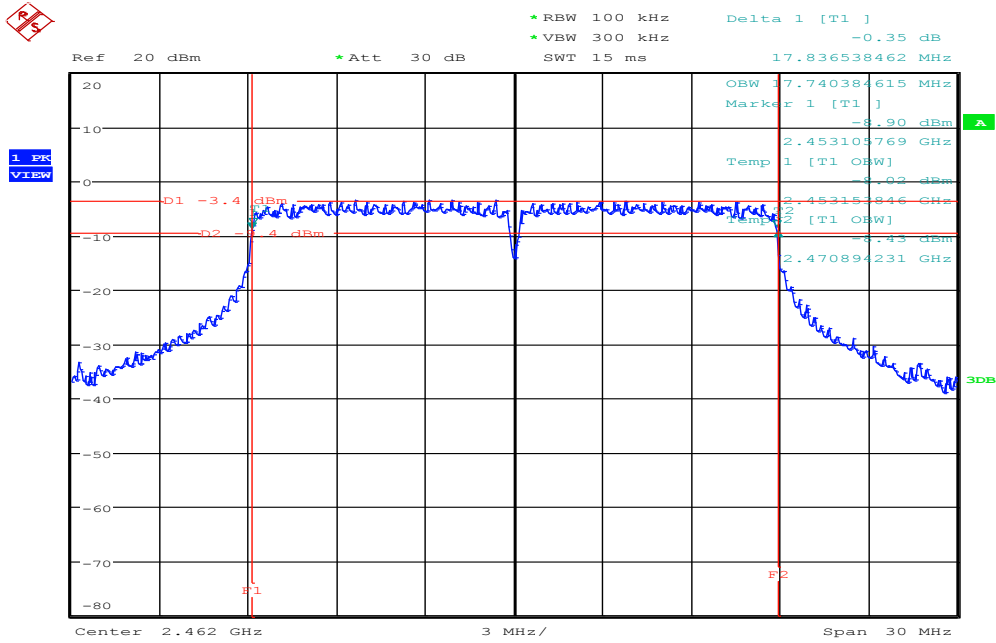

Date: 18.MAR.2016 16:08:12

**IEEE 802.11n HT 40 MHz mode / Chain 0**

**6dB Bandwidth (CH Low)**

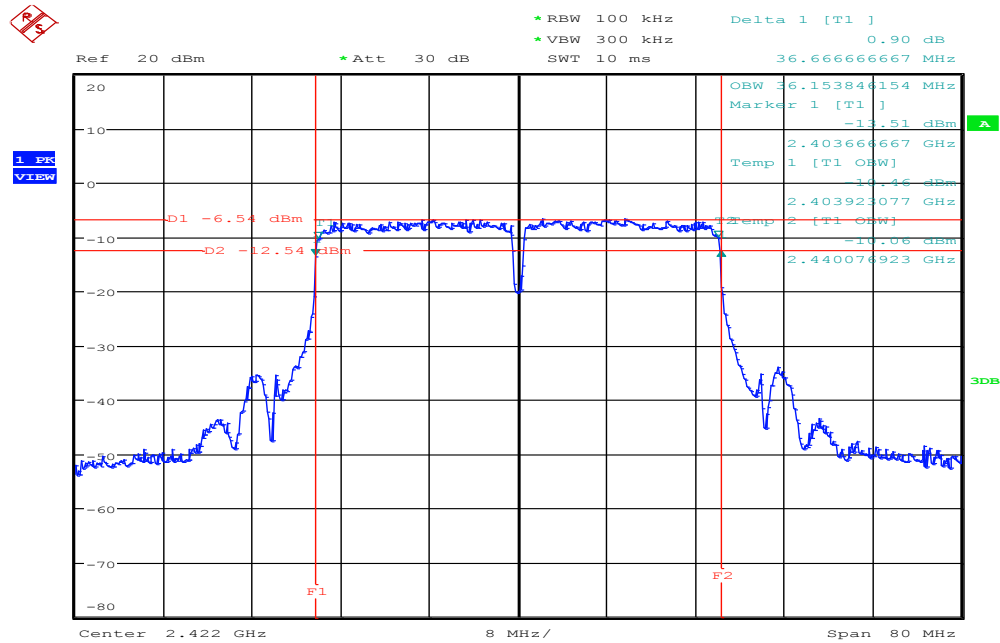

Date: 18.MAR.2016 16:41:30

**6dB Bandwidth (CH Mid)**

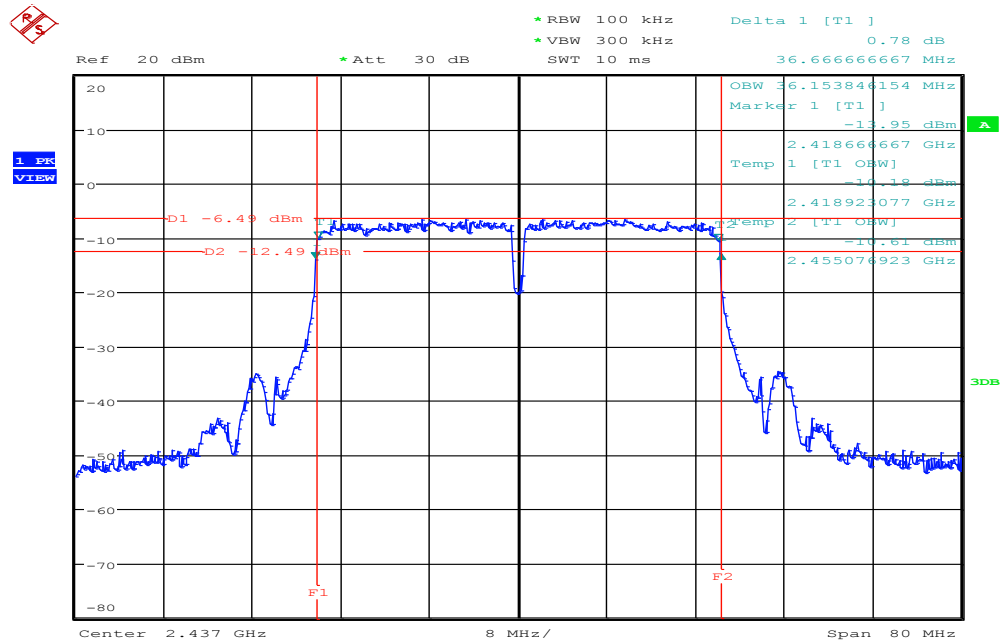

Date: 18.MAR.2016 16:42:56

### 6dB Bandwidth (CH High)

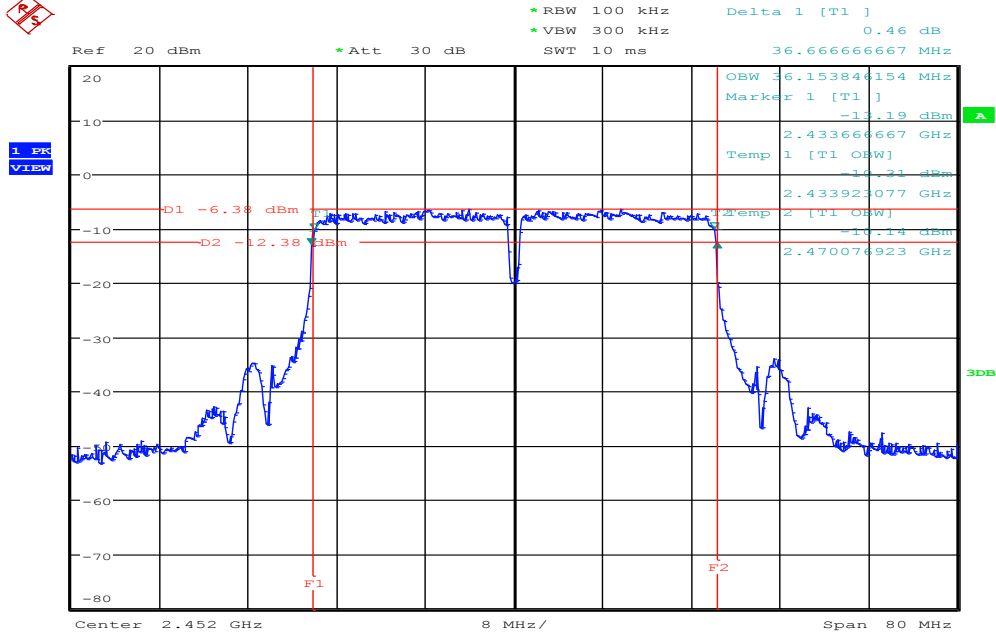

Date: 18.MAR.2016 16:43:59

### IEEE 802.11n HT 40 MHz mode / Chain 1

#### 6dB Bandwidth (CH Low)

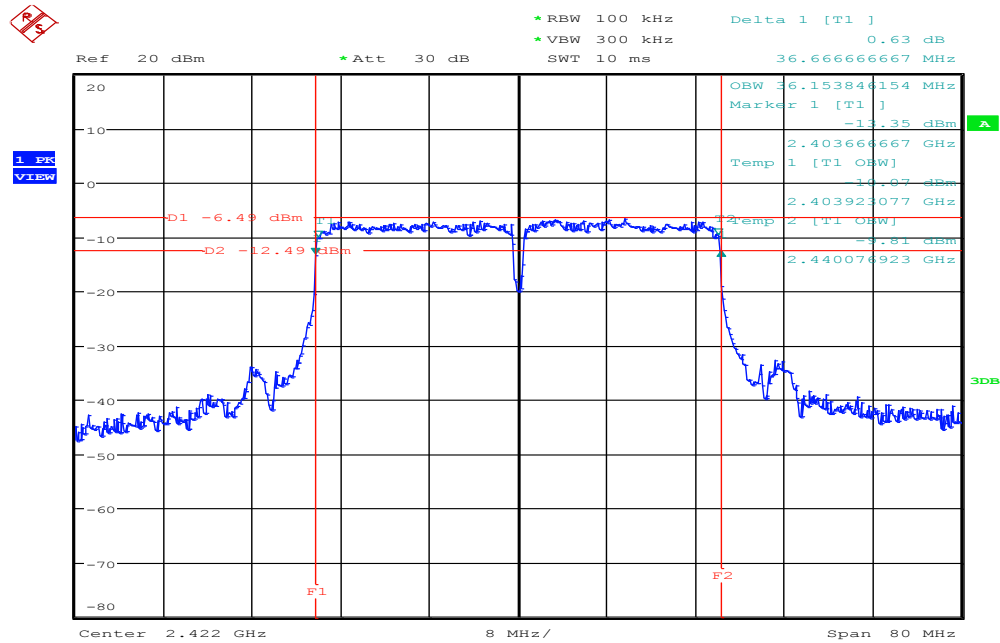

Date: 18.MAR.2016 16:29:30

#### 6dB Bandwidth (CH Mid)

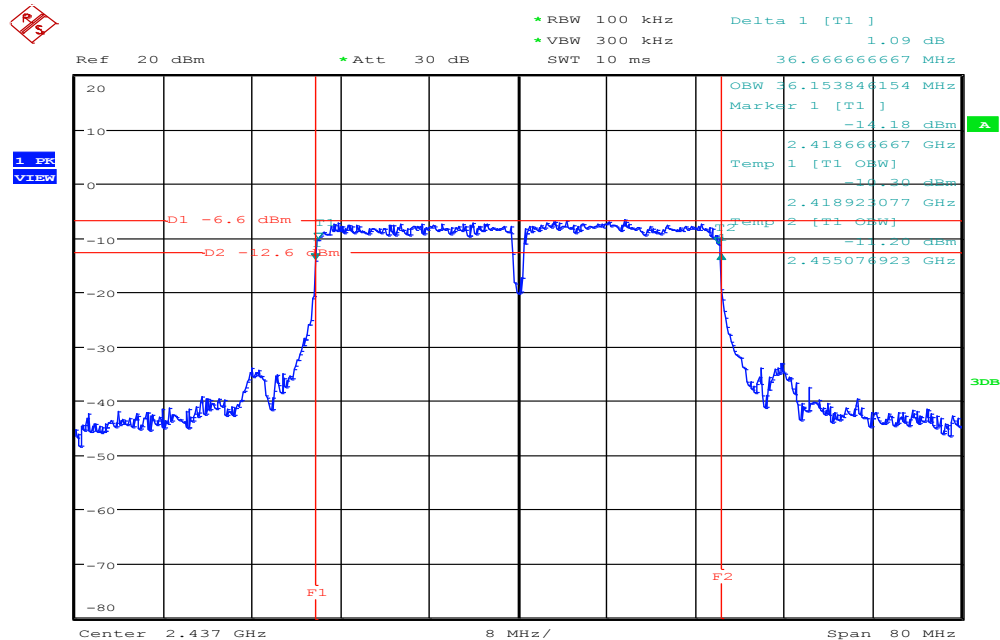

Date: 18.MAR.2016 16:30:42



### 6dB Bandwidth (CH High)

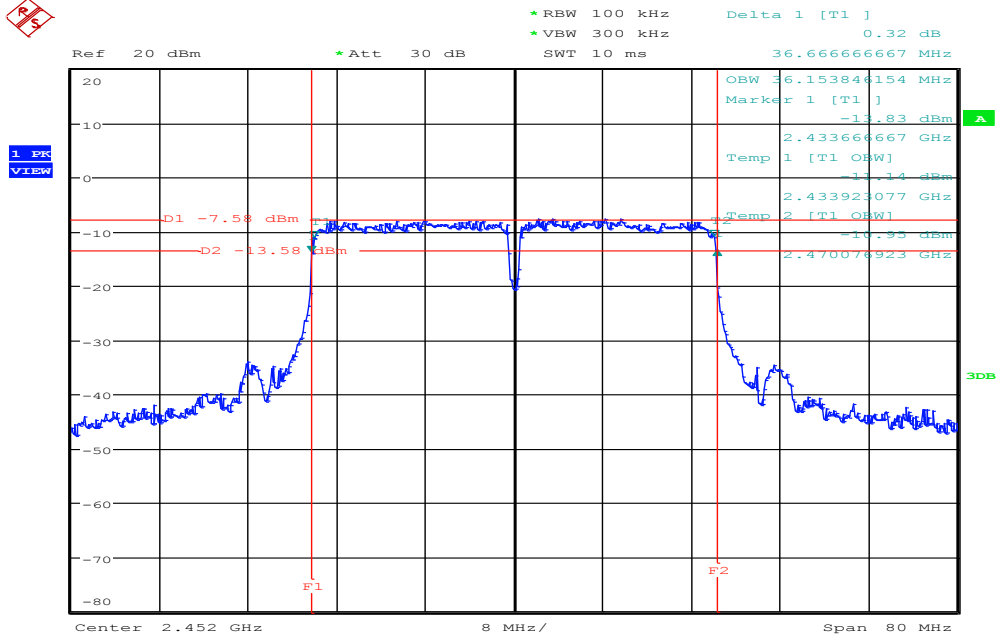

Date: 18.MAR.2016 16:32:45

## 7.3 PEAK POWER

### LIMIT

The maximum peak output power of the intentional radiator shall not exceed the following:

1. According to §15.247(b)(3), for systems using digital modulation in the bands of 902-928 MHz, 2400-2483.5 MHz, and 5725-5850 MHz: 1 Watt.
2. According to §15.247(b)(4), the conducted output power limit specified in paragraph (b) of this section is based on the use of antennas with directional gains that do not exceed 6 dBi. Except as shown in paragraph (c) of this section, if transmitting antennas of directional gain greater than 6 dBi are used, the conducted output power from the intentional radiator shall be reduced below the stated values in paragraphs (b)(1), (b)(2), and (b)(3) of this section, as appropriate, by the amount in dB that the directional gain of the antenna exceeds 6 dBi.
3. According to RSS-247, for systems employing digital modulation techniques operating in the bands 902-928 MHz, 2400-2483.5 MHz and 5725-5850 MHz, the maximum peak conducted output power shall not exceed 1 W.

### Test Configuration

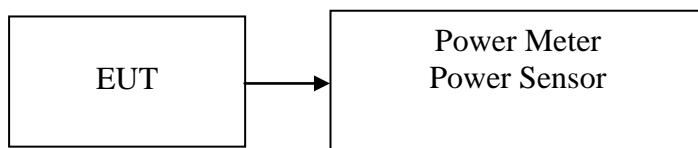

### TEST PROCEDURE

The transmitter output is connected to the Power Meter. The Power Meter is set to the peak power detection.

### TEST RESULTS

*No non-compliance noted*

**Test Data**

**IEEE 802.11b mode**

Channel	Frequency (MHz)	Output Power (dBm)	Output Power (W)	Limit (dBm)	Result
Low	2412	17.82	0.0605	30	PASS
Mid	2437	<b>*19.97</b>	0.0993		PASS
High	2462	19.35	0.0861		PASS

**IEEE 802.11g mode**

Channel	Frequency (MHz)	Output Power (dBm)	Output Power (W)	Limit (dBm)	Result
Low	2412	<b>*21.14</b>	0.1300	30	PASS
Mid	2437	21.01	0.1262		PASS
High	2462	20.94	0.1242		PASS

**IEEE 802.11n HT 20 MHz mode**

Channel	Frequency (MHz)	Chain 0 Output Power (dBm)	Chain 1 Output Power (dBm)	Total Output Power (dBm)	Output Power (W)	Limit (dBm)	Result
Low	2412	22.68	19.43	<b>*24.36</b>	0.2731	30	PASS
Mid	2437	22.55	19.07	24.16	0.2606		PASS
High	2462	22.33	19.17	24.04	0.2536		PASS

**IEEE 802.11n HT 40 MHz mode**

Channel	Frequency (MHz)	Chain 0 Output Power (dBm)	Chain 1 Output Power (dBm)	Total Output Power (dBm)	Output Power (W)	Limit (dBm)	Result
Low	2422	22.85	19.45	<b>*24.48</b>	0.2809	30	PASS
Mid	2437	22.53	19.37	24.24	0.2656		PASS
High	2452	22.71	19.14	24.29	0.2687		PASS

**Remark:**

1. Total Output Power (w) = Chain 0 (10^(Output Power /10)/1000)+ Chain 1 (10^(Output Power /10)/1000)

## 7.4 AVERAGE POWER

### LIMIT

None; for reporting purposes only.

### Test Configuration

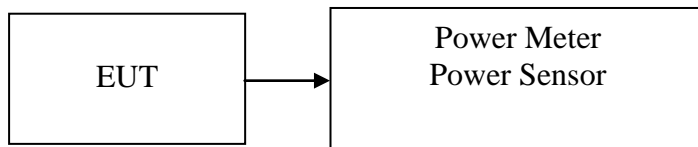

### TEST PROCEDURE

The transmitter output is connected to the Power Meter. The Power Meter is set to the peak power detection.

### TEST RESULTS

*No non-compliance noted*

**Test Data**

**Test mode: IEEE 802.11b mode**

Channel	Frequency (MHz)	Output Power (dBm)	Output Power (W)
Low	2412	15.59	0.0362
Mid	2437	18.41	0.0693
High	2462	17.45	0.0556

**Test mode: IEEE 802.11g mode**

Channel	Frequency (MHz)	Output Power (dBm)	Output Power (W)
Low	2412	15.23	0.0333
Mid	2437	15.56	0.0360
High	2462	15.51	0.0356

**Test mode: IEEE 802.11n HT 20 MHz mode**

Channel	Frequency (MHz)	Chain 0 Output Power (dBm)	Chain 1 Output Power (dBm)	Total Output Power (dBm)	Output Power (W)
Low	2412	12.65	10.79	14.83	0.0304
Mid	2437	12.13	10.53	14.41	0.0276
High	2462	12.40	10.84	14.70	0.0295

**Test mode: IEEE 802.11n HT 40 MHz mode**

Channel	Frequency (MHz)	Chain 0 Output Power (dBm)	Chain 1 Output Power (dBm)	Total Output Power (dBm)	Output Power (W)
Low	2422	12.45	10.58	14.63	0.0290
Mid	2437	12.08	10.52	14.38	0.0274
High	2452	12.14	10.23	14.30	0.0269

**Remark:** Total Output Power (w) = Chain 0 (10^(Output Power /10)/1000) + Chain 1 (10^(Output Power /10)/1000)

## 7.5 BAND EDGES MEASUREMENT

### LIMIT

According to §15.247(d) & RSS-247, in any 100 kHz bandwidth outside the frequency bands in which the spread spectrum intentional radiator is operating, the radio frequency power that is produced by the intentional radiator shall be at least 20 dB below that in the 100 kHz bandwidth within the band that contains the highest level of the desired power, based on either an RF conducted or a radiated measurement, provided the transmitter demonstrates compliance with the peak conducted power limits. In addition, radiated emissions which fall in the restricted bands, as defined in §15.205(a), must also comply with the radiated emission limits specified in 15.209(a) (see Section 15.205(c)).

### Test Configuration

#### For Radiated

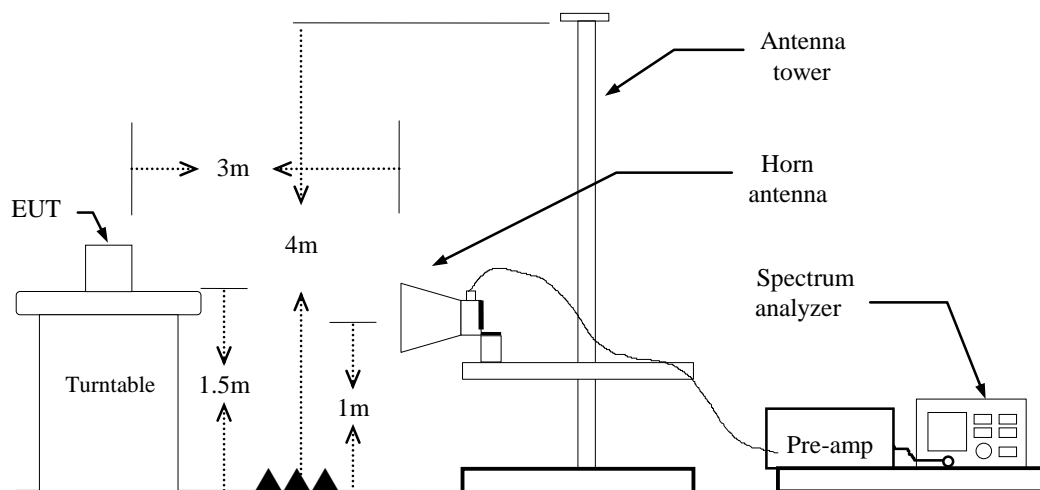

## **TEST PROCEDURE**

### **For Radiated**

1. The EUT is placed on a turntable, which is 1.5m above the ground plane.
2. The turntable shall be rotated for 360 degrees to determine the position of maximum emission level.
3. EUT is set 3m away from the receiving antenna, which is varied from 1m to 4m to find out the highest emission.
4. Set the spectrum analyzer in the following setting in order to capture the lower and upper band-edges of the emission:
  - (a) PEAK: RBW=1MHz / VBW=3MHz / Sweep=AUTO
  - (b) AVERAGE: RBW=1MHz,  
if duty cycle  $\geq 98\%$ , VBW=10Hz.  
if duty cycle  $< 98\%$  VBW=1/T.  
**IEEE 802.11b mode:**  $\geq 98\%$ , VBW=10Hz  
**IEEE 802.11g mode:**  $\geq 98\%$ , VBW=10Hz  
**IEEE 802.11n HT 20 MHz mode:**  $\geq 98\%$ , VBW=10Hz  
**IEEE 802.11n HT 40 MHz mode:**  $\geq 98\%$ , VBW=10Hz
5. Repeat the procedures until all the PEAK and AVERAGE versus POLARIZATION are measured.
6. Result = Spectrum Reading + cable loss(spectrum to Amp) - Amp Gain + Cable loss(Amp to receive Ant)+ Receive Ant

### **For Un-restricted Band Emissions**

The peak output power procedure is used to measure the fundamental emission power to demonstrate compliance to requirements, then the peak conducted output power measured within any 100 kHz outside the authorized frequency band shall be attenuated by at least 20 dB relative to the maximum measured in-band peak PSD level.

## **TEST RESULTS**

Refer to attach spectrum analyzer data chart.

**Band Edges (IEEE 802.11b mode / CH Low)**

**Detector mode: Peak**



No.	Frequency (MHz)	Reading (dBuV)	Correct Factor(dB)	Result (dBuV)	Limit (dBuV)	Margin (dB)	Remark
1	2386.384	51.44	-2.52	48.92	74.00	-25.08	peak
2	2412.032	100.45	-2.42	98.03	-	-	peak



**Detector mode: Average**

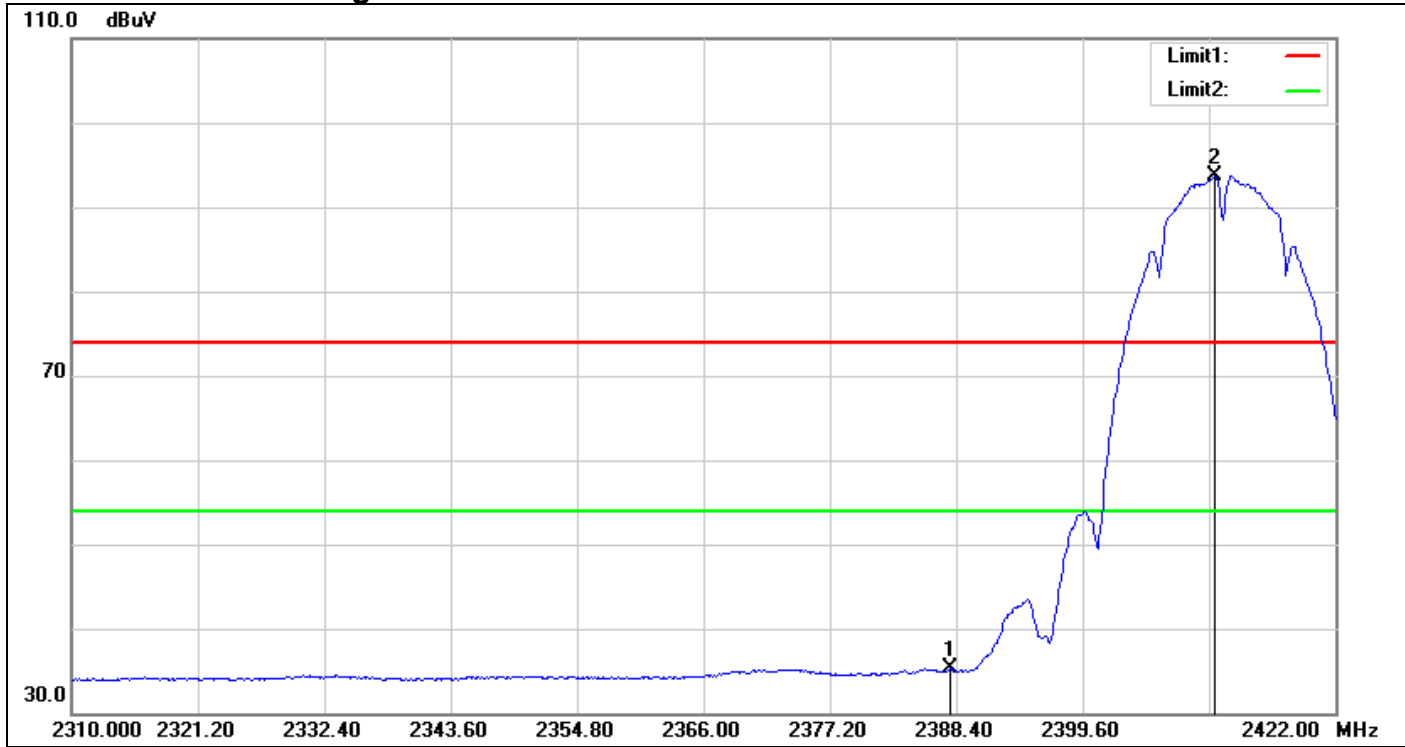

No.	Frequency (MHz)	Reading (dBuV)	Correct Factor(dB)	Result (dBuV)	Limit (dBuV)	Margin (dB)	Remark
1	2387.840	37.78	-2.51	35.27	54.00	-18.73	AVG
2	2411.248	96.08	-2.42	93.66	-	-	AVG

**Band Edges (IEEE 802.11b mode / CH Mid)**

**Detector mode: Peak**

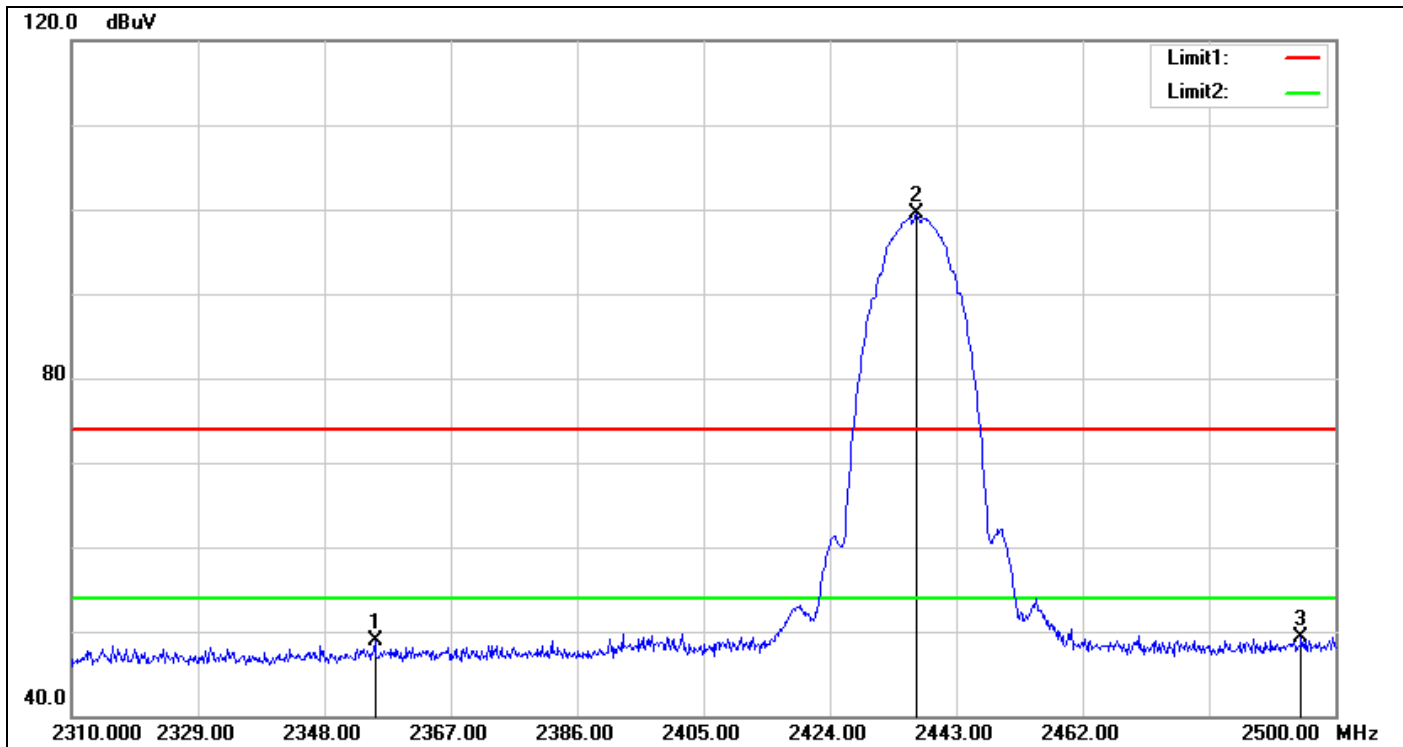

No.	Frequency (MHz)	Reading (dBuV)	Correct Factor(dB)	Result (dBuV)	Limit (dBuV)	Margin (dB)	Remark
1	2355.600	51.69	-2.81	48.88	74.00	-25.12	peak
2	2437.110	101.66	-2.23	99.43	-	-	peak
3	2494.870	51.13	-1.90	49.23	74.00	-24.77	peak

**Detector mode: Average**

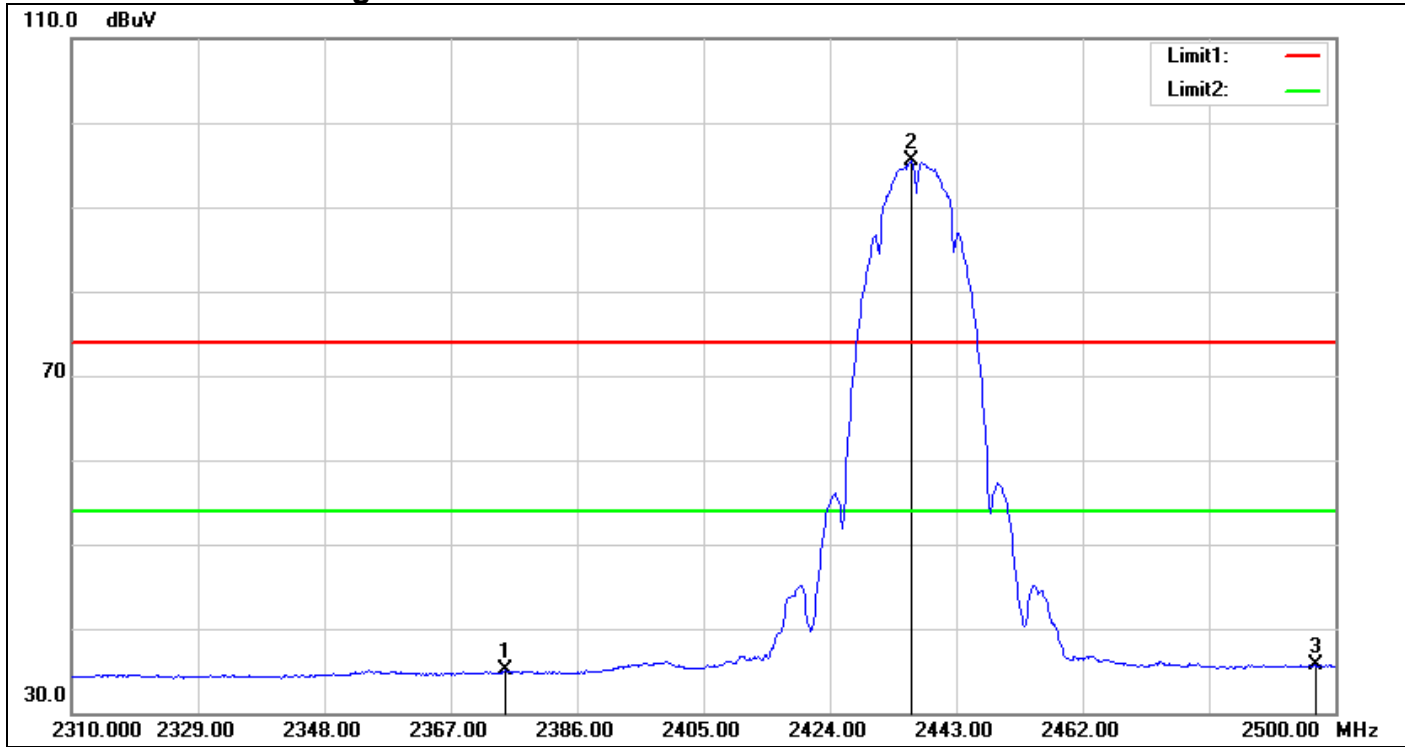

No.	Frequency (MHz)	Reading (dBuV)	Correct Factor(dB)	Result (dBuV)	Limit (dBuV)	Margin (dB)	Remark
1	2375.170	37.63	-2.61	35.02	54.00	-18.98	AVG
2	2436.350	97.73	-2.24	95.49	-	-	AVG
3	2496.960	37.59	-1.88	35.71	54.00	-18.29	AVG

**Band Edges (IEEE 802.11b mode / CH High)**

**Detector mode: Peak**

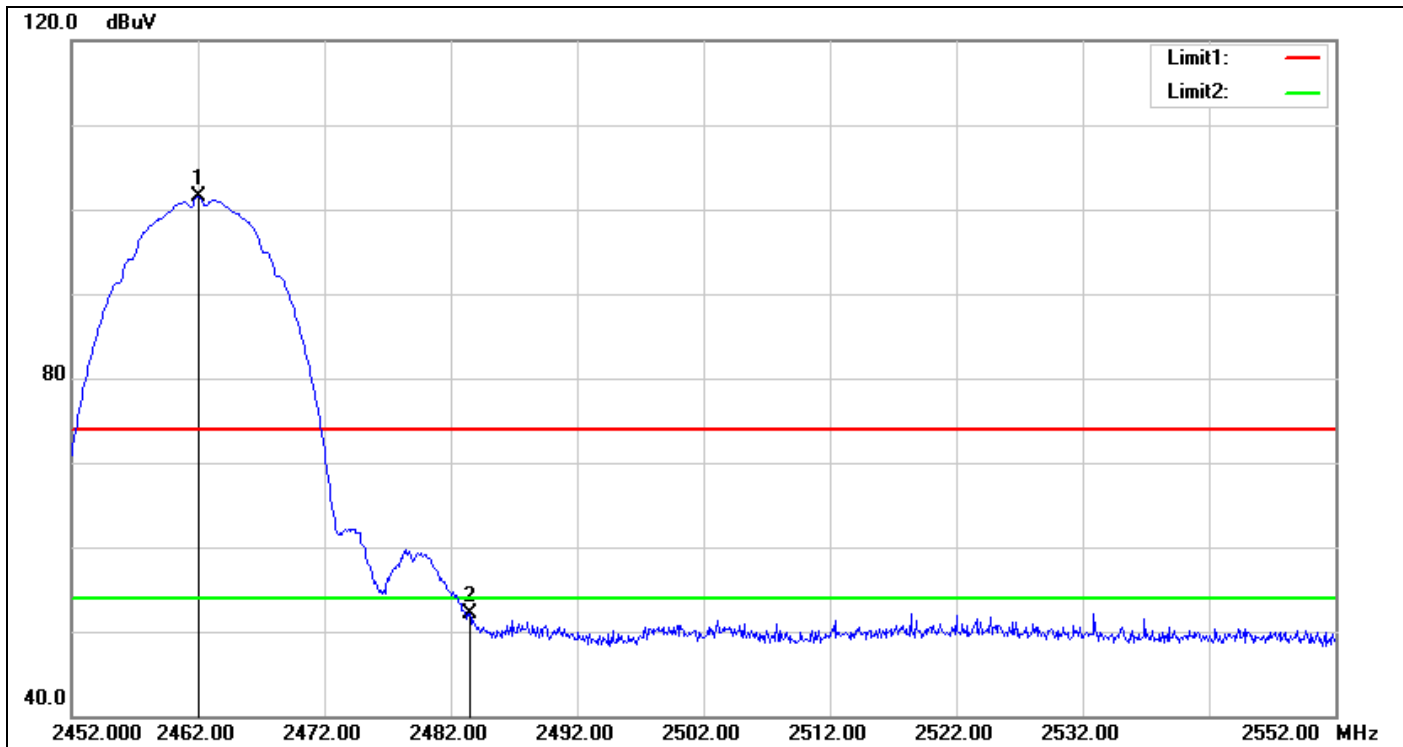

No.	Frequency (MHz)	Reading (dBuV)	Correct Factor(dB)	Result (dBuV)	Limit (dBuV)	Margin (dB)	Remark
1	2462.000	103.59	-2.10	101.49	-	-	peak
2	2483.500	54.10	-1.99	52.11	74.00	-21.89	peak

**Detector mode: Average**



No.	Frequency (MHz)	Reading (dBuV)	Correct Factor(dB)	Result (dBuV)	Limit (dBuV)	Margin (dB)	Remark
1	2462.800	99.64	-2.09	97.55	-	-	AVG
2	2483.500	44.43	-1.99	42.44	54.00	-11.56	AVG

**Band Edges (IEEE 802.11g mode / CH Low)**

**Detector mode: Peak**

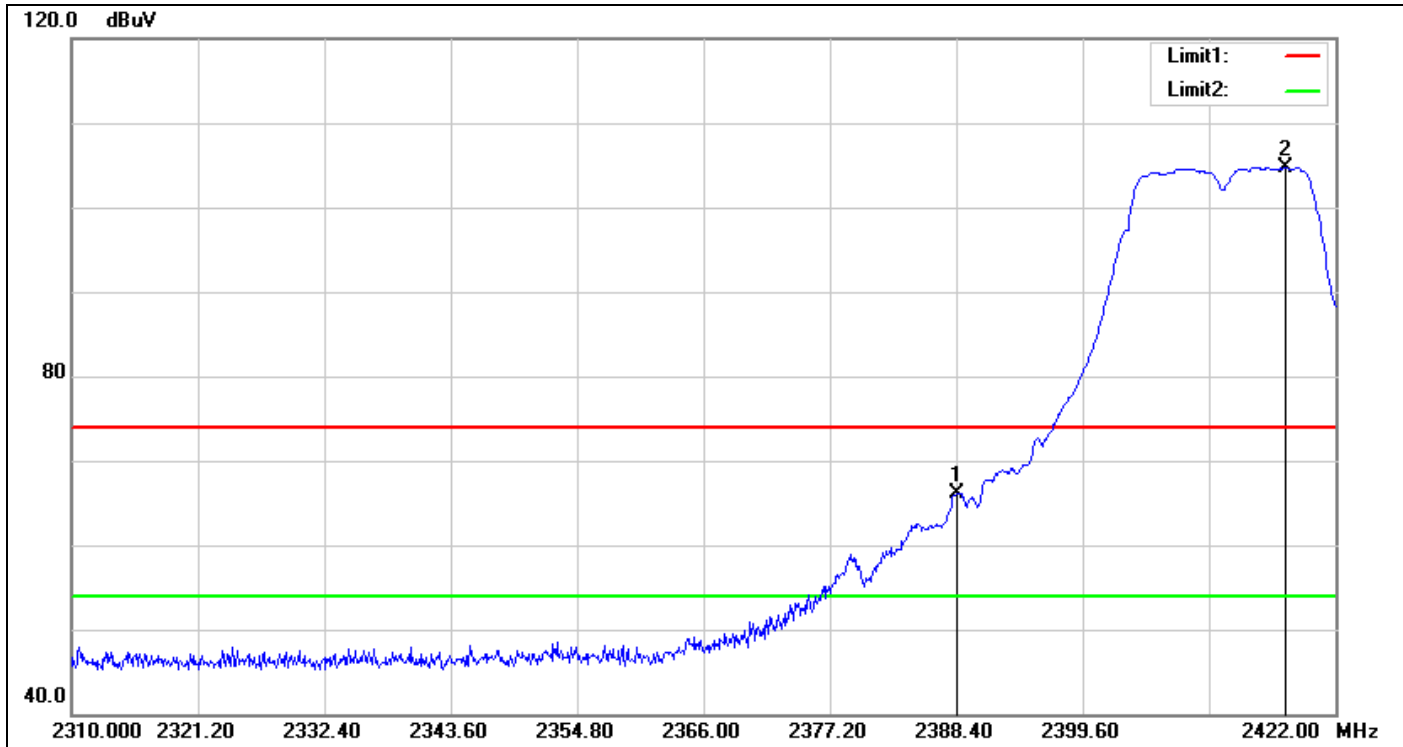

No.	Frequency (MHz)	Reading (dBuV)	Correct Factor(dB)	Result (dBuV)	Limit (dBuV)	Margin (dB)	Remark
1	2388.400	68.69	-2.50	66.19	74.00	-7.81	peak
2	2417.632	107.07	-2.37	104.70	-	-	peak

**Detector mode: Average**

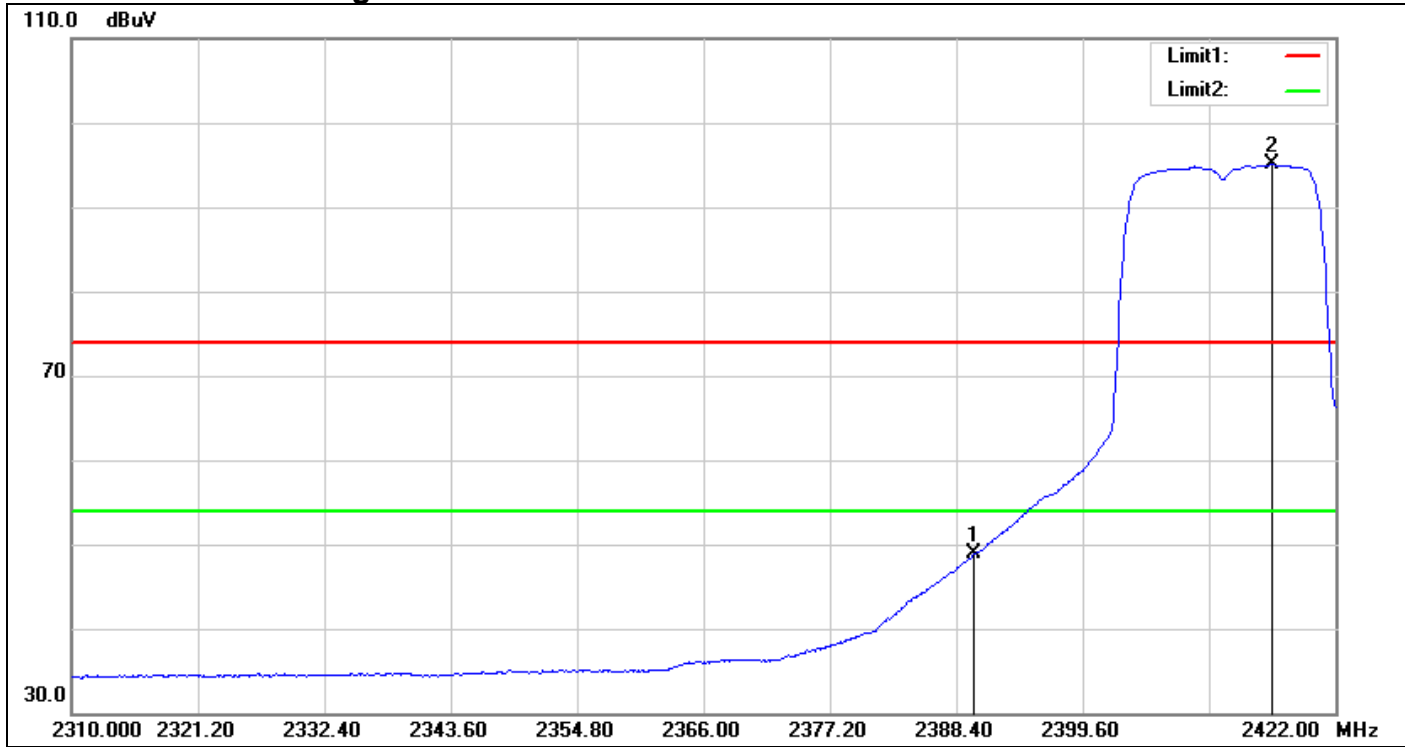

No.	Frequency (MHz)	Reading (dBuV)	Correct Factor(dB)	Result (dBuV)	Limit (dBuV)	Margin (dB)	Remark
1	2390.000	51.42	-2.49	48.93	54.00	-5.07	AVG
2	2416.400	97.41	-2.38	95.03	-	-	AVG

**Band Edges (IEEE 802.11g mode / CH Mid)**

**Detector mode: Peak**

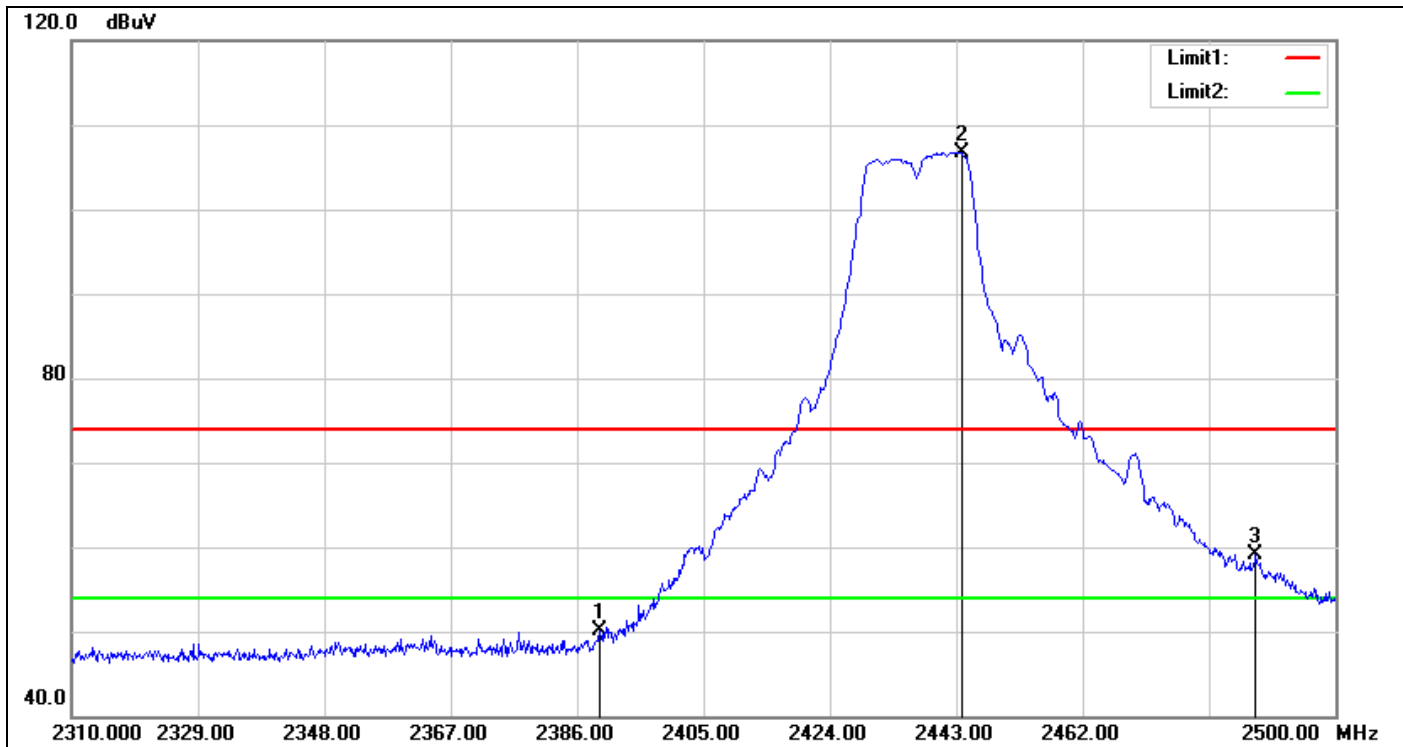

No.	Frequency (MHz)	Reading (dBuV)	Correct Factor(dB)	Result (dBuV)	Limit (dBuV)	Margin (dB)	Remark
1	2389.420	52.69	-2.50	50.19	74.00	-23.81	peak
2	2443.760	108.91	-2.19	106.72	-	-	peak
3	2488.030	61.14	-1.95	59.19	74.00	-14.81	peak



**Detector mode: Average**

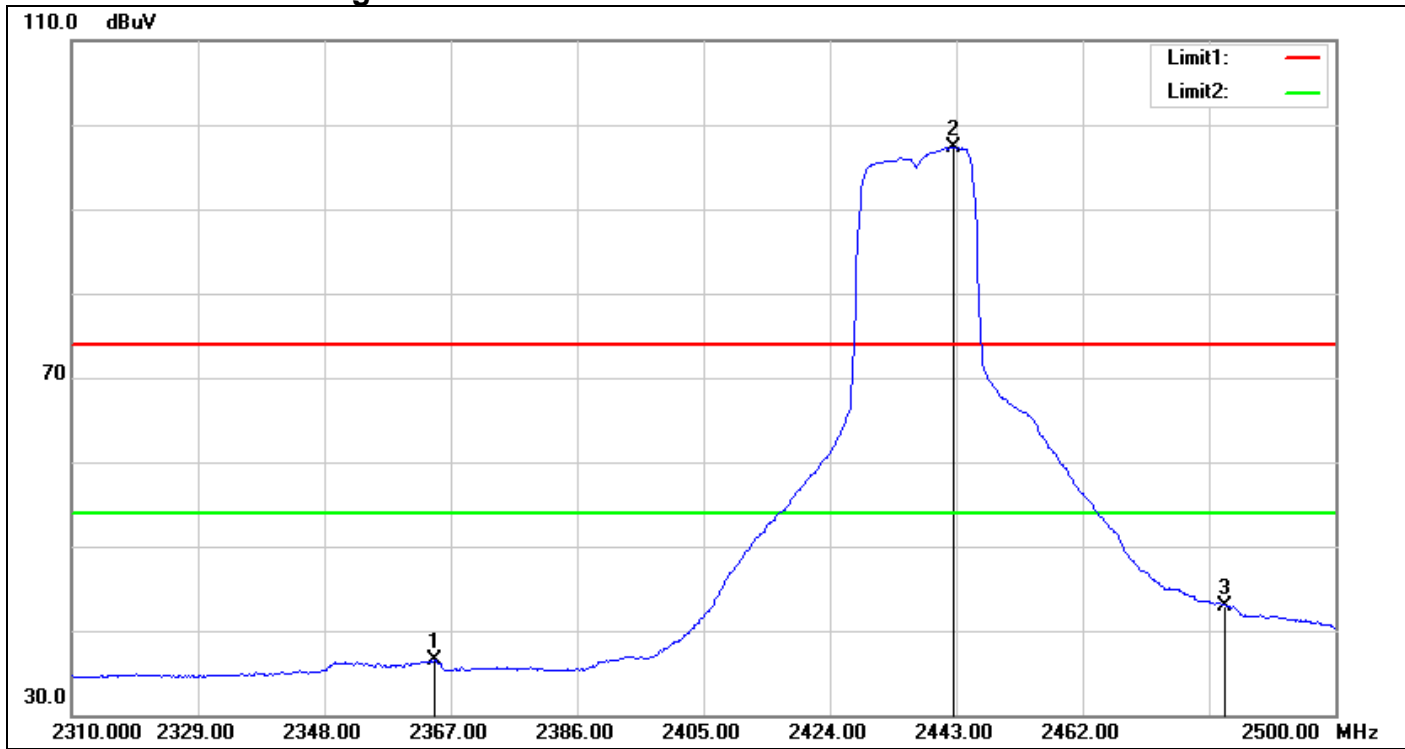

No.	Frequency (MHz)	Reading (dBuV)	Correct Factor(dB)	Result (dBuV)	Limit (dBuV)	Margin (dB)	Remark
1	2364.530	39.21	-2.74	36.47	54.00	-17.53	AVG
2	2442.620	99.44	-2.19	97.25	-	-	AVG
3	2483.500	44.96	-1.99	42.97	54.00	-11.03	AVG

**Band Edges (IEEE 802.11g mode / CH High)**

**Detector mode: Peak**

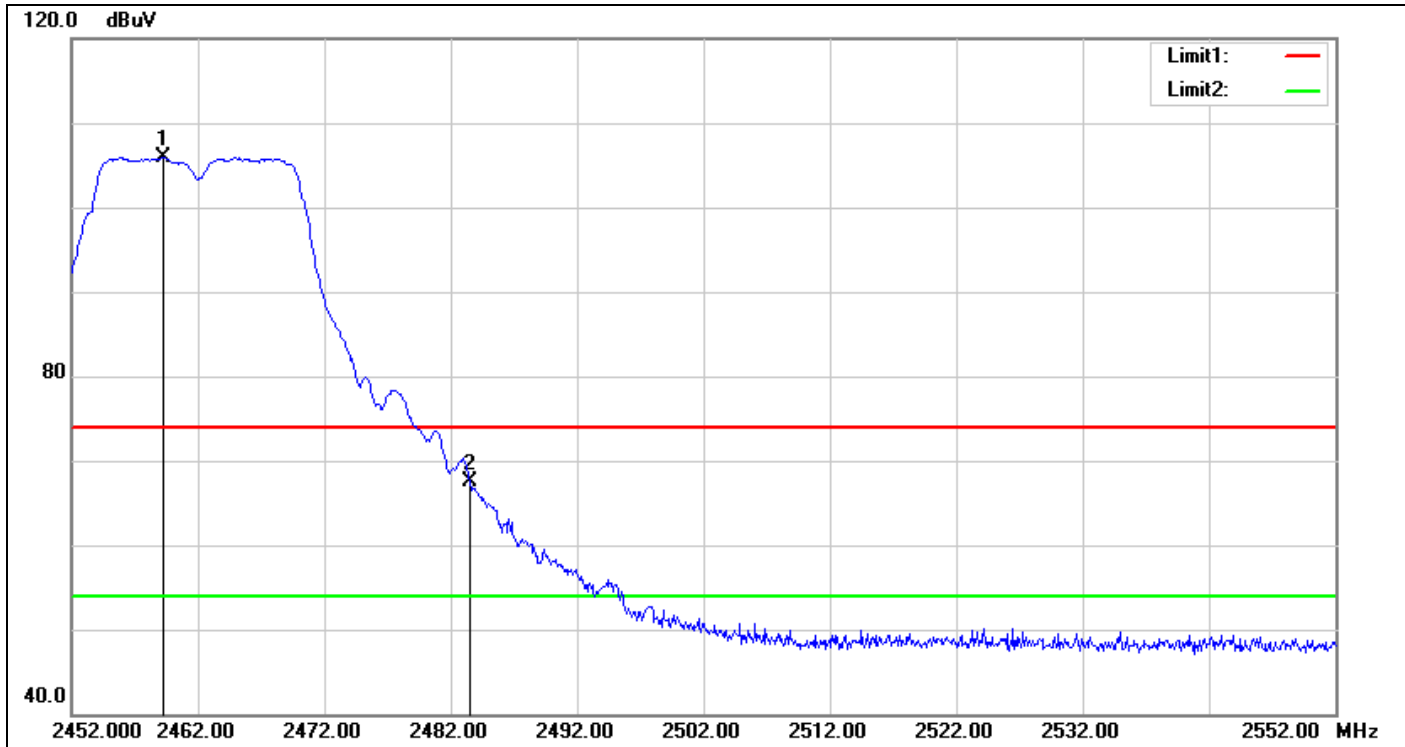

No.	Frequency (MHz)	Reading (dBuV)	Correct Factor(dB)	Result (dBuV)	Limit (dBuV)	Margin (dB)	Remark
1	2459.300	107.96	-2.11	105.85	-	-	peak
2	2483.500	69.47	-1.99	67.48	74.00	-6.52	peak

**Detector mode: Average**

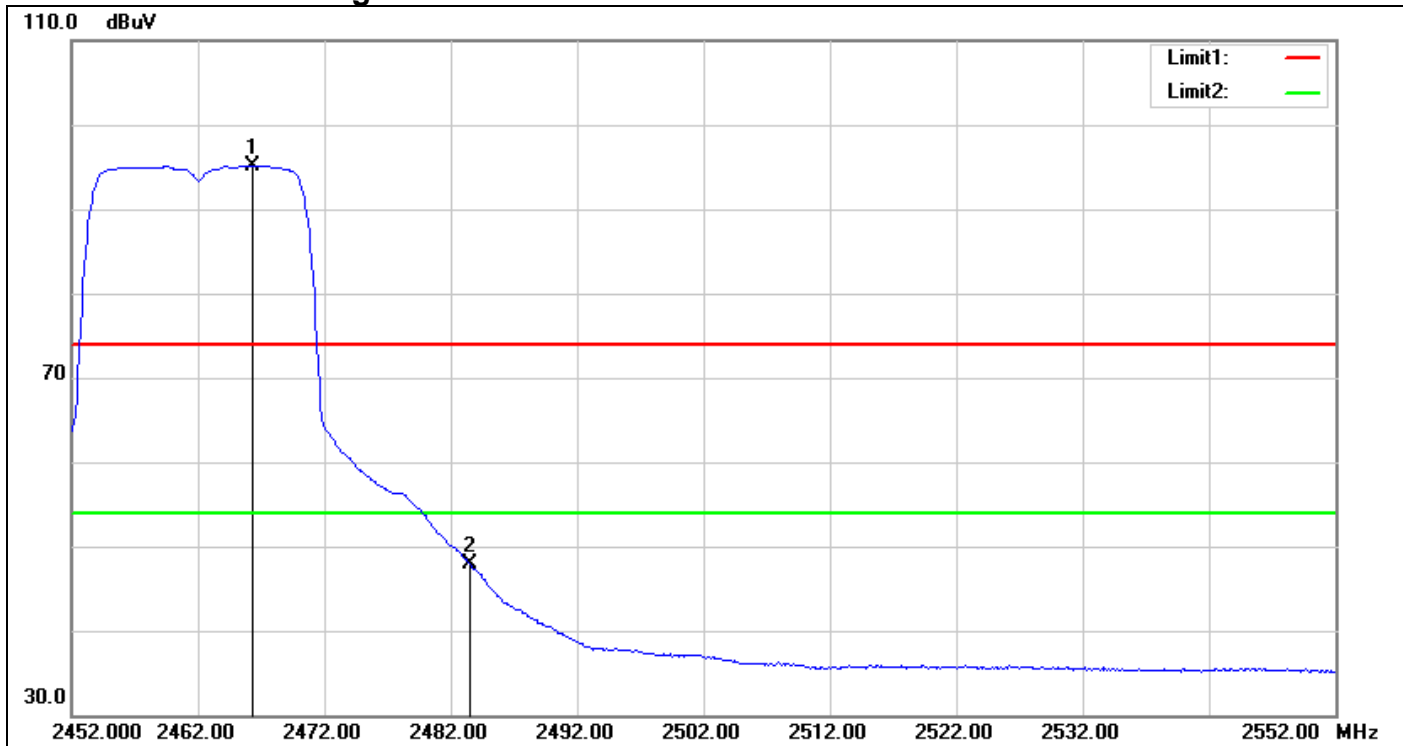

No.	Frequency (MHz)	Reading (dBuV)	Correct Factor(dB)	Result (dBuV)	Limit (dBuV)	Margin (dB)	Remark
1	2466.300	97.26	-2.08	95.18	-	-	AVG
2	2483.500	49.88	-1.99	47.89	54.00	-6.11	AVG

**Band Edges (IEEE 802.11n HT 20 MHz mode / CH Low)**

**Detector mode: Peak**

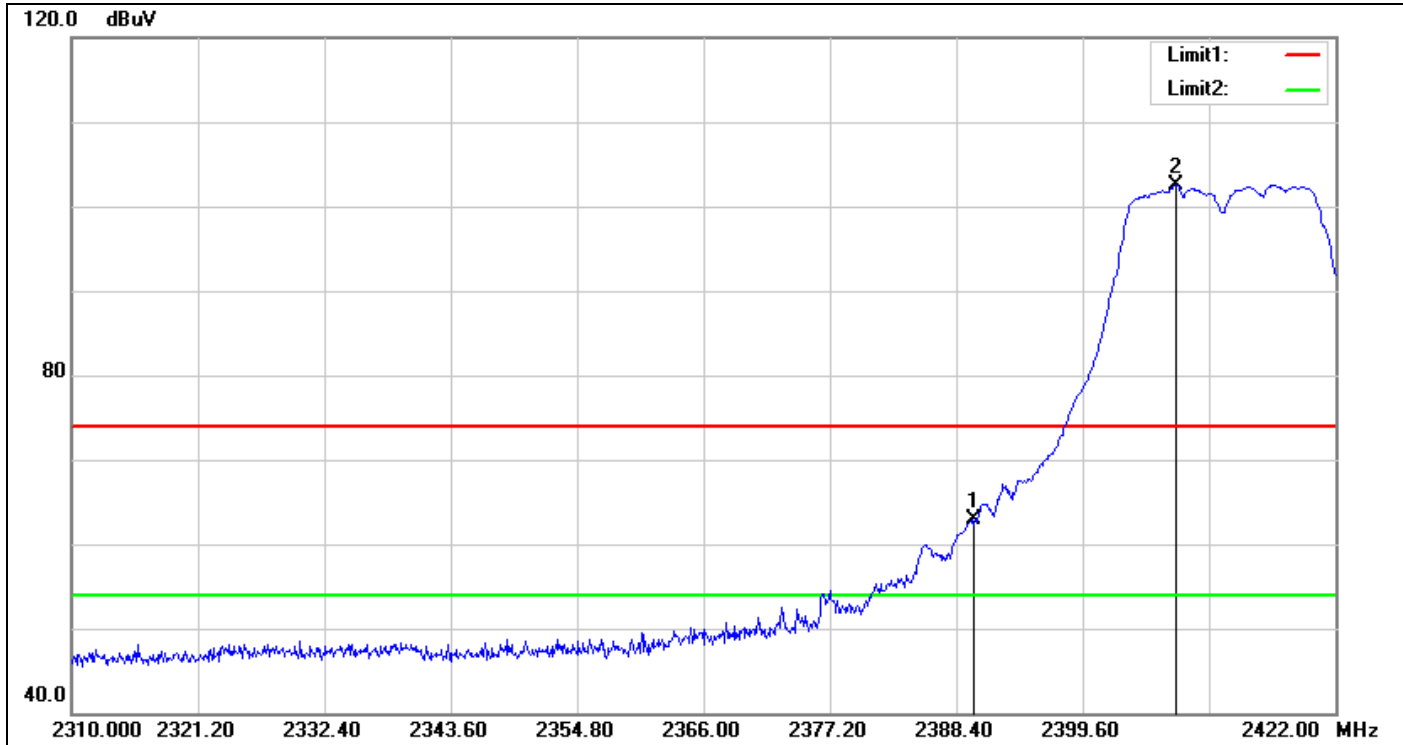

No.	Frequency (MHz)	Reading (dBuV)	Correct Factor(dB)	Result (dBuV)	Limit (dBuV)	Margin (dB)	Remark
1	2390.000	65.34	-2.49	62.85	74.00	-11.15	peak
2	2407.888	104.94	-2.43	102.51	-	-	peak

**Detector mode: Average**

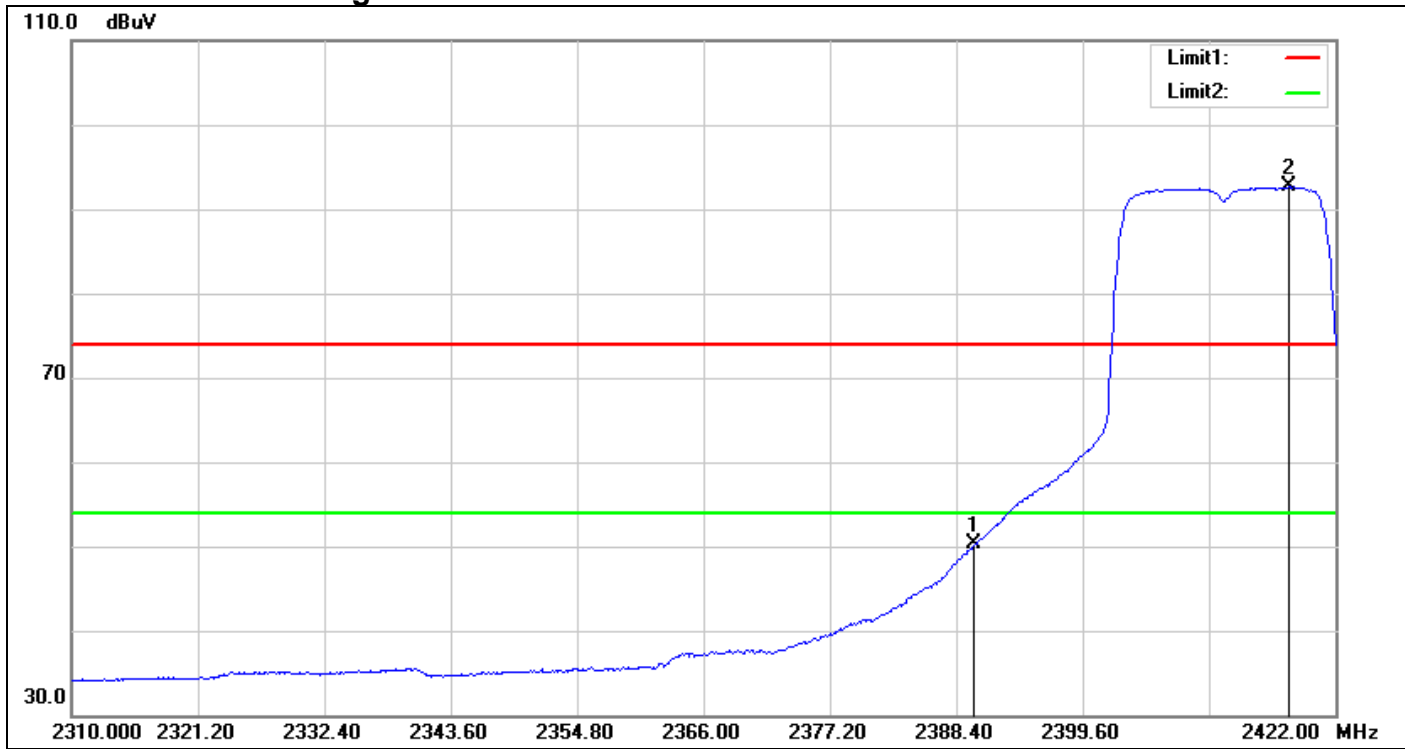

No.	Frequency (MHz)	Reading (dBuV)	Correct Factor(dB)	Result (dBuV)	Limit (dBuV)	Margin (dB)	Remark
1	2390.000	52.72	-2.49	50.23	54.00	-3.77	AVG
2	2417.856	95.03	-2.37	92.66	-	-	AVG

**Band Edges (IEEE 802.11n HT 20 MHz mode / CH Mid)**

**Detector mode: Peak**

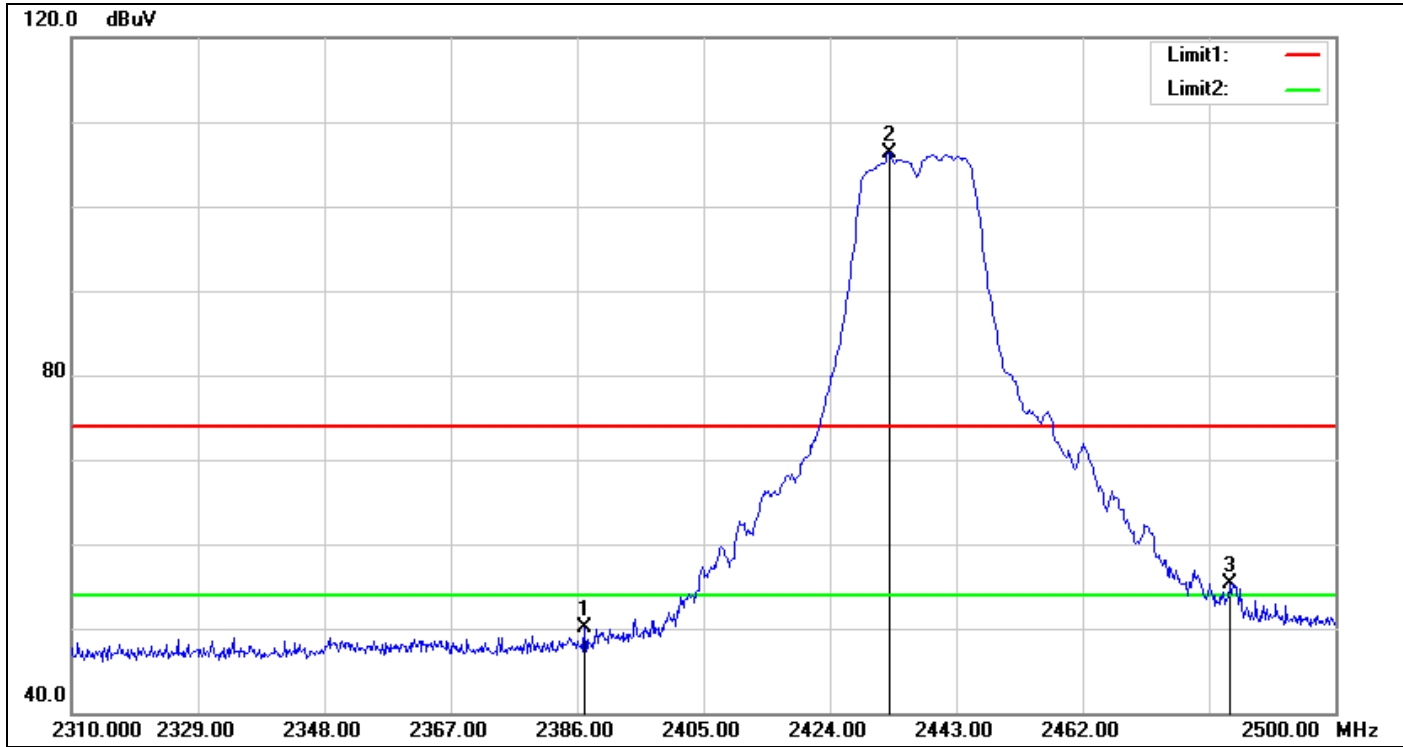

No.	Frequency (MHz)	Reading (dBuV)	Correct Factor(dB)	Result (dBuV)	Limit (dBuV)	Margin (dB)	Remark
1	2387.140	52.60	-2.52	50.08	74.00	-23.92	peak
2	2432.930	108.65	-2.26	106.39	-	-	peak
3	2484.230	57.32	-1.99	55.33	74.00	-18.67	peak

**Detector mode: Average**

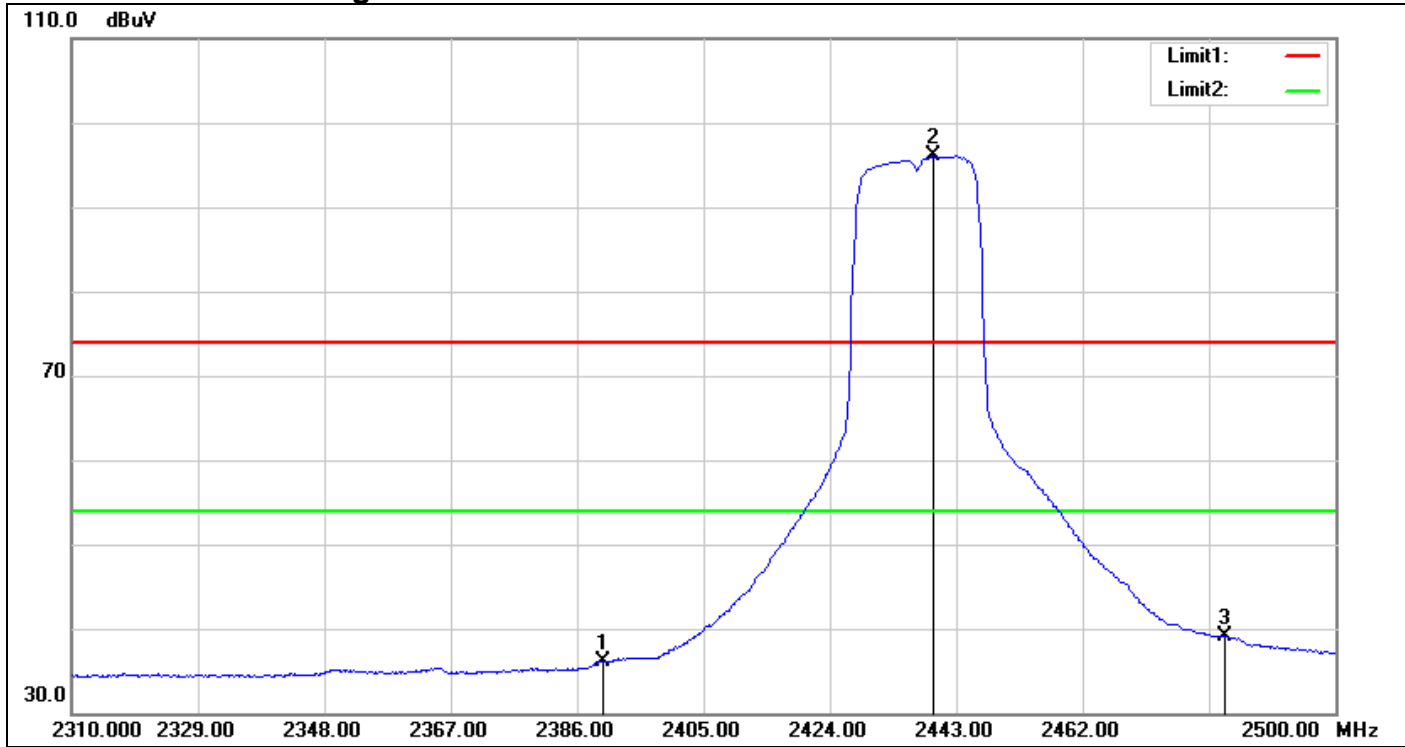

No.	Frequency (MHz)	Reading (dBuV)	Correct Factor(dB)	Result (dBuV)	Limit (dBuV)	Margin (dB)	Remark
1	2390.000	38.58	-2.49	36.09	54.00	-17.91	AVG
2	2439.580	98.27	-2.22	96.05	-	-	AVG
3	2483.500	41.08	-1.99	39.09	54.00	-14.91	AVG

**Band Edges (IEEE 802.11n HT 20 MHz mode / CH High)**

**Detector mode: Peak**

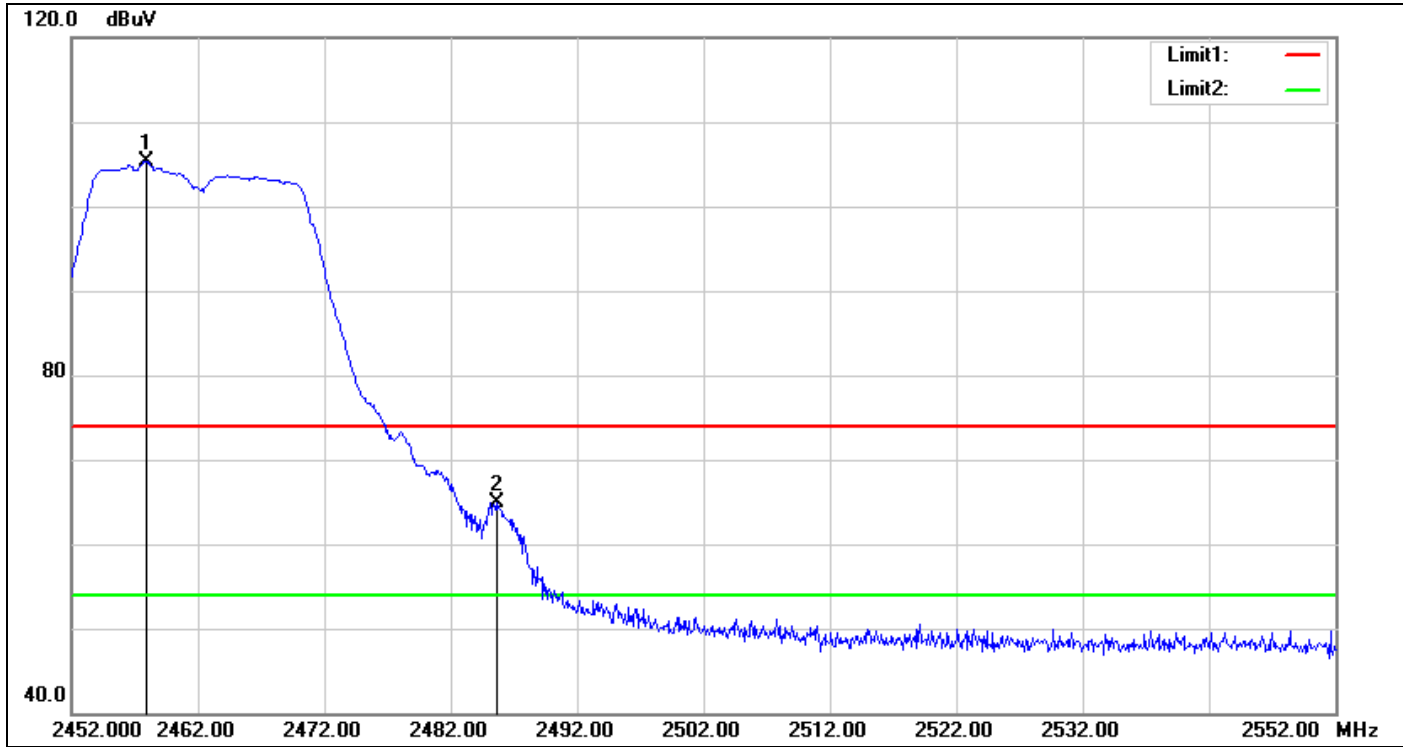

No.	Frequency (MHz)	Reading (dBuV)	Correct Factor(dB)	Result (dBuV)	Limit (dBuV)	Margin (dB)	Remark
1	2457.900	107.45	-2.11	105.34	-	-	peak
2	2485.600	66.90	-1.97	64.93	74.00	-9.07	peak



**Detector mode: Average**

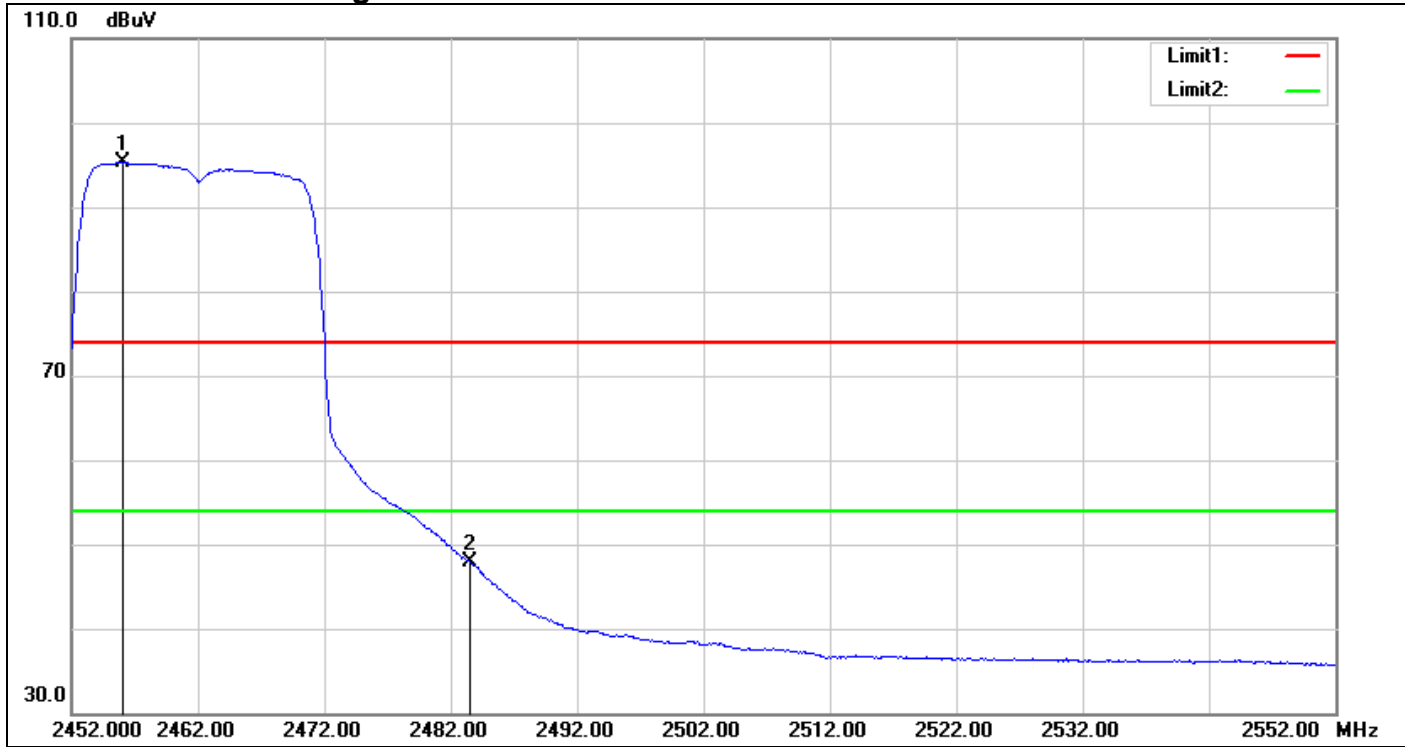

No.	Frequency (MHz)	Reading (dBuV)	Correct Factor(dB)	Result (dBuV)	Limit (dBuV)	Margin (dB)	Remark
1	2456.000	97.44	-2.12	95.32	-	-	AVG
2	2483.500	49.83	-1.99	47.84	54.00	-6.16	AVG

**Band Edges (IEEE 802.11n HT 40 MHz mode / CH Low)**

**Detector mode: Peak**

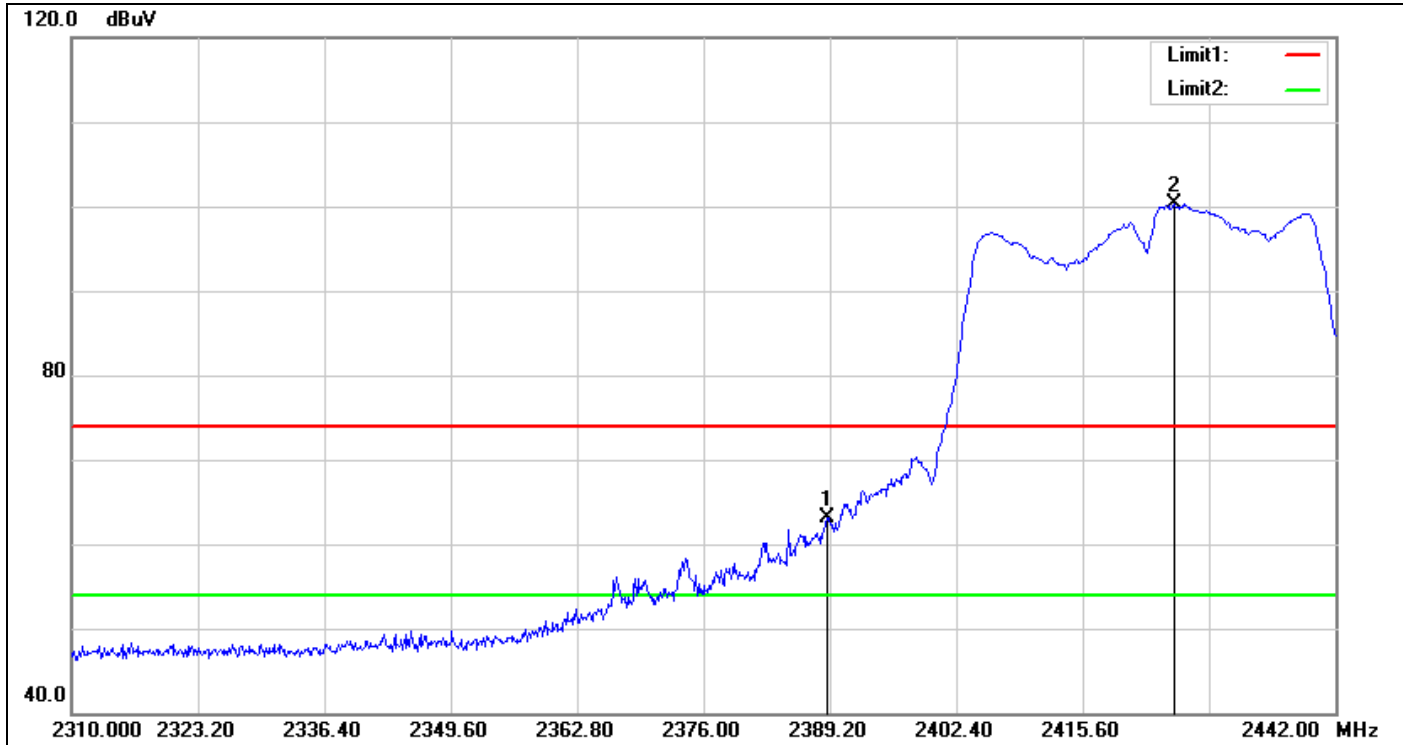

No.	Frequency (MHz)	Reading (dBuV)	Correct Factor(dB)	Result (dBuV)	Limit (dBuV)	Margin (dB)	Remark
1	2388.936	65.67	-2.50	63.17	74.00	-10.83	peak
2	2425.104	102.56	-2.32	100.24	-	-	peak

**Detector mode: Average**

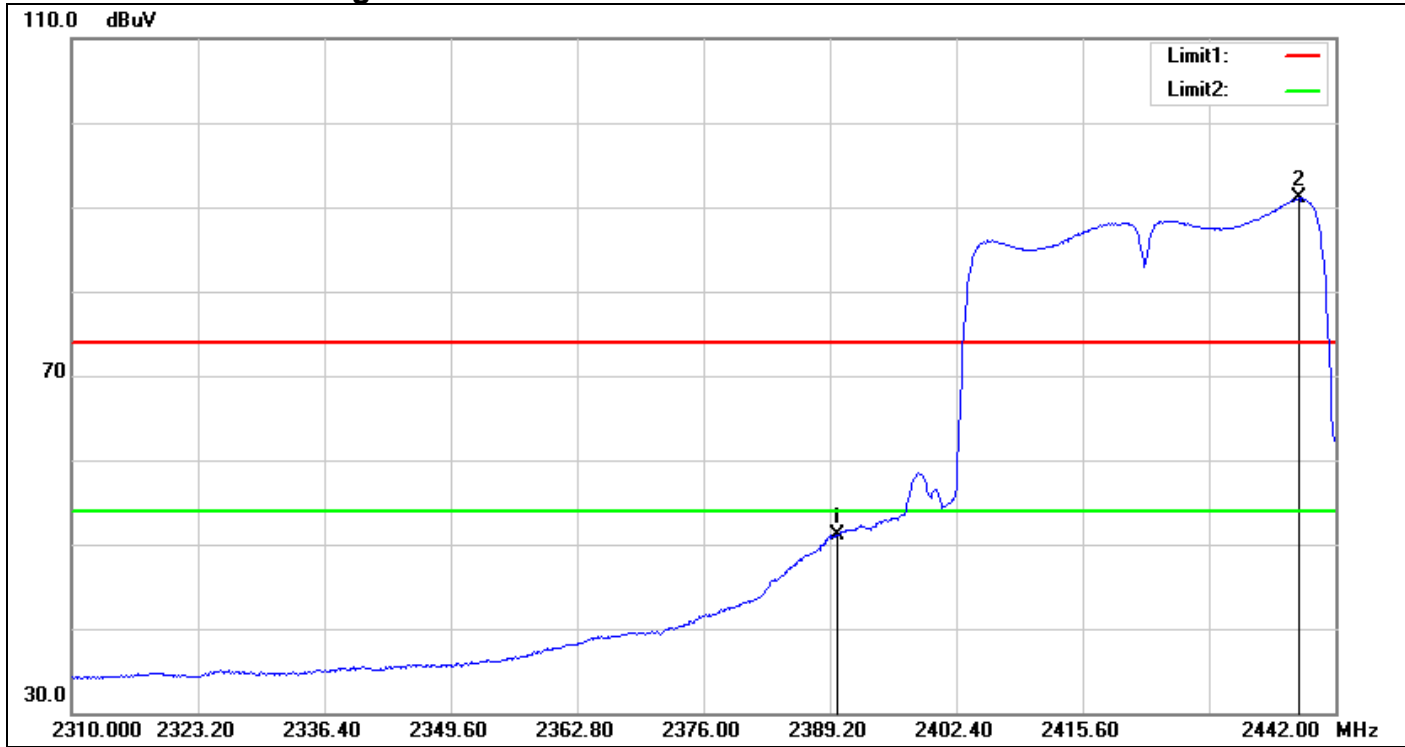

No.	Frequency (MHz)	Reading (dBuV)	Correct Factor(dB)	Result (dBuV)	Limit (dBuV)	Margin (dB)	Remark
1	2390.000	53.63	-2.49	51.14	54.00	-2.86	AVG
2	2438.172	93.28	-2.23	91.05	-	-	AVG

**Band Edges (IEEE 802.11n HT 40 MHz mode / CH Mid)**

**Detector mode: Peak**

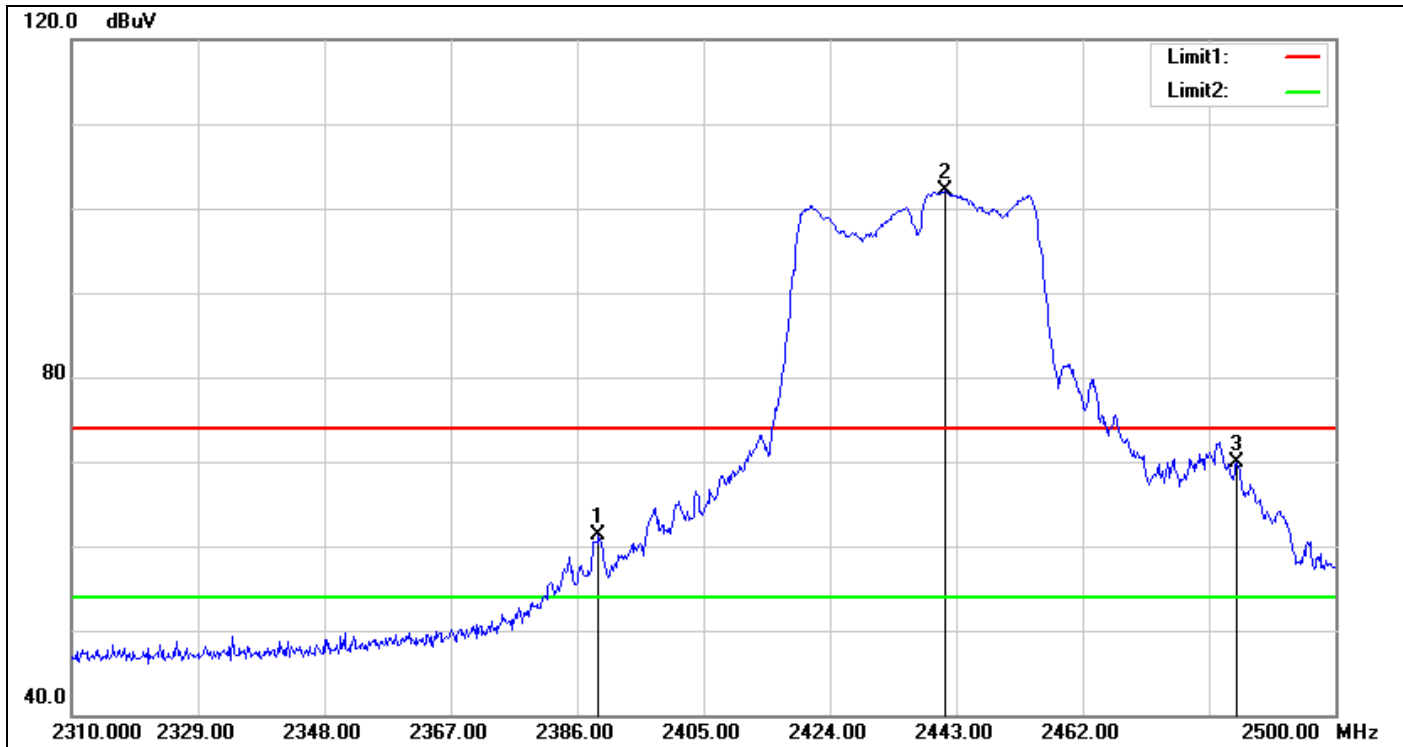

No.	Frequency (MHz)	Reading (dBuV)	Correct Factor(dB)	Result (dBuV)	Limit (dBuV)	Margin (dB)	Remark
1	2389.230	63.83	-2.50	61.33	74.00	-12.67	peak
2	2441.290	104.23	-2.20	102.03	-	-	peak
3	2485.180	71.86	-1.98	69.88	74.00	-4.12	peak

**Detector mode: Average**

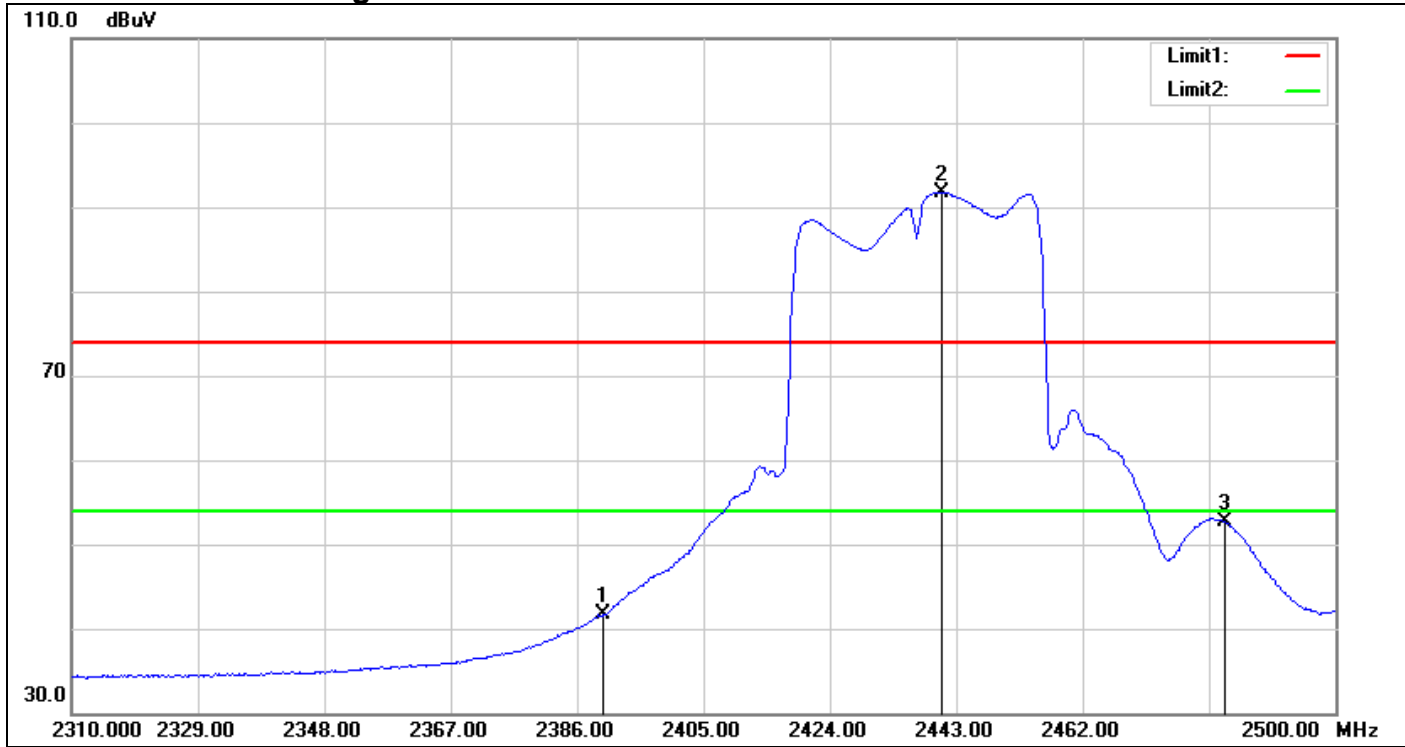

No.	Frequency (MHz)	Reading (dBuV)	Correct Factor(dB)	Result (dBuV)	Limit (dBuV)	Margin (dB)	Remark
1	2390.000	44.15	-2.49	41.66	54.00	-12.34	AVG
2	2440.910	94.01	-2.21	91.80	-	-	AVG
3	2483.470	54.70	-2.00	52.70	54.00	-1.30	AVG

**Band Edges (IEEE 802.11n HT 40 MHz mode / CH High)**

**Detector mode: Peak**

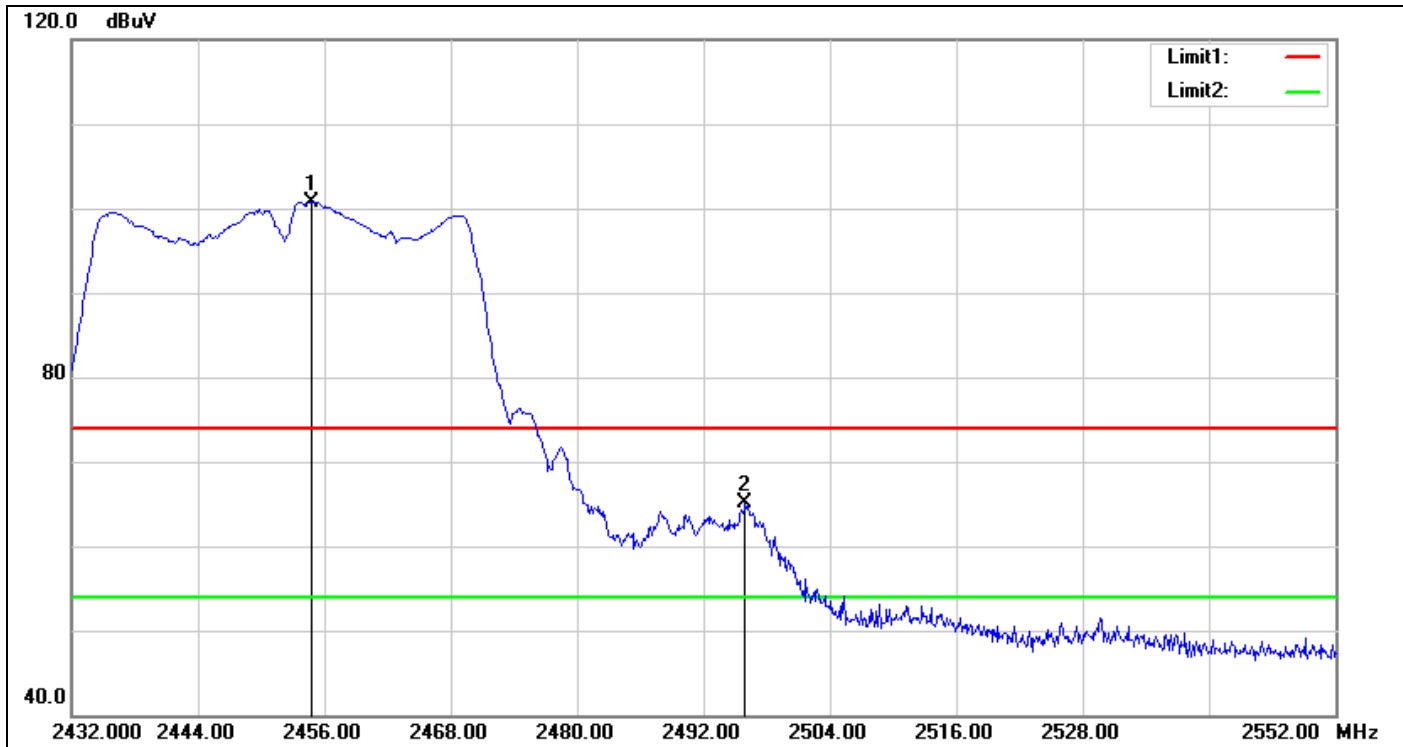

No.	Frequency (MHz)	Reading (dBuV)	Correct Factor(dB)	Result (dBuV)	Limit (dBuV)	Margin (dB)	Remark
1	2454.800	102.84	-2.12	100.72	-	-	peak
2	2495.960	66.90	-1.89	65.01	74.00	-8.99	peak

**Detector mode: Average**

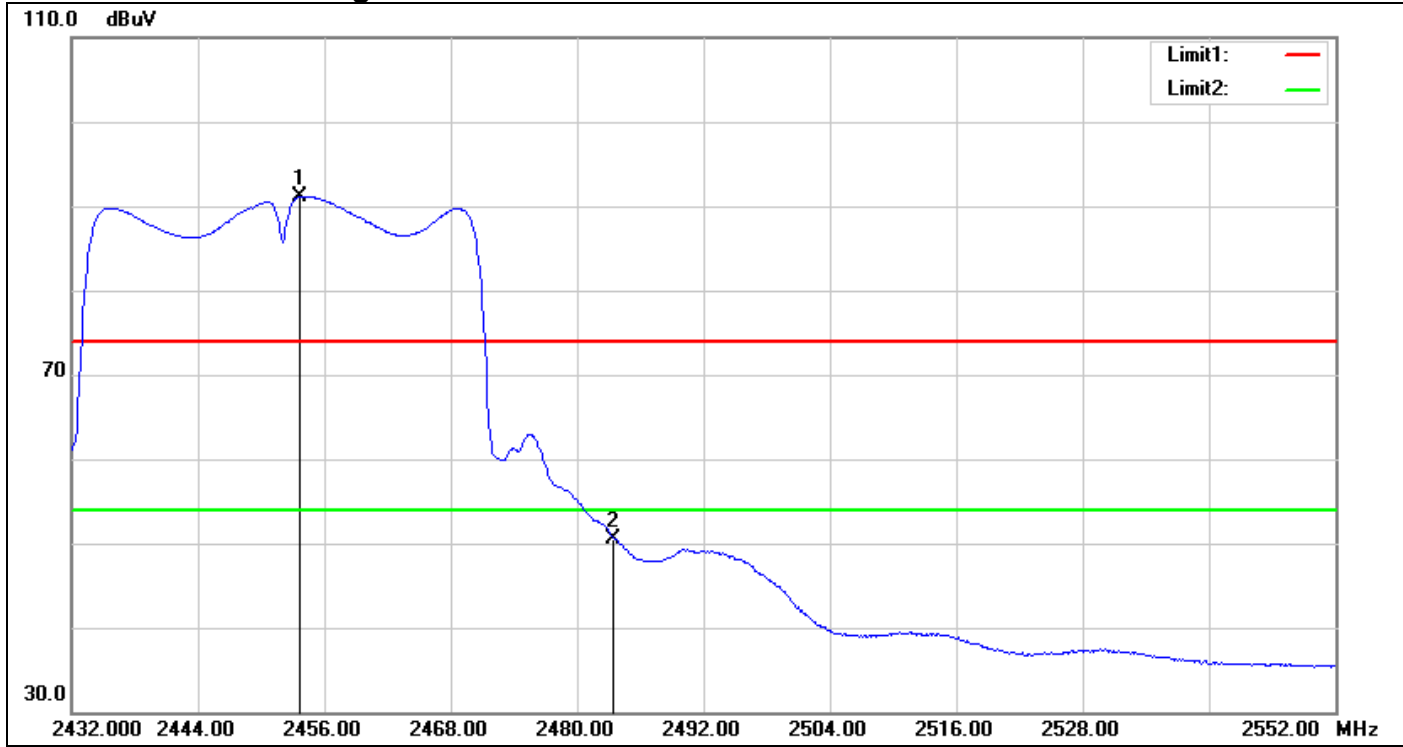

No.	Frequency (MHz)	Reading (dBuV)	Correct Factor(dB)	Result (dBuV)	Limit (dBuV)	Margin (dB)	Remark
1	2453.600	93.19	-2.13	91.06	-	-	AVG
2	2483.500	52.51	-1.99	50.52	54.00	-3.48	AVG

**Test Plot**

**Un-restricted Band Emissions (IEEE 802.11b mode / CH Low)**

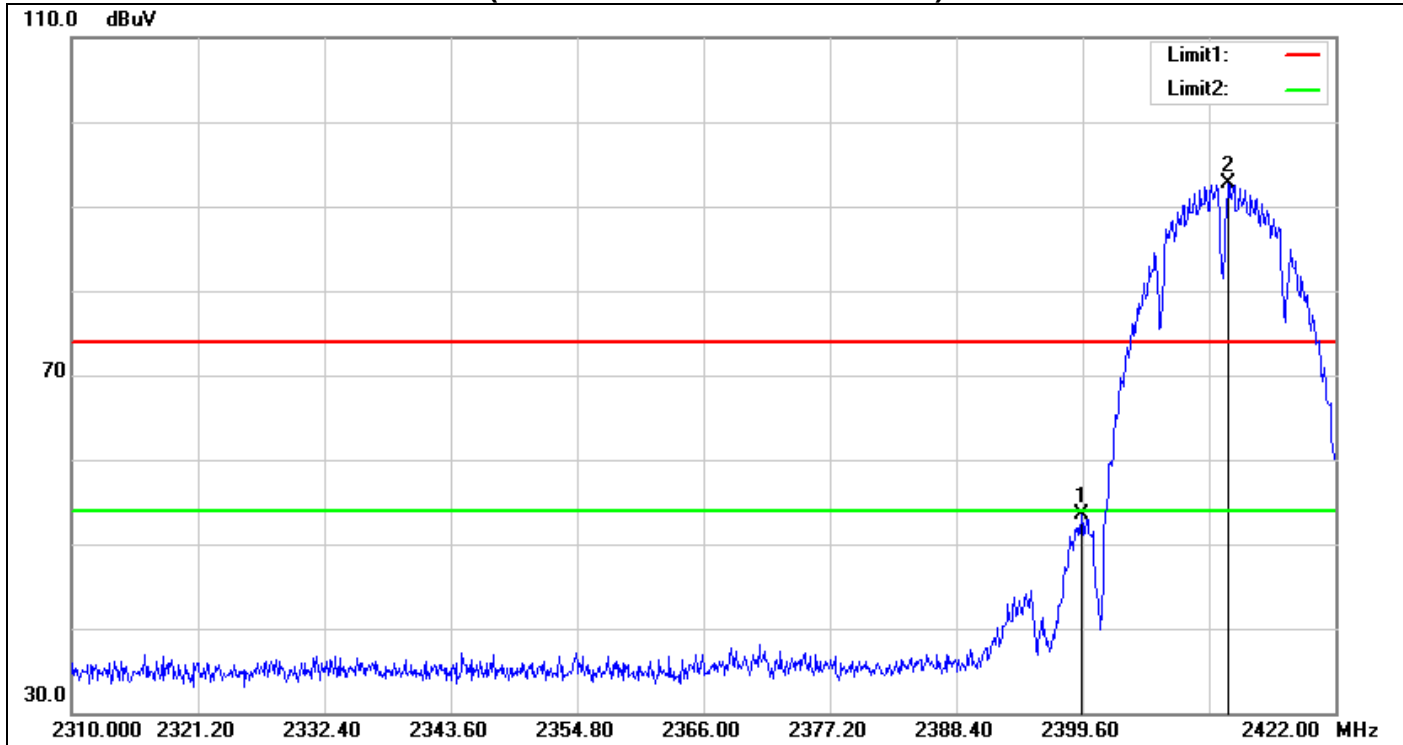

No.	Frequency (MHz)	Reading (dBuV)	Correct Factor(dB)	Result (dBuV)	Remark
1	2399.488	55.92	-2.41	53.51	peak
2	2412.480	95.07	-2.41	92.66	peak

**Note: Spurious emission levels that exceed the level of 20 dB below the applicable limit.**



**Un-restricted Band Emissions (IEEE 802.11b mode / CH High)**

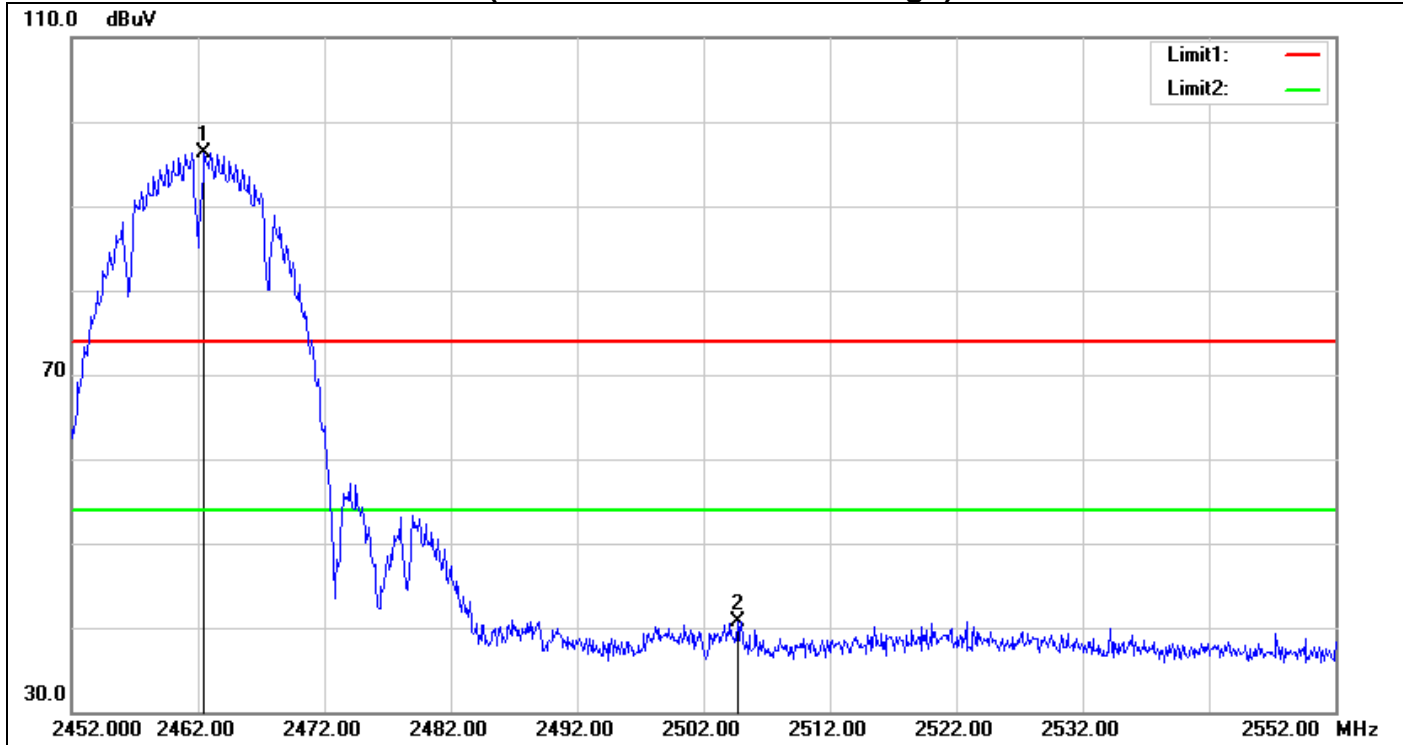

No.	Frequency (MHz)	Reading (dBuV)	Correct Factor(dB)	Result (dBuV)	Remark
1	2462.500	98.36	-2.09	96.27	peak
2	2504.700	42.65	-1.85	40.80	peak

**Note: Spurious emission levels that exceed the level of 20 dB below the applicable limit.**

**Un-restricted Band Emissions (IEEE 802.11g mode / CH Low)**

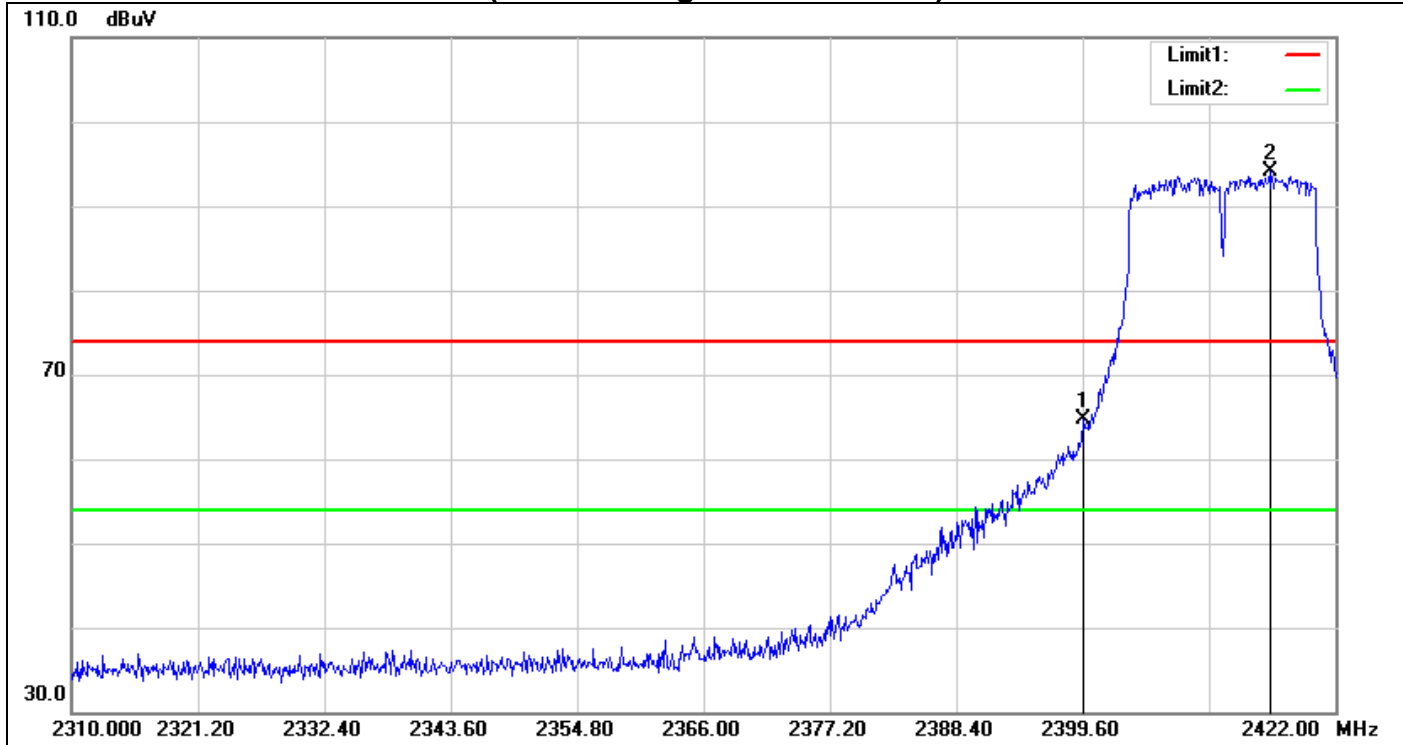

No.	Frequency (MHz)	Reading (dBuV)	Correct Factor(dB)	Result (dBuV)	Remark
1	2399.712	67.15	-2.41	64.74	peak
2	2416.176	96.50	-2.39	94.11	peak

**Note: Spurious emission levels that exceed the level of 20 dB below the applicable limit.**

**Un-restricted Band Emissions (IEEE 802.11g mode / CH High)**

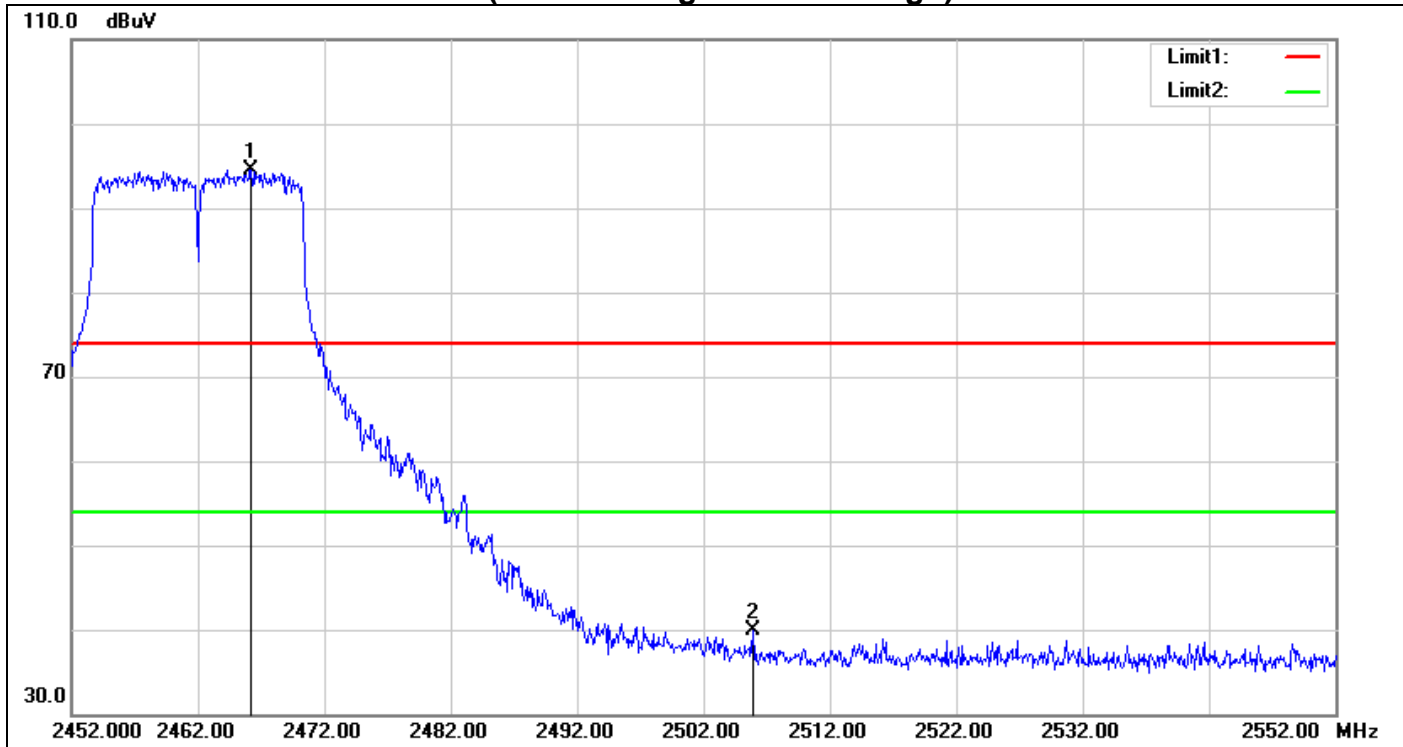

No.	Frequency (MHz)	Reading (dBuV)	Correct Factor(dB)	Result (dBuV)	Remark
1	2466.200	96.60	-2.08	94.52	peak
2	2505.900	41.71	-1.85	39.86	peak

**Note: Spurious emission levels that exceed the level of 20 dB below the applicable limit.**

**Un-restricted Band Emissions (IEEE 802.11n HT 20 MHz mode / CH Low)**

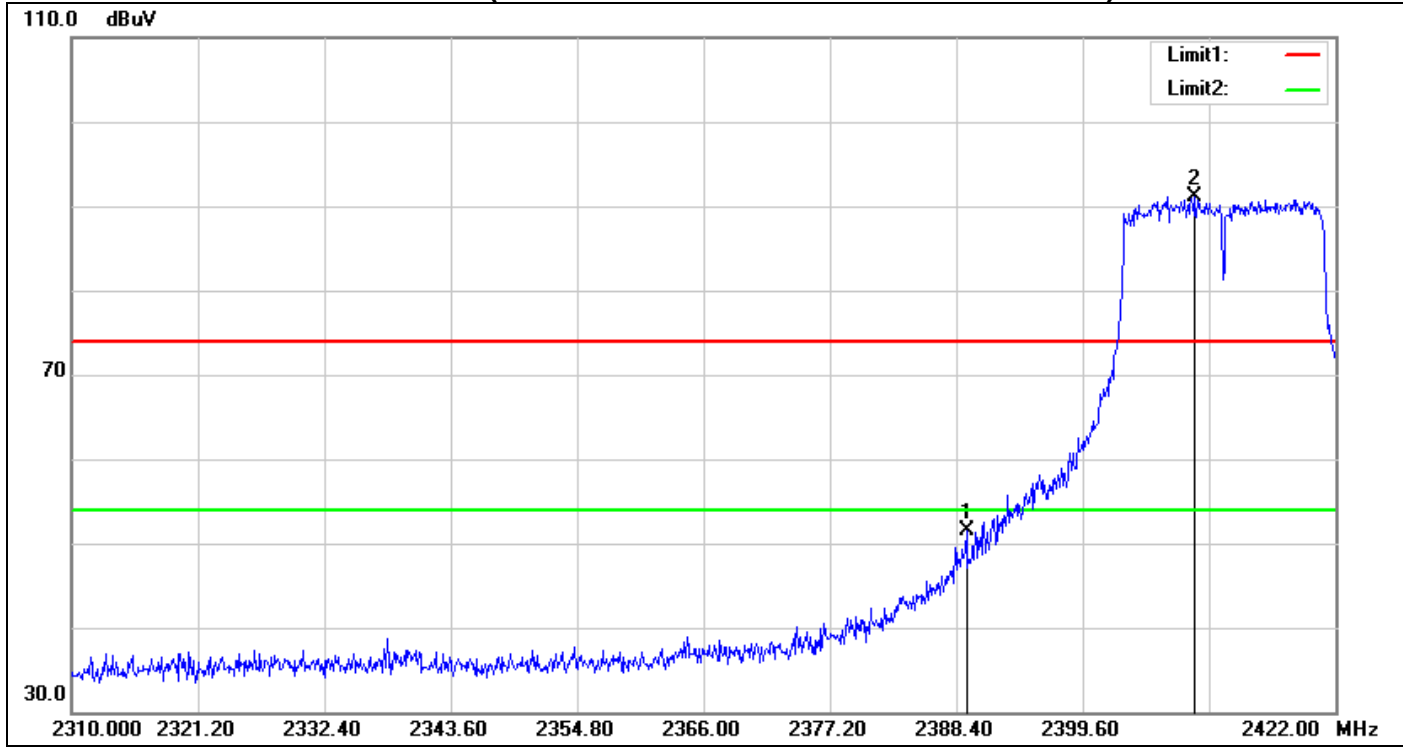

No.	Frequency (MHz)	Reading (dBuV)	Correct Factor(dB)	Result (dBuV)	Remark
1	2389.296	53.92	-2.50	51.42	peak
2	2409.568	93.62	-2.43	91.19	peak

**Note: Spurious emission levels that exceed the level of 20 dB below the applicable limit.**

**Un-restricted Band Emissions (IEEE 802.11n HT 20 MHz mode / CH High)**

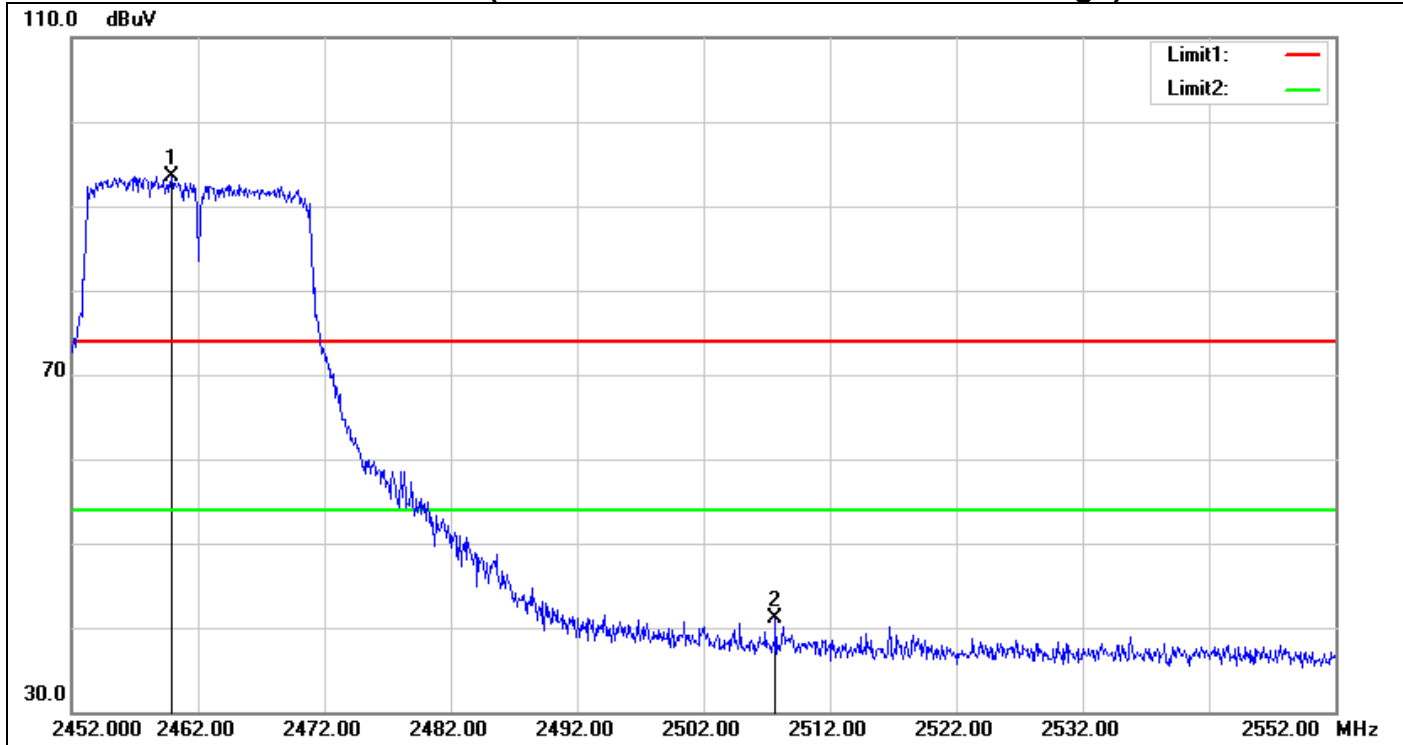

No.	Frequency (MHz)	Reading (dBuV)	Correct Factor(dB)	Result (dBuV)	Remark
1	2459.900	95.63	-2.10	93.53	peak
2	2507.700	42.91	-1.84	41.07	peak

**Note: Spurious emission levels that exceed the level of 20 dB below the applicable limit.**

**Un-restricted Band Emissions (IEEE 802.11n HT 40 MHz mode / CH Low)**

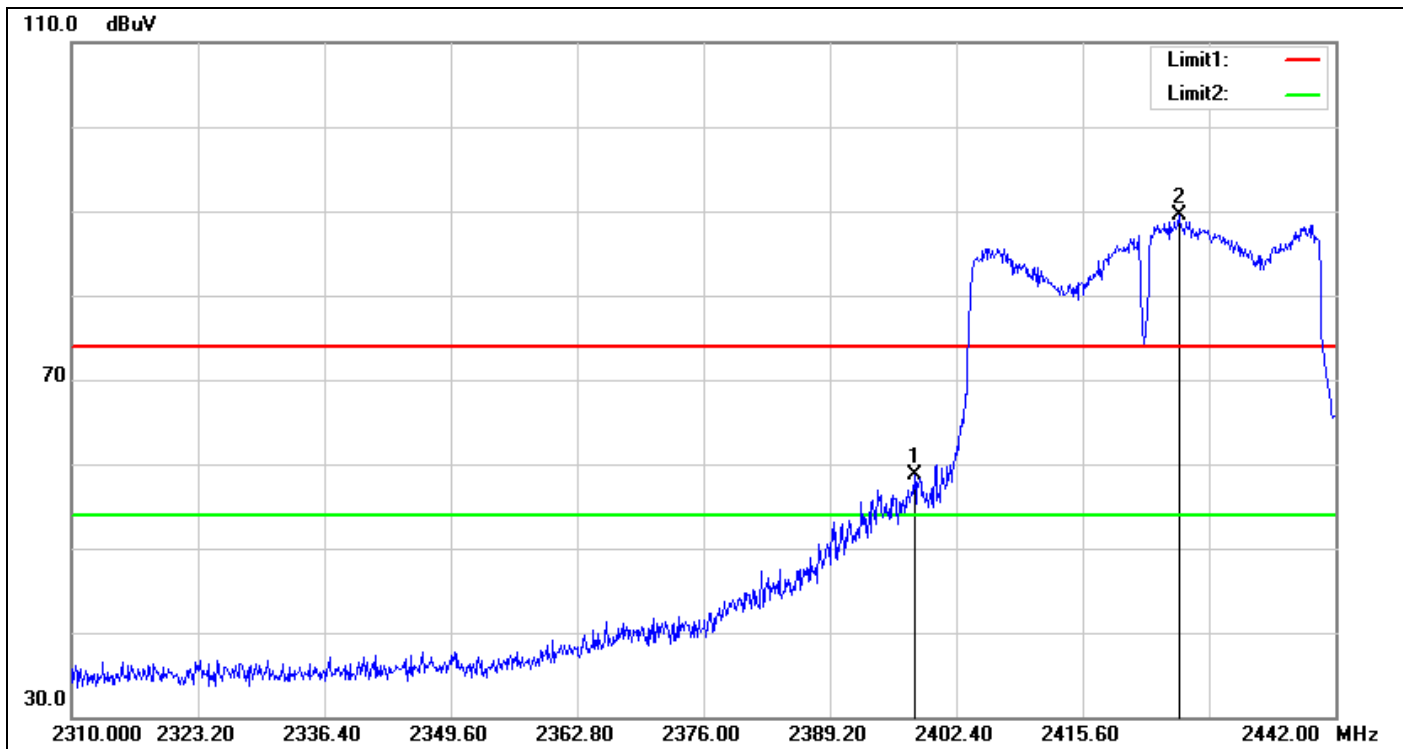

No.	Frequency (MHz)	Reading (dBuV)	Correct Factor(dB)	Result (dBuV)	Remark
1	2398.044	61.08	-2.43	58.65	peak
2	2425.632	91.74	-2.32	89.42	peak

**Note: Spurious emission levels that exceed the level of 20 dB below the applicable limit.**

**Un-restricted Band Emissions (IEEE 802.11n HT 40 MHz mode / CH High)**

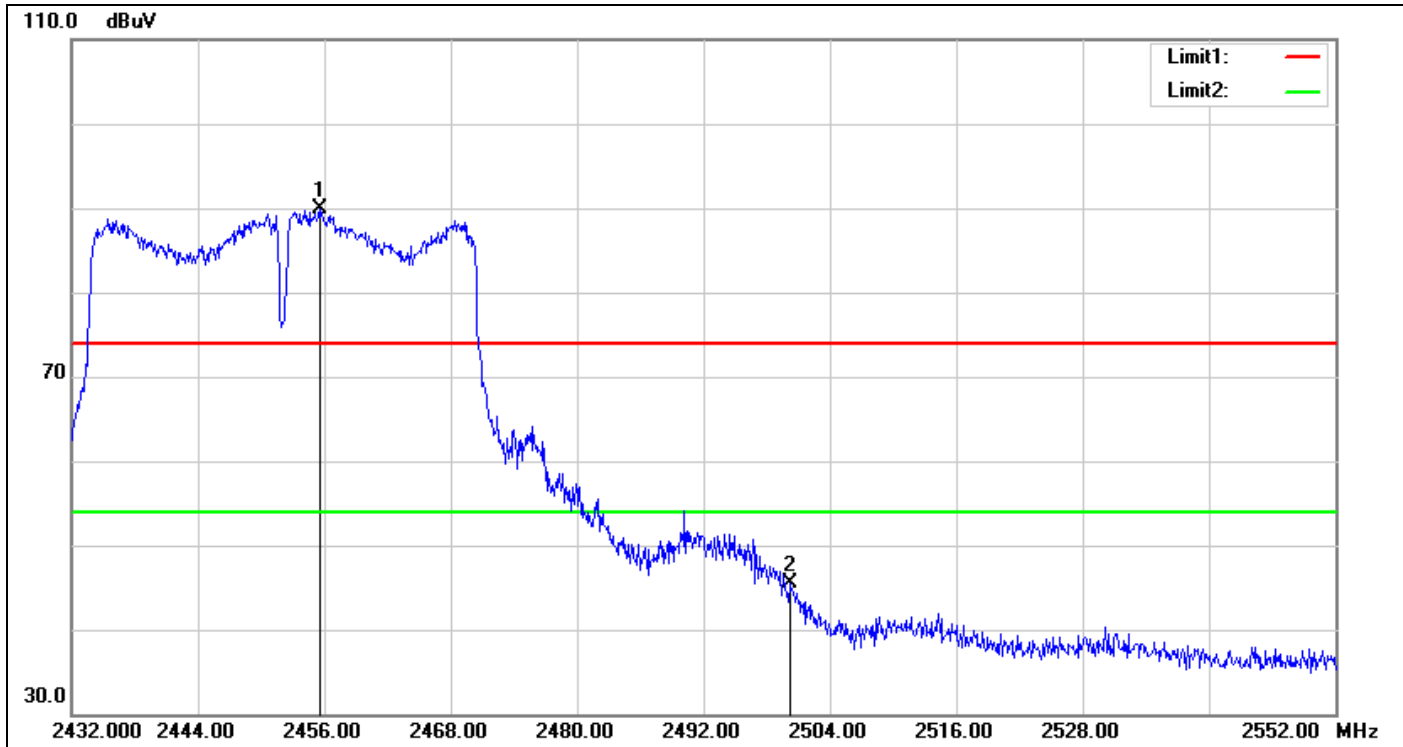

No.	Frequency (MHz)	Reading (dBuV)	Correct Factor(dB)	Result (dBuV)	Remark
1	2455.520	91.95	-2.12	89.83	peak
2	2500.160	47.34	-1.86	45.48	peak

**Note: Spurious emission levels that exceed the level of 20 dB below the applicable limit.**

## 7.6 PEAK POWER SPECTRAL DENSITY

### LIMIT

1. According to §15.247(e) & RSS-247, for digitally modulated systems, the power spectral density conducted from the intentional radiator to the antenna shall not be greater than 8 dBm in any 3 kHz band during any time interval of continuous transmission.
2. According to §15.247(f) & RSS-247, the digital modulation operation of the hybrid system, with the frequency hopping turned off, shall comply with the power density requirements of paragraph (d) of this section.

### Test Configuration

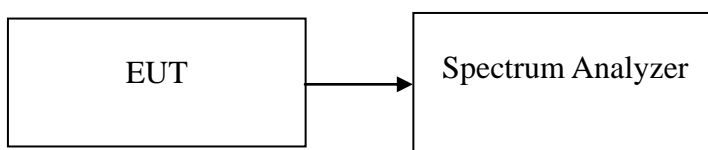

### TEST PROCEDURE

1. Place the EUT on the table and set it in transmitting mode. Remove the antenna from the EUT and then connect a low loss RF cable from the antenna port to the spectrum analyzer.
2. Set the spectrum analyzer as RBW = 3 kHz, VBW = 30 kHz, Span = 1.5 times the bandwidth , Sweep time = auto
3. Record the max reading.
4. Repeat the above procedure until the measurements for all frequencies are completed.

### TEST RESULTS

*No non-compliance noted*



## Test Data

### IEEE 802.11b mode

Channel	Frequency (MHz)	PPSD (dBm)	Limit (dBm)	Result
Low	2412	-15.27	8.00	PASS
Mid	2437	-12.00		PASS
High	2462	-12.70		PASS

### IEEE 802.11g mode

Channel	Frequency (MHz)	PPSD (dBm)	Limit (dBm)	Result
Low	2412	-13.89	8.00	PASS
Mid	2437	-13.37		PASS
High	2462	-13.72		PASS

### IEEE 802.11n HT 20 MHz mode

Channel	Frequency (MHz)	Chain 0 PPSD (dBm)	Chain 1 PPSD (dBm)	PPSD (dBm)	Limit (dBm)	Result
Low	2412	-15.97	-16.72	-13.32	8.00	PASS
Mid	2437	-16.17	-16.72	-13.43		PASS
High	2462	-15.04	-16.05	-12.51		PASS

### IEEE 802.11n HT 40 MHz mode

Channel	Frequency (MHz)	Chain 0 PPSD (dBm)	Chain 1 PPSD (dBm)	PPSD (dBm)	Limit (dBm)	Result
Low	2422	-16.52	-18.28	-14.30	8.00	PASS
Mid	2437	-16.95	-18.51	-14.65		PASS
High	2452	-16.18	-19.07	-14.38		PASS

**Remark:**

1. Total PPSD (dBm) =  $10 \cdot \text{LOG}(10^{\text{Chain 0 PPSD} / 10} + 10^{\text{Chain 1 PPSD} / 10})$

### Test Plot

### IEEE 802.11b mode

### PPSD (CH Low)

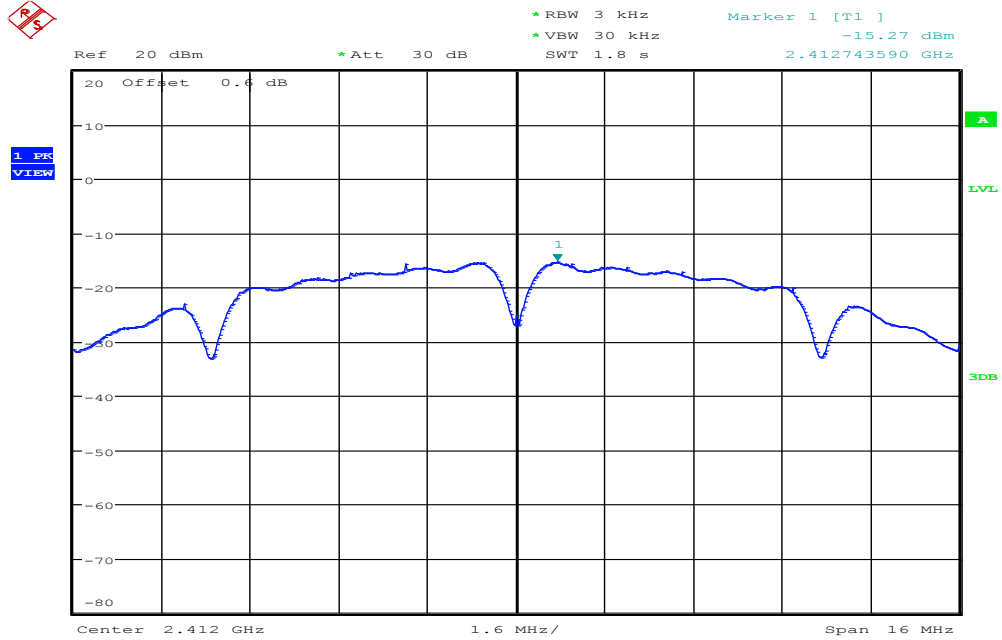

Date: 18.MAR.2016 14:17:08

### PPSD (CH Mid)

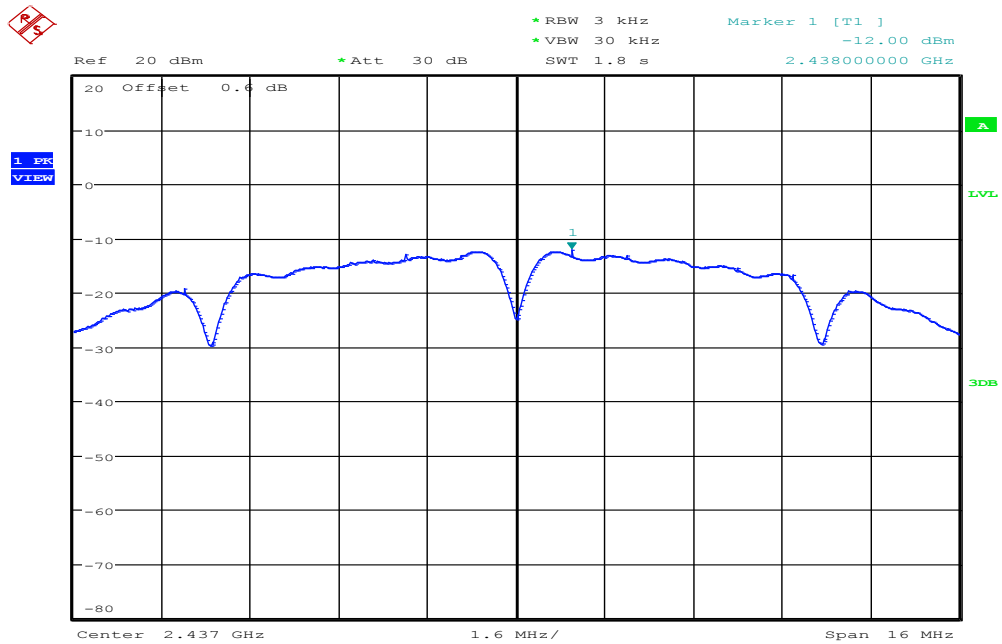

Date: 18.MAR.2016 14:18:11

### PPSD (CH High)

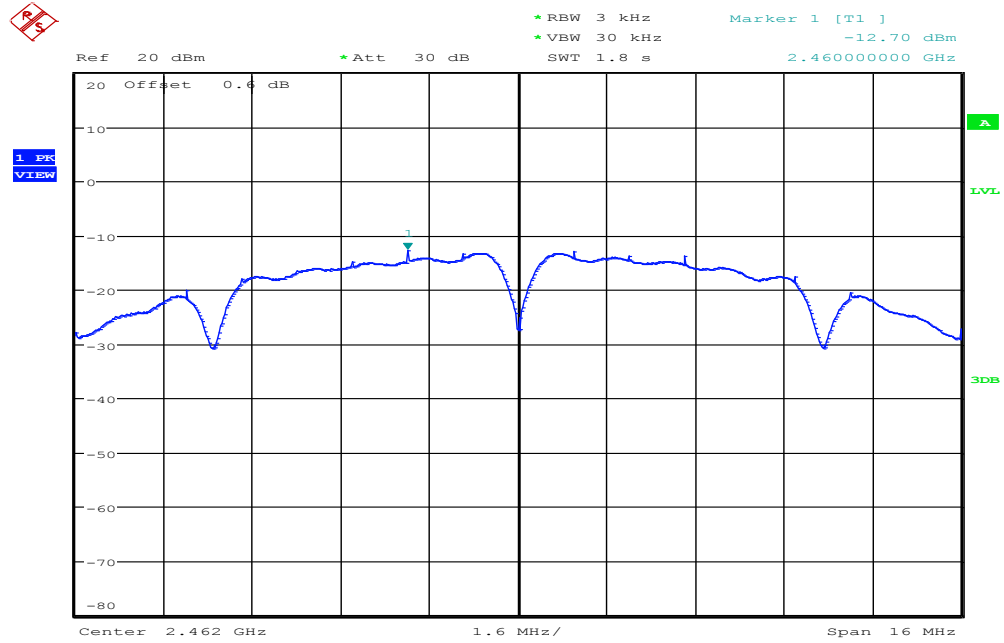

Date: 18.MAR.2016 14:19:02

### IEEE 802.11g mode

### PPSD (CH Low)

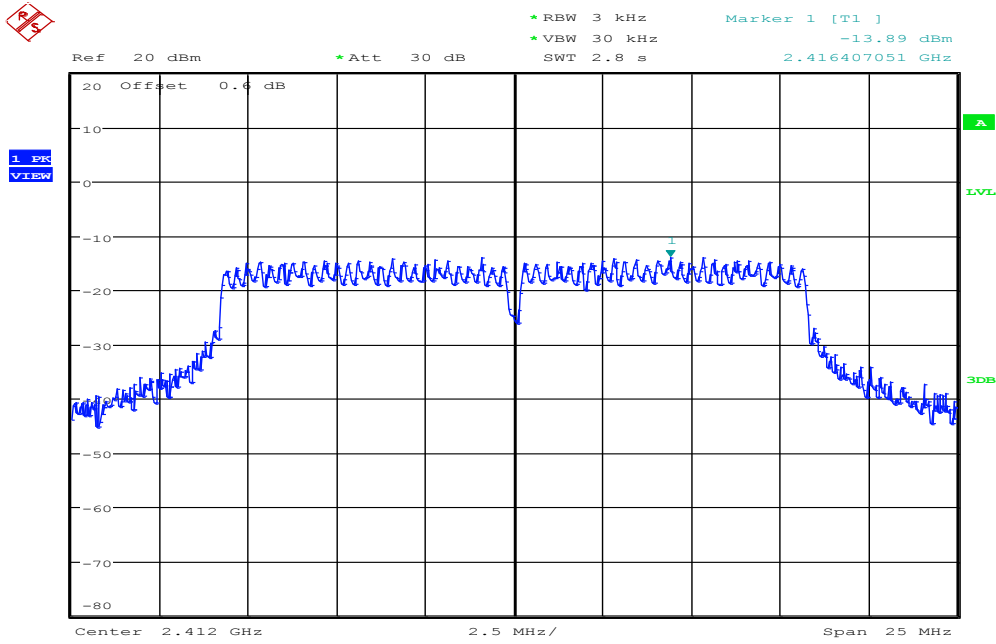

Date: 18.MAR.2016 14:30:59

### PPSD (CH Mid)

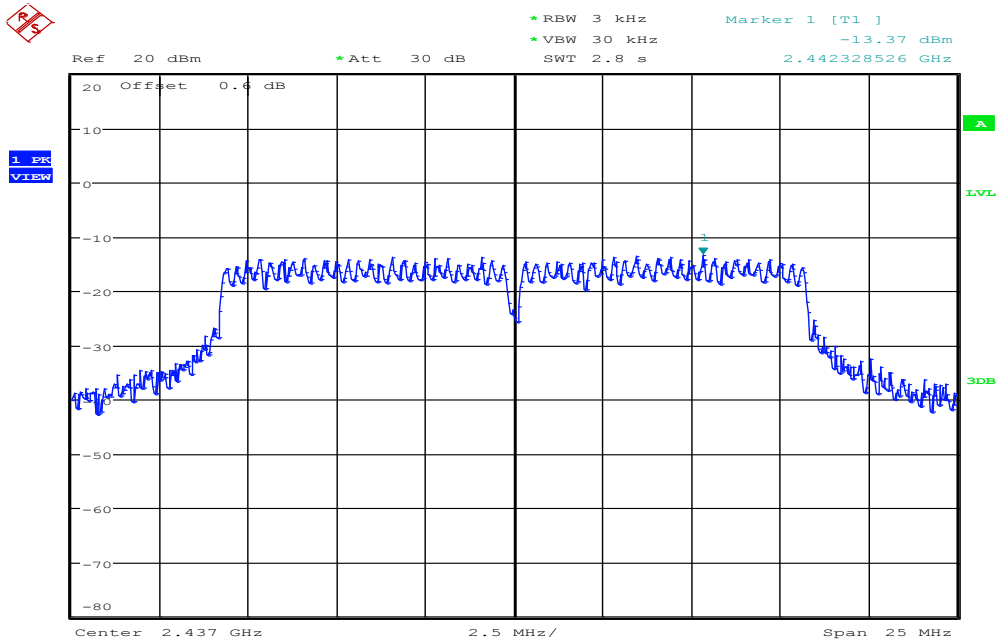

Date: 18.MAR.2016 14:34:43

### PPSD (CH High)

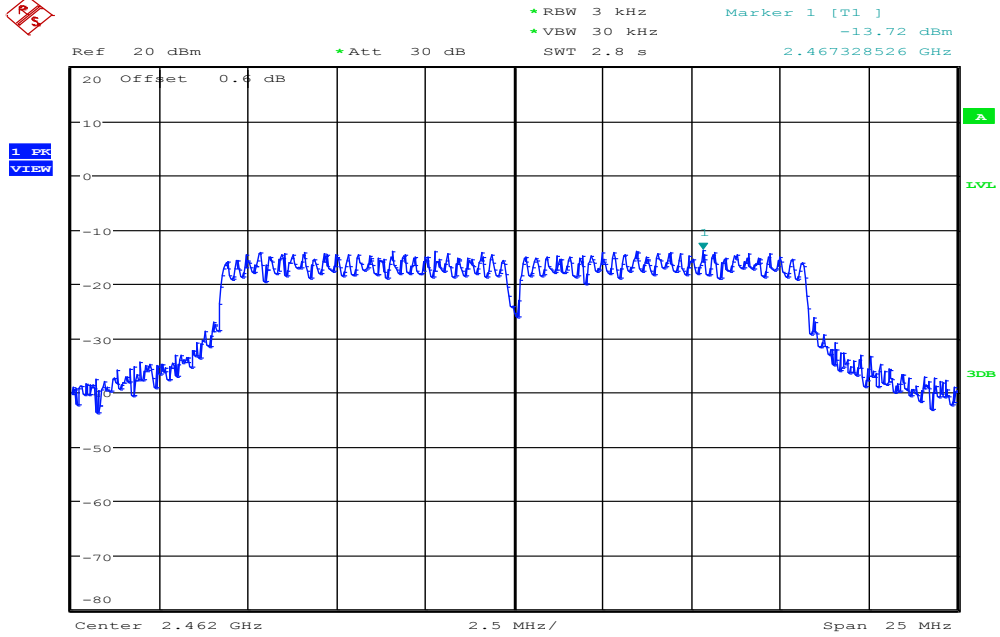

Date: 18.MAR.2016 14:35:35

### IEEE 802.11n HT 20 MHz mode / Chain 0

### PPSD (CH Low)

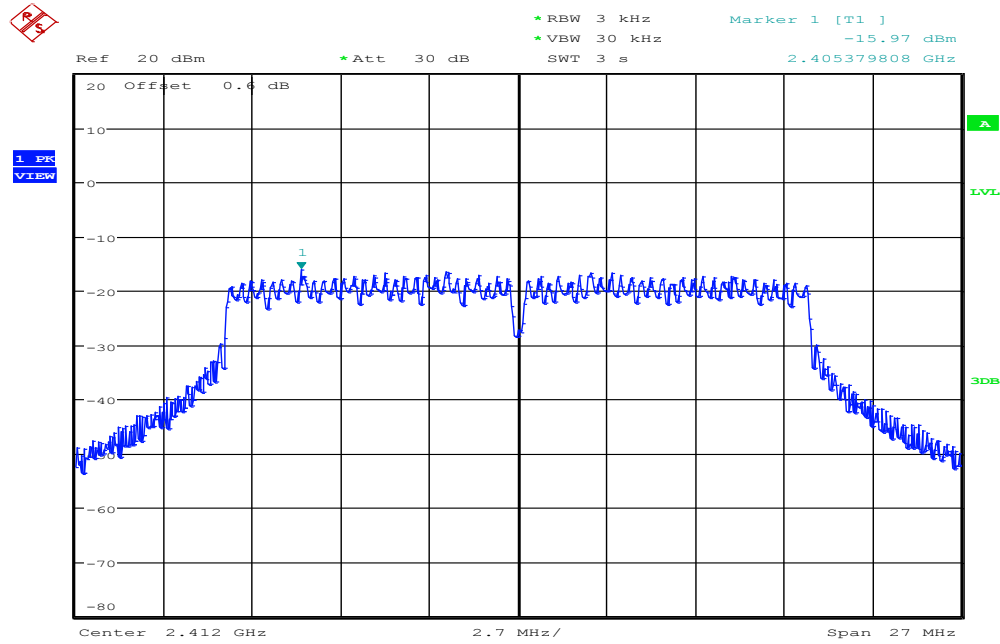

Date: 18.MAR.2016 14:48:38

### PPSD (CH Mid)

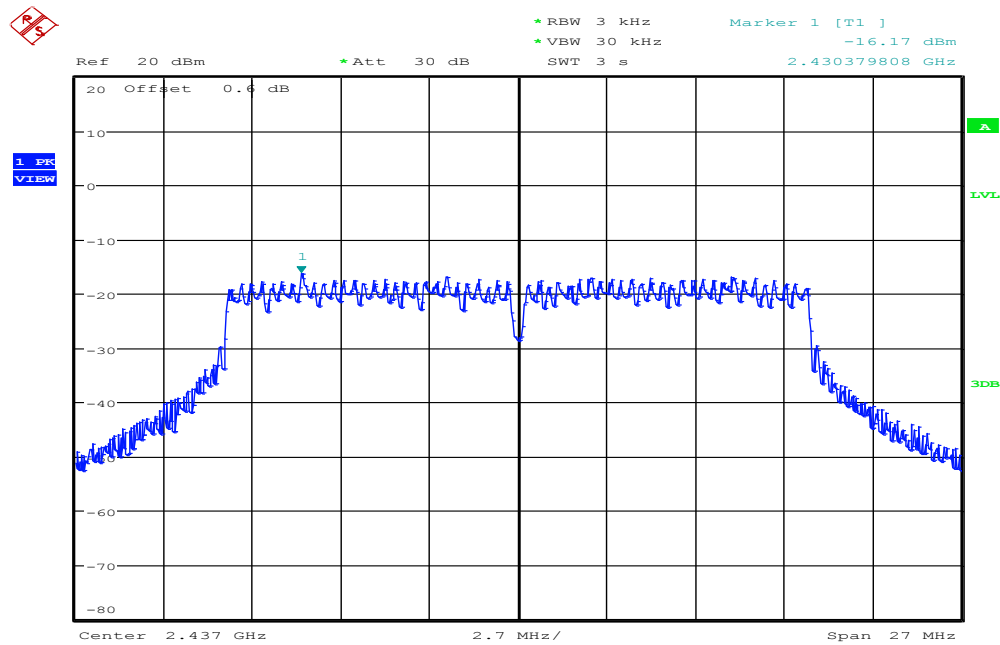

Date: 18.MAR.2016 14:49:35

### PPSD (CH High)

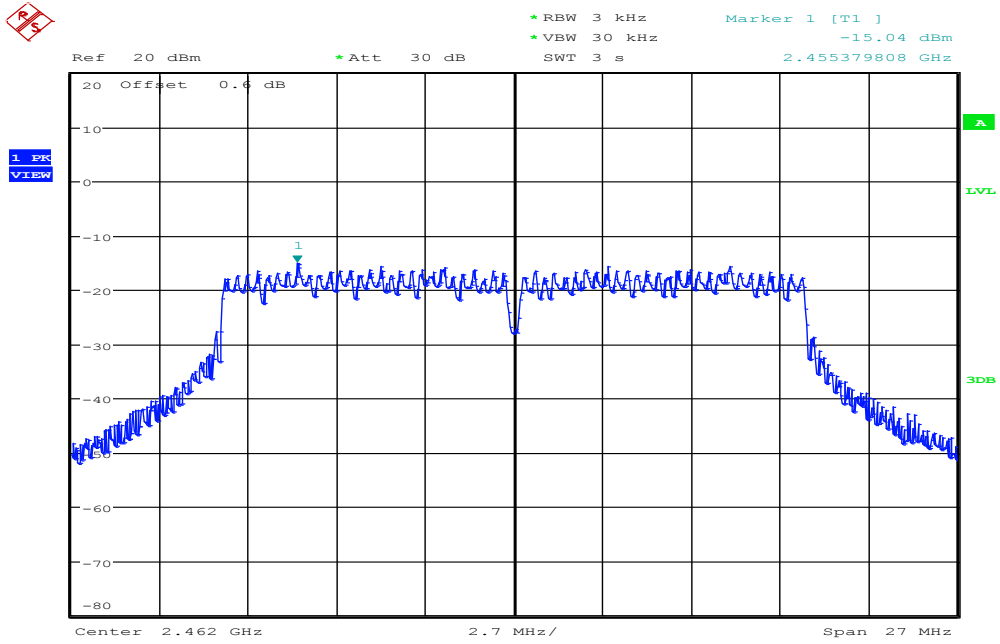

Date: 18.MAR.2016 14:50:35

### IEEE 802.11n HT 20 MHz mode / Chain 1

### PPSD (CH Low)

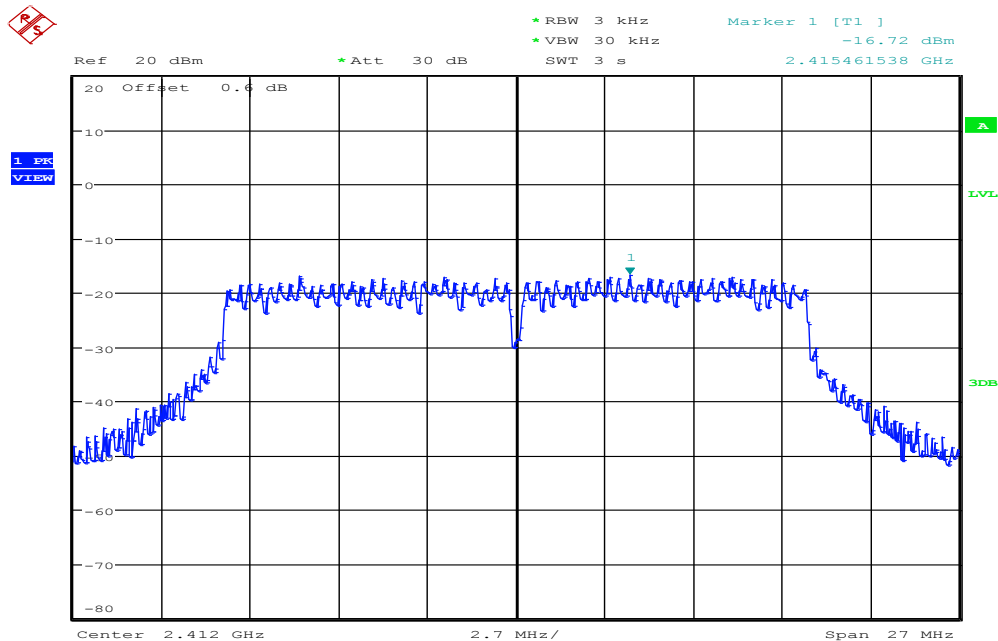

Date: 18.MAR.2016 16:23:33

### PPSD (CH Mid)

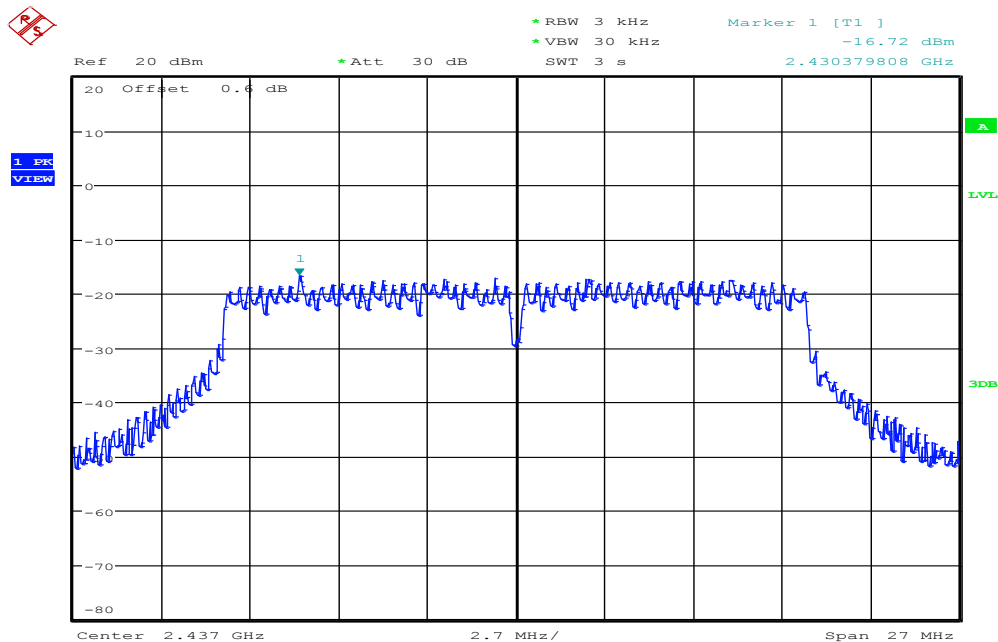

Date: 18.MAR.2016 16:24:18



### PPSD (CH High)

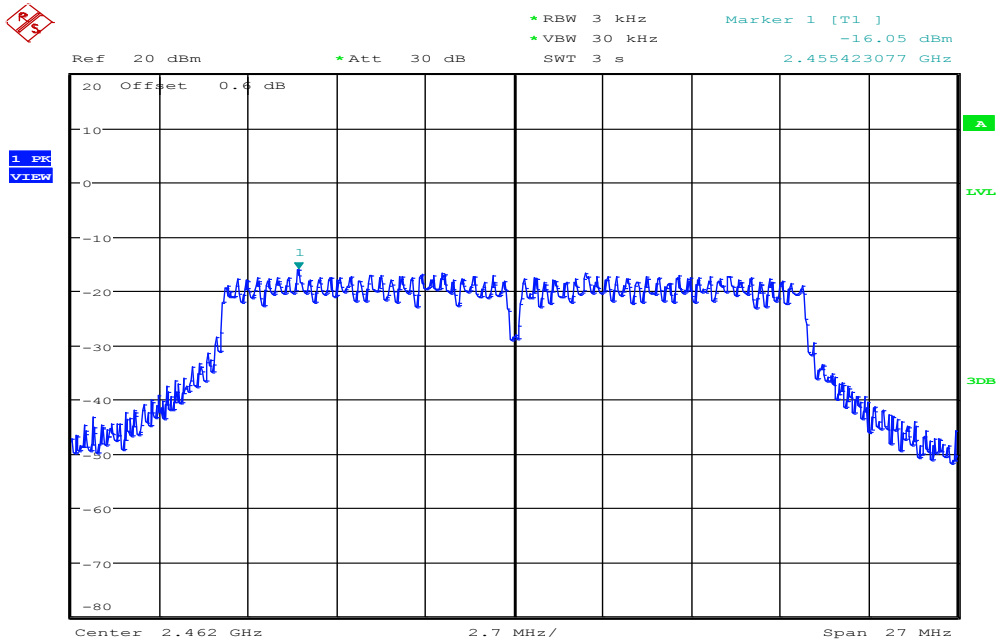

Date: 18.MAR.2016 16:25:10

### IEEE 802.11n HT 40 MHz mode / Chain 0

### PPSD (CH Low)

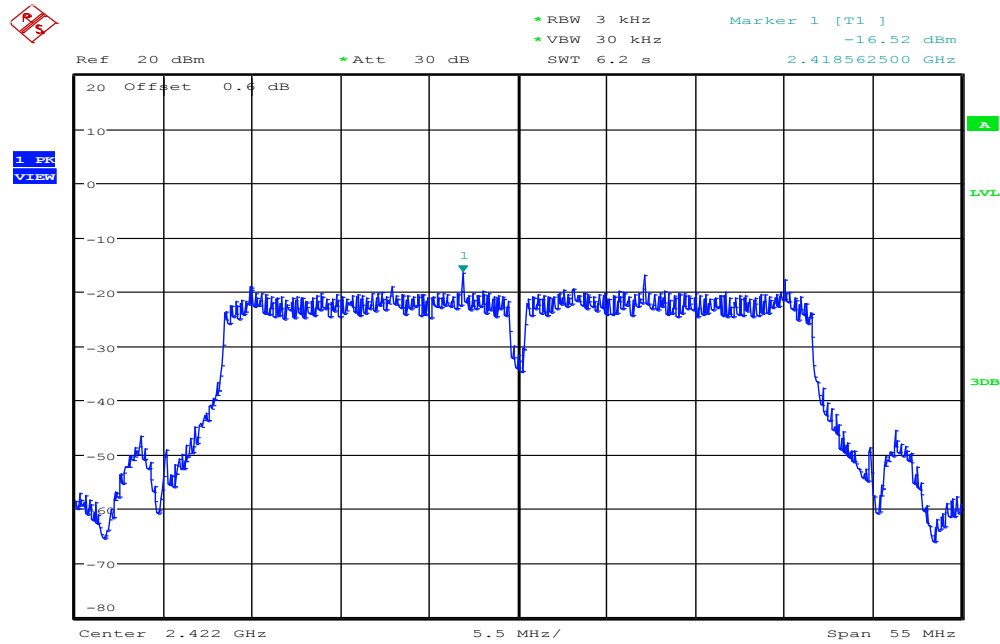

Date: 18.MAR.2016 16:47:06

### PPSD (CH Mid)

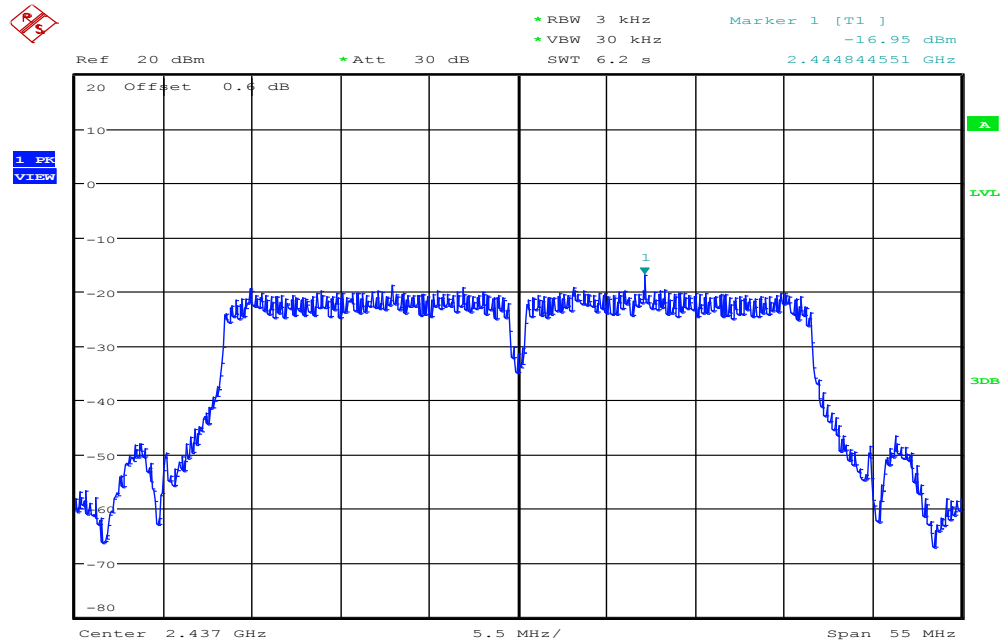

Date: 18.MAR.2016 16:48:34

### PPSD (CH High)

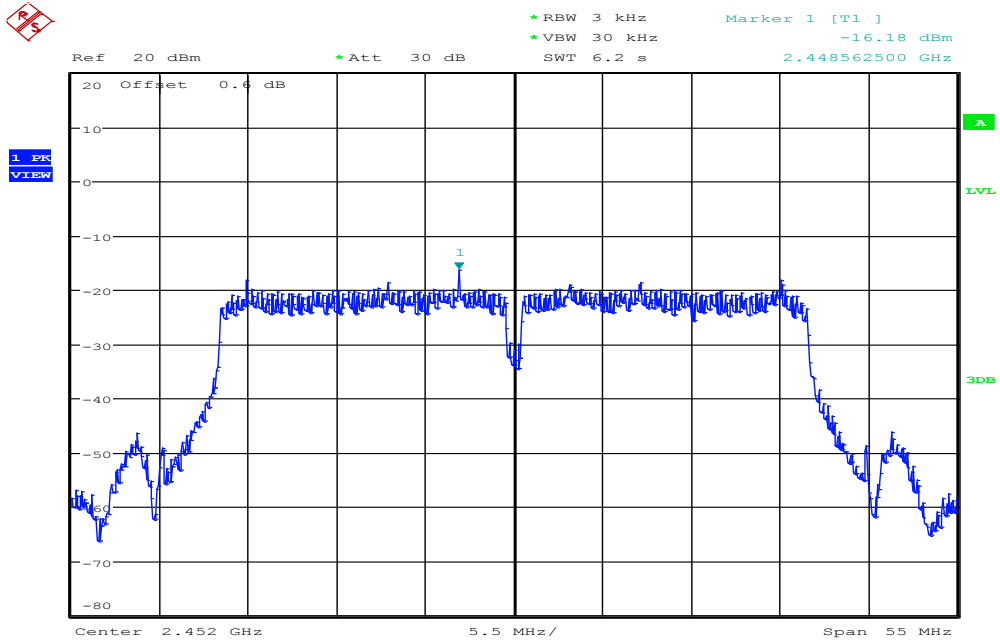

Date: 18.MAR.2016 16:49:30

### IEEE 802.11n HT 40 MHz mode / Chain 1

### PPSD (CH Low)

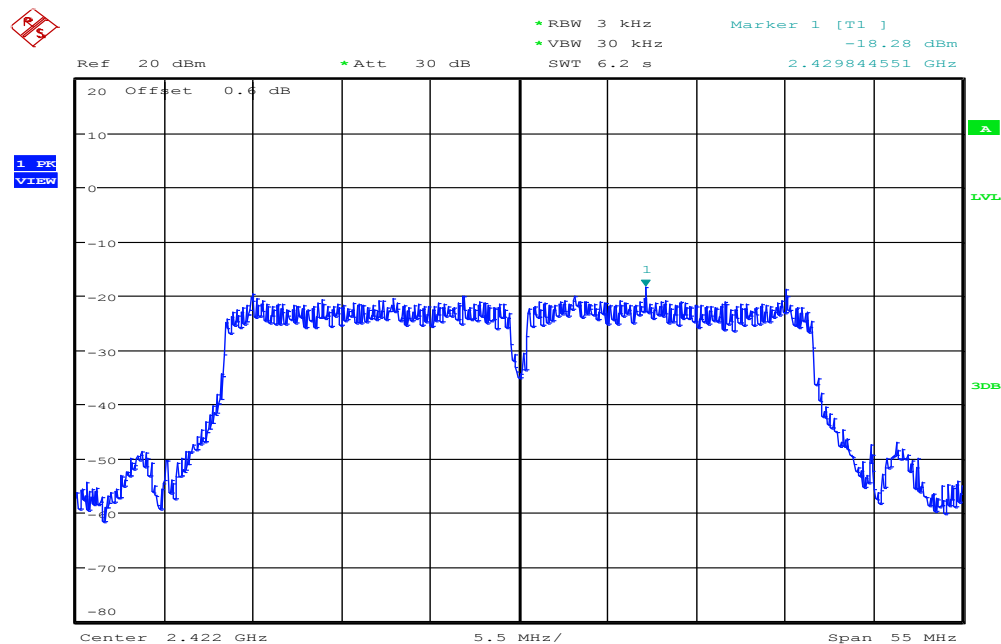

Date: 18.MAR.2016 16:34:42

### PPSD (CH Mid)

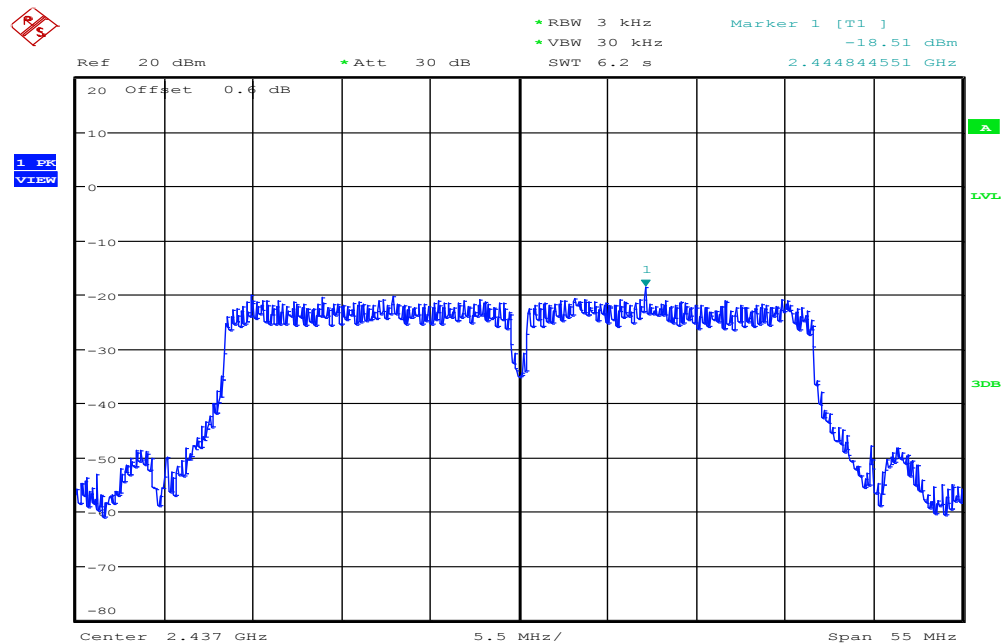

Date: 18.MAR.2016 16:35:35

### PPSD (CH High)

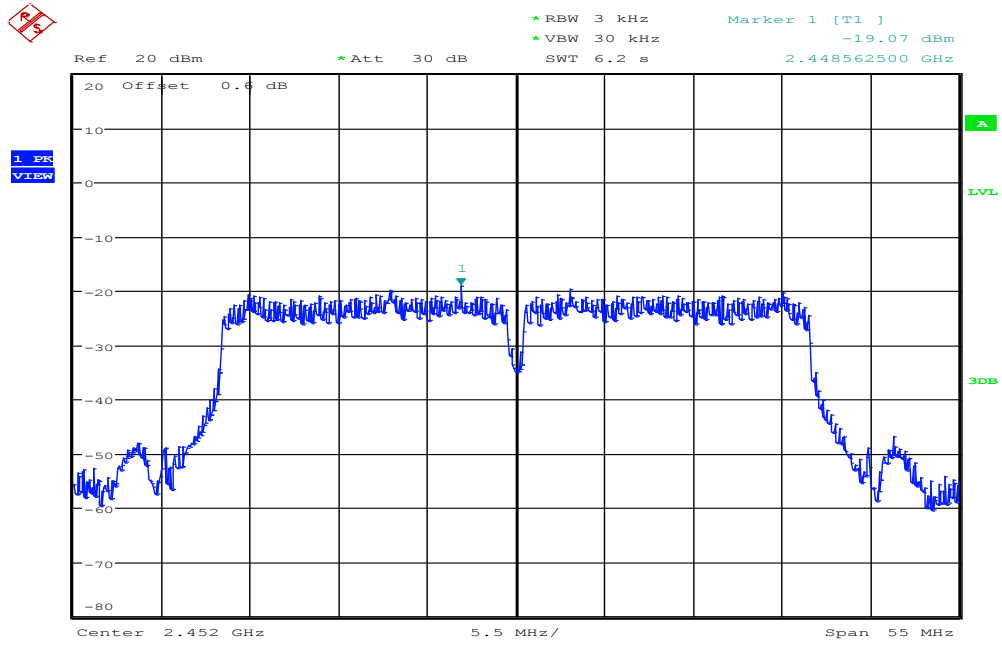

Date: 18.MAR.2016 16:36:38

## 7.7 RADIATED EMISSIONS

### LIMIT

All spurious emissions shall comply with the limits of §15.209(a) and RSS-Gen Table 2 & Table 5.

#### **RSS-Gen Table 2 & Table 5: General Field Strength Limits for Transmitters and Receivers at Frequencies Above 30 MHz** <sup>(Note)</sup>

Frequency (MHz)	Field Strength microvolts/m at 3 metres (watts, e.i.r.p.)	
	Transmitters	Receivers
30-88	100 (3 nW)	100 (3 nW)
88-216	150 (6.8 nW)	150 (6.8 nW)
216-960	200 (12 nW)	200 (12 nW)
Above 960	500 (75 nW)	500 (75 nW)

**Note:** \*Measurements for compliance with limits in the above table may be performed at distances other than 3 metres, in accordance with Section 7.2.7.

Transmitting devices are not permitted in Table 1 bands or, unless stated otherwise, in TV bands (54-72 MHz, 76-88 MHz, 174-216 MHz, 470-608 MHz and 614-806 MHz).

#### **RSS-Gen Table 6: General Field Strength Limits for Transmitters at Frequencies Below 30 MHz (Transmit)**

Frequency	Field Strength (microvolts/m)	Magnetic H-Field (microamperes/m)	Measurement Distance (metres)
9-490 kHz	2,400/F (F in kHz)	2,400/377F (F in kHz)	3000
490-1,705 kHz	24,000/F (F in kHz)	24,000/377F (F in kHz)	30
1.705-30 MHz	30	N/A	30

**Note:** The emission limits for the bands 9-90 kHz and 110-490 kHz are based on measurements employing an average detector.

**Test Configuration**

**9kHz ~ 30MHz**

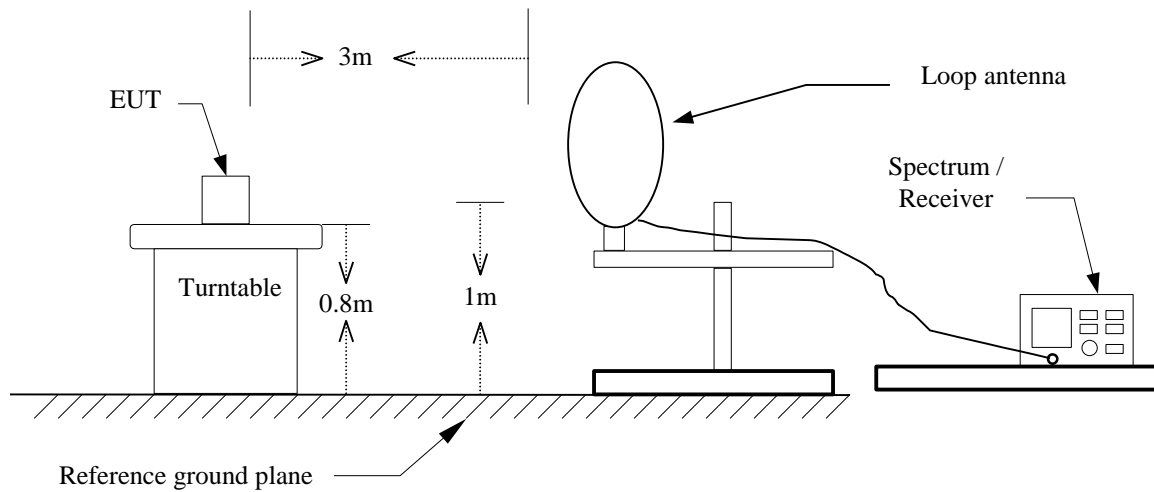

**30MHz ~ 1GHz**

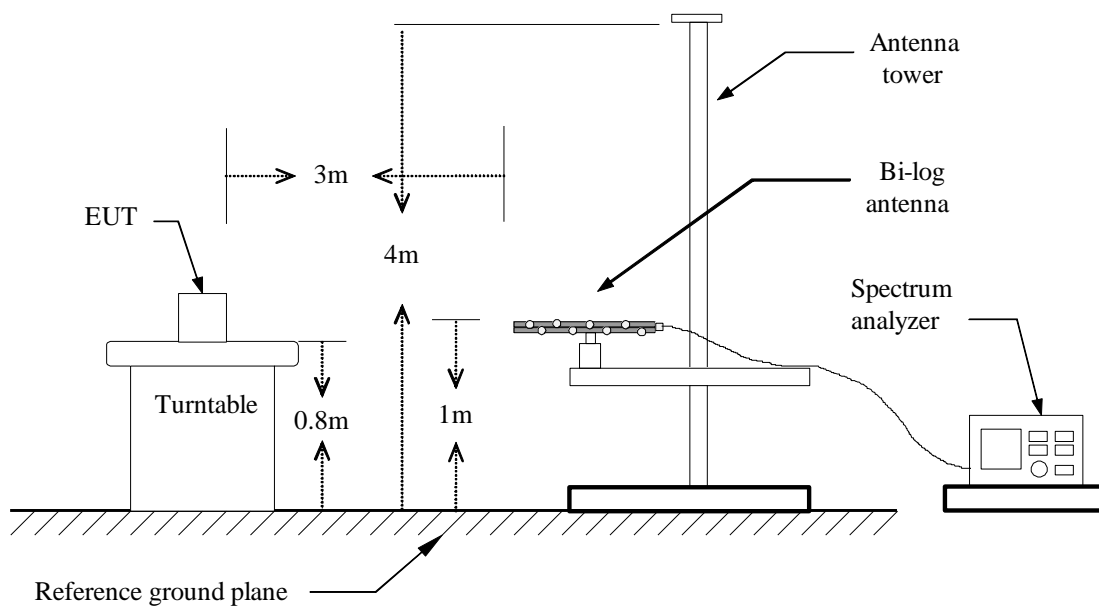

**Above 1 GHz**

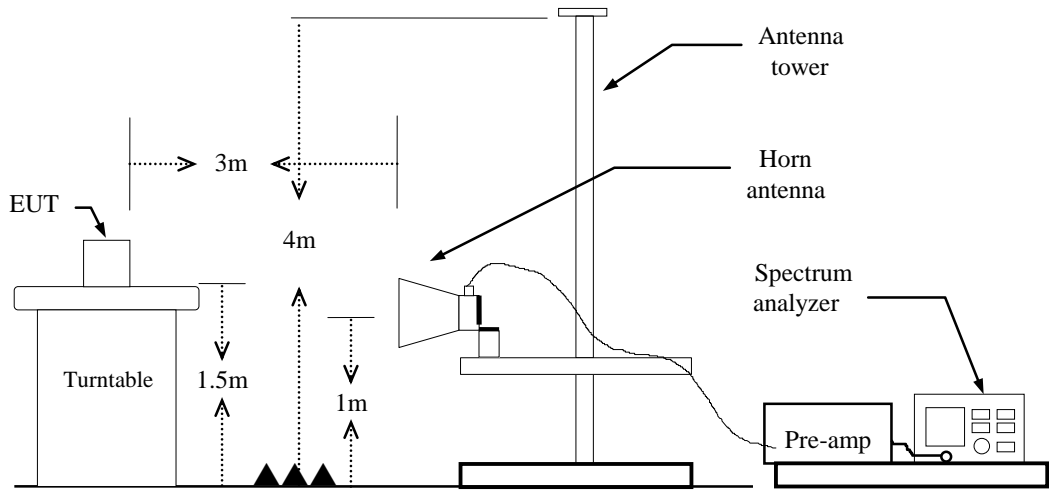



## **TEST PROCEDURE**

1. The EUT is placed on a turntable, Above 1 GHz is 1.5m high and below 1 GHz is 0.8m high above ground plane.
2. The turntable shall be rotated for 360 degrees to determine the position of maximum emission level.
3. EUT is set 3m away from the receiving antenna, which is varied from 1m to 4m to find out the highest emissions.
4. Maximum procedure was performed on the six highest emissions to ensure EUT compliance.
5. And also, each emission was to be maximized by changing the polarization of receiving antenna both horizontal and vertical.
6. Set the spectrum analyzer in the following setting as:

Below 1GHz:

RBW=100kHz / VBW=300kHz / Sweep=AUTO

Above 1GHz:

(a) PEAK: RBW=1MHz / VBW=3MHz / Sweep=AUTO

(b) AVERAGE: RBW=1MHz,

if duty cycle  $\geq 98\%$ , VBW=10Hz.

if duty cycle  $< 98\%$  VBW=1/T.

**IEEE 802.11b mode:**  $\geq 98\%$ , VBW=10Hz

**IEEE 802.11g mode:**  $\geq 98\%$ , VBW=10Hz

**IEEE 802.11n HT 20 MHz mode:**  $\geq 98\%$ , VBW=10Hz

**IEEE 802.11n HT 40 MHz mode:**  $\geq 98\%$ , VBW=10Hz

7. Repeat above procedures until the measurements for all frequencies are complete.
8. Result = Spectrum Reading + cable loss(spectrum to Amp) - Amp Gain + Cable loss(Amp to receive Ant)+ Receive Ant

**Note:** We checked every harmonics frequencies from Fundamental frequencies with reduced VBW, and we mark a point to prove pass or not if we find any emission. For this case, there are no emissions hidden in the noise floor.

**Below 1GHz**

**Operation Mode:** Normal Link

**Test Date:** March 17, 2016

**Temperature:** 27°C

**Tested by:** Jason Lu

**Humidity:** 53% RH

**Polarity:** Ver.

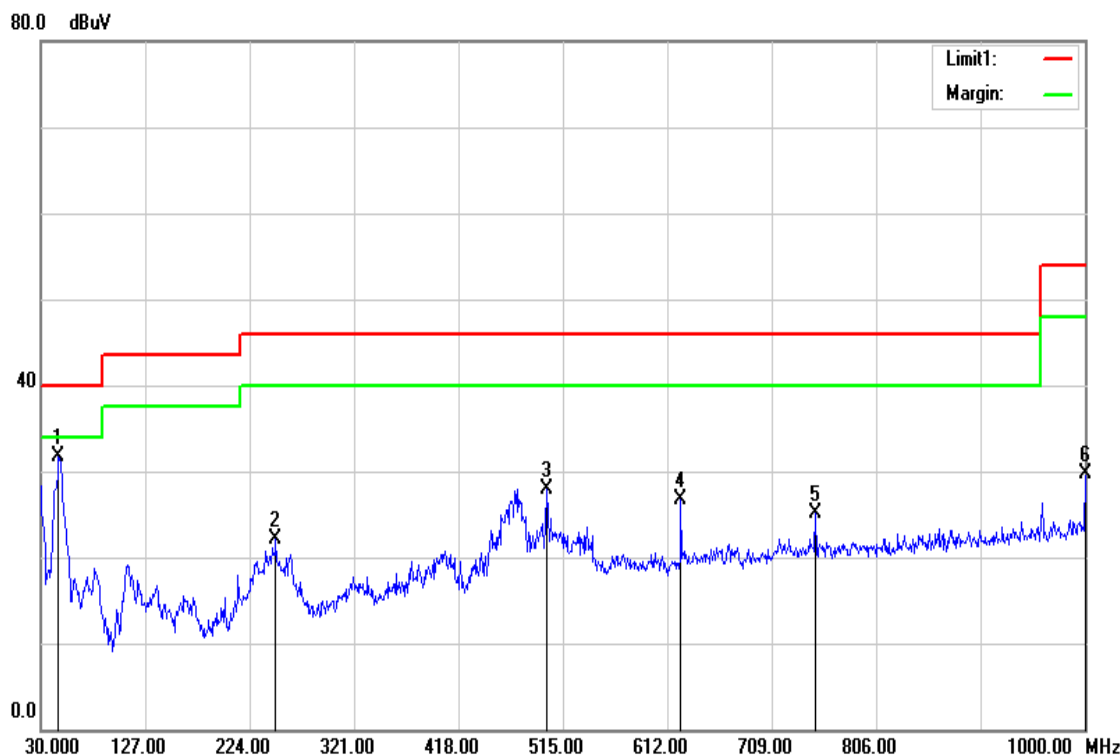

Frequency (MHz)	Reading (dBuV)	Correction Factor (dB/m)	Result (dBuV/m)	Limit (dBuV/m)	Margin (dB)	Remark	Ant. Pol. (H/V)
46.4900	50.69	-19.06	31.63	40.00	-8.37	peak	V
248.2500	38.39	-16.32	22.07	46.00	-23.93	peak	V
500.4500	37.17	-9.23	27.94	46.00	-18.06	peak	V
624.6100	33.92	-7.17	26.75	46.00	-19.25	peak	V
749.7400	29.94	-4.93	25.01	46.00	-20.99	peak	V
1000.0000	31.29	-1.58	29.71	54.00	-24.29	peak	V

**Remark:**

1. Measuring frequencies from 30 MHz to the 1GHz.
2. Radiated emissions measured in frequency range from 30 MHz to 1000MHz were made with an instrument using peak/quasi-peak detector mode.
3. Quasi-peak test would be performed if the peak result were greater than the quasi-peak limit or as required by the applicant.
4. Measurements above show only up to 6 maximum emissions noted, or would be lesser, with " N/A " remark, if no specific emissions from the EUT are recorded (ie: margin>20dB from the applicable limit) and considered that's already beyond the background noise floor.
5. Margin (dB) = Result (dBuV/m) – Limit (dBuV/m).

**Operation Mode:** Normal Link

**Test Date:** March 17, 2016

**Temperature:** 27°C

**Tested by:** Jason Lu

**Humidity:** 53% RH

**Polarity:** Hor.

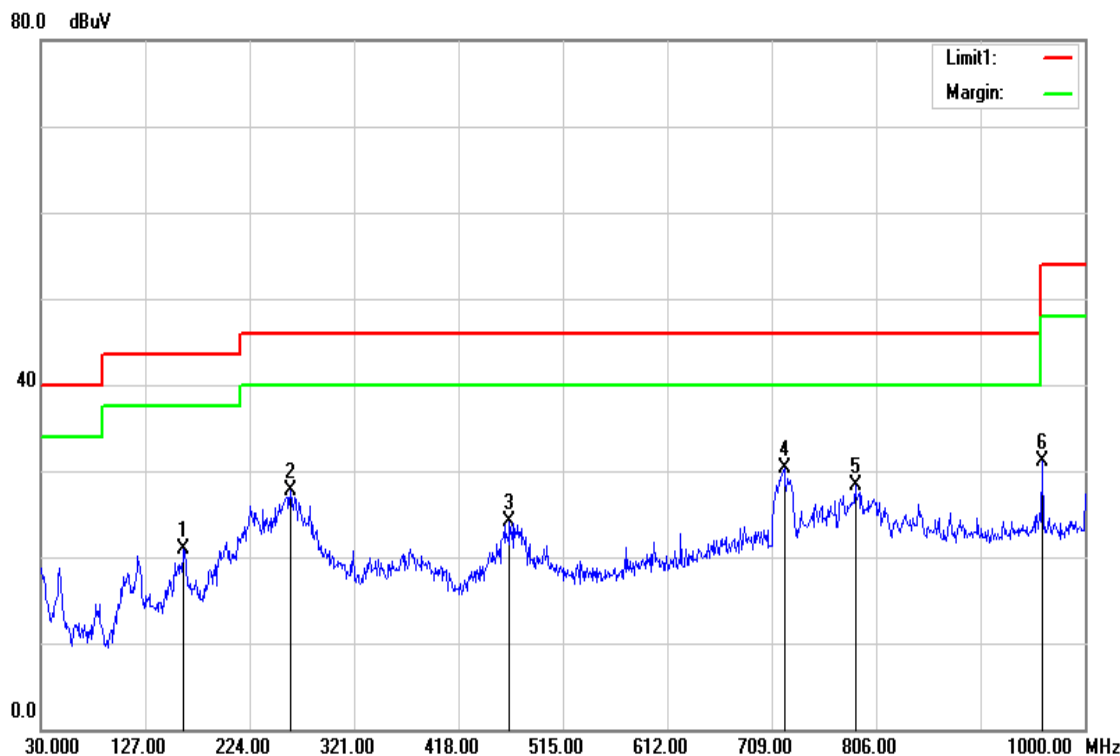

Frequency (MHz)	Reading (dBuV)	Correction Factor (dB/m)	Result (dBuV/m)	Limit (dBuV/m)	Margin (dB)	Remark	Ant. Pol. (H/V)
162.8900	37.33	-16.50	20.83	43.50	-22.67	peak	H
261.8300	43.09	-15.40	27.69	46.00	-18.31	peak	H
465.5300	34.09	-9.89	24.20	46.00	-21.80	peak	H
720.6400	35.85	-5.60	30.25	46.00	-15.75	peak	H
786.6000	32.90	-4.61	28.29	46.00	-17.71	peak	H
960.2300	33.29	-2.23	31.06	54.00	-22.94	peak	H

**Remark:**

1. Measuring frequencies from 30 MHz to the 1GHz.
2. Radiated emissions measured in frequency range from 30 MHz to 1000MHz were made with an instrument using peak/quasi-peak detector mode.
3. Quasi-peak test would be performed if the peak result were greater than the quasi-peak limit or as required by the applicant.
4. Measurements above show only up to 6 maximum emissions noted, or would be lesser, with " N/A " remark, if no specific emissions from the EUT are recorded (ie: margin>20dB from the applicable limit) and considered that's already beyond the background noise floor.
5. Margin (dB) = Result (dBuV/m) – Limit (dBuV/m).

**Above 1 GHz**

**TX / IEEE 802.11b / CH Low**

**Polarity: Vertical**

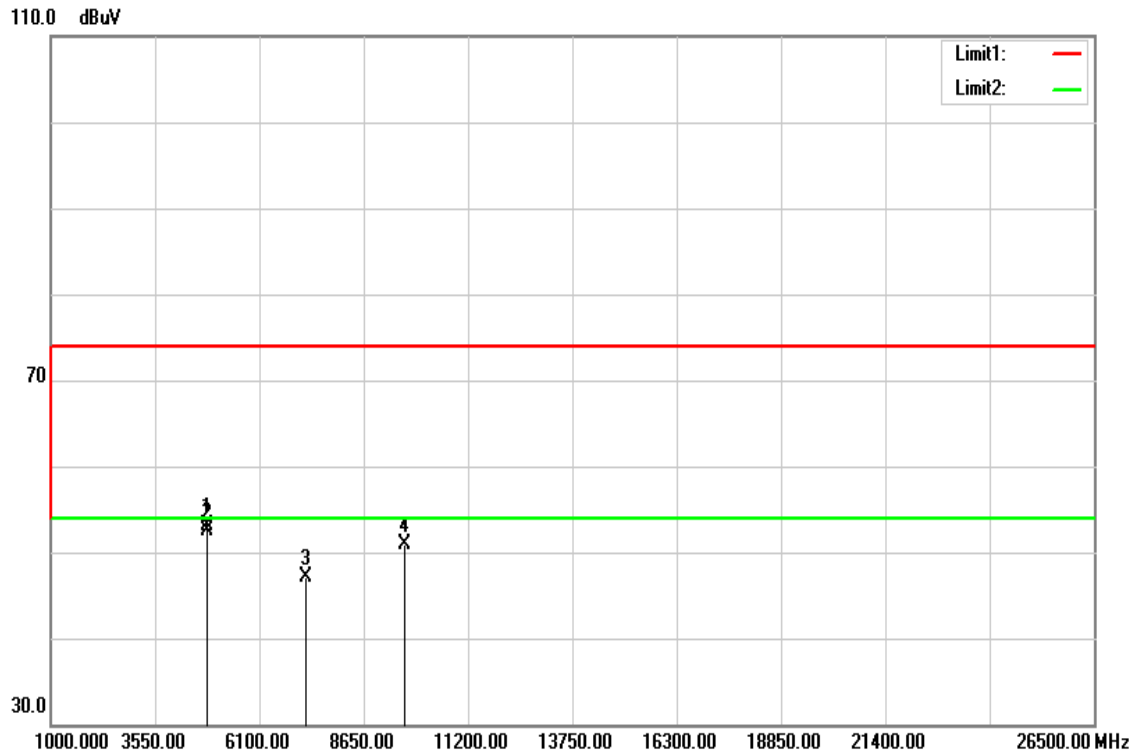

**Polarity: Horizontal**

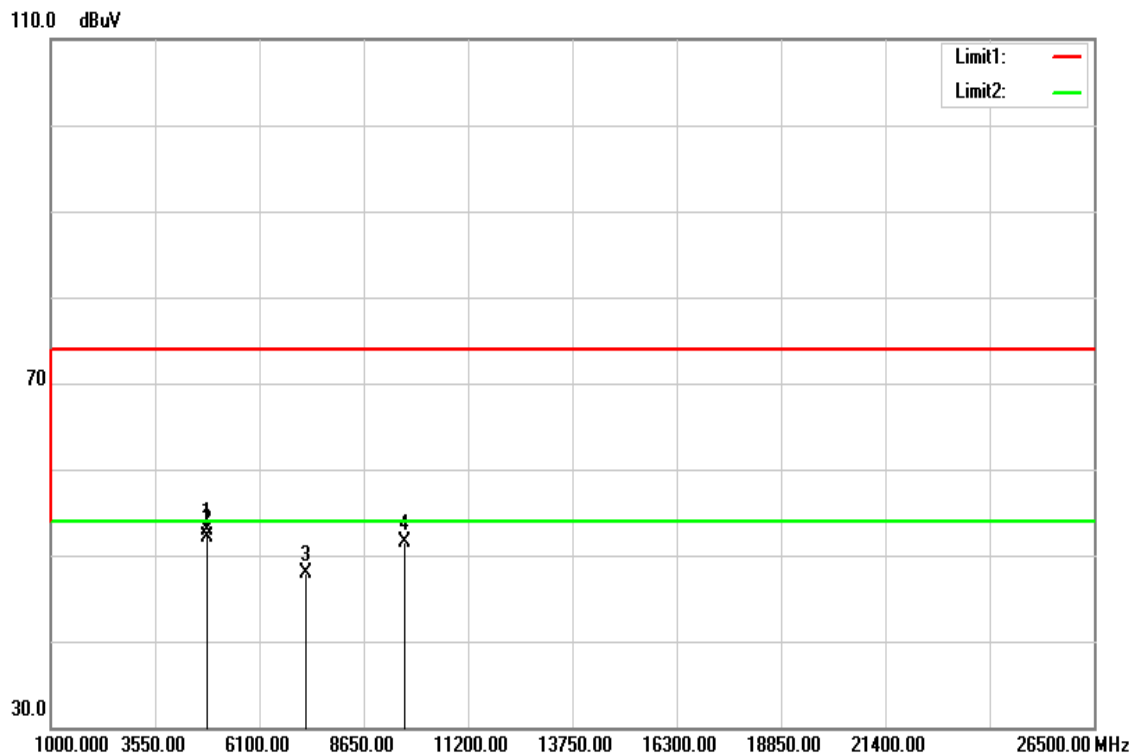

**Above 1 GHz**

**Operation Mode:** TX / IEEE 802.11b / CH Low

**Test Date:** March 18, 2016

**Temperature:** 27°C

**Tested by:** Jason Lu

**Humidity:** 53% RH

**Polarity:** Ver. / Hor.

Frequency (MHz)	Reading (dBuV)	Correction Factor (dB/m)	Result (dBuV/m)	Limit (dBuV/m)	Margin (dB)	Remark	Ant. Pol. (H/V)
4824.000	48.02	5.10	53.12	74.00	-20.88	peak	V
4824.000	47.37	5.10	52.47	54.00	-1.53	AVG	V
7236.000	34.37	12.71	47.08	74.00	-26.92	peak	V
9648.000	33.32	17.60	50.92	74.00	-23.08	peak	V
N/A							
4824.000	47.87	5.10	52.97	74.00	-21.03	peak	H
4824.000	47.08	5.10	52.18	54.00	-1.82	AVG	H
7236.000	35.12	12.71	47.83	74.00	-26.17	peak	H
9648.000	33.92	17.60	51.52	74.00	-22.48	peak	H
N/A							

**Remark:**

1. Measuring frequencies from 1 GHz to the 10th harmonic of highest fundamental frequency.
2. Radiated emissions measured in frequency above 1000MHz were made with an instrument using peak/average detector mode.
3. Average test would be performed if the peak result were greater than the average limit or as required by the applicant.
4. Data of measurement within this frequency range shown " --- " in the table above means the reading of emissions are attenuated more than 20dB below the permissible limits or the field strength is too small to be measured.
5. Measurements above show only up to 6 maximum emissions noted, or would be lesser, with " N/A " remark, if no specific emissions from the EUT are recorded (ie: margin>20dB from the applicable limit) and considered that's already beyond the background noise floor.
6. Margin (dB) = Remark result (dBuV/m) – Average limit (dBuV/m).

**TX / IEEE 802.11b / CH Mid**

**Polarity: Vertical**

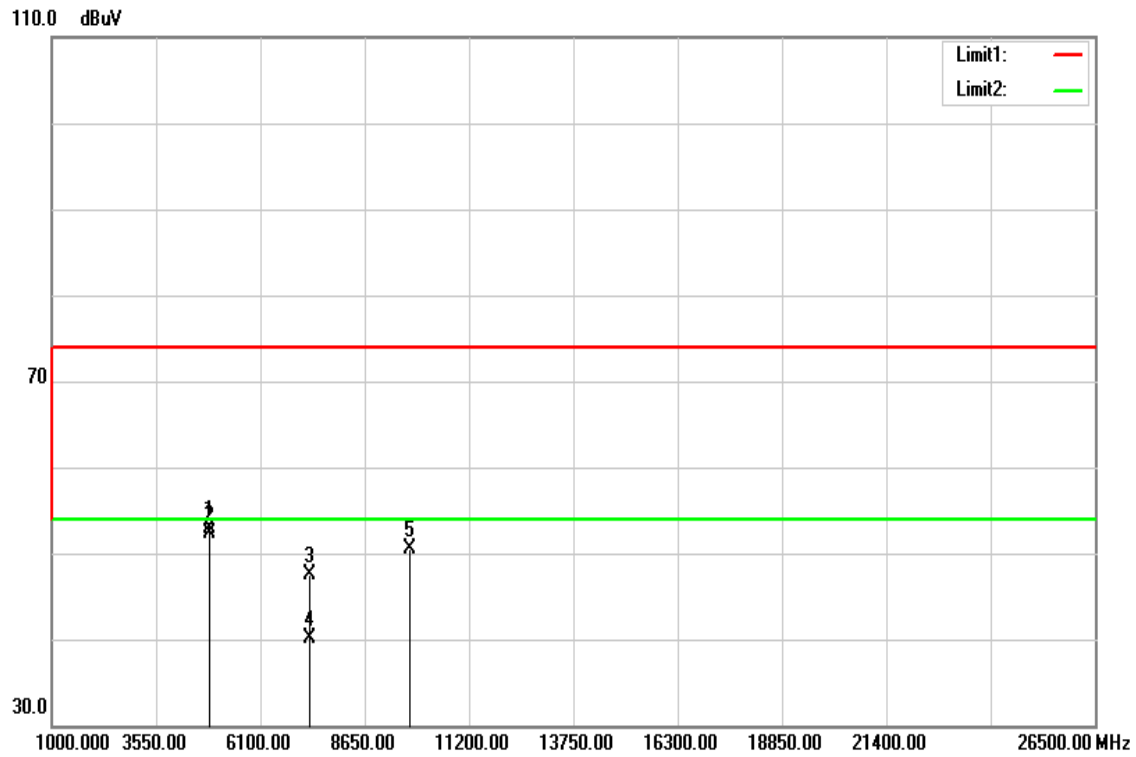

**Polarity: Horizontal**

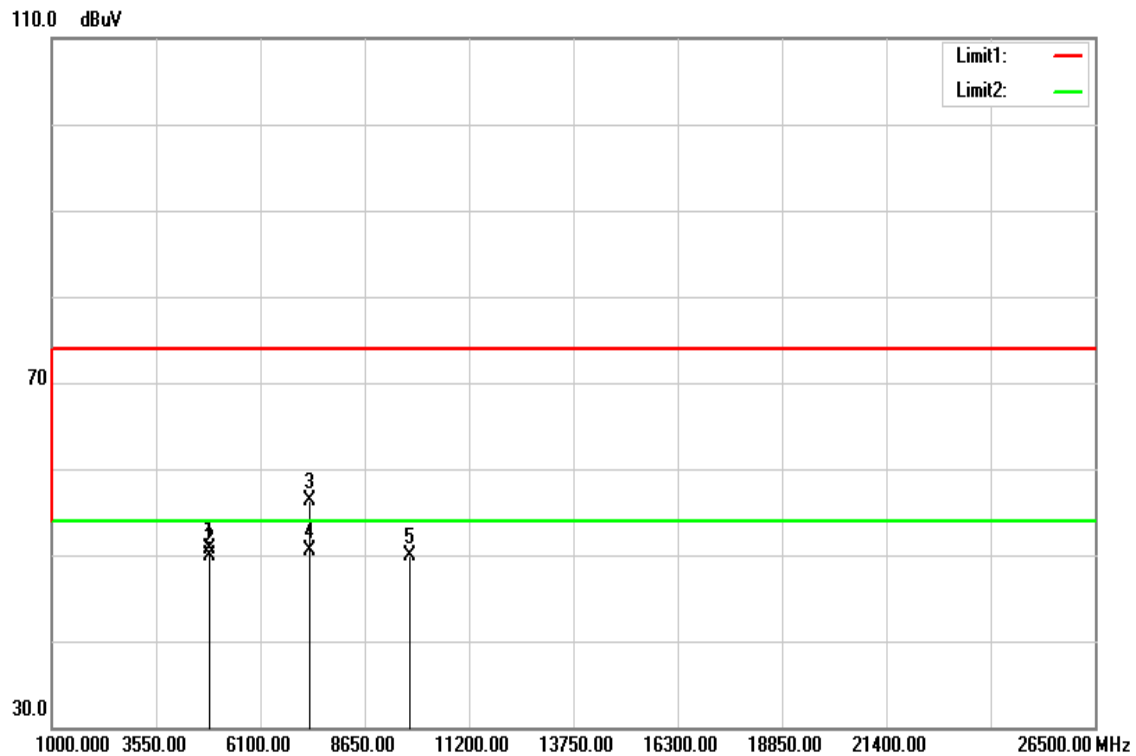

**Operation Mode:** TX / IEEE 802.11b / CH Mid

**Test Date:** March 18, 2016

**Temperature:** 27°C

**Tested by:** Jason Lu

**Humidity:** 53% RH

**Polarity:** Ver. / Hor.

Frequency (MHz)	Reading (dBuV)	Correction Factor (dB/m)	Result (dBuV/m)	Limit (dBuV/m)	Margin (dB)	Remark	Ant. Pol. (H/V)
4874.000	47.66	5.23	52.89	74.00	-21.11	peak	V
4874.000	47.07	5.23	52.30	54.00	-1.70	AVG	V
7311.000	34.53	12.94	47.47	74.00	-26.53	peak	V
7311.000	27.18	12.94	40.12	54.00	-13.88	AVG	V
9748.000	32.81	17.60	50.41	74.00	-23.59	peak	V
N/A							
4874.000	45.44	5.23	50.67	74.00	-23.33	peak	H
4874.000	44.72	5.23	49.95	54.00	-4.05	AVG	H
7311.000	43.40	12.94	56.34	74.00	-17.66	peak	H
7311.000	37.51	12.94	50.45	54.00	-3.55	AVG	H
9748.000	32.22	17.60	49.82	74.00	-24.18	peak	H
N/A							

**Remark:**

1. Measuring frequencies from 1 GHz to the 10th harmonic of highest fundamental frequency.
2. Radiated emissions measured in frequency above 1000MHz were made with an instrument using peak/average detector mode.
3. Average test would be performed if the peak result were greater than the average limit or as required by the applicant.
4. Data of measurement within this frequency range shown " --- " in the table above means the reading of emissions are attenuated more than 20dB below the permissible limits or the field strength is too small to be measured.
5. Measurements above show only up to 6 maximum emissions noted, or would be lesser, with " N/A " remark, if no specific emissions from the EUT are recorded (ie: margin>20dB from the applicable limit) and considered that's already beyond the background noise floor.
6. Margin (dB) = Remark result (dBuV/m) – Average limit (dBuV/m).

**TX / IEEE 802.11b / CH High**

**Polarity: Vertical**

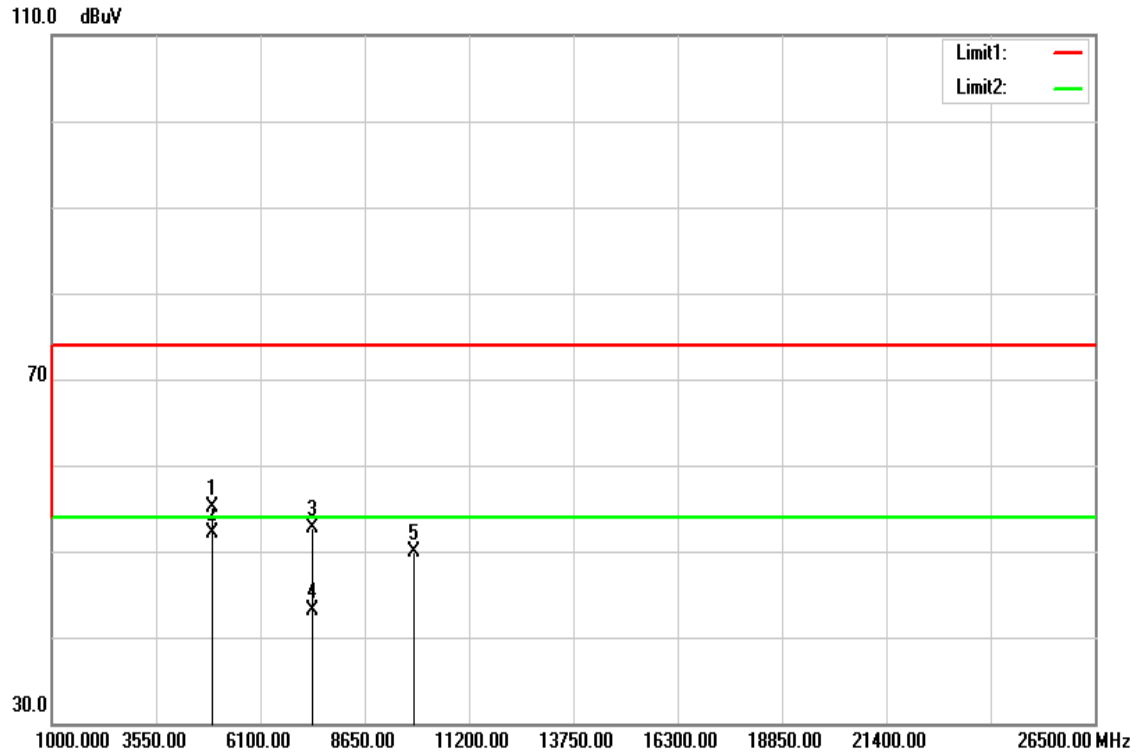

**Polarity: Horizontal**

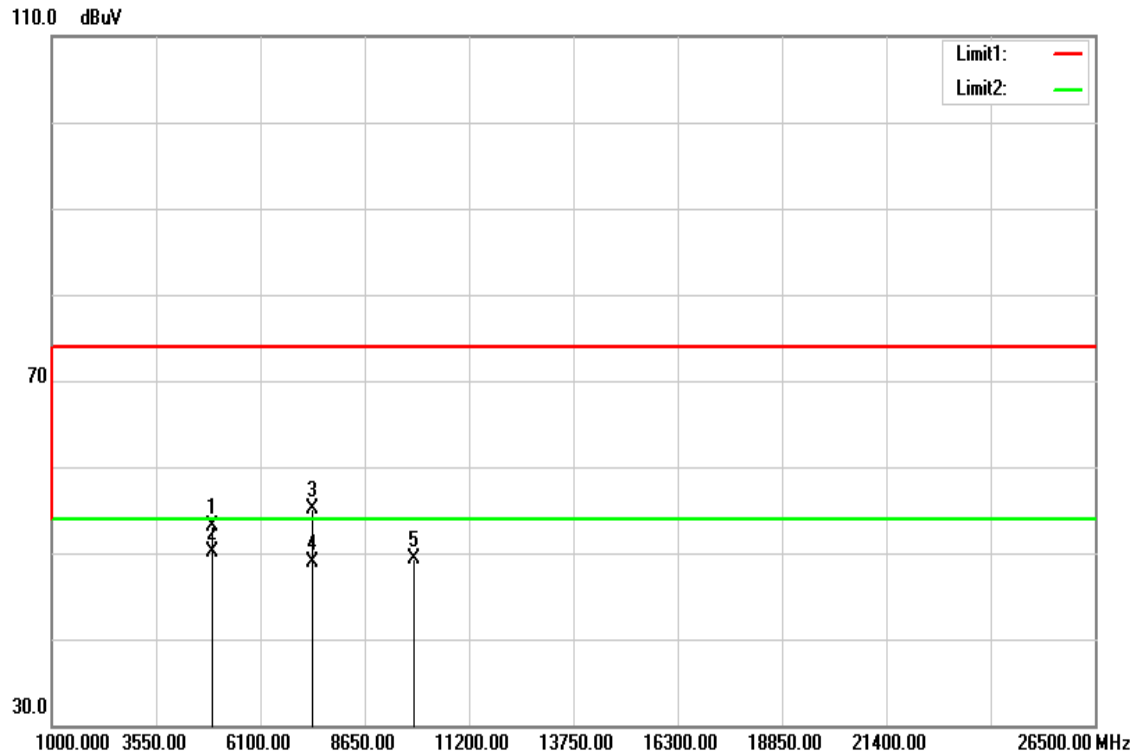



**Operation Mode:** TX / IEEE 802.11b / CH High

**Test Date:** March 18, 2016

**Temperature:** 27°C

**Tested by:** Jason Lu

**Humidity:** 53% RH

**Polarity:** Ver. / Hor.

Frequency (MHz)	Reading (dBuV)	Correction Factor (dB/m)	Result (dBuV/m)	Limit (dBuV/m)	Margin (dB)	Remark	Ant. Pol. (H/V)
4924.000	49.69	5.37	55.06	74.00	-18.94	peak	V
4924.000	46.64	5.37	52.01	54.00	-1.99	AVG	V
7386.000	39.62	13.17	52.79	74.00	-21.21	peak	V
7386.000	30.01	13.17	43.18	54.00	-10.82	AVG	V
9848.000	32.38	17.60	49.98	74.00	-24.02	peak	V
N/A							
4924.000	47.76	5.37	53.13	74.00	-20.87	peak	H
4924.000	44.72	5.37	50.09	54.00	-3.91	AVG	H
7386.000	42.00	13.17	55.17	74.00	-18.83	peak	H
7386.000	35.80	13.17	48.97	54.00	-5.03	AVG	H
9848.000	31.69	17.60	49.29	74.00	-24.71	peak	H
N/A							

**Remark:**

1. Measuring frequencies from 1 GHz to the 10th harmonic of highest fundamental frequency.
2. Radiated emissions measured in frequency above 1000MHz were made with an instrument using peak/average detector mode.
3. Average test would be performed if the peak result were greater than the average limit or as required by the applicant.
4. Data of measurement within this frequency range shown " --- " in the table above means the reading of emissions are attenuated more than 20dB below the permissible limits or the field strength is too small to be measured.
5. Measurements above show only up to 6 maximum emissions noted, or would be lesser, with " N/A " remark, if no specific emissions from the EUT are recorded (ie: margin>20dB from the applicable limit) and considered that's already beyond the background noise floor.
6. Margin (dB) = Remark result (dBuV/m) – Average limit (dBuV/m).

**TX / IEEE 802.11g / CH Low**

**Polarity: Vertical**

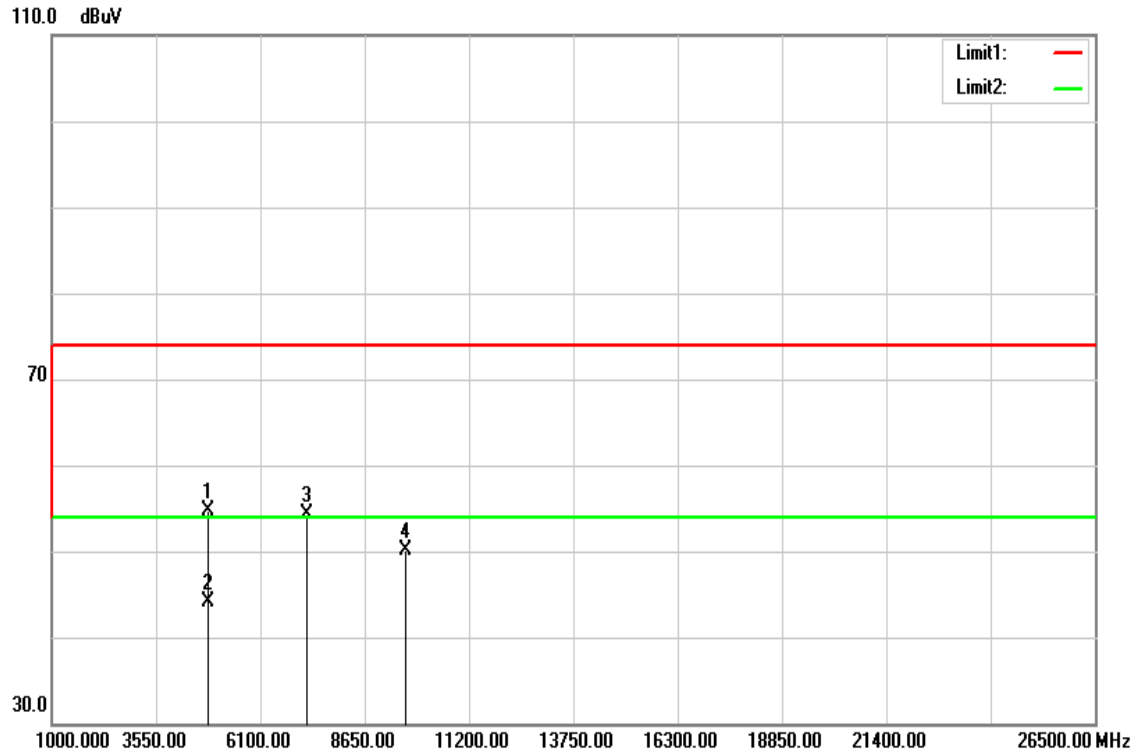

**Polarity: Horizontal**

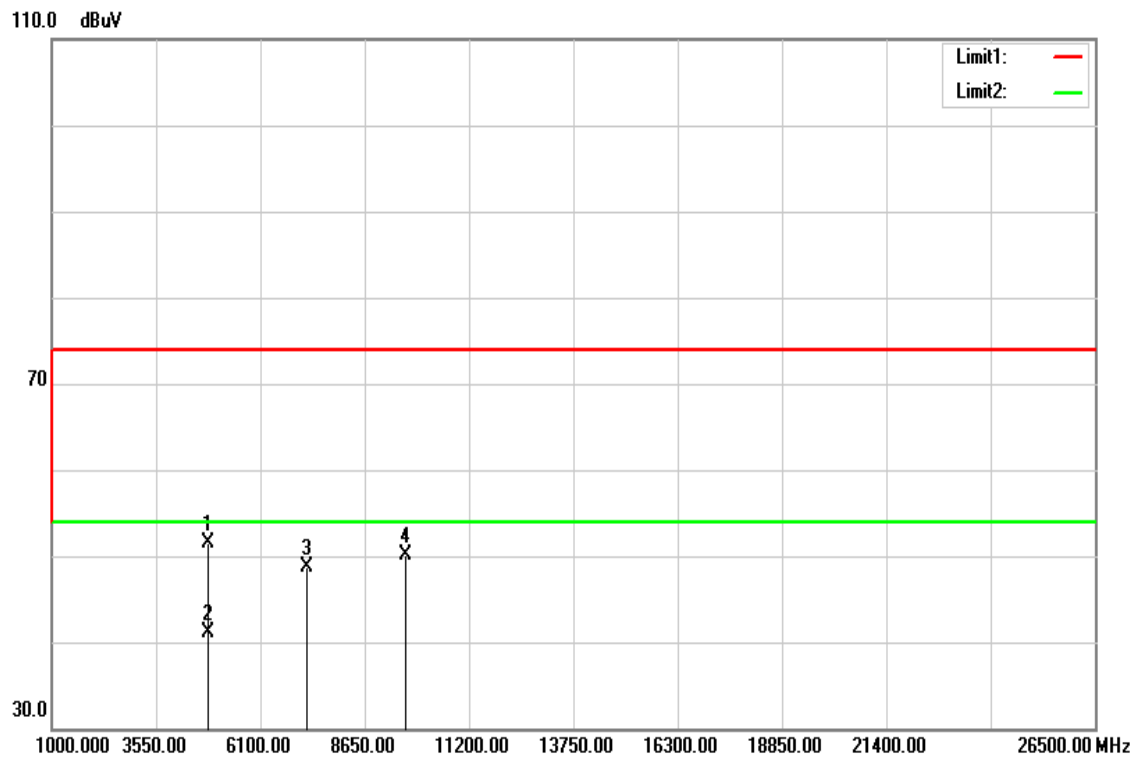

**Operation Mode:** TX / IEEE 802.11g / CH Low

**Test Date:** March 18, 2016

**Temperature:** 27°C

**Tested by:** Jason Lu

**Humidity:** 53% RH

**Polarity:** Ver. / Hor.

Frequency (MHz)	Reading (dBuV)	Correction Factor (dB/m)	Result (dBuV/m)	Limit (dBuV/m)	Margin (dB)	Remark	Ant. Pol. (H/V)
4824.000	49.56	5.10	54.66	74.00	-19.34	peak	V
4824.000	39.03	5.10	44.13	54.00	-9.87	AVG	V
7236.000	41.49	12.71	54.20	74.00	-19.80	peak	V
9648.000	32.50	17.60	50.10	74.00	-23.90	peak	V
N/A							
4824.000	46.48	5.10	51.58	74.00	-22.42	peak	H
4824.000	36.02	5.10	41.12	54.00	-12.88	AVG	H
7236.000	35.93	12.71	48.64	74.00	-25.36	peak	H
9648.000	32.56	17.60	50.16	74.00	-23.84	peak	H
N/A							

**Remark:**

1. Measuring frequencies from 1 GHz to the 10th harmonic of highest fundamental frequency.
2. Radiated emissions measured in frequency above 1000MHz were made with an instrument using peak/average detector mode.
3. Average test would be performed if the peak result were greater than the average limit or as required by the applicant.
4. Data of measurement within this frequency range shown " --- " in the table above means the reading of emissions are attenuated more than 20dB below the permissible limits or the field strength is too small to be measured.
5. Measurements above show only up to 6 maximum emissions noted, or would be lesser, with " N/A " remark, if no specific emissions from the EUT are recorded (ie: margin>20dB from the applicable limit) and considered that's already beyond the background noise floor.
6. Margin (dB) = Remark result (dBuV/m) – Average limit (dBuV/m).

**TX / IEEE 802.11g / CH Mid**

**Polarity: Vertical**

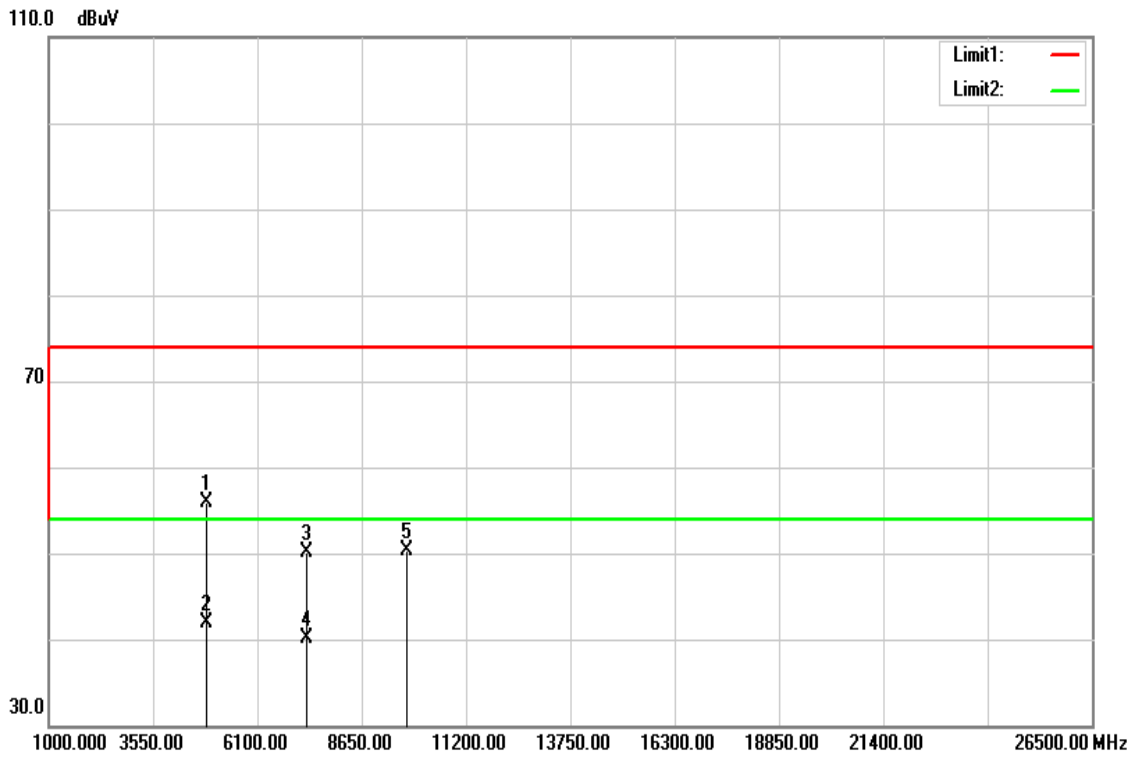

**Polarity: Horizontal**

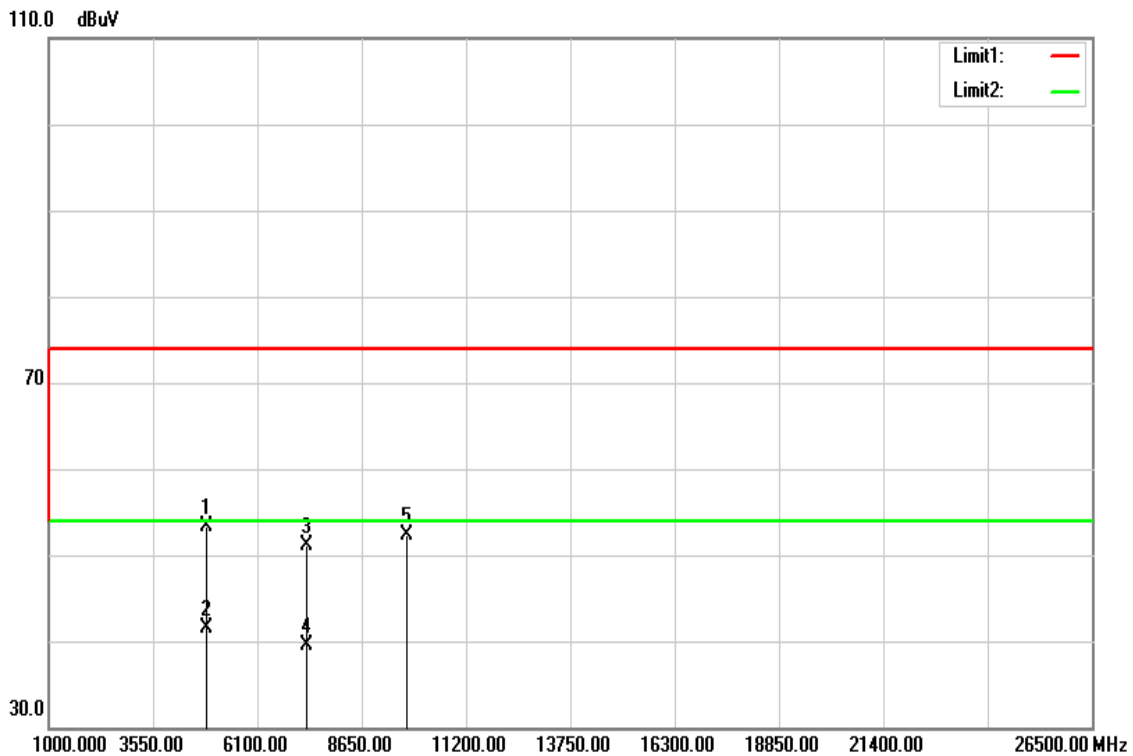

**Operation Mode:** TX / IEEE 802.11g / CH Mid

**Test Date:** March 18, 2016

**Temperature:** 27°C

**Tested by:** Jason Lu

**Humidity:** 53% RH

**Polarity:** Ver. / Hor.

Frequency (MHz)	Reading (dBuV)	Correction Factor (dB/m)	Result (dBuV/m)	Limit (dBuV/m)	Margin (dB)	Remark	Ant. Pol. (H/V)
4874.000	50.67	5.23	55.90	74.00	-18.10	peak	V
4874.000	36.72	5.23	41.95	54.00	-12.05	AVG	V
7311.000	37.23	12.94	50.17	74.00	-23.83	peak	V
7311.000	27.17	12.94	40.11	54.00	-13.89	AVG	V
9748.000	32.77	17.60	50.37	74.00	-23.63	peak	V
N/A							
4874.000	47.98	5.23	53.21	74.00	-20.79	peak	H
4874.000	36.33	5.23	41.56	54.00	-12.44	AVG	H
7311.000	38.22	12.94	51.16	74.00	-22.84	peak	H
7311.000	26.51	12.94	39.45	54.00	-14.55	AVG	H
9748.000	34.80	17.60	52.40	74.00	-21.60	peak	H
N/A							

**Remark:**

1. Measuring frequencies from 1 GHz to the 10th harmonic of highest fundamental frequency.
2. Radiated emissions measured in frequency above 1000MHz were made with an instrument using peak/average detector mode.
3. Average test would be performed if the peak result were greater than the average limit or as required by the applicant.
4. Data of measurement within this frequency range shown " --- " in the table above means the reading of emissions are attenuated more than 20dB below the permissible limits or the field strength is too small to be measured.
5. Measurements above show only up to 6 maximum emissions noted, or would be lesser, with " N/A " remark, if no specific emissions from the EUT are recorded (ie: margin>20dB from the applicable limit) and considered that's already beyond the background noise floor.
6. Margin (dB) = Remark result (dBuV/m) – Average limit (dBuV/m).

**TX / IEEE 802.11g / CH High**

**Polarity: Vertical**

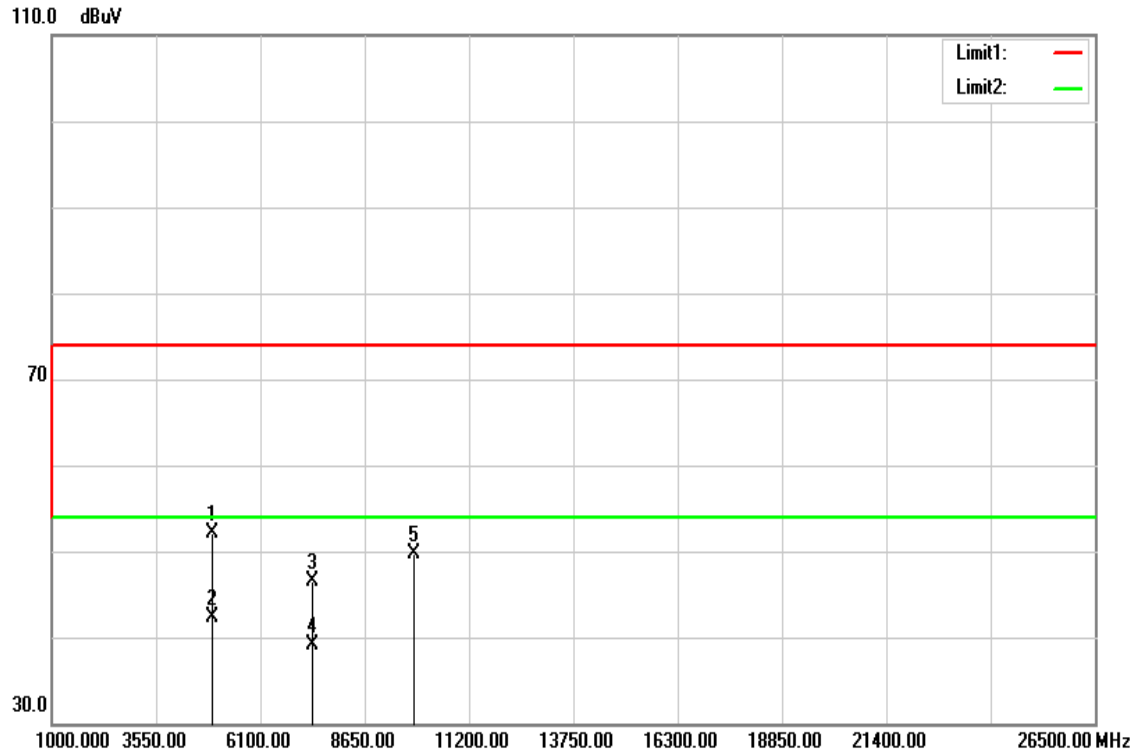

**Polarity: Horizontal**

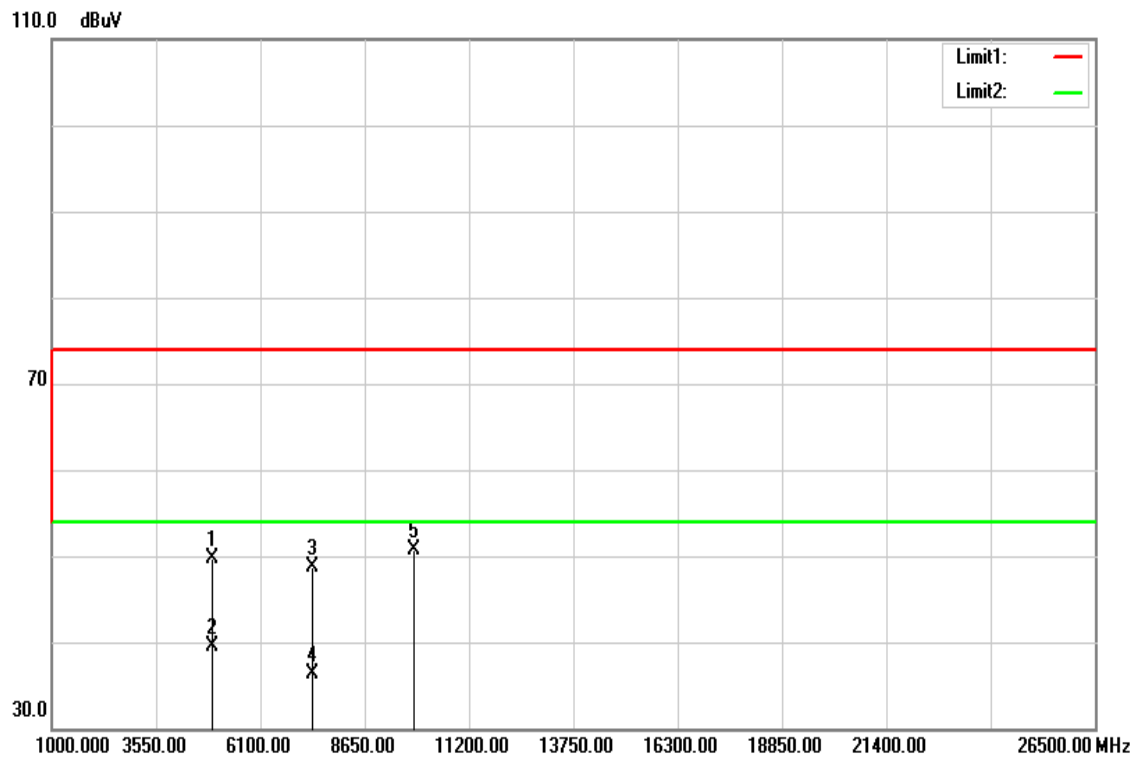

**Operation Mode:** TX / IEEE 802.11g / CH High

**Test Date:** March 18, 2016

**Temperature:** 27°C

**Tested by:** Jason Lu

**Humidity:** 53% RH

**Polarity:** Ver. / Hor.

Frequency (MHz)	Reading (dBuV)	Correction Factor (dB/m)	Result (dBuV/m)	Limit (dBuV/m)	Margin (dB)	Remark	Ant. Pol. (H/V)
4924.000	46.65	5.37	52.02	74.00	-21.98	peak	V
4924.000	36.96	5.37	42.33	54.00	-11.67	AVG	V
7386.000	33.43	13.17	46.60	74.00	-27.40	peak	V
7386.000	25.94	13.17	39.11	54.00	-14.89	AVG	V
9848.000	32.06	17.60	49.66	74.00	-24.34	peak	V
N/A							
4924.000	44.26	5.37	49.63	74.00	-24.37	peak	H
4924.000	34.18	5.37	39.55	54.00	-14.45	AVG	H
7386.000	35.51	13.17	48.68	74.00	-25.32	peak	H
7386.000	23.15	13.17	36.32	54.00	-17.68	AVG	H
9848.000	33.14	17.60	50.74	74.00	-23.26	peak	H
N/A							

**Remark:**

1. *Measuring frequencies from 1 GHz to the 10th harmonic of highest fundamental frequency.*
2. *Radiated emissions measured in frequency above 1000MHz were made with an instrument using peak/average detector mode.*
3. *Average test would be performed if the peak result were greater than the average limit or as required by the applicant.*
4. *Data of measurement within this frequency range shown " --- " in the table above means the reading of emissions are attenuated more than 20dB below the permissible limits or the field strength is too small to be measured.*
5. *Measurements above show only up to 6 maximum emissions noted, or would be lesser, with " N/A " remark, if no specific emissions from the EUT are recorded (ie: margin>20dB from the applicable limit) and considered that's already beyond the background noise floor.*
6. *Margin (dB) = Remark result (dBuV/m) – Average limit (dBuV/m).*

**TX / IEEE 802.11n HT 20 MHz mode / CH Low**

**Polarity: Vertical**

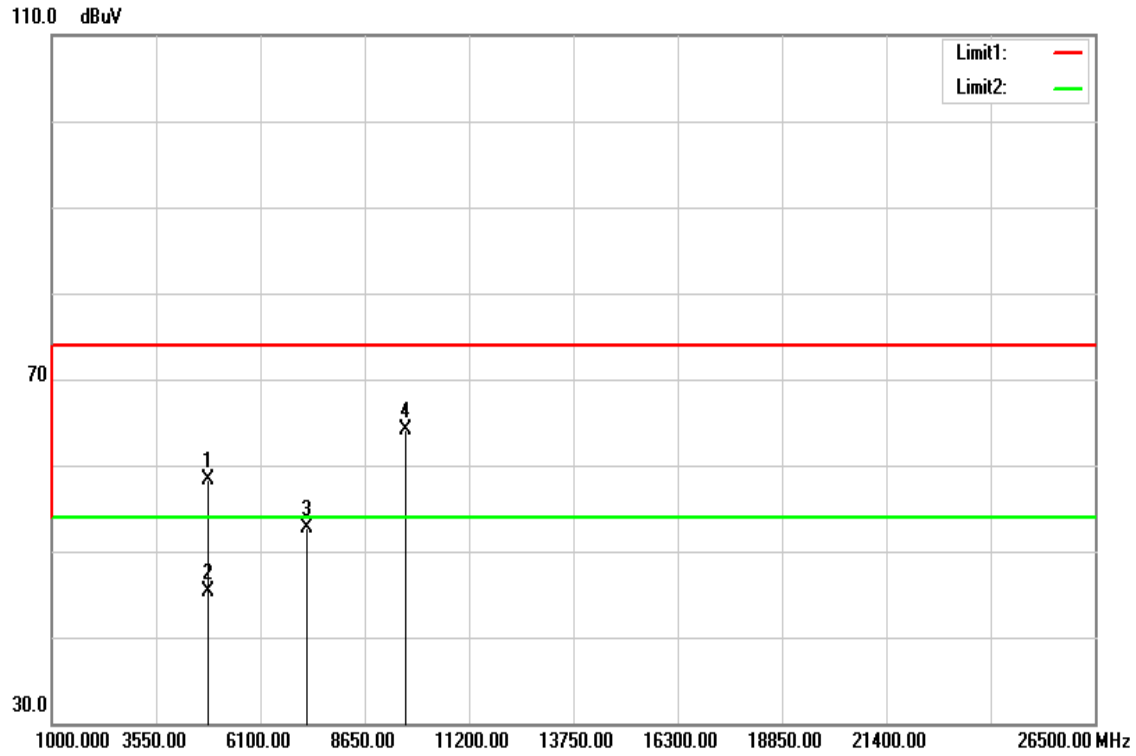

**Polarity: Horizontal**

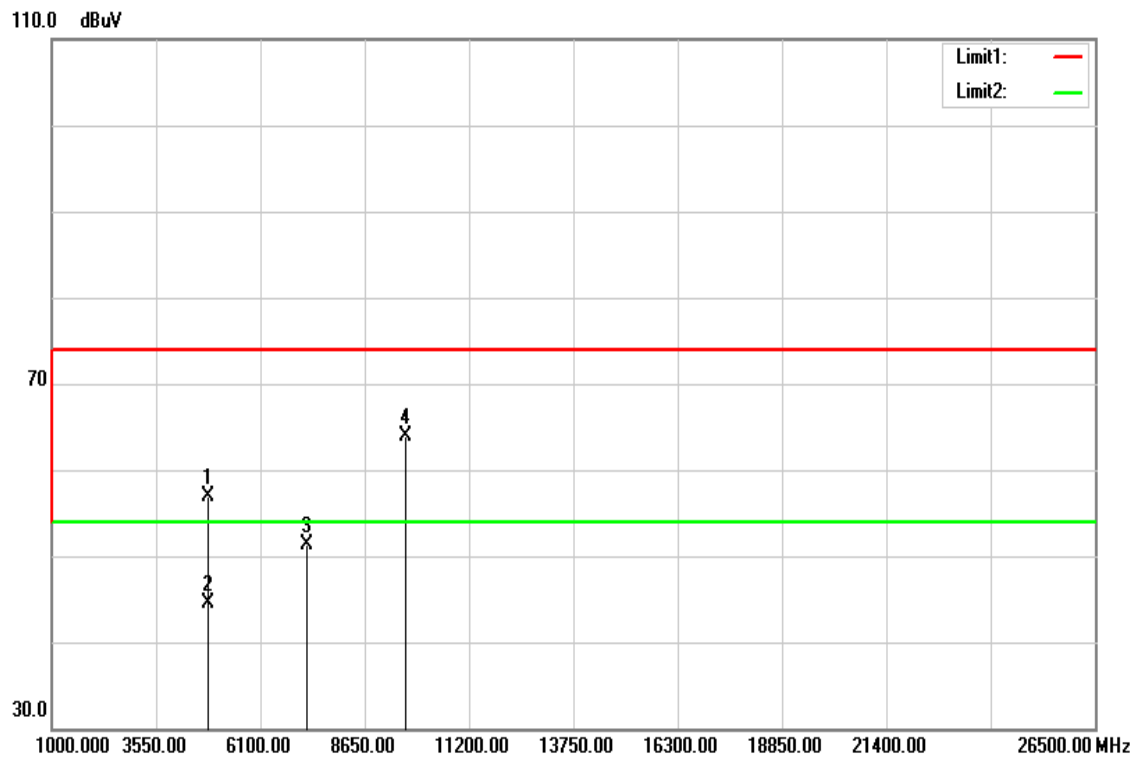



**Operation Mode:** TX / IEEE 802.11n HT 20 MHz mode / CH Low **Test Date:** March 18, 2016

**Temperature:** 27°C

**Tested by:** Jason Lu

**Humidity:** 53% RH

**Polarity:** Ver. / Hor.

Frequency (MHz)	Reading (dBuV)	Correction Factor (dB/m)	Result (dBuV/m)	Limit (dBuV/m)	Margin (dB)	Remark	Ant. Pol. (H/V)
4824.000	53.23	5.10	58.33	74.00	-15.67	peak	V
4824.000	40.11	5.10	45.21	54.00	-8.79	AVG	V
7236.000	39.98	12.71	52.69	74.00	-21.31	peak	V
9648.000	46.59	17.60	64.19	74.00	-9.81	peak	V
N/A							
4824.000	51.78	5.10	56.88	74.00	-17.12	peak	H
4824.000	39.47	5.10	44.57	54.00	-9.43	AVG	H
7236.000	38.55	12.71	51.26	74.00	-22.74	peak	H
9648.000	46.36	17.60	63.96	74.00	-10.04	peak	H
N/A							

**Remark:**

1. Measuring frequencies from 1 GHz to the 10th harmonic of highest fundamental frequency.
2. Radiated emissions measured in frequency above 1000MHz were made with an instrument using peak/average detector mode.
3. Average test would be performed if the peak result were greater than the average limit or as required by the applicant.
4. Data of measurement within this frequency range shown " --- " in the table above means the reading of emissions are attenuated more than 20dB below the permissible limits or the field strength is too small to be measured.
5. Measurements above show only up to 6 maximum emissions noted, or would be lesser, with " N/A " remark, if no specific emissions from the EUT are recorded (ie: margin>20dB from the applicable limit) and considered that's already beyond the background noise floor.
6. Margin (dB) = Remark result (dBuV/m) – Average limit (dBuV/m).

**TX / IEEE 802.11n HT 20 MHz mode / CH Mid**

**Polarity: Vertical**

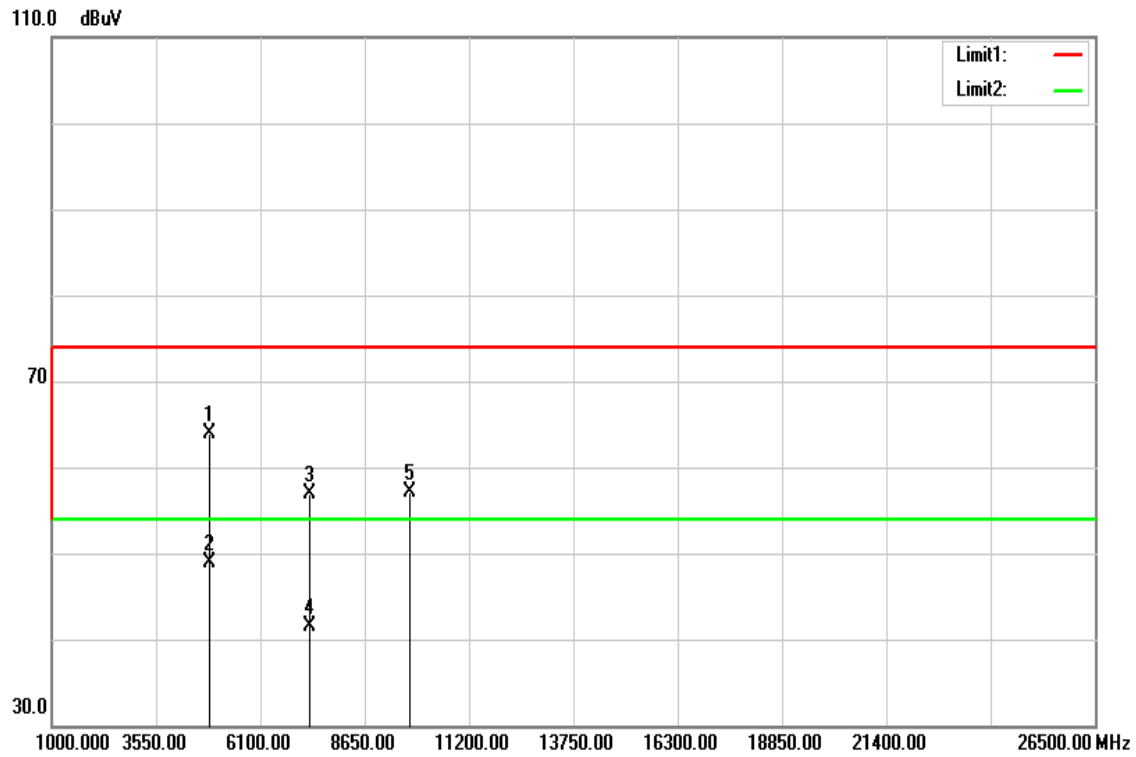

**Polarity: Horizontal**

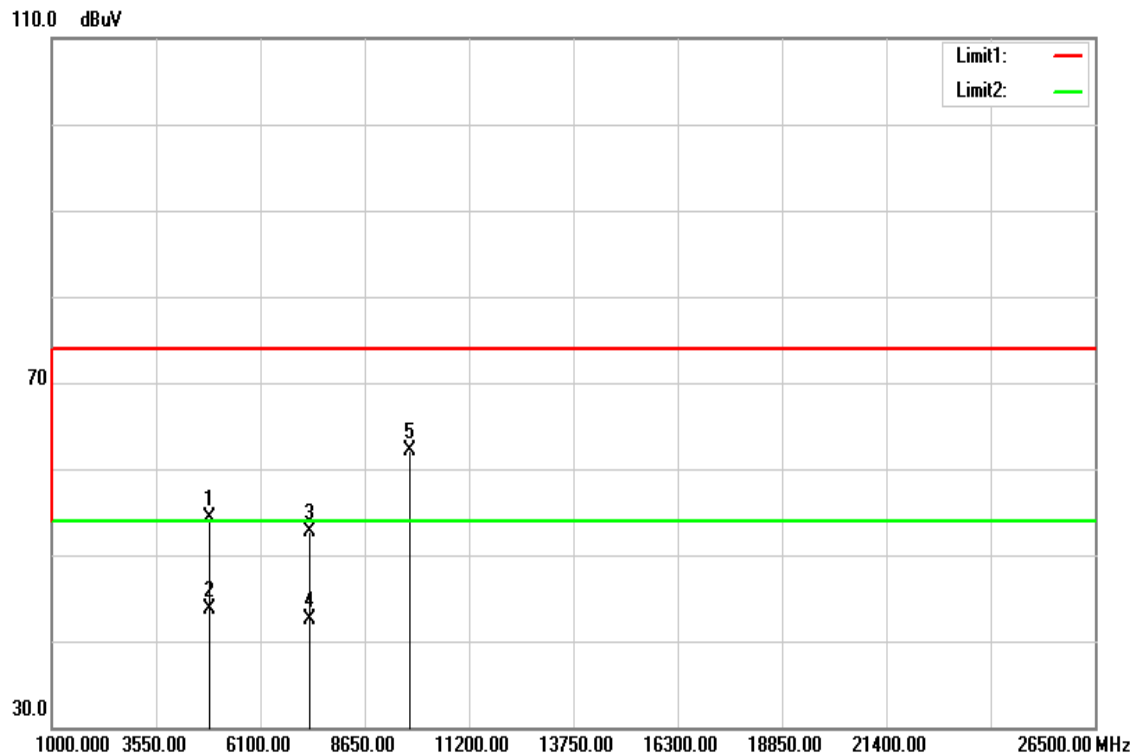

**Operation Mode:** TX / IEEE 802.11n HT 20 MHz mode / CH Mid**Test Date:** March 18, 2016

**Temperature:** 27°C

**Tested by:** Jason Lu

**Humidity:** 53% RH

**Polarity:** Ver. / Hor.

Frequency (MHz)	Reading (dBuV)	Correction Factor (dB/m)	Result (dBuV/m)	Limit (dBuV/m)	Margin (dB)	Remark	Ant. Pol. (H/V)
4874.000	58.65	5.23	63.88	74.00	-10.12	peak	V
4874.000	43.73	5.23	48.96	54.00	-5.04	AVG	V
7311.000	43.87	12.94	56.81	74.00	-17.19	peak	V
7311.000	28.49	12.94	41.43	54.00	-12.57	AVG	V
9748.000	39.58	17.60	57.18	74.00	-16.82	peak	V
N/A							
4874.000	49.02	5.23	54.25	74.00	-19.75	peak	H
4874.000	38.47	5.23	43.70	54.00	-10.30	AVG	H
7311.000	39.86	12.94	52.80	74.00	-21.20	peak	H
7311.000	29.52	12.94	42.46	54.00	-11.54	AVG	H
9748.000	44.54	17.60	62.14	74.00	-11.86	peak	H
N/A							

**Remark:**

1. Measuring frequencies from 1 GHz to the 10th harmonic of highest fundamental frequency.
2. Radiated emissions measured in frequency above 1000MHz were made with an instrument using peak/average detector mode.
3. Average test would be performed if the peak result were greater than the average limit or as required by the applicant.
4. Data of measurement within this frequency range shown " --- " in the table above means the reading of emissions are attenuated more than 20dB below the permissible limits or the field strength is too small to be measured.
5. Measurements above show only up to 6 maximum emissions noted, or would be lesser, with " N/A " remark, if no specific emissions from the EUT are recorded (ie: margin>20dB from the applicable limit) and considered that's already beyond the background noise floor.
6. Margin (dB) = Remark result (dBuV/m) – Average limit (dBuV/m).

**TX / IEEE 802.11n HT 20 MHz mode / CH High**

**Polarity: Vertical**

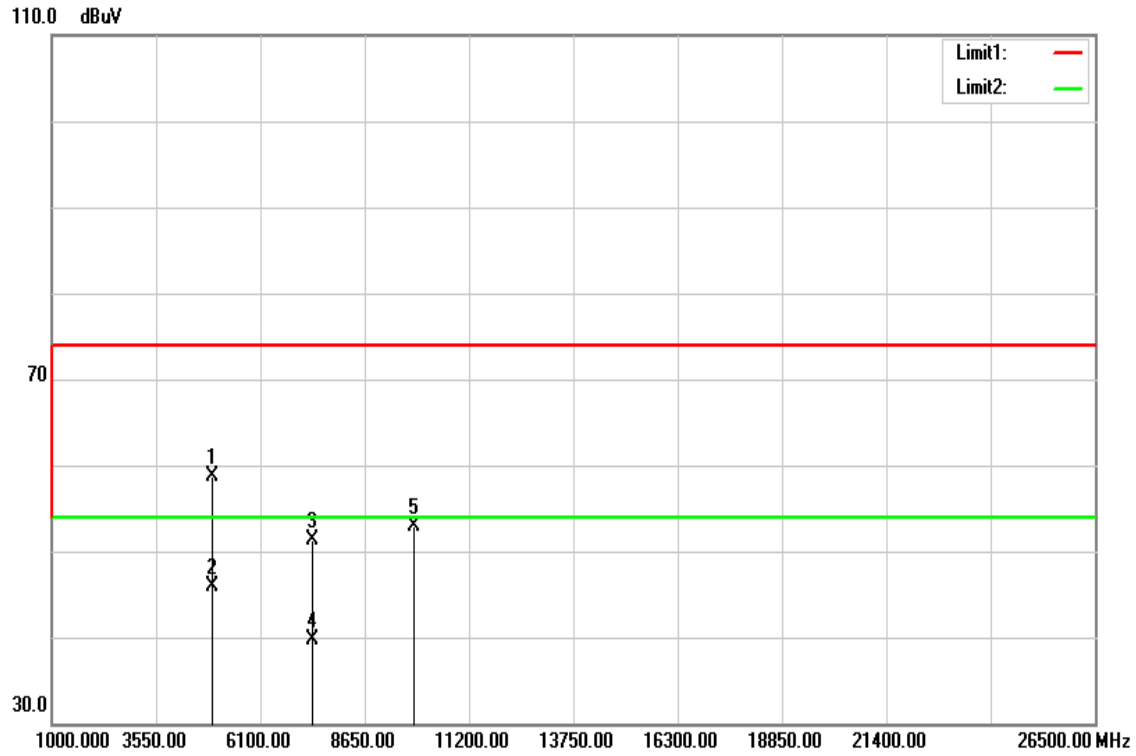

**Polarity: Horizontal**

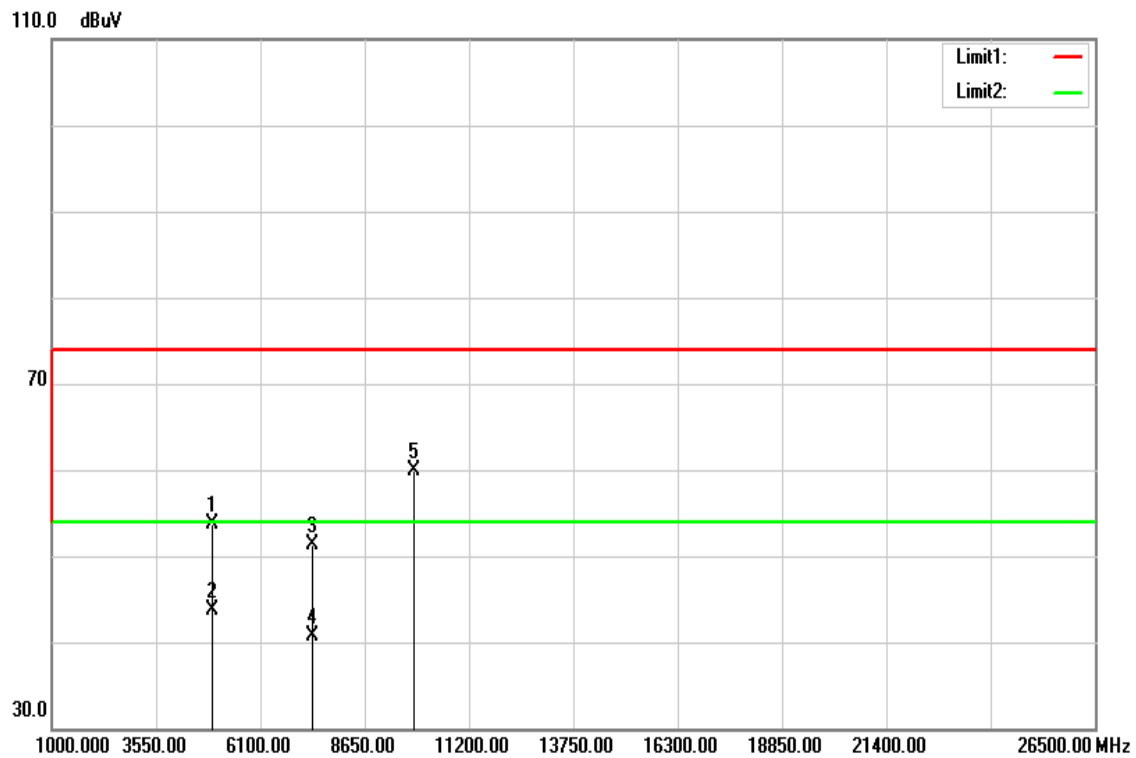

**Operation Mode:** TX / IEEE 802.11n HT 20 MHz mode / CH High  
**Temperature:** 27°C  
**Humidity:** 53% RH

**Test Date:** March 18, 2016  
**Tested by:** Jason Lu  
**Polarity:** Ver. / Hor.

Frequency (MHz)	Reading (dBuV)	Correction Factor (dB/m)	Result (dBuV/m)	Limit (dBuV/m)	Margin (dB)	Remark	Ant. Pol. (H/V)
4924.000	53.43	5.37	58.80	74.00	-15.20	peak	V
4924.000	40.55	5.37	45.92	54.00	-8.08	AVG	V
7386.000	38.03	13.17	51.20	74.00	-22.80	peak	V
7386.000	26.50	13.17	39.67	54.00	-14.33	AVG	V
9848.000	35.39	17.60	52.99	74.00	-21.01	peak	V
N/A							
4924.000	48.29	5.37	53.66	74.00	-20.34	peak	H
4924.000	38.39	5.37	43.76	54.00	-10.24	AVG	H
7386.000	38.11	13.17	51.28	74.00	-22.72	peak	H
7386.000	27.59	13.17	40.76	54.00	-13.24	AVG	H
9848.000	42.31	17.60	59.91	74.00	-14.09	peak	H
N/A							

**Remark:**

1. Measuring frequencies from 1 GHz to the 10th harmonic of highest fundamental frequency.
2. Radiated emissions measured in frequency above 1000MHz were made with an instrument using peak/average detector mode.
3. Average test would be performed if the peak result were greater than the average limit or as required by the applicant.
4. Data of measurement within this frequency range shown " --- " in the table above means the reading of emissions are attenuated more than 20dB below the permissible limits or the field strength is too small to be measured.
5. Measurements above show only up to 6 maximum emissions noted, or would be lesser, with " N/A " remark, if no specific emissions from the EUT are recorded (ie: margin>20dB from the applicable limit) and considered that's already beyond the background noise floor.
6. Margin (dB) = Remark result (dBuV/m) – Average limit (dBuV/m).

**TX / IEEE 802.11n HT 40 MHz mode / CH Low**

**Polarity: Vertical**

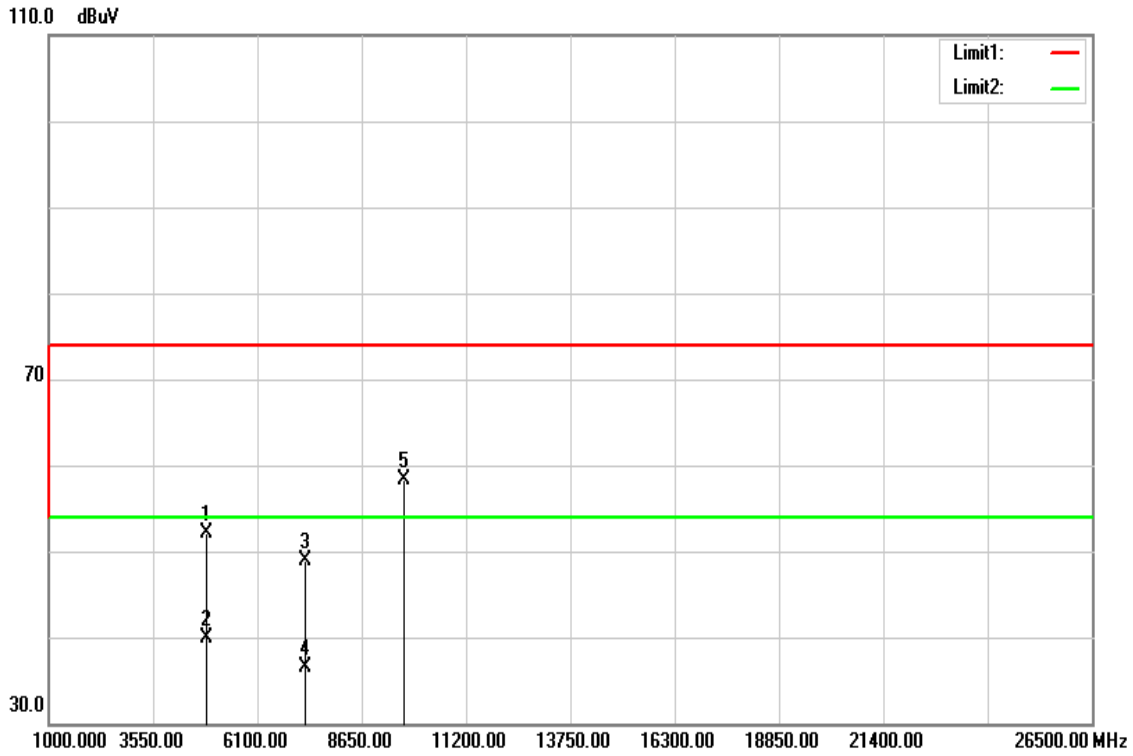

**Polarity: Horizontal**

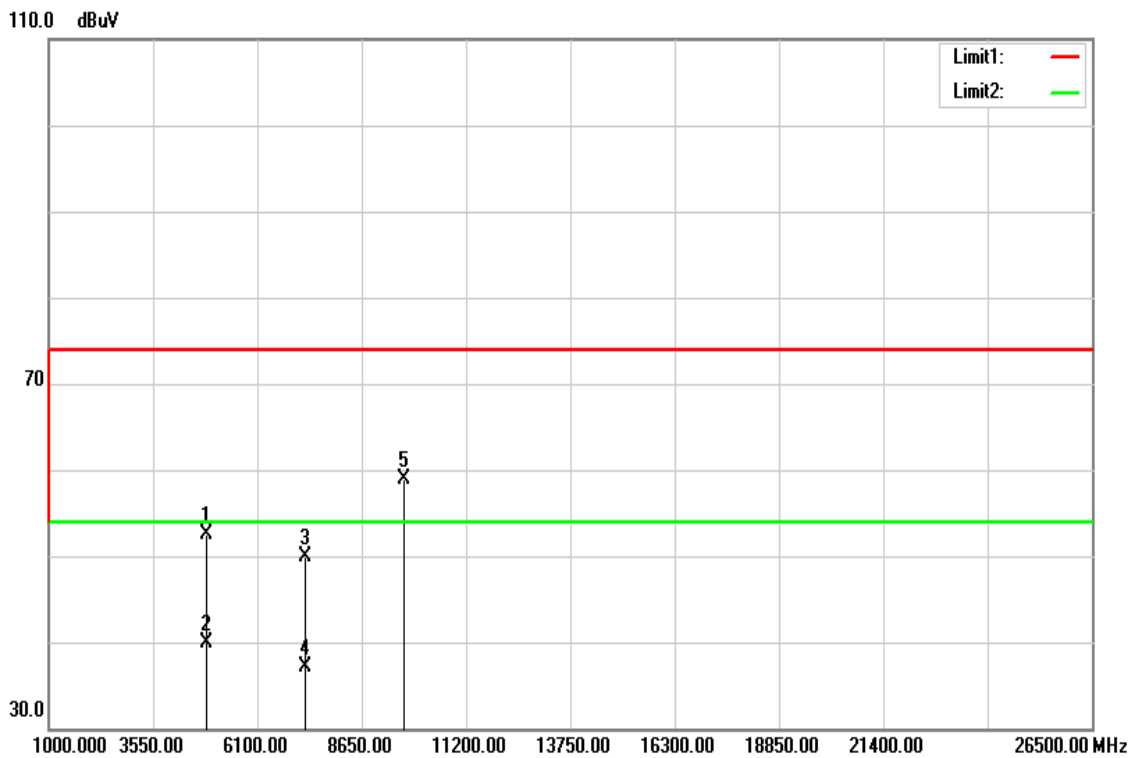

**Operation Mode:** TX / IEEE 802.11n HT 40 MHz mode  
/ CH Low

**Test Date:** March 18, 2016

**Temperature:** 27°C

**Tested by:** Jason Lu

**Humidity:** 53% RH

**Polarity:** Ver. / Hor.

Frequency (MHz)	Reading (dBuV)	Correction Factor (dB/m)	Result (dBuV/m)	Limit (dBuV/m)	Margin (dB)	Remark	Ant. Pol. (H/V)
4844.000	46.95	5.15	52.10	74.00	-21.90	peak	V
4844.000	34.70	5.15	39.85	54.00	-14.15	AVG	V
7266.000	36.13	12.80	48.93	74.00	-25.07	peak	V
7266.000	23.67	12.80	36.47	54.00	-17.53	AVG	V
9688.000	40.65	17.60	58.25	74.00	-15.75	peak	V
N/A							
4844.000	47.29	5.15	52.44	74.00	-21.56	peak	H
4844.000	34.76	5.15	39.91	54.00	-14.09	AVG	H
7266.000	37.13	12.80	49.93	74.00	-24.07	peak	H
7266.000	24.35	12.80	37.15	54.00	-16.85	AVG	H
9688.000	41.29	17.60	58.89	74.00	-15.11	peak	H
N/A							

**Remark:**

1. Measuring frequencies from 1 GHz to the 10th harmonic of highest fundamental frequency.
2. Radiated emissions measured in frequency above 1000MHz were made with an instrument using peak/average detector mode.
3. Average test would be performed if the peak result were greater than the average limit or as required by the applicant.
4. Data of measurement within this frequency range shown " --- " in the table above means the reading of emissions are attenuated more than 20dB below the permissible limits or the field strength is too small to be measured.
5. Measurements above show only up to 6 maximum emissions noted, or would be lesser, with " N/A " remark, if no specific emissions from the EUT are recorded (ie: margin>20dB from the applicable limit) and considered that's already beyond the background noise floor.
6. Margin (dB) = Remark result (dBuV/m) – Average limit (dBuV/m).

**TX / IEEE 802.11n HT 40 MHz mode / CH Mid**

**Polarity: Vertical**

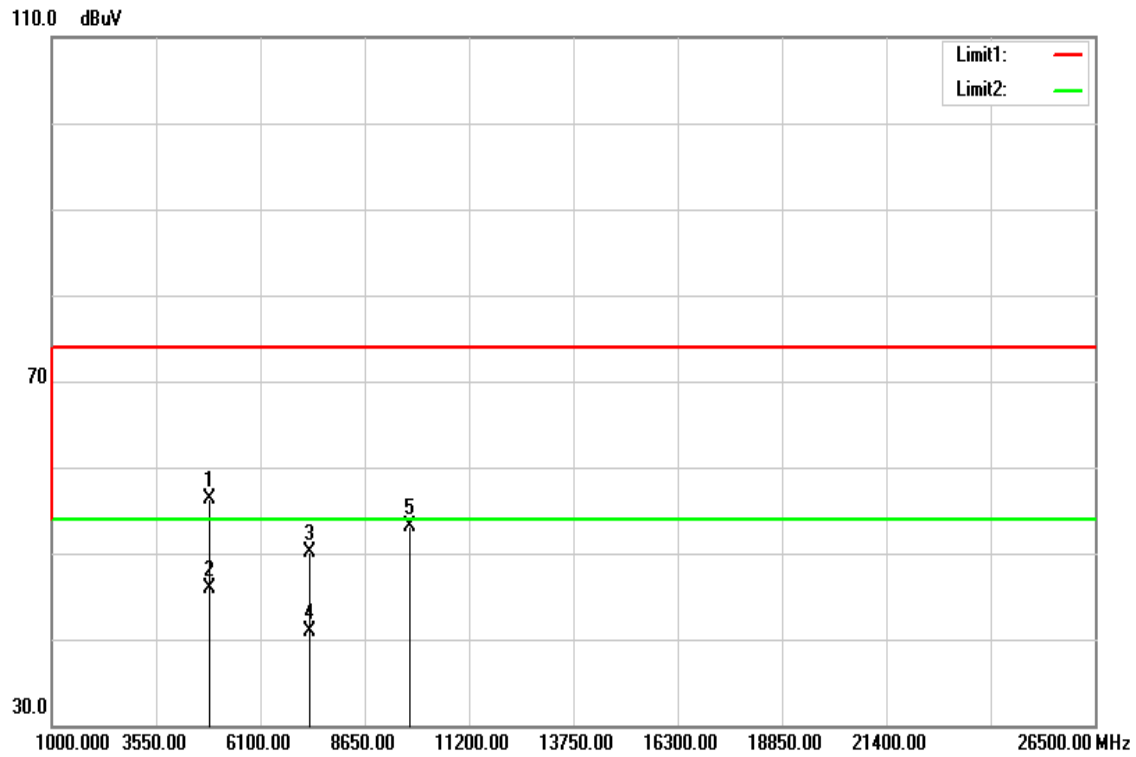

**Polarity: Horizontal**

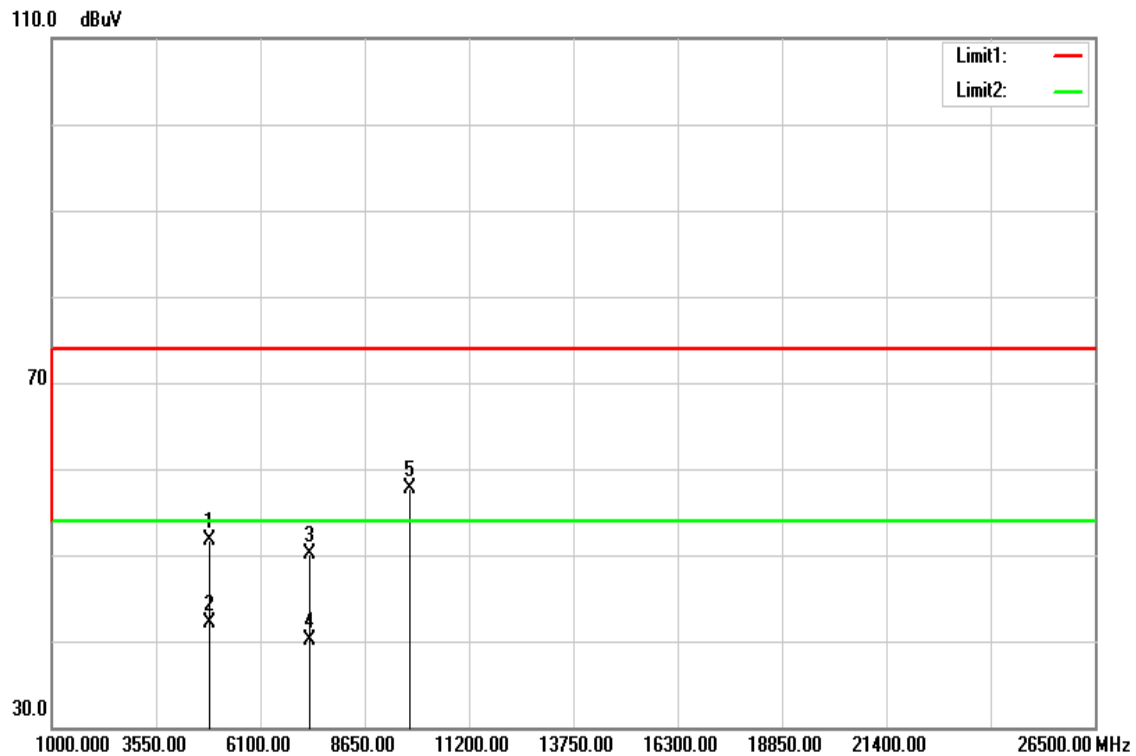



**Operation Mode:** TX / IEEE 802.11n HT 40 MHz mode  
/ CH Mid

**Test Date:** March 18, 2016

**Temperature:** 27°C

**Tested by:** Jason Lu

**Humidity:** 53% RH

**Polarity:** Ver. / Hor.

Frequency (MHz)	Reading (dBuV)	Correction Factor (dB/m)	Result (dBuV/m)	Limit (dBuV/m)	Margin (dB)	Remark	Ant. Pol. (H/V)
4874.000	50.99	5.23	56.22	74.00	-17.78	peak	V
4874.000	40.61	5.23	45.84	54.00	-8.16	AVG	V
7311.000	37.20	12.94	50.14	74.00	-23.86	peak	V
7311.000	27.91	12.94	40.85	54.00	-13.15	AVG	V
9748.000	35.59	17.60	53.19	74.00	-20.81	peak	V
N/A							
4874.000	46.51	5.23	51.74	74.00	-22.26	peak	H
4874.000	36.90	5.23	42.13	54.00	-11.87	AVG	H
7311.000	37.09	12.94	50.03	74.00	-23.97	peak	H
7311.000	27.17	12.94	40.11	54.00	-13.89	AVG	H
9748.000	40.19	17.60	57.79	74.00	-16.21	peak	H
N/A							

**Remark:**

1. Measuring frequencies from 1 GHz to the 10th harmonic of highest fundamental frequency.
2. Radiated emissions measured in frequency above 1000MHz were made with an instrument using peak/average detector mode.
3. Average test would be performed if the peak result were greater than the average limit or as required by the applicant.
4. Data of measurement within this frequency range shown " --- " in the table above means the reading of emissions are attenuated more than 20dB below the permissible limits or the field strength is too small to be measured.
5. Measurements above show only up to 6 maximum emissions noted, or would be lesser, with " N/A " remark, if no specific emissions from the EUT are recorded (ie: margin>20dB from the applicable limit) and considered that's already beyond the background noise floor.
6. Margin (dB) = Remark result (dBuV/m) – Average limit (dBuV/m).

**TX / IEEE 802.11n HT 40 MHz mode / CH High**

**Polarity: Vertical**

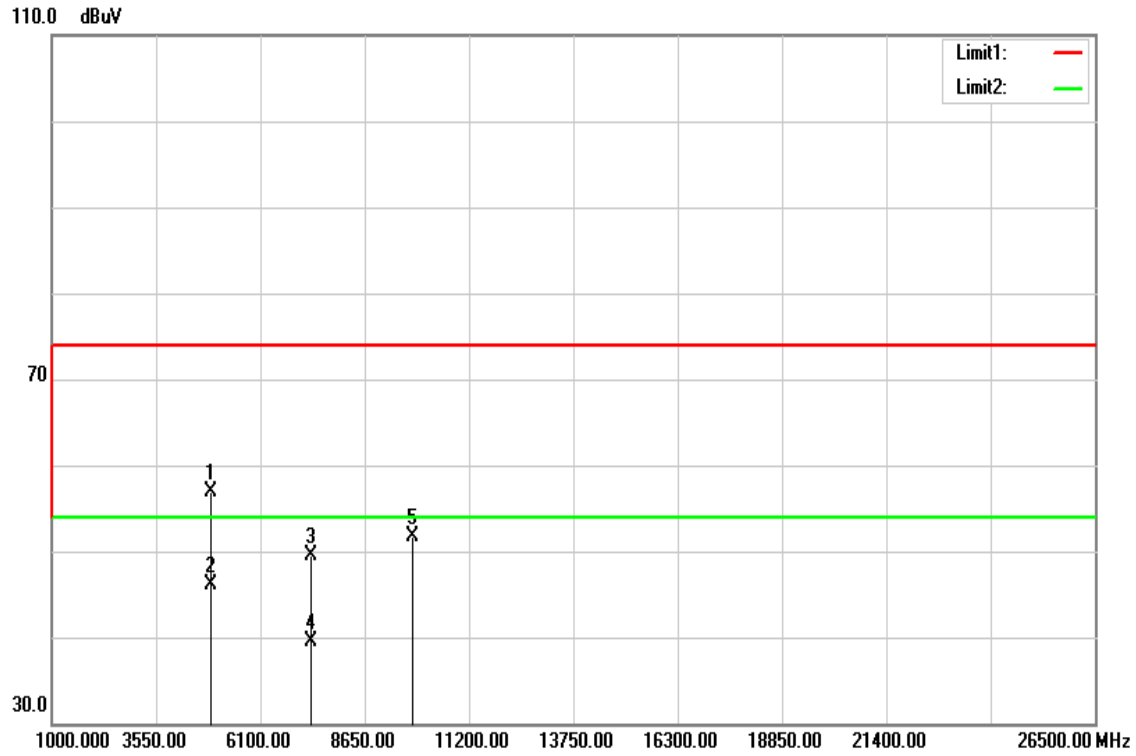

**Polarity: Horizontal**

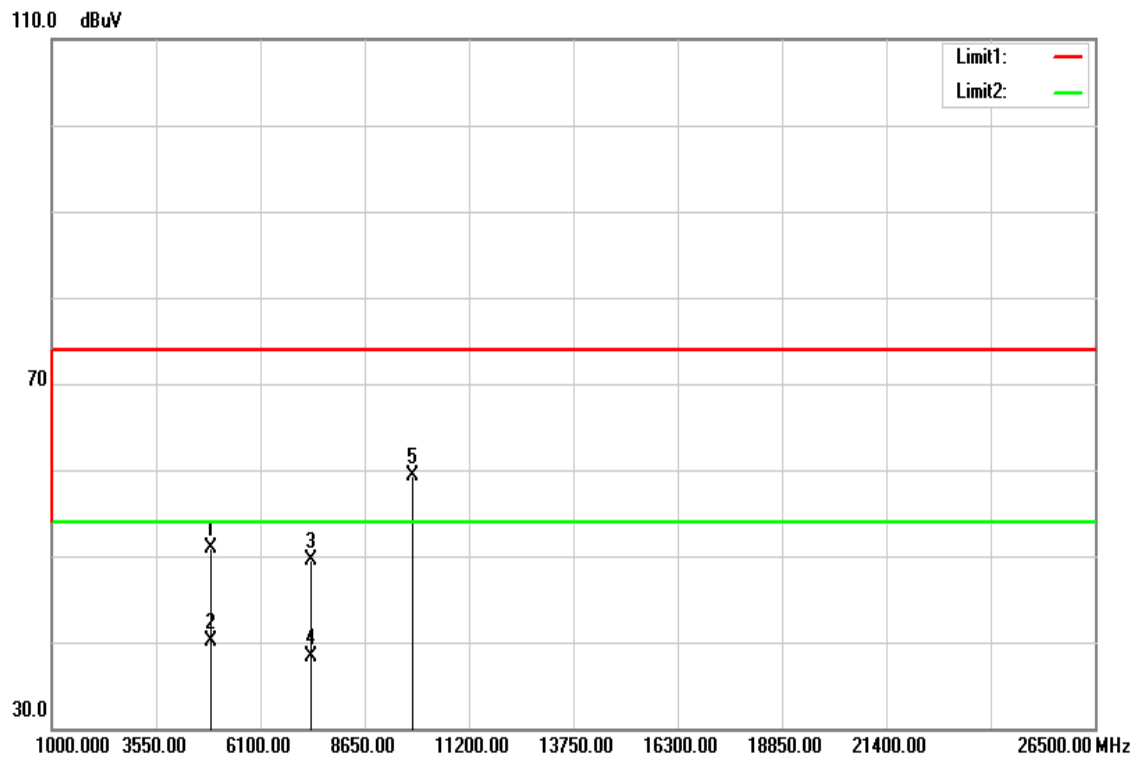

**Operation Mode:** TX / IEEE 802.11n HT 40 MHz mode  
/ CH High

**Test Date:** March 18, 2016

**Temperature:** 27°C

**Tested by:** Jason Lu

**Humidity:** 53% RH

**Polarity:** Ver. / Hor.

Frequency (MHz)	Reading (dBuV)	Correction Factor (dB/m)	Result (dBuV/m)	Limit (dBuV/m)	Margin (dB)	Remark	Ant. Pol. (H/V)
4904.000	51.54	5.31	56.85	74.00	-17.15	peak	V
4904.000	40.83	5.31	46.14	54.00	-7.86	AVG	V
7356.000	36.33	13.08	49.41	74.00	-24.59	peak	V
7356.000	26.45	13.08	39.53	54.00	-14.47	AVG	V
9808.000	34.17	17.60	51.77	74.00	-22.23	peak	V
N/A							
4904.000	45.50	5.31	50.81	74.00	-23.19	peak	H
4904.000	34.79	5.31	40.10	54.00	-13.90	AVG	H
7356.000	36.37	13.08	49.45	74.00	-24.55	peak	H
7356.000	25.12	13.08	38.20	54.00	-15.80	AVG	H
9808.000	41.68	17.60	59.28	74.00	-14.72	peak	H
N/A							

**Remark:**

1. Measuring frequencies from 1 GHz to the 10th harmonic of highest fundamental frequency.
2. Radiated emissions measured in frequency above 1000MHz were made with an instrument using peak/average detector mode.
3. Average test would be performed if the peak result were greater than the average limit or as required by the applicant.
4. Data of measurement within this frequency range shown " --- " in the table above means the reading of emissions are attenuated more than 20dB below the permissible limits or the field strength is too small to be measured.
5. Measurements above show only up to 6 maximum emissions noted, or would be lesser, with " N/A " remark, if no specific emissions from the EUT are recorded (ie: margin>20dB from the applicable limit) and considered that's already beyond the background noise floor.
6. Margin (dB) = Remark result (dBuV/m) – Average limit (dBuV/m).

## 7.8 POWERLINE CONDUCTED EMISSIONS

### LIMIT

According to §15.207(a) & RSS-Gen §8.8, except as shown in paragraphs (b) and (c) of this section, for an intentional radiator that is designed to be connected to the public utility (AC) power line, the radio frequency voltage that is conducted back onto the AC power line on any frequency or frequencies within the band 150 kHz to 30 MHz shall not exceed the limits in the following table, as measured using a 50  $\mu$ H/50 ohms line impedance stabilization network (LISN). Compliance with the provisions of this paragraph shall be based on the measurement of the radio frequency voltage between each power line and ground at the power terminal. The lower limit applies at the boundary between the frequency ranges.

Frequency Range (MHz)	Limits (dB $\mu$ V)	
	Quasi-peak	Average
0.15 to 0.50	66 to 56*	56 to 46*
0.50 to 5	56	46
5 to 30	60	50

\* Decreases with the logarithm of the frequency.

### Test Configuration

See test photographs attached in Appendix II for the actual connections between EUT and support equipment.

### TEST PROCEDURE

1. The EUT was placed on a table, which is 0.8m above ground plane.
2. Maximum procedure was performed on the six highest emissions to ensure EUT compliance.
3. Repeat above procedures until all frequency measured were complete.

## **TEST RESULTS**

The initial step in collecting conducted data is a spectrum analyzer peak scan of the measurement range. Significant peaks are then marked as shown on the following data page, and these signals are then quasi-peaked.

### **Test Data**

**Operation Mode:** Normal Link                      **Test Date:** March 14, 2016  
**Temperature:** 24°C                                      **Tested by:** Dennis Li  
**Humidity:** 50% RH

Freq. (MHz)	QP Reading (dBuV)	AV Reading (dBuV)	Corr. factor (dB/m)	QP Result (dBuV/m)	AV Result (dBuV/m)	QP Limit (dBuV)	AV Limit (dBuV)	QP Margin (dB)	AV Margin (dB)	Note
0.1740	32.23	19.22	9.69	41.92	28.91	64.76	54.77	-22.84	-25.86	L1
0.4420	21.63	17.97	9.75	31.38	27.72	57.02	47.02	-25.64	-19.30	L1
0.5140	28.70	27.07	9.85	38.55	36.92	56.00	46.00	-17.45	-9.08	L1
10.1140	20.24	10.20	9.95	30.19	20.15	60.00	50.00	-29.81	-29.85	L1
16.0180	21.57	11.42	9.98	31.55	21.40	60.00	50.00	-28.45	-28.60	L1
16.8779	19.47	9.60	9.98	29.45	19.58	60.00	50.00	-30.55	-30.42	L1
0.1780	32.25	19.19	9.64	41.89	28.83	64.57	54.58	-22.68	-25.75	L2
0.2100	29.63	17.00	9.64	39.27	26.64	63.20	53.21	-23.93	-26.57	L2
0.4460	20.72	15.96	9.71	30.43	25.67	56.95	46.95	-26.52	-21.28	L2
0.5140	28.78	27.22	9.81	38.59	37.03	56.00	46.00	-17.41	-8.97	L2
13.4780	20.39	11.33	9.93	30.32	21.26	60.00	50.00	-29.68	-28.74	L2
16.4340	20.75	11.31	9.96	30.71	21.27	60.00	50.00	-29.29	-28.73	L2

**Remark:**

1. Measuring frequencies from 0.15 MHz to 30MHz.
2. The emissions measured in frequency range from 0.15 MHz to 30MHz were made with an instrument using Quasi-peak detector and average detector.
3. The IF bandwidth of SPA between 0.15MHz and 30MHz was 10 kHz; the IF bandwidth of Test Receiver between 0.15MHz and 30MHz was 9 kHz;
4. L1 = Line One (Live Line) / L2 = Line Two (Neutral Line)

**Test Plots**

**Conducted emissions (Line 1)**

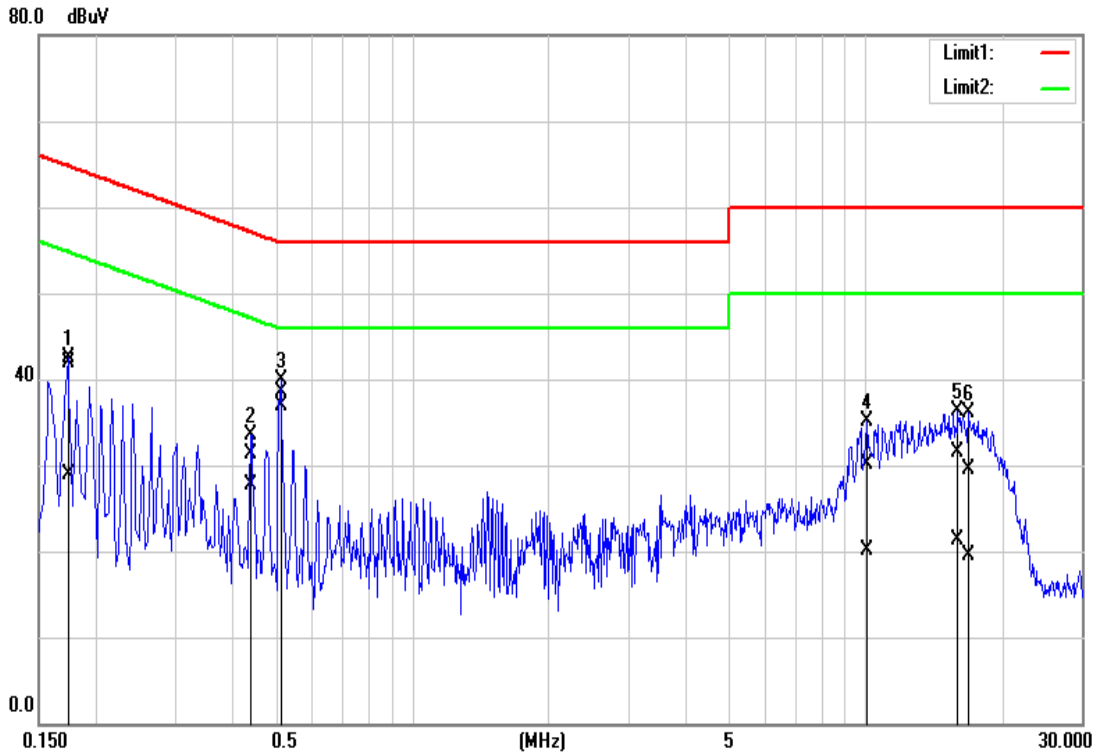

**Conducted emissions (Line 2)**

