



EUROFINS ELECTRICAL TESTING SERVICE (SHENZHEN) CO., LTD.

RADIO TEST - REPORT

FCC Compliance Test Report for

Product name: Wireless control button

Model name: SRVO SR260 SWITCH

FCC ID: 2AHVL-SRVO-SWITCH

Test Report Number: EFGX22080017-IE-01-E04

1	General Information	3
1.1	Notes	3
1.2	Testing laboratory	4
1.3	Details of applicant	4
1.4	Details of manufacturer	4
1.5	Application details	5
1.6	Test item	5
1.7	Test standards	5
2	Technical test	6
2.1	Summary of test results	6
2.2	Test environment	6
2.3	Measurement uncertainty	6
2.4	Test mode	7
2.5	Test equipment utilized	7
2.6	Auxiliary Equipment Used during Test:	7
2.7	Test software information:	7
2.8	Test setup	8
2.9	Test results	10
3	Technical requirement and result	11
3.1	20 dB bandwidth	11
3.2	Radiated emission	13

1 General Information

1.1 Notes

The results of this test report relate exclusively to the item tested as specified in chapter “Description of test item” and are not transferable to any other test items.

Eurofins Electrical Testing Service (Shenzhen) Co., Ltd. is not responsible for any generalisations and conclusions drawn from this report. Any modification of the test item can lead to invalidity of test results and this test report may therefore be not applicable to the modified test item.

The test report may only be reproduced or published in full. Reproducing or publishing extracts of the report requires the prior written approval of the Eurofins Electrical Testing Service (Shenzhen) Co., Ltd. This document is subject to the General Terms and Conditions and the Testing and Certification System of Eurofins Electrical Testing Service (Shenzhen) Co., Ltd., available on request or accessible at www.eurofins.com.

Operator:

2022-08-26		Bruce Zheng / Project Engineer	
Date	Eurofins-Lab.	Name / Title	Signature

Technical responsibility for area of testing:

2022-08-26		Albert Xu / Lab Manager	
Date	Eurofins	Name / Title	Signature

1.2 Testing laboratory

Eurofins Electrical Testing Service (Shenzhen) Co., Ltd.

1st Floor, Building 2, Chungu, Meisheng Huigu Science and Technology Park, No. 83 Dabao Road, Bao'an District, Shenzhen. P.R.China.

Telephone : +86-755-82911867

Fax : +86-755-82910749

The Laboratory has passed the Accreditation by the American Association for Laboratory Accreditation (A2LA). The Accreditation number is 5376.01

The Laboratory has been listed by industry Canada to perform electromagnetic emission measurements, The CAB identifier is CN0088

1.3 Details of applicant

Name : Dyaco international inc
Address : 12F No. 111 Songjiang Rd Taipei City Taiwan, 10486
Telephone : ./.
Fax : ./.

1.4 Details of manufacturer

Name : Dyaco international inc
Address : 12F No. 111 Songjiang Rd Taipei City Taiwan, 10486
Telephone : ./.
Fax : ./.

1.5 Application details

Date of receipt of application : 2022-08-15
 Date of receipt of test item : 2022-08-15
 Date of test : 2022-08-15 to 2022-08-25
 Date of issue : 2022-08-26

1.6 Test item

Product type : Wireless control button
 Model name : SRVO SR260 SWITCH
 Brand : SOLE
 Serial number : ./.
 Ratings : 3.0Vdc supplied by a type "CR2032" Battery
 Test voltage : 3Vdc
 FCC ID : 2AHVL-SRVO-SWITCH
 Hardware Version : YD.SWITCH.1B
 Software / Firmware Version : HPS20_Wireless_Switch_Sender_Rf73fea2_20210528
 PMN : Wireless control button
 Additional information : ./.

RadioTechnical data

Frequency range : 2405MHz
 Radio Tech. : 2.4G SRD
 Frequency channel : 1
 Modulation : GFSK
 Antenna type : PCB antenna
 Antenna gain : 0 dBi

1.7 Test standards

Test Standards	
FCC Part 15 Subpart C December 16, 2020	PART 15 - RADIO FREQUENCY DEVICES Subpart C - Intentional Radiators
RSS-210 Issue 10 December 2019	RSS-210 — Licence-Exempt Radio Apparatus: Category I Equipment

Test Method

- ANSI C63.4-2014, American National Standard for Methods of Measurement of Radio-Noise Emissions from Low-Voltage Electrical and Electronic Equipment in the Range of 9 kHz to 40 GHz.
- ANSI C63.10-2013, American National Standard for Testing Unlicensed Wireless Devices.

2 Technical test

2.1 Summary of test results

No deviations from the technical specification(s) were ascertained in the course of the tests performed.

or

The deviations as specified were ascertained in the course of the tests performed.

2.2 Test environment

RF Conducted

Environment Parameter	Temperature	Relative Humidity
101.2Kpa	24.6	62.6%

Radiated

Environment Parameter	Temperature	Relative Humidity
101.2Kpa	23.7	51.7%

2.3 Measurement uncertainty

The uncertainty is calculated using the methods suggested in the "Guide to the Expression of Uncertainty in Measurement" (GUM) published by ISO.

System Measurement Uncertainty	
Test Items	Extended Uncertainty
Uncertainty in conducted measurements	1.96dB
Uncertainty for Conducted RF test	RF Power Conducted: 1.16dB Frequency test involved: 1.05x10 ⁻⁷ or 1%
Uncertainty for Radiated Spurious Emission 25MHz-3000MHz	Horizontal: 4.46dB; Vertical: 4.54dB;
Uncertainty for Radiated Spurious Emission 3000MHz-18000MHz	Horizontal: 4.42dB; Vertical: 4.41dB;
Uncertainty for Radiated Spurious Emission 18000MHz-40000MHz	Horizontal: 4.63dB; Vertical: 4.62dB;

2.4 Test mode

The EUT was set at continuously transmitting mode during the test.

2.5 Test equipment utilized

EQUIPMENT ID	EQUIPMENT NAME	MODEL NO.	CAL. DUE DATE
23-2-13-05	EMI Test Receiver	ESR3	2023-04-24
23-2-13-06	LISN	NNLK 8127 RC	2023-04-23
23-2-10-16	Attenuator	VTSD 9561-F	2023-04-24
23-2-13-12	Signal Analyzer	N9010B-544	2023-04-24
23-2-13-13	BT/WLAN Tester	CMW270	2023-04-23
23-2-13-14	Signal Generator	N5183B-520	2023-04-23
23-2-13-15	Vector Signal Generator	N5182B-506	2023-04-23
23-2-10-43	Switch and Control Unit	ERIT-E-JS0806-2	2023-06-17
23-2-10-44	DC power supply	E3642A	2023-06-03
23-2-10-45	Temperature test chamber	SG-80-CC-2	2023-04-23
23-2-13-01	EMI Test Receiver	ESR7	2023-04-24
23-2-13-02	Signal Analyzer	N9020B-544	2023-04-24
23-2-12-01	Active Loop Antenna	FMZB 1519B	2024-05-05
23-2-12-02	TRILOG Broadband Antenna	VULB9168	2024-05-05
23-2-12-03	Horn Antenna	3117	2024-05-05
23-2-12-04	Horn Antenna	BBHA 9170	2024-05-05
23-2-10-01	Preamplifier	BBV9745	2023-04-23
23-2-10-02	Preamplifier	TAP01018048	2023-04-24
23-2-10-03	Preamplifier	TAP18040048	2023-04-24
23-2-10-14	Switch and Control Unit	ERIT-E-JS0806-SF1	N/A

2.6 Auxiliary Equipment Used during Test:

DESCRIPTION	MANUFACTURER	MODEL NO.	S/N
Laptop	LENOVO	TP00096A	PF-1QH0LV

2.7 Test software information:

Test Software Version	N/A		
Modulation	Setting TX Power	TX Pattern	Packet Type
N/A	N/A	TX Packet	N/A

2.8 Test setup

Setup diagram for conducted tests

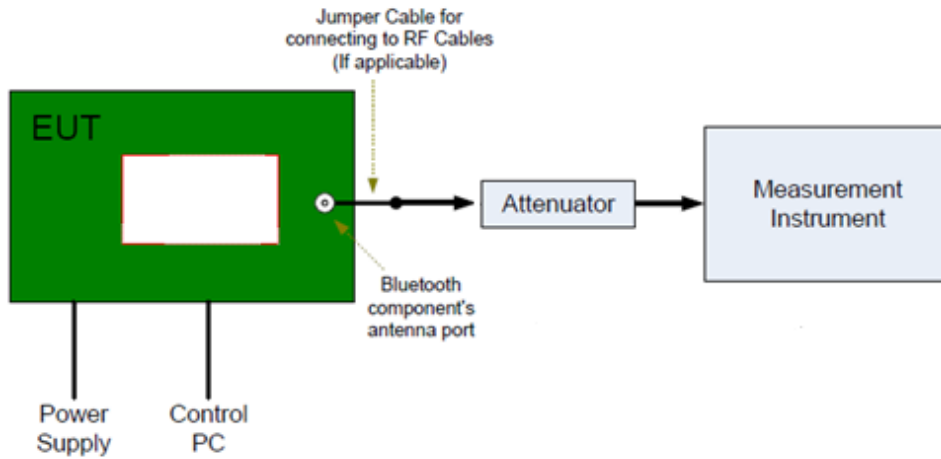

Setup diagram for radiated tests below 30MHz

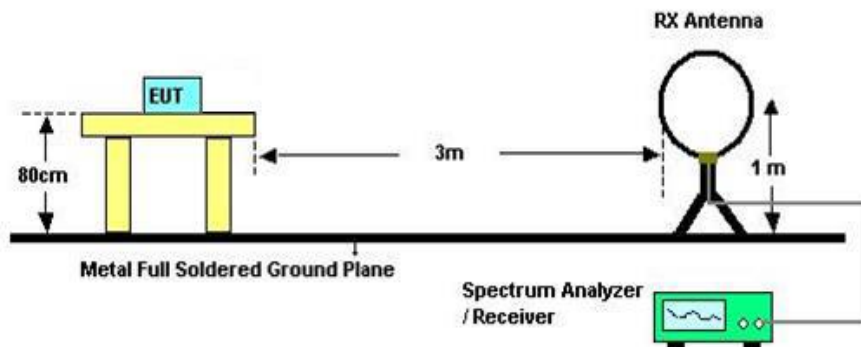

Setup diagram for radiated tests below 1GHz

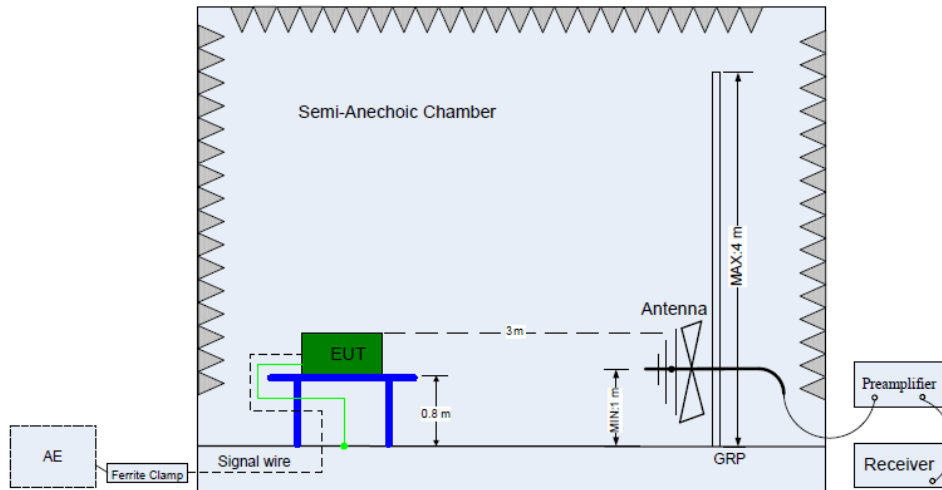

(Below 1 GHz)

Setup diagram for radiated tests above 1GHz

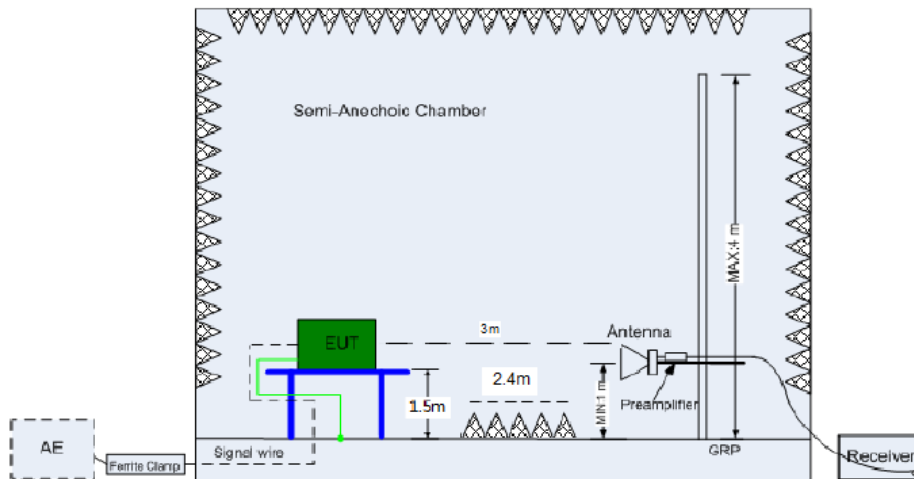

(Above 1 GHz)

2.9 Test results

 1st test

 test after modification

 production test

Technical Requirements				
FCC Part 15 Subpart C/RSS-210 Issue 10/RSS-Gen Issue 5				
Test Condition		Test Result	Verdict	Test Site
§15.215(c)(1)	20dB bandwidth	See page 12	Pass	Site 1
§15.249(a)&(d)&§15.209 &§15.205	Radiated emission	See page 16	Pass	Site 1
§15.203	Antenna requirement	See note 1	Pass	--

Remark 1: N/A – Not Applicable.

Note 1: The EUT uses a PCB antenna, the gain: 0 dBi. According to §15.203, it is considered sufficiently to comply with the provisions of this section.

3 Technical requirement and result

3.1 20 dB bandwidth

Test Method:

The test method was referred to the subclause 6.9.2 of ANSI C63.10-2013.

The occupied bandwidth is measured as the width of the spectral envelope of the modulated signal, at an amplitude level reduced from a reference value by a specified ratio (or in decibels, a specified number of dB down from the reference value). Typical ratios, expressed in dB, are -6 dB, -20 dB, and -26 dB, corresponding to 6 dB BW, 20 dB BW, and 26 dB BW, respectively. In this subclause, the ratio is designated by “-xx dB.” The reference value is either the level of the unmodulated carrier or the highest level of the spectral envelope of the modulated signal, as stated by the applicable requirement. Some requirements might specify a specific maximum or minimum value for the “-xx dB” bandwidth; other requirements might specify that the “-xx dB” bandwidth be entirely contained within the authorized or designated frequency band.

- a) The spectrum analyzer center frequency is set to the nominal EUT channel center frequency. The span range for the EMI receiver or spectrum analyzer shall be between two times and five times the OBW.
- b) The nominal IF filter bandwidth (3 dB RBW) shall be in the range of 1% to 5% of the OBW and video bandwidth (VBW) shall be approximately three times RBW, unless otherwise specified by the applicable requirement.
- c) Set the reference level of the instrument as required, keeping the signal from exceeding the maximum input mixer level for linear operation. In general, the peak of the spectral envelope shall be more than $[10 \log (OBW/RBW)]$ below the reference level. Specific guidance is given in 4.1.5.2.
- d) Steps a) through c) might require iteration to adjust within the specified tolerances.
- e) The dynamic range of the instrument at the selected RBW shall be more than 10 dB below the target “-xx dB down” requirement; that is, if the requirement calls for measuring the -20 dB OBW, the instrument noise floor at the selected RBW shall be at least 30 dB below the reference value.
- f) Set detection mode to peak and trace mode to max hold.
- g) Determine the reference value: Set the EUT to transmit an unmodulated carrier or modulated signal, as applicable. Allow the trace to stabilize. Set the spectrum analyzer marker to the highest level of the displayed trace (this is the reference value).
- h) Determine the “-xx dB down amplitude” using $[(\text{reference value}) - xx]$. Alternatively, this calculation may be made by using the marker-delta function of the instrument.
- i) If the reference value is determined by an unmodulated carrier, then turn the EUT modulation ON, and either clear the existing trace or start a new trace on the spectrum analyzer and allow the new trace to stabilize. Otherwise, the trace from step g) shall be used for step j).
- j) Place two markers, one at the lowest frequency and the other at the highest frequency of the envelope of the spectral display, such that each marker is at or slightly below the “ixx dB down amplitude” determined in step h). If a marker is below this “-xx dB down amplitude” value, then it shall be as close as possible to this value. The occupied bandwidth is the frequency difference between the two markers. Alternatively, set a marker at the lowest frequency of the envelope of the spectral display, such that the marker is at or slightly below the “ixx dB down amplitude” determined in step h). Reset the marker-delta function and move the marker to the other side of the emission until the delta marker amplitude is at the same level as the reference marker amplitude. The marker-delta frequency reading at this point is the specified emission bandwidth.
- k) The occupied bandwidth shall be reported by providing plot(s) of the measuring instrument display; the plot axes and the scale units per division shall be clearly labeled. Tabular data may be reported in addition to the plot(s).

Limit:

None; for reporting purposes only.

Test Result:

Channel	20db EBW[MHz]	FL[MHz]	FH[MHz]	Verdict
2405	1.29	2404.365	2405.655	PASS

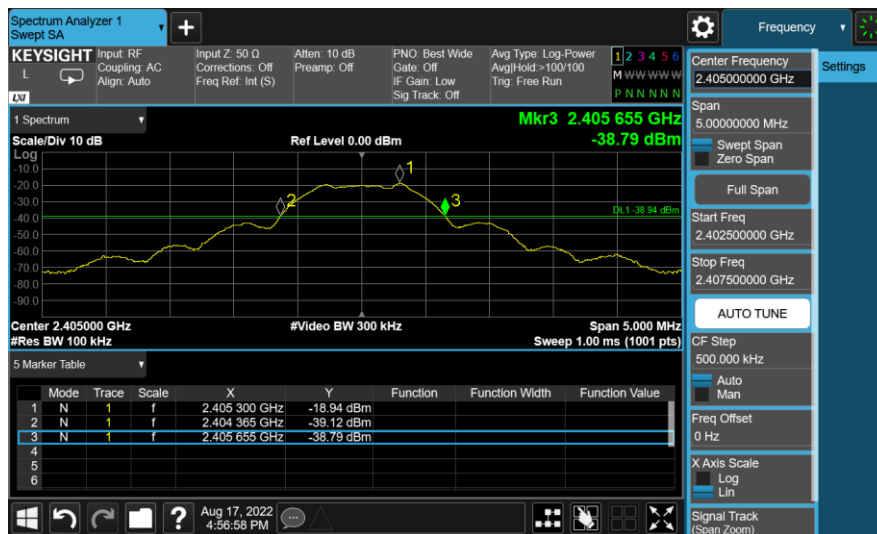

3.2 Radiated emission

Test Method:

The test method was referred to the subclause 11.11/11.12 of ANSI C63.10-2013.

- 1: The EUT was placed on a turn table which is 1.5m above ground plane for above 1GHz and 0.8m above ground for below 1GHz at 3 meter chamber room for test. The table was rotated 360 degrees to determine the position of the highest radiation.
- 2: The EUT was set 3 meters away from the interference – receiving antenna, which was mounted on the top of a variable – height antenna tower.
- 3: The height of antenna is varied from one meter to four meters above the ground to determine the maximum value of the field strength. Both horizontal and vertical polarizations of the antenna are set to make the measurement.
- 4: For each suspected emission, the EUT was arranged to its worst case and then the antenna was tuned to heights from 1 meter to 4 meters and the rotatable table was turned from 0 degrees to 360 degrees to find the maximum reading.
- 5: Use the following spectrum analyzer settings According to C63.10:
For Above 1GHz
Span = wide enough to capture the peak level of the in-band emission and all spurious
RBW = 1MHz, VBW \geq RBW for peak measurement and VBW = 10Hz for average measurement, Sweep = auto, Detector function = peak, Trace = max hold.
For Below 1GHz
Use the following spectrum analyzer settings:
Span = wide enough to capture the peak level of the in-band emission and all spurious
RBW = 100 KHz, VBW \geq RBW for peak measurement, Sweep = auto, Detector function = peak, Trace = max hold.
For Below 30MHz
Use the following spectrum analyzer settings:
Span = wide enough to capture the peak level of the in-band emission and all spurious
RBW = 200 Hz, VBW \geq RBW from 9KHz to 0.15MHz, RBW 9KHz VBW \geq RBW from 0.15MHz to 30MHz for peak measurement, Sweep = auto, Detector function = peak, Trace = max hold.

Note:

- 1: The resolution bandwidth and video bandwidth of test receiver/spectrum analyzer is 120 KHz for Quasi-peak detection (QP) at frequency below 1GHz.
- 2: The resolution bandwidth of test receiver/spectrum analyzer is 1MHz and the video bandwidth is 3MHz for peak detection (PK) at frequency above 1GHz.
- 3: The resolution bandwidth of test receiver/spectrum analyzer is 1MHz and the video bandwidth is 3MHz for RMS Average ((duty cycle < 98%) for Average detection (AV) at frequency above 1GHz, then the measurement results was added to a correction factor (20log(1/duty cycle)).
- 4: The resolution bandwidth of test receiver/spectrum analyzer is 1MHz and the video bandwidth is 10Hz (duty cycle > 98%) for Average detection (AV) at frequency above 1GHz.
- 5: When duty cycle <98%, The resolution bandwidth of test receiver/spectrum analyzer is 1MHz and the video bandwidth is VBW \geq 1 / T, the T is transmission duration (T).

Limit:

FCC §15.209

Frequency Range (MHz)	Field Strength Limit ($\mu\text{V/m}$) at 3 m	Field Strength Limit ($\text{dB}\mu\text{V/m}$) at 3 m
0.009-0.490	2400/F(kHz) @ 300 m	-
0.490-1.705	24000/F(kHz) @ 30 m	-
1.705 - 30	30 @ 30m	-
30 - 88	100	40
88 - 216	150	43.5
216 - 960	200	46
Above 960	500	54

§15.205 Restricted bands of operation

MHz	MHz	MHz	GHz
0.090-0.110	16.42-16.423	399.9-410	4.5-5.15
0.495-0.505	16.69475-16.69525	608-614	5.35-5.46
2.1735-2.1905	16.80425-16.80475	960-1240	7.25-7.75
4.125-4.128	25.5-25.67	1300-1427	8.025-8.5
4.17725-4.17775	37.5-38.25	1435-1626.5	9.0-9.2
4.20725-4.20775	73-74.6	1645.5-1646.5	9.3-9.5
6.215-6.218	74.8-75.2	1660-1710	10.6-12.7
6.26775-6.26825	108-121.94	1718.8-1722.2	13.25-13.4
6.31175-6.31225	123-138	2200-2300	14.47-14.5
8.291-8.294	149.9-150.05	2310-2390	15.35-16.2
8.362-8.366	156.52475-156.52525	2483.5-2500	17.7-21.4
8.37625-8.38675	156.7-156.9	2690-2900	22.01-23.12
8.41425-8.41475	162.0125-167.17	3260-3267	23.6-24.0
12.29-12.293	167.72-173.2	3332-3339	31.2-31.8
12.51975-12.52025	240-285	3345.8-3358	36.43-36.5
12.57675-12.57725	322-335.4	3600-4400	
13.36-13.41			

FCC §15.249(a)

Fundamental frequency	Field strength of fundamental (mV/m)	Field strength of fundamental (dB μ V/m)	Field strength of harmonics (μ V/m)	Field strength of harmonics (dB μ V/m)
902-928 MHz	50	94	500	54
2400-2483.5 MHz	50	94	500	54
5725-5875 MHz	50	94	500	54
24.0-24.25 GHz	250	128	2500	68

Test Result:

30-1000MHz

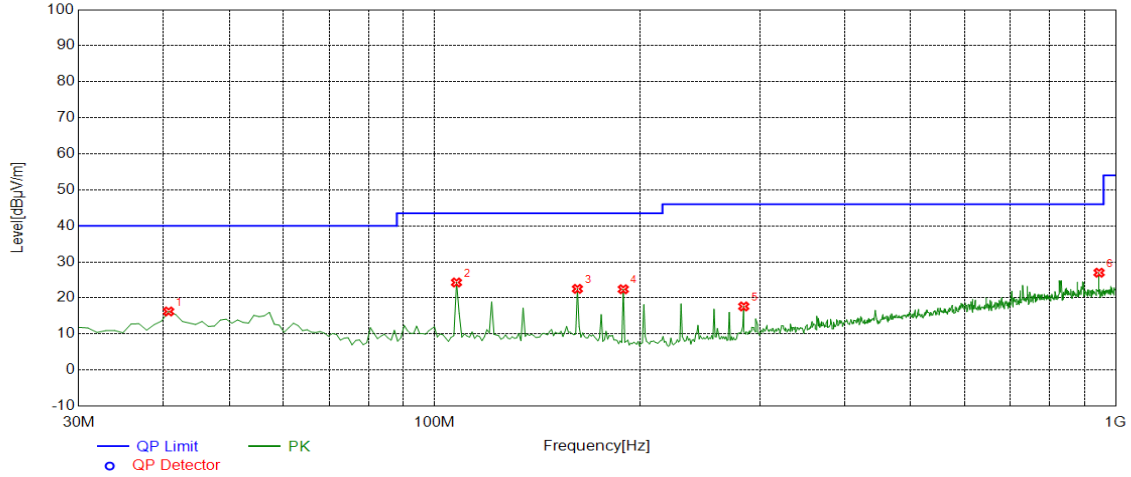

NO.	Freq. [MHz]	Level [dBµV/m]	Factor [dB/m]	Limit [dBµV/m]	Margin [dB]	Height [cm]	Angle [°]	Polarity
1	40.6807	16.25	-15.80	40.00	23.75	100	10	Horizontal
2	107.677	24.30	-19.59	43.50	19.20	100	300	Horizontal
3	162.052	22.52	-15.77	43.50	20.98	100	280	Horizontal
4	189.239	22.42	-18.10	43.50	21.08	100	300	Horizontal
5	284.394	17.65	-15.98	46.00	28.35	100	10	Horizontal
6	945.625	27.01	-5.16	46.00	18.99	100	280	Horizontal

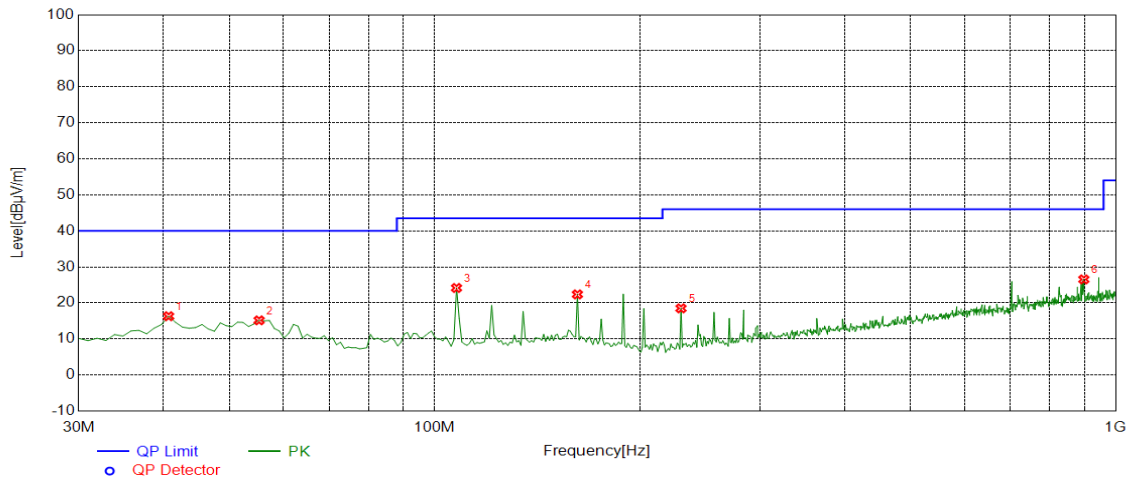

NO.	Freq. [MHz]	Level [dBµV/m]	Factor [dB/m]	Limit [dBµV/m]	Margin [dB]	Height [cm]	Angle [°]	Polarity
1	40.6807	16.32	-15.80	40.00	23.68	100	150	Vertical
2	55.2452	15.18	-15.88	40.00	24.82	100	230	Vertical
3	107.677	24.17	-19.59	43.50	19.33	100	250	Vertical
4	162.052	22.38	-15.77	43.50	21.12	100	60	Vertical
5	230.020	18.51	-18.33	46.00	27.49	100	330	Vertical
6	898.048	26.54	-5.70	46.00	19.46	100	10	Vertical

PK Final Data List								
NO.	Freq. [MHz]	PK Reading [dB μ V/m]	Level [dB μ V/m]	Factor [dB/m]	Limit [dB μ V/m]	Margin [dB]	Polarity	Verdict
1	1440.00	66.03	41.08	-24.95	74.00	32.92	Horizon-	PASS
2	3764.49	64.77	46.27	-18.50	74.00	27.73	Horizon-	PASS
3	4264.15	65.09	47.88	-17.21	74.00	26.12	Horizon-	PASS
4	4808.79	66.53	50.08	-16.45	74.00	23.92	Horizon-	PASS
5	7212.19	68.06	55.31	-12.75	74.00	18.69	Horizon-	PASS
6	9225.84	62.97	52.49	-10.48	74.00	21.51	Horizon-	PASS

PK Final Data List								
NO.	Freq. [MHz]	PK Reading [dB μ V/m]	Level [dB μ V/m]	Factor [dB/m]	Limit [dB μ V/m]	Margin [dB]	Polarity	Verdict
1	3659.56	64.79	46.15	-18.64	74.00	27.85	Vertical	PASS
2	4808.79	65.19	48.74	-16.45	74.00	25.26	Vertical	PASS
3	6107.92	63.12	49.51	-13.61	74.00	24.49	Vertical	PASS
4	7217.18	67.78	55.04	-12.74	74.00	18.96	Vertical	PASS
5	8381.41	64.28	52.27	-12.01	74.00	21.73	Vertical	PASS
6	8991.00	63.39	52.35	-11.04	74.00	21.65	Vertical	PASS

According to C63.10, if the peak (or quasi-peak) measured value complies with the average limit, it is unnecessary to perform an average measurement, so AV emission value did not show in below table if the peak value complies with average limit.

Band-edge (Radiated)

2405MHz Test Result

PK Final Data List								
NO.	Freq. [MHz]	PK Reading [dB μ V/m]	Level [dB μ V/m]	Factor [dB/m]	Limit [dB μ V/m]	Margin [dB]	Polarity	Verdict
1	2386.10	64.27	43.29	-20.98	74.00	30.71	Horizon-	PASS
2	2390.00	62.60	41.63	-20.97	74.00	32.37	Horizon-	PASS

PK Final Data List								
NO.	Freq. [MHz]	PK Reading [dB μ V/m]	Level [dB μ V/m]	Factor [dB/m]	Limit [dB μ V/m]	Margin [dB]	Polarity	Verdict
1	2365.10	66.07	45.05	-21.02	74.00	28.95	Vertical	PASS
2	2390.00	63.19	42.22	-20.97	74.00	31.78	Vertical	PASS

Level = Read level + Factor

Factor= Antenna Factor + Cable loss – Preamp Factor

Field strength of fundamental

PK Final Data List								
NO.	Freq. [MHz]	PK Reading [dB μ V/m]	Level [dB μ V/m]	Factor [dB/m]	Limit [dB μ V/m]	Margin [dB]	Polarity	Verdict
1	2405	107.52	86.57	-20.95	114.00	27.43	Vertical	PASS

PK Final Data List								
NO.	Freq. [MHz]	PK Reading [dB μ V/m]	Level [dB μ V/m]	Factor [dB/m]	Limit [dB μ V/m]	Margin [dB]	Polarity	Verdict
1	2405	112.74	91.79	-20.95	114.00	22.21	Horizon-	PASS

-END OF REPORT-