



# Shenzhen General Testing & Inspection Technology Co., Ltd.

1-2/F., Building 2, Jiaquan Building, Guanlan High-Tech Park, Shenzhen, Guangdong, China  
Tel : +86-755-27521059  
Fax: +86-755-27521011

## FCC TEST REPORT

**Product name**..... : LED TV  
**Trademark**..... : AMTC, JVC  
**Model Name**..... : MUAV5801-65864  
**Adding Model**..... : MUAV58\*\*-65864 (\*can from 0 to 9,A to Z ); LT-58MA877,  
LT-58MA887  
**Test Standards** ..... : **FCC CFR Title 47 Part 15 Subpart B**  
**FCC ID**..... : 2AHVH58658641  
**Report no.** ..... : GTI20181916F  
**Applicant** ..... : Shen Zhen MTC Co.,LTD  
**Address of applicant** ..... : MTC Industry Park, 1st Lilang Road, Xialilang community, Nanwan  
street,Longgang district, Shenzhen, China  
**Date of Receipt**..... : Oct 10, 2018  
**Date of Test Date**..... : Oct 10, 2018 to Oct 19, 2018  
**Date of issue.** ..... : Oct 19, 2018

<b>Test result</b> ..... :	Pass *
----------------------------	--------

\* In the configuration tested, the EUT complied with the standards specified above



The FCC mark as shown above can be used, under the responsibility of the manufacturer, all necessary steps have been enforced to assure that all production units of the same equipment will continue to comply with the Federal Communications Commission's requirements.

---

Shenzhen General Testing & Inspection Technology Co., Ltd.

1-2/F., Building 2, Jiaquan Building, Guanlan High-Tech Park, Shenzhen, Guangdong, China  
Tel.: (86)755-27521059 Fax.: (86)755-27521011 Http://www.sz-ctc.org.cn



For anti-fake verification, please visit the official website of Certification and Accreditation Administration of the People's Republic of China : [yz.cncaic.cn](http://yz.cncaic.cn)

**GENERAL DESCRIPTION OF EUT**

Equipment	LED TV
Model Name	MUAV5801-65864
Adding Model	MUAV58**-65864 (*can from 0 to 9,A to Z ); LT-58MA877, LT-58MA887
Model Difference	Just different colors and trademarks, the other is the same
Manufacturer	Shen Zhen MTC Co.,LTD
Manufacturer Address	MTC Industry Park, 1st Lilang Road, Xialilang community, Nanwan street,Longgang district, Shenzhen, China
Factory	Shen Zhen MTC Co.,LTD
Factory Address	MTC Industry Park, 1st Lilang Road, Xialilang community, Nanwan street,Longgang district, Shenzhen, China
Product Description	Based on the application, features, or specification exhibited in User's Manual, the EUT is considered as as both an ITE /Computing Device & a Sound and Television Broadcast Receiver. More details of EUT technical specification, please refer to the User's Manual.
Power Rating	Input: AC100-240V, 50/60Hz, 150W

Compiled By:

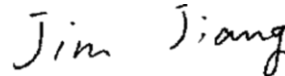

(Jim Jiang)

Reviewed By:



(Cary Luo)

Approved By:

  
(Walter Chen)

This test report may be duplicated completely for legal use with the approval of the applicant. It should not be reproduced except in full, without the written approval of our laboratory. The client should not use it to claim product endorsement by GTI. The test results in the report only apply to the tested sample. The test report shall be invalid without all the signatures of testing engineers, reviewer and approver. Any objections must be raised to GTI within 15 days since the date when the report is received. It will not be taken into consideration beyond this limit.



**Table of Contents**

**Page**

<b>1</b>	<b>TEST SUMMARY</b> .....	<b>4</b>
1.1	TEST STANDARDS .....	4
1.2	TEST FACILITY .....	4
1.3	MEASUREMENT UNCERTAINTY .....	5
<b>2</b>	<b>GENERAL INFORMATION</b> .....	<b>6</b>
2.1	DESCRIPTION OF TEST MODES .....	6
2.2	DESCRIPTION TEST PERIPHERAL AND EUT PERIPHERAL .....	7
2.3	MEASUREMENT INSTRUMENTS EQUIPMENTS LIST .....	8
<b>3</b>	<b>CONDUCTED EMISSION MEASUREMENT</b> .....	<b>9</b>
3.1	LIMITS OF CONDUCTED EMISSION .....	9
3.2	TEST PROCEDURE.....	10
3.3	TEST SETUP .....	10
3.4	EUT OPERATING CONDITIONS .....	10
3.5	TEST RESULTS .....	11
<b>4</b>	<b>RADIATED EMISSION MEASUREMENT</b> .....	<b>13</b>
4.1	LIMITS OF RADIATED EMISSION MEASUREMENT.....	13
4.2	TEST PROCEDURE.....	13
4.3	TEST SETUP .....	14
4.4	EUT OPERATING CONDITIONS .....	14
4.5	TEST RESULTS .....	15
<b>5</b>	<b>ANTENNA POWER CONDUCTION MEASUREMENT</b> .....	<b>19</b>
<b>6</b>	<b>ANTENNA POWER CONDUCTION MEASUREMENT</b> .....	<b>21</b>
<b>7</b>	<b>PICTURE SENSITIVITY MEASUREMENT</b> .....	<b>23</b>
<b>8</b>	<b>NOISE FIGURE MEASUREMENT</b> .....	<b>24</b>
<b>9</b>	<b>EUT TEST PHOTO</b> .....	<b>25</b>
<b>10</b>	<b>ATTACHMENT PHOTOGRAPHS OF EUT</b> .....	<b>27</b>

## 1 TEST SUMMARY

### 1.1 TEST STANDARDS

The tests were performed according to following standards:

[47 CFR FCC Part 15 Subpart B](#): Unintentional Radiators.

[ANSI C63.4: 2014](#): American National Standard for Methods of Measurement of Radio-Noise Emissions from Low-Voltage Electrical and Electronic Equipment in the Range of 9 kHz to 40GHz.

Test procedures according to the technical standards:

Test	Standard	Class	Result	Remark
Conducted Emission	FCC Part 15 Section 15.107	Class B	PASS	---
Radiated Emission	FCC Part 15 Section 15.109	Class B	PASS	---
Antenna Power Conduction	FCC Part 15 Section 15.111	Class B	PASS	---
Picture Sensitivity	FCC Part 15 Section 15.117(f)	Class B	PASS	---
Noise figure	FCC Part 15 Section 15.117(g)	Class B	PASS	---

### 1.2 TEST FACILITY

Shenzhen General Testing & Inspection Technology Co., Ltd.

Add. : 1-2F., Building 2, Jiaquan Building, Guanlan High-Tech Park, Shenzhen, Guangdong, China

#### IC Registration No.: 9783A

The 3m alternate test site of Shenzhen GTI Technology Co., Ltd. EMC Laboratory has been registered by Certification and Engineer Bureau of Industry Canada for the performance of with Registration NO.: 9783A on Jan, 2016.

#### FCC-Registration No.: 951311

Shenzhen GTI Technology Co., Ltd. EMC Laboratory has been registered and fully described in a report filed with the (FCC) Federal Communications Commission. The acceptance letter from the FCC is maintained in our files. Registration 951311, Aug 26, 2017

1.3 MEASUREMENT UNCERTAINTY

The reported uncertainty of measurement  $y \pm U$  · where expended uncertainty **U** is based on a standard uncertainty multiplied by a coverage factor of **k=2** · providing a level of confidence of approximately **95 %** .

A. Conducted Measurement :

Test Site	Method	Measurement Frequency Range	U · (dB)	NOTE
GTIC01	ANSI	150 KHz ~ 30MHz	3.2	/

B. Radiated Measurement :

Test Site	Method	Measurement Frequency Range	U · (dB)	NOTE
GTIA01	ANSI	30MHz ~ 1000MHz	4.7	/
		1GHz ~ 6GHz	5.0	/

## 2 GENERAL INFORMATION

### 2.1 DESCRIPTION OF TEST MODES

As the function of the EUT, test mode selected to test as below to conform this standard.

test Mode	Description
Mode 1	AV IN
Mode 2	HDMI
Mode 3	USB
Mode 4	NTSC
Mode 5	ATSC

Note:

Pre-scan above all test mode and voltage(120Vac/60Hz and 230Vac/50Hz), found below test mode and voltage which it was worse case mode.

Test item	Worse case operation Test mode	Worse case operation Test Voltage
Conducted emission	Mode 2	120V/60Hz
Radiated emission	Mode 2	120V/60Hz
Antenna Power Conduction	Mode 4/ Mode 5	120V/60Hz
Picture Sensitivity	Mode 4	120V/60Hz
Noise figure	Mode 4	120V/60Hz

## 2.2 DESCRIPTION TEST PERIPHERAL AND EUT PERIPHERAL

The EUT has been tested as an independent unit together with other necessary accessories or support units. The following support units or accessories were used to form a representative test configuration during the tests.

Item	Equipment	Mfr/Brand	Model/Type No.	Series No.	Note
E-1	LED TV	AMTC, JVC	MUAV5801-65864	N/A	EUT
E-2	PC	HP	P7-1035cn	4CV125C15J	AE
E-3	DVD	GIEC	GK-901	N/A	AE
E-4	TV Generator	DTV tool	DTV	N/A	AE
E-5	Printer	HP	P1007	VNFN584036	AE
E-6	USB Disk	Kingston	DT101G2/8GB	253394	AE

Item	Shielded Type	Ferrite Core	Length	Note
C-1	NO	NO	120cm	AC Line
C-2	NO	NO	150cm	AV Line
C-3	NO	NO	150cm	HDMI Line
C-4	NO	NO	150cm	TV Line

Note:

- (1) The support equipment was authorized by Declaration of Confirmation.
- (2) For detachable type I/O cable should be specified the length in cm in 『Length』 column.
- (3) “YES” is means “shielded” “with core”; “NO” is means “unshielded” “without core”.

**2.3 MEASUREMENT INSTRUMENTS EQUIPMENTS LIST**

Conducted Emission							
Item	Test Equipment	Manufacturer	Model No.	Serial No.	Calibration date	Calibrated until	Calibration interval
1	LISN	R&S	ENV216	101112	Jan. 05, 2018	Jan. 04, 2019	1 year
2	LISN	R&S	ENV216	101113	Jan. 05, 2018	Jan. 04, 2019	1 year
3	EMI Test Receiver	R&S	ESCI	100920	Jan. 05, 2018	Jan. 04, 2019	1 year
4	ISN CAT6	Schwarzbeck	NTFM 8158	8158-0046	Jan. 05, 2018	Jan. 04, 2019	1 year
5	Isolation Transformer	Schwarzbeck	D-65396	65396	Jan. 05, 2018	Jan. 04, 2019	1 year
6	RF cable	Schwarzbeck	AK9515E	33154	Jan. 05, 2018	Jan. 04, 2019	1 year

Radiated Emission							
Item	Test Equipment	Manufacturer	Model No.	Serial No.	Calibration date	Calibrated until	Calibration interval
1	Bilog Antenna	Schwarzbeck	CBL6141A	4180	Jan. 05, 2018	Jan. 04, 2019	1 year
2	Spectrum Analyzer	R&S	FSU26	100105	Jan. 05, 2018	Jan. 04, 2019	1 year
3	Horn Antenna	Schwarzbeck	BBHA 9120D	647	Jan. 05, 2018	Jan. 04, 2019	1 year
4	Low Noise Pre-Amplifier	HP	8447D	1937A03050	Jan. 05, 2018	Jan. 04, 2019	1 year
5	Low Noise Pre-Amplifier	EMCI	EMC051835	980075	Jan. 05, 2018	Jan. 04, 2019	1 year
6	Test Receiver	R&S	ESCI7	100967	Jan. 05, 2018	Jan. 04, 2019	1 year
7	Antenna Mast	UC	UC3000	N/A	N/A	N/A	N/A
8	Turn Table	UC	UC3000	N/A	N/A	N/A	N/A
9	RF cable	Schwarzbeck	AK9515E	33155	Jan. 05, 2018	Jan. 04, 2019	1 year

Antenna Power Conduction& Picture Sensitivity& Noise figure							
Item	Test Equipment	Manufacturer	Model No.	Serial No.	Calibration date	Calibrated until	Calibration interval
1	EMI Test Receiver	R&S	ESCI	100920	Jan.05, 2018	Jan. 04, 2019	1 year
2	Spectrum Analyzer	R&S	FSU26	100105	Jan.05, 2018	Jan. 04, 2019	1 year
3	Digital signal generator	R&S	SFC-U	N/A	Jan.05, 2018	Jan. 04, 2019	1 year
4	Analog signal generator	PHILIPS	YQ-70C-1052 (PM5418)	N/A	Jan.05, 2018	Jan. 04, 2019	1 year
5	RF cable	Schwarzbeck	AK9515E	33154	Jan.05, 2018	Jan. 04, 2019	1 year

Shenzhen General Testing & Inspection Technology Co., Ltd.

1-2/F., Building 2, Jiaquan Building, Guanlan High-Tech Park, Shenzhen, Guangdong, China

Tel.: (86)755-27521059

Fax.: (86)755-27521011

Http://www.sz-ctc.org.cn



For anti-fake verification, please visit the official website of Certification and Accreditation Administration of the People's Republic of China : [yz.cncaic.cn](http://yz.cncaic.cn)



### 3 CONDUCTED EMISSION MEASUREMENT

#### 3.1 Limits of Conducted Emission

FREQUENCY (MHz)	Class A (dBuV)		Class B (dBuV)	
	Quasi-peak	Average	Quasi-peak	Average
0.15 -0.5	79.00	66.00	66 - 56 *	56 - 46 *
0.50 -5.0	73.00	60.00	56.00	46.00
5.0 -30.0	73.00	60.00	60.00	50.00

Note:

- (1) The tighter limit applies at the band edges.
- (2) The limit of " \* " marked band means the limitation decreases linearly with the logarithm of the frequency in the range.

The following table is the setting of the receiver

Receiver Parameters	Setting
Attenuation	10 dB
Start Frequency	0.15 MHz
Stop Frequency	30 MHz
IF Bandwidth	9 kHz

### 3.2 TEST PROCEDURE

- a. The EUT was tested according to ANSI C63.4:2014.
- b. The EUT was placed 0.8 meters from the horizontal ground plane with EUT being connected to the power mains through a line impedance stabilization network (LISN). All other support equipments powered from additional LISN(s). The LISN provide 50 Ohm/ 50uH of coupling impedance for the measuring instrument.
- c. Interconnecting cables that hang closer than 40 cm to the ground plane shall be folded back and forth in the center forming a bundle 30 to 40 cm long.
- d. I/O cables that are not connected to a peripheral shall be bundled in the center. The end of the cable may be terminated, if required, using the correct terminating impedance. The overall length shall not exceed 1 m.
- e. LISN at least 80 cm from nearest part of EUT chassis.
- f. For the actual test configuration, please refer to the related Item –EUT Test Photos.

### 3.3 TEST SETUP

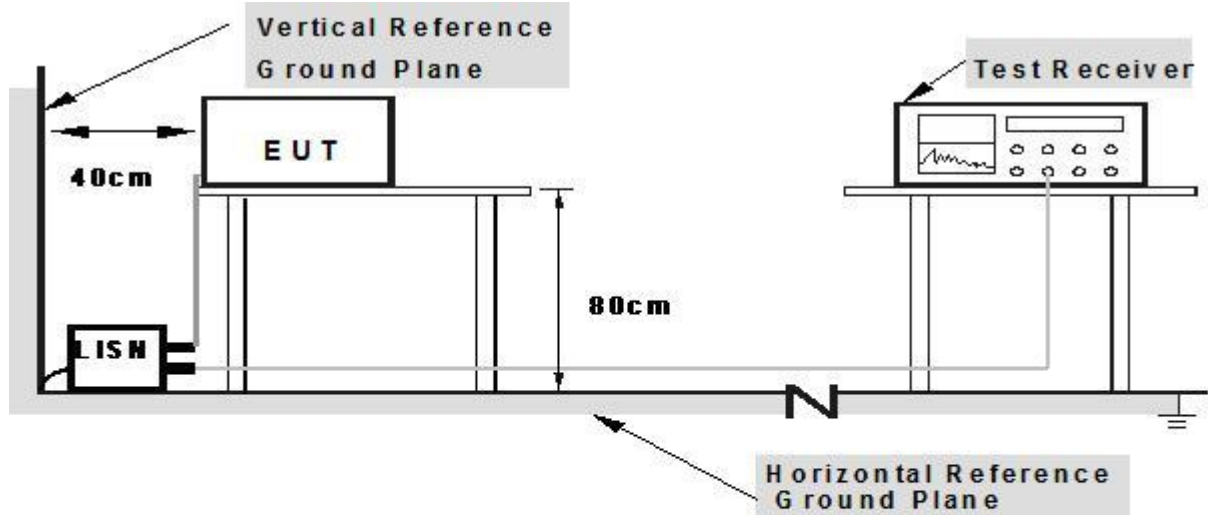

**Note: 1. Support units were connected to second LISN.**

**2. Both of LISN s (AMN) are 80 cm from EUT and at least 80 from other units and other metal planes**

### 3.4 EUT OPERATING CONDITIONS

The EUT tested system was configured as the statements of 2.1 Unless otherwise a special operating condition is specified in the follows during the testing.

### 3.5 TEST RESULTS

Temperature :	25.0°C	Relative Humidity :	52%
Pressure :	101 Kpa	Test Mode :	Mode 2
Test Voltage :	AC 120V/60Hz	Phase :	L

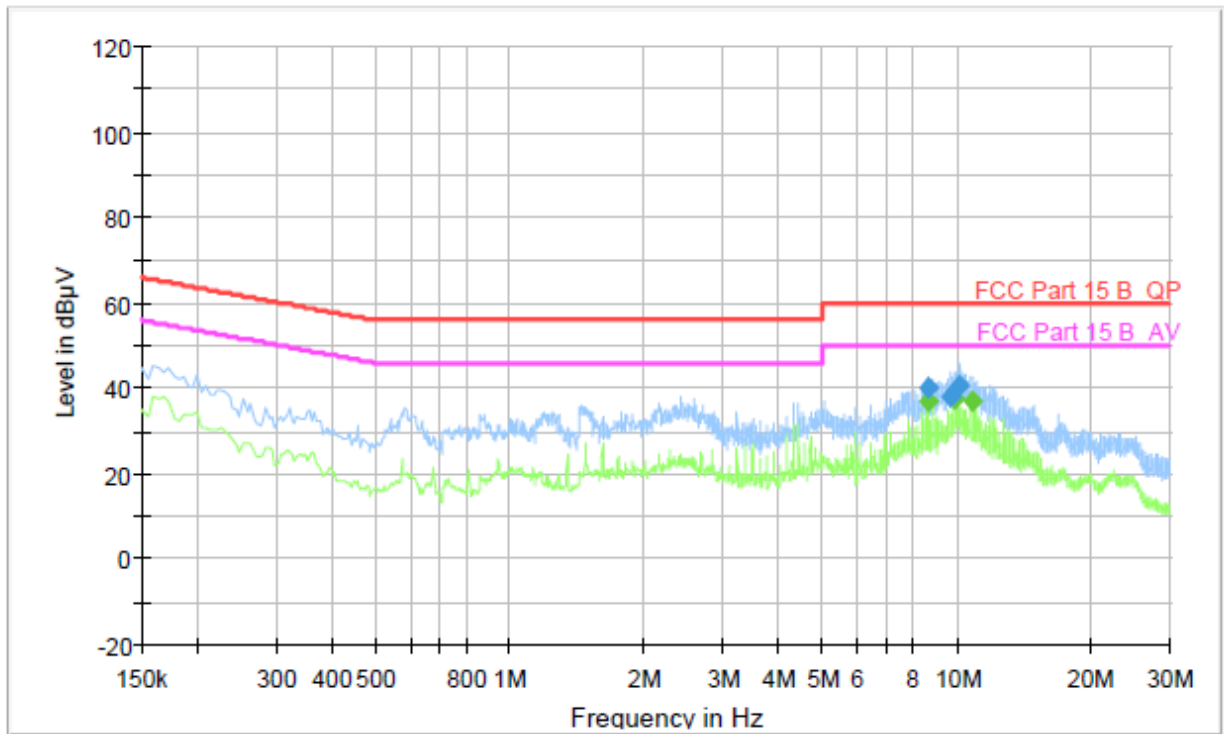

#### Final Measurement Detector 1

Frequency (MHz)	QuasiPeak (dBµV)	Meas. Time (ms)	Bandwidth (kHz)	Filter	Line	Corr. (dB)	Margin (dB)	Limit (dBµV)	Comment
8.619000	39.9	1000.000	9.000	Off	L1	9.7	20.1	60.0	
9.699000	38.3	1000.000	9.000	Off	L1	9.7	21.7	60.0	
10.216500	40.5	1000.000	9.000	Off	L1	9.7	19.5	60.0	

#### Final Measurement Detector 2

Frequency (MHz)	Average (dBµV)	Meas. Time (ms)	Bandwidth (kHz)	Filter	Line	Corr. (dB)	Margin (dB)	Limit (dBµV)	Comment
8.619000	36.9	1000.000	9.000	Off	L1	9.7	13.1	50.0	
9.964500	37.4	1000.000	9.000	Off	L1	9.7	12.6	50.0	
10.923000	36.9	1000.000	9.000	Off	L1	9.7	13.1	50.0	

Temperature :	25.0°C	Relative Humidity :	52%
Pressure :	101 Kpa	Test Mode :	Mode 2
Test Voltage :	AC 120V/60Hz	Phase :	N

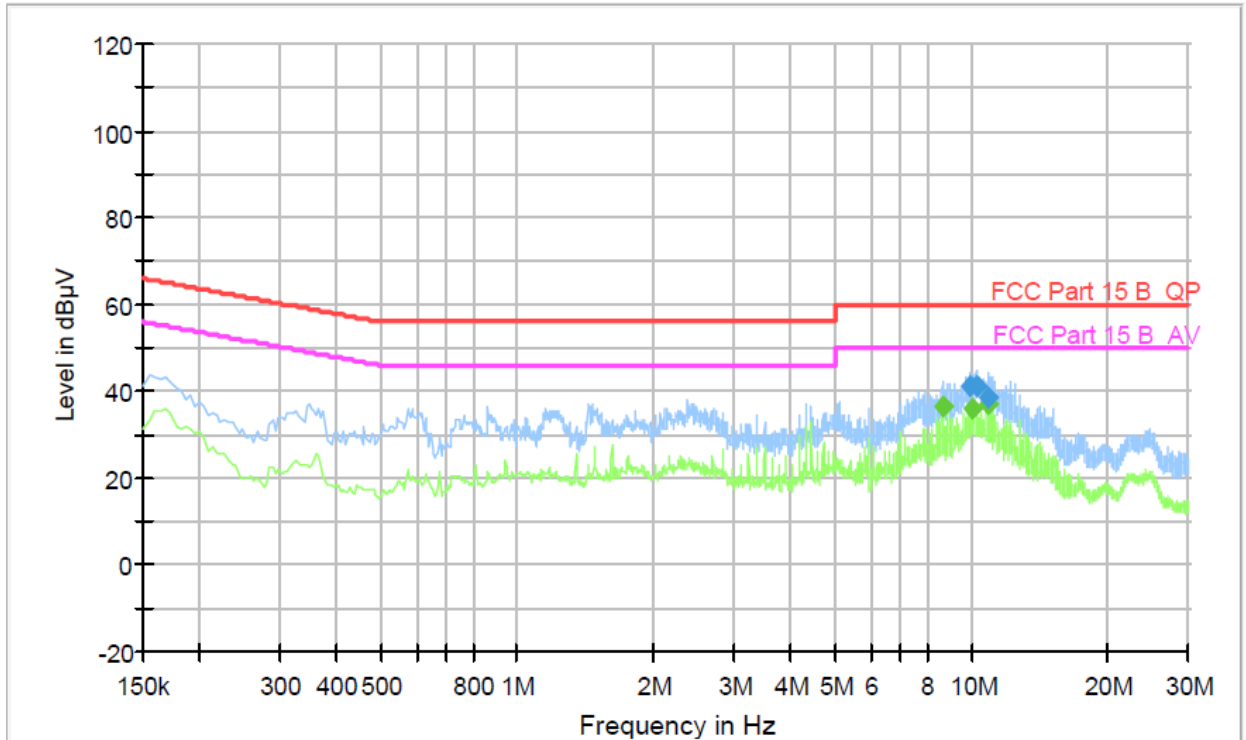

### Final Measurement Detector 1

Frequency (MHz)	QuasiPeak (dBµV)	Meas. Time (ms)	Bandwidth (kHz)	Filter	Line	Corr. (dB)	Margin (dB)	Limit (dBµV)	Comment
9.978000	41.0	1000.000	9.000	Off	N	9.7	19.0	60.0	
10.221000	41.3	1000.000	9.000	Off	N	9.7	18.7	60.0	
10.905000	38.8	1000.000	9.000	Off	N	9.7	21.2	60.0	

### Final Measurement Detector 2

Frequency (MHz)	Average (dBµV)	Meas. Time (ms)	Bandwidth (kHz)	Filter	Line	Corr. (dB)	Margin (dB)	Limit (dBµV)	Comment
8.632500	36.4	1000.000	9.000	Off	N	9.7	13.6	50.0	
10.099500	36.2	1000.000	9.000	Off	N	9.7	13.8	50.0	
10.923000	37.0	1000.000	9.000	Off	N	9.7	13.0	50.0	

## 4 RADIATED EMISSION MEASUREMENT

### 4.1 LIMITS OF RADIATED EMISSION MEASUREMENT

#### LIMITS OF RADIATED EMISSION MEASUREMENT (Below 1000MHz)

FREQUENCY (MHz)	Class A (at 10m)	Class B (at 3m)
	dBuV/m	dBu /m
30 ~ 88	39.0	40.0
88 ~ 216	43.5	43.5
216 ~ 960	46.5	46.0
Above 960	49.5	54.0

#### LIMITS OF RADIATED EMISSION MEASUREMENT (Above 1000MHz)

FREQUENCY (MHz)	Class A (at 3m) dBuV/m		Class B (at 3m) dBuV/m	
	Peak	Avg	Peak	Avg
Above 1000	80	60	74	54

Notes:

- (1) The limit for radiated test was performed according to as following:  
FCC PART 15B /ICES-003.
- (2) The tighter limit applies at the band edges.
- (3) Emission level (dBuV/m)=20log Emission level (uV/m).

### 4.2 TEST PROCEDURE

- a. The EUT was tested according to ANSI C63.4:2014.
- b. The measuring distance of at 3 m shall be used for measurements at frequency to 30MHz to 6GHz.
- c. The EUT was placed on the top of a rotating table 0.8 meters above the ground at a 3 meter test site. The table was rotated 360 degrees to determine the position of the highest radiation.
- d. The height of the equipment or of the substitution antenna shall be 0.8 m; the height of the test antenna shall vary between 1 m to 4 m. Both horizontal and vertical polarizations of the antenna are set to make the measurement.
- e. The initial step in collecting radiated emission data is a spectrum analyzer peak detector mode pre-scanning the measurement frequency range. Significant peaks are then marked and then Quasi Peak detector mode re-measured, above 1G Average detector mode will be instead.
- f. If the Peak Mode measured value compliance with and lower than Quasi Peak Mode Limit, the EUT shall be deemed to meet QP(AV) Limits and then no additional QP Mode measurement performed.
- g. For the actual test configuration, please refer to the related Item –EUT Test Photos.

### 4.3 TEST SETUP

(A) Radiated Emission Test Set-up, Frequency Below 1000MHz

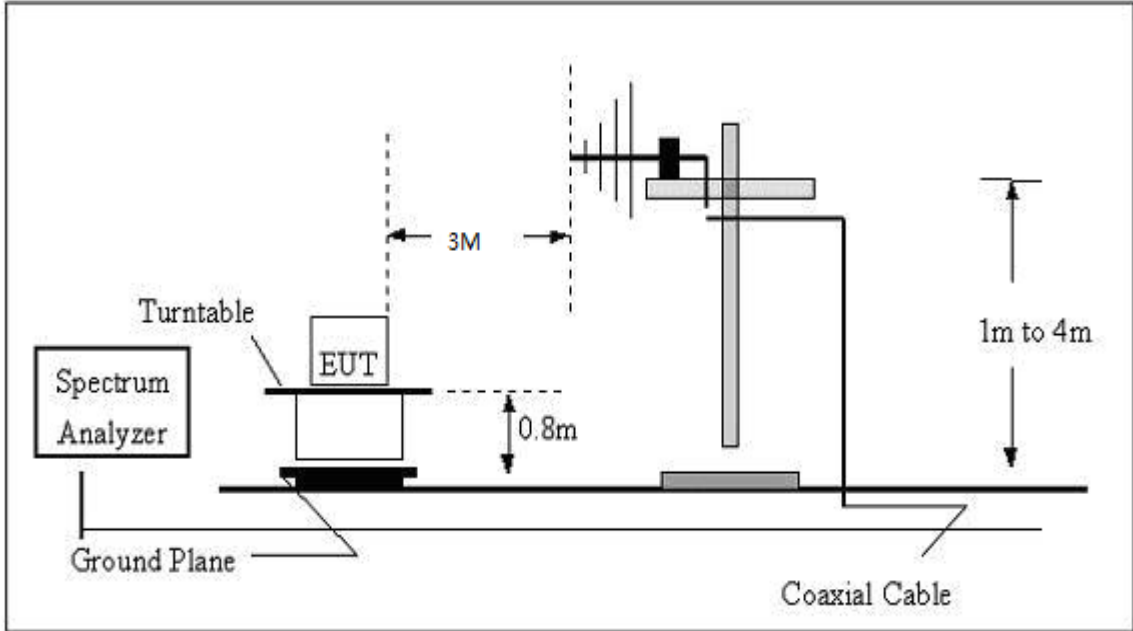

(B) Radiated Emission Test Set-up, Frequency Over 1GHz

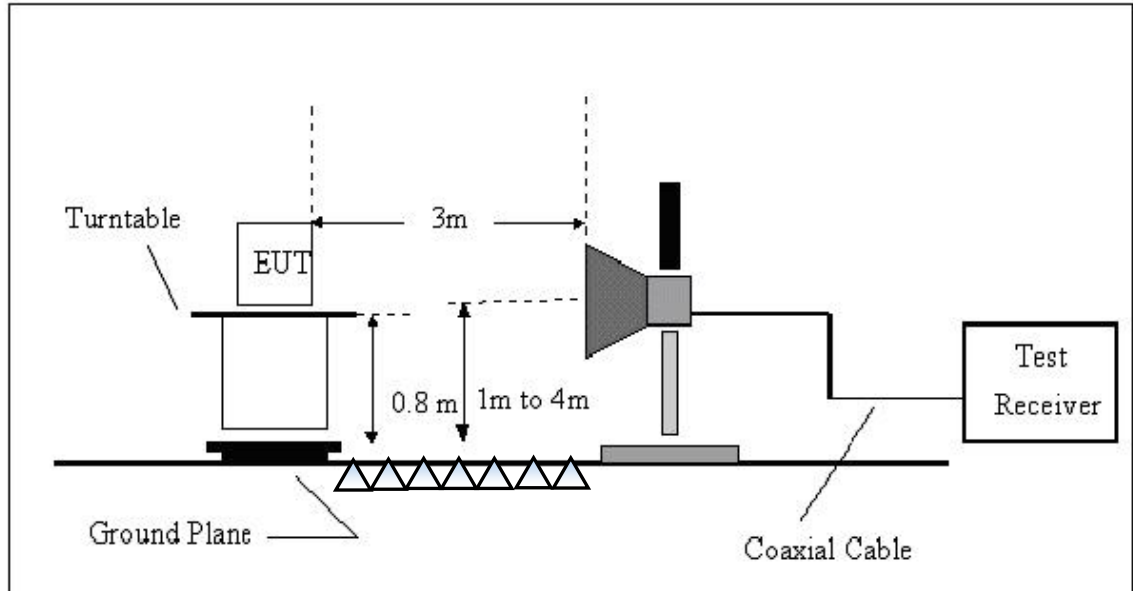

### 4.4 EUT OPERATING CONDITIONS

The EUT tested system was configured as the statements of 2.1 Unless otherwise a special operating condition is specified in the follows during the testing.

### 4.5 TEST RESULTS

Temperature:	25.0°C	Relative Humidity:	55%
Pressure:	101 Kpa	Test Mode:	Mode 2
Polarization:	Vertical	Test Power:	AC 120V/60Hz

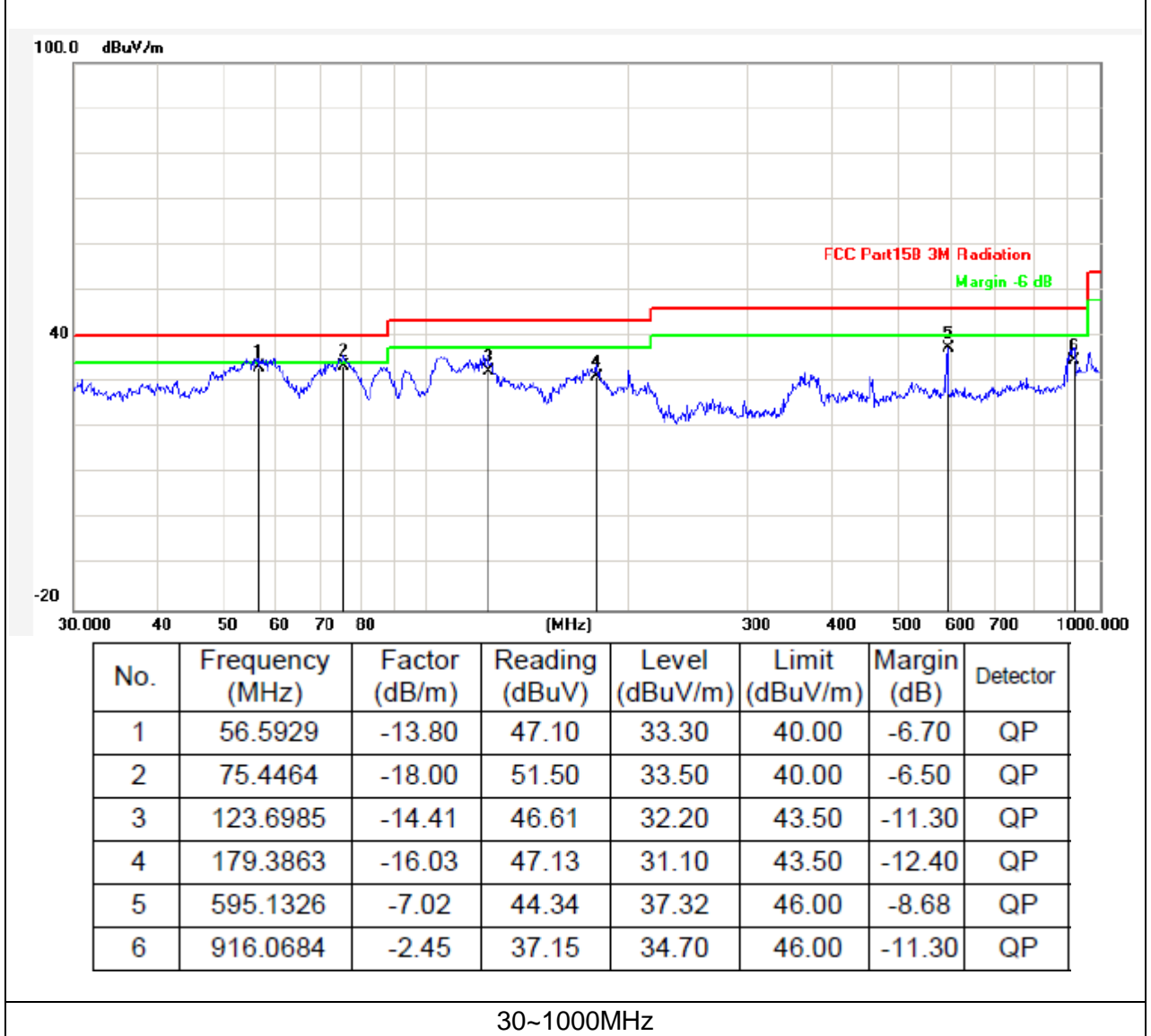



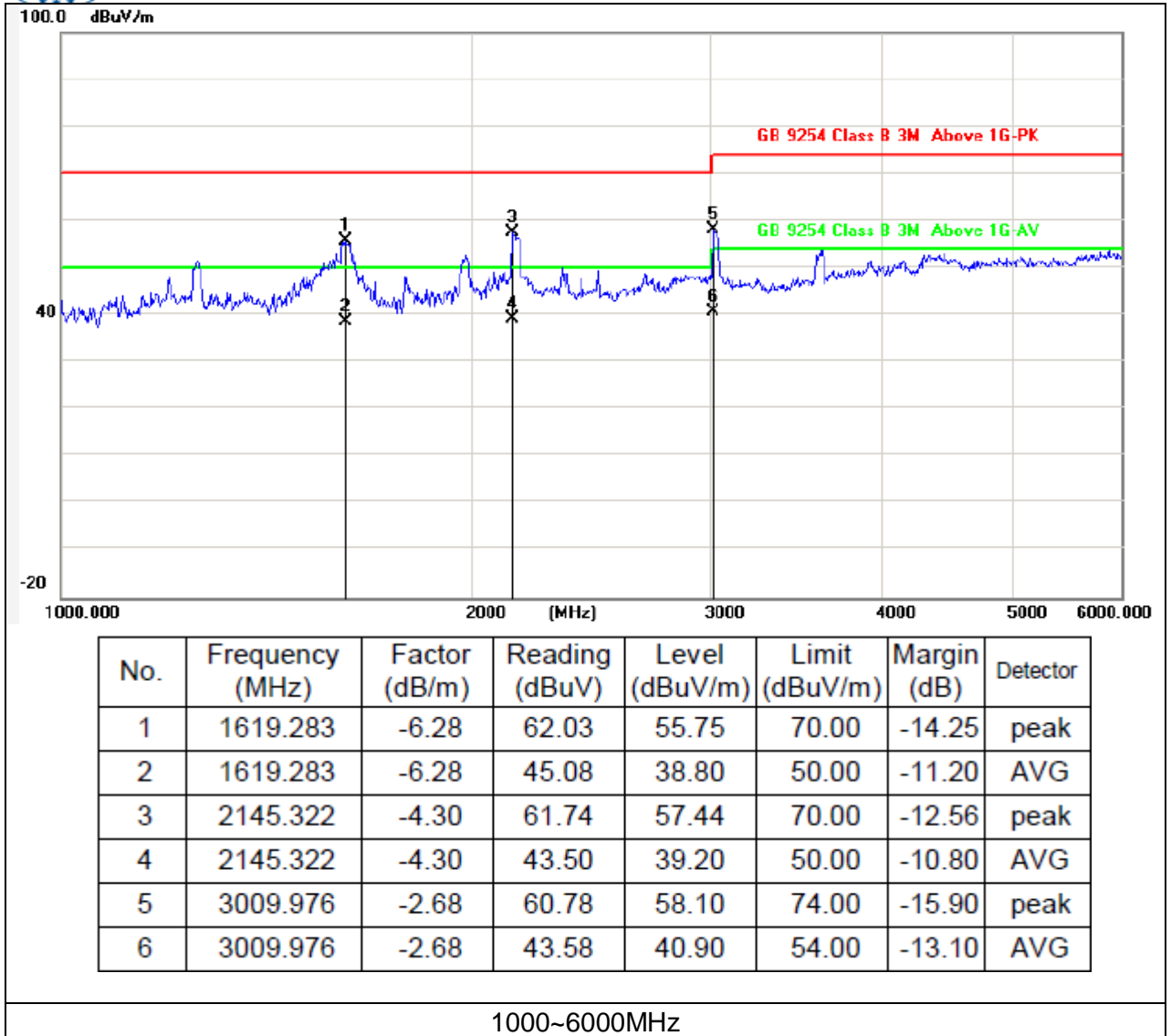

Shenzhen General Testing & Inspection Technology Co., Ltd.

1-2/F., Building 2, Jiaquan Building, Guanlan High-Tech Park, Shenzhen, Guangdong, China  
 Tel.: (86)755-27521059 Fax.: (86)755-27521011 Http://www.sz-ctc.org.cn



Temperature:	25.0°C	Relative Humidity:	55%
Pressure:	101 Kpa	Test Mode:	Mode 2
Polarization:	Horizontal	Test Power:	AC 120V/60Hz

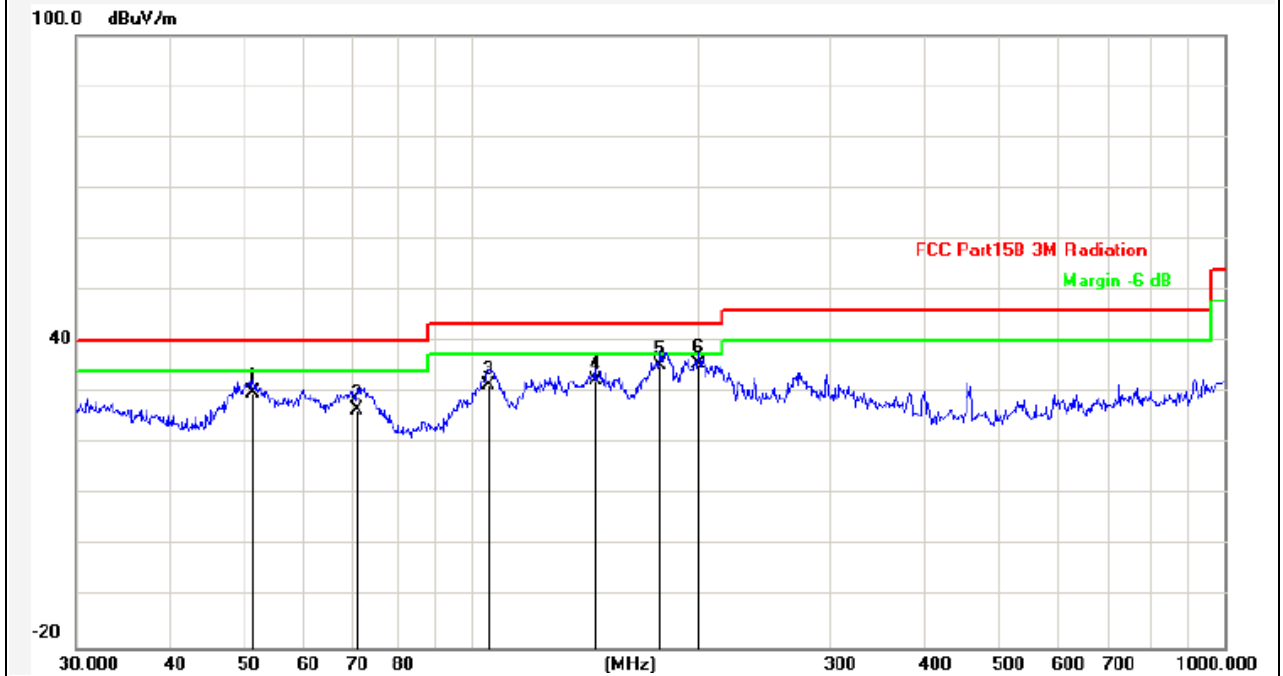

No.	Frequency (MHz)	Factor (dB/m)	Reading (dBuV)	Level (dBuV/m)	Limit (dBuV/m)	Margin (dB)	Detector
1	51.4806	-11.85	41.85	30.00	40.00	-10.00	QP
2	70.5835	-18.86	45.46	26.60	40.00	-13.40	QP
3	105.6415	-14.77	46.17	31.40	43.50	-12.10	QP
4	146.3734	-15.43	47.63	32.20	43.50	-11.30	QP
5	178.7584	-16.05	51.35	35.30	43.50	-8.20	QP
6	200.6880	-14.31	50.11	35.80	43.50	-7.70	QP

30~1000MHz

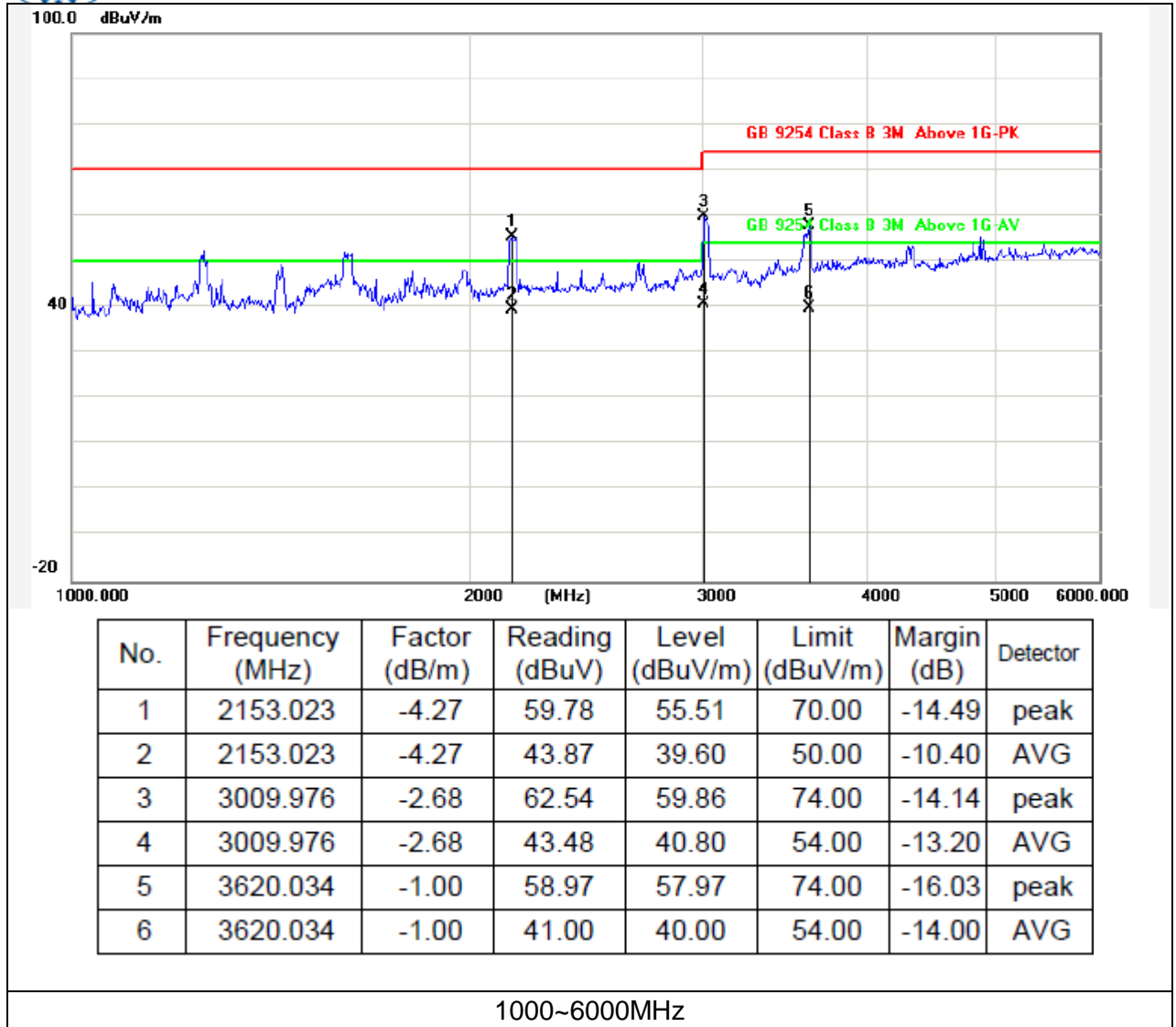

Shenzhen General Testing & Inspection Technology Co., Ltd.

1-2/F., Building 2, Jiaquan Building, Guanlan High-Tech Park, Shenzhen, Guangdong, China

Tel.: (86)755-27521059

Fax.: (86)755-27521011 [Http://www.sz-ctc.org.cn](http://www.sz-ctc.org.cn)



For anti-fake verification, please visit the official website of Certification and Accreditation Administration of the People's Republic of China : [yz.cncaic.cn](http://yz.cncaic.cn)

## 5 Antenna Power Conduction Measurement

Test Mode: Mode 4

Channel	Frequency (MHz)	Measured Frequency (MHz)	Reading (dB $\mu$ V)	Limit (dB $\mu$ V)	Margin (dB)
2	101.000	101.000	<30.0	50.0	<-20.0
	202.000	202.000	<30.0	50.0	<-20.0
3	107.000	107.000	<30.0	50.0	<-20.0
	214.000	214.000	<30.0	50.0	<-20.0
4	113.000	113.000	<30.0	50.0	<-20.0
	226.000	226.000	<30.0	50.0	<-20.0
5	123.000	123.000	<30.0	50.0	<-20.0
	246.000	246.000	<30.0	50.0	<-20.0
6	129.000	129.000	<30.0	50.0	<-20.0
	258.000	258.000	<30.0	50.0	<-20.0
7	221.000	221.000	<30.0	50.0	<-20.0
	442.000	442.000	<30.0	50.0	<-20.0
8	227.000	227.000	<30.0	50.0	<-20.0
	454.000	454.000	<30.0	50.0	<-20.0
9	233.000	233.000	<30.0	50.0	<-20.0
	466.000	466.000	<30.0	50.0	<-20.0
10	239.000	239.000	<30.0	50.0	<-20.0
	478.000	478.000	<30.0	50.0	<-20.0
11	245.000	245.000	<30.0	50.0	<-20.0
	490.000	490.000	<30.0	50.0	<-20.0
12	251.000	251.000	<30.0	50.0	<-20.0
	502.000	502.000	<30.0	50.0	<-20.0

Note: Negative signs (-) in the margin column signify levels below the limit.

Limit (50 dB $\mu$ V) was converted from the limit (2nW) at the 50  $\Omega$  measurement impedance.

Test Mode: Mode 4

Channel	Frequency (MHz)	Measured Frequency(MHz)	Reading (dB $\mu$ V)	Limit (dB $\mu$ V)	Margin (dB)
13	257.000	257.000	<30.0	50.0	<-20.0
	514.000	514.000	<30.0	50.0	<-20.0
14	517.000	517.000	<30.0	50.0	<-20.0
	1034.000	1034.000	<30.0	50.0	<-20.0
15	523.000	523.000	<30.0	50.0	<-20.0
	1046.000	1046.000	<30.0	50.0	<-20.0
20	553.000	553.000	<30.0	50.0	<-20.0
	1106.000	1106.000	<30.0	50.0	<-20.0
28	601.000	601.000	<30.0	50.0	<-20.0
	1202.000	1202.000	<30.0	50.0	<-20.0
36	649.000	649.000	<30.0	50.0	<-20.0
	1298.000	1298.000	<30.0	50.0	<-20.0
45	703.000	703.000	<30.0	50.0	<-20.0
	1406.000	1406.000	<30.0	50.0	<-20.0
53	751.000	751.000	<30.0	50.0	<-20.0
	1502.000	1502.000	<30.0	50.0	<-20.0
61	799.000	799.000	<30.0	50.0	<-20.0
	1598.000	1598.000	<30.0	50.0	<-20.0
69	847.000	847.000	<30.0	50.0	<-20.0
	1694.000	1694.000	<30.0	50.0	<-20.0

Note: Negative signs (-) in the margin column signify levels below the limit.

Limit (50 dB $\mu$ V) was converted from the limit (2nW) at the 50  $\Omega$  measurement impedance.

## 6 Antenna Power Conduction Measurement

Test Mode: Mode 5

Channel	Frequency (MHz)	Measured Frequency(MHz)	Reading (dB $\mu$ V)	Limit (dB $\mu$ V)	Margin (dB)
2	101.000	101.000	<30.0	50.0	<-20.0
	202.000	202.000	<30.0	50.0	<-20.0
3	107.000	107.000	<30.0	50.0	<-20.0
	214.000	214.000	<30.0	50.0	<-20.0
4	113.000	113.000	<30.0	50.0	<-20.0
	226.000	226.000	<30.0	50.0	<-20.0
5	123.000	123.000	<30.0	50.0	<-20.0
	246.000	246.000	<30.0	50.0	<-20.0
6	129.000	129.000	<30.0	50.0	<-20.0
	258.000	258.000	<30.0	50.0	<-20.0
7	221.000	221.000	<30.0	50.0	<-20.0
	442.000	442.000	<30.0	50.0	<-20.0
8	227.000	227.000	<30.0	50.0	<-20.0
	454.000	454.000	<30.0	50.0	<-20.0
9	233.000	233.000	<30.0	50.0	<-20.0
	466.000	466.000	<30.0	50.0	<-20.0
10	239.000	239.000	<30.0	50.0	<-20.0
	478.000	478.000	<30.0	50.0	<-20.0
11	245.000	245.000	<30.0	50.0	<-20.0
	490.000	490.000	<30.0	50.0	<-20.0
12	251.000	251.000	<30.0	50.0	<-20.0
	502.000	502.000	<30.0	50.0	<-20.0

Note: Negative signs (-) in the margin column signify levels below the limit.

Limit (50 dB $\mu$ V) was converted from the limit (2nW) at the 50  $\Omega$  measurement impedance.

Test Mode: Mode 5

Channel	Frequency (MHz)	Measured Frequency(MHz)	Reading (dB $\mu$ V)	Limit (dB $\mu$ V)	Margin (dB)
13	257.000	257.000	<30.0	50.0	<-20.0
	514.000	514.000	<30.0	50.0	<-20.0
14	517.000	517.000	<30.0	50.0	<-20.0
	1034.000	1034.000	<30.0	50.0	<-20.0
15	523.000	523.000	<30.0	50.0	<-20.0
	1046.000	1046.000	<30.0	50.0	<-20.0
20	553.000	553.000	<30.0	50.0	<-20.0
	1106.000	1106.000	<30.0	50.0	<-20.0
28	601.000	601.000	<30.0	50.0	<-20.0
	1202.000	1202.000	<30.0	50.0	<-20.0
36	649.000	649.000	<30.0	50.0	<-20.0
	1298.000	1298.000	<30.0	50.0	<-20.0
45	703.000	703.000	<30.0	50.0	<-20.0
	1406.000	1406.000	<30.0	50.0	<-20.0
53	751.000	751.000	<30.0	50.0	<-20.0
	1502.000	1502.000	<30.0	50.0	<-20.0
61	799.000	799.000	<30.0	50.0	<-20.0
	1598.000	1598.000	<30.0	50.0	<-20.0
69	847.000	847.000	<30.0	50.0	<-20.0
	1694.000	1694.000	<30.0	50.0	<-20.0

Note: Negative signs (-) in the margin column signify levels below the limit.  
 Limit (50 dB $\mu$ V) was converted from the limit (2nW) at the 50  $\Omega$  measurement impedance.

## 7 Picture Sensitivity Measurement

Test Mode: Mode 4

VHF Band		Antenna Input Level (dBμV)	UHF Band		Antenna Input Level (dBμV)
Channel	Frequency Range (MHz)		Channel	Frequency Range (MHz)	
2	55.250	23	14	471.250	28
3	61.250	26	20	507.250	27
4	67.250	25	26	543.250	28
5	77.250	27	32	579.250	28
6	83.250	24	38	615.250	26
7	175.250	28	44	651.250	27
8	181.250	23	50	687.250	26
9	187.250	25	56	723.250	28
10	193.250	26	62	759.250	25
11	199.250	23	69	801.250	24
12	205.250	24	/	/	/
13	211.250	29	/	/	/
Average(VHF)		25.25	Average(UHF)		26.70
Average(UHF)-Average(VHF)=1.45 dB(Limit 8.0dB)					

## 8 Noise Figure Measurement

Test Mode: Mode 4

Channel	Measured Frequency (MHz)	Gain (dB)	Noise Figure (dB)	Limit (dB)
14	471.250	>30.0	4.4	14
20	507.250	>30.0	4.0	14
26	543.250	>30.0	4.3	14
32	579.250	>30.0	4.2	14
38	615.250	>30.0	4.6	14
44	651.250	>30.0	4.3	14
50	687.250	>30.0	4.4	14
56	723.250	>30.0	4.0	14
62	759.250	>30.0	4.1	14
69	801.250	>30.0	4.3	14

Remark: The specification was provided by tuner manufacturer.



## 9 EUT TEST PHOTO

### Conducted Measurement Photo

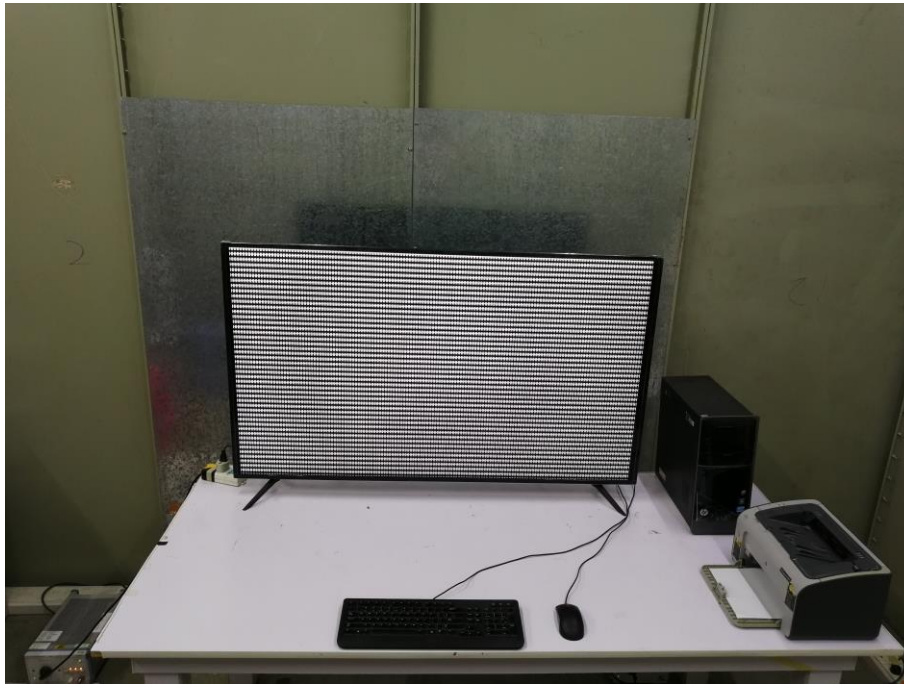

### Radiated Measurement Photo (30~1000MHz)



**Radiated Measurement Photo (1000~6000MHz)**



## 10 ATTACHMENT PHOTOGRAPHS OF EUT

### 1. Photo



### 2. Photo





3. Photo



4. Photo



5. Photo

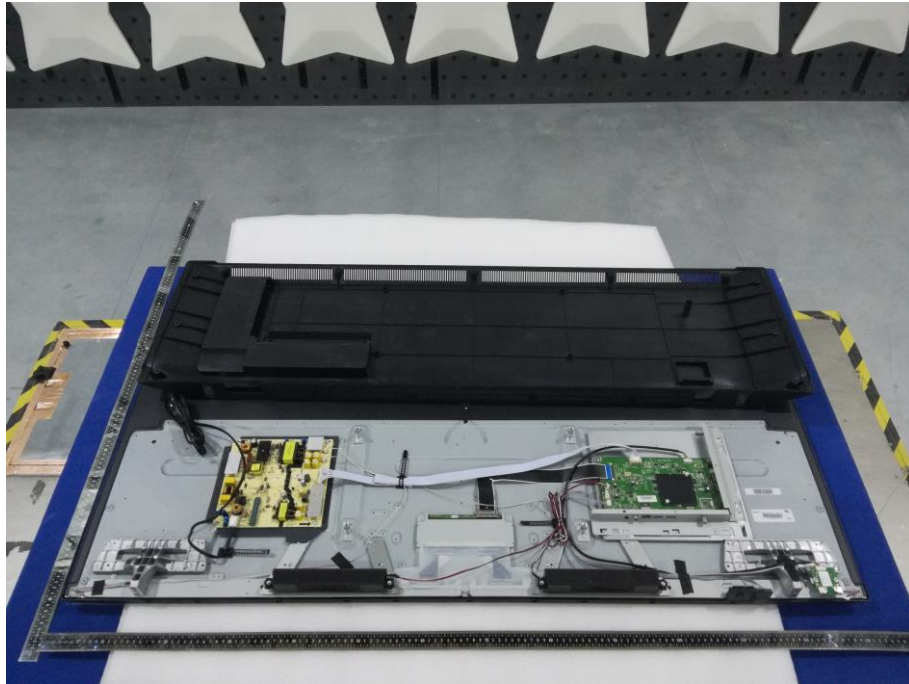

6. Photo

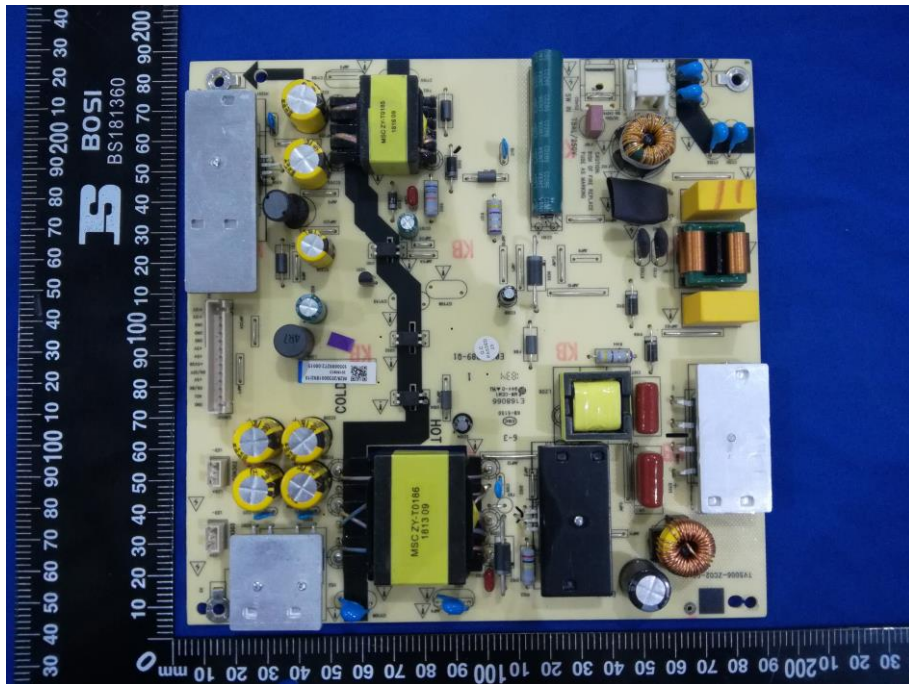



### 7. Photo

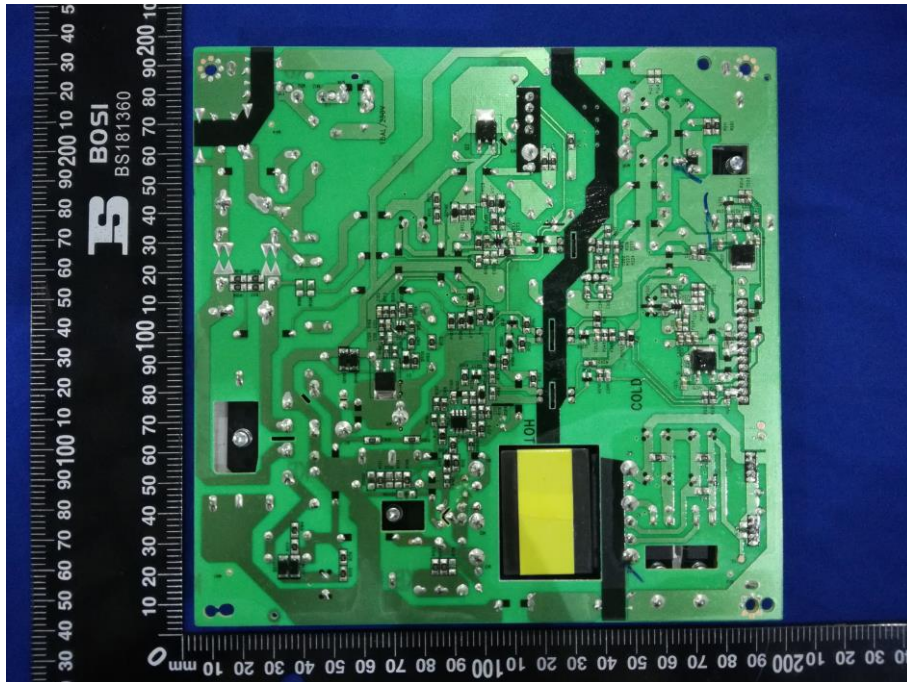

### 8. Photo

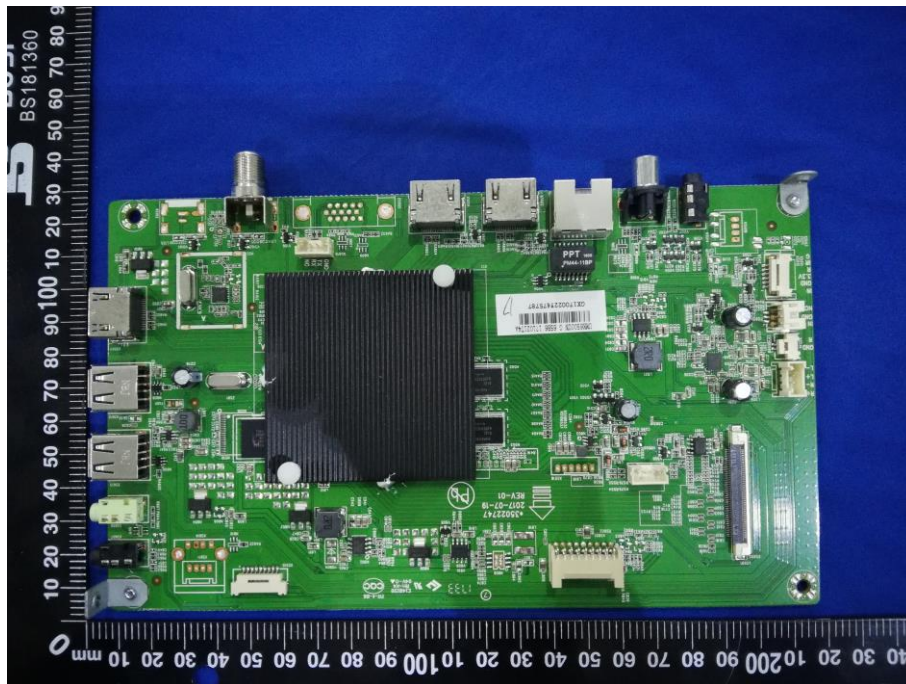

Shenzhen General Testing & Inspection Technology Co., Ltd.

1-2/F., Building 2, Jiaquan Building, Guanlan High-Tech Park, Shenzhen, Guangdong, China  
Tel.: (86)755-27521059 Fax.: (86)755-27521011 Http://www.sz-ctc.org.cn

9. Photo

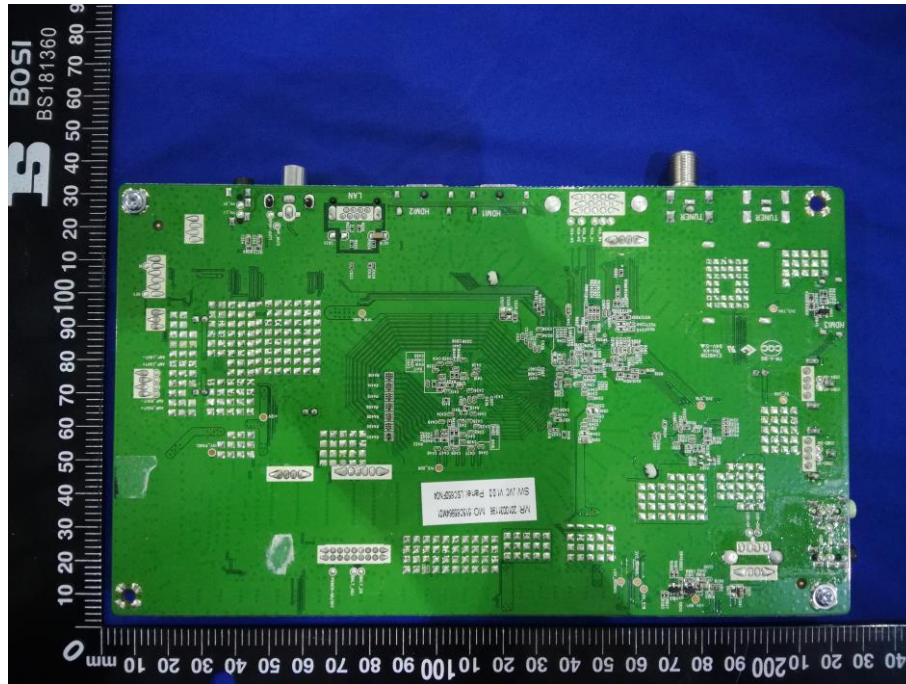

10. Photo

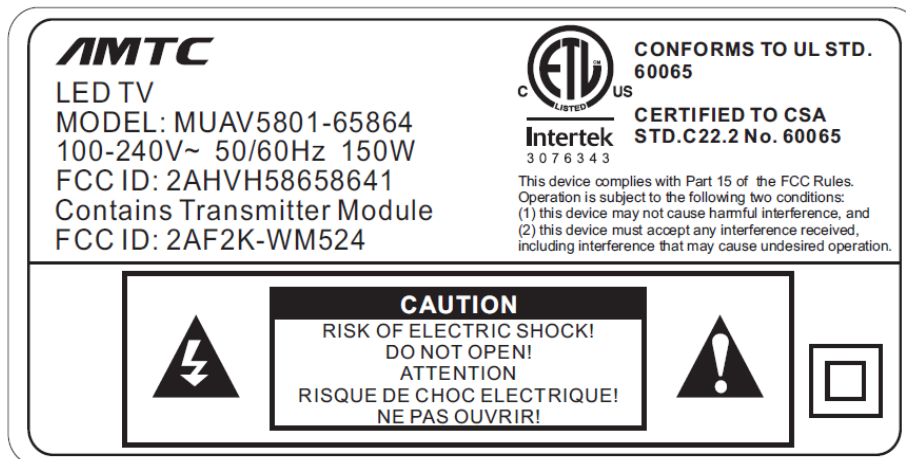

==== End of Test Report ====