

The logo for AMTC, featuring the letters 'AMTC' in a bold, italicized, sans-serif font. The logo is positioned in the upper center of the page, with a large black curved shape in the top-left corner of the page.

LED TV

USER MANUAL
MUA4360Y-65864

Please read this User Manual carefully to ensure use of this product and keep this manual for future reference

A large black curved shape in the bottom-right corner of the page, mirroring the shape in the top-left corner.



Contents

Safety and warnings.....	1-3
Introduction.....	4
Installation.....	5-8
Wall Mount.....	9
General Description.....	10-13
External Connection.....	14-17
Basic Operations.....	18-19
Menu System Instruction.....	20-37
Digital Media Player.....	38
Trouble Shooting.....	39-40
Reference.....	41

IMPORTANT SAFETY INSTRUCTION

- 1) Read these instructions.
 - 2) Keep these instructions.
 - 3) Heed all warnings.
 - 4) Follow all instructions.
 - 5) Do not use this apparatus near water.
 - 6) Clean only with dry cloth.
 - 7) Do not block any ventilation openings, install in accordance with the instructions.
 - 8) Do not install near any heat sources such as radiations, heat registers, stoves, or other apparatus (including amplifiers) that produce heat.
 - 9) Do not defeat the safety purpose of the polarized plug. If the provided plug does not fit into your outlet, consult an electrician for replacement of the obsolete outlet.
 - 10) Protected the power cord from being walked on or pinched particularly at plugs, convenience receptacles, and the point where they exit from the apparatus.
 - 11) Only use attachments/accessories specified by the manufacturer.
 - 12) Unplug this apparatus during lightning storms or when unused for long periods of time.
 - 13) Refer all servicing to qualified service personnel. Servicing is required when the apparatus has been damaged in any way, such as power-supply cord or plug is damaged, liquid has been spilled or objects have fallen into the apparatus, the apparatus has been exposed to rain or moisture, does not operate normally, or has been dropped.
 - 14) Mains plug is used as the disconnect device, the disconnect device shall remain readily operable.
 - 15) The ventilation should not be impeded by covering the ventilation openings with items, such as newspapers, table-cloth, curtains, etc.
 - 16) No naked flame sources, such as lighted candles, should be placed on the apparatus.
 - 17) Attention should be drawn to the environmental aspects of battery disposal.
 - 18) The use of apparatus in moderate climate.
 - 19) The apparatus shall not be exposed to dripping or splashing and that no objects filled with liquids, such as vases, shall be placed on the apparatus.
- Warning: To avoid any injury caused by lean of the product, please always ensure the whole product was placed within the table surface in horizontal.

WARNING

Never place a television set in an unstable location. A television set may fall, causing serious personal injury or death. Many injuries, particularly to children, can be avoided by taking simple precautions such as:

- Using cabinets or stands recommended by the manufacturer of the television set.
- Only using furniture that can safely support the television set.
- Ensuring the television set is not overhanging the edge of the supporting furniture.
- Not placing the television set on tall furniture (for example, cupboards or bookcases) without anchoring both the furniture and the television set to a suitable support.
- Not placing the television set on cloth or other materials that may be located between the television set and supporting furniture.
- Educating children about the dangers of climbing on furniture to reach the television set or its controls.

If your existing television set is being retained and relocated, the same considerations as above should be applied.

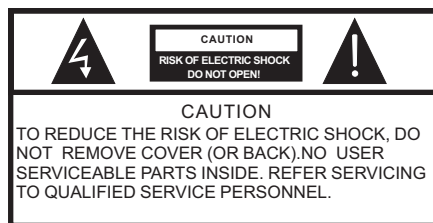

 The symbol indicates that dangerous voltages constituting a risk of electric shock are present within this unit.

 The symbol indicates that there are important operating and maintenance instructions in the literature accompanying this unit.

WARNING:

To reduce the risk of fire or electric shock, do not expose this apparatus to rain or moisture.

WARNING:

The batteries shall not be exposed to excessive heat such as sunshine, fire or the like.



This symbol indicates that this product incorporates double insulation between hazardous mains voltage and user accessible parts. When servicing use only identical replacement parts.



This marking indicates that this product should not be disposed with other household wastes throughout the EU. To prevent possible harm to the environment or human health from uncontrolled waste disposal, recycle it responsibly to promote the sustainable reuse of material resources. To return your used device, please use the return and collection systems or contact the retailer where the product was purchased. They can take this product for environmental safe recycling.

Step one: Use the expansion bolts(4*36PWA) to fix the wall mount brackets into the wall

Step Two: Fix the wall mount screws (M6x8mm/4pcs) into the rear side of the LCD TV,using the tongue of 8kgf.cm.

* The TV appearance subject to material object.

Step Three: Put the LCD TV with wall mount screws onto the wall mount brackets.

Warning: the angle between the TV and wall must not be bigger than 3°.

Warning: Changes or modifications to this unit not expressly approved by the party responsible for compliance

could void the user's authority to operate the equipment.

NOTE: This equipment has been tested and found to comply with the limits for a Class B digital device, pursuant to Part 15 of the FCC Rules.

These limits are designed to provide reasonable protection against harmful interference in a residential installation.

This equipment generates, uses and can radiate radio frequency energy and, if not installed and used in accordance

with the instructions, may cause harmful interference to radio communications.

However, there is no guarantee that interference will not occur in a particular installation. If this equipment does cause harmful interference to radio or television reception, which can be determined by turning the equipment off and on, the user is encouraged to try to correct the interference by one or more of the following measures:

- o Reorient or relocate the receiving antenna.
 - o Increase the separation between the equipment and receiver.
 - o Connect the equipment into an outlet on a circuit different from that to which the receiver is connected.
- Consult the dealer or an experienced radio/TV technician for help.

This device complies with Part 15 of the FCC Rules.

Operation is subject to the following two conditions:
(1) this device may not cause harmful interference, and

(2) this device must accept any interference received, including interference that may cause undesired operation.

SAFETY AND WARNINGS

IMPORTANT SAFETY INSTRUCTIONS

Important Safety Instructions

- 1) Read these instructions.
- 2) Keep these instructions.
- 3) Heed all warnings.
- 4) Follow all instructions.
- 5) Do not use this apparatus near water.
- 6) Clean only with **non abrasive** dry cloth.
- 7) Do not block any ventilation openings, install in accordance with the instructions.
- 8) Do not install near any heat sources such as **radiators**, heat registers, stoves, or other apparatus (including amplifiers) that produce heat.
- 9) Do not defeat the safety purpose of the polarized plug. If the provided plug does not fit into your outlet, consult an electrician for replacement of the obsolete outlet.
- 10) **Protect** the power cord from being walked on or pinched particularly at plugs, convenience receptacles, and the point where they exit from the apparatus.
- 11) Only use attachments/accessories specified by the manufacturer.
- 12) Unplug this apparatus during lightning storms or when unused for long periods of time.
- 13) Refer all servicing to qualified service personnel. Servicing is required when the apparatus has been damaged in any way, such as **when** power-supply cord or plug is damaged, liquid has been spilled or objects have fallen into the apparatus, the apparatus has been exposed to rain or moisture, does not operate normally, or has been dropped.
- 14) Mains plug is used as the disconnect device, the disconnect device shall remain readily operable.
- 15) Do not **cover** the ventilation openings with items such as newspapers, table-cloth, curtains, etc.
- 16) No naked flame sources, such as lighted candles, should be placed on the apparatus.
- 17) Attention should be drawn to the environmental aspects of battery disposal.
- 18) **Use** apparatus in moderate climate.
- 19) The apparatus shall not be exposed to dripping or splashing and that no objects filled with liquids, such as vases, shall be placed on the apparatus.
- 20) Use only with a cart, stand, tripod, bracket, or table specified by the manufacturer, or sold with the apparatus. When a cart is used, use caution when moving the cart/apparatus combination to avoid injury from tip-over.



The symbol indicates that dangerous voltages constituting a risk of electric shock are present within this unit.



The symbol indicates that there are important operating and maintenance instructions in the literature accompanying this unit.

WARNING:

To reduce the risk of fire or electric shock, do not expose this apparatus to rain or moisture.

WARNING:

The batteries shall not be exposed to excessive heat such as, fire or the like.

WARNING:

The excessive sound pressure from earphones and headphones can cause hearing loss.



This symbol indicates that this product incorporates double insulation between hazardous mains voltage and user accessible parts. When servicing use only identical replacement parts.



This marking indicates that this product should not be disposed with other household wastes. To prevent possible harm to the environment or human health from uncontrolled waste disposal, recycle it responsibly to promote the sustainable reuse of material resources. To return your used device, please use the return and collection systems or contact the retailer where the product was purchased. They can take this product for environmental safe recycling.

SAFETY AND WARNINGS

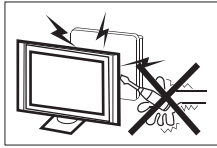

High voltages are used in the operation of this television receiver. Do not remove the cabinet back from your set. Refer servicing to qualified service personnel.

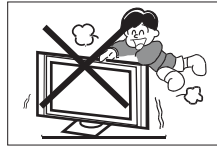

Never stand on, lean on, or suddenly push the television or its stand. You should pay special attention to children. Serious injury may result if it falls.

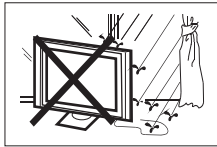

To prevent fire or electrical shock hazard, do not expose the television receiver to rain or moisture.

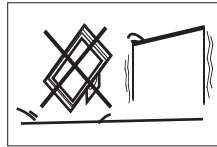

Do not place your television on an unstable cart, stand, shelf or table. Serious injury to an individual, and damage to the television, may result if it falls. Recommended to utilize rear mount screw holes for anti-tipping (hardware not included).



Do not drop or push objects into the television cabinet slots or openings. Never spill any kind of liquid on the television receiver.

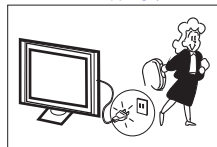

When the television receiver is not used for an extended period of time, it is advisable to disconnect the AC power cord from the AC outlet.



Do not block the ventilation holes in the back cover. Adequate ventilation is essential to prevent failure of electrical components.

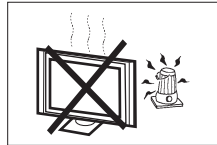

Avoid exposing the television receiver to direct sunlight and other sources of heat. Do not stand the television receiver directly on other products which give off heat, e.g. video cassette players and audio amplifiers. Do not place naked flame sources, such as lighted candles on the television.



Do not trap the power supply cord under the television receiver.

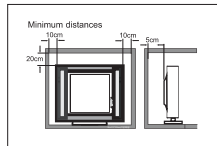

If the television is to be built into a compartment or similar enclosure, the minimum distances must be maintained. Heat build-up can reduce the service life of your television, and can also be dangerous.

INTRODUCTION

Antenna

Main features

- 43" wide screen for a complete home theater experience
- Super slim LCD TV with LED backlight
- 3840 x 2160 native resolution for UHD performance
- Integrated ATSC TV tuner for HDTV broadcast reception
- Beautiful color depth with a contrast ratio of 1200:1
- HDMI® inputs for true digital connections

Accessories

Infrared Remote Control.....	1
User's Manual	1
Battery(AAA)	2
Screws.....	4
Base stand.....	2
Component adaptor cable.....	2

Specifications

Resolution:	3840 x 2160
AspectRatio:	16:9
TV System:	ATSC Digital system and NTSC Analog system
Video Signal System:	NTSC
Receiving Channel:	Cable :1-135/ Air: 2-69(ATV&DTV)
Maximum Power Consumption:	70W
Input Power Voltage:	AC 100-240V 50/60Hz
Audio OutputPower(THD≤ 7%):	2 x 8W
High-Definition Multimedia Interface(HDMI)Input	x 3
YCb(Pb)Cr(Pr)Input	x 1
Composite Video Input	x 1
Audio Input	x 1
Headphone Output	x 1
Coaxial	x 1
LAN	x 1
USB 2.0 Input	x 2



The terms HDMI and HDMI High-Definition Multimedia Interface, and the HDMI Logo are trademarks or registered trademarks of HDMI Licensing Administrator, Inc. in the United States and other countries.

Manufactured under license from Dolby Laboratories. Dolby, Dolby Audio, and the double-D symbol are trademarks of Dolby Laboratories.

"This product is manufactured, distributed, serviced and warranted exclusively by SHENZHEN MTC CO., LTD.. "JVC" is the trademark of JVC KENWOOD Corporation, used by such company under license."

INSTALLATION

Front panel

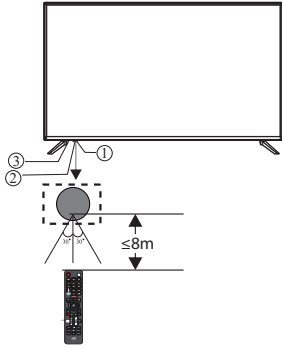

- 1: Remote control sensor.
- 2: Indicator LED: RED ● STANDBY.
- 3: Key board

KEYBOARD

The keyboard is located at the bottom left near the right side of signal indicator.

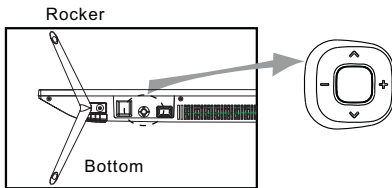

- 1. Middle Button: press longtime for "power" function; press once for "source" function
- 2. Up/Down: CH+/-
- 3. Left/Right: VOL-/+

REAR Connections



All the terminals are(from left to right): HEADPHONE, COAXIAL, LAN, HDMI3, HDMI2, RF.

SIDE Connections



All the terminals are (from left to right):

HDMI1(ARC), USB2.0, VIDEO/YPbPr, AUDIO.

INSTALLATION

Antenna

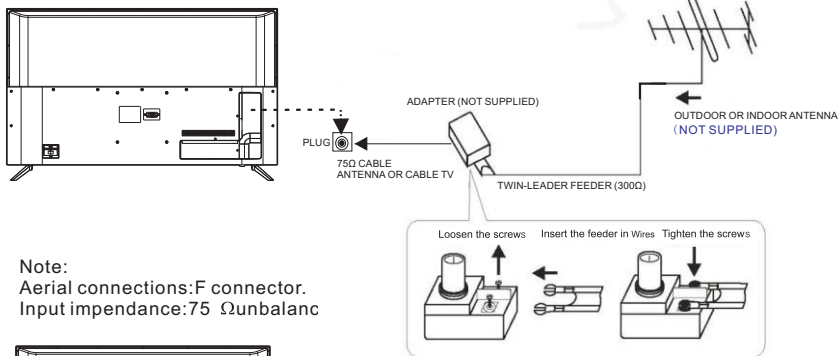

Note:
Aerial connections:F connector.
Input impedance:75 Ωunbalanc

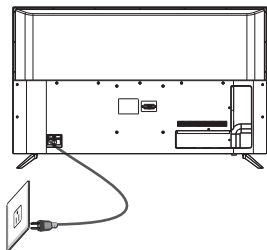

Power connection

Please note: After unpacking, allow the TV to reach ambient room temperature before connection the TV to the mains power socket.
Connect the power cord plug to the mains power socket.

PRESET MODE (HDMI)

	RESOLUTION	V.Freq.(Hz)	H.Freq.(KHz)
1	800*600	60	37.88
2	1024*768	60	48.36
3	1366*768	60	47.7
4	1280*768	60	47.3
5	1920*1080	60	67.5
6	3840*2160	30	67.5
7	3840*2160	50	112.5
8	3840*2160	60	135

CABLE

When shipped from the factory, the Signal Type option is for the RF connector (F-type) set to the "AIR" (Over-the air antenna) mode.

INSTALLATION

Base Stand Assembly Instruction

The base stand

Prepare to place the TV with the display side down on a flat surface. Due to the size and weight of this TV, the use of 2 people is recommended when moving it. Ensure the table or desk you use provides a flat, totally clean surface, and use a soft cloth between the face of the TV and the table to protect the TV's screen.

1. Locate the 2PCS of the base stand and **insert it into** the gap in the bottom of the TV , and check that it is securely held in place as per a) below.

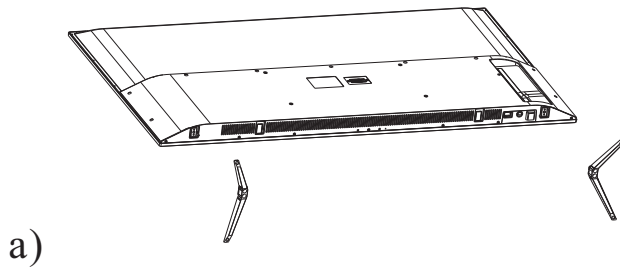

2. Lock 4 screws in the designated location as per b) below and check each screw is firmly tightened

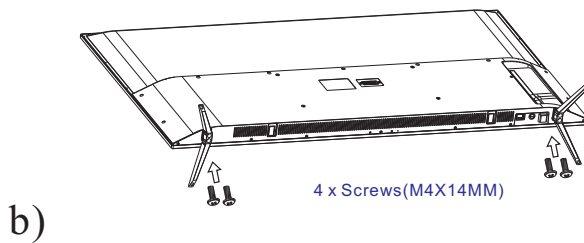

INSTALLATION

AV Equipment

You can use the **rear** input terminals as follows.

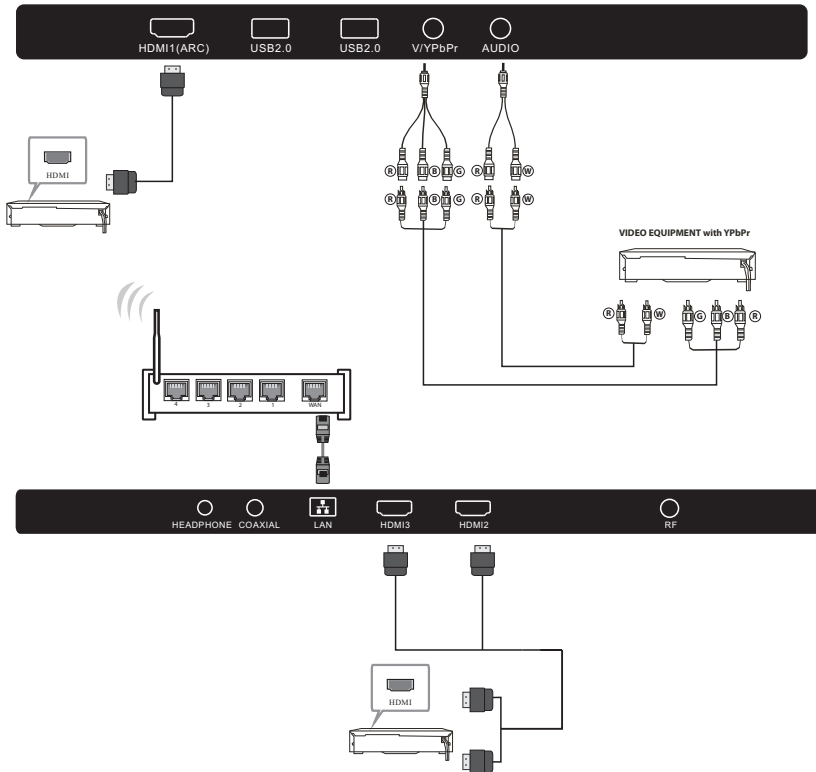

Video Equipments: VCR, Multi Disc Player, DVD Player, Camcorder, Video Game, etc.
Video format that YPbPr supports: 480i, 576i, 480p, 720p, 1080i, 1080p, 2160p.

Wall Mount

Instruction for Wall Mount

A wall mount kit (purchased separately) would allow you to mount your JVC TV on the wall. For detailed information on installing the wall mount, refer to the instructions provided by the wall mount manufacturer. It is strongly recommended to contact a technician for professional assistance for wall mount installation. JVC is not responsible for any damage to the product or injury to yourself or others resulting from the wall-mounting.

Dimensions for Mounting Hole Pattern

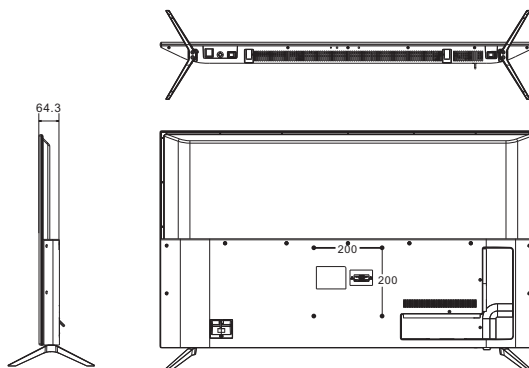

This JVC TV is compatible with a **200mm x 200mm** mounting hole pattern.

- 4 pcs of type M6 screws are required for installing the wall mount bracket to your JVC TV. Do not use screws that are longer than 10 mm. Screws that are too long may cause damage to the inside of the TV set.
- Do not fasten the screws too tight for this may damage the TV or cause the TV to fall, resulting in personal injury. JVC is not liable for these kinds of incidents.
- Do not mount your JVC TV at more than a 15 degree tilt.
- Always use two people to mount the TV to a wall.
- Do not install your Wall Mount Kit while your TV is turned on. It may result in personal injury due to electric shock.

General Description

Overview of remote control

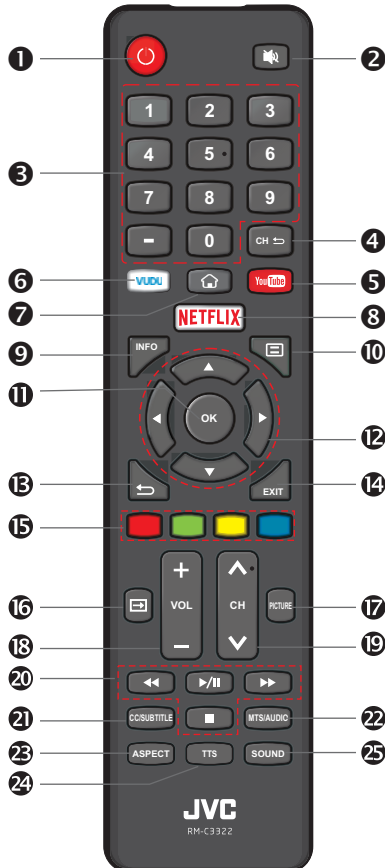

Loading batteries:

- 1) Remove the lid of the battery compartment.
- 2) Insert 2 size AAA batteries with polarities as indicated inside the compartment.
- 3) Replace the lid.

Note:

- 1) A loading of batteries should be last one year under normal use.
- 2) If you don't intend to use the remote control for a long period of time, remove batteries to avoid damage due to leakage.
- 3) Do not mix old and new batteries or different types.
- 4) Do not throw batteries into fire or water.
- 5) The batteries (battery pack or batteries installed) should not be exposed to excessive heat such as sunshine, fire or the like.

General Description

Overview of remote control

1. **POWER:** Turn the TV on and off.
2. **MUTE:** Press this button to cut off the sound of the TV set temporarily, press again to resume.
3. **Digital Buttons(0-9, -):** Directly select channel with digital buttons.
4. **CH ↵:** Switch to the previous program.
5. **YouTube:** If network connects, press this key to view YouTube directly.
6. **VUDU:** Press it to show channel list and favorite list on screen.
7. **🏠:** Press it to go to App home page.
8. **NETFLIX:** If network connects, press this key to view NETFLIX directly.
9. **INFO:** Display the program information.
10. **☰:** Display the main menu or exit the current menu.
11. **OK:** Validation key.
12. **Arrow buttons ▲▼◀▶:** Use to select on-screen menu items and change menu values.
13. **↶:** Return.
14. **EXIT:** Exit the menu.
15. **COLOR BUTTONS:** It's used as it's showed in the EPG or Program Edit menu.
16. **☰:** This button is used to switch among different sources, Select a source and press OK button to confirm

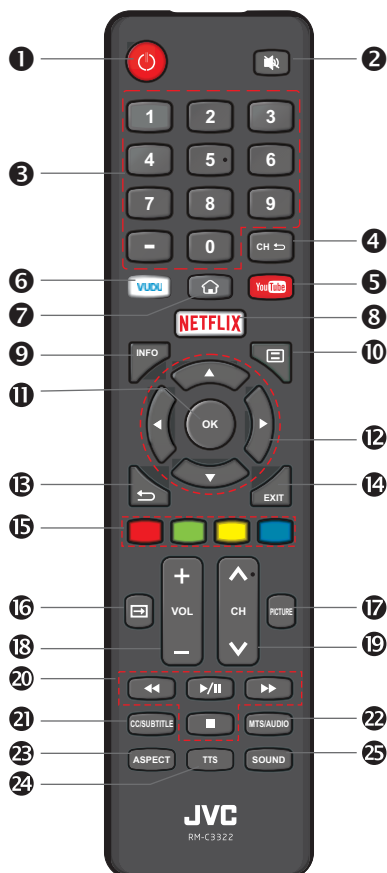

General Description

Overview of remote control

17. **PICTURE:** Select picture mode.
18. **VOL+/-:** Press these buttons to adjust the volume.
19. **CH \wedge /v:** Press these buttons to change channel upward or downward.
20. **DIGITAL MEDIA PLAYER CONTROL BUTTON:** Include play/pause, stop, backward, forward is used in USB mode. Please refer to relevant instructions in the section of multimedia player.
21. **CC/SUBTITLE:** In USB mode, press this button to switch subtitles when movie is playing.
22. **MTS/AUDIO:** In USB mode, press this button to switch audio track when movie is playing. In TV mode, press this button to switch MTS or Audio Language.
23. **ASPECT:** Press this button to set aspect, such as 16:9,4:3,native,ect.
24. **TTS:** Press this button to set TTS on or off.
25. **SOUND:** Press this button to select sound mode.

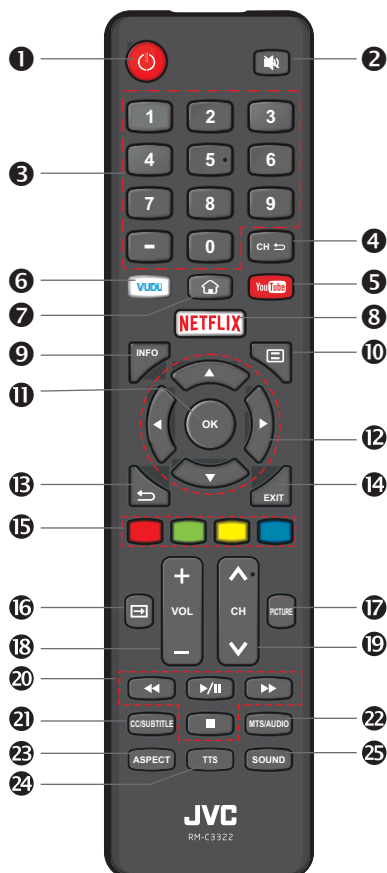

General Description

Installing Batteries in the Remote Control

Installing Batteries

- 1** Open the battery compartment cover on the back side.

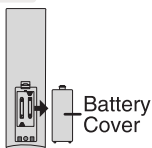

- 2** Insert two 1.5V AAA size batteries in correct polarity. Don't mix old or used batteries with new ones.

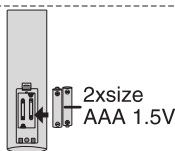

- 3** Closed the cover.

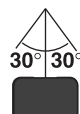
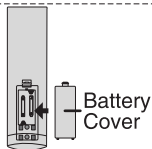

- ✦ Point the remote towards the remote control sensor of the TV and use it within 8 meters.
- ✦ Put the used batteries into the recycling bin since they can negatively affect the environment.

Note:

- One loading of batteries will last for 1 year under normal use.
- If you do not intend to use the remote controller for a long period of time, remove them to avoid damage due to leakage.
- Do not use old and new batteries together.
- The batteries (battery pack or batteries installed) shall not be exposed to excessive heat such as sunshine, fire or the like.

External Connection

Antenna connection

Antenna input impedance of this unit is 75ohm. VHF/UHF 75ohm coaxial cable can be connected to the antenna jack directly, if the antenna cable is 300ohm parallel flat feeder cable, you need to use the 300ohm/75ohm converter to connect the antenna cable to the antenna jack. For details Please refer to the following drawing.

Antennas with 300 Ω flat twins Leads

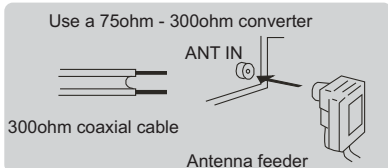

Antennas with 75 Ω Round Leads

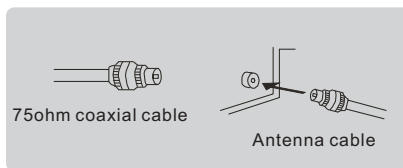

External Connection

Connecting VCR

These instructions assume that you have already connected your TV to an antenna or a cable TV system. Skip step 1 if you have not yet connected to an antenna or a cable system.

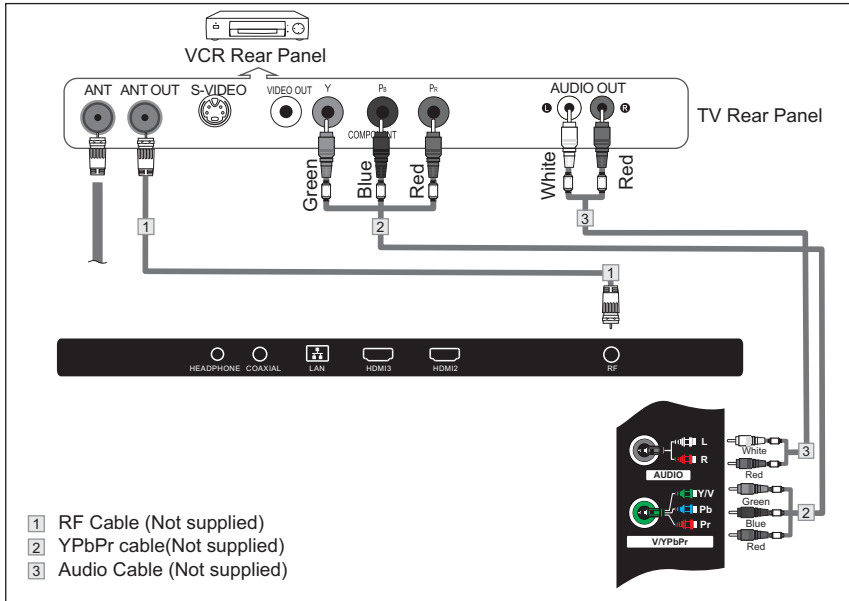

Follow the instructions in Viewing a VCR or Camcorder Tape to view your VCR tape.

Each VCR has a different back panel configuration.

When connecting a VCR, match the color of the connection terminal to the cable.

1. Unplug the cable or antenna from the back of the TV.
2. Connect the cable or antenna to the ANT IN terminal on the back of the VCR.
3. Connect an RF Cable between the ANT OUT terminal on the VCR and the ANT IN terminal on the TV.
4. Connect a Component Cable between the COMPONENT [Y, Pb, Pr] jacks on the DVD player and YPbPr jack on the TV.
5. Connect Audio Cables between the AUDIO OUT jacks on the VCR and the AUDIO L and AUDIO R jacks on the TV.

Note:

1. Whenever you connect an external device to your TV, make sure that power on the unit is turned off.
2. When connecting an external device, match the color of the connection terminal to the cable.

External Connection

Connecting a Camcorder

The rear panel jacks on your TV make it easy to connect a camcorder to your TV. They allow you to view the camcorder tapes without using a VCR.

Each Camcorder has a different back panel configuration.

When connecting a Camcorder or DVD, match the color of the connection terminal to the cable.

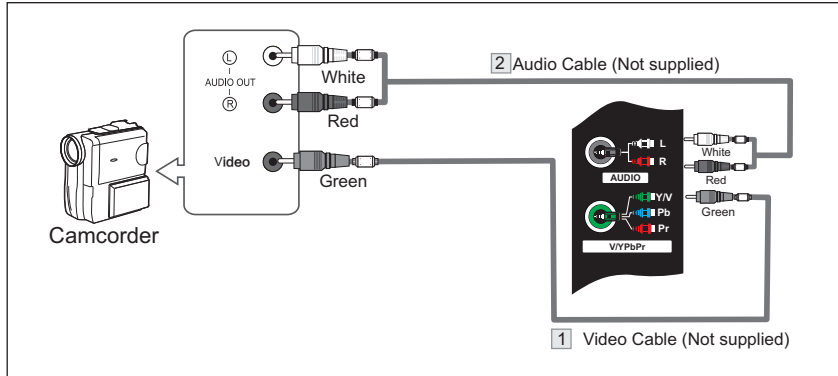

1. Connect a Video Cable between the AV VIDEO in jacks on the TV and the VIDEO OUT jack on the camcorder.
2. Connect Audio Cables between the AUDIO L and AUDIO R jacks on the TV and the AUDIO OUT jacks on the camcorder.
3. Connect a Video Cable between the AV VIDEO IN jacks on the TV and the VIDEO OUT jack on the DVD.
4. Connect Audio Cables between the component IN AUDIO L and R jacks on the TV and the AUDIO OUT jack on the DVD.

Notes:

1. **Whenever you connect an external device to your TV, make sure that power on the unit is turned off.**
2. **When connecting an external device, match the color of the connection terminal to the cable.**

External Connection

Connecting Digital Audio System

This connection can only be made if there is a HDMI Output connector on the external device.

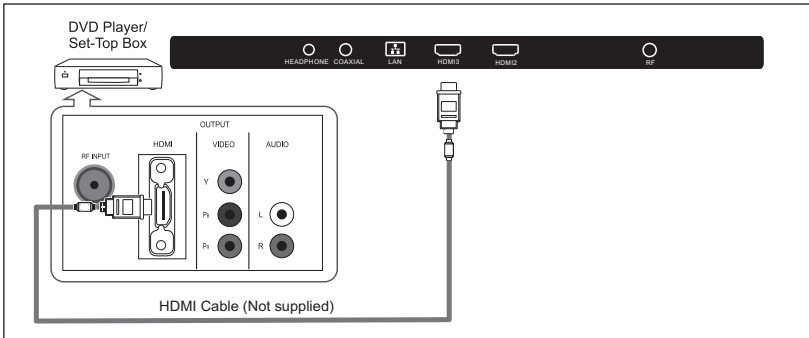

What is HDMI?

HDMI, or high-definition multimedia interface, is a next-generation interface that enables the transmission of digital audio and video signals using a single cable without compression. Multimedia interface is a more accurate name for it especially because it allows multiple channels of digital audio (5.1 channels).

The difference between HDMI and DVI is that the HDMI device is smaller in size, has the HDCP (High Bandwidth Digital Copy Protection) coding feature installed, and supports multi-channel digital audio.

Each DVD player/STB has a different back panel configuration.

Connect an HDMI Cable between the HDMI1, HDMI2, HDMI3 connector on the TV and the HDMI connector on the DVD player/Set-Top Box.

Notes:

- 1. Whenever you connect an external device to your TV, make sure that power on the unit is turned off.**
- 2. When connecting an external device, match the color of the connection terminal to the cable.**

External Connection

Connecting PC

The rear panel jacks on your TV make it easy to connect a Digital Audio System to your TV.

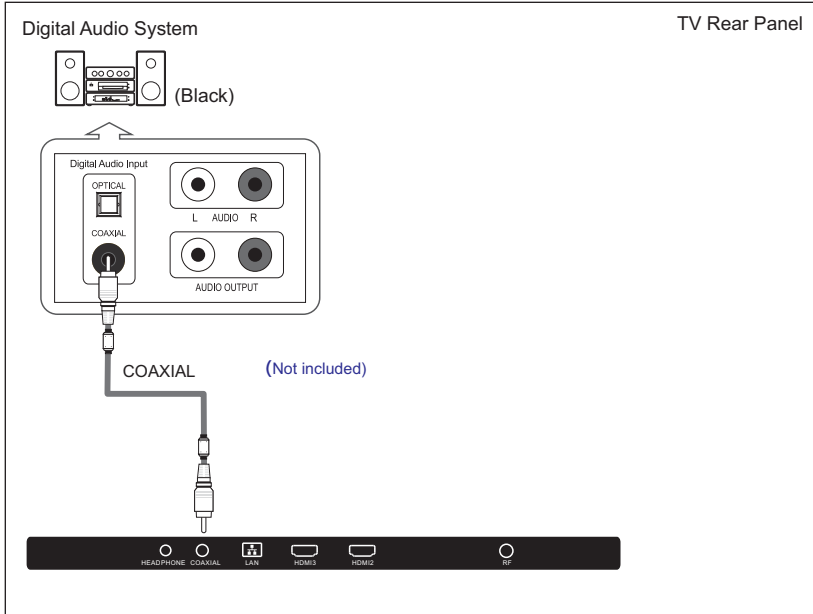

5.1 CH audio is possible when the TV is connected to an external device supporting 5.1 CH.

Connect an OPTICAL Cable between the OPTICAL jacks on the TV and the Digital Audio Input jacks on the Digital Audio System. When a Digital Audio System is connected to the OPTICAL terminal: Decrease the gain (volume) of the TV, and adjust the volume level with the Digital Audio System's volume control.

Supporting Signals

Input	Mode
Digital	ATSC
Analog	PAL-M/PAL-N/NTSC M
CVBS	PAL/NTSC

Input	Resolution	Vertical Frequency
Component	480i	60Hz
	480p	60Hz
	720p	50Hz/60Hz
	1080i	50Hz/60Hz
	1080p	50Hz/60Hz
	480p	60Hz
HDMI	720p	50Hz/60Hz
	1080i	50Hz/60Hz
	1080p	50Hz/60Hz
	3840x2160	24Hz/25Hz/30Hz/60Hz

Basic Operations

Menu Operation

1 Input Setup





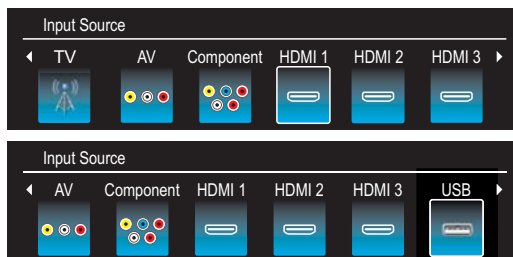





Press  key on the remote control to enter "INPUT SOURCE" menu. There are these options for you to select: "TV", "AV", "Component", "HDMI1", "HDMI2", "HDMI3", "USB".

Use /  key to select a input source and press **OK** key to confirm.







2 Channels Selection

There are four ways to select channel:

- 1) Using number keys, and **OK** keys on the remote control to select channel directly.
To select channel 90, press  →  → .
When you use the number buttons, you can directly select channels that were either erased or not memorized.
- 2) Using **CH** /  key on the remote control or on your TV to select channel.
When you press the **CH** /  key, the TV changes channels in sequence. You will see all the channels that the TV has memorized.
You will not see channels that were either erased or not memorized.
- 3) Press **CH**  key to return to previous channel, press it again to return to current channel.
To quickly switch between two channels that are far apart, tune to one channel, then use the number keys to select the second channel. Then use the **CH**  button to quickly alternate between them.
CH  is not activated if no channel has been changed after TV turning on.
- 4) Select channels from "Channels List" or "Favorite List".
Press **OK** key to choose from "Channel List" menu.

3 Volume Adjustment and Mute Setup

Volume adjustment

Press **VOL** /  key on the remote control or the TV to display "Volume" menu, adjust the volume of TV between 0 to 100 by using **VOL** /  key:

Basic Operations

Menu Operation

- To increase the volume, press **VOL**△ key;
- To decrease the volume, press **VOL**▽ key;



Mute

Press “” and the sound cuts off. The MUTE icon will appear in the lower-left corner of the screen.

To resume sound, press the “” button again, or simply press the VOL△ key.

4 Current Channel Information

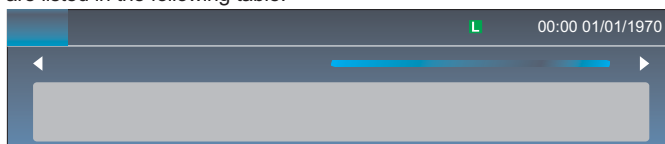

Press “INFO” key on the remote control to view current channel information, the indications of channel information are listed in the following table.



Press “EXIT” key on the remote control to exit this OSD.



Menu system instruction

Picture

1. Press  key to display the main menu on the screen.
2. Press  key to select "Picture" option.
3. Press  key to enter "Picture" submenu.
4. You can also press the **PICTURE** key on the remote control to select one of the picture settings.

Picture Mode



Your TV has four picture settings (Sports, Normal, Mild, Save, User) that are preset at the factory. Only "User" mode can be set to your preference by adjusting particular items such as Contrast, Brightness, Color, Sharpness.

1. Press  key to select "Picture Mode" option.
2. Press  key to select one picture mode.

User settings for PICTURE

(Contrast, Brightness, Color, Sharpness, Tint)

Your set has several settings which allow you to control picture quality.

1. Press  key to select a particular item.
2. Press  key to decrease or increase the value of a particular item.

Note: The adjusted values are stored according to the selected particular item.

Contrast: Adjusts the lightness and darkness between objects and the background.

Brightness: Adjusts the brightness of the picture.

Color: Adjusts the colors, making them lighter or darker.

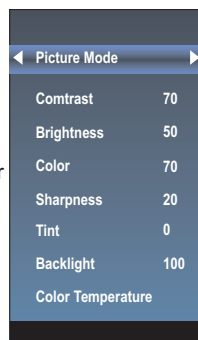
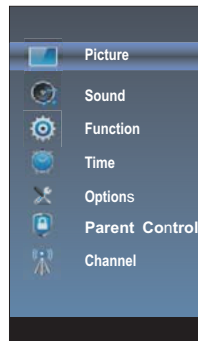

Sharpness: Adjusts the outline of objects to either sharpen them or make them more dull.

Tint: Adjusts the Tint of the picture.



Backlight



You can Change the brightness of the entire screen according to your preference.

1. Press  key to select "Backlight" option.
2. Press  key to increase or decrease the backlight value.

Backlight: Adjusts the brightness of the whole screen.

Color Temperature

You can change the color of the entire screen according to your preference.

1. Press  key to select "Color Temperature" option.
2. Press  key to select one color temp.



Cool: Makes whites bluish.

Standard: Makes whites nature

Warm: Makes whites reddish.



Menu system instruction

Sound

1. Press  key to display the main menu on the screen.
2. Press  key to select "Sound" option.
3. Press  key to enter "Sound" submenu.
4. You can also press the **SOUND** key on the remote control to select one of the sound.

Sound Mode

You can select the type of the special sound effect to be used when watching a given broadcast. Your TV has five sound settings ("Standard", "Music", "Movie", "Sports", "User") that are preset at the factory.

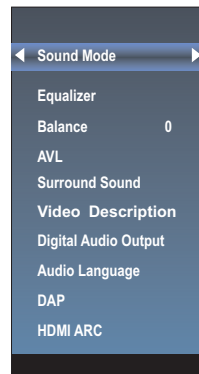

1. Press  key to select "Sound Mode" option.
2. Press  key to select one sound mode.

- Standard: Selects the normal sound mode.
- Music: Provides clear and live sound for music.
- Movie: Provides live and full sound for movies.
- Sports: Emphasizes bass over other sounds.
- User: Selects your custom sound settings.





Equalizer

Only can be adjusted in User mode.

1. Press  key to select "Equalizer" option.
2. Press  key to decrease or increase the value of the item.



Balance

If the volumes of the left speaker and the right speaker are not the same, you can adjust the "Balance" to suit your personal preference.

1. Press  key to select "Balance" option.
2. Press  key to decrease or increase the value of the item.



AVL

Each broadcasting station has its own signal conditions, and it is inconvenient to adjust the volume every time the channel is changed. "AVL" automatically adjusts the volume of the desired channel by lowering the sound output when the modulation signal is high or by raising the sound output when the modulation signal is low.



1. Press  key to select "AVL" option.
2. Press  key to select "On" or "Off".

Surround sound

This is used to turn on surround sound to gain better sound effect.

1. Press  key to select "Surround sound" option.
2. Press  key to select "Surround" or "Off".

Video Description

1. Press  key to select "Video Description" option.
2. Press  key to select "On" or "Off".

Menu system instruction

SOUND

Digital Audio Output

This is used to set digital audio output.

1. Press ▲/▼ key to select "Digital Audio Output" option.
2. Press ▲/▼ key to select "Auto" or "PCM".

Audio Language

You can set the first and secondary language for audio.

DAP

This is used to set DAP.

1. Press ▲/▼ key to select "DAP" option.
2. Press ► key to enter "DAP" submenu.

HDMI ARC

Turn on or turn off the HDMI ARC function.

DAP	
DAP Enable	Off
DAP Mode	Standard
Surround Virtualizer	High
Dialog Enhancer	Low
Auto Volume Control	Off

Function

1. Press  key to display the main menu on the screen.
2. Press ▲/▼ key to select "Function" option.
3. Press ► key to enter "Function" submenu.

Noise Reduction

Press ▲/▼ key to select the Noise Reduction mode. You can select the right mode to match the pictures.

MPEG Noise Reduction

Press ◀/▶ key to select the mode: off/low/middle/high. The picture will be better when it is in "high" mode.

Aspect Ratio

1. Press ▲/▼ key to select "Aspect Ratio" option.
2. Press ▲/▼ key to change the size of the picture on the size of the picture on the screen.

◀ Noise Reduction ▶
MPEG Noise Reduction
Aspect Ratio
CEC Link Setup
HDMI EDID
Netflix Deactive
Netflix ESN
Netflix Version
VUDU Deactivation
TTS

Menu system instruction

Function

DTV

Turn on/off ginga function

CEC Link Setup

1. Press ▲/▼ key to select "Link Setup" option.
2. Press OK or ► key to enter "Link Setup" submenu.

Enable Link: Press ◀/▶ to turn on/off the link setup.

Auto Power On: When this option is "On" and the TV is in standby mode. To turn on the DVD can also turn the TV at the same time.

Auto Standby: When this Option is "On" and the TV is on, to turn off TV can also turn the DVD into standby mode.

CEC Link Setup	
Enable CEC link ◀ On ▶	
Auto Power On	Off
Auto Standby	Off

HDMI EDID

This function is only used in HDMI mode.

1. Press ▲/▼ key to select "HDMI EDID" option.
2. Press ▲/▼ key to select "4K" or "2K".

Netflix Deactive

1. Press "▲/▼" key to select "Netflix Deactive" option.
2. Press "►" or "OK" key to confirm.
3. Press "Yes" to confirm again, the Netflix will be activated.

Netflix ESN



Display the Netflix Esn information.

Netflix Version

Display the Netflix version.

Menu system instruction

Time

1. Press  key to display the main menu on the screen.
2. Press  key to select "Time" option.
3. Press  key to enter "Time" submenu.

Off Time



In "Off Time" item, press  button or OK button to enter the submenu, set the day & time to turn off the TV set.

On Time

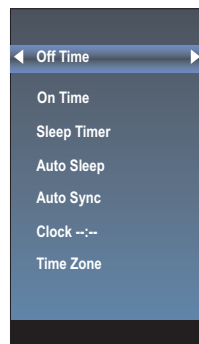
In "On Time" item, press  button or OK button to enter the submenu, set the time to turn on the TV set, when the TV set is in the standby mode. You can also choose which day to control your TV set in a week.



Sleep Timer

1. Press  key to select "Sleep Timer" option.
2. Press  key repeatedly until the desired time appears (Off, 10mins, 20mins, 30mins, 60mins, 90mins, 120mins, 180mins, 240mins).

Notes: The sleep timer you have set will be cancelled when the TV turns off or if a power failure occurs.

Notes: When the time is less than 60 seconds, remind information will be displayed on the screen. Press any key button to cancel timer function.

Auto Sleep

Press  key to select whether to open the Nosignal Power off features. If this function is opened, the TV will power off in ten minutes when there is no signal.

Auto Sync



You can modify the time of your TV set in Manual mode. In Auto mode, the "clock" is decided by the DTV signal.

Clock --:--

When Auto Sync is on, the clock is got from DTV streams; Set the clock when Auto Sync is off.



Time Zone

You can choose it to modify your time zone in the TV set.



1. Press  key to select "Time Zone" option.
2. Press  key to select time zone.

Menu system instruction

Options

1. Press  key to display the main menu on the screen.
2. Press  key to select "Option" option.
3. Press  key to enter "Option" submenu.



OSD Language

1. Press  key to select "OSD Language" option.
2. Press **OK** or  key to select a proper language for OSD



OSD Time

Set the preferred amount of time for the OSD to be displayed on the screen.

Closed Caption

1. Press  key to select "Closed Caption" option.
2. Press  key to select CC mode.

Reset



1. Press  key to select "Reset" option.
2. Press  or "OK" key to confirm.
3. Press "Yes" to confirm again, TV will turn off automatically and change all setting to factory setting.

Network Configuration

Please refer to "Network setting" behind.

Software Update(USB)

When the TV need to be updated, please copy the new software to a USB storage and inset the USB storage to TV, then operating by following steps.

1. Press  key to select "Software Update" option.
2. Press  or "OK" key to confirm.
3. Press "Yes" to confirm again, the TV will update by USB, Please wait a few minutes and don't turn off the power, it will turn off automatically when updating is finish.



Internet Update Check

This can update TV through internet.

Network Update Information

Display the Network Update Information.

User Mode

1. Press  key to select "User Mode" option.
2. Press  or "OK" key to confirm.

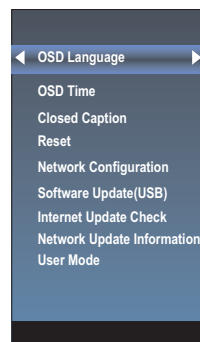

Menu system instruction

Parent Control

The "Parent Control" feature automatically locks out programming that is deemed inappropriate for children. The user must first enter a Password before any of the lock restrictions can be set up or changed.

1. Press ▲/▼ key to select "Parent Control" option.
2. Press **OK** or **u** key to enter "Parent Control" submenu, "Enter Password" menu will appear, enter your 4-digit password to enter "Parent Control" submenu (the default password is 0000, and the universal password is 1980).

Parent Control

Set the Lock function on or off.

1. Press ▲/▼ key to select "Parent Control" option.
2. Press ▲/▼ key to select "On" or "Off".

Set Password

1. Press ▲/▼ key to select "Set Password" option.
2. Enter your 4-digit password to enter "Set Password" submenu. Choose any 4-digits for your new password and enter them. As soon as the 4 digits are entered, the cursor skipped to "Confirm Password" item, re-enter the same 4 digits, and your new password has been memorized.

When the programs is locked, you can also press the menu key, Info key and so on. Then you can press ◀/▶ key to call back the input-password window.

Parental Guidance

This option only used in DTV mode.

1. Press ▲/▼ key to select "Parental Guidance" option.
2. Press ▲/▼ key to select the lock level of the Parental Rate.

USA TV

1. Press ▲/▼ key to select "USA TV" option.
2. Press **OK** key to open USA TV menu.

USA MPAA

1. Press ▲/▼ key to select "USA MPAA" option.
2. Press **OK** key to open USA MPAA menu.

Canada English

1. Press ▲/▼ key to select "Canada English" option.
2. Press **OK** key to open Canada English menu.

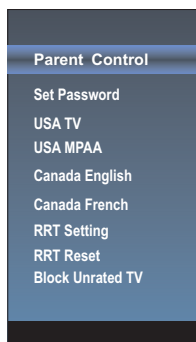
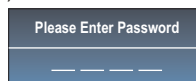

Menu system instruction

Parent Control

Canada French

1. Press ▲/▼ key to select "Canada French " option.
2. Press OK key to open Canada French menu.

RRT Setting

1. Press ▲/▼ key to select "RRT Setting " option.
2. Press OK key to open RRT Setting menu.

RRT Reset

1. Press ▲/▼ key to select "RRT Seseet " option.
2. Press OK key to open RRT Seseet menu.

Block Unrated TV

1. Press ▲/▼ key to select "Block Unrated TV " option.
2. Press ▲/▼ key to select "On" or "Off".

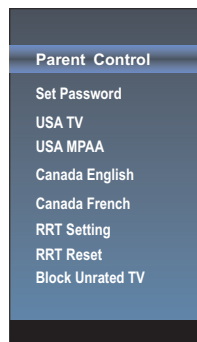

Menu system instruction

Channel

Before your television can begin memorizing the available channels, you must specify the type of signal source that is connected to the TV (i.e. an antenna or a cable system).

1. Press **[Menu]** key to display the main menu on the screen.
2. Press **▲/▼** key to select "Channel" option.
3. Press OK or **▶** key to enter "Channel" submenu.

Antenna

1. Press **▲/▼** key to select "Antenna" option.
2. Press **▲/▼** key to select "Antenna" or "CABLE".

Auto Search

1. Press **▲/▼** key to select "Auto Search" option.
2. Press **▶** or OK key to confirm. then a notice window will be displayed on the screen. Select "Start" to start search or "Cancel" to cancel it. When searching, press EXIT key to exit tuning at any moment. Press **[Menu]** key to skip DTV tuning when searching DTV, skip ATV tuning when searching ATV, skip CATV tuning when searching CATV.
3. After all the available channels are stored, the searching menu will exit.

Program Edit

After the program is searched, select "Program Edit" in the "Channel" menu, press "OK" button, program can be edited such as delete or skip according to the user's habit.

Skip (Blue) Button

This function can help shield certain program. Program skips when selecting program by the "**▲/▼**" button on the TV or remote control.

1. Select the program to be shielded in the "Program Edit".
2. Press "Skip" (Blue) button, the skip mark is displayed at the left side of the program and this program is shielded.
3. To cancel the Skip function, enter the channel edit menu, select the shielded program and press "Skip" (Blue) button, the skip mark at the left side of the program disappears then program is recovered.

Delete (Red) Button

This function can help delete program.

1. Select the program to be deleted in the "Program Edit".
2. Press "Delete"(Red) button, the program will be deleted.

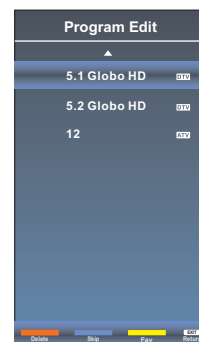
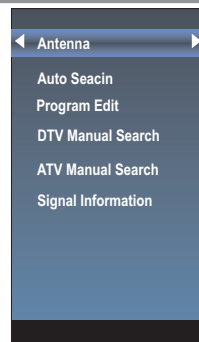

Menu system instruction

Channel

Favorite(Yellow) button

This function can help store the favorite program then these programs can be quickly selected.

1. Select the program which is favorite.
2. Press "Fav"(Yellow) Button, the favorite mark is displayed at the left side of the program and this program is store into the Favorites.
3. To cancel the Favorite function, enter the program edit menu, select the program and press "Fav"(Yellow) button, the favorite mark at the left side of the program disappears.

DTV Manual Search

Enter digital number and press "OK" to select DTV Channel.

ATV Manual Search

1. Press ▲/▼ key to select "ATV Manual Search" option.
2. Press ► or OK key to enter submenu.

Current CH

1. Press ▲/▼ key to select the second item.
2. Press ◀/▶ key to select current channel.

Fine-Tune

1. Press ▲/▼ key to select the third item.
2. Press ◀/▶ key to select a better frequency for current channel.

Signal Information(Used only in DTV)

1. Press ▲/▼ key to select "Signal Information" option.
2. Press "OK" or ► key ,you can see the information of the DTV channel.

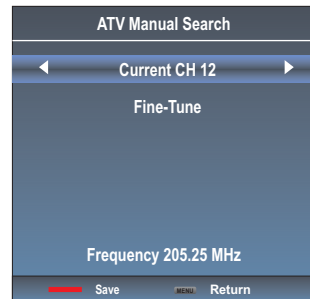
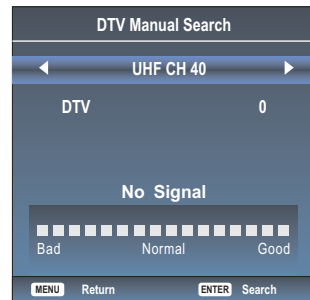

Network Setting

1. Press the "⏏" to enter, then pitch on the "Options", and press "OK" or click the right button to enter the submenu.

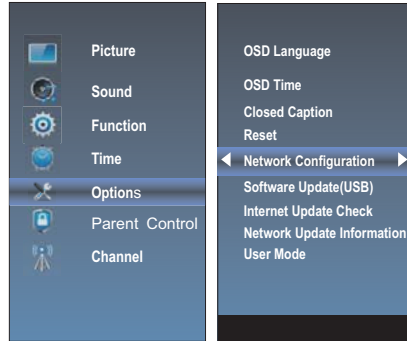

2. Pitch on the "Network Configuration", and press "OK" or click right button to enter the "Network Configuration".

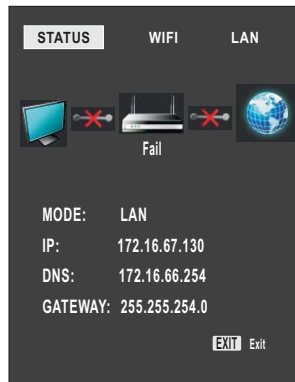

3. When the wired network is used, if select dynamic IP address setting, pitch on the "DHCP" in the "Network Configuration", then click the "Setting", and press the "OK" button to enter. If select static IP address setting, pitch on the "Static" in the "Network configuration", then setting up the IP, Netmask, Gateway and DNS in sequence. When the setting complete, pitch on the "setting" and press the "Enter".

Network Setting

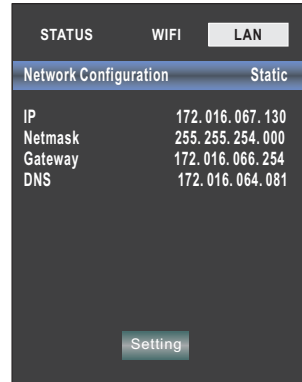

4.If shows "Success" , the "WLAN" on the bottom right corner will turn to green from red, and it means the network connect successfully; If shows "Fail" , it means the network can not connect, please check whether the net wire and router connect successfully or not.

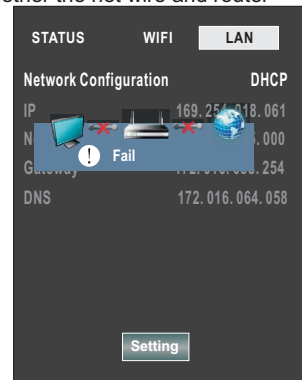

5. Select the "WIFI" in the Network Configuration before using WIFI connecting.

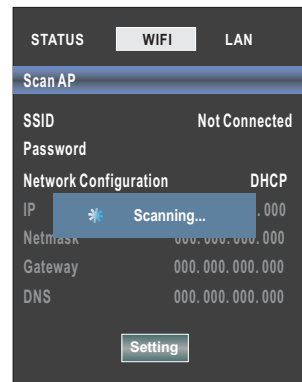

Network Setting

Pitch on the "Setting", press the "OK" to confirm. If shows "Success", the "WIFI" on the bottom right corner will turn to green from red, and it means the network connect successfully; If shows "Fail", it means the network can not connect, please check whether the wireless router connects successfully or not.

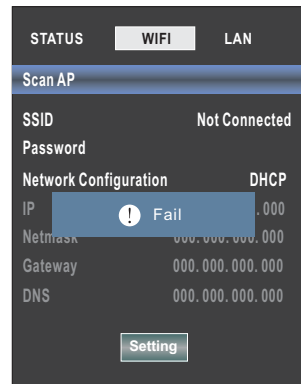

Internet

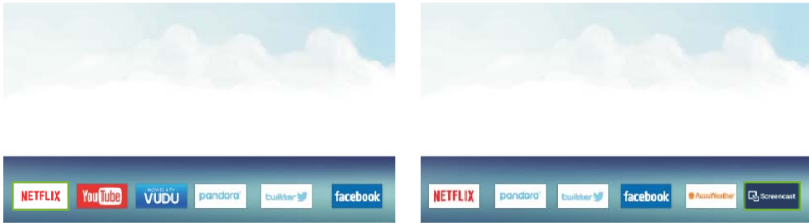

Press “” key to enter internet interface

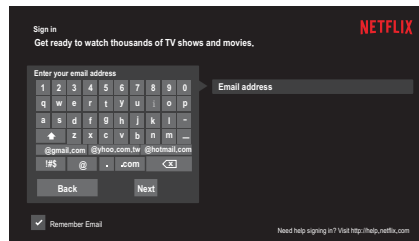

1. NETFLIX

① Use arrow key to Select  button, then press “OK” key to enter NETFLIX.





- ② Use arrow button to select one video and press “OK” key to play.
Press “” key to exit playing.
- ③ Use arrow key to browse the pages. press “” key to return to main menu and press “EXIT” key to exit.

2. Youtube

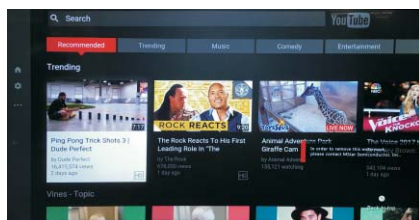
① Use arrow key to Select  button, then press “OK” key to enter Youtube.



- ② Use arrow button to select one video and press “OK” key to play.
Press “” key to exit playing.
- ③ Press  key to open or close control menu when playing.



Internet

- 4 Press ▲ key to enter search interface, input the keyword and then press “OK” to search videos.



3. VUDU

- 1 Use arrow key to Select  button, then press “OK” key to enter VUDU.



4. pandora

- 1 Use arrow key to Select  button, then press “OK” key to enter pandora.

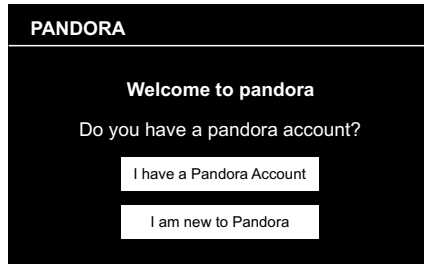

Internet

5. Twitter

❶ Use arrow key to Select  button, then press “OK” key to enter Twitter.



❷ Input the right Email and password, then select “Authorize app” button and press “OK” key to log in.

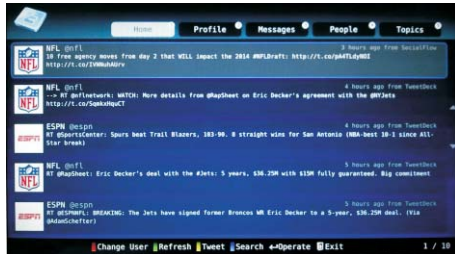

❸ Use arrow key to browse the pages. press “” key to return to main menu and press “EXIT” key to exit twitter.

Red key: log in or log out twitter.

Green key: refresh current page.

Yellow key: write new tweet.

Blue key: Search tweet.

Internet

6. Facebook

❶ Use arrow key to Select  button, then press “OK” key to enter Facebook.



❷ Input the right Email and password, select “log In” button, then press “OK” key to log in.

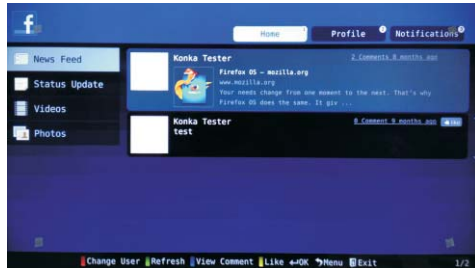

❸ Press arrow key to browse the pages and press “OK” key to view.
Press “” key to return the main menu.
Press “EXIT” key to exit Facebook.

Red key: log in or log out Facebook.

Green key: refresh current page.

Yellow key: sign “like” or “unlike” for current content.

Blue key: view comments and add comments.

7. Accuweather

❶ Use arrow key to Select  button, then press “OK” key to enter Accuweather.



❷ Input a city or zip code press select to get the weather information.

8.Screencast

Use arrow key to Select  button, then press "OK" key to enter Screencast.



Digital Media Player

Introduction

This TV is embedded with one USB port digital media player. It can find the devices support USB1.1/2.0, including flash disk, USB hard disk and digital camera. It supports functions as: Display pictures. Play music files, Play video files, Display text files.

Notice:

1. In order to avoid affecting the user's viewing experience, please use the better quality and shorter USB cable.
2. Play, preview some of the non-standard files may appear abnormal, please understand.

Explain:

1. Under the USB channel, you can use only the remote control.
2. Play Control menu to enter the playing surface to press the menu button pop-up menu

Data	Format
Picture	JPEG
Video	Motion-JPEG

Remote Control Button

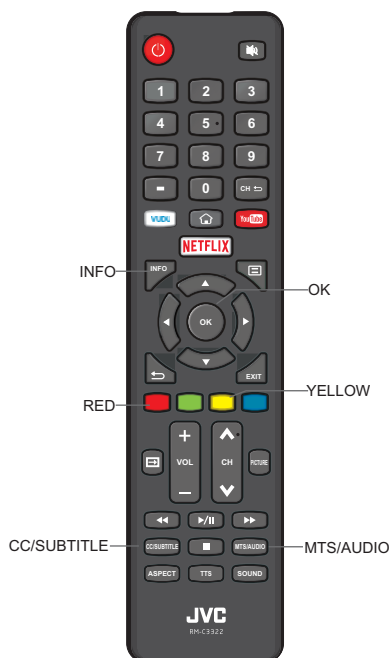

Description of Buttons:

Buttons	Function
MTS/AUDIO	Track switch (video)
CC/SUBTITLE	Subtitle switch (video)
INFO	Show/Hide movie info (video)
YELLOW	AB Loop (Video)
RED	Goto Time (Video)
▶/■	Play/Pause
■/◀	Stop
◀◀	Backward
▶▶	Forward

Troubleshooting

If you have any problem, check the counter measures for each symptom listed below. The following symptoms may have been caused by inappropriate adjustment rather than actual malfunction of the unit. If the trouble persists, contact the Customer Care Centre, see back page for contact details.

Symptoms	Possible solutions
No power	Please check the power cord plugged in and that the power outlet works. Unplug the power cord and plug it in after 60 seconds and restart the TV.
No picture	Please check antenna connection. Station may be experiencing problems, please tune to another station. Please adjust the settings of contrast and brightness.
Good picture but no sound	Please increase the volume. Please check TV is under mute mode, press MUTE button on the remote control. Please check sound settings If external devices are being used, check their volumes are not set too low or turned off. If using AVI or Component inputs, please make sure cables are connected properly and not loose.
Good sound but abnormal color or no picture	Please check antenna connection and antenna condition. If using Component input, please check Component connections, incorrect or loose connections may cause colour problems or cause the screen to be blank.
No response to remote control	Batteries of remote control may have exhausted, if necessary, please change the batteries. Clean the remote control lens. The distance between LED TV and remote control should be within 8m, within recommended operating angle and path is free of obstructions.
Colored dots may be present on the screen	Although the LED screen is made with high-precision technology and 99.99% or more of the pixels are effective, black dots may appear or bright points of light (red, blue, or green) may appear constantly on the LED screen. This is a structural property of the LED screen and not a malfunction.
Picture is breaking up	Keep the TV away from noisy electrical sources such as cars, hair dryers, welders, and all optional equipment. Electrical atmospheric interference such as local or distant lightning storms may cause picture to break up. When installing optional equipment, leave some space between the optional equipment and the TV. Check the antenna and connection. Keep the antenna away from any power or input/output cables.
After Auto Tuning only some channels are available	Check your area is covered by Digital Video Broadcasts. Try re-tuning or manually tuning missing channels. Check that you are using the correct antenna type - please see pg.16 'Antenna connection'.

Troubleshooting

Channel cannot be selected	Check if the channel has been blocked in the main menu settings.
USB not playing	Please check connecting USB cable and power supply is connected. Hard drive has not been formatted. Please make sure USB disk is compatible and the multimedia data formats are supported.
Picture is distorted, macroblock, small block, dots, pixelization, etc	Compression of video contents may cause distortion especially on fast moving pictures such as sports and action movies.
Noise from speaker	Check cable connections, make sure a video cable is not connected to an audio input. Low signal level may cause sound distortion.
TV turns on automatically	Check if the On Timer is set to On in the Setup menu.
Picture is not shown in full screen	Black bars on each side will be shown on HD channels when displaying SD (4:3) contents. Black bars on Top & Bottom will be shown on movies that have aspect ratios different from your TV. Adjust picture size option on your external device or TV to full screen.

WARNING

Never place a television set in an unstable location. A television set may fall, causing serious personal injury or death. Many injuries, particularly to children, can be avoided by taking simple precautions such as:

- Using cabinets or stands recommended by the manufacturer of the television set.
- Only using furniture that can safely support the television set.
- Ensuring the television set is not overhanging the edge of the supporting furniture.
- Not placing the television set on tall furniture (for example, cupboards or bookcases) without anchoring both the furniture and the television set to a suitable support.
- Not placing the television set on cloth or other materials that may be located between the television set and supporting furniture.
- Educating children about the dangers of climbing on furniture to reach the television set or its controls

If your existing television set is being retained and relocated, the same considerations as above should be applied.

The plug or appliance coupler is used as the disconnect device, the disconnect device shall remain readily operable.

Reference

Picture defects and the reason



Snowy Picture

Snowy picture is usually due to weak signal. Adjust antenna or install an antenna amplifier.



Double Image or Ghosts

Double images are usually caused by reflections from tall buildings. Adjust the direction of the antenna or raise it.



Radio Wave Interference

Wave patterns are moving on the screen, which are usually caused by nearby radio transmitters or short-wave receiving equipment.



High Temperature Electrothermal Interference

Diagonal or herringbone patterns appear on the screen or part of picture is missing. This is probably caused by high temperature electrothermal equipment in a nearby hospital.

JVC