

AMTC

LED TV

**USER MANUAL
MUAV4360Y-34580**

Please read this User Manual carefully to ensure use of this product and keep this manual for future reference

Contents

Safety and warnings.....	2-3
Introduction.....	4
Installation.....	5-8
Remote Control.....	9-10
Operation.....	11-14
Trouble Shooting.....	15

IMPORTANT SAFETY INSTRUCTION

- 1) Read these instructions.
- 2) Keep these instructions.
- 3) Heed all warnings.
- 4) Follow all instructions.
- 5) Do not use this apparatus near water.
- 6) Clean only with dry cloth.
- 7) Do not block any ventilation openings, install in accordance with the instructions.
- 8) Do not install near any heat sources such as radiations, heat registers, stoves, or other apparatus (including amplifiers) that produce heat.
- 9) Do not defeat the safety purpose of the polarized plug. If the provided plug does not fit into your outlet, consult an electrician for replacement of the obsolete outlet.
- 10) Protected the power cord from being walked on or pinched particularly at plugs, convenience receptacles, and the point where they exit from the apparatus.
- 11) Only use attachments/accessories specified by the manufacturer.
- 12) Unplug this apparatus during lightning storms or when unused for long periods of time.
- 13) Refer all servicing to qualified service personnel. Servicing is required when the apparatus has been damaged in any way, such as power-supply cord or plug is damaged, liquid has been spilled or objects have fallen into the apparatus, the apparatus has been exposed to rain or moisture, does not operate normally, or has been dropped.
- 14) Mains plug is used as the disconnect device, the disconnect device shall remain readily operable.
- 15) The ventilation should not be impeded by covering the ventilation openings with items, such as newspapers, table-cloth, curtains, etc.
- 16) No naked flame sources, such as lighted candles, should be placed on the apparatus.
- 17) Attention should be drawn to the environmental aspects of battery disposal.
- 18) The use of apparatus in moderate climate.
- 19) The apparatus shall not be exposed to dripping or splashing and that no objects filled with liquids, such as vases, shall be placed on the apparatus.

Warning: To avoid any injury caused by lean of the product, please always ensure the whole product was placed within the table surface in horizontal.

WARNING

Never place a television set in an unstable location. A television set may fall, causing serious personal injury or death. Many injuries, particularly to children, can be avoided by taking simple

precautions such as:

– Using cabinets or stands recommended by the manufacturer of the television set.

– Only using furniture that can safely support the television set.



– Ensuring the television set is not overhanging the edge of the supporting furniture.

– Not placing the television set on tall furniture (for example, cupboards or bookcases) without anchoring both the furniture and the television set to a suitable support.

– Not placing the television set on cloth or other materials that may be located between the television set and supporting furniture.

– Educating children about the dangers of climbing on furniture to reach the television set or its controls.

If your existing television set is being retained and relocated, the same considerations as above should be applied.

	CAUTION RISK OF ELECTRIC SHOCK DO NOT OPEN!	
CAUTION		
TO REDUCE THE RISK OF ELECTRIC SHOCK, DO NOT REMOVE COVER (OR BACK). NO USER SERVICEABLE PARTS INSIDE. REFER SERVICING TO QUALIFIED SERVICE PERSONNEL.		

 The symbol indicates that dangerous voltages constituting a risk of electric shock are present within this unit.

 The symbol indicates that there are important operating and maintenance instructions in the literature accompanying this unit.

WARNING:

To reduce the risk of fire or electric shock, do not expose this apparatus to rain or moisture.

WARNING:

The batteries shall not be exposed to excessive heat such as sunshine, fire or the like.



This symbol indicates that this product incorporates double insulation between hazardous mains voltage and user accessible parts. When servicing use only identical replacement parts.



This marking indicates that this product should not be disposed with other household wastes throughout the EU. To prevent possible harm to the environment or human health from uncontrolled waste disposal, recycle it responsibly to promote the sustainable reuse of material resources. To return your used device, please use the return and collection systems or contact the retailer where the product was purchased. They can take this product for environmental safe recycling.

Step one: Use the expansion bolts(4*36PWA) to fix the wall mount brackets into the wall

Step Two: Fix the wall mount screws (M6x8mm/4pcs) into the rear side of the LCD TV,using the tongue of 8kgf.cm.

*** The TV appearance subject to material object.**

Step Three: Put the LCD TV with wall mount screws onto the wall mount brackets.

Warning: the angle between the TV and wall must not be bigger than 3°.

Warning: Changes or modifications to this unit not expressly approved by the party responsible for compliance

could void the user's authority to operate the equipment.

NOTE: This equipment has been tested and found to comply with the limits for a Class B digital device, pursuant to Part 15 of the FCC Rules.

These limits are designed to provide reasonable protection against harmful interference in a residential installation.

This equipment generates, uses and can radiate radio frequency energy and, if not installed and used in accordance

with the instructions, may cause harmful interference to radio communications.

However, there is no guarantee that interference will not occur in a particular installation. If this equipment does cause harmful interference to radio or television reception, which can be determined by turning the equipment off and on, the user is encouraged to try to correct the interference by one or more of the following measures:

- o Reorient or relocate the receiving antenna.
 - o Increase the separation between the equipment and receiver.
 - o Connect the equipment into an outlet on a circuit different from that to which the receiver is connected.
- Consult the dealer or an experienced radio/TV technician for help.

This device complies with Part 15 of the FCC Rules.

Operation is subject to the following two conditions:
(1) this device may not cause harmful interference, and

(2) this device must accept any interference received, including interference that may cause undesired operation.

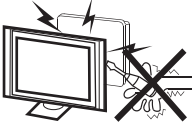

Warning ⚡

High voltages are used in the operation of this television receiver. Do not remove the cabinet back from your set. Refer servicing to qualified service personnel.

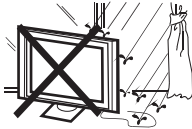

Warning ⚡

To prevent fire or electrical shock hazard, do not expose the television receiver to rain or moisture.



Warning ⚡

Do not drop or push objects into the television cabinet slots or openings. Never spill any kind of liquid on the television receiver.

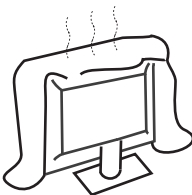

Caution ⚠

Do not block the ventilation holes in the back cover. Adequate ventilation is essential to prevent failure of electrical components.



Caution ⚠

Do not trap the power supply cord under the television receiver.

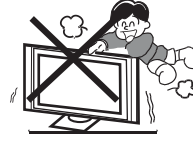

Caution ⚠

Never stand on, lean on, or suddenly push the television or its stand. You should pay special attention to children. Serious injury may result if it should fall.



Caution ⚠

Do not place your television on an unstable cart, stand, shelf or table. Serious injury to an individual, and damage to the television, may result if it should fall.



Caution ⚠

When the television receiver is not used for an extended period of time, it is advisable to disconnect the AC power cord from the AC outlet.

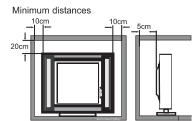

Caution ⚠

If the television is to be built into a compartment or similar enclosure, the minimum distances must be maintained. Heat build-up can reduce the service life of your television, and can also be dangerous.

Thank you very much for purchasing this TV. To enjoy your product from the very beginning, read this manual carefully and keep it handy for easy reference.

CAUTION

Never tamper with any components inside the TV, or any other adjustment controls not mentioned in this manual. All LED-TVs are high voltage instruments. When you clean up dust or water drops on the LED PANEL or CABINET, the power cord should be pulled out from the receptacle, then wipe the TV with a dry soft cloth. During thunder and lightning, unplug the power cord and antenna cord to prevent damage to your TV. All repairs to this TV should only be performed by qualified TV service personnel.

INSTALLATION

- *Locate the TV in the room where light does not strike the screen directly.
- *Total darkness or a reflection on the picture screen can cause eyestrain. Soft and indirect lighting is recommended for comfortable viewing.
- *Allow enough space between the TV and the wall to permit ventilation.
- *Avoid excessively warm locations to prevent possible damage to the cabinet or premature component failure.
- *Do not cover the ventilation openings when using the TV.

Main features

- ① Used as Television, display terminal, PC display;
- ② High luminance, wide viewing Angle;
- ③ HDMI interface and SCART Interface;
- ④ NICAM;

Main parameter

Panel	43 "
TV System	PAL-B/G、I、D/K SECAM- B/G、D/K、 L、 LL
Video Signal System	PAL/NTSC/SECAM
Input Power Voltage	100-240V~50/60Hz
Power consumption	78 W
Audio Output Power (THD≤7%)	2x8W
Signal Input	Analog RGB(PC)x1 High-Definition Multimedia Interface(HDMI) x2 Video INput x1 Audio Input x2 USB Input x1 Y、Cb (Pb)、Cr (PR)x1 Mini SCART X1
Horizontal definition (TV line)	Composite Video input ≥350 Super Video Input ≥400 Y Cb(Pb) Cr(Pr) ≥400

Front panel

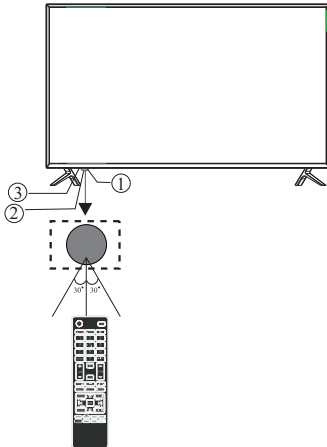

KEYBOARD

The keyboard is located at the bottom left near the right side of signal indicator.

Remote Buttons

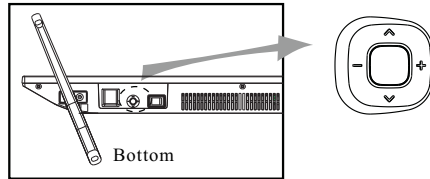

“-” VOL- and move left

“+” VOL+ and move right

“▲” CH- and move down

“▼” CH+ and move up

“Center button” power key and source key, hold it for a long time, the TV will power down.

KEYBOARD

- 1: Remote control sensor.
- 2: Indicator LED: RED ● STANDBY.
- 3: Key board

REAR Connections



All the terminals are (from left to right):
AC POWER SOURCE, OPTICAL, AUDIO OUTPUT, VIDEO, AUDIO INPUT.

SIDE Connections



All the terminals are (from left to right):
HDMI1, HDMI2, HDMI3/MHL, HEADPHONE, YPbPr, USB, RF.

ANTENNA

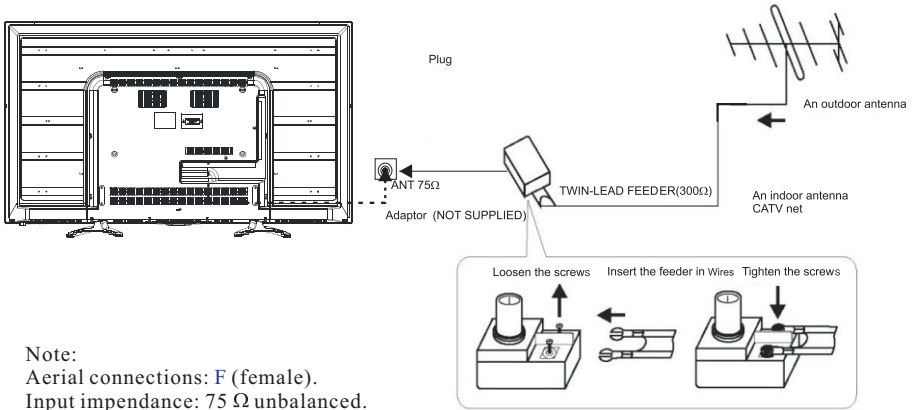

Note:
 Aerial connections: F (female).
 Input impedance: 75 Ω unbalanced.

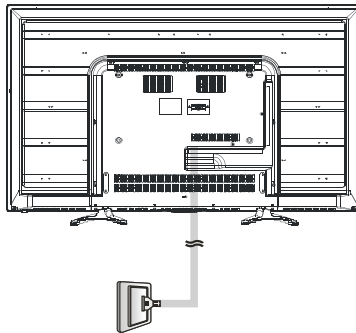

PRESET MODE (HDMI)

	RESOLUTION	V.Freq.(Hz)	H.Freq.(KHz)
1	800*600	60	37.88
2	1024*768	60	48.36
3	1360*768	60	47.7
4	1280*768	60	47.3
5	1920*1080	60	67.5
6	3840*2160	30	67.5
7	3840*2160	50	112.5
8	3840*2160	60	135

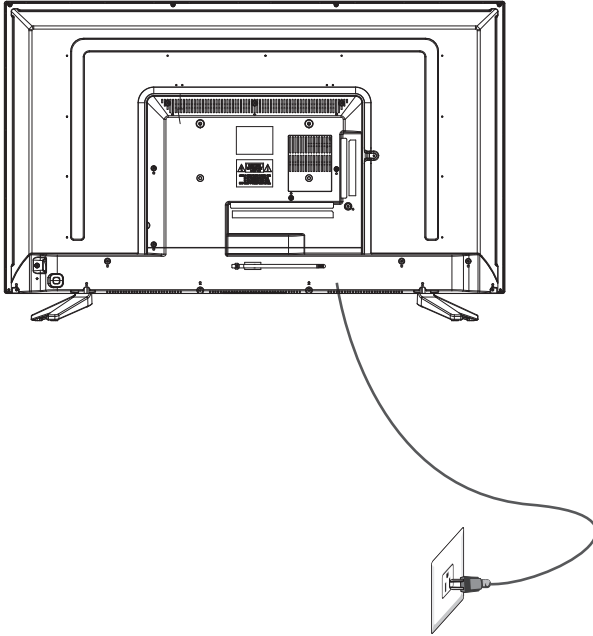

AV EQUIPMENT

There are three HDMI ports located on the back of your TV. You can connect a Blu-ray player, DVD player, or other video equipment through these ports.

The **HDMI3** port is MHL enabled. You can connect MHL devices, such as the compatible mobile phones and tablets.

NOTE: a USB to HDMI cable is required to connect a mobile phone or tablet to the TV. Please check the documentation of your device.

There is one component (Y, Pb, Pr) and video input located on your TV. You can connect a VCR, cable box, or other video equipment to these jacks.

Please see the diagram below. You may also need to refer to the owner's manual of the device that you are trying to connect.

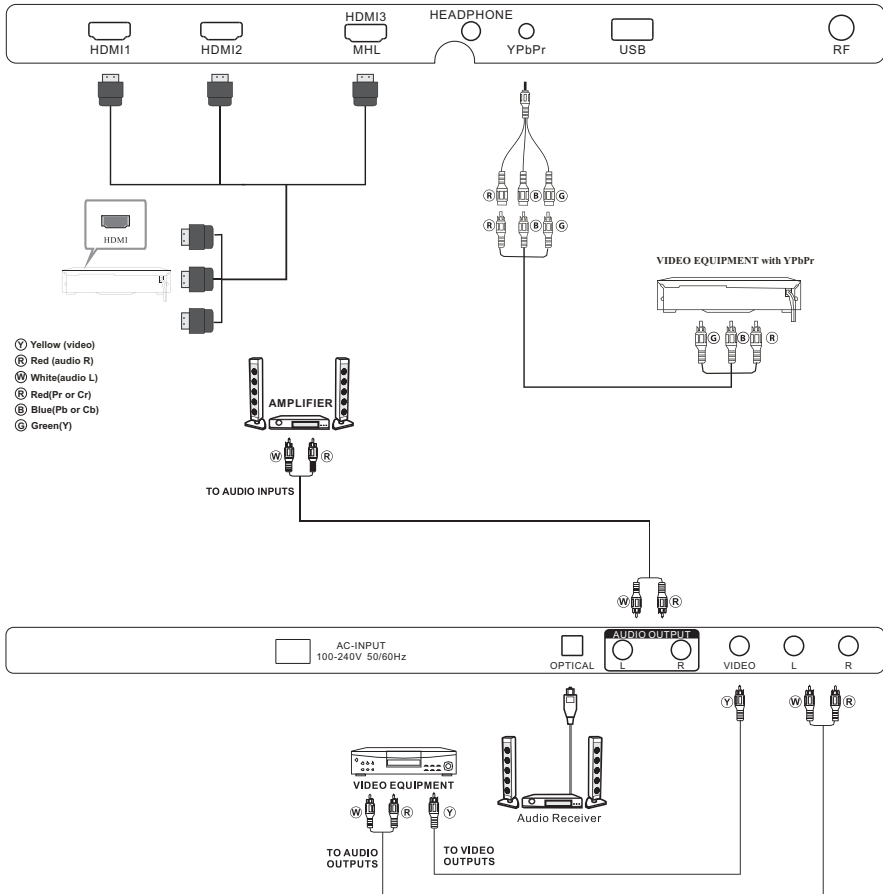

The television's inputs can be connected to the following types of equipment: VCR, multi disc player, DVD, camcorder, video game or stereo system, etc.....

YPbPr can support these video formats:480i,576i,480p,576p,720p,1080i, 1080p.

REMOTE CONTROL

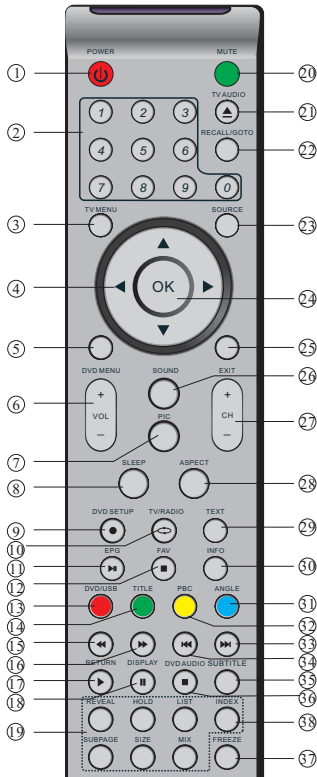

- 1: POWER:**
To set the TV to standby or power on.
- 2: NUMERIC KEY:**
For direct access to channels.
- 3: TV MENU:**
To display TV menu.
- 4: CURSOR:**
To move within the menu.
- 6: VOL+/- :**
To adjust sound level.
- 7: PIC:**
To switch picture mode.
- 8: SLEEP:**
Set timer to turn off the TV.
- 10: TV/RADIO:** In DVB mode, it is used to switch between digital TV channels and radio stations. Display/remove the programme information.
- 11: EPG:** To display information about the program being viewed and what's on next in DTV mode.
- 12: FAV:** To access your favourite channels list in TV or DTV mode.
- 14: TITLE:**
- 19: TELETEXT KEYS:**
- 20: MUTE:**
To disable or enable the sound output.
- 21: TV/AUDIO:** To select the available audio language of TV programs .
- 22: RECALL/GOTO:** To access the previously viewed channel.
- 23: SOURCE:**
To select input source.
- 24: OK:**
To confirm selection.
- 25: EXIT:**
To return to the previous menu or exit menu.
- 26: SOUND:**
To switch sound mode.
- 27: CH+/CH-:**
To access the next or previous channels.
- 28: ASPECT:**
To change picture aspect ratio.
- 29: TEXT:**
To enter or exit TELETEXT.
- 30: INFO:** To display information about the channel being viewed or further information about the program when in small EPG screen in DTV mode.
- 35: SUBTITLE:**
To switch between different subtitles in DTV mode.
- 37: FREEZE:**
To freeze the picture.

Insert Batteries Into the Remote Control

1. Remove the battery cover.
2. Inserting the 2 AAA 1.5V batteries making sure the polarity (+ or -) of the batteries matches the polarity marks inside the unit.
3. Mount the battery cover. Replace with new batteries when the TV set begins to show the following symptoms: Operation is unsteady or erratic. Sometimes the TV set does not function with Remote Control Unit.



Remark:

- 1) Alkaline Battery Recommended.
- 2) Remove batteries when they are exhausted or if the remote control is not to be used for Long time.

NOTE:
For the function of DVD button ,please refer to the DVD part at the back of this instruction book.

TELETEXT

Teletext is an information system broadcast by certain channels which can be consulted like a newspaper. It also offers access to subtitles for viewers with hearing problems or who are not familiar with the transmission language (cable networks, satellite channels, etc.)

Press:	You will obtain:
TEXT	This is used to call or exit teletext modes. The summary appears with a list of items that can be accessed. Each item has a corresponding 3 digit page number. If the channel selected does not broadcast teletext, the indication 100 will be displayed and the screen will remain blank (in this case, exit teletext and select another channel).
SELECTING A PAGE 	Enter the number of the page required using the 0 to 9 up/down. Example: page 120, enter 120. The number is displayed top left, the counter turns and then the page is displayed. Repeat this operation to view another page. If the counter continues to search, this means that the page is not transmitted. Select another number.
DIRECT ACCESS TO THE ITEMS 	Coloured are as are displayed at the bottom of the screen. The 4 coloured keys are used to access the items or corresponding pages. The coloured areas flash when the item or the page is not yet available.
INDEX	This returns to the contents page (usually page 100).
SUB PAGE	Certain pages contain sub-pages which are automatically displayed successively. This key is used to stop or resume sub-page acquisition. The indication appears top left.
HOLD	To freeze the page.
REVEAL	To display or hide the concealed information (games solutions).
LIST	The user can set four favorite pages to be directly linked to the four color keys. While list mode is activated, it is not possible to use TOP or FLOF navigation with the colorkeys. The favorite page numbers should be stored and restored to/from nonvolatile memory for each channel by the system software.

Insert Batteries into the Remote Control

1. Remove the battery cover.
2. Inserting the 2 AAA 1.5V batteries making sure the polarity (+ or -) of the batteries matches the polarity marks inside the unit.
3. Mount the battery cover. Replace with new batteries when the TV set begins to show the following symptoms: Operation is unsteady or erratic. Sometimes the TV set does not function with Remote Control Unit.

Remark:

- 1) Alkaline Battery Recommended.
- 2) Remove batteries when they are exhausted or if the remote control is not to be used for Long time.

Installation Guide

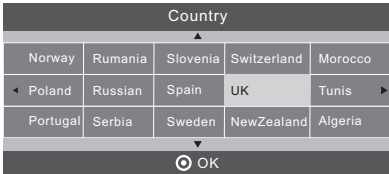

This screen only appear when the TV first time turn on or reset to factory set. You can choose language and country, auto turning programs . And after turning the screen will skip to the first DTV program.

1.CHANNEL MENU

The first item of the MENU is channel menu(for TV or DTV source only).

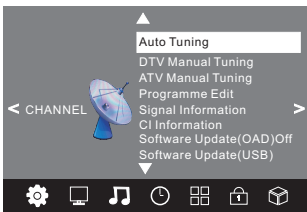

You can search channels and edit programs here.

1).Auto tuning:

Search all the channels automatically(you can select ATV and DTV)

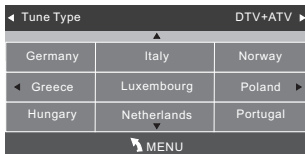

Pls press ◀▶▼▲ to select country at first , then press OK button to start auto tuning .

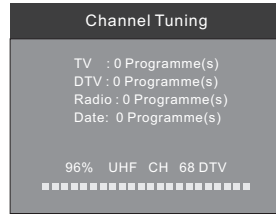

NOTE:

All the channels including ATV, DTV and Radio can be tuning by one time,if the Tune Type is DTV+ATV .

All the stored channels will be disappear after auto tuning .

After auto tuning , the channel will skip to the first DTV channel.

2).DTV Manual tuning:

You can select a DTV channel then find the program in this channel.

Pls press ◀▶ to select the channel , then press OK to search the programs .

NOTE:

Bad Normal Good means signal intensity.



3). ATV Manual tuning :

You can change the sound system to search the analog TV channels and fine tune the channels , then storage the channels you selected.

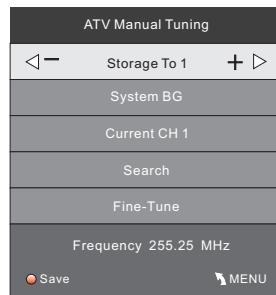

NOTE:

Press teletext red button to storage to channels after manual tuning .

4). Program edit:

You can Delete ,Rename ,Move, Skip , FAV any programs.

Delete

Press teletext red button , the program in cursor will delete.

Rename:

Only can rename ATV programs .

Move the cursor to the program, press teletext green button to rename the program.

Press ▼▲ to choose the character. Press ◀▶ to move the cursor .

Press MENU button to exit edit , Press EXIT to exit the menu.

Note: ATV programs name only can be 5 character, DTV programs name can be 25 character.

Move

Move the cursor to the program , press teletext yellow button , it will show yellow cursor , Press ▼▲ to move the program.

Skip

Press ▼▲ to choose the program , press teletext blue button to skip this program, The Ⓞ will show on the right side of the program .

Choose the skipped program, press blue button again , you can cancel the skip ,The Ⓞ will disappear .

Favourite

Press ▼▲ to choose the program , press FAV button , it will show ♥ on the right side of the program.Choose the FAV program , press FAV button again , you can cancel the FAV,♥ the will disappear .

Once your favorite group is created, you can press the FAV key to quickly access your favorite channel.

5). CI information: (optional)

This menu can display the CI card' s information.

2. PICTURE MENU

The second item of the MENU is PICTURE MENU.

You can adjust picture effect here, such as contrast, brightness, etc.

Press OK to move, press OK to adjust.

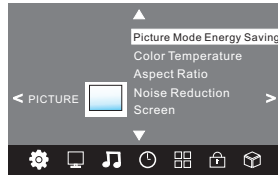

Picture Mode	Energy Saving	Color Temperature	Medium
Contrast	50	Red	40
Brightness	50	Green	31
Color	50	Blue	50
Sharpness	50		
Tint	50		
MENU		MENU	

Note:

1) If you want to adjust contrast, brightness, color, and sharpness, the picture mode must be set to personal.

2) This will increase or decrease Warm (red) and Cool (blue) colors to suit your personal preference.

Select Cool to give the white colors a blue tint, Normal to give the white colors a neutral tint, Warm to give the white colors a red tint.

Energy saving is the default setting, if you select some other options, the power consumption may change.

This product default mode (Energy saving) already pass the Energy star test, if TV set in other mode, may increase energy consumption beyond the limits required for ENERGY STAR qualification

3.SOUND MENU

The third item of the MENU is the SOUND MENU.

You can adjust the sound effect here such as treble, bass, balance etc.

Press ▼▲ to move, press OK to adjust.

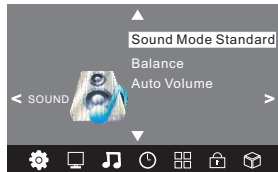

Note:

Auto volume: only available when the input signal volume is too large or distortion.

4.TIME MENU

The fourth item of the menu is the TIME MENU

You can adjust the clock, power on/off time, sleep time etc Press ◀▶ to move, press OK to adjust



NOTE:

Within 15 minutes there is no signal, the TV will auto sleep , if Auto Sleep is set ON. The clock time can get from the DTV system auto.

5. OPTION MENU

The fifth item of the MENU is the OPTION MENU. You can adjust the Menu language, Audio language, Subtitle language etc.

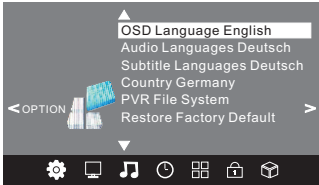

In PVR File system menu you can set up USB disk for PVR.

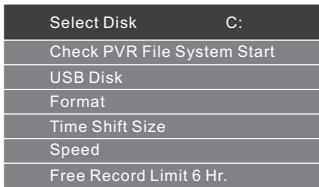

NOTE:
Restore factory default will clear all the programs and password.

6. LOCK MENU

The sixth item of the menu is the LOCK MENU. You can lock system, set password, block program and set parental guidance. Once you set the lock system on you can not search the channels or change any programs.

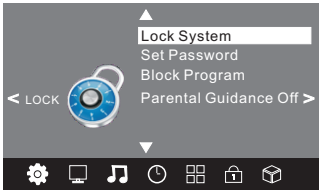

NOTE:
The default pass word is 6666.
Block program: Press ▼▲ to choose the program, press teletext green button to block the program. If you want unblock the program, pls enter the main menu, input the password, then press green button again. Parental guidance: Press ◀▶ to choose 4~18 years.

7. APPLICATIONS MENU

The sixth item of the MENU is the OPTION MENU.

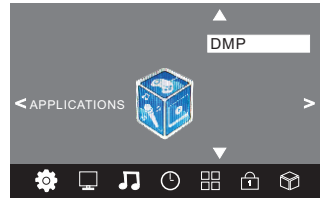

Press OK button to enter the DMP menu.

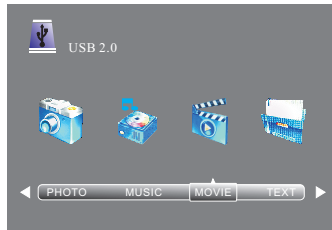

Please make sure that the USB device have plugged in the slot. There are four type media item can be selected, such as photo, music, Movie, and text. Select the type media item by pressing ◀▶, press OK button to enter the disk selection menu.

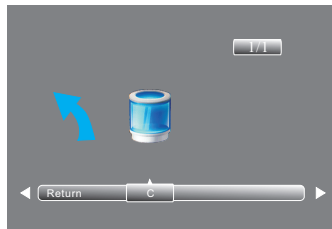

Press the ◀▶ to select the right disk and press OK to display media files and folder list or choose Return to back to the media type selection menu.

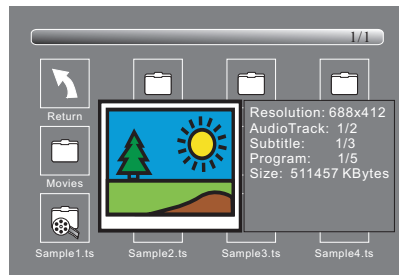

Select the media file by pressing ◀▶ or ▼▲ , then the preview frame will pop up. Press the button ▶ to play the media file in full screen. When the media file (photo, music, Movie, or text type) is playing, press the **OK** or Info button can display the control bar.



Press ◀▶ to select the function icon, press **OK** button to confirm the function.

Press ▼ or **EXIT** button to exit the control bar.

NOTE:

You can adjust the audio track, subtitle, or program in the Info menu while Playing the video file. Choose the Info icon and press **OK** can display the Info MENU.

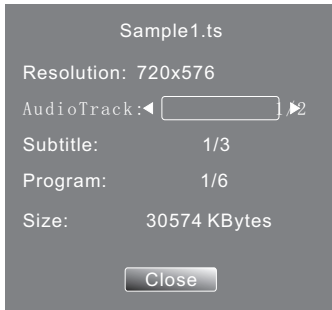

8. EPG Menu (Electronic Program Guide).

The EPG menu is used to look at what is being broadcasted on DTV or Radio channel in the day. To access the EPG menu, press the EPG button, the following menu will be displayed:

PROGRAMME GUIDE	TIME
28 Apr 04:39	
800 SZTVM01	No Information
801 SZTVM02	No Information
802 SZTVM03	No Information
803 SZTVM04	No Information
804 Date	No Information
Record INFO Schedule Remind OK INDEX	

1. **INFO**

Use ⚙️ to choose the programs , Press **INFO** key, you can display the highlight program's information.

2. **Schedule**

Press the teletext yellow key, It can list all the reminder schedule, press ▼▲ to choose the list, press red key **DELETE** to delete the schedule list, Press **EPG** to return to **EPG** menu.

Time	Date	Programme Title	Channel Name









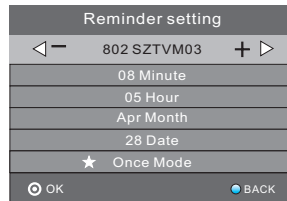







3. **Record**

Press the red key ,It can set the program to be recorded.

4. **Remind**

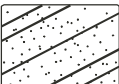
Press the blue key to choose one program and set up one reminder time, the TV screen will skip to the choosed program in the reminder time automatically.



Trouble phenomenon Symptom				Inspection Check
Picture		Audio		
	Snow		Noise	antenna position, direction or connection
	Ghost		Normal audio	antenna position, direction or connection
	Interference		Noise	electronic equipment, car/ motorcycle, fluorescent light
	Normal Picture		Mute	Volume (check if mute is activated or if the audio system connections are not correct)
	No picture		Mute	Power cord is not inserted Power switch is not opened Contrast and brightness/volume setup Press standby key on the remote control for inspecting
	No colour		Normal audio	Colour control
	Picture breaking up		Normal audio or weak	retune channel
	No colour		Noise	TV system

The LED TV panel is built with very high precision technology giving you fine picture details in vibrant color. Occasionally, a few non-active pixels may appear on the screen as a fixed point of red, green, blue, black or white. Please note this does not affect the performance of the product.

LED TV



This symbol on the product or in the instructions means that your electrical and electronic equipment should be disposed at the end of life separately from your household waste. There are separate collection systems for recycling in the EU. For more information, please contact the local authority or your retailer where you purchased the product.