



TEST REPORT

For

Applicant : KEEFE GROUP

Address : 10880 LIN PAGE PLACE, ST. LOUIS,
MISSOURI 63132-1008, USA

Product Name : The Edge Mini

Model Name : The Edge Mini Alkaline Tablet

Brand Name : N/A

FCC ID : 2AHUC-EDGEMINI-AA

Report No. : MTE/DYY/S16040605

Date of Issue : Apr. 16, 2016

Issued by : Most Technology Service Co., Ltd.

Address : No.5, 2nd Langshan Road, North District, Hi-tech Industrial
Park, Nanshan, Shenzhen, Guangdong, China

Tel : 86-755-8602 6850

Fax : 86-755-2601 3350

The report consists 51 pages in total. It may be duplicated completely for legal use with the approval of the applicant. It should not be reproduced except in full, without the written approval of our laboratory. The client should not use it to claim product endorsement by MOST. The test results in the report only apply to the tested sample. The test report shall be invalid without all the signatures of testing engineers, reviewer and approver.

TABLE OF CONTENTS

1. VERIFICATION OF CONFORMITY.....	4
2. GENERAL INFORMATION	5
2.1 Product Information.....	5
2.2 Objective	5
2.3 Test Standards and Results.....	6
2.4 Environmental Conditions.....	6
3. TEST METHODOLOGY.....	7
3.1 TEST FACILITY	7
3.2 GENERAL TEST PROCEDURES	7
4. SETUP OF EQUIPMENT UNDER TEST	8
4.1 SETUP CONFIGURATION OF EUT.....	8
4.2 SUPPORT EQUIPMENT	8
4.3 TEST EQUIPMENT LIST	9
5. 47 CFR Part 15 C Requirements	10
5.1 RF EXPOSURE	10
5.1.1 Applicable Standard	10
5.1.2 Measurement Result.....	10
5.2 ANTENNA REQUIREMENT.....	11
5.2.1 Applicable Standard	11
5.2.2 Evaluation Criteria.....	11
5.2.3 Result: Compliance.	11
5.3 AC Power Line Conducted Emission.....	12
5.3.1 Requirement	12
5.3.2 Block Diagram of Test Setup	12
5.3.3 Test procedure	12
5.3.4 Test Result	12
5.4 Radiated Emission	15
5.4.1 Requirement	15
5.4.2 Test Configuration	15
5.4.3 Test Procedure:	16
5.4.4 Test Result	17
5.5 Conducted Peak Output Power.....	24
5.5.1 Requirement	24
5.5.2 Block Diagram of Test Setup	24
5.5.3 Test Procedure	24
5.5.4 Test Result	24
5.6 6dB Emission Bandwidth	25
5.6.1 Test Requirement	25
5.6.2 Block Diagram of Test Setup	25
5.6.3 Test Procedure	25
5.6.4 Test Result	25
5.7 POWER SPECTRAL DENSITY.....	30
5.7.1 Applicable Standard	30
5.7.2 Block Diagram of Test Setup	30
5.7.3 Test Procedure	30
5.7.4 Test Result	30
5.8 Band Edge and Conducted Spurious Emissions	35

5.8.1 Test Requirement	35
5.8.2 Test Procedure	35
5.8.3 Test Result	35
5.9 Restricted Frequency Bands.....	39
5.9.1 Test Requirement	39
5.9.2 Test Configuration	39
5.9.3 Test Procedure:	39
5.9.4 Test Result	39

1. VERIFICATION OF CONFORMITY

Equipment Under Test: The Edge Mini
Brand Name: N/A
Model Number: The Edge Mini Alkaline Tablet
FCC ID: 2AHUC-EDGEMINI-AA
Applicant: KEEFE GROUP
 10880 LIN PAGE PLACE, ST. LOUIS, MISSOURI 63132-1008,
 USA
Manufacturer: Ospicon Technology Limited
 Unit 1025, 10 Floor, Metro Centre II, 21 Lam Hing Street, Kowloon
 Bay, Hong Kong
Technical Standards: 47 CFR Part 15 Subpart C
File Number: MTE/DYY/S16040605
Date of test: Mar. 31-Apr. 08, 2016
Deviation: None
Condition of Test Sample: Normal
Test Result: PASS

The above equipment was tested by Most Technology Service Co., Ltd. for compliance with the requirements set forth in FCC rules and the Technical Standards mentioned above. This said equipment in the configuration described in this report shows the maximum emission levels emanating from equipment and the level of the immunity endurance of the equipment are within the compliance requirements.

The test results of this report relate only to the tested sample identified in this report.

Tested by (+ signature): *Daisy*
 Daisy Yu Mar. 31-Apr. 08, 2016

Review by (+ signature): *Henry* 
 Henry Chen Apr. 16, 2016

Approved by (+ signature): *Yvette Zhou*
 Yvette Zhou (Manager) Apr. 16, 2016

2. GENERAL INFORMATION

2.1 Product Information

Product	The Edge Mini
Brand Name	N/A
Model Number	The Edge Mini Alkaline Tablet
Series Model Name:	N/A
Series Model Difference description:	N/A
Power Supply	DC 5V by USB Port DC 6V by Battery
Frequency Range	802.11b/g/n(20MHz): 2412-2462MHz
Modulation Type:	IEEE 802.11b mode: DSSS IEEE 802.11g mode: OFDM 802.11n Standard-20 MHz Channel mode: OFDM
Channel Number	802.11b/g/n(20MHz): 11
Antenna Type	FPC Antenna, -0.5dBi
Temperature Range	0°C ~ +40°C

NOTE:

1. For a more detailed features description about the EUT, please refer to User's Manual.

2.2 Objective

The objective of the report is to perform tests according to FCC Part 15 Subpart C for the EUT FCC ID Certification:

No.	Identity	Document Title
1	47 CFR Part 15	Radio Frequency Devices
2	KDB 558074	Guidance for Performing Compliance Measurements on Digital Transmission Systems (DTS) Operating Under §15.247

2.3 Test Standards and Results

No.	Section	Test Items	Result	Date of Test
1	FCC 15.247 (i)	RF EXPOSURE	PASS	2016-04-08
2	FCC 15.203	Antenna Requirement	PASS	2016-04-08
3	FCC15.207 (a)	AC Power Line Conducted Emission	N/A	2016-03-31
4	FCC15.209, 15.247(d)	Radiated Emission	PASS	2016-04-06
5	FCC15.247(b)(3)	Conducted Peak Output Power	PASS	2016-04-06
6	FCC15.247(a)(2)	6dB Emission Bandwidth	PASS	2016-04-06
7	FCC15.247(e)	Power Spectral Density	PASS	2016-04-06
8	FCC15.247(d)	Band Edge and Conducted Spurious Emissions	PASS	2016-04-07
9	FCC15.247(d)	Restricted Frequency Bands	PASS	2016-04-08

Note: 1. The test result judgment is decided by the limit of measurement standard
 2. The information of measurement uncertainty is available upon the customer's request.

2.4 Environmental Conditions

During the measurement the environmental conditions were within the listed ranges:

- Temperature: 15-35°C
- Humidity: 30-60 %
- Atmospheric pressure: 86-106 kPa

3. TEST METHODOLOGY

3.1 TEST FACILITY

Test Site:	Most Technology Service Co., Ltd
Location:	No.5, Langshan 2nd Rd., North Hi-Tech Industrial park, Nanshan, Shenzhen, Guangdong, China
Description:	There is one 3m semi-anechoic an area test sites and two line conducted labs for final test. The Open Area Test Sites and the Line Conducted labs are constructed and calibrated to meet the FCC requirements in documents ANSI C63.10:2013 and CISPR 16 requirements. The FCC Registration Number is 490827 . The IC Registration Number is 7103A-1 .
Site Filing:	The site description is on file with the Federal Communications Commission, 7435 Oakland Mills Road, Columbia, MD 21046.
Instrument	All measuring equipment is in accord with ANSI C63.10:2013 and CISPR 16
Tolerance:	requirements that meet industry regulatory agency and accreditation agency requirement.
Ground Plane:	Two conductive reference ground planes were used during the Line Conducted Emission, one in vertical and the other in horizontal. The dimensions of these ground planes are as below. The vertical ground plane was placed distancing 40 cm to the rear of the wooden test table on where the EUT and the support equipment were placed during test. The horizontal ground plane projected 50 cm beyond the footprint of the EUT system and distanced 80 cm to the wooden test table. For Radiated Emission Test, one horizontal conductive ground plane extended at least 1m beyond the periphery of the EUT and the largest measuring antenna, and covered the entire area between the EUT and the antenna.

3.2 GENERAL TEST PROCEDURES

Radiated Emissions

The EUT is placed on a turn table, which is 1.5 m above ground plane. The turntable shall rotate 360 degrees to determine the position of maximum emission level. EUT is set 3m away from the receiving antenna, which varied from 1m to 4m to find out the highest emission. And also, each emission was to be maximized by changing the polarization of receiving antenna both horizontal and vertical. In order to find out the maximum emissions, exploratory radiated emission measurements were made according to the requirements in Section 6.5 of ANSI C63.10:2013.

Conducted Emissions

The EUT is placed on the turntable, which is 0.8 m above ground plane. According to the requirements in Section 6.2 of ANSI C63.10:2013, Conducted emissions from the EUT measured in the frequency range between 0.15 MHz and 30MHz using CISPR Quasi-peak and average detector modes.

4. SETUP OF EQUIPMENT UNDER TEST

4.1 SETUP CONFIGURATION OF EUT

See test photographs attached in Appendix 1 for the actual connections between EUT and support equipment.

4.2 SUPPORT EQUIPMENT

Device Type	Manufacturer	Model Name	Serial No.	Input	Output
---	---	---	---	---	---

Remark:

All the equipment/cables were placed in the worst-case configuration to maximize the emission during the test. Grounding was established in accordance with the manufacturer's requirements and conditions for the intended use.

4.3 TEST EQUIPMENT LIST

Instrumentation: The following list contains equipment used at Most for testing. The equipment conforms to the CISPR 16-1 / ANSI C63.2 Specifications for Electromagnetic Interference and Field Strength Instrumentation from 10 kHz to 1.0 GHz or above.

No.	Equipment	Manufacturer	Model No.	S/N	Calibration date	Calibration Interval
1	Test Receiver	Rohde & Schwarz	ESCI	100492	2016/03/10	1 Year
2	Spectrum Analyzer	Agilent	E7405A	US44210471	2016/03/14	1 Year
3	L.I.S.N.	Rohde & Schwarz	ENV216	100093	2016/03/10	1 Year
4	Coaxial Switch	Anritsu Corp	MP59B	6200283933	2016/03/07	1 Year
5	Terminator	Hubersuhner	50Ω	No.1	2016/03/07	1 Year
6	RF Cable	SchwarzBeck	N/A	No.1	2016/03/07	1 Year
7	Test Receiver	Rohde & Schwarz	ESPI	101202	2016/03/10	1 Year
8	Bilog Antenna	Sunol	JB3	A121206	2016/03/14	1 Year
9	Horn Antenna	SCHWARZBECK	BBHA9120D	756	2016/03/14	1 Year
10	Horn Antenna	Penn Engineering	9034	8376	2016/03/14	1 Year
11	Cable	Resenberger	N/A	NO.1	2016/03/07	1 Year
12	Cable	SchwarzBeck	N/A	NO.2	2016/03/07	1 Year
13	Cable	SchwarzBeck	N/A	NO.3	2016/03/07	1 Year
14	Single Phase Power Line Filter	DuoJi	FNF 202B30	N/A	2016/03/07	1 Year
15	Test Receiver	Rohde & Schwarz	ESCI	100492	2016/03/10	1 Year
16	Loop antenna	ARA	PLA-1030/B	1039	2016/03/14	1 Year

NOTE: Equipments listed above have been calibrated and are in the period of validation.

5. 47 CFR Part 15 C Requirements

5.1 RF EXPOSURE

5.1.1 Applicable Standard

According to §15.247(i) and §1.1310, systems operating under the provisions of this section shall be operated in a manner that ensure that the public is not exposed to radio frequency energy level in excess of the Commission's guideline.

According to KDB447498 D01 General RF Exposure Guidance v05r02:

The 1-g and 10-g SAR test exclusion thresholds for 100 MHz to 6 GHz at test separation distances ≤ 50 mm are determined by:

$$\left[\frac{\text{max. power of channel, including tune-up tolerance, mW}}{\text{min. test separation distance, mm}} \right] \cdot [\sqrt{f(\text{GHz})}] \leq 3.0 \text{ for 1-g SAR and } \leq 7.5 \text{ for 10-g extremity SAR, where}$$

$$f(\text{GHz}) \text{ is the RF channel transmit frequency in GHz}$$

Power and distance are rounded to the nearest mW and mm before calculation

The result is rounded to one decimal place for comparison

3.0 and 7.5 are referred to as the numeric thresholds in the step 2 below

The test exclusions are applicable only when the minimum test separation distance is ≤ 50 mm and for transmission frequencies between 100 MHz and 6 GHz. When the minimum test separation distance is < 5 mm, a distance of 5 mm according to 5) in section 4.1 is applied to determine SAR test exclusion.

5.1.2 Measurement Result

The maximum conducted output power = 6.01 dBm (3.99 mW) at 2462 MHz $\left[\frac{\text{max. power of channel, mW}}{\text{min. test separation distance, mm}} \right] [\sqrt{f(\text{GHz})}]$

$$= 3.99/5 \cdot (\sqrt{2.462}) = 1.252 < 3.0$$

So the stand-alone SAR evaluation is not necessary.

5.2 ANTENNA REQUIREMENT

5.2.1 Applicable Standard

According to FCC § 15.203 , An intentional radiator shall be designed to ensure that no antenna other than that furnished by the responsible party shall be used with the device. The use of a permanently attached antenna or of an antenna that uses a unique coupling to the intentional radiator shall be considered sufficient to comply with the provisions of this section. The manufacturer may design the unit so that a broken antenna can be replaced by the user, but the use of a standard antenna jack or electrical connector is prohibited. This requirement does not apply to carrier current devices or to devices operated under the provisions of §15.211, §15.213, §15.217, §15.219, or §15.221. Further, this requirement does not apply to intentional radiators that must be professionally installed, such as perimeter protection systems and some field disturbance sensors, or to other intentional radiators which, in accordance with §15.31(d), must be measured at the installation site. However, the installer shall be responsible for ensuring that the proper antenna is employed so that the limits in this part are not exceeded.

5.2.2 Evaluation Criteria

(a) Antenna must be permanently attached to the unit.

(b) Antenna must use a unique type of connector to attach to the EUT.

Unit must be professionally installed, Installer shall be responsible for verifying that the correct antenna is employed with the unit.

5.2.3 Result: Compliance.

The EUT has one integral antenna arrangement, which was permanently attached and the antenna gain is -0.5 dBi, fulfill the requirement of this section.

5.3 AC Power Line Conducted Emission

5.3.1 Requirement

A radio apparatus that is designed to be connected to the public utility (AC) power line shall ensure that the radio frequency voltage, which is conducted back onto the AC power line on any frequency or frequencies within the and 150 kHz-30 MHz, shall not exceed the limits in the following table:

Frequency	Maximum RF Line Voltage	
	Q.P.(dBuV)	Average(dBuV)
150kHz-500kHz	66-56	56-46
500kHz-5MHz	56	46
5MHz-30MHz	60	50

****Note:** 1. the lower limit shall apply at the band edges.
2. The limit decreases linearly with the logarithm of the frequency in the range 0.15 MHz to 0.50 MHz

5.3.2 Block Diagram of Test Setup

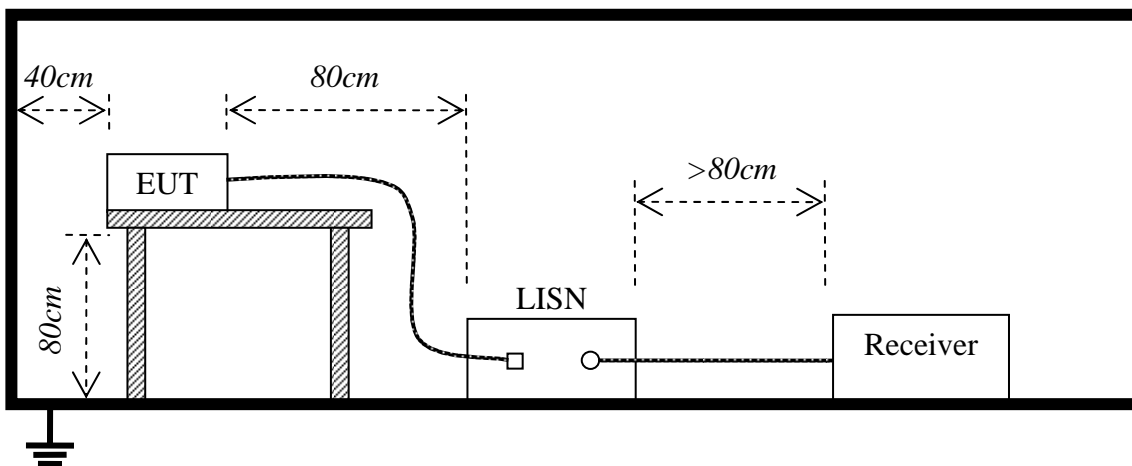

5.3.3 Test procedure

1. The E.U.T and simulators are connected to the main power through a line impedance stabilization network (L.I.S.N.). This provides a 50ohm/50uH coupling impedance for the measuring equipment.
2. Exploratory measurements were made to identify the frequency of the emission that has the highest amplitude relative to the limit;
3. The peripheral devices are also connected to the main power through a LISN that provides a 50ohm/50uH coupling impedance with 50ohm termination. (Please refer to the block diagram of the test setup and photographs).
4. Both sides of A.C. line are checked for maximum conducted interference. In order to find the maximum emission, the relative positions of equipment and all of the interface cables must be changed according to ANSI C63.10: 2013 on conducted measurement.
5. The bandwidth of test receiver (ESCI) set at 9 KHz.
6. All data was recorded in the Quasi-peak and average detection mode.

5.3.4 Test Result

Pass

Note: All test modes are performed, only the worst case is recorded in this report.

Please refer the following pages.

EUT:	The Edge Mini	M/N:	The Edge Mini Lithium Tablet
Mode:	Charging	Phase:	L1
Test by:	John	Power:	DC 5V by USB Port
Temperature: / Humidity	23.7°C / 52.2%	Test date:	2016-03-31

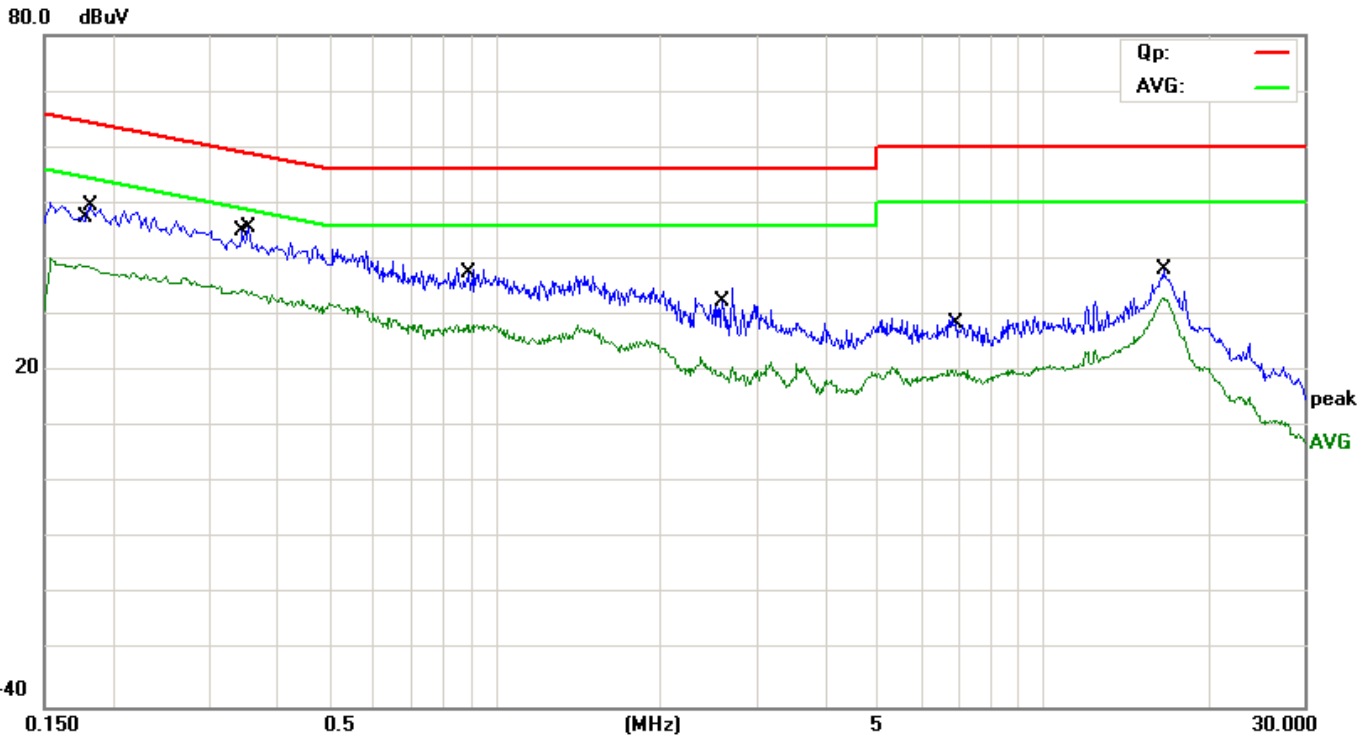

No.	Mk.	Freq. MHz	Reading Level dBuV	Correct Factor dB	Measure- ment dBuV	Limit dBuV	Over dB	Detector	Comment
1		0.1768	29.20	9.61	38.81	54.63	-15.82	AVG	
2		0.1820	40.09	9.61	49.70	64.39	-14.69	QP	
3		0.3465	24.81	9.59	34.40	49.05	-14.65	AVG	
4	*	0.3540	35.95	9.59	45.54	58.87	-13.33	QP	
5		0.8980	27.89	9.60	37.49	56.00	-18.51	QP	
6		0.8980	18.63	9.60	28.23	46.00	-17.77	AVG	
7		2.5940	10.37	9.61	19.98	46.00	-26.02	AVG	
8		2.5980	22.70	9.61	32.31	56.00	-23.69	QP	
9		6.9220	18.78	9.65	28.43	60.00	-31.57	QP	
10		6.9220	10.58	9.65	20.23	50.00	-29.77	AVG	
11		16.5660	23.49	9.71	33.20	50.00	-16.80	AVG	
12		16.6140	28.52	9.71	38.23	60.00	-21.77	QP	

*:Maximum data x:Over limit !:over margin

EUT:	The Edge Mini	M/N:	The Edge Mini Lithium Tablet
Mode:	Charging	Phase:	N
Test by:	John	Power:	DC 5V by USB Port
Temperature: / Humidity	23.7°C / 52.2%	Test date:	2016-03-31

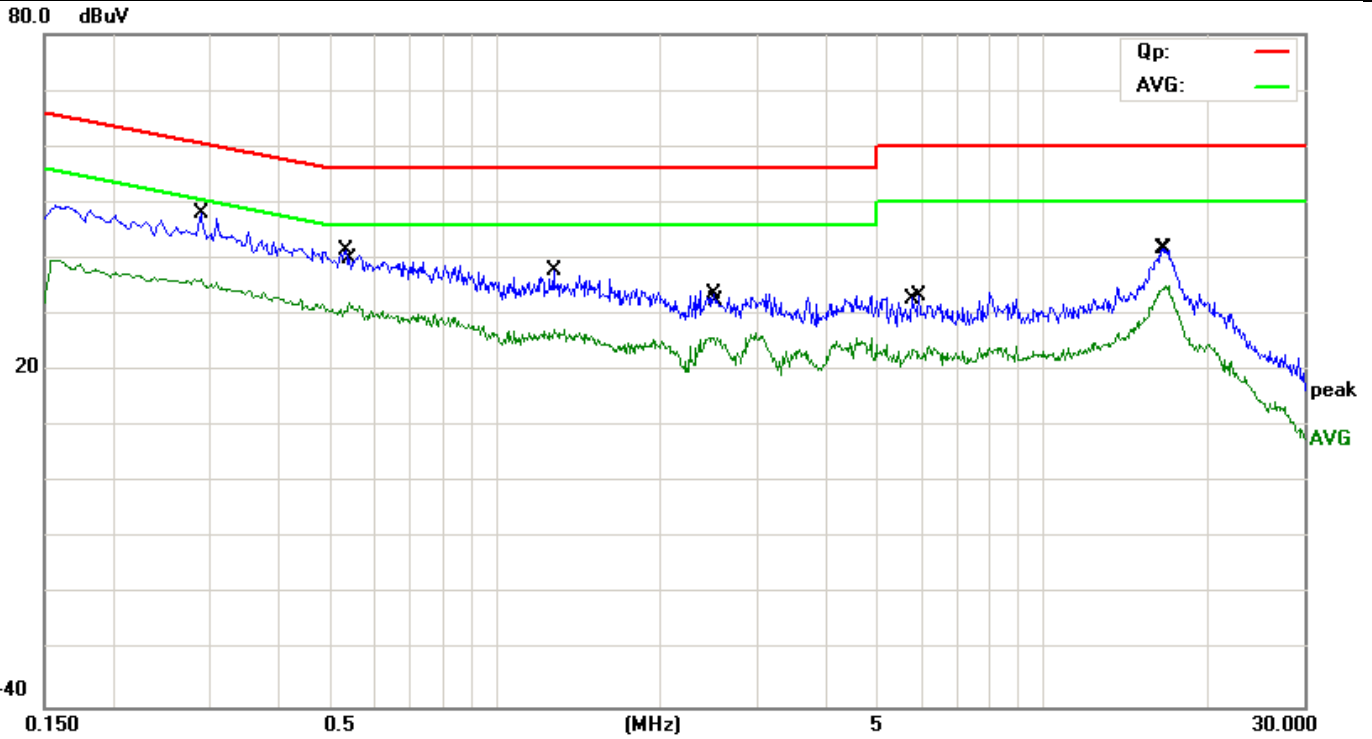

No.	Mk.	Freq. MHz	Reading Level dBuV	Correct Factor dB	Measure- ment dBuV	Limit dBuV	Over dB	Detector	Comment
1	*	0.2900	38.59	9.59	48.18	60.52	-12.34	QP	
2		0.2900	26.82	9.59	36.41	50.52	-14.11	AVG	
3		0.5340	31.76	9.59	41.35	56.00	-14.65	QP	
4		0.5420	22.45	9.59	32.04	46.00	-13.96	AVG	
5		1.2780	28.26	9.60	37.86	56.00	-18.14	QP	
6		1.2780	17.63	9.60	27.23	46.00	-18.77	AVG	
7		2.5060	24.15	9.61	33.76	56.00	-22.24	QP	
8		2.5420	16.37	9.61	25.98	46.00	-20.02	AVG	
9		5.8100	14.06	9.64	23.70	50.00	-26.30	AVG	
10		5.9460	23.74	9.64	33.38	60.00	-26.62	QP	
11		16.5700	32.15	9.71	41.86	60.00	-18.14	QP	
12		16.7700	25.57	9.71	35.28	50.00	-14.72	AVG	

*:Maximum data x:Over limit !:over margin

5.4 Radiated Emission

5.4.1 Requirement

According to FCC section 15.247(d), In addition, radiated emissions which fall in the restricted bands, as defined in §15.205(a), must also comply with the radiated emission limits specified in §15.209(a) (see §15.205(c)).

According to FCC section 15.209(a), Except as provided elsewhere in this subpart, the emissions from an intentional radiator shall not exceed the field strength levels specified in the following table:

Frequency (MHz)	Field Strength ($\mu\text{V}/\text{m}$ at 3-meter)	Test Distance (m)	Field Strength ($\text{dB}\mu\text{V}/\text{m}$ at 3-meter)
0.009 - 0.490	$2400/F(\text{kHz})$	300	
0.490 - 1.705	$24000/F(\text{kHz})$	30	
1.705-30	30	30	
30-88	100	3	40
88-216	150	3	43.5
216-960	200	3	46
Above 960	500	3	54

Note:

1. For Above 1000MHz, the emission limit in this paragraph is based on measurement instrumentation employing an average detector, measurement using instrumentation with a peak detector function, corresponding to 20dB above the maximum permitted average limit.

2. For above 1000MHz, limit field strength of harmonics: 54dBuV/m@3m (AV) and 74dBuV/m@3m (PK)

In addition, radiated emissions which fall in the restricted bands, as defined in §15.205(a), must also comply with the radiated emission limits specified in §15.209(a) (see §15.205(c)).

5.4.2 Test Configuration

Test Setup:

1) For radiated emissions from 9kHz to 30MHz

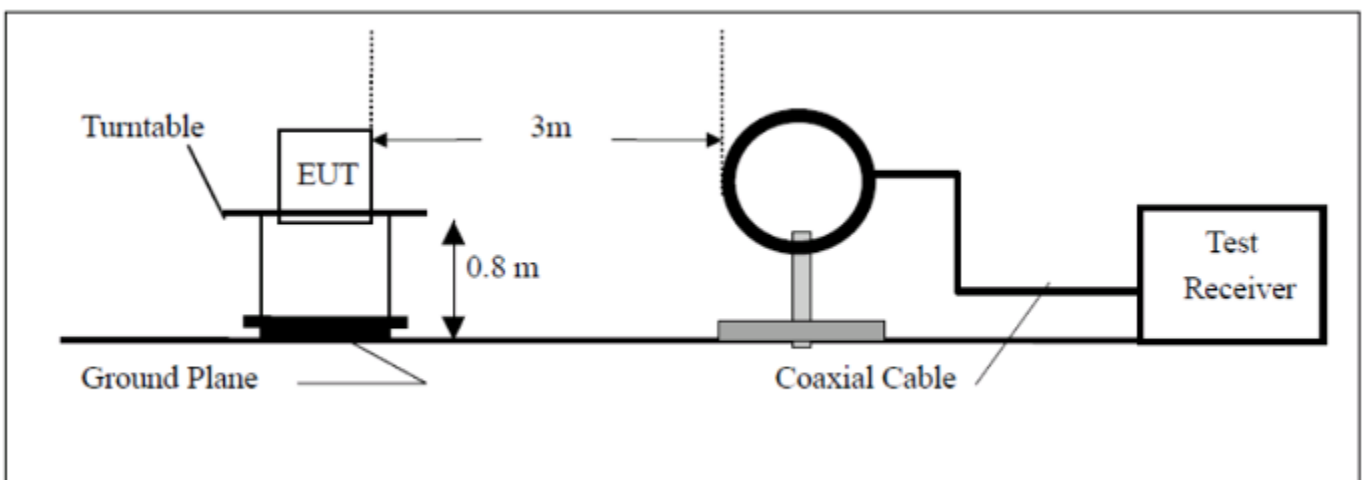

2) For radiated emissions from 30MHz to1GHz

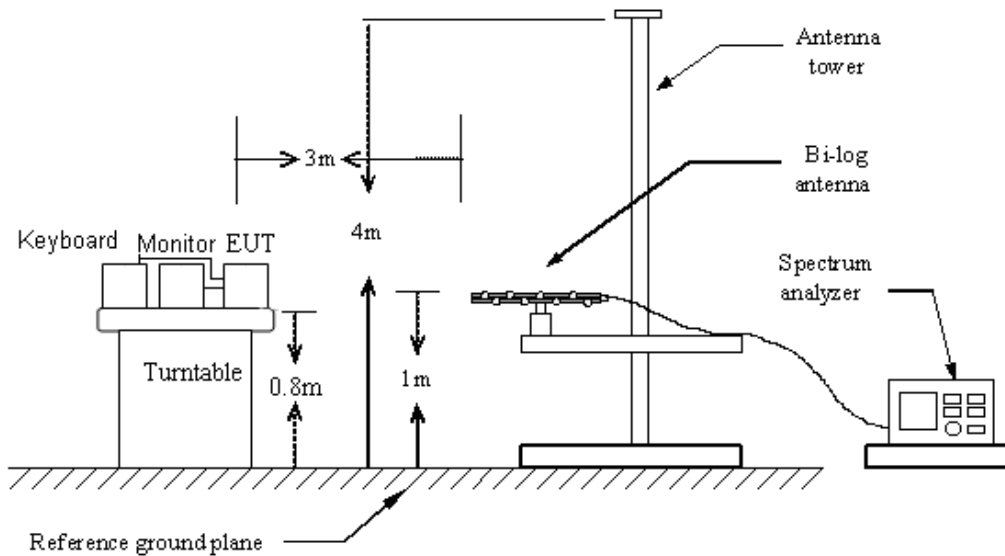

3) For radiated emissions above 1GHz

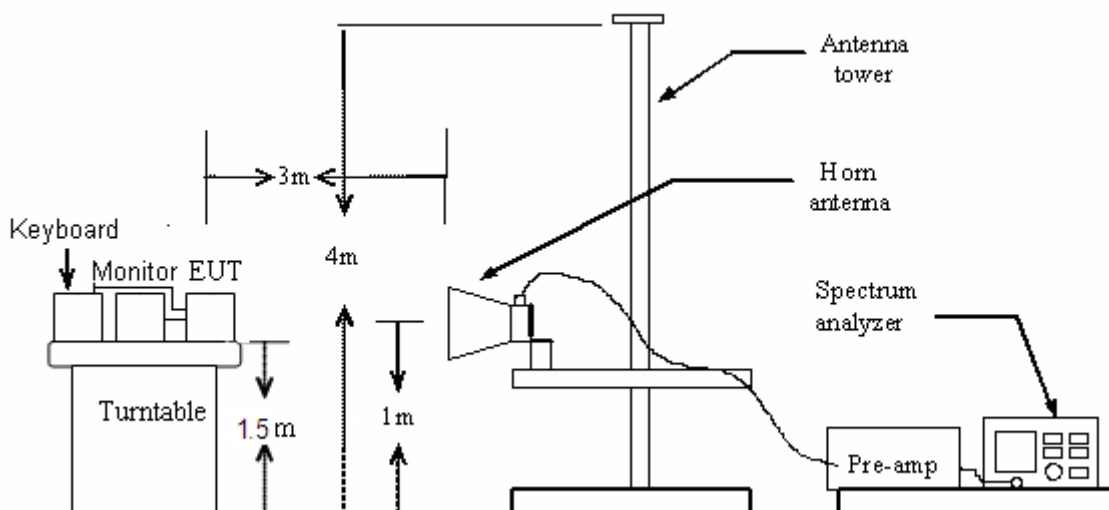
**5.4.3 Test Procedure:**

1. For frequencies above 1GHz, the frequencies of maximum emission was recorded by manually positioning the antenna close to the EUT and by moving the antenna over all sides of the EUT while observing a spectral display.
2. The EUT was placed on the top of a rotating table 1.5 meters above the ground at a 3 meter chamber. The table was rotated 360 degrees to determine the position of the highest radiation.
3. The EUT was set 3 meters away from the interference-receiving antenna, which was mounted on the top of a variable-height antenna tower.
4. The antenna height is varied from one meter to four meters above the ground to determine the maximum value of the field strength. Both horizontal and vertical polarizations of the antenna are set to make the measurement.
5. For each suspected emission, the EUT was arranged to its worst case and then the antenna was tuned to heights from 1 meter to 4 meters and the rote table was turned from 0 degrees to 360 degrees to find the maximum reading.
6. For frequencies above 1GHz, horn antenna mouth should face to the EUT all the time when rise or fall.
7. Set the spectrum analyzer in the following setting as:

Below 1GHz: PEAK: RBW=100 kHz / VBW=300 kHz / Sweep=AUTO QP: RBW=120 kHz / Sweep=AUTO
Above 1GHz: (a)PEAK: RBW=VBW=1MHz / Sweep=AUTO
(b)AVERAGE: RBW=1MHz / VBW=10Hz / Sweep=AUTO

The test-receiver system was set to Peak Detect Function and Specified Bandwidth with Maximum Hold Mode.

8. If the emission level of the EUT in peak mode was 10dB lower than the limit specified, then testing could be stopped and the peak values of the EUT would be reported. Otherwise the emissions that did not have 10dB margin would be re-tested one by one using peak, quasi-peak or average method as specified and then reported in a data sheet.

5.4.4 Test Result

Pass

Remark:

1. During the test, pre-scan the 802.11b, 802.11g, 802.11n(20M)modulation, and found the 802.11b modulation which it is worse case in above 1GHz and the 802.11b Low channel modulation which it is worse case in below 1GHz.

2. Pre-scan all kind of the place mode (X-axis, Y-axis, Z-axis), and found the Y-axis which it is worse case.

Please refer the following pages.

Below 1GHz:

EUT:	The Edge Mini	M/N:	The Edge Mini Alkaline Tablet
Mode:	802.11b-CH1	Polarization:	Horizontal
Test by:	John	Power:	DC 6V by Battery
Temperature: / Humidity	23.4°C / 53.1%	Test date:	2016-04-06

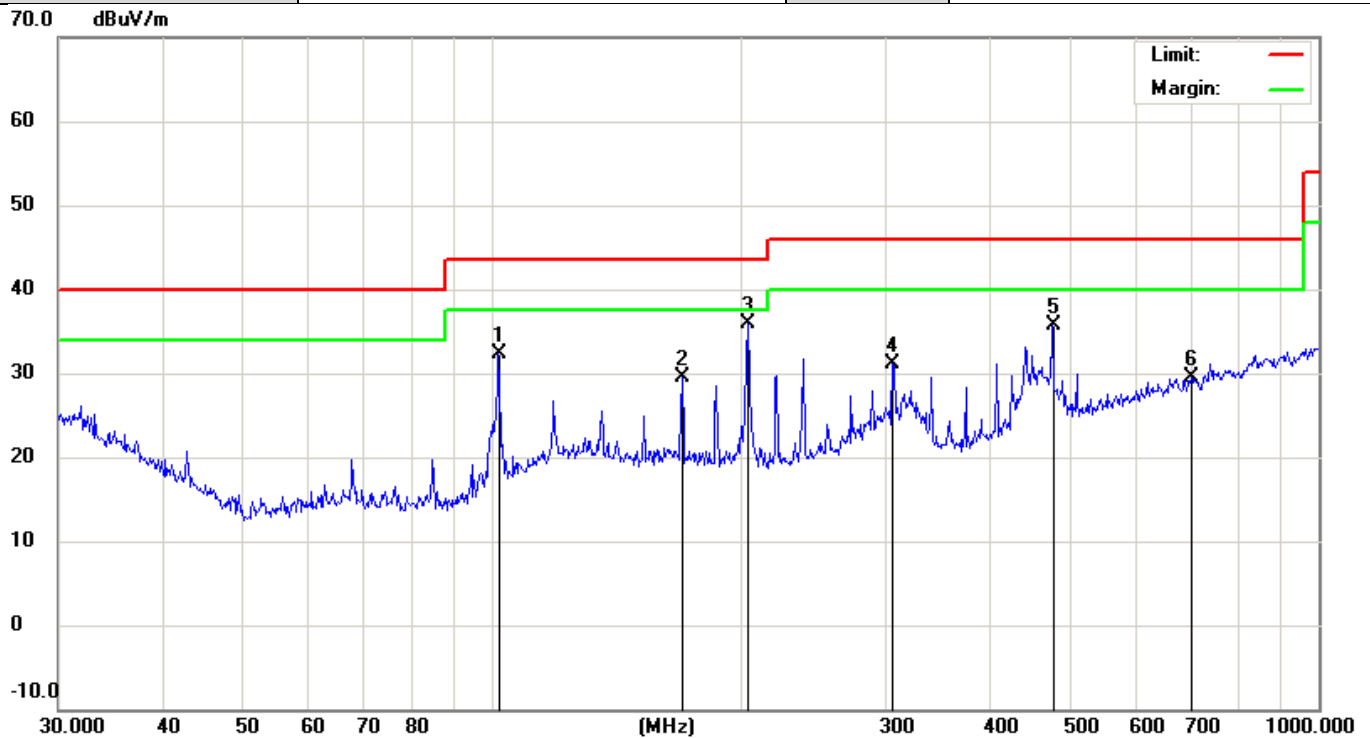

No.	Mk.	Freq. MHz	Reading Level dBuV	Correct Factor dB	Measure- ment dBuV/m	Limit dBuV/m	Over dB	Antenna Height cm	Table Degree	Comment
1		102.0014	18.49	13.78	32.27	43.50	-11.23	QP		
2		170.1947	12.26	17.19	29.45	43.50	-14.05	QP		
3	*	204.2377	19.19	16.76	35.95	43.50	-7.55	QP		
4		305.6799	13.33	17.76	31.09	46.00	-14.91	QP		
5		477.1694	14.07	21.56	35.63	46.00	-10.37	QP		
6		701.7610	4.79	24.70	29.49	46.00	-16.51	QP		

*:Maximum data x:Over limit !:over margin

EUT:	The Edge Mini	M/N:	The Edge Mini Alkaline Tablet
Mode:	802.11b-CH1	Polarization:	Vertical
Test by:	John	Power:	DC 6V by Battery
Temperature: / Humidity	23.4°C / 53.1%	Test date:	2016-04-06

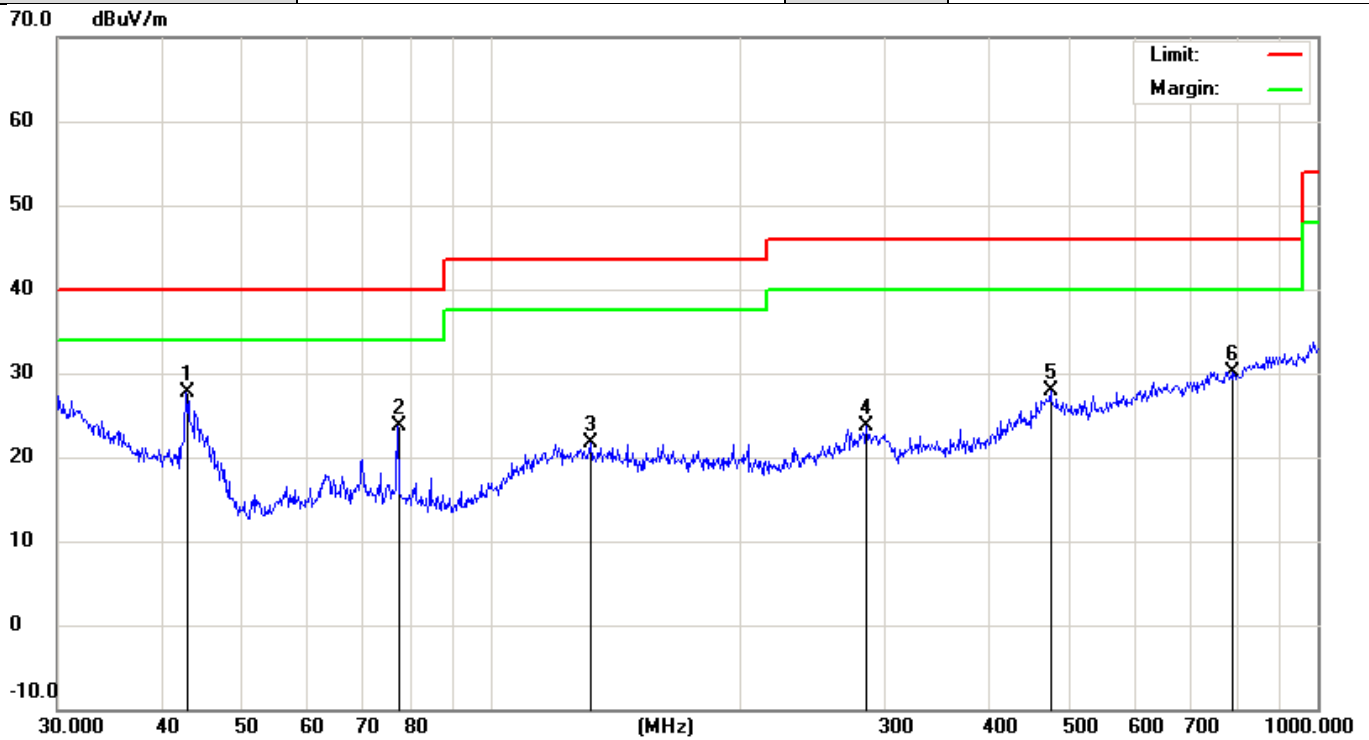

No.	Mk.	Freq. MHz	Reading Level dBuV	Correct Factor dB	Measure- ment dBuV/m	Limit dBuV/m	Over dB	Antenna Height cm	Table Degree	Detector	Comment
1	*	42.8998	13.38	14.35	27.73	40.00	-12.27			QP	
2		77.3212	12.20	11.48	23.68	40.00	-16.32			QP	
3		132.2205	4.06	17.59	21.65	43.50	-21.85			QP	
4		284.9766	4.27	19.40	23.67	46.00	-22.33			QP	
5		475.4990	6.43	21.47	27.90	46.00	-18.10			QP	
6		790.6186	4.15	26.00	30.15	46.00	-15.85			QP	

*:Maximum data x:Over limit !:over margin

Above 1GHz

EUT:	The Edge Mini	M/N:	The Edge Mini Alkaline Tablet
Mode:	802.11b-CH1	Polarization:	Horizontal
Test by:	John	Power:	DC 6V by Battery
Temperature: / Humidity	23.5°C / 52.8%	Test date:	2016-04-07

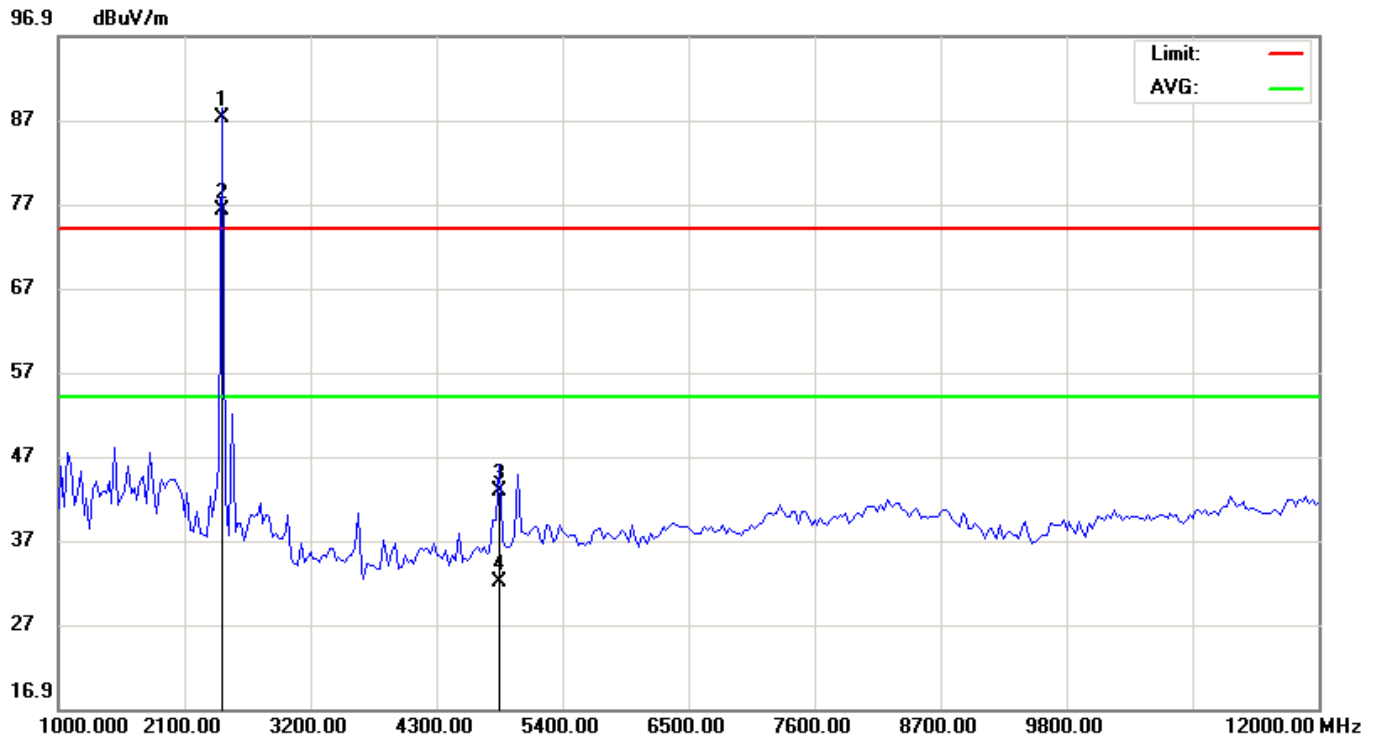

No.	Mk.	Freq. MHz	Reading Level dBuV	Correct Factor dB	Measure- ment dBuV/m	Limit dBuV/m	Over dB	Detector	Antenna Height cm	Table Degree degree	Comment
1	X	2412.000	95.66	-8.41	87.25	74.00	13.25	peak			
2	*	2412.000	84.67	-8.41	76.26	54.00	22.26	AVG			
3		4824.000	48.76	-5.91	42.85	74.00	-31.15	peak			
4		4824.000	37.98	-5.91	32.07	54.00	-21.93	AVG			

*:Maximum data x:Over limit !:over margin

EUT:	The Edge Mini	M/N:	The Edge Mini Alkaline Tablet
Mode:	802.11b-CH1	Polarization:	Horizontal
Test by:	John	Power:	DC 6V by Battery
Temperature: / Humidity	23.5°C / 52.8%	Test date:	2016-04-07

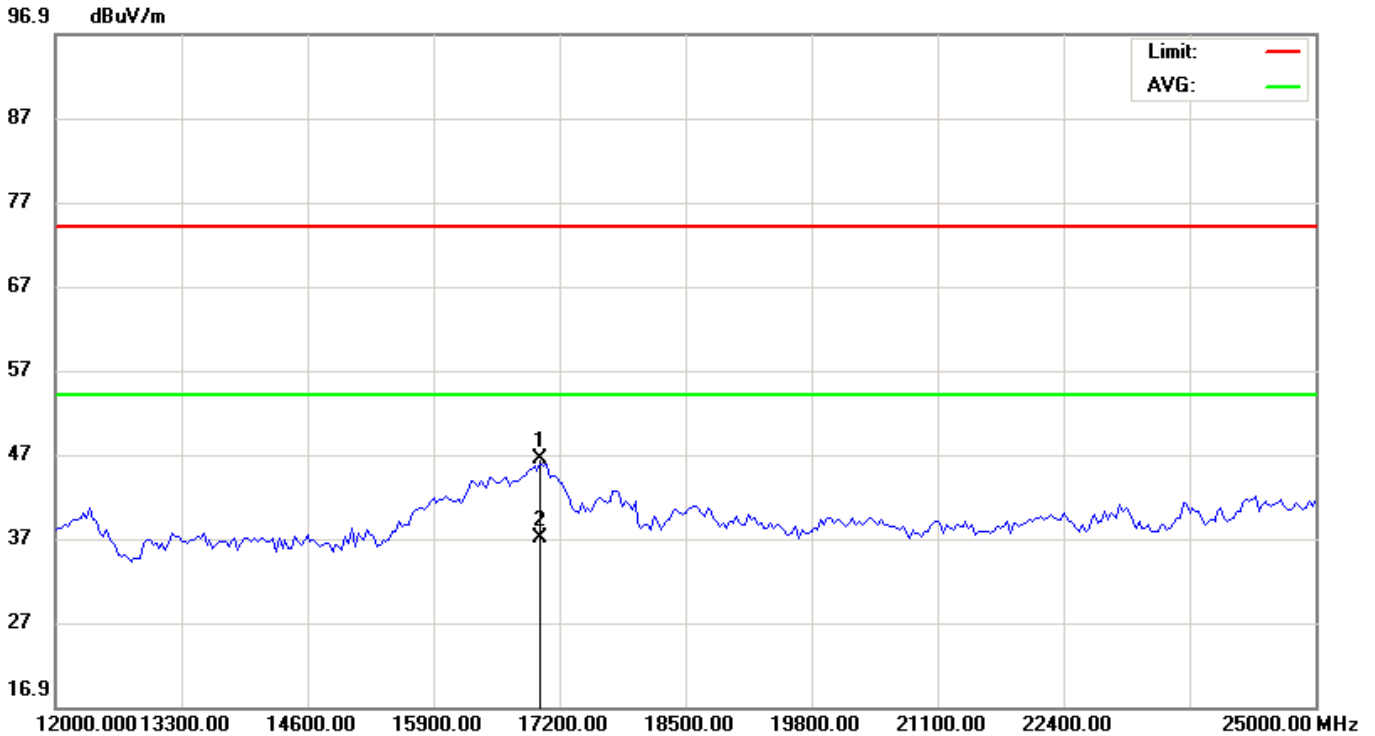

No.	Mk.	Freq. MHz	Reading Level dBuV	Correct Factor dB	Measure- ment dBuV/m	Limit dBuV/m	Over dB	Detector	Antenna Height cm	Table Degree	Comment
1		17005.00	39.42	6.90	46.32	74.00	-27.68	peak			
2	*	17005.00	30.06	6.90	36.96	54.00	-17.04	AVG			

*:Maximum data x:Over limit !:over margin

EUT:	The Edge Mini	M/N:	The Edge Mini Alkaline Tablet
Mode:	802.11b-CH1	Polarization:	Vertical
Test by:	John	Power:	DC 6V by Battery
Temperature: / Humidity	23.5°C / 52.8%	Test date:	2016-04-07

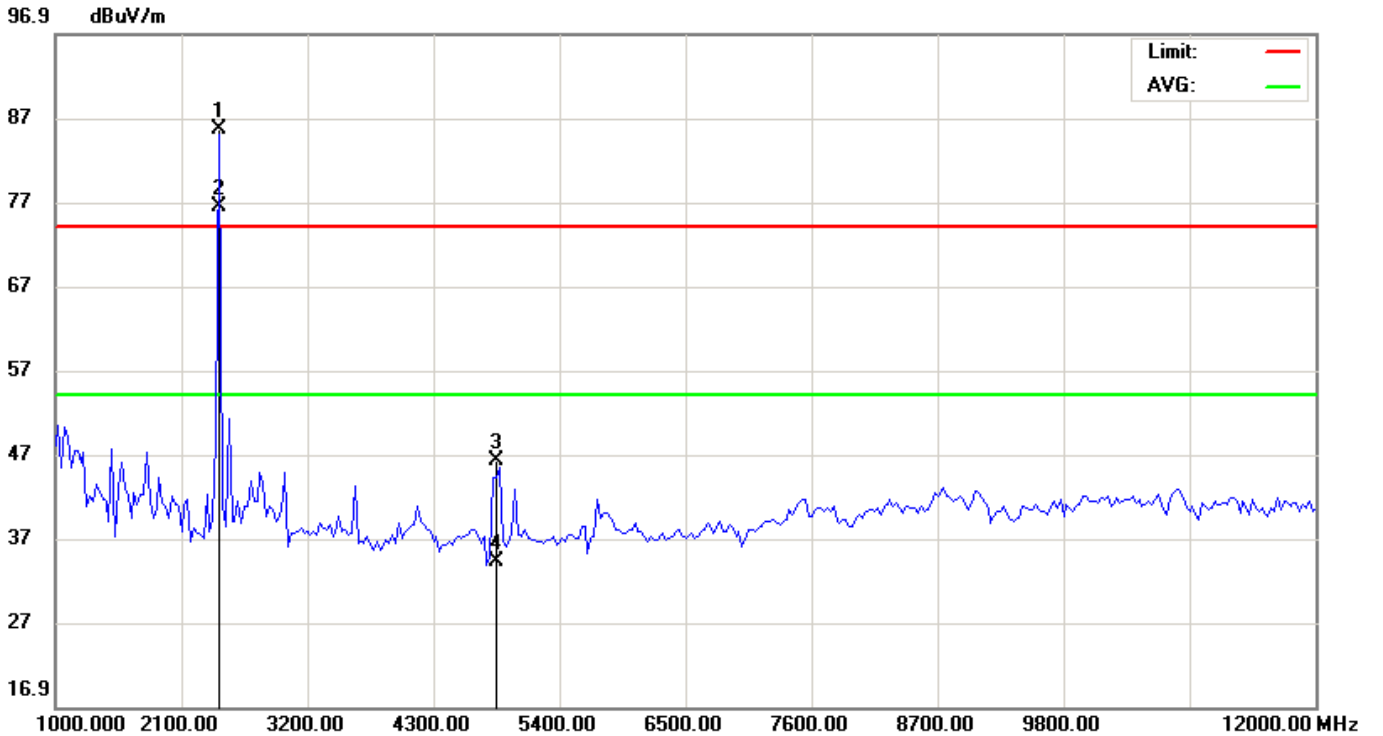

No.	Mk.	Freq. MHz	Reading Level dBuV	Correct Factor dB	Measure- ment dBuV/m	Limit dBuV/m	Over dB	Detector	Antenna Height cm	Table Degree degree	Comment
1	X	2412.100	94.01	-8.41	85.60	74.00	11.60	peak			
2	*	2412.100	84.86	-8.41	76.45	54.00	22.45	AVG			
3		4824.000	52.06	-5.91	46.15	74.00	-27.85	peak			
4		4824.000	40.05	-5.91	34.14	54.00	-19.86	AVG			

*:Maximum data x:Over limit !:over margin

EUT:	The Edge Mini	M/N:	The Edge Mini Alkaline Tablet
Mode:	802.11b-CH1	Polarization:	Vertical
Test by:	John	Power:	DC 6V by Battery
Temperature: / Humidity	23.5°C / 52.8%	Test date:	2016-04-07

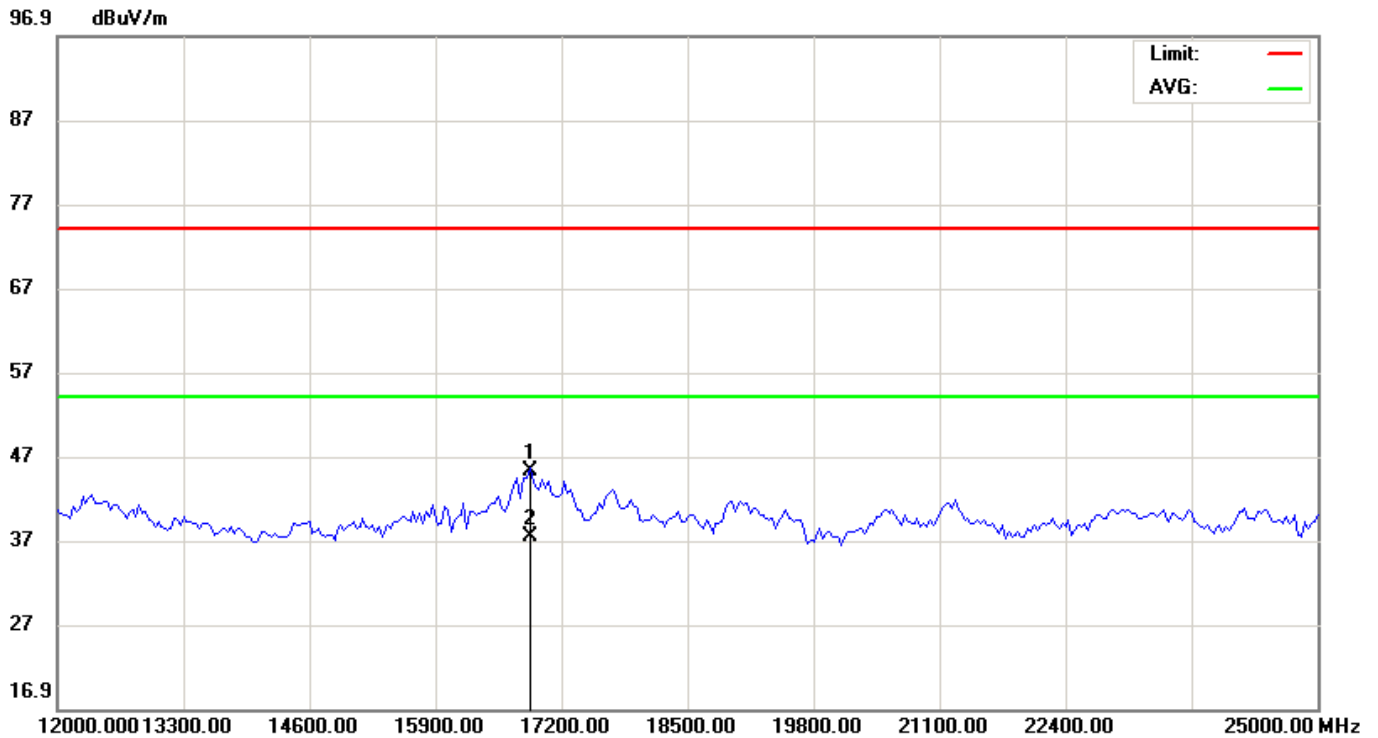

No.	Mk.	Freq. MHz	Reading Level dBuV	Correct Factor dB	Measure- ment dBuV/m	Limit dBuV/m	Over dB	Detector	Antenna Height cm	Table Degree degree	Comment
1		16875.00	38.76	6.51	45.27	74.00	-28.73	peak			
2	*	16875.00	30.86	6.51	37.37	54.00	-16.63	AVG			

*:Maximum data x:Over limit !:over margin

5.5 Conducted Peak Output Power

5.5.1 Requirement

According to FCC section 15.247(b)(3), for systems using digital modulation in the 902-928 MHz, 2400-2483.5 MHz, and 5725-5850 MHz bands: 1 Watt. As an alternative to a peak power measurement, compliance with the one Watt limit can be based on a measurement of the maximum conducted output power. Maximum Conducted Output Power is defined as the total transmit power delivered to all antennas and antenna elements averaged across all symbols in the signaling alphabet when the transmitter is operating at its maximum power control level. Power must be summed across all antennas and antenna elements. The average must not include any time intervals during which the transmitter is off or is transmitting at a reduced power level. If multiple modes of operation are possible (e.g., alternative modulation methods), the maximum conducted output power is the highest total transmit power occurring in any mode.

5.5.2 Block Diagram of Test Setup

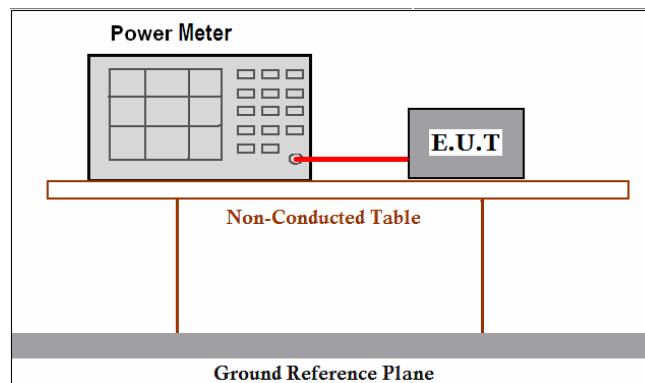

5.5.3 Test Procedure

1. Remove the antenna from the EUT and then connect a low attention attenuation RF cable (Cable loss =0.5dB) from the antenna port to the power meter.
2. Measurement using an RF peak power meter.
3. Report the worse case.

5.5.4 Test Result

Test Item:	Peak Output Power	Temperature :	20°C
Test Engineer:	John	Relative Humidity :	55%

Mode	Channel	Frequency (MHz)	Peak Output Power(dBm)	Limit		Pass/Fail
				(mW)	(dBm)	
802.11b	Low	2412	4.88	1000	30	Pass
	Middle	2437	4.92	1000	30	Pass
	High	2462	5.08	1000	30	Pass
802.11g	Low	2412	5.55	1000	30	Pass
	Middle	2437	5.65	1000	30	Pass
	High	2462	5.98	1000	30	Pass
802.11n (20MHz)	Low	2412	5.86	1000	30	Pass
	Middle	2437	5.89	1000	30	Pass
	High	2462	6.01	1000	30	Pass

5.6 6dB Emission Bandwidth

5.6.1 Test Requirement

Systems using digital modulation techniques may operate in the 902–928 MHz, 2400–2483.5 MHz, and 5725–5850 MHz bands. The minimum 6 dB bandwidth shall be at least 500 kHz.

5.6.2 Block Diagram of Test Setup

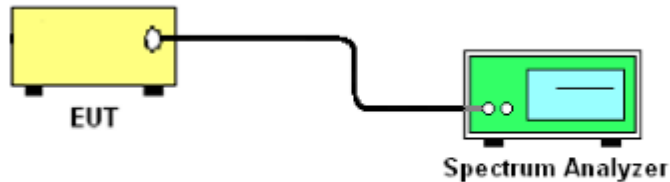

5.6.3 Test Procedure

According to KDB 558074 D01 DTS Meas Guidance v03r02 clause 8.1 Option 1:

- a) Set RBW = 100 kHz.
- b) Set the video bandwidth (VBW) $\geq 3 \times$ RBW.
- c) Detector = Peak.
- d) Trace mode = max hold.
- e) Sweep = auto couple.
- f) Allow the trace to stabilize.
- g) Measure the maximum width of the emission that is constrained by the frequencies associated with the two outermost amplitude points (upper and lower frequencies) that are attenuated by 6 dB relative to the maximum level measured in the fundamental emission.

5.6.4 Test Result

Pass

Test Item:	6dB Emission Bandwidth	Temperature :	20°C
Test Engineer:	John	Relative Humidity :	55%

Mode	Channel	Frequency (MHz)	6dB Bandwidth(MHz)	Limit(KHz)
802.11b	Low	2412	9.974	≥ 500
	Middle	2437	9.979	≥ 500
	High	2462	9.609	≥ 500
802.11g	Low	2412	16.542	≥ 500
	Middle	2437	16.606	≥ 500
	High	2462	16.596	≥ 500
802.11n (20MHz)	Low	2412	17.798	≥ 500
	Middle	2437	17.786	≥ 500
	High	2462	17.835	≥ 500

802.11 b Mode

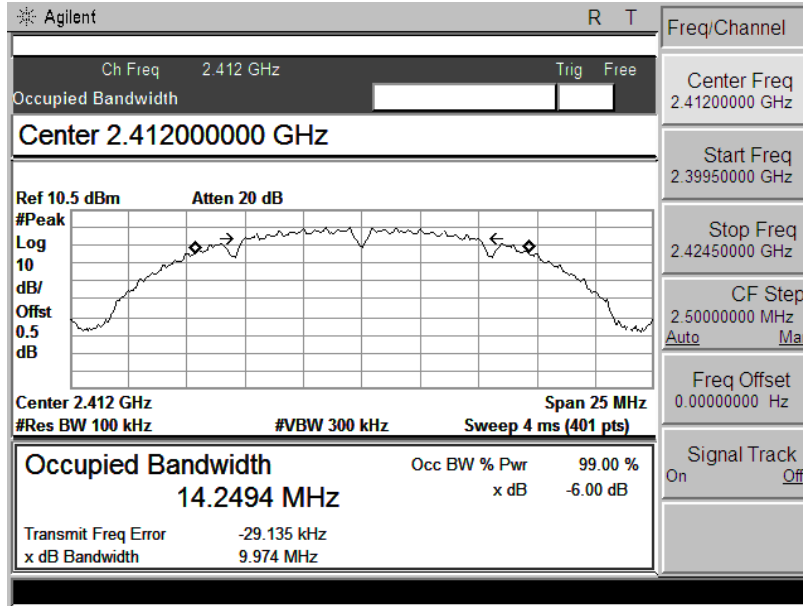

Ch 1

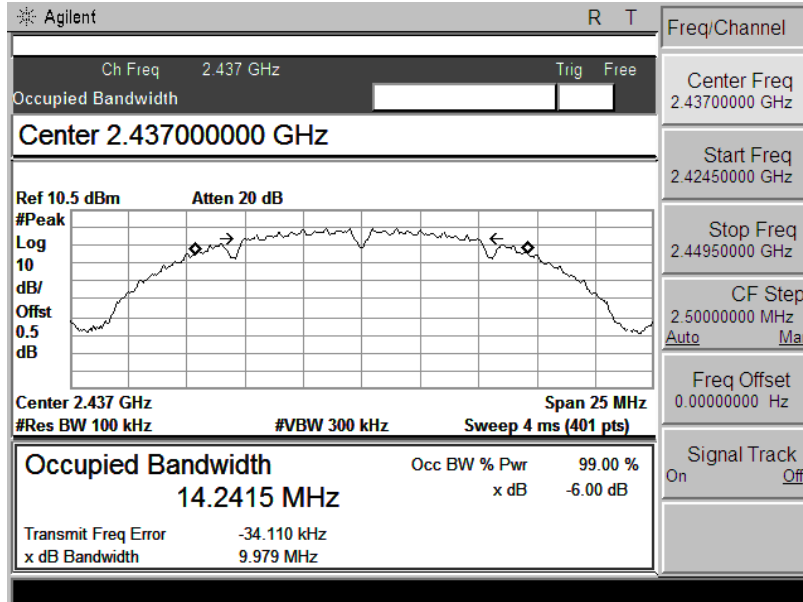

Ch 6

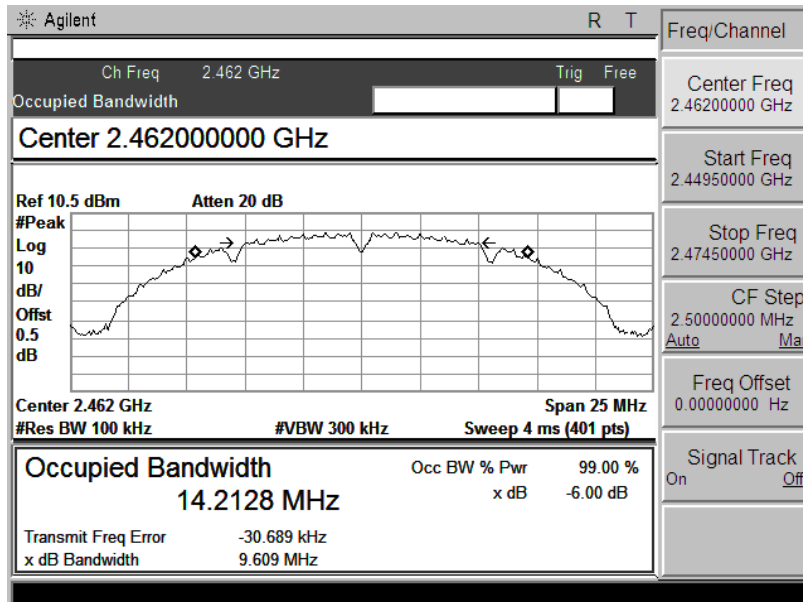

Ch 11

802.11 g Mode

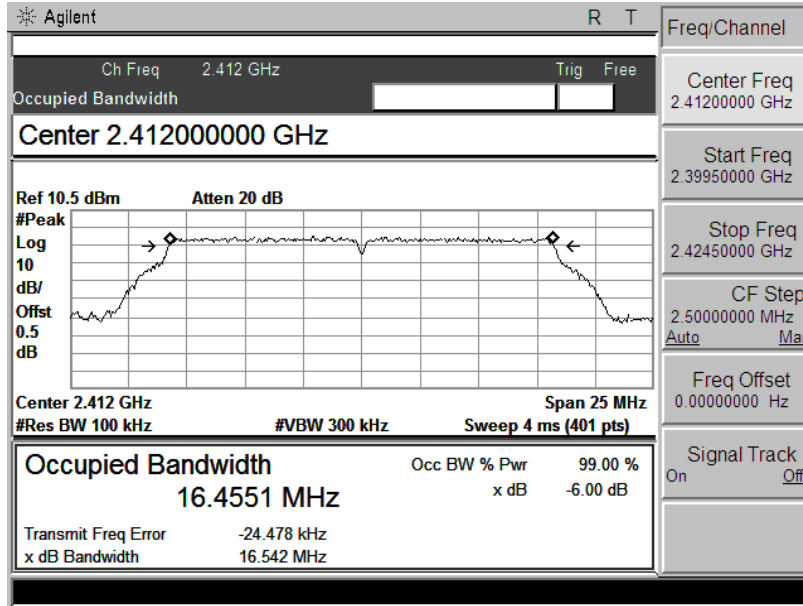

Ch 1

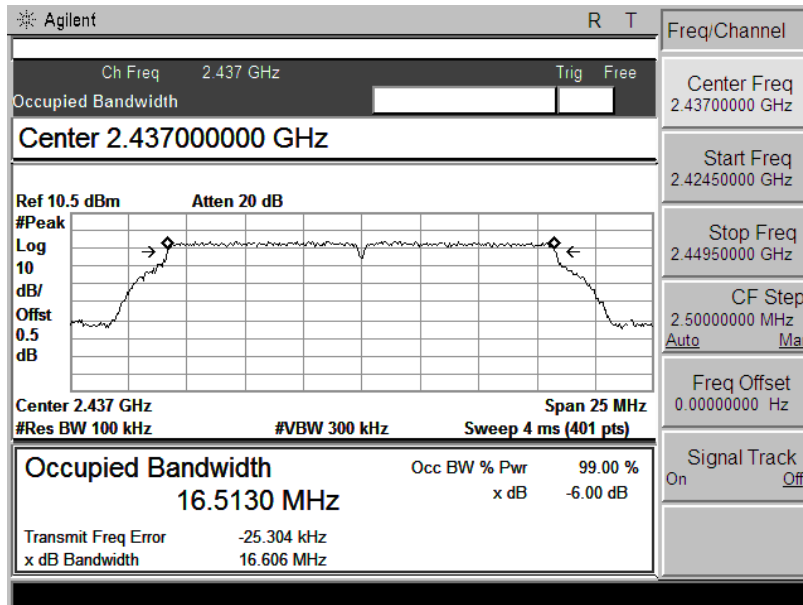

Ch 6

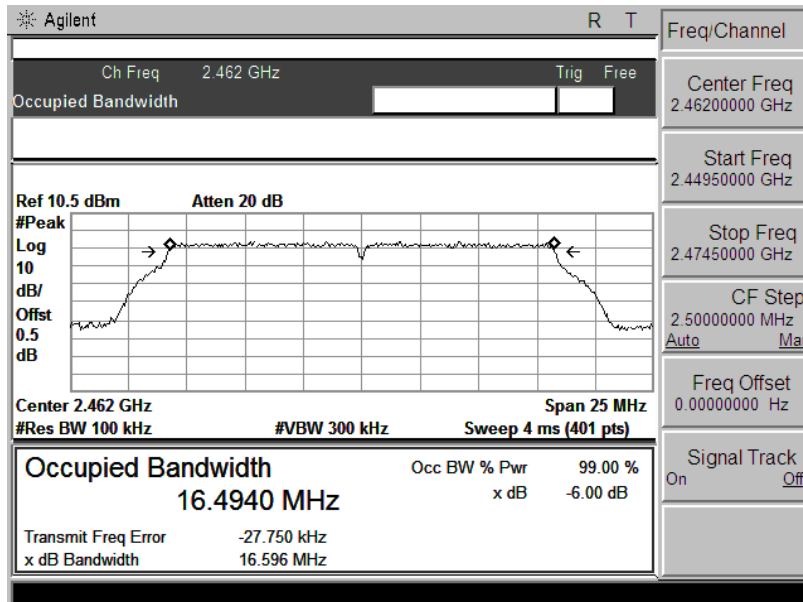

Ch 11

802.11 n(20M) Mode

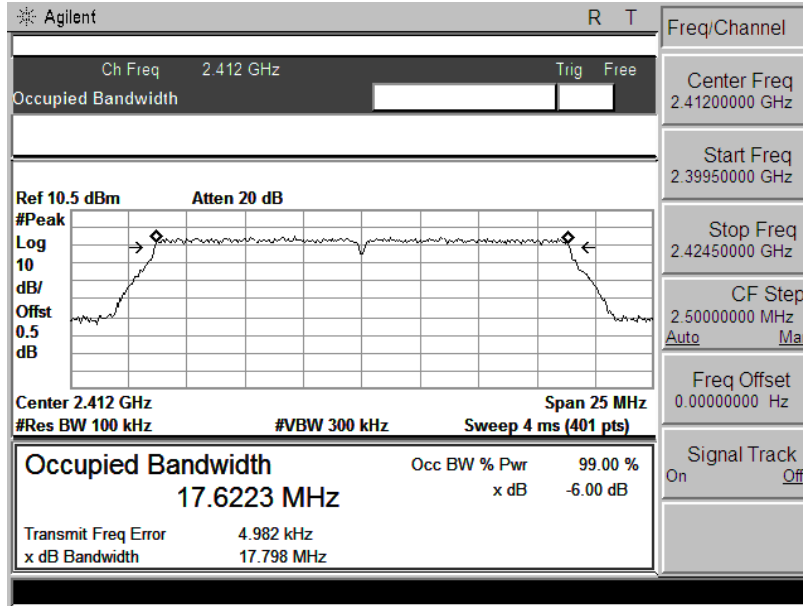

Ch 1

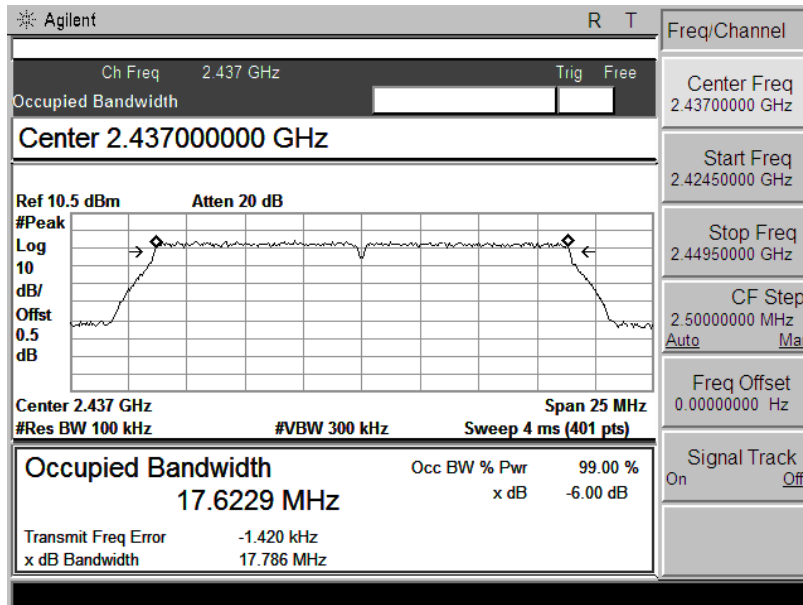

Ch 6

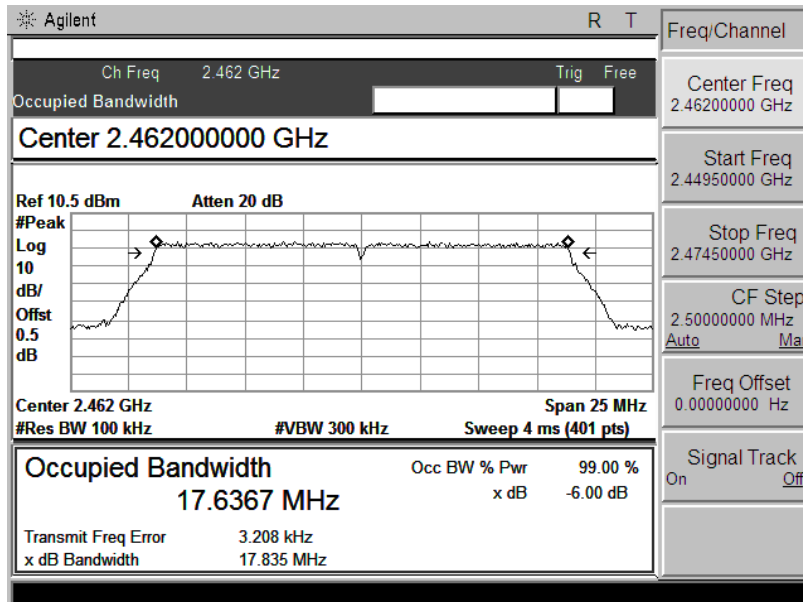

Ch 11

5.7 POWER SPECTRAL DENSITY

5.7.1 Applicable Standard

For digitally modulated systems, the power spectral density conducted from the intentional radiator to the antenna shall not be greater than 8 dBm in any 3 kHz band during any time interval of continuous transmission. This power spectral density shall be determined in accordance with the provisions of paragraph (b) of this section. The same method of determining the conducted output power shall be used to determine the power spectral density.

5.7.2 Block Diagram of Test Setup

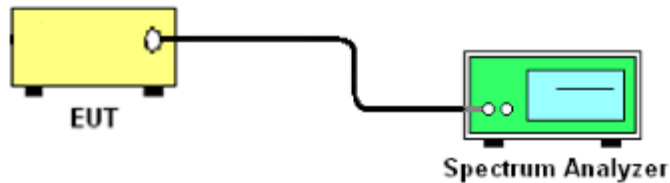

5.7.3 Test Procedure

According to KDB 558074 D01 DTS Meas Guidance v03r01clause10.2:

- a) Set analyzer center frequency to DTS channel center frequency.
- b) Set the span to 1.5 times the DTS bandwidth.
- c) Set the RBW to: $3 \text{ kHz} \leq \text{RBW} \leq 100 \text{ kHz}$.
- d) Set the VBW $\geq 3 \times \text{RBW}$.
- e) Detector = peak.
- f) Sweep time = auto couple.
- g) Trace mode = max hold.
- h) Allow trace to fully stabilize.
- i) Use the peak marker function to determine the maximum amplitude level within the RBW.
- j) If measured value exceeds limit, reduce RBW (no less than 3 kHz) and repeat.

5.7.4 Test Result

Test Item:	POWER SPECTRAL DENSITY	Temperature :	20°C
Test Engineer:	John	Relative Humidity :	55%

Mode	Channel	Frequency (MHz)	PSD (dBm/100kHz)	Limit (dBm/100kHz)	Result
802.11b	Low	2412	-19.15	≤8	Pass
	Middle	2437	-19.74	≤8	Pass
	High	2462	-20.23	≤8	Pass
802.11g	Low	2412	-17.26	≤8	Pass
	Middle	2437	-17.43	≤8	Pass
	High	2462	-18.14	≤8	Pass
802.11n (20MHz)	Low	2412	-14.97	≤8	Pass
	Middle	2437	-16.94	≤8	Pass
	High	2462	-16.67	≤8	Pass

802.11 b Mode

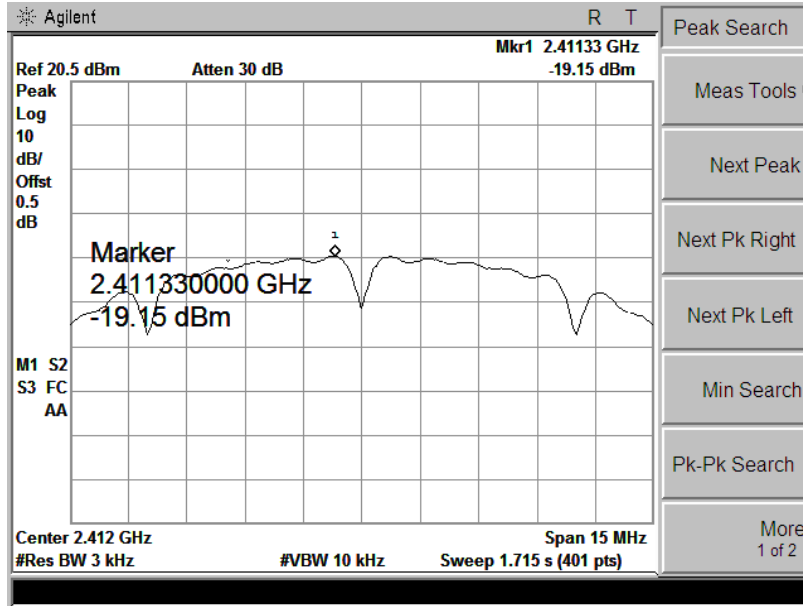

Ch 1

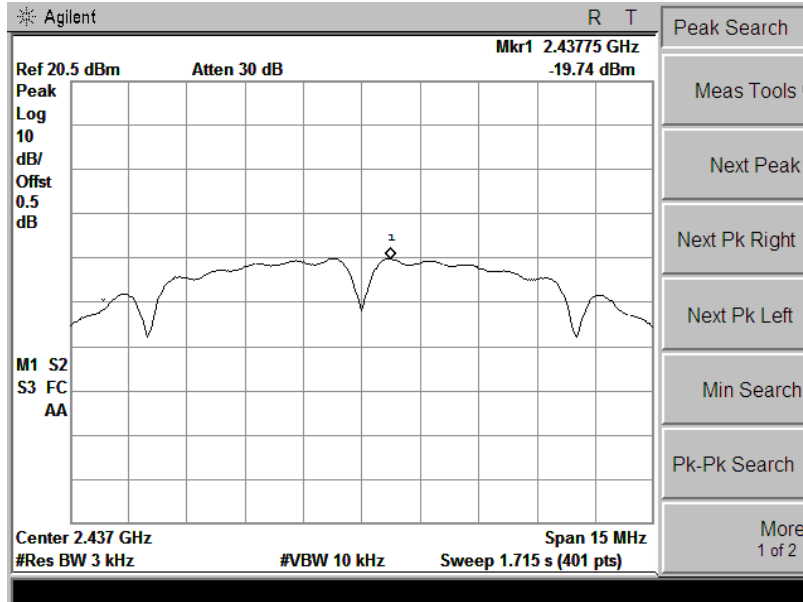

Ch 6

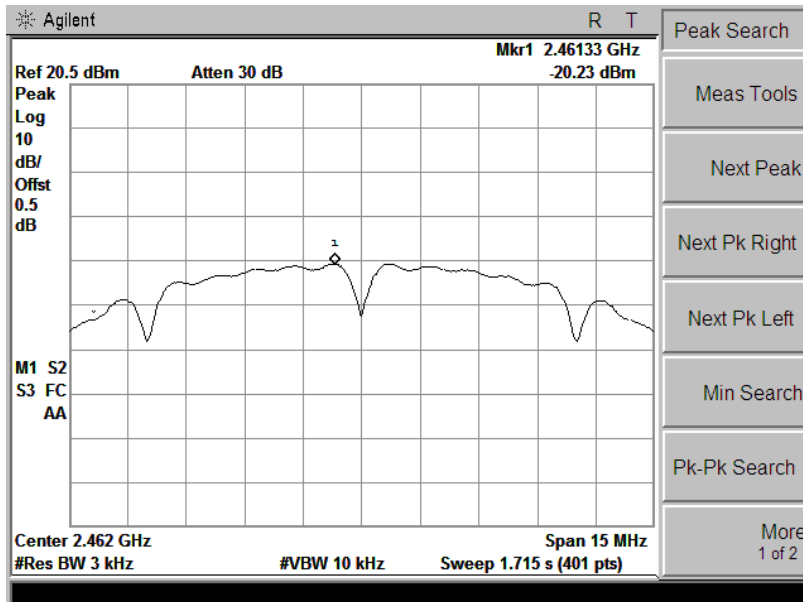

Ch 11

802.11 g Mode

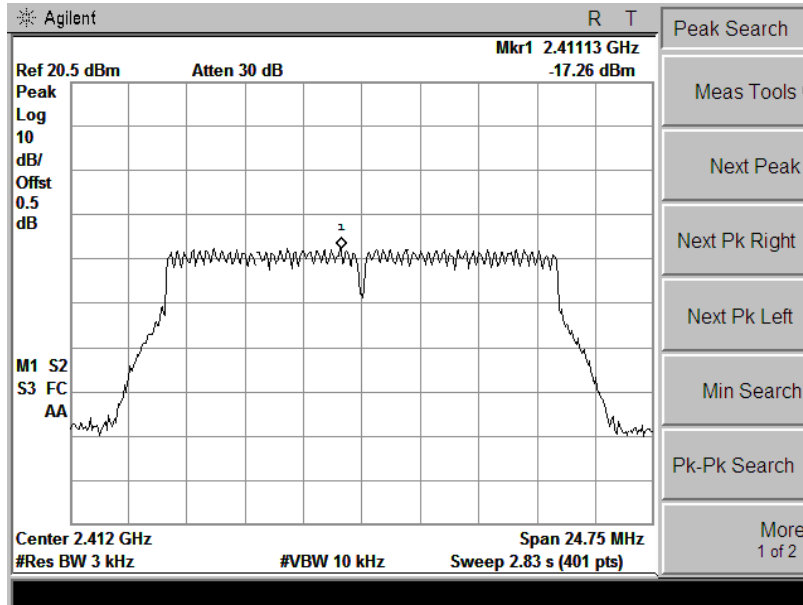

Ch 1

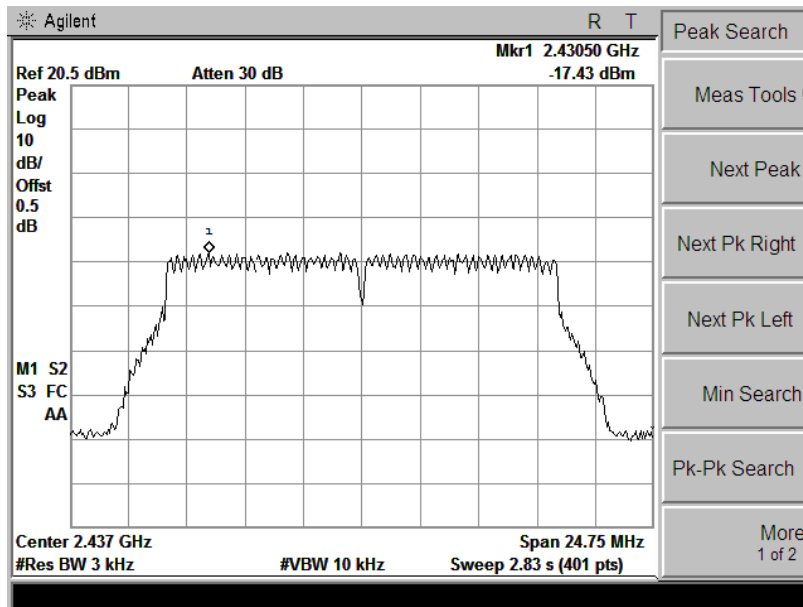

Ch 6

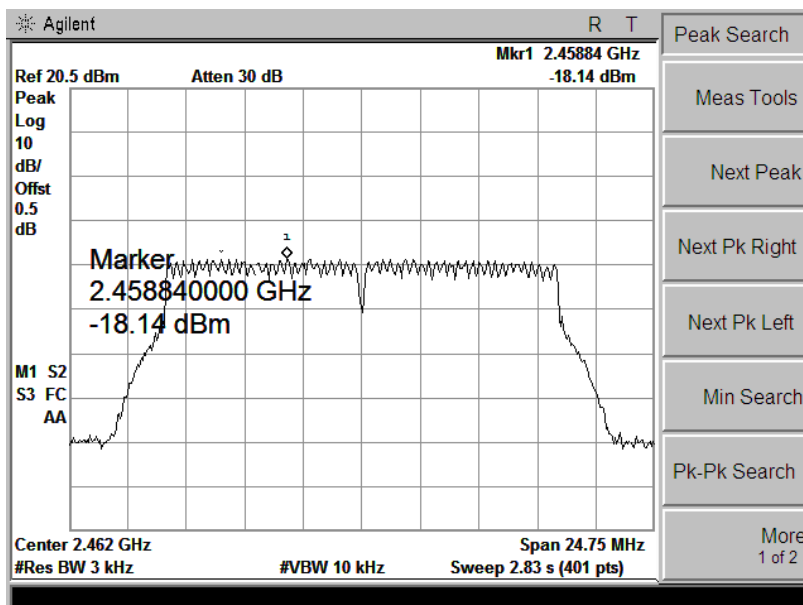

Ch 11

802.11 n(20M) Mode

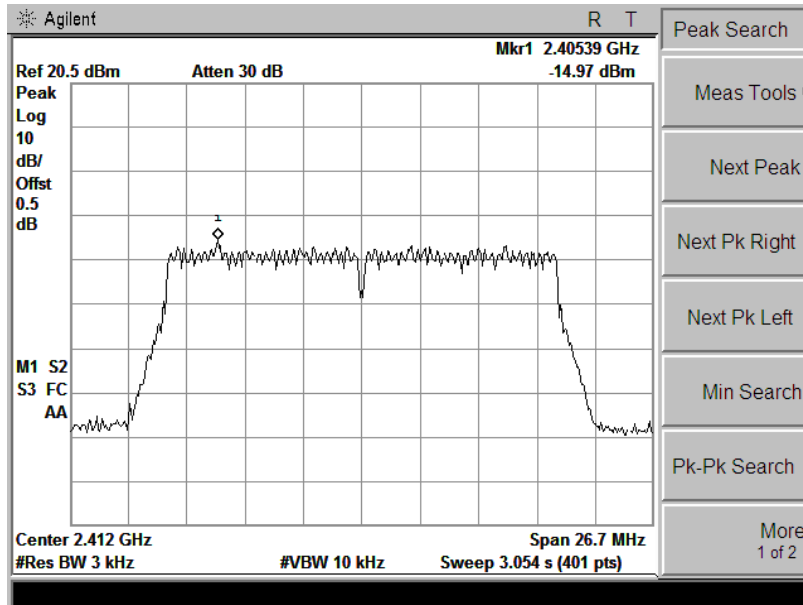

Ch 1

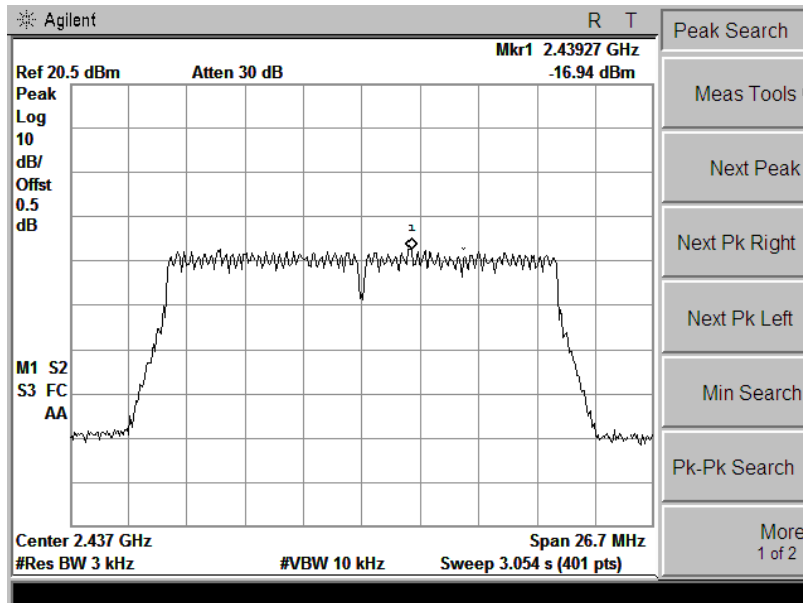

Ch 6

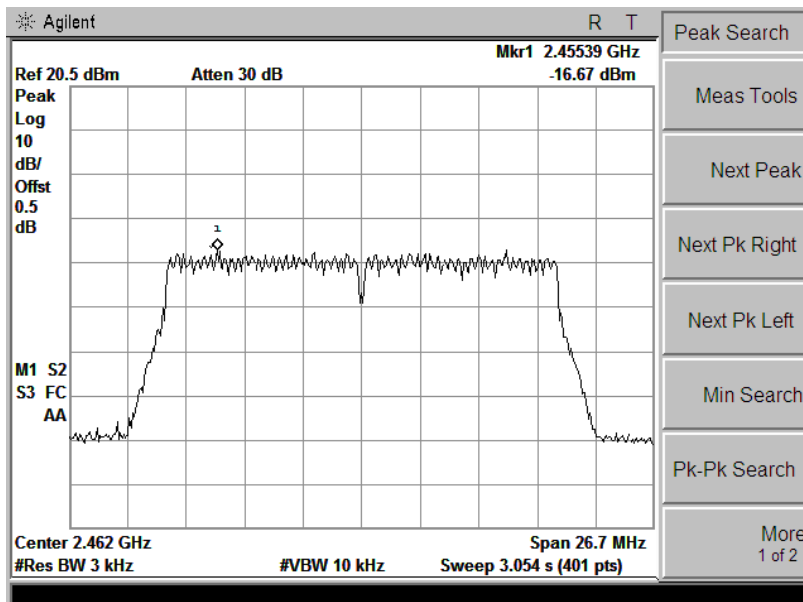

Ch 11

5.8 Band Edge and Conducted Spurious Emissions

5.8.1 Test Requirement

In any 100 kHz bandwidth outside the frequency band in which the spread spectrum or digitally modulated intentional radiator is operating, the radio frequency power that is produced by the intentional radiator shall be at least 20 dB below that in the 100 kHz bandwidth within the band that contains the highest level of the desired power, based on either an RF conducted or a radiated measurement, provided the transmitter demonstrates compliance with the peak conducted power limits. If the transmitter complies with the conducted power limits based on the use of RMS averaging over a time interval, as permitted under paragraph (b)(3) of this section, the attenuation required under this paragraph shall be 30 dB instead of 20 dB. Attenuation below the general limits specified in §15.209(a) is not required.

5.8.2 Test Procedure

1. Check the calibration of the measuring instrument using either an internal calibrator or a known signal from an external generator.
2. Remove the antenna from the EUT and then connect to a low loss RF cable from the antenna port to a EMI test receiver, then turn on the EUT and make it operate in transmitting mode. Then set it to Low Channel and High Channel within its operating range, and make sure the instrument is operated in its linear range.
3. Set both RBW and VBW of spectrum analyzer to 100 kHz with a convenient frequency span including 100 kHz bandwidth from band edge.
4. Measure the highest amplitude appearing on spectral display and set it as a reference level. Plot the graph with marking the highest point and edge frequency.
5. Repeat above procedures until all measured frequencies were complete.

5.8.3 Test Result

Pass

Remark:

During the Conducted Spurious Emissions test, pre-scan the 802.11b, 802.11g, 802.11n(20/40)modulation, and found the 802.11b modulation which it is worse case.

Test Item:	Band Edge	Temperature :	23°C
Test Engineer:	John	Relative Humidity :	65%

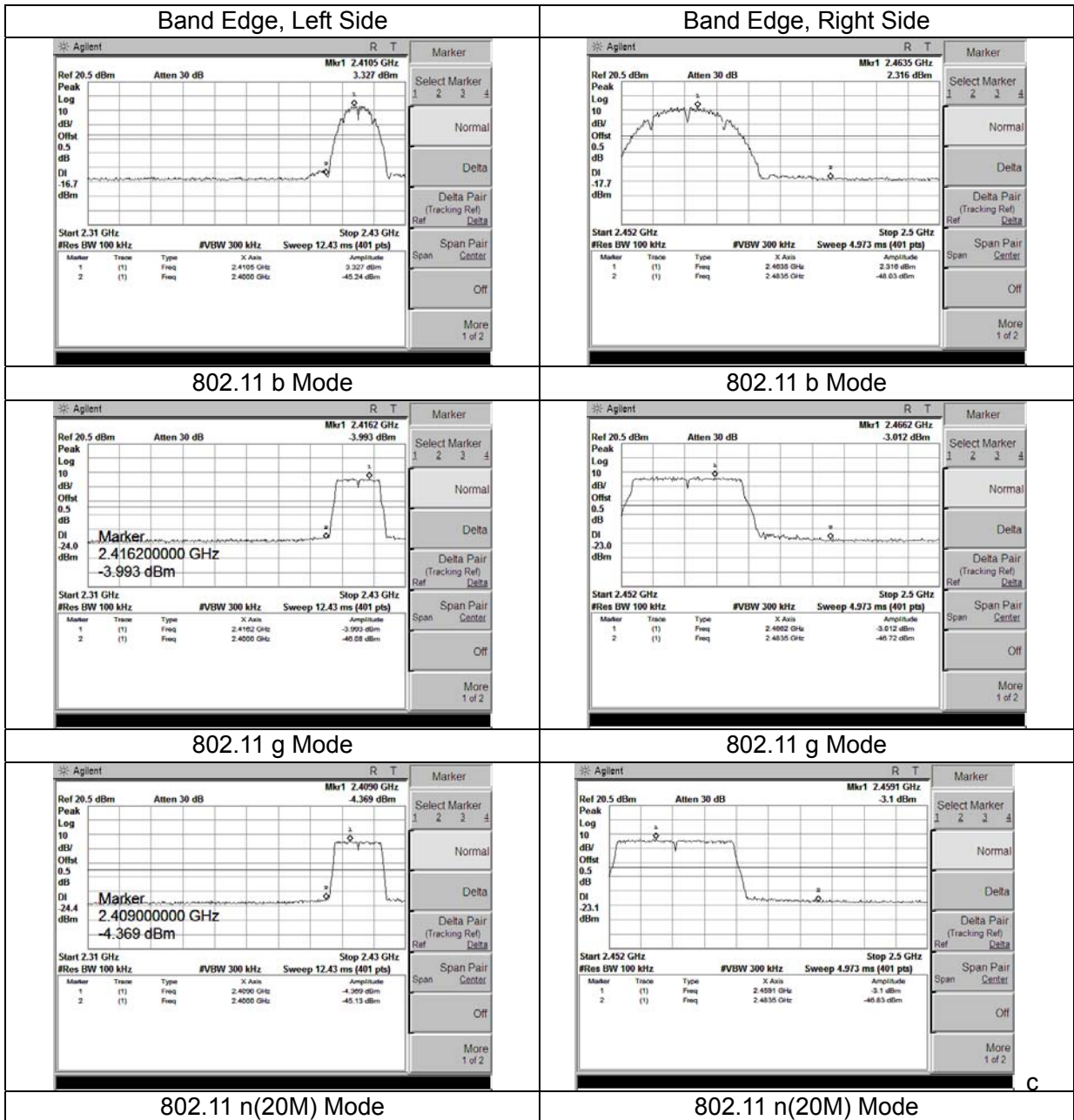

Conducted Spurious Emissions

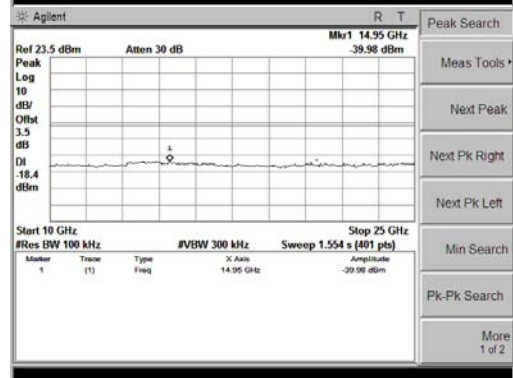
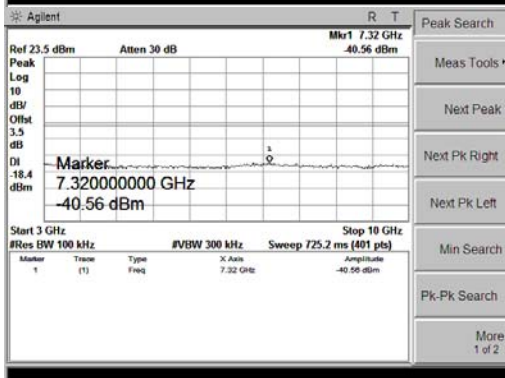
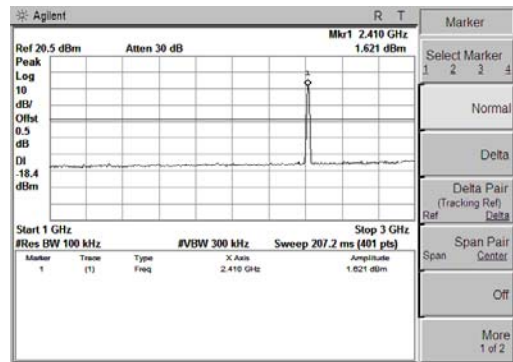
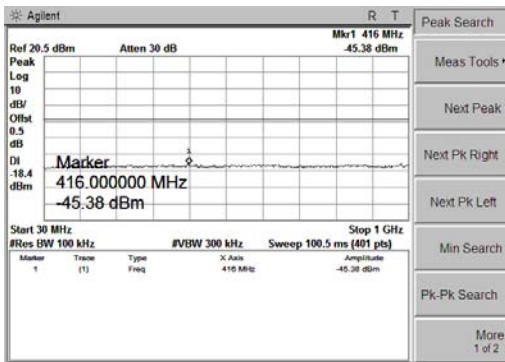

802.11b Mode, Ch1

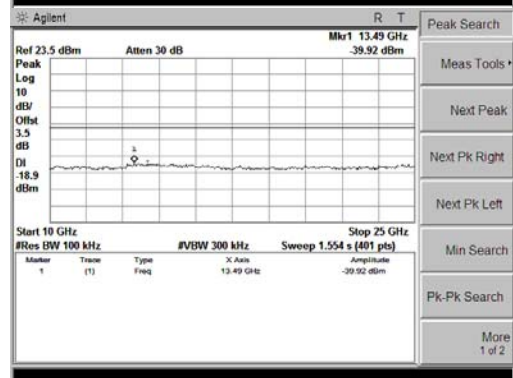
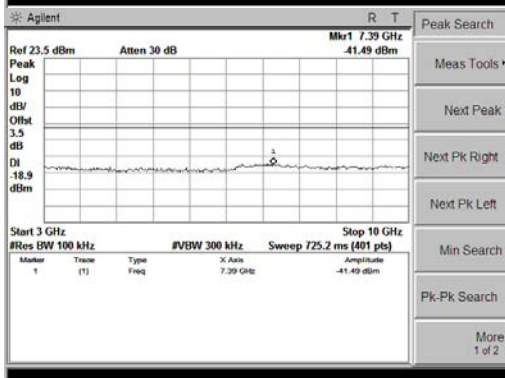
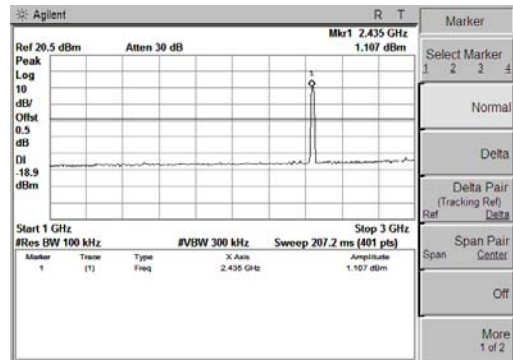
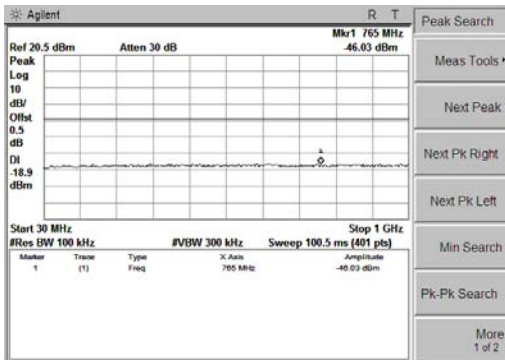

802.11b Mode, Ch6

Conducted Spurious Emissions

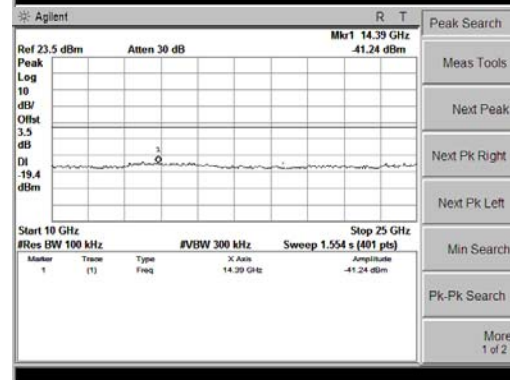
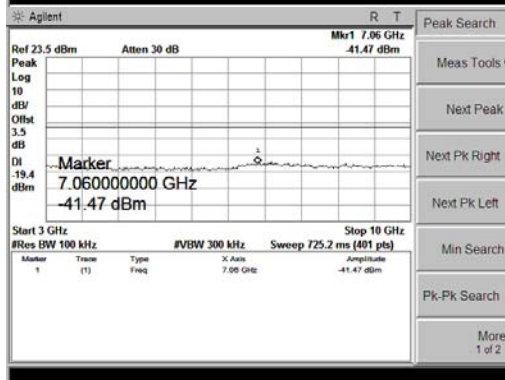
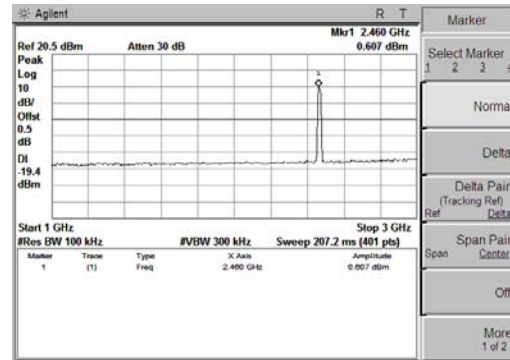
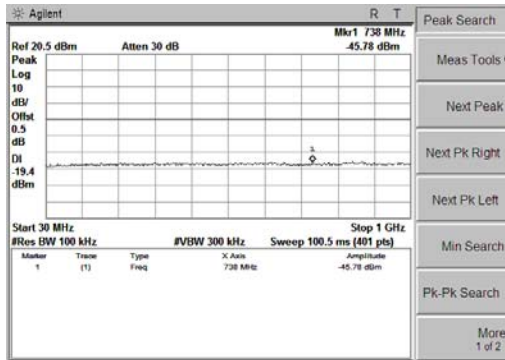

802.11b Mode, Ch11

5.9 Restricted Frequency Bands

5.9.1 Test Requirement

In any 100 kHz bandwidth outside the frequency band in which the spread spectrum or digitally modulated intentional radiator is operating, the radio frequency power that is produced by the intentional radiator shall be at least 20 dB below that in the 100 kHz bandwidth within the band that contains the highest level of the desired power. In addition, radiated emissions which fall in the restricted bands, as defined in §15.205(a), must also comply with the radiated emission limits specified in §15.209(a) (see §15.205(c)).

5.9.2 Test Configuration

Test Setup:

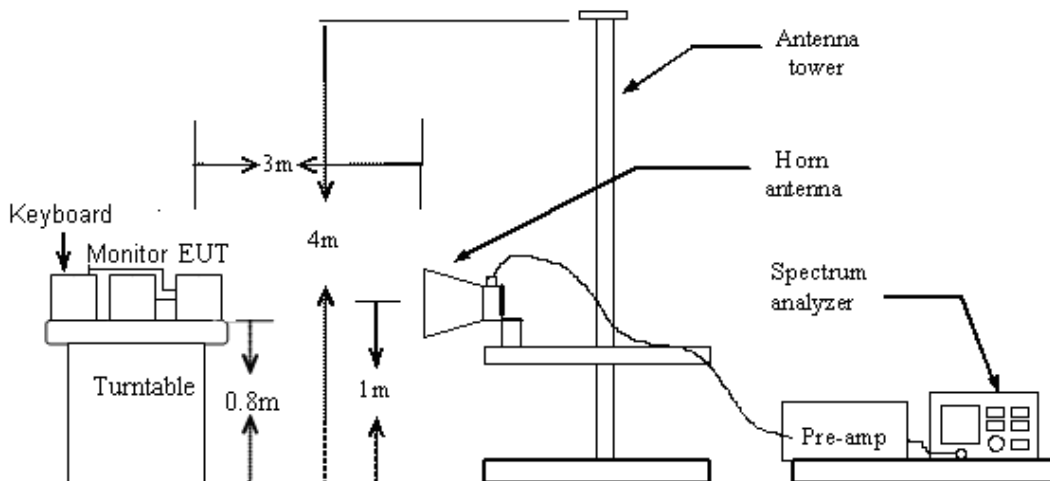

5.9.3 Test Procedure:

1. The EUT was placed on the top of a rotating table 0.8 meters above the ground at a 3 meter chamber. The table was rotated 360 degrees to determine the position of the highest radiation.
2. The EUT was set 3 meters away from the interference-receiving antenna, which was mounted on the top of a variable-height antenna tower.
3. The antenna height is varied from one meter to four meters above the ground to determine the maximum value of the field strength. Both horizontal and vertical polarizations of the antenna are set to make the measurement.
4. For each suspected emission, the EUT was arranged to its worst case and then the antenna was tuned to heights from 1 meter to 4 meters and the table was turned from 0 degrees to 360 degrees to find the maximum reading.

5.9.4 Test Result

Pass

Note: All test modes are performed, only the worst case is recorded in this report.

Please refer the following plots.

EUT:	The Edge Mini	M/N:	The Edge Mini Alkaline Tablet
Mode:	802.11b-CH1	Polarization:	Horizontal
Test by:	John	Power:	DC 6V by Battery
Temperature: / Humidity	22.7°C / 53.1%	Test date:	2016-04-08

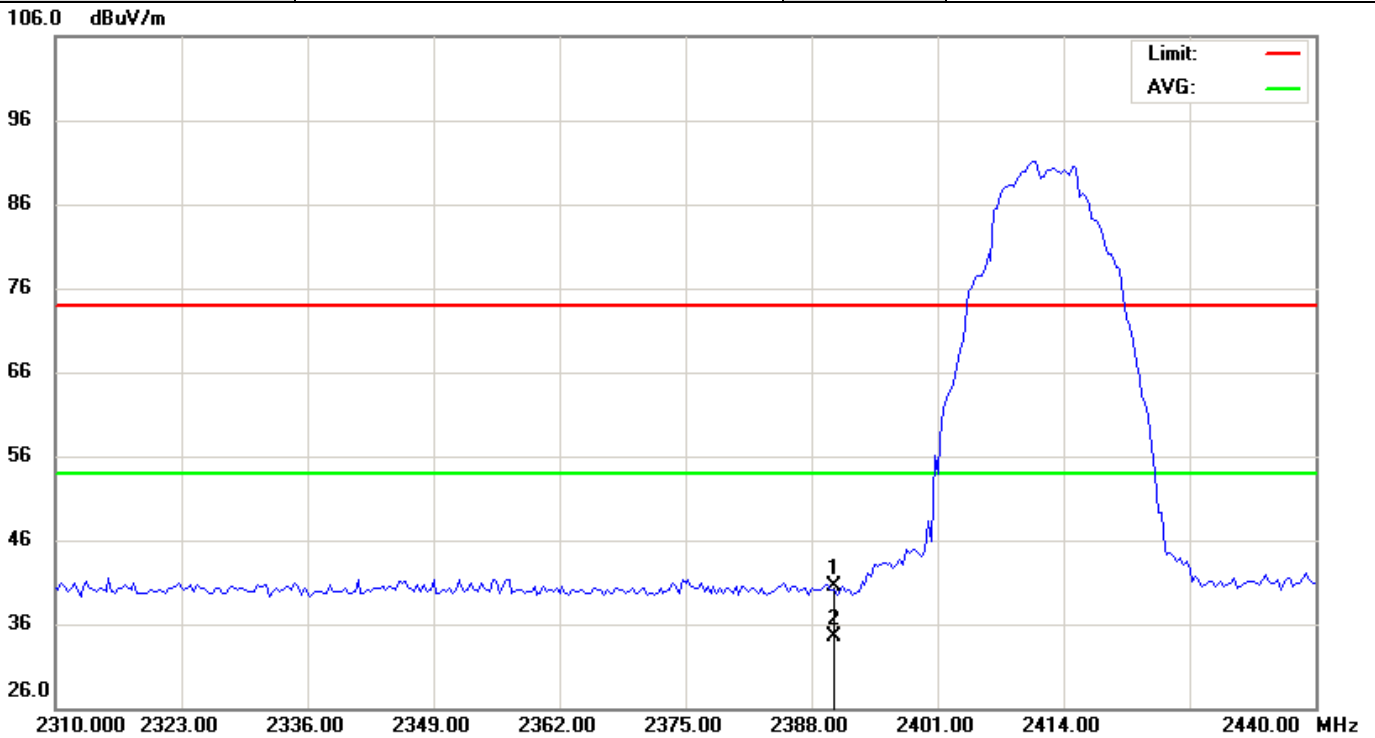

No.	Mk.	Freq. MHz	Reading Level dBuV	Correct Factor dB	Measure- ment dBuV/m	Limit dBuV/m	Over dB	Detector	Antenna Height cm	Table Degree degree	Comment
1		2390.000	49.03	-8.43	40.60	74.00	-33.40	peak			
2	*	2390.000	42.96	-8.43	34.53	54.00	-19.47	AVG			

*:Maximum data x:Over limit l:over margin

EUT:	The Edge Mini	M/N:	The Edge Mini Alkaline Tablet
Mode:	802.11b-CH1	Polarization:	Vertical
Test by:	John	Power:	DC 6V by Battery
Temperature: / Humidity	22.7°C / 53.1%	Test date:	2016-04-08

106.0 dBuV/m

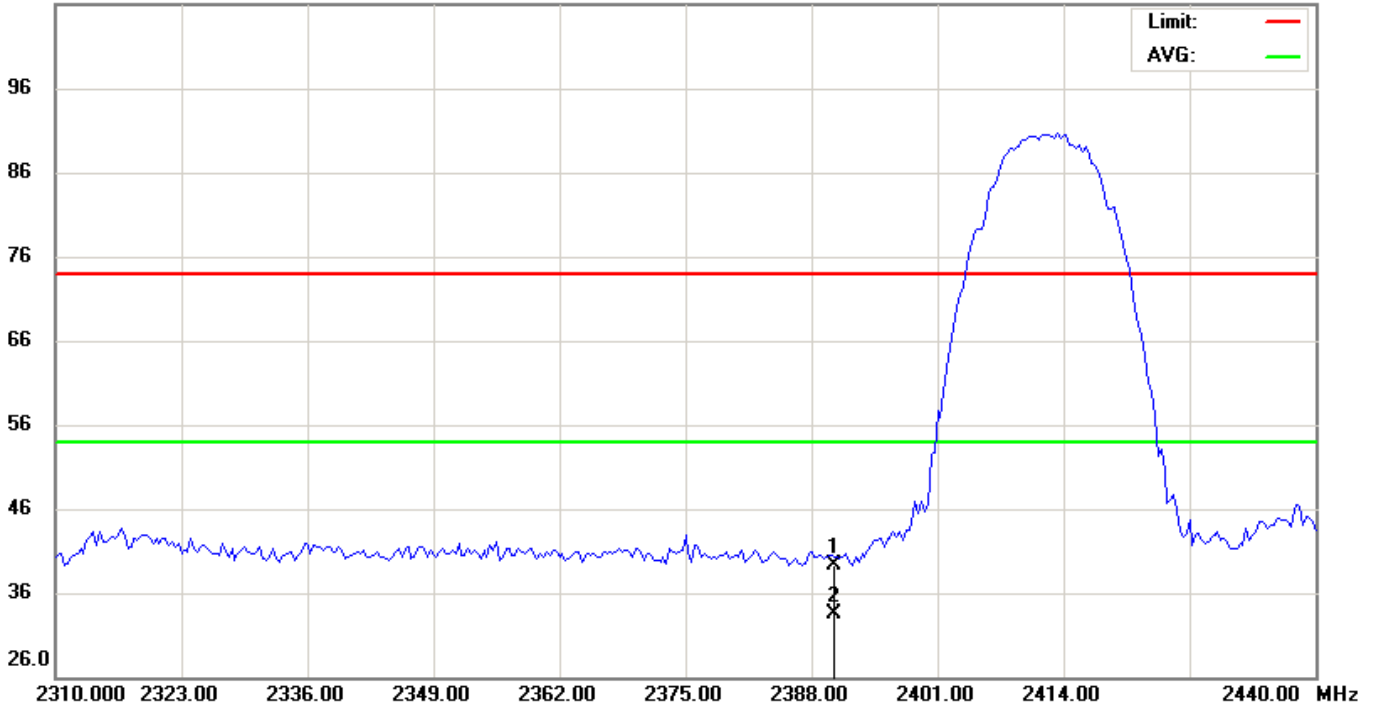

No.	Mk.	Freq. MHz	Reading Level dBuV	Correct Factor dB	Measure- ment dBuV/m	Limit dBuV/m	Over dB	Antenna Height cm	Table Degree degree	Comment
1		2390.000	47.68	-8.43	39.25	74.00	-34.75			peak
2	*	2390.000	41.94	-8.43	33.51	54.00	-20.49			AVG

*:Maximum data x:Over limit l:over margin

EUT:	The Edge Mini	M/N:	The Edge Mini Alkaline Tablet
Mode:	802.11b-CH11	Polarization:	Horizontal
Test by:	John	Power:	DC 6V by Battery
Temperature: / Humidity	22.7°C / 53.1%	Test date:	2016-04-08

111.0 dBuV/m

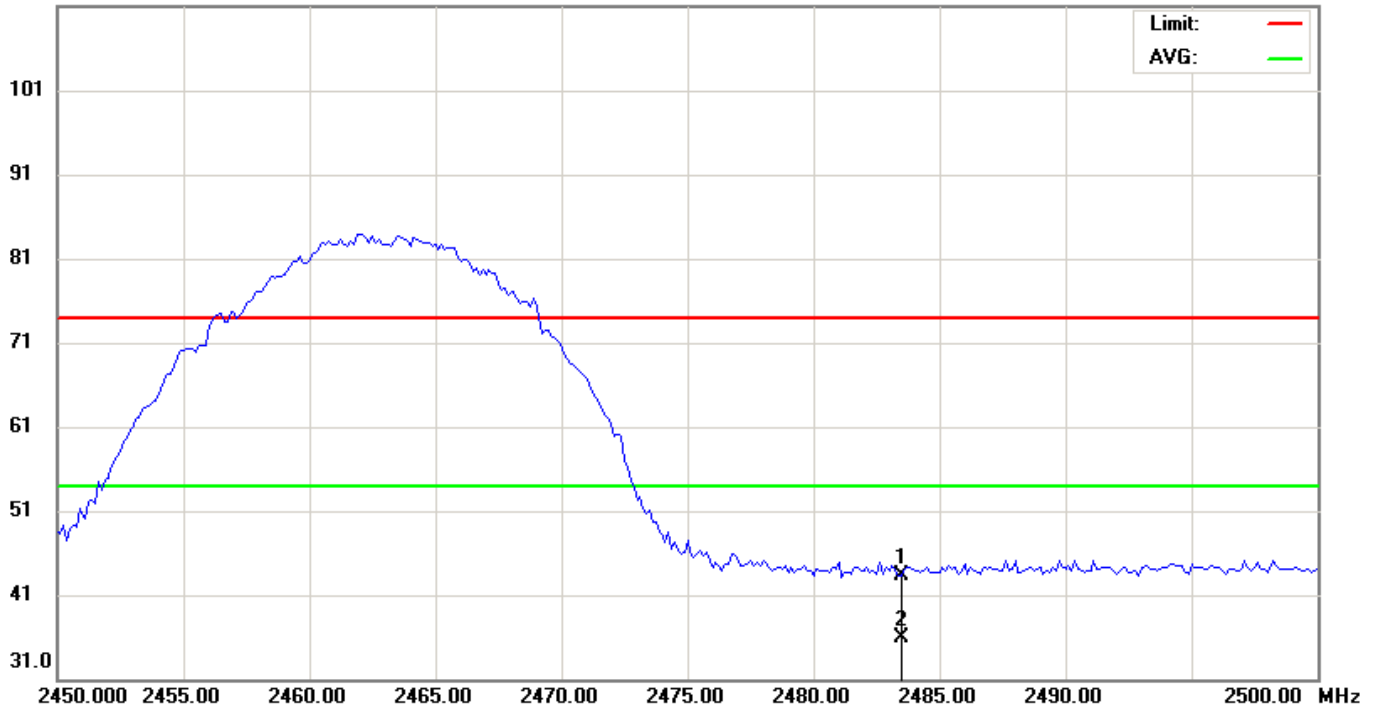

No.	Mk.	Freq.	Reading Level	Correct Factor	Measurement	Limit	Over	Antenna Height	Table Degree	
		MHz	dBuV	dB	dBuV/m	dBuV/m	dB	cm	degree	Comment
1		2483.500	51.68	-8.29	43.39	74.00	-30.61			peak
2	*	2483.500	44.10	-8.29	35.81	54.00	-18.19			AVG

*:Maximum data x:Over limit !:over margin

EUT:	The Edge Mini	M/N:	The Edge Mini Alkaline Tablet
Mode:	802.11b-CH11	Polarization:	Vertical
Test by:	John	Power:	DC 6V by Battery
Temperature: / Humidity	22.7°C / 53.1%	Test date:	2016-04-08

111.0 dBuV/m

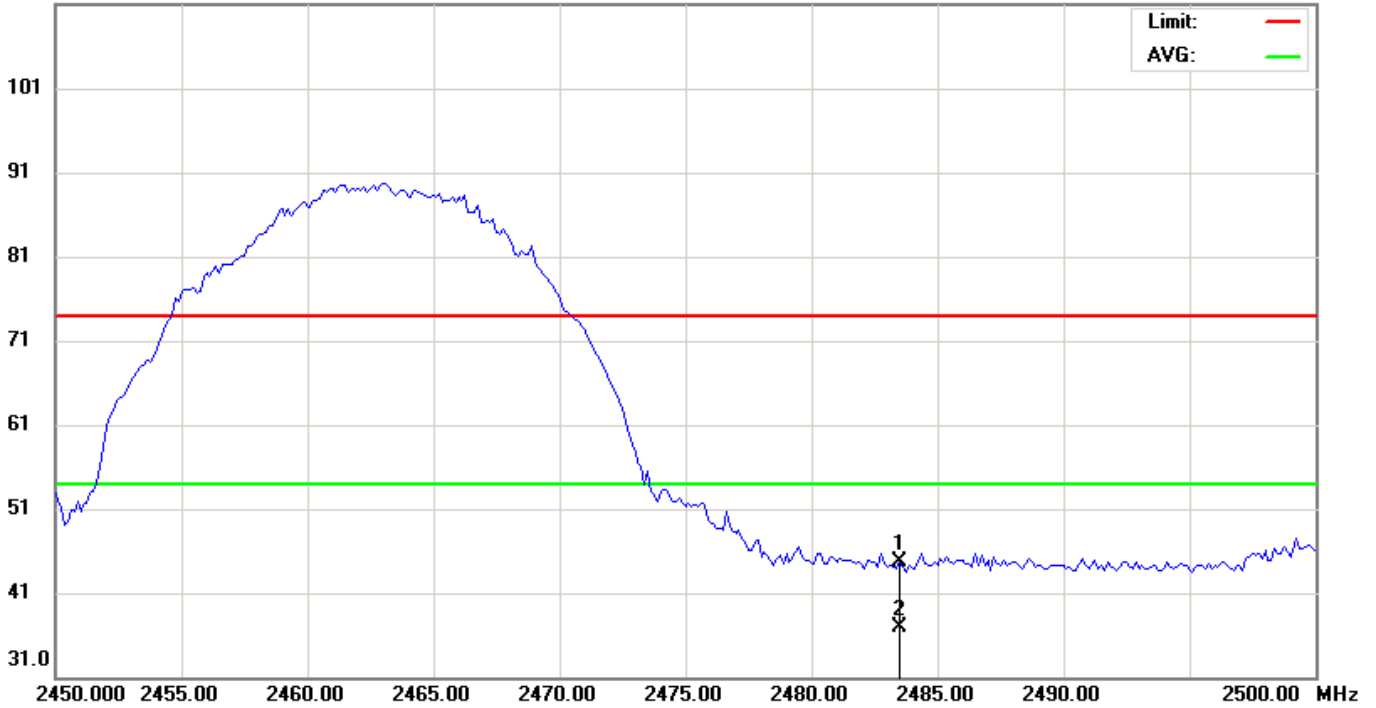

No.	Mk.	Freq. MHz	Reading Level dBuV	Correct Factor dB	Measure- ment dBuV/m	Limit dBuV/m	Over dB	Detector	Antenna Height cm	Table Degree	Comment
1		2483.500	52.96	-8.29	44.67	74.00	-29.33	peak			
2	*	2483.500	45.23	-8.29	36.94	54.00	-17.06	AVG			

*:Maximum data x:Over limit !:over margin

EUT:	The Edge Mini	M/N:	The Edge Mini Alkaline Tablet
Mode:	802.11g-CH1	Polarization:	Horizontal
Test by:	John	Power:	DC 6V by Battery
Temperature: / Humidity	22.7°C / 53.1%	Test date:	2016-04-08

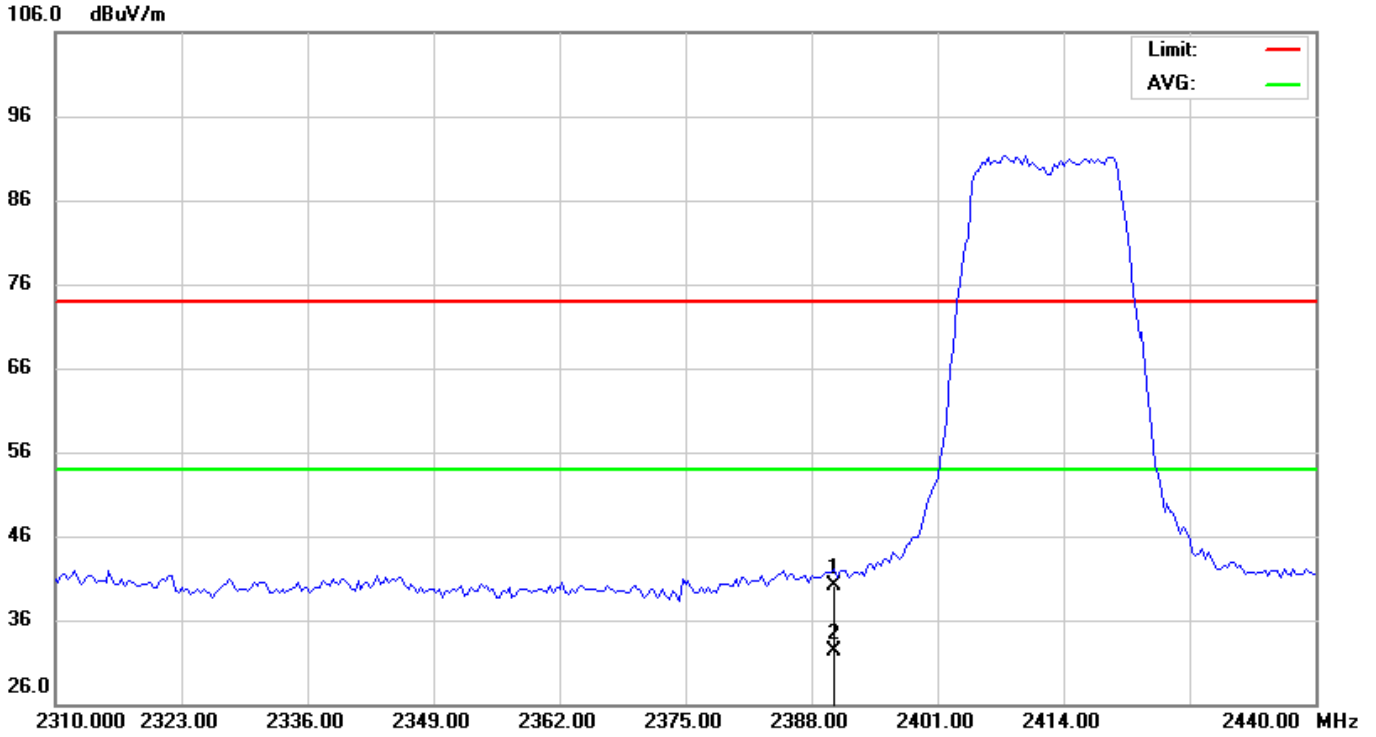

No.	Mk.	Freq.	Reading Level	Correct Factor	Measurement	Limit	Over	Antenna Height	Table Degree	
		MHz	dBuV	dB	dBuV/m	dBuV/m	dB	cm	degree	Comment
1		2390.000	48.54	-8.43	40.11	74.00	-33.89			peak
2	*	2390.000	40.66	-8.43	32.23	54.00	-21.77			AVG

*:Maximum data x:Over limit !:over margin

EUT:	The Edge Mini	M/N:	The Edge Mini Alkaline Tablet
Mode:	802.11g-CH1	Polarization:	Vertical
Test by:	John	Power:	DC 6V by Battery
Temperature: / Humidity	22.7°C / 53.1%	Test date:	2016-04-08

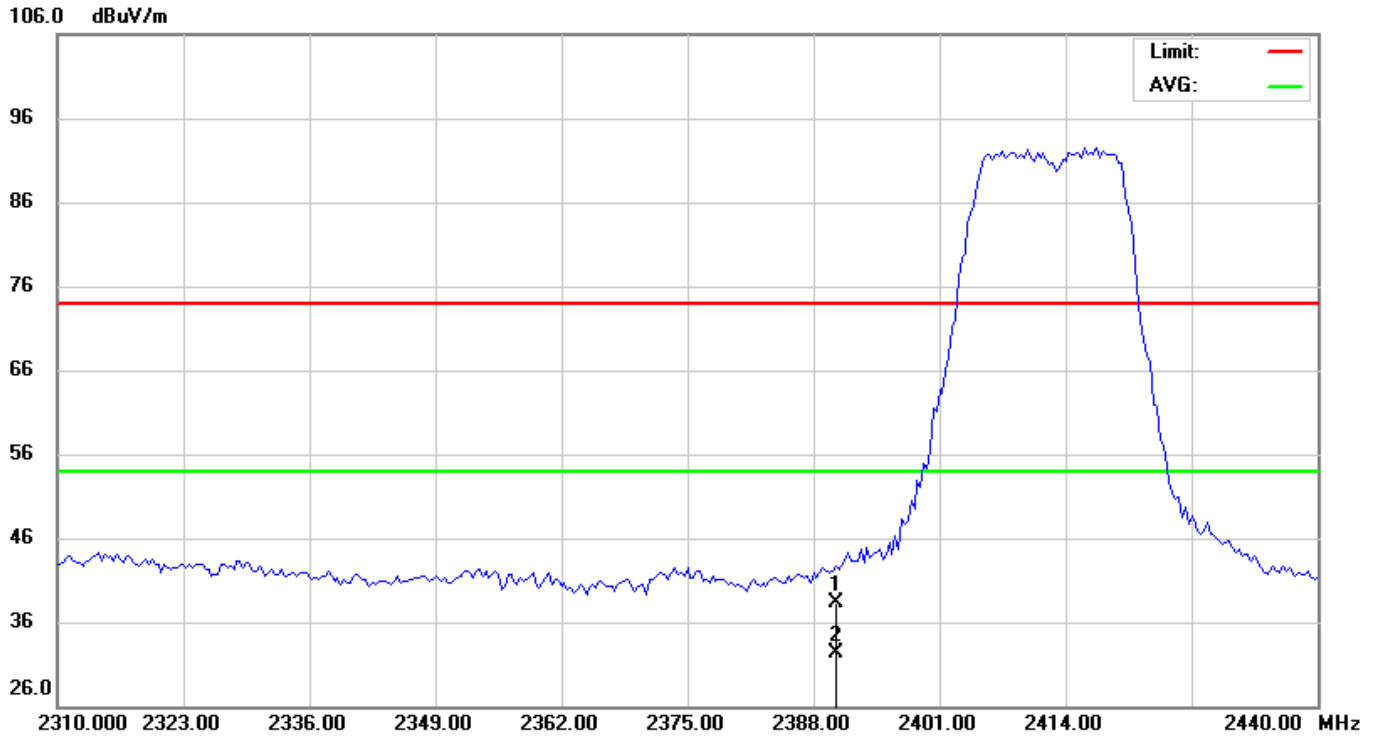

No.	Mk.	Freq.	Reading Level	Correct Factor	Measurement	Limit	Over	Antenna Height	Table Degree	
		MHz	dBuV	dB	dBuV/m	dBuV/m	dB	cm	degree	Comment
1		2390.000	46.74	-8.43	38.31	74.00	-35.69			peak
2	*	2390.000	40.67	-8.43	32.24	54.00	-21.76			AVG

*:Maximum data x:Over limit !:over margin

EUT:	The Edge Mini	M/N:	The Edge Mini Alkaline Tablet
Mode:	802.11g-CH11	Polarization:	Horizontal
Test by:	John	Power:	DC 6V by Battery
Temperature: / Humidity	22.7°C / 53.1%	Test date:	2016-04-08

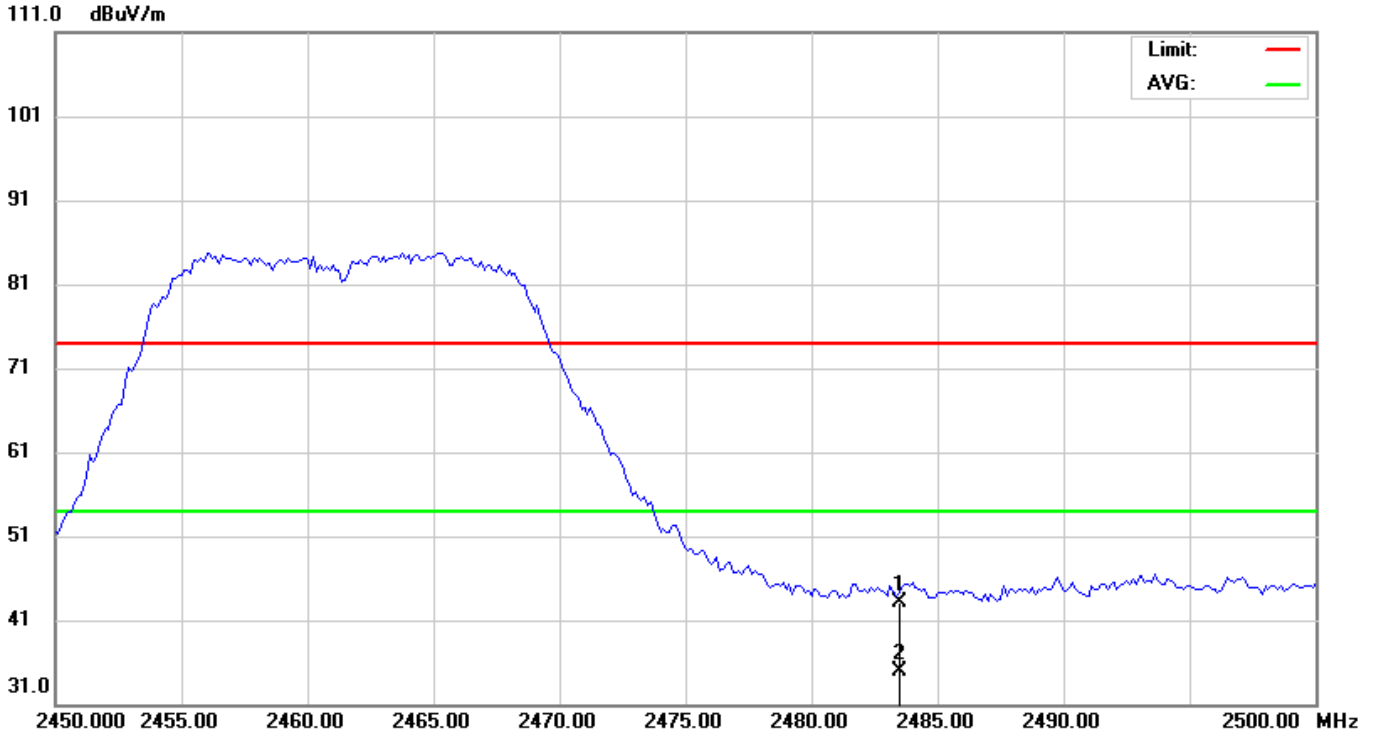

No.	Mk.	Freq. MHz	Reading Level dBuV	Correct Factor dB	Measure- ment dBuV/m	Limit dBuV/m	Over dB	Detector	Antenna Height cm	Table Degree	Comment
1		2483.500	51.34	-8.29	43.05	74.00	-30.95	peak			
2	*	2483.500	43.22	-8.29	34.93	54.00	-19.07	AVG			

*:Maximum data x:Over limit !:over margin

EUT:	The Edge Mini	M/N:	The Edge Mini Alkaline Tablet
Mode:	802.11g-CH11	Polarization:	Vertical
Test by:	John	Power:	DC 6V by Battery
Temperature: / Humidity	22.7°C / 53.1%	Test date:	2016-04-08

111.0 dBuV/m

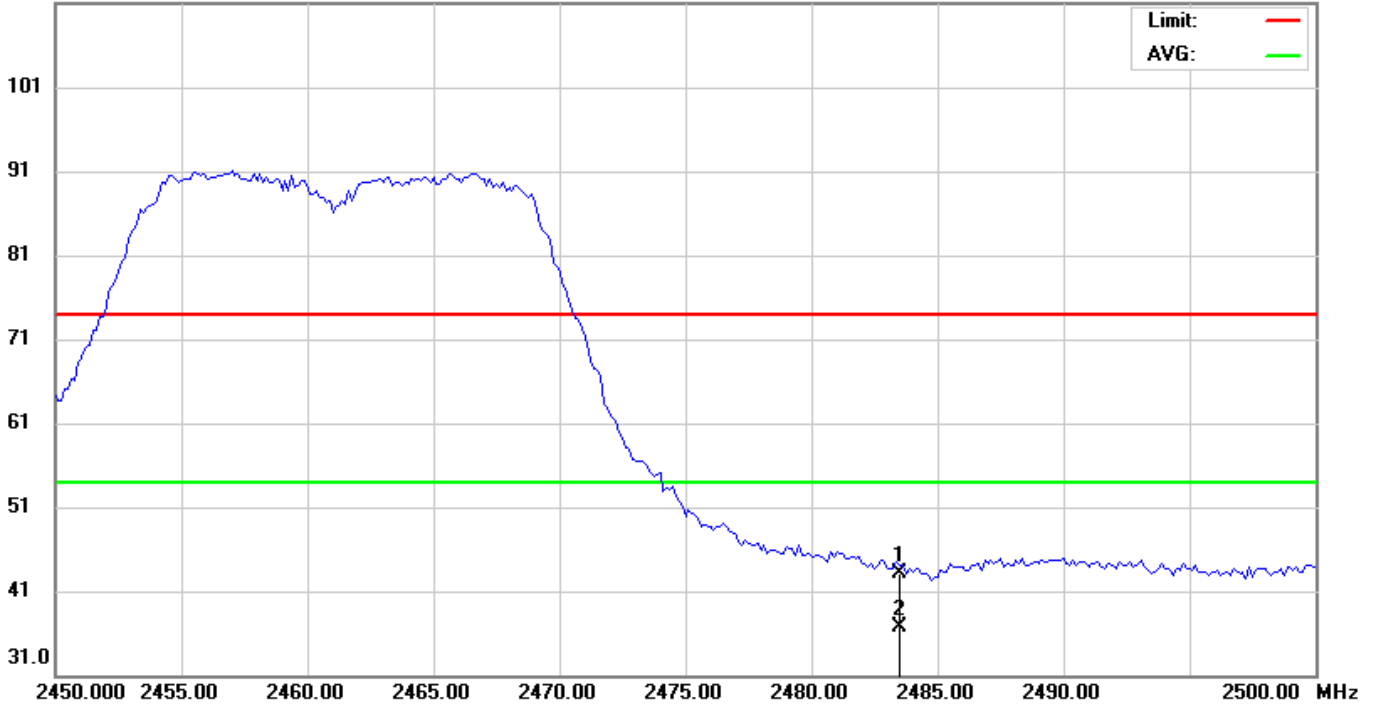

No.	Mk.	Freq. MHz	Reading Level dBuV	Correct Factor dB	Measure- ment dBuV/m	Limit dBuV/m	Over dB	Detector	Antenna Height cm	Table Degree	Comment
1		2483.500	51.42	-8.29	43.13	74.00	-30.87	peak			
2	*	2483.500	45.01	-8.29	36.72	54.00	-17.28	AVG			

*:Maximum data x:Over limit !:over margin

EUT:	The Edge Mini	M/N:	The Edge Mini Alkaline Tablet
Mode:	802.11n(20MHz)-CH1	Polarization:	Horizontal
Test by:	John	Power:	DC 6V by Battery
Temperature: / Humidity	22.7°C / 53.1%	Test date:	2016-04-08

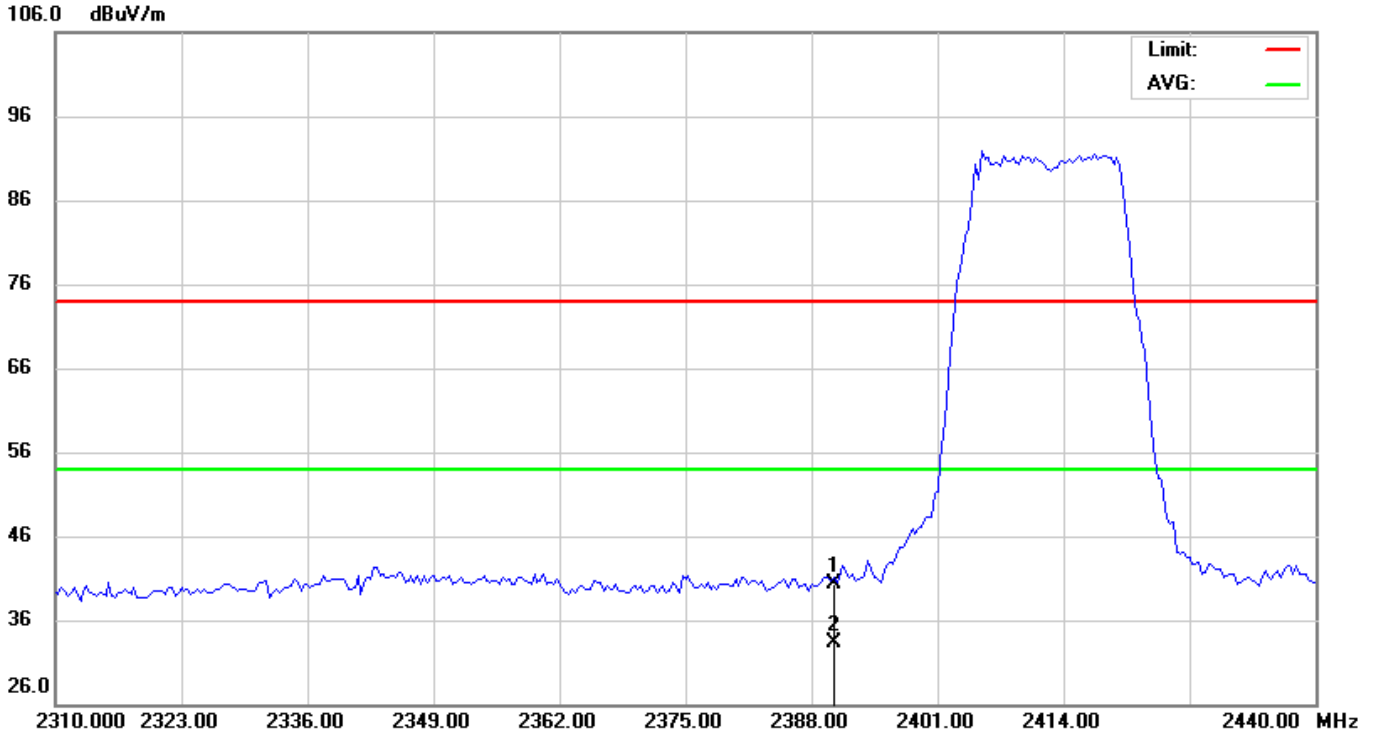

No.	Mk.	Freq.	Reading Level	Correct Factor	Measurement	Limit	Over	Antenna Height	Table Degree	Comment
		MHz	dBuV	dB	dBuV/m	dBuV/m	dB	cm	degree	
1		2390.000	48.67	-8.43	40.24	74.00	-33.76			peak
2	*	2390.000	41.65	-8.43	33.22	54.00	-20.78			AVG

*:Maximum data x:Over limit !:over margin

EUT:	The Edge Mini	M/N:	The Edge Mini Alkaline Tablet
Mode:	802.11n(20MHz)-CH1	Polarization:	Vertical
Test by:	John	Power:	DC 6V by Battery
Temperature: / Humidity	22.7°C / 53.1%	Test date:	2016-04-08

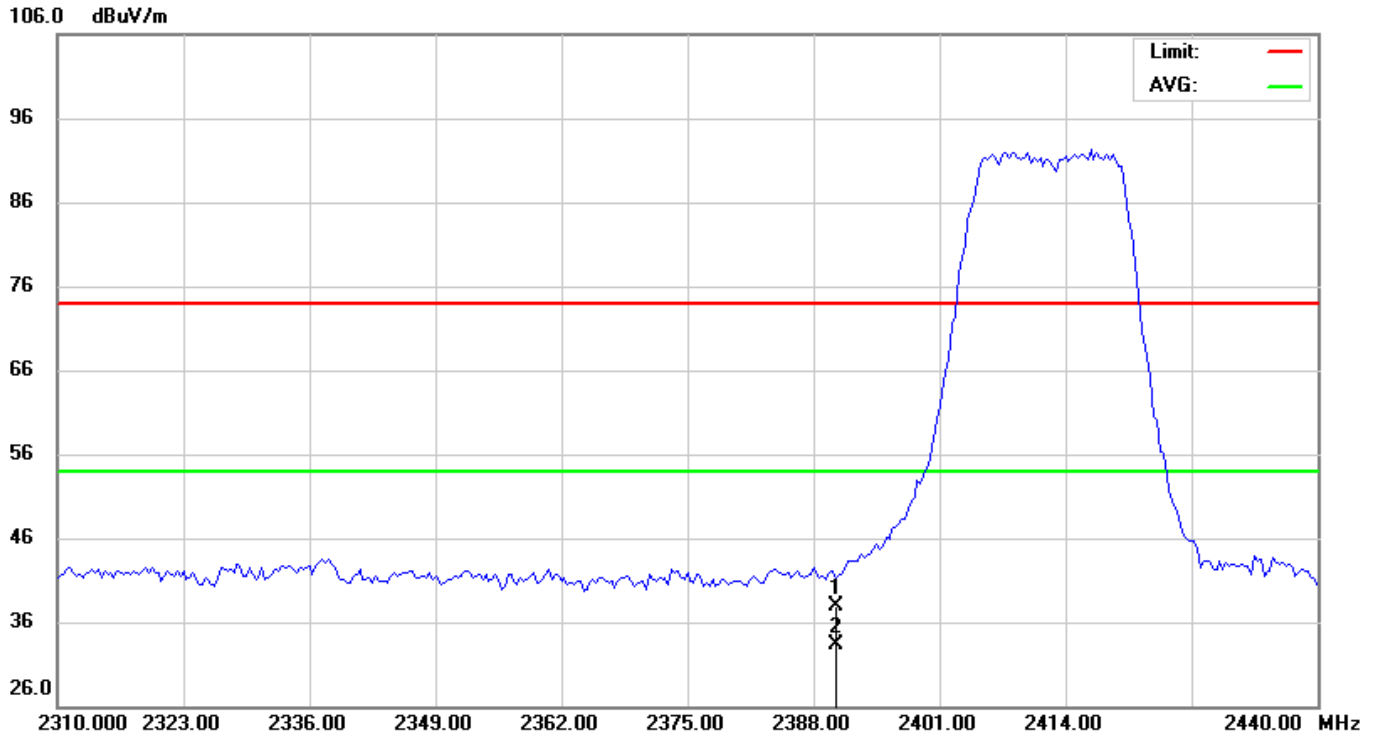

No.	Mk.	Freq.	Reading Level	Correct Factor	Measurement	Limit	Over	Antenna Height	Table Degree	
		MHz	dBuV	dB	dBuV/m	dBuV/m	dB	cm	degree	Comment
1		2390.000	46.34	-8.43	37.91	74.00	-36.09			peak
2	*	2390.000	41.75	-8.43	33.32	54.00	-20.68			AVG

*:Maximum data x:Over limit !:over margin

EUT:	The Edge Mini	M/N:	The Edge Mini Alkaline Tablet
Mode:	802.11n(20MHz)-CH11	Polarization:	Horizontal
Test by:	John	Power:	DC 6V by Battery
Temperature: / Humidity	22.7°C / 53.1%	Test date:	2016-04-08

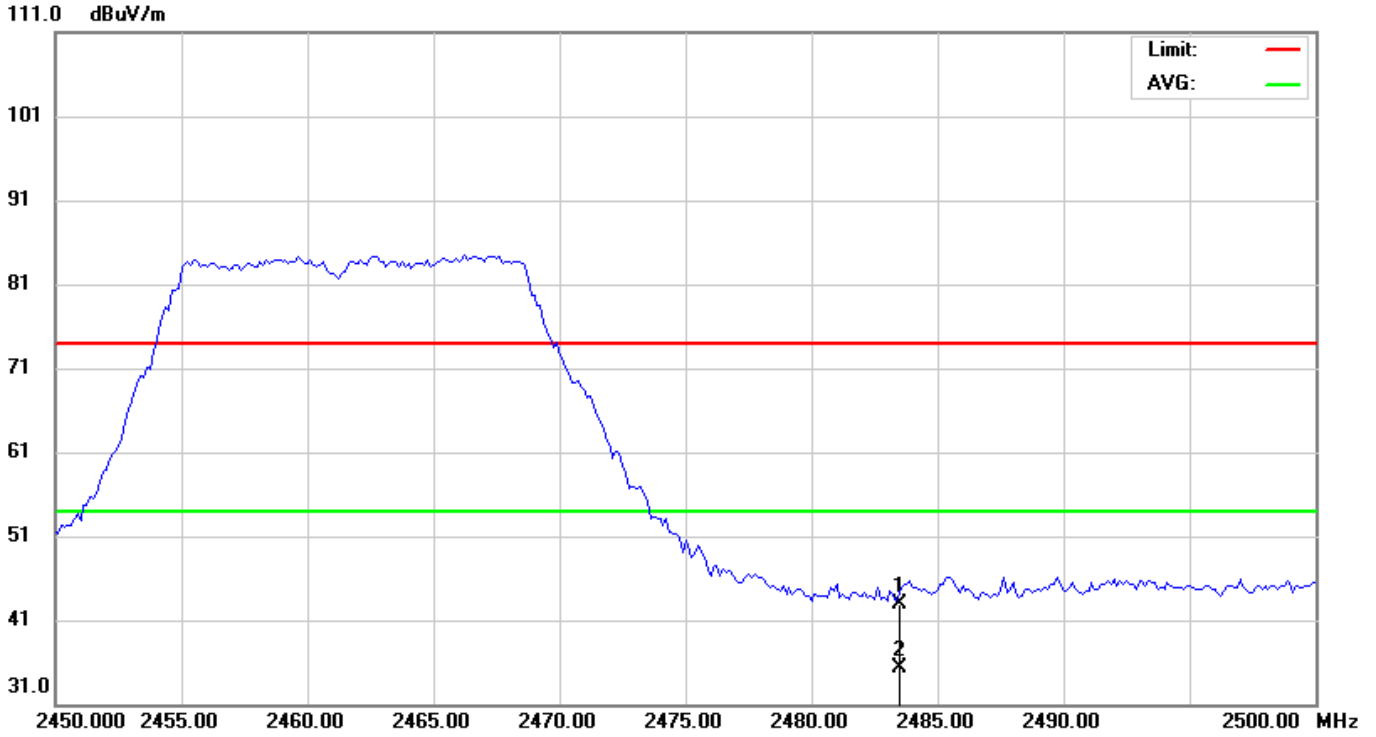

No.	Mk.	Freq.	Reading Level	Correct Factor	Measurement	Limit	Over	Antenna Height	Table Degree	
		MHz	dBuV	dB	dBuV/m	dBuV/m	dB	cm	degree	Comment
1		2483.500	51.21	-8.29	42.92	74.00	-31.08			peak
2	*	2483.500	43.69	-8.29	35.40	54.00	-18.60			AVG

*:Maximum data x:Over limit !:over margin

EUT:	The Edge Mini	M/N:	The Edge Mini Alkaline Tablet
Mode:	802.11n(20MHz)-CH11	Polarization:	Vertical
Test by:	John	Power:	DC 6V by Battery
Temperature: / Humidity	22.7°C / 53.1%	Test date:	2016-04-08

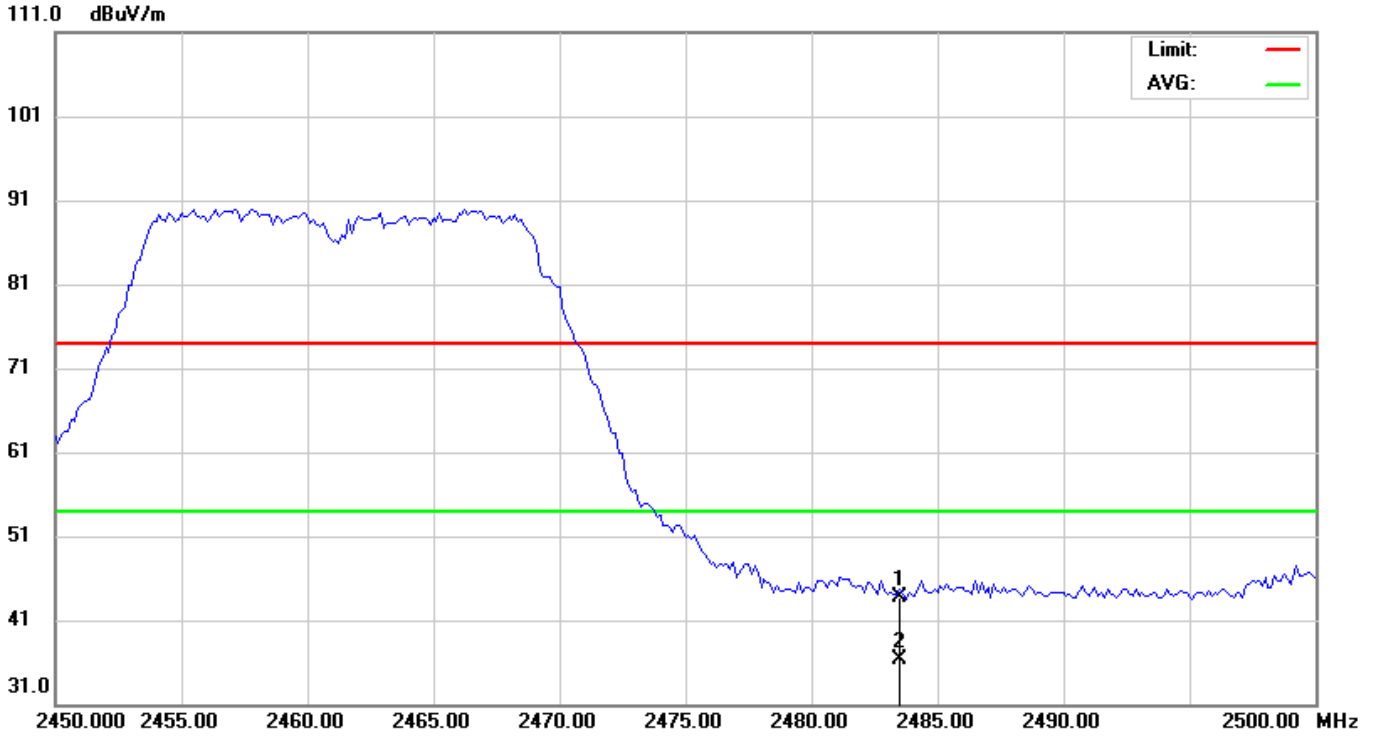

No.	Mk.	Freq. MHz	Reading Level dBuV	Correct Factor dB	Measure- ment dBuV/m	Limit dBuV/m	Over dB	Detector	Antenna Height cm	Table Degree degree	Comment
1		2483.500	51.95	-8.29	43.66	74.00	-30.34	peak			
2	*	2483.500	44.61	-8.29	36.32	54.00	-17.68	AVG			

*:Maximum data x:Over limit !:over margin

End of Report