



## MEASUREMENT REPORT

### FCC PART 15.247 FHSS 2.4GHz

---

**FCC ID:** 2AHU2WVSXM70  
**APPLICANT:** ASA Electronics Shenzhen Limited  
**Application Type:** Certification  
**Product:** Digital Wireless Observation Monitor  
**Model No.:** WVSXM70CV, WVSXM70  
**FCC Classification:** (DSS) FCC Part 15 Spread Spectrum Transmitter  
**FCC Rule Part(s):** Part 15.247  
**Test Procedure(s):** ANSI C63.10-2013  
**Received Date:** August 10, 2021  
**Test Date:** August 25, 2021 ~ September 6, 2021

**Tested By** : *Peter Syu*

( Peter Syu )

**Reviewed By** : *Paddy Chen*

( Paddy Chen )

**Approved By** : *Chenz Ker*

( Chenz Ker )



The test results only relate to the tested sample.

This equipment has been shown to be capable of compliance with the applicable technical standards as indicated in the measurement report and was tested in accordance with the measurement procedures specified in ANSI C63.10. Test results reported herein relate only to the item(s) tested.

The test report shall not be reproduced except in full without the written approval of MRT Technology (Taiwan) Co., Ltd.

### Revision History

Report No.	Version	Description	Issue Date	Note
2108TW5502-U2	1.0	Original Report	2021-09-07	

## CONTENTS

Description	Page
<b>1. INTRODUCTION .....</b>	<b>7</b>
1.1. Scope .....	7
1.2. MRT Test Location .....	7
<b>2. PRODUCT INFORMATION .....</b>	<b>8</b>
2.1. Equipment Description .....	8
2.2. Product Specification Subjective to this Standard .....	8
2.3. Test Mode .....	8
2.4. Operation Frequency / Channel List .....	9
2.5. Test Configuration .....	10
2.6. Test Software .....	10
2.7. EMI Suppression Device(s)/Modifications .....	10
2.8. Labeling Requirements .....	10
<b>3. DESCRIPTION of TEST .....</b>	<b>11</b>
3.1. Evaluation Procedure .....	11
3.2. AC Line Conducted Emissions .....	11
3.3. Radiated Emissions .....	12
<b>4. ANTENNA REQUIREMENTS .....</b>	<b>13</b>
<b>5. TEST EQUIPMENT CALIBRATION DATE .....</b>	<b>14</b>
<b>6. MEASUREMENT UNCERTAINTY .....</b>	<b>15</b>
<b>7. TEST RESULT .....</b>	<b>16</b>
7.1. Summary .....	16
7.2. 20dB Bandwidth Measurement .....	17
7.2.1. Test Limit .....	17
7.2.2. Test Procedure used .....	17
7.2.3. Test Setting .....	17
7.2.4. Test Setup .....	17
7.2.5. Test Result .....	18
7.3. Output Power Measurement .....	20
7.3.1. Test Limit .....	20
7.3.2. Test Procedure Used .....	20
7.3.3. Test Setting .....	21
7.3.4. Test Setup .....	21

7.3.5.	Test Result.....	22
7.4.	Carrier Frequency Separation Measurement.....	23
7.4.1.	Test Limit.....	23
7.4.2.	Test Procedure Used.....	23
7.4.3.	Test Setting.....	23
7.4.4.	Test Setup.....	23
7.4.5.	Test Result.....	24
7.5.	Number of Hopping Channels Measurement.....	26
7.5.1.	Test Limit.....	26
7.5.2.	Test Procedure Used.....	26
7.5.3.	Test Settintg.....	26
7.5.4.	Test Setup.....	26
7.5.5.	Test Result.....	27
7.6.	Time of Occupancy Measurement.....	28
7.6.1.	Test Limit.....	28
7.6.2.	Test Procedure Used.....	28
7.6.3.	Test Settintg.....	28
7.6.4.	Test Setup.....	28
7.6.5.	Test Result.....	29
7.7.	Out-of-Band Spurious Emissions Emissions Measurement.....	31
7.7.1.	Test Limit.....	31
7.7.2.	Test Procedure Used.....	31
7.7.3.	Test Setting.....	32
7.7.4.	Test Setup.....	32
7.7.5.	Test Result.....	33
7.8.	Radiated Spurious Emission Measurement.....	36
7.8.1.	Test Limit.....	36
7.8.2.	Test Procedure Used.....	36
7.8.3.	Test Setting.....	36
7.8.4.	Test Setup.....	38
7.8.5.	Test Result.....	40
7.9.	Radiated Restricted Band Edge Measurement.....	48
7.9.1.	Test Limit.....	48
7.9.2.	Test Procedure Used.....	48
7.9.3.	Test Setting.....	48
7.9.4.	Test Setup.....	50
7.9.5.	Test Result.....	51
7.10.	AC Conducted Emissions Measurement.....	59



7.10.1. Test Limit .....	59
7.10.2. Test Setup .....	59
7.10.3. Test Result.....	60
<b>8. CONCLUSION .....</b>	<b>61</b>

## §2.1033 General Information

<b>Applicant</b>	ASA Electronics Shenzhen Limited
<b>Applicant Address</b>	Room 503, 5/F., Unit A, Skyworth Building, Gaoxin Avenue.1.S.,Nanshan District, Shen Zhen 518057, China
<b>Manufacturer</b>	SYSGRATION LTD.
<b>Manufacturer Address</b>	6F, No.1 , Sec. 1 , Tiding Blvd. , Neihu Dist. , Taipei City 11494, Taiwan
<b>Test Site</b>	MRT Technology (Taiwan) Co., Ltd
<b>Test Site Address</b>	No. 38, Fuxing Second Rd., Guishan Dist., Taoyuan City 333, Taiwan (R.O.C)
<b>MRT FCC Registration No.</b>	291082
<b>FCC Rule Part(s)</b>	Part 15.247
<b>Test Device Serial No.</b>	#1 <input type="checkbox"/> Production <input checked="" type="checkbox"/> Pre-Production <input type="checkbox"/> Engineering

### Test Facility / Accreditations

1. MRT facility is a FCC registered (Reg. No. 291082) test facility with the site description report on file and is designated by the FCC as an Accredited Test Firm.
2. MRT facility is an IC registered (MRT Reg. No. 21723) test laboratory with the site description on file at Industry Canada.
3. MRT Lab is accredited to ISO 17025 by the Taiwan Accreditation Foundation (TAF Cert. No. 3261) in EMC, Telecommunications and Radio testing for FCC (Designation Number: TW3261), Industry Taiwan, EU and TELEC Rules.

## 1. INTRODUCTION

### 1.1. Scope

Measurement and determination of electromagnetic emissions (EMC) of radio frequency devices including intentional and/or unintentional radiators for compliance with the technical rules and regulations of the Federal Communications Commission and the Industry Canada Certification and Engineering Bureau.

### 1.2. MRT Test Location

The map below shows the location of the MRT LABORATORY, its proximity to the Taoyuan City. These measurement tests were conducted at the MRT Technology (Taiwan) Co., Ltd. Facility located at No.38, Fuxing 2nd Rd., Guishan Dist., Taoyuan City 33377, Taiwan (R.O.C).

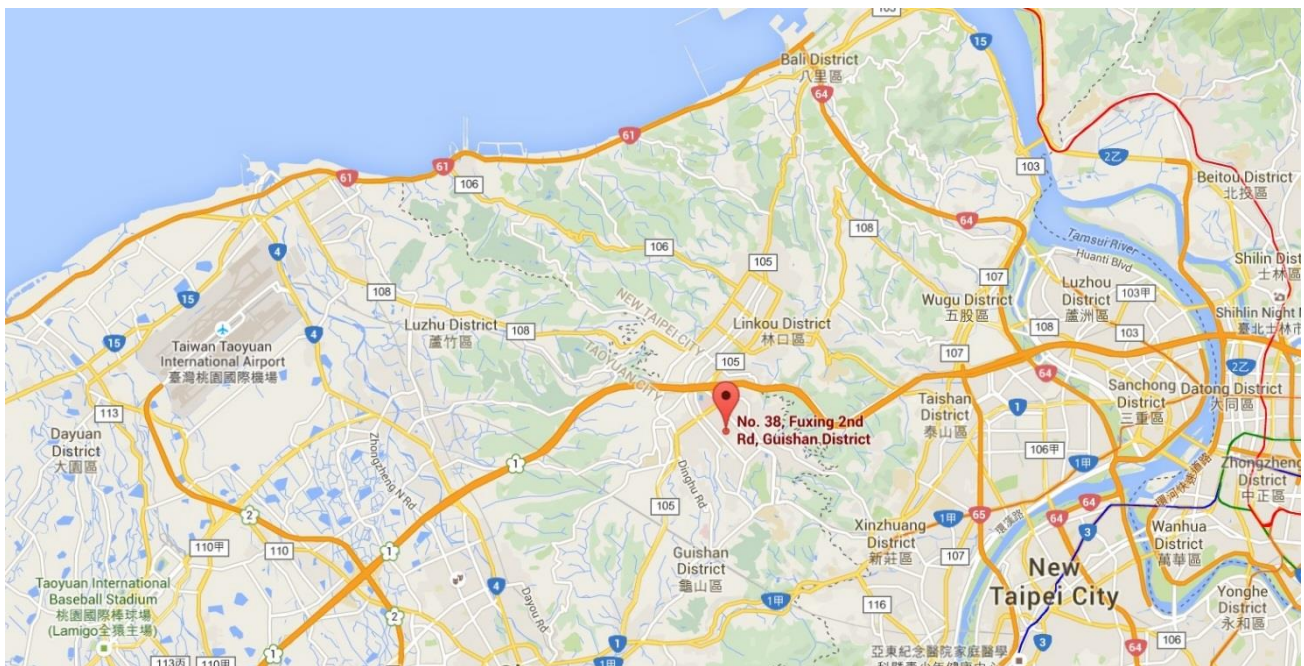

## 2. PRODUCT INFORMATION

### 2.1. Equipment Description

Product Name	Digital Wireless Observation Monitor
FCC ID	2AHU2WVSXM70
Model No.	WVSXM70CV, WVSXM70
Supports Radios Spec.	FHSS 2.4GHz
Maximum Output Power	19.45dBm

Note: 1) The model difference is as below:

Model	Accessory Cable
WVSXM70	GPIO cable
WVSXM70CV	Without GPIO cable

2) The test sample model is WVSXM70CV.

### 2.2. Product Specification Subjective to this Standard

Operating Frequency	2403~2472MHz
Type of modulation	FHSS (QPSK)

### 2.3. Test Mode

Test Mode	Mode 1: Transmit - QPSK
-----------	-------------------------

Note:

- Regarding to the operation frequency, the lowest, middle and highest frequency are selected to perform the test.



## 2.4. Operation Frequency / Channel List

Channel	Frequency	Channel	Frequency
33	2403 MHz	72	2442 MHz
36	2406 MHz	75	2445 MHz
39	2409 MHz	78	2448 MHz
45	2415 MHz	82	2452 MHz
48	2418 MHz	85	2455 MHz
52	2422 MHz	88	2458 MHz
55	2425 MHz	95	2465 MHz
58	2428 MHz	98	2468 MHz
62	2432 MHz	102	2472 MHz

## **2.5. Test Configuration**

This device was tested per the guidance of ANSI C63.10-2013. ANSI C63.10-2013 was used to reference the appropriate EUT setup for radiated spurious emissions testing and AC line conducted testing.

## **2.6. Test Software**

The test utility software used during testing was “Tera Term”.

## **2.7. EMI Suppression Device(s)/Modifications**

No EMI suppression device(s) were added and/or no modifications were made during testing.

## **2.8. Labeling Requirements**

Per 2.1074 & 15.19; Docket 95-19

The label shall be permanently affixed at a conspicuous location on the device; instruction manual or pamphlet supplied to the user and be readily visible to the purchaser at the time of purchase. However, when the device is so small wherein placement of the label with specified statement is not practical, only the FCC ID must be displayed on the device per Section 15.19(a)(5). Please see attachment for FCC ID label and label location.

### 3. DESCRIPTION of TEST

#### 3.1. Evaluation Procedure

The measurement procedures described in the American National Standard for Testing Unlicensed Wireless Devices (ANSI C63.10-2013) were used in the measurement of the **Digital Wireless Observation Monitor**.

**Deviation from measurement procedure.....None**

#### 3.2. AC Line Conducted Emissions

The line-conducted facility is located inside an 9'x4'x3' shielded enclosure. A 1m x 2m wooden table 80cm high is placed 40cm away from the vertical wall and 80cm away from the sidewall of the shielded room. Two 10kHz-30MHz, 50Ω/50uH Line-Impedance Stabilization Networks (LISNs) are bonded to the shielded room floor. Power to the LISNs is filtered by external high-current high-insertion loss power line filters. These filters attenuate ambient signal noise from entering the measurement lines. These filters are also bonded to the shielded enclosure.

The EUT is powered from one LISN and the support equipment is powered from the second LISN. All interconnecting cables more than 1 meter were shortened to a 1 meter length by non-inductive bundling (serpentine fashion) and draped over the back edge of the test table. All cables were at least 40cm above the horizontal reference ground-plane. Power cables for support equipment were routed down to the second LISN while ensuring that that cables were not draped over the second LISN.

Sufficient time for the EUT, support equipment, and test equipment was allowed in order for them to warm up to their normal operating condition. The RF output of the LISN was connected to the receiver and exploratory measurements were made to determine the frequencies producing the maximum emission from the EUT. The receiver was scanned from 150kHz to 30MHz. The detector function was set to peak mode for exploratory measurements while the bandwidth of the analyzer was set to 9kHz. The EUT, support equipment, and interconnecting cables were arranged and manipulated to maximize each emission. Each emission was also maximized by varying: power lines, the mode of operation or data exchange speed, or support equipment whichever determined the worst-case emission. Once the worst case emissions have been identified, the one EUT cable configuration/arrangement and mode of operation that produced these emissions were used for final measurements on the same test site. The analyzer is set to CISPR quasi-peak and average detectors with a 9kHz resolution bandwidth for final measurements.

An extension cord was used to connect to a single LISN which powered by EUT. The extension cord was calibrated with LISN, the impedance and insertion loss are compliance with the requirements as stated in ANSI C63.10-2013.

Line conducted emissions test results are shown in Section 7.10.

### 3.3. Radiated Emissions

The radiated test facilities consisted of an indoor 3 meter semi-anechoic chamber used for final measurements and exploratory measurements, when necessary. The measurement area is contained within the semi-anechoic chamber which is shielded from any ambient interference. For measurements above 1GHz absorbers are arranged on the floor between the turn table and the antenna mast in such a way so as to maximize the reduction of reflections. For measurements below 1GHz, the absorbers are removed. An MF Model 210SS turntable is used for radiated measurement. It is a continuously rotatable, remote controlled, metallic turntable and 2 meters (6.56 ft.) in diameter. The turn table is flush with the raised floor of the chamber in order to maintain its function as a ground plane. An 80cm high PVC support structure is placed on top of the turntable. For all measurements, the spectrum was scanned through all EUT azimuths and from 1 to 4 meter receive antenna height using a broadband antenna from 30MHz up to the upper frequency shown in 15.33(b)(1) depending on the highest frequency generated or used in the device or on which the device operates or tunes. For frequencies above 1GHz, linearly polarized double ridge horn antennas were used. For frequencies below 30MHz, a calibrated loop antenna was used. When exploratory measurements were necessary, they were performed at 1 meter test distance inside the semi-anechoic chamber using broadband antennas, broadband amplifiers, and spectrum analyzers to determine the frequencies and modes producing the maximum emissions. Sufficient time for the EUT, support equipment, and test equipment was allowed in order for them to warm up to their normal operating condition. The test set-up for frequencies below 1GHz was placed on top of the 0.8 meter high, 1 x 1.5 meter table; and test set-up for frequencies 1-40GHz was placed on top of the 1.5 meter high, 1 x 1.5 meter table. The EUT, support equipment, and interconnecting cables were arranged and manipulated to maximize each emission. Appropriate precaution was taken to ensure that all emissions from the EUT were maximized and investigated. The system configuration, clock speed, mode of operation or video resolution, if applicable, turntable azimuth, and receive antenna height was noted for each frequency found.

Final measurements were made in the semi-anechoic chamber using calibrated, linearly polarized broadband and horn antennas. The test setup was configured to the setup that produced the worst case emissions. The spectrum analyzer was set to investigate all frequencies required for testing to compare the highest radiated disturbances with respect to the specified limits. The turntable containing the EUT was rotated through 360 degrees and the height of the receive antenna was varied 1 to 4 meters and stopped at the azimuth and height producing the maximum emission. Each emission was maximized by changing the orientation of the EUT through three orthogonal planes and changing the polarity of the receive antenna, whichever produced the worst-case emissions. According to 3dB Beamwidth of horn antenna, the horn antenna should be always directed to the EUT when rising height.

Radiated emissions test results are shown in Section 7.8 & 7.9

## 4. ANTENNA REQUIREMENTS

### Excerpt from §15.203 of the FCC Rules/Regulations:

“An intentional radiator antenna shall be designed to ensure that no antenna other than that furnished by the responsible party can be used with the device. The use of a permanently attached antenna or of an antenna that uses a unique coupling to the intentional radiator shall be considered sufficient to comply with the provisions of this section.”

- The antenna of the Digital Wireless Observation Monitor, is permanently attached.
- There are no provisions for connection to an external antenna.

### Conclusion:

The EUT unit complies with the requirement of §15.203.

#### Antenna List

No.	Manufacturer	Part No.	Antenna Type	Peak Gain
1	Master Wave Technology Co., Ltd	98152MSAX004	Dipole	3.91dBi

## 5. TEST EQUIPMENT CALIBRATION DATE

### Conducted Emissions – SR2

Instrument	Manufacturer	Type No.	Asset No.	Cali. Interval	Cali. Due Date
Two-Line V-Network	R&S	ENV216	MRTTWA00019	1 year	2022/3/23
Cable	Rosnol	N1C50-RG400- B1C50-500CM	MRTTWE00013	1 year	2022/6/20
EMI Test Receiver	R&S	ESR3	MRTTWA00009	1 year	2022/3/24

### Radiated Emissions – AC1

Instrument	Manufacturer	Type No.	Asset No.	Cali. Interval	Cali. Due Date
Broadband TRILOG Antenna	SCHWARZBECK	VULB 9162	MRTTWA00001	1 year	2021/10/5
EMI Test Receiver	R&S	ESR3	MRTTWA00009	1 year	2022/3/24
Active Loop Antenna	Schwarzbeck	FMZB 1519B	MRTTWA00002	1 year	2022/5/6
Broadband Horn antenna	SCHWARZBECK	BBHA 9120D	MRTTWA00003	1 year	2022/4/21
Breitband Hornantenna	Schwarzbeck	BBHA 9170	MRTTWA00004	1 year	2022/4/28
Broadband Amplifier	Schwarzbeck	BBV 9721	MRTTWA00006	1 year	2022/4/26
Broadband Preampfier	SCHWARZBECK	BBV 9718	MRTTWA00005	1 year	2022/4/21
Cable	HUBERSUHNER	SF106	MRTTWE00010	1 year	2022/6/15
Cable	Rosnol	K1K50-UP0264- K1K50-4M	MRTTWE00012	1 year	2022/6/20

### Conducted Test Equipment – SR2

Instrument	Manufacturer	Type No.	Asset No.	Cali. Interval	Cali. Due Date
EXA Signal Analyzer	KEYSIGHT	N9010A	MRTTWA00012	1 year	2021/10/14
EXA Signal Analyzer	KEYSIGHT	N9010B	MRTTWA00074	1 year	2022/7/19
USB Wideband Power Sensor	KEYSIGHT	U2021XA	MRTTWA00015	1 year	2022/3/24

### Test Software

Software	Version	Function
e3	9.160520a	EMI Test Software
EMI	V3	EMI Test Software

## 6. MEASUREMENT UNCERTAINTY

Where relevant, the following test uncertainty levels have been estimated for tests performed on the EUT as specified in CISPR 16-4-2. This uncertainty represents an expanded uncertainty expressed at approximately the 95% confidence level using a coverage factor of  $k = 2$ .

<b>Conducted Emission- Power Line</b>
Measuring Uncertainty for a Level of Confidence of 95% ( $U=2Uc(y)$ ): 0.15MHz~30MHz: $\pm 2.53\text{dB}$
<b>Radiated Spurious Emission</b>
Measuring Uncertainty for a Level of Confidence of 95% ( $U=2Uc(y)$ ): 9kHz~30MHz: $\pm 3.92\text{dB}$ 30MHz~1GHz: $\pm 4.25\text{dB}$ 1GHz~18GHz: $\pm 4.40\text{dB}$ 18GHz~40GHz: $\pm 4.45\text{dB}$
<b>Frequency Error</b>
Measuring Uncertainty for a Level of Confidence of 95% ( $U=2Uc(y)$ ): $\pm 78.4\text{Hz}$
<b>Conducted Power</b>
Measuring Uncertainty for a Level of Confidence of 95% ( $U=2Uc(y)$ ): $\pm 0.84\text{dB}$
<b>Conducted Spurious Emission</b>
Measuring Uncertainty for a Level of Confidence of 95% ( $U=2Uc(y)$ ): $\pm 2.65\text{ dB}$
<b>Occupied Bandwidth</b>
Measuring Uncertainty for a Level of Confidence of 95% ( $U=2Uc(y)$ ): 3.3%
<b>Temp. / Humidity</b>
Measuring Uncertainty for a Level of Confidence of 95% ( $U=2Uc(y)$ ): $\pm 0.82^\circ\text{C}/ \pm 3\%$
<b>DC Voltage</b>
Measuring Uncertainty for a Level of Confidence of 95% ( $U=2Uc(y)$ ): $\pm 0.3\%$

## 7. TEST RESULT

### 7.1. Summary

**Product Name:** Digital Wireless Observation Monitor

**FCC Classification:** (DSS) FCC Part 15 Spread Spectrum Transmitter

FCC Part Section(s)	Test Description	Test Limit	Test Condition	Test Result	Reference
15.247(a)(1)	20dB Bandwidth	N/A	Conducted	PASS	Section 7.2
15.247(b)(1)	Output Power	<1 Watt if > 75 non-overlapping channels used		PASS	Section 7.3
15.247(a)(1)	Carrier Frequency Separation	25KHz or 20 dB BW for systems with Output Power < 125mW		PASS	Section 7.4
15.247(a)(1)(iii)	Number of Hopping Channels	> 15 Channels		PASS	Section 7.5
15.247(a)(1)(iii)	Time of Occupancy	< 0.4 sec in 31.6 sec period		PASS	Section 7.6
15.247(d)	Out-of-Band Emissions	Conducted $\geq$ 20dBc		PASS	Section 7.7
15.205 15.209	Spurious Emission	< FCC 15.209 limits	Radiated	PASS	Section 7.8
15.205 15.209	Band Edge Measurement	$\leq$ 74dBuV/m(Peak) $\leq$ 54dBuV/m(Average)		PASS	Section 7.9
15.207	AC Conducted Emissions 150kHz - 30MHz	< FCC 15.207 limits	Line Conducted	N/A	Section 7.10

**Note:**

- 1) Determining compliance is based on the test results met the regulation limits or requirements declared by clients, and the test results don't take into account the value of measurement uncertainty.
- 2) All modes of operation and data rates were investigated. For radiated emission test, every axis (X, Y, Z) was also verified. The test results shown in the following sections represent the worst case emissions.
- 3) The analyzer plots shown in this section were all taken with a correction table loaded into the analyzer. The correction table was used to account for the losses of the cables and attenuators used as part of the system to connect the EUT to the analyzer at all frequencies of interest.
- 4) All antenna port conducted emissions testing was performed on a test bench with the antenna port of the EUT connected to the spectrum analyzer through calibrated cables and attenuators.



## 7.2. 20dB Bandwidth Measurement

### 7.2.1. Test Limit

N/A

### 7.2.2. Test Procedure used

ANSI C63.10-2013 - Section 6.9.2

### 7.2.3. Test Setting

1. Set RBW  $\geq 1\%$  of the 20dB bandwidth
2. VBW  $\geq 3 \times$  RBW
3. Span = approximately 2 to 5 times the 20dB bandwidth, centered on a hopping channel
4. Detector = Peak
5. Trace mode = max hold
6. Sweep = auto couple
7. Allow the trace to stabilize
8. Measure the maximum width of the emission that is constrained by the frequencies associated with the two outermost amplitude points (upper and lower frequencies) that are attenuated by 20 dB relative to the maximum level measured in the fundamental emission.

### 7.2.4. Test Setup

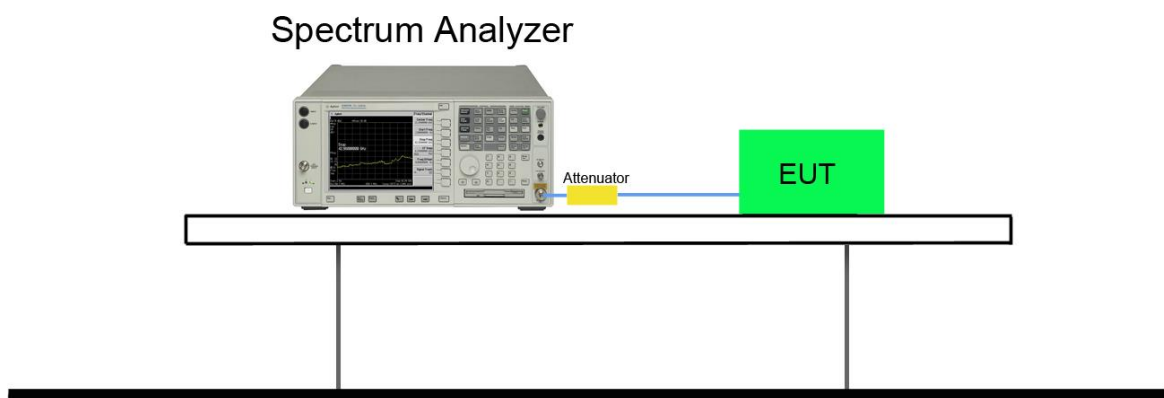

**7.2.5. Test Result**

Test Mode	Channel No.	Frequency (MHz)	20dB Bandwidth (kHz)	99% Bandwidth (kHz)	Result
QPSK	33	2403	4398.00	3903.10	Pass
QPSK	72	2442	4376.00	3913.50	Pass
QPSK	102	2472	4401.00	3922.70	Pass

### CH33 (2403MHz) QPSK

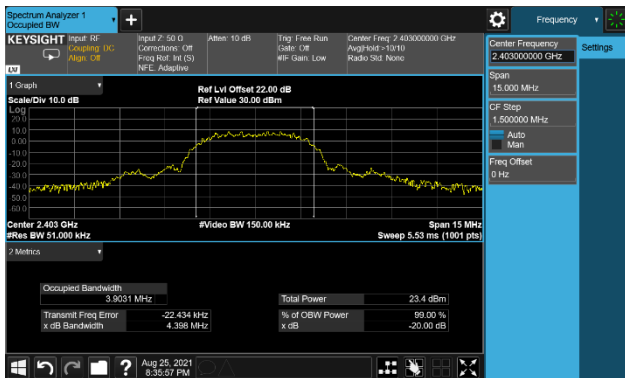

### CH72 (2442MHz) QPSK

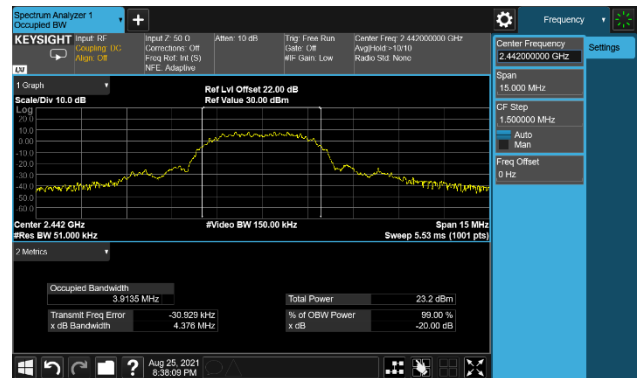

### CH102 (2472MHz) QPSK

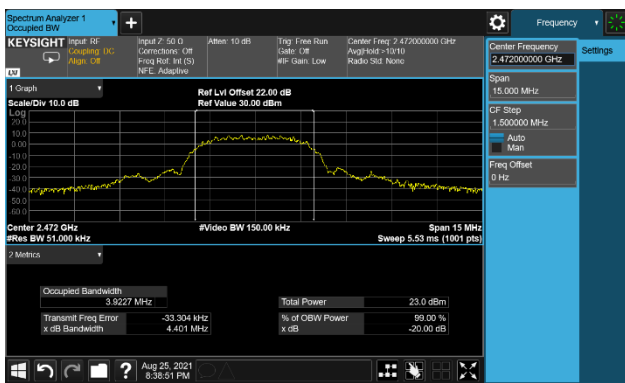

### **7.3. Output Power Measurement**

#### **7.3.1. Test Limit**

The maximum out power permissible output power is 1 Watt for all other frequency hopping systems operating in the 2400-2483.5 MHz band employing at least 75 non-overlapping hopping channels.

For FHSs operating in the band 2400-2483.5 MHz, the maximum peak conducted output power shall not exceed 1.0 W and the e.i.r.p. shall not exceed 4 W if the hopset uses 75 or more hopping channels.

#### **7.3.2. Test Procedure Used**

ANSI C63.10-2013 - Section 7.8.5

### 7.3.3. Test Setting

1. Set RBW  $\geq$  the 20 dB bandwidth of the emission being measured.
2. VBW  $\geq 3 \times$  RBW
3. Span = approximately 2 to 3 times the 20dB bandwidth, centered on a hopping channel
4. Detector = Peak
5. Trace mode = max hold
6. Sweep = auto couple
7. Allow the trace to stabilize, Use the marker-to-peak function to set the marker to the peak of the emission. The indicated level is the peak output power (don't forget added the external attenuation and cable loss)
8. Note: A peak responding power meter may be used, where the power meter and sensor system video bandwidth is greater than the occupied bandwidth of the unlicensed wireless device, rather than a spectrum analyzer.

### 7.3.4. Test Setup

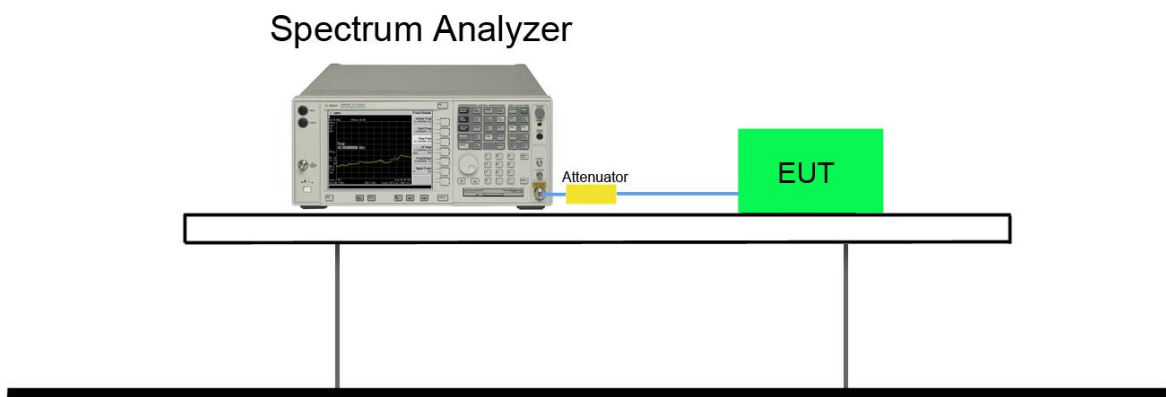

### 7.3.5. Test Result

Test Mode	Channel No.	Frequency (MHz)	Peak Power (dBm)	EIRP (dBm)	Peak Power Limit (dBm)	EIRP Limit (dBm)
QPSK	33	2403	19.45	23.36	< 30	< 36
QPSK	72	2442	18.98	22.89	< 30	< 36
QPSK	102	2472	18.63	22.54	< 30	< 36

Note:

1. The peak power of all test modes is less than 21dBm(125mW).
2. Peak Power Output Value =Reading value on power meter + cable loss.
3. Antenna Gain: 3.91dBi.

## 7.4. Carrier Frequency Separation Measurement

### 7.4.1. Test Limit

The minimum permissible channel separation for this system is 2/3 the value of the 20dB BW.

### 7.4.2. Test Procedure Used

ANSI C63.10-2013 - Section 7.8.2

### 7.4.3. Test Setting

1. Span = wide enough to capture the peaks of two adjacent channels.
2. RBW  $\geq$  1 % of the span
3. VBW  $\geq$  RBW
4. Detector = peak
5. Sweep time = auto couple
6. Trace mode = max hold
7. Trace was allowed to stabilize

### 7.4.4. Test Setup

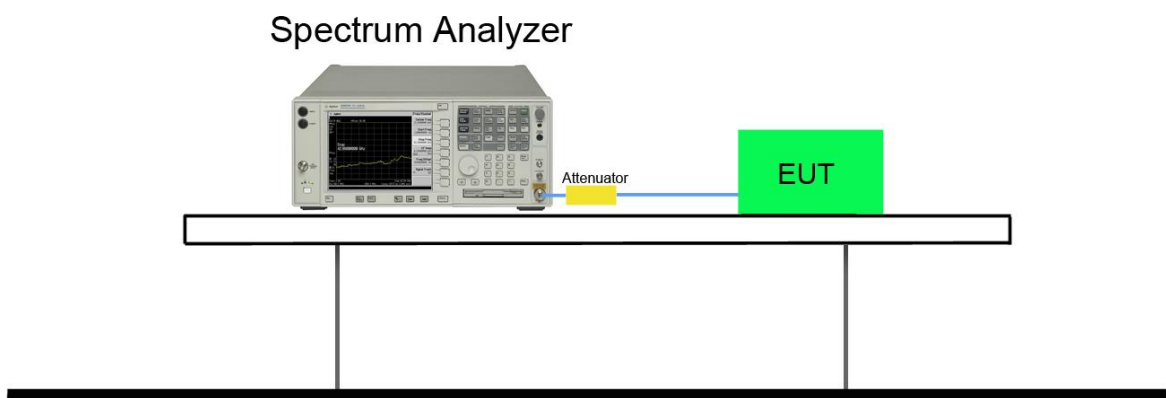

#### 7.4.5. Test Result

Test Mode	Channel No.	Frequency (MHz)	Channel Separation (MHz)	Limit (kHz)	Limit of 2/3*20dB Bandwidth (kHz)	Result
DH5(1M)	33	2403	3.00	25	2932.00	Pass
DH5(1M)	72	2442	3.00	25	2917.33	Pass
DH5(1M)	102	2472	4.00	25	2934.00	Pass

Note:

1. The limit is 25 kHz or 2/3 the value of the 20dB bandwidth of the hopping channel, whichever is greater.
2. The 20dB Bandwidth is refer to section 7.2.



### CH33 (2403MHz) QPSK

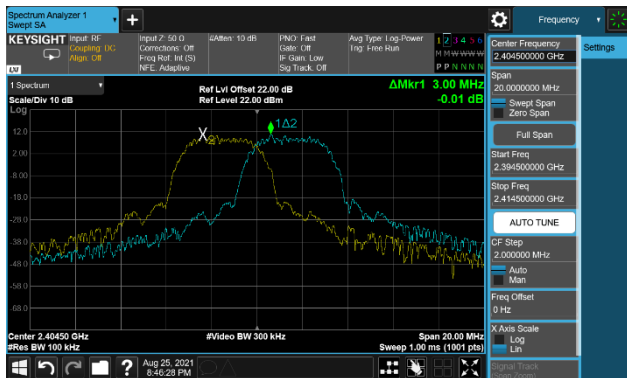

### CH72 (2442MHz) QPSK

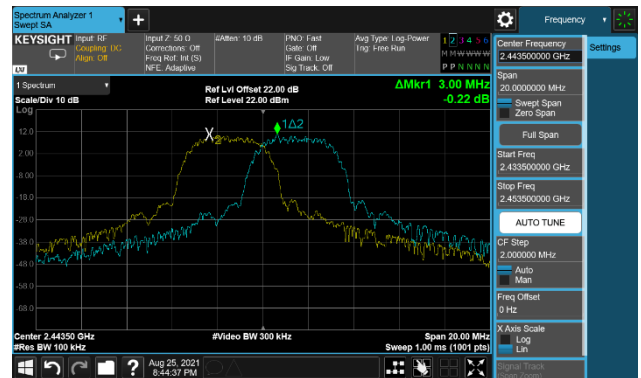

### CH102 (2472MHz) QPSK

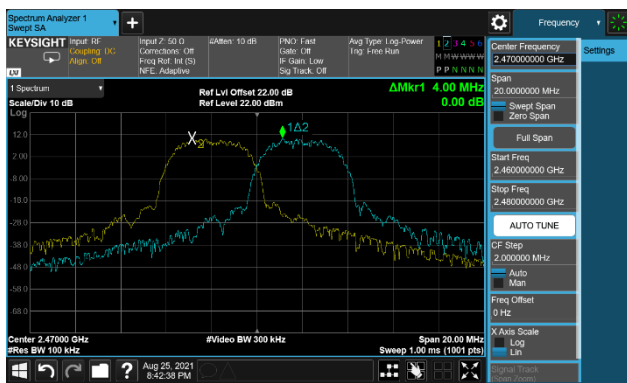

## 7.5. Number of Hopping Channels Measurement

### 7.5.1. Test Limit

This frequency hopping system must employ a minimum of 15 hopping channels.

### 7.5.2. Test Procedure Used

ANSI C63.10-2013 - Section 7.8.3

### 7.5.3. Test Setting

1. Span = the frequency band of operation.
2. RBW  $\geq$  1 % of the span
3. VBW  $\geq$  RBW
4. Detector = Peak
5. Trace mode = max hold
6. Sweep time = auto couple
7. The trace was allowed to stabilize

### 7.5.4. Test Setup

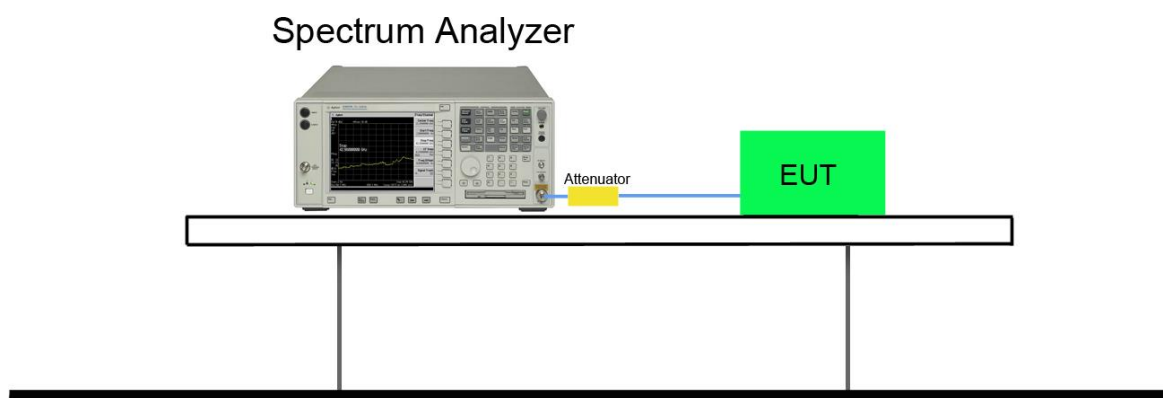

### 7.5.5. Test Result

Test Mode (Hopping)	Channel Numbers	Frequency (MHz)	Limit (Hopping Channels)	Result
QPSK	17	2403~2472	≥ 15	Pass

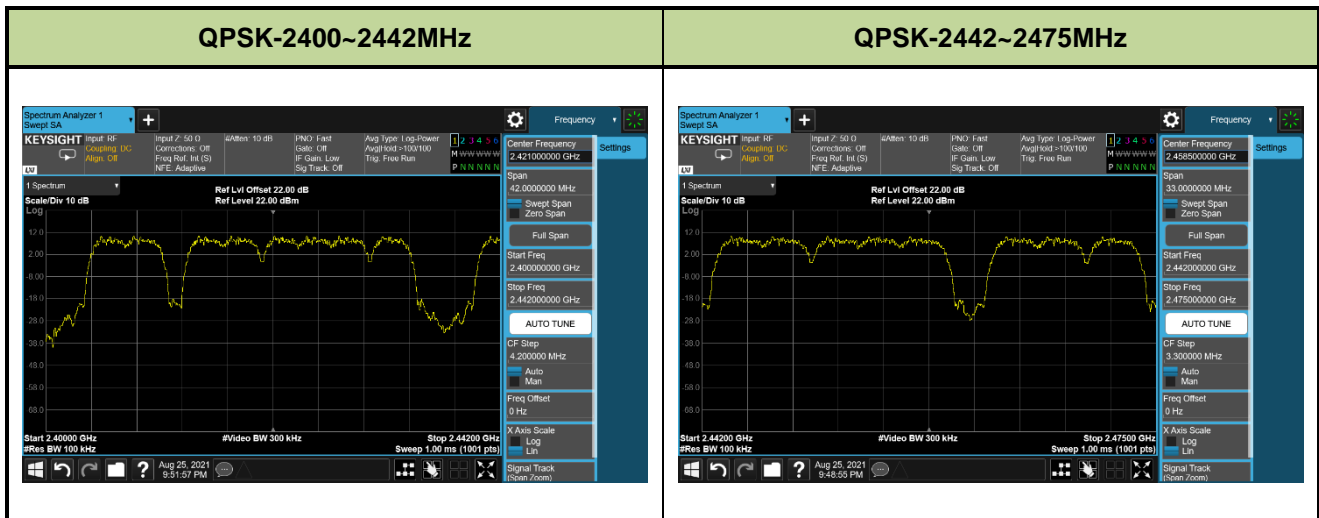

## 7.6. Time of Occupancy Measurement

### 7.6.1. Test Limit

The maximum permissible time of occupancy is 400ms within a period of 400ms multiplied by the number of hopping channels employed.

### 7.6.2. Test Procedure Used

ANSI C63.10-2013 – Section 7.8.4

### 7.6.3. Test Setting

1. Span = zero span, centered on a hopping channel.
2. RBW = 1MHz
3. VBW  $\geq$  RBW
4. Sweep time = as necessary to capture the entire dwell time per hopping channel
5. Detector = Peak
6. Trace mode = max hold

If possible, use the marker-delta function to determine the dwell time. If this value varies with different modes of operation (data rate, modulation format, etc.), repeat this test for each variation. An oscilloscope may be used instead of a spectrum analyzer. The EUT shall show compliance with the appropriate regulatory limit for the number of hopping channels. A plot of the data shall be included in the test report.

### 7.6.4. Test Setup

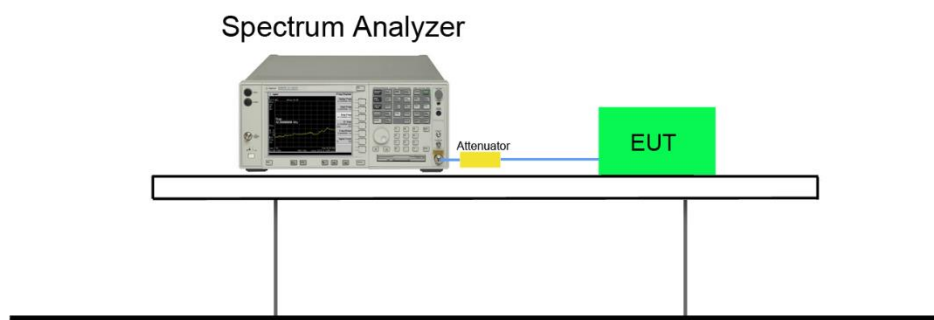

**7.6.5. Test Result**

Test Mode	Frequency (MHz)	Time of Occupancy (ms)	Hopping of Numbers	Sweep time (ms)	Duty cycle	Dwell Time (Sec)	Limit (Sec)	Result
QPSK	2403	0.35	25	50	1.75	0.07	0.4	Pass
	2442	0.35	25	50	1.75	0.07	0.4	Pass
	2472	0.35	25	50	1.75	0.07	0.4	Pass

Note:

1. Duty cycle =  $((\text{Time slot length (ms)} \times \text{Hopping of Number}) / \text{Sweep time (ms)}) \circ$
2. Dwell time =  $((\text{Duty cycle} \times (\text{Time Period} <0.4 \times 79>)) / (\text{Total Hopping of Number} <79>)) \circ$

### CH33 (2403MHz) - Duty Cycle

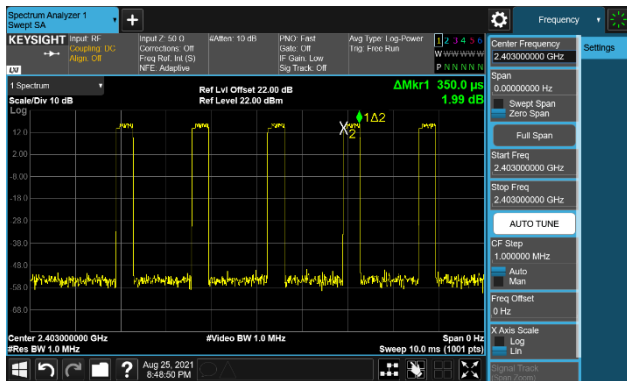

### CH33 (2403MHz) - Dwell time

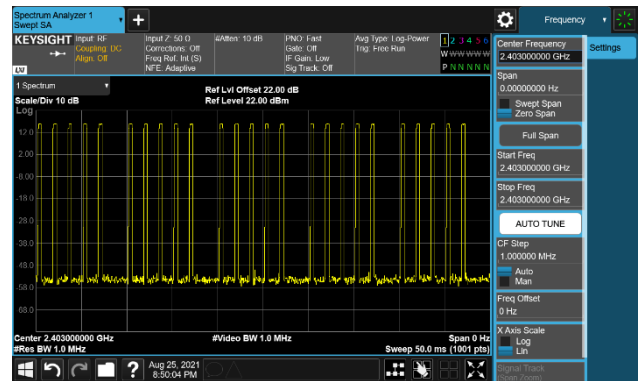

### CH72 (2442MHz) - Duty Cycle

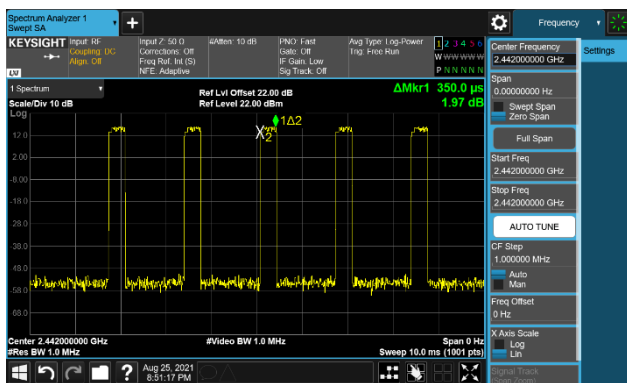

### CH72 (2442MHz) - Dwell time

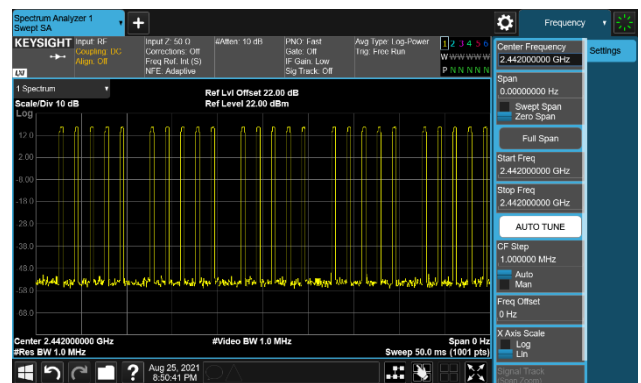

### CH102 (2472MHz) - Duty Cycle

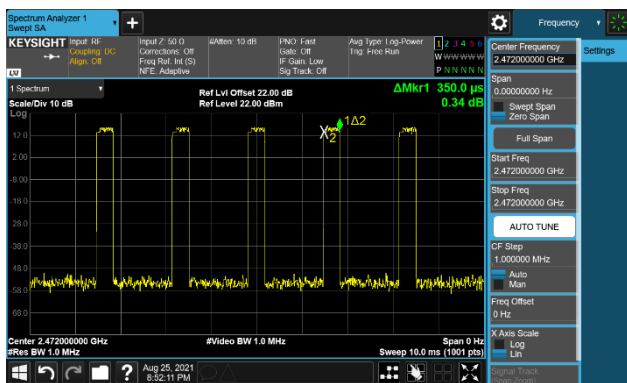

### CH102 (2472MHz) - Dwell time

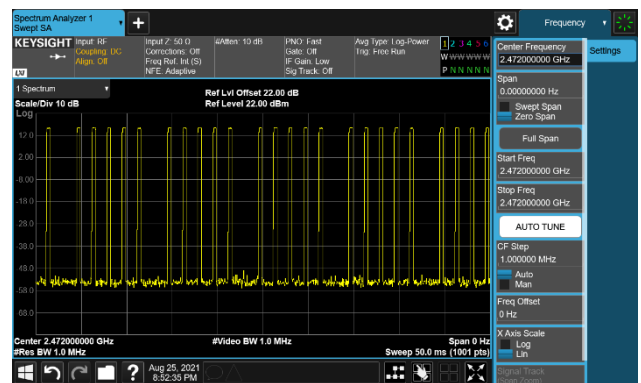

## **7.7. Out-of-Band Spurious Emissions Emissions Measurement**

### **7.7.1. Test Limit**

In any 100 kHz bandwidth outside the frequency band in which the spread spectrum or digitally modulated intentional radiator is operating, the radio frequency power that is produced by the intentional radiator shall be at least 20 dB below that in the 100 kHz bandwidth within the band that contains the highest level of the desired power, based on either an RF conducted or a radiated measurement, provided the transmitter demonstrates compliance with the peak conducted or a radiated measurement, provided the transmitter demonstrates compliance with the peak conducted power limits. If the transmitter complies with the conducted power limits based on the use of RMS averaging over a time interval, the attenuation required under this paragraph shall be 30 dB instead of 20 dB.

### **7.7.2. Test Procedure Used**

ANSI C63.10-2013 - Section 7.8.8

### 7.7.3. Test Setting

1. Span = wide enough to capture the peak level of the in-band emission and all spurious emissions (e.g., harmonics) from the lowest frequency generated in the EUT up through the 10th harmonic. Typically, several plots are required to cover this entire span.
2. RBW = 100 KHz
3. VBW  $\geq$  RBW
4. Detector = peak
5. Sweep time = auto couple
6. Trace mode = max hold
7. Trace was allowed to stabilize

Set the marker on the peak of any spurious emission recorded. The level displayed must comply with the limit specified in this section.

### 7.7.4. Test Setup

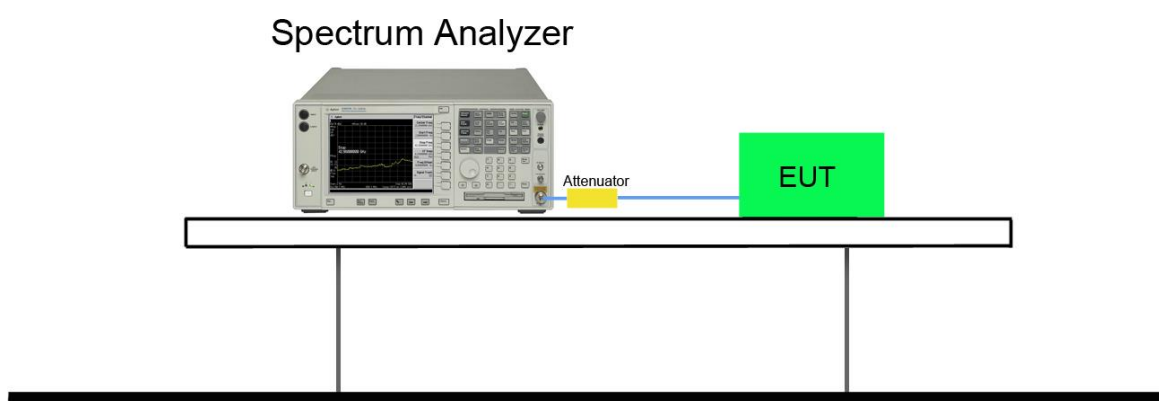



**7.7.5. Test Result**

Test Mode	Channel No.	Frequency (MHz)	Limit (MHz)	Result
QPSK	33	2403	20dBc	Pass
QPSK	72	2442	20dBc	Pass
QPSK	102	2472	20dBc	Pass

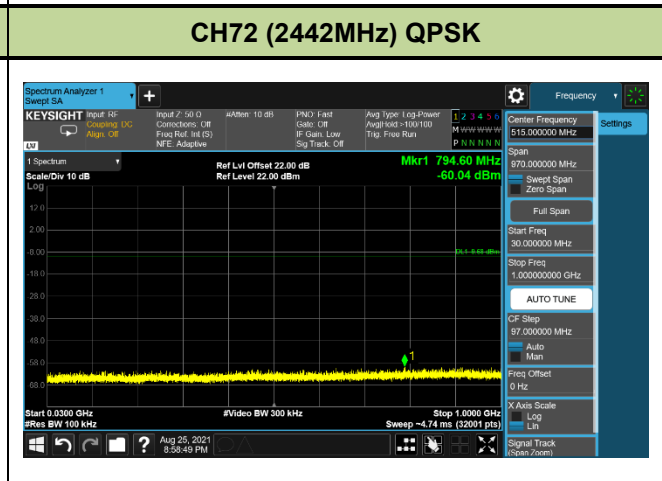
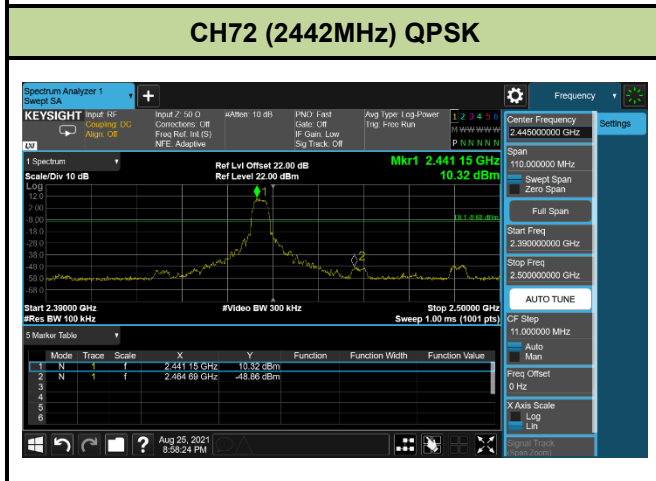
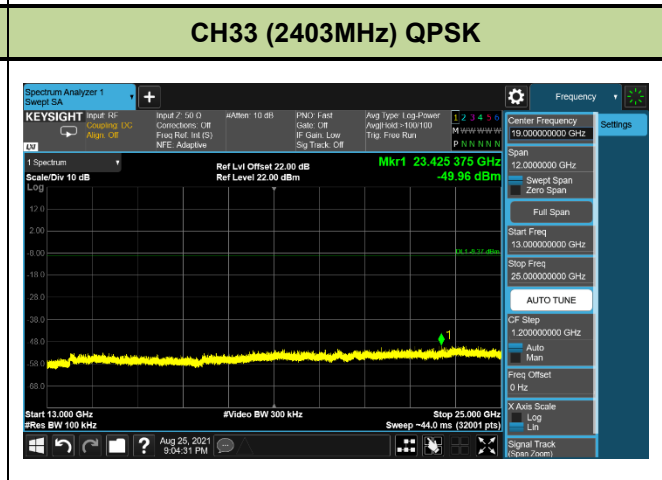
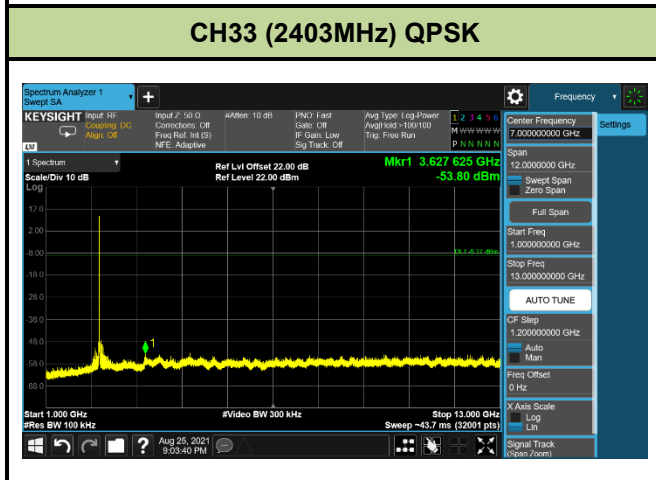
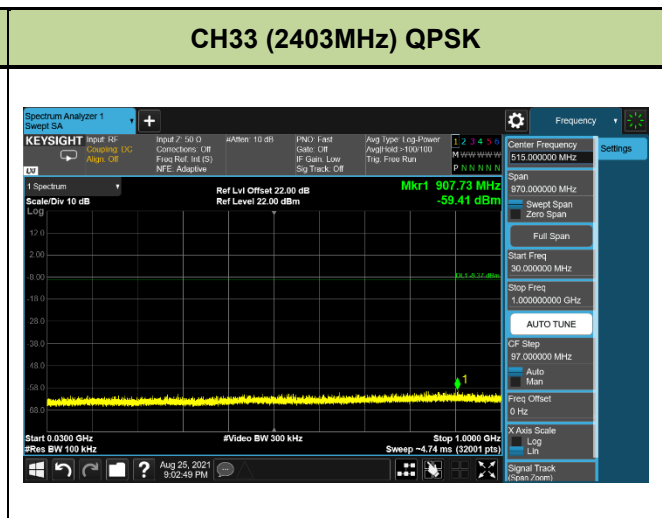
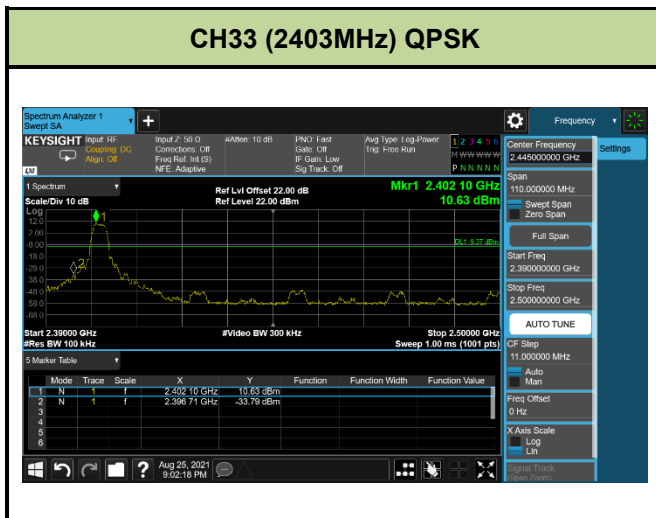

**CH72 (2442MHz) QPSK**

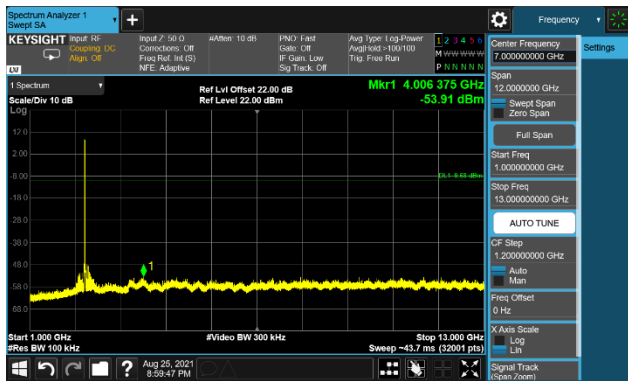

**CH72 (2442MHz) QPSK**

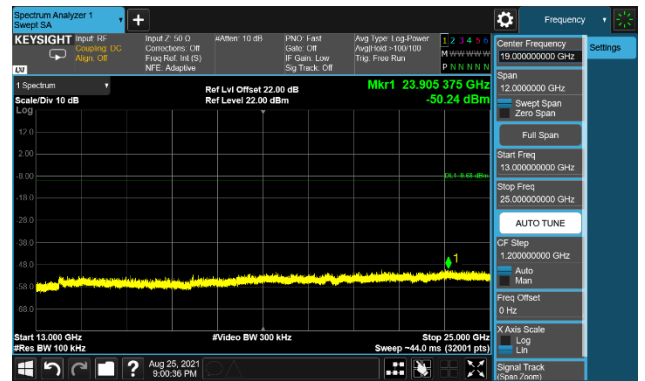

**CH102 (2472MHz) QPSK**

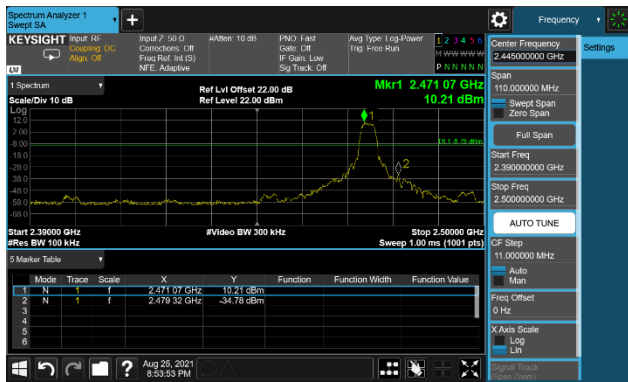

**CH102 (2472MHz) QPSK**

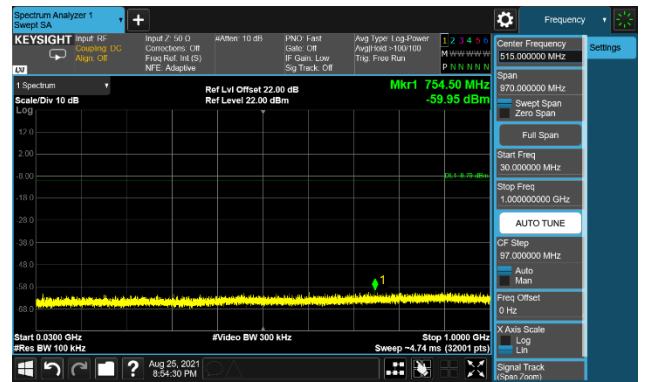

**CH102 (2472MHz) QPSK**

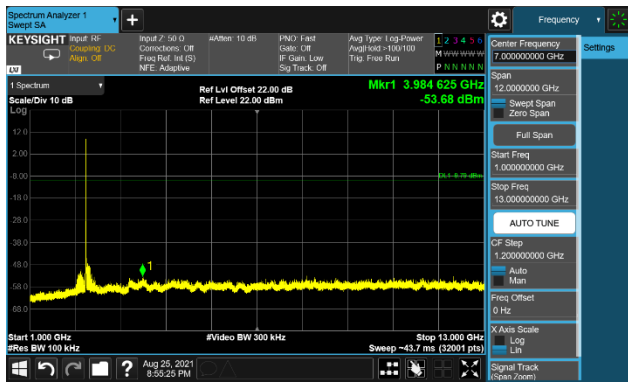

**CH102 (2472MHz) QPSK**

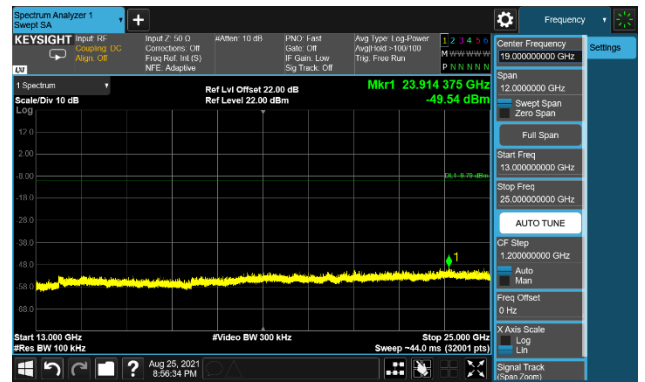

## 7.8. Radiated Spurious Emission Measurement

### 7.8.1. Test Limit

All out of band emissions appearing in a restricted band as specified in Section 15.205 of the Title 47 CFR must not exceed the limits shown in Table per Section 15.209.

FCC Part 15 Subpart C Paragraph 15.209		
Frequency [MHz]	Field Strength [V/m]	Measured Distance [Meters]
0.009 - 0.490	2400/F (kHz)	300
0.490 - 1.705	24000/F (kHz)	30
1.705 – 30	30	30
30 – 88	100	3
88 – 216	150	3
216 – 960	200	3
Above 960	500	3

### 7.8.2. Test Procedure Used

ANSI C63.10-2013 - Section 11.12.1

### 7.8.3. Test Setting

#### Peak Field Strength Measurements

1. Analyzer center frequency was set to the frequency of the radiated spurious emission of interest
2. RBW = as specified in Table 1
3. VBW = 3 \* RBW
4. Detector = peak
5. Sweep time = auto couple
6. Trace mode = max hold

- Trace was allowed to stabilize

**Table 1 - RBW as a function of frequency**

Frequency	RBW
9 ~ 150 kHz	200 ~ 300 Hz
0.15 ~ 30 MHz	9 ~ 10 kHz
30 ~ 1000 MHz	100 ~ 120 kHz
> 1000 MHz	1 MHz

#### **Average Field Strength Measurements**

- Analyzer center frequency was set to the frequency of the radiated spurious emission of interest
- RBW = 1MHz
- VBW  $\geq 1/T$
- De As an alternative, the instrument may be set to linear detector mode. Ensure that video filtering is applied in linear voltage domain (rather than in a log or dB domain). Some instruments require linear display mode in order to accomplish this. Others have a setting for Average-VBW Type, which can be set to "Voltage" regardless of the display mode
- Detector = Peak
- Sweep time = auto
- Trace mode = max hold
- Allow max hold to run for at least 50 times (1/duty cycle) traces

### 7.8.4. Test Setup

#### 9kHz ~ 30MHz Test Setup:

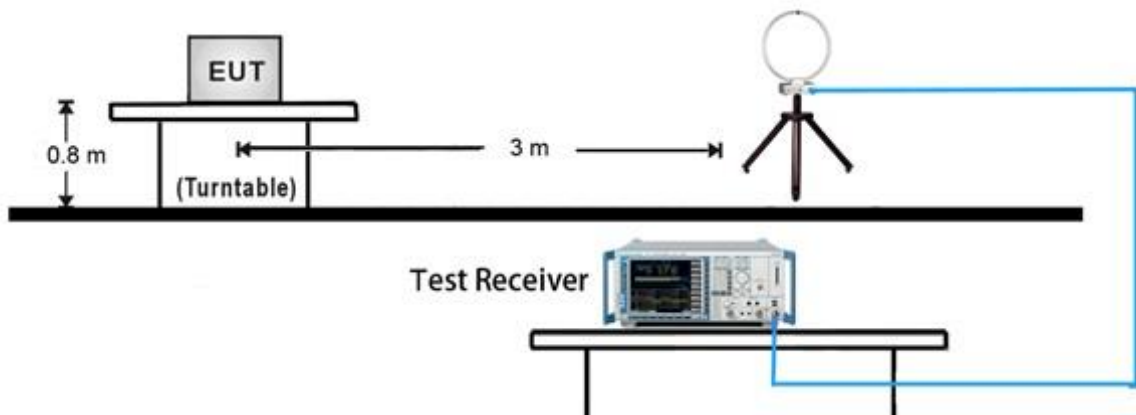

#### 30MHz ~ 1GHz Test Setup:

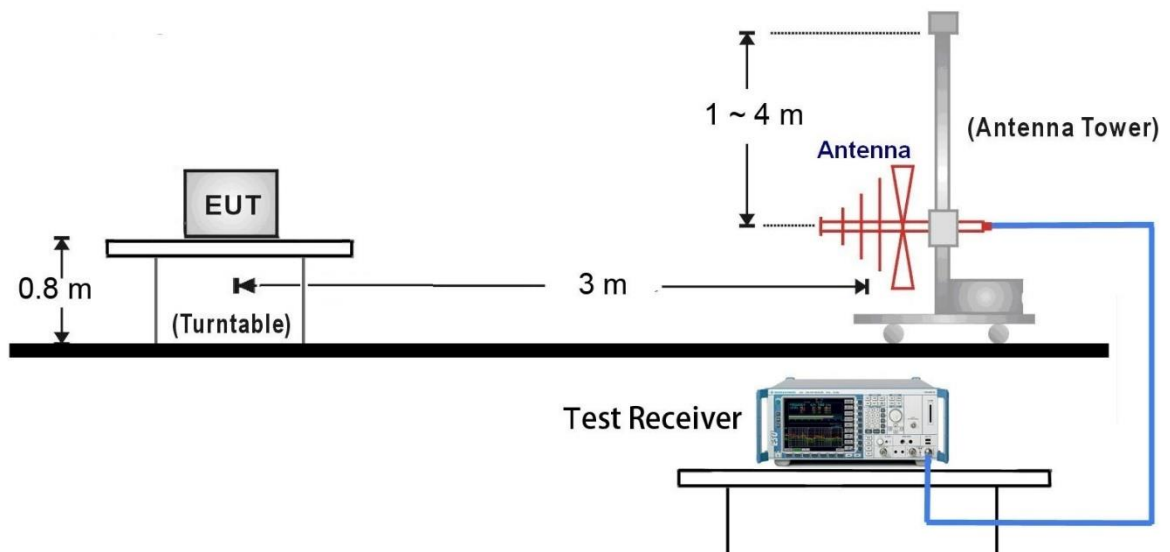

1GHz ~ 18GHz Test Setup:

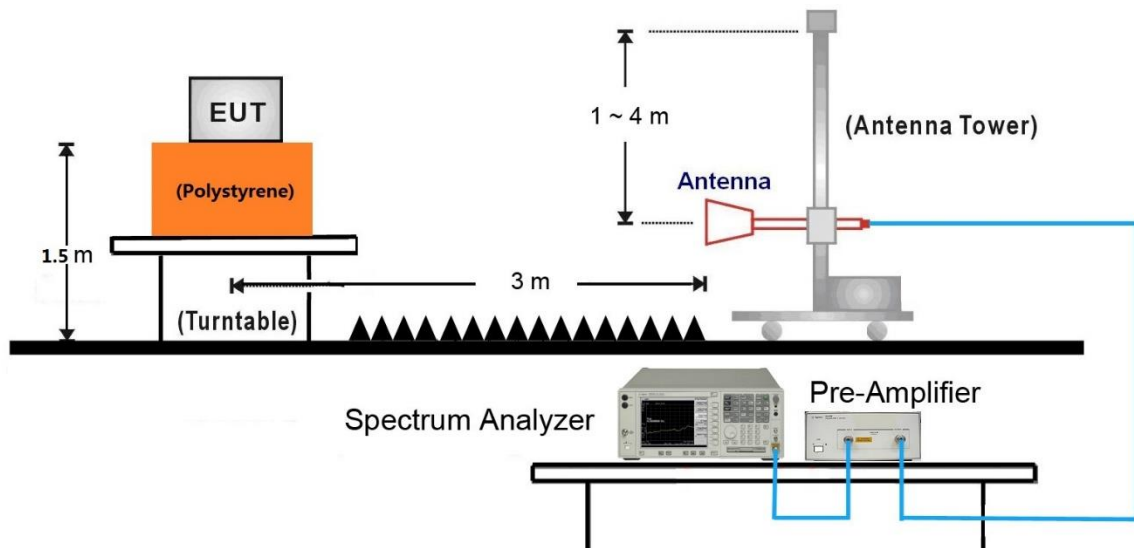

18GHz ~40GHz Test Setup:

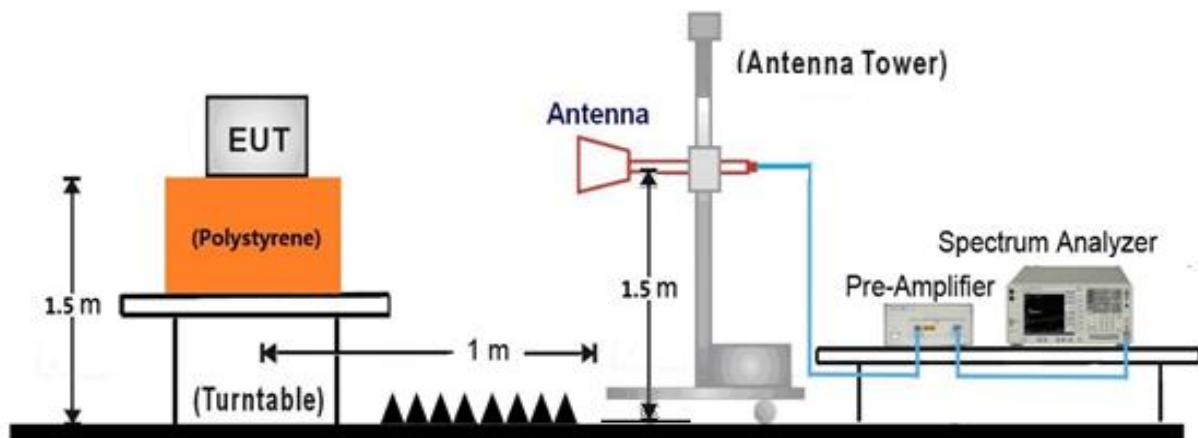

**7.8.5. Test Result**

EUT	Digital Wireless Observation Monitor	Date of Test	2021-09-06
Factor	VULB 9162	Temp. / Humidity	24°C /57%
Polarity	Horizontal	Site / Test Engineer	AC1 / Volvo
Test Mode	FHSS 2.4G_QPSK_TX_2442MHz	Test Voltage	DC 12V

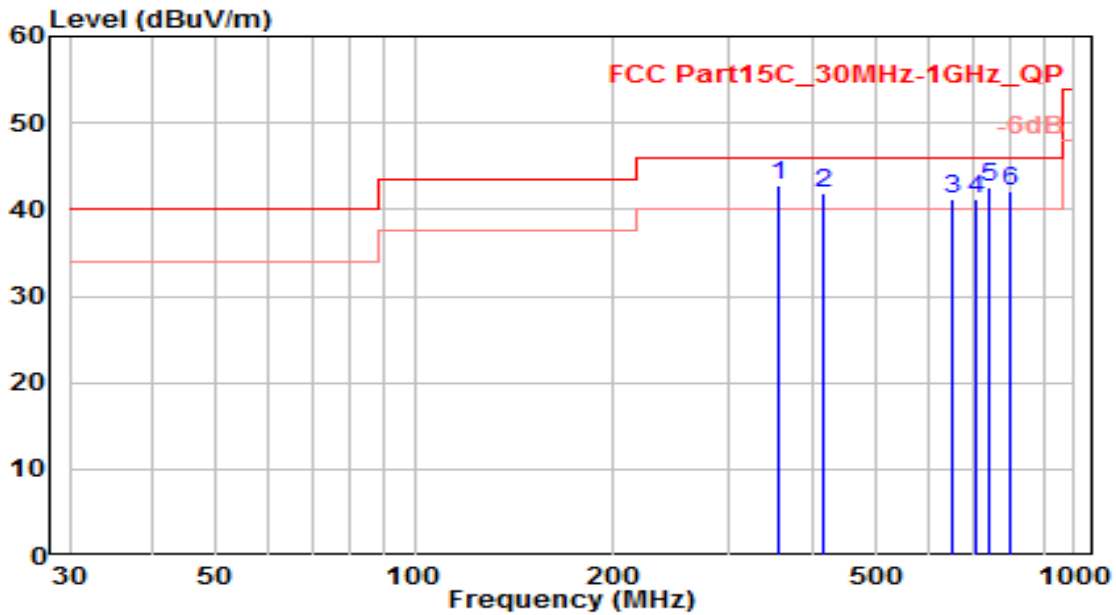

No	Frequency (MHz)	Reading (dBuV)	C.F (dB)	Measurement (dBuV/m)	Margin (dB)	Limit (dBuV/m)	Height (cm)	Angle (deg)	Remark (QP/PK/AV)
1	* 355.621	19.56	23.32	42.88	-3.12	46.00	100	160	QP
2	415.505	17.56	24.32	41.88	-4.12	46.00	100	55	QP
3	652.561	12.56	28.65	41.21	-4.79	46.00	100	205	QP
4	712.650	11.80	29.52	41.32	-4.68	46.00	100	360	QP
5	742.541	12.51	29.99	42.50	-3.50	46.00	100	285	QP
6	800.056	11.51	30.50	42.01	-3.99	46.00	100	65	QP

Note:

1. " \*", means this data is the worst emission level.
2. C.F (Correction Factor) = Antenna Factor (dB)+ Cable Loss (dB).
3. Measurement (dBuV/m) = Reading(dBuV) + C.F (Correction Factor).
4. The emission levels of other frequencies are very lower than the limit and not show in test report.



EUT	Digital Wireless Observation Monitor	Date of Test	2021-09-06
Factor	VULB 9162	Temp. / Humidity	24°C /57%
Polarity	Vertical	Site / Test Engineer	AC1 / Volvo
Test Mode	FHSS 2.4G_QPSK_TX_2442MHz	Test Voltage	DC 12V

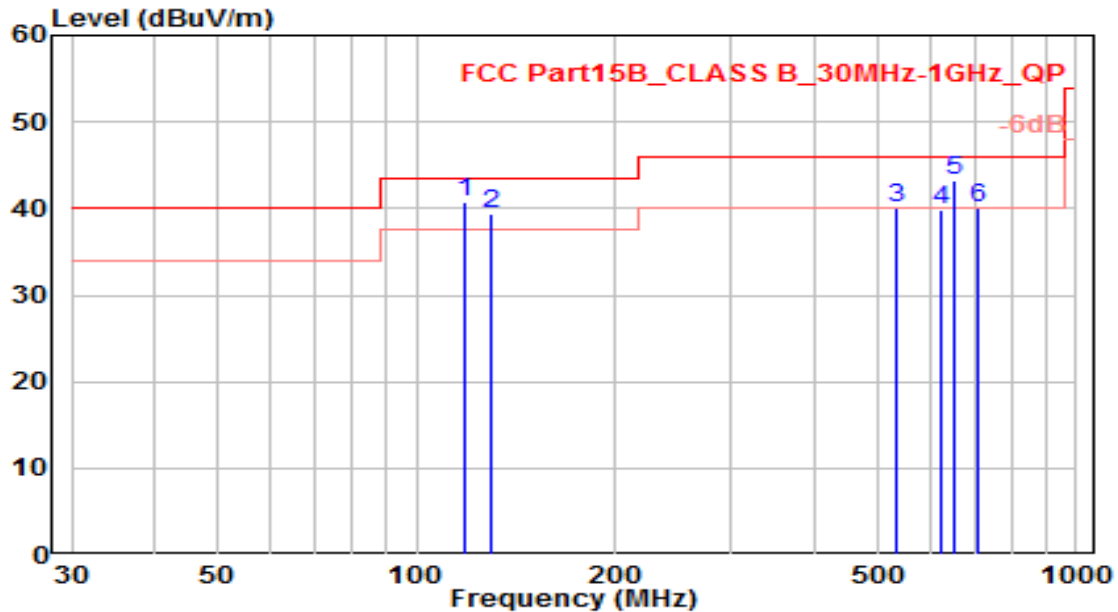

No	Frequency (MHz)	Reading (dBuV)	C.F (dB)	Measurement (dBuV/m)	Margin (dB)	Limit (dBuV/m)	Height (cm)	Angle (deg)	Remark (QP/PK/AV)
1	* 118.561	23.40	17.45	40.85	-2.65	43.50	100	320	QP
2	129.360	23.07	16.35	39.41	-4.09	43.50	100	165	QP
3	534.561	13.51	26.63	40.13	-5.87	46.00	100	210	QP
4	623.561	11.56	28.18	39.74	-6.26	46.00	100	325	QP
5	652.561	14.56	28.65	43.21	-2.79	46.00	100	20	QP
6	712.561	10.51	29.52	40.02	-5.98	46.00	100	170	QP

Note:

1. " \*", means this data is the worst emission level.
2. C.F (Correction Factor) = Antenna Factor (dB)+ Cable Loss (dB).
3. Measurement (dBuV/m) = Reading(dBuV) + C.F (Correction Factor).
4. The emission levels of other frequencies are very lower than the limit and not show in test report.

EUT	Digital Wireless Observation Monitor	Date of Test	2021-08-26
Factor	BBHA 9120D & BBHA 9170	Temp. / Humidity	24°C /65%
Polarity	Horizontal	Site / Test Engineer	AC1 / Kaunaz
Test Mode	FHSS 2.4G_QPSK_TX_2403MHz	Test Voltage	DC 12V

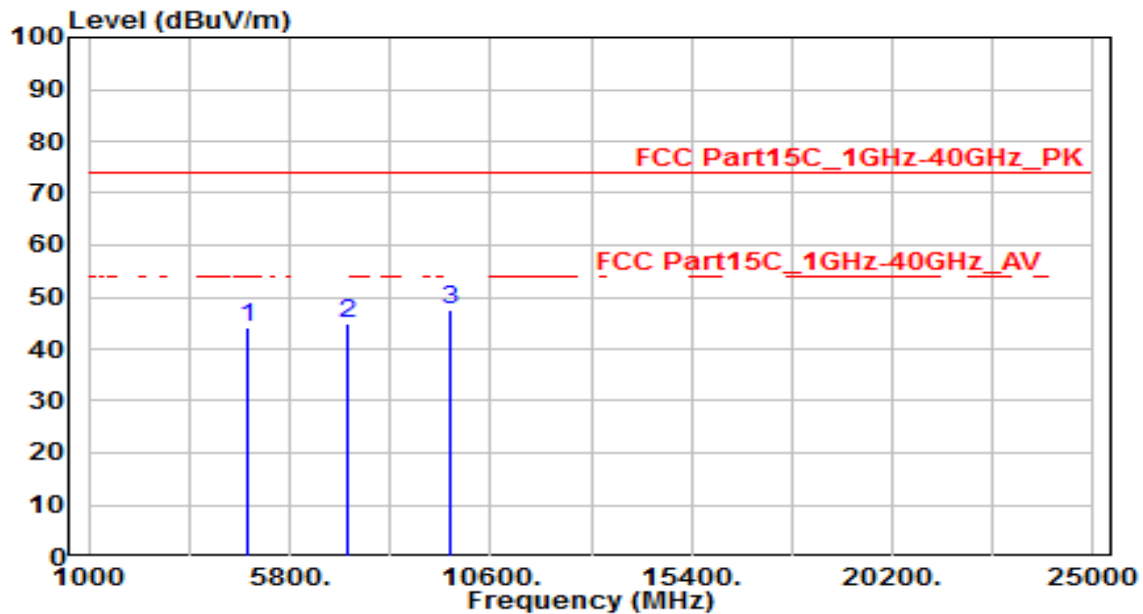

No	Frequency (MHz)	Reading (dBuV)	C.F (dB)	Measurement (dBuV/m)	Margin (dB)	Limit (dBuV/m)	Height (cm)	Angle (deg)	Remark (QP/PK/AV)
1	4806.000	40.43	3.60	44.03	-29.97	74.00	150	360	Peak
2	7209.000	33.16	11.73	44.88	-29.12	74.00	150	360	Peak
3	* 9612.000	31.57	15.91	47.48	-26.52	74.00	150	360	Peak

Note:

1. " \*", means this data is the worst emission level.
2. C.F (Correction Factor) = Antenna Factor (dB)+ Cable Loss (dB) – Pre-amplifier(dB).
3. Measurement (dBuV/m) = Reading(dBuV) + C.F (Correction Factor).
4. The emission levels of other frequencies are very lower than the limit and not show in test report.

EUT	Digital Wireless Observation Monitor	Date of Test	2021-08-26
Factor	BBHA 9120D & BBHA 9170	Temp. / Humidity	24°C /65%
Polarity	Vertical	Site / Test Engineer	AC1 / Kaunaz
Test Mode	FHSS 2.4G_QPSK_TX_2403MHz	Test Voltage	DC 12V

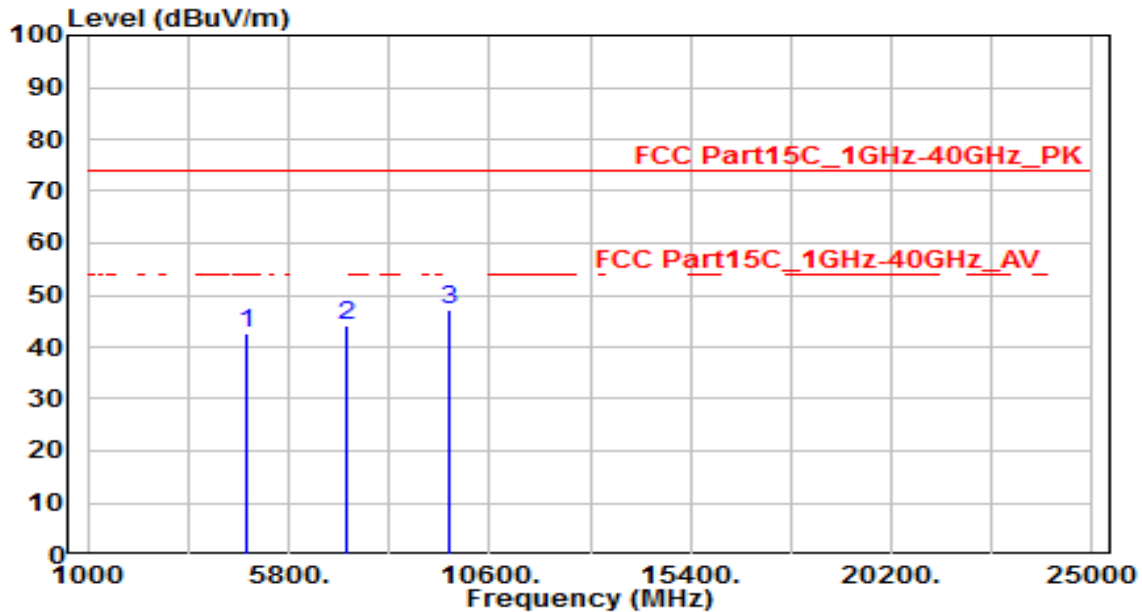

No	Frequency (MHz)	Reading (dBuV)	C.F (dB)	Measurement (dBuV/m)	Margin (dB)	Limit (dBuV/m)	Height (cm)	Angle (deg)	Remark (QP/PK/AV)
1	4806.000	39.01	3.60	42.61	-31.39	74.00	150	360	Peak
2	7209.000	32.58	11.73	44.31	-29.69	74.00	150	360	Peak
3	* 9612.000	31.39	15.91	47.30	-26.70	74.00	150	360	Peak

Note:

1. " \*", means this data is the worst emission level.
2. C.F (Correction Factor) = Antenna Factor (dB)+ Cable Loss (dB) – Pre-amplifier(dB).
3. Measurement (dBuV/m) = Reading(dBuV) + C.F (Correction Factor).
4. The emission levels of other frequencies are very lower than the limit and not show in test report.

EUT	Digital Wireless Observation Monitor	Date of Test	2021-08-26
Factor	BBHA 9120D & BBHA 9170	Temp. / Humidity	24°C /65%
Polarity	Horizontal	Site / Test Engineer	AC1 / Kaunaz
Test Mode	FHSS 2.4G_QPSK_TX_2442MHz	Test Voltage	DC 12V

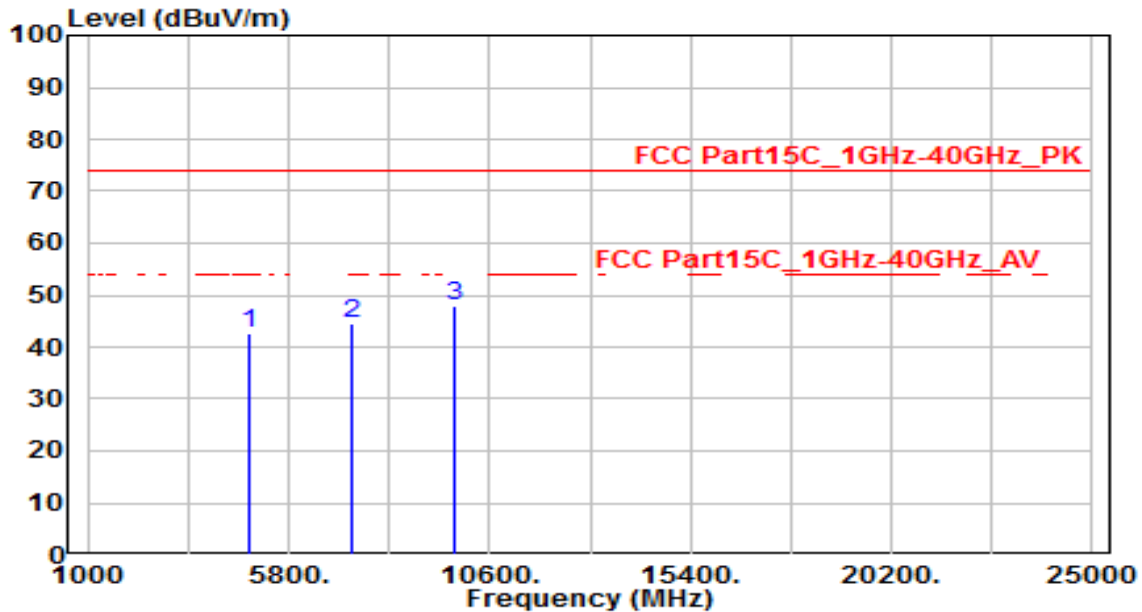

No	Frequency (MHz)	Reading (dBuV)	C.F (dB)	Measurement (dBuV/m)	Margin (dB)	Limit (dBuV/m)	Height (cm)	Angle (deg)	Remark (QP/PK/AV)
1	4884.000	38.93	3.74	42.67	-31.33	74.00	150	360	Peak
2	7326.000	32.38	12.24	44.62	-29.38	74.00	150	360	Peak
3	* 9768.000	31.60	16.17	47.77	-26.23	74.00	150	360	Peak

Note:

1. " \*", means this data is the worst emission level.
2. C.F (Correction Factor) = Antenna Factor (dB)+ Cable Loss (dB) – Pre-amplifier(dB).
3. Measurement (dBuV/m) = Reading(dBuV) + C.F (Correction Factor).
4. The emission levels of other frequencies are very lower than the limit and not show in test report.

EUT	Digital Wireless Observation Monitor	Date of Test	2021-08-26
Factor	BBHA 9120D & BBHA 9170	Temp. / Humidity	24°C /65%
Polarity	Vertical	Site / Test Engineer	AC1 / Kaunaz
Test Mode	FHSS 2.4G_QPSK_TX_2442MHz	Test Voltage	DC 12V

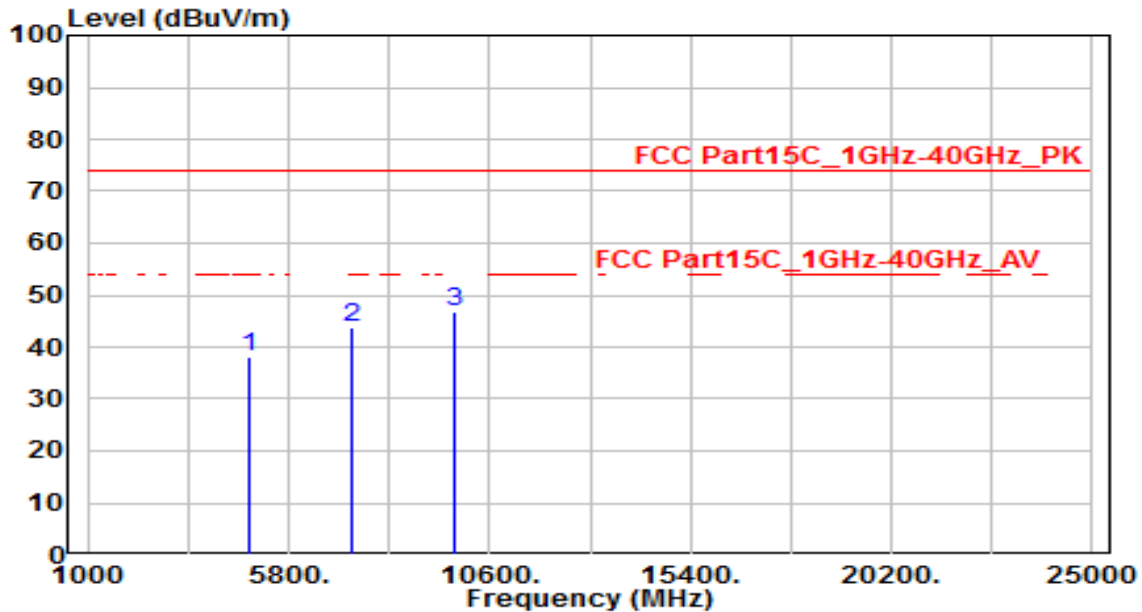

No	Frequency (MHz)	Reading (dBuV)	C.F (dB)	Measurement (dBuV/m)	Margin (dB)	Limit (dBuV/m)	Height (cm)	Angle (deg)	Remark (QP/PK/AV)
1	4884.000	34.53	3.74	38.27	-35.73	74.00	150	360	Peak
2	7326.000	31.49	12.24	43.74	-30.26	74.00	150	360	Peak
3	* 9768.000	30.64	16.17	46.81	-27.19	74.00	150	360	Peak

Note:

1. " \*", means this data is the worst emission level.
2. C.F (Correction Factor) = Antenna Factor (dB)+ Cable Loss (dB) – Pre-amplifier(dB).
3. Measurement (dBuV/m) = Reading(dBuV) + C.F (Correction Factor).
4. The emission levels of other frequencies are very lower than the limit and not show in test report.

EUT	Digital Wireless Observation Monitor	Date of Test	2021-08-26
Factor	BBHA 9120D & BBHA 9170	Temp. / Humidity	24°C /65%
Polarity	Horizontal	Site / Test Engineer	AC1 / Kaunaz
Test Mode	FHSS 2.4G_QPSK_TX_2472MHz	Test Voltage	DC 12V

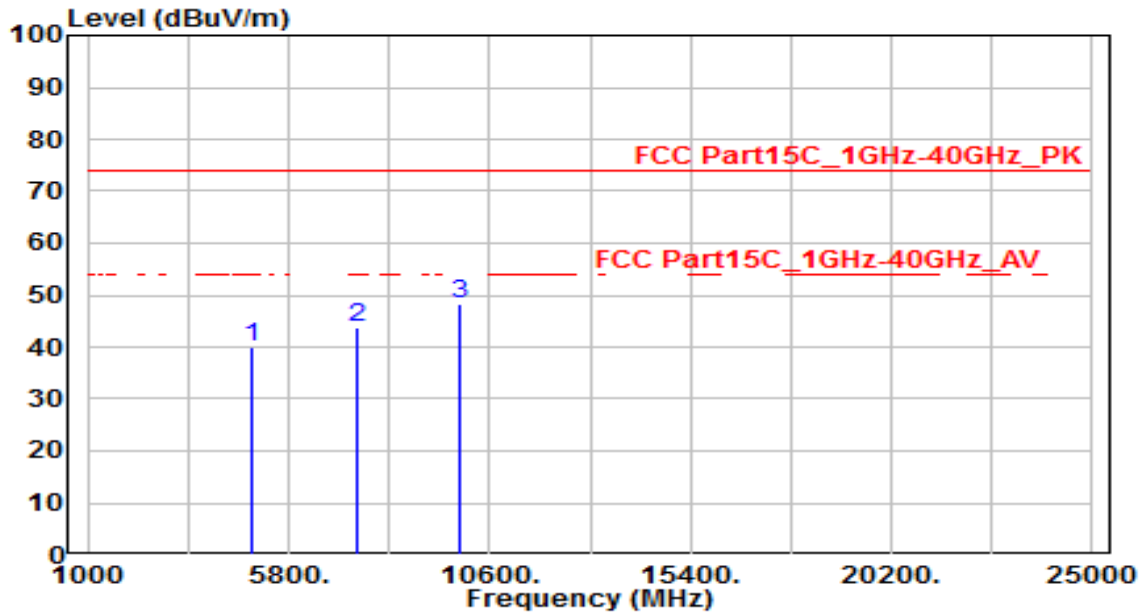

No	Frequency (MHz)	Reading (dBuV)	C.F (dB)	Measurement (dBuV/m)	Margin (dB)	Limit (dBuV/m)	Height (cm)	Angle (deg)	Remark (QP/PK/AV)
1	4944.000	36.01	3.85	39.86	-34.14	74.00	150	360	Peak
2	7416.000	31.30	12.64	43.95	-30.05	74.00	150	360	Peak
3	* 9888.000	31.81	16.37	48.18	-25.82	74.00	150	360	Peak

Note:

- " \*", means this data is the worst emission level.
- C.F (Correction Factor) = Antenna Factor (dB)+ Cable Loss (dB) – Pre-amplifier(dB).
- Measurement (dBuV/m) = Reading(dBuV) + C.F (Correction Factor).
- The emission levels of other frequencies are very lower than the limit and not show in test report.

EUT	Digital Wireless Observation Monitor	Date of Test	2021-08-26
Factor	BBHA 9120D & BBHA 9170	Temp. / Humidity	24°C /65%
Polarity	Vertical	Site / Test Engineer	AC1 / Kaunaz
Test Mode	FHSS 2.4G_QPSK_TX_2472MHz	Test Voltage	DC 12V

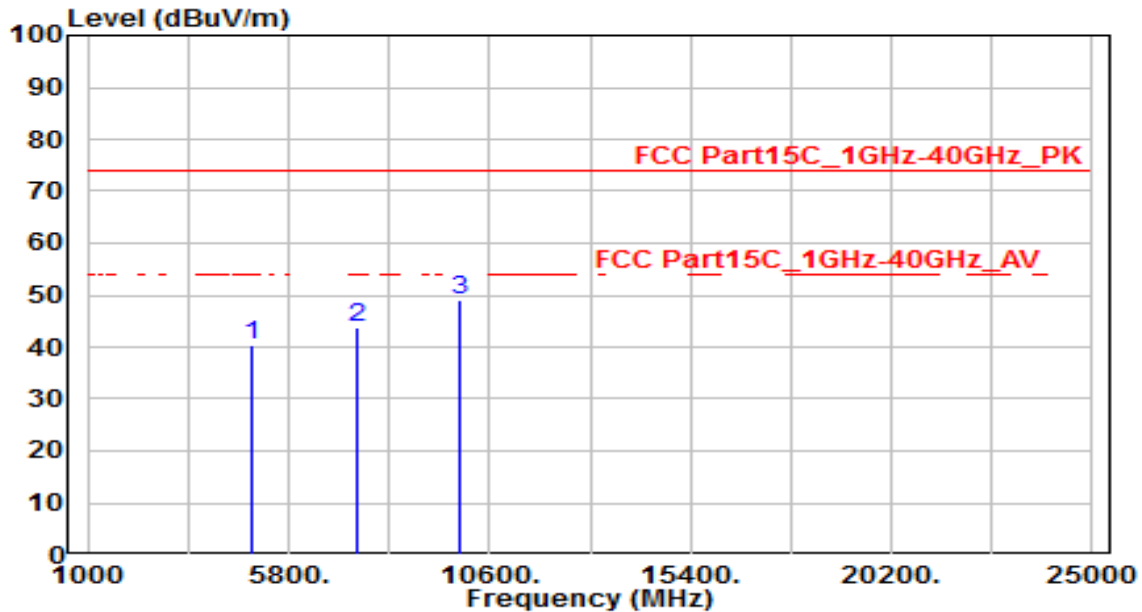

No	Frequency (MHz)	Reading (dBuV)	C.F (dB)	Measurement (dBuV/m)	Margin (dB)	Limit (dBuV/m)	Height (cm)	Angle (deg)	Remark (QP/PK/AV)
1	4944.000	36.66	3.85	40.50	-33.50	74.00	150	360	Peak
2	7416.000	31.06	12.64	43.71	-30.29	74.00	150	360	Peak
3	* 9888.000	32.56	16.37	48.94	-25.06	74.00	150	360	Peak

Note:

1. " \*", means this data is the worst emission level.
2. C.F (Correction Factor) = Antenna Factor (dB)+ Cable Loss (dB) – Preamplifier(dB).
3. Measurement (dBuV/m) = Reading(dBuV) + C.F (Correction Factor).
4. The emission levels of other frequencies are very lower than the limit and not show in test report.

## 7.9. Radiated Restricted Band Edge Measurement

### 7.9.1. Test Limit

All out of band emissions appearing in a restricted band as specified in Section 15.205 of the Title 47 CFR must not exceed the limits shown in Table per Section 15.209.

FCC Part 15 Subpart C Paragraph 15.209		
Frequency [MHz]	Field Strength [V/m]	Measured Distance [Meters]
0.009 - 0.490	2400/F (kHz)	300
0.490 - 1.705	24000/F (kHz)	30
1.705 – 30	30	30
30 – 88	100	3
88 – 216	150	3
216 – 960	200	3
Above 960	500	3

### 7.9.2. Test Procedure Used

ANSI C63.10-2013 - Section 11.12.1

### 7.9.3. Test Setting

#### Peak Field Strength Measurements

1. Analyzer center frequency was set to the frequency of the radiated spurious emission of interest
2. RBW = as specified in Table 1
3. VBW = 3 \* RBW
4. Detector = peak
5. Sweep time = auto couple
6. Trace mode = max hold



- Trace was allowed to stabilize

**Table 1 - RBW as a function of frequency**

Frequency	RBW
9 ~ 150 kHz	200 ~ 300 Hz
0.15 ~ 30 MHz	9 ~ 10 kHz
30 ~ 1000 MHz	100 ~ 120 kHz
> 1000 MHz	1 MHz

**Average Field Strength Measurements**

- Analyzer center frequency was set to the frequency of the radiated spurious emission of interest
- RBW = 1MHz
- VBW  $\geq 1/T$
- De As an alternative, the instrument may be set to linear detector mode. Ensure that video filtering is applied in linear voltage domain (rather than in a log or dB domain). Some instruments require linear display mode in order to accomplish this. Others have a setting for Average-VBW Type, which can be set to "Voltage" regardless of the display mode
- Detector = Peak
- Sweep time = auto
- Trace mode = max hold
- Allow max hold to run for at least 50 times (1/duty cycle) traces

### 7.9.4. Test Setup

#### 1GHz ~ 18GHz Test Setup:

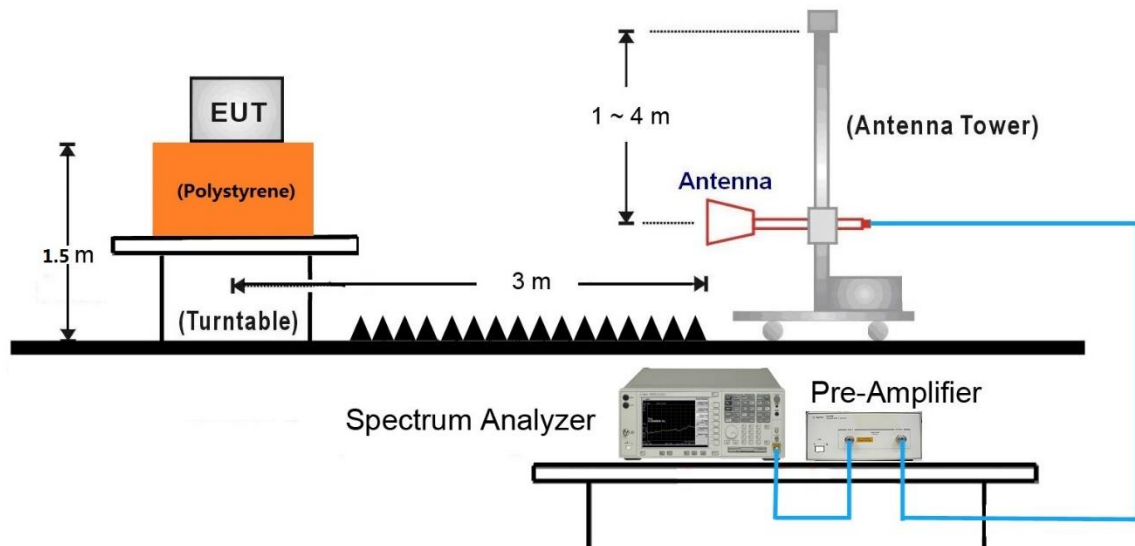

#### 18GHz ~40GHz Test Setup:

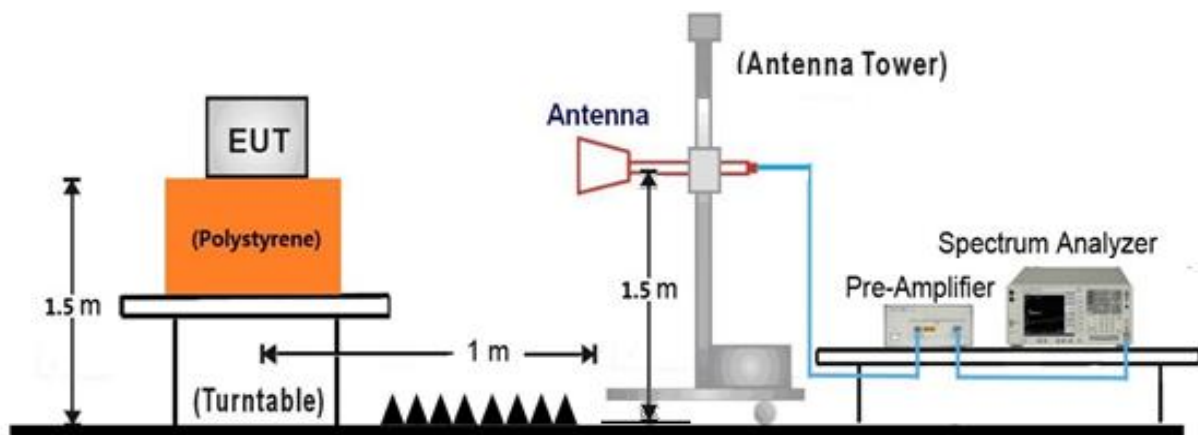

**7.9.5. Test Result**

EUT	Digital Wireless Observation Monitor	Date of Test	2021-08-26
Factor	BBHA 9120D	Temp. / Humidity	24°C /65%
Polarity	Horizontal	Site / Test Engineer	AC1 / Kaunaz
Test Mode	FHSS 2.4G_QPSK_TX_2403MHz	Test Voltage	DC 12V

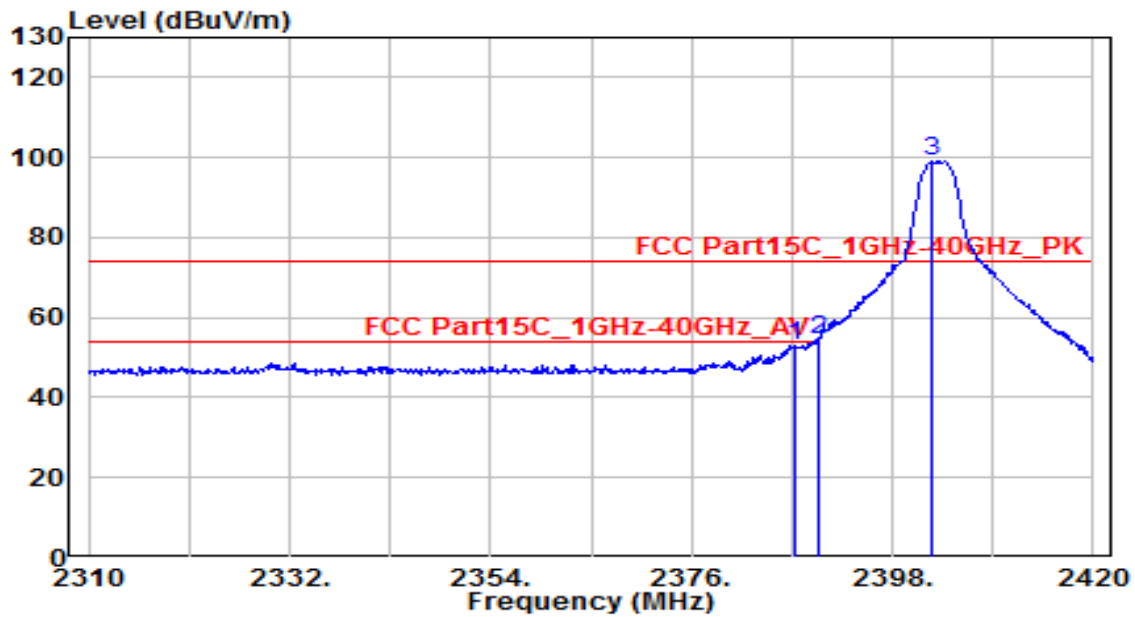

No	Frequency (MHz)	Reading (dBuV)	C.F (dB)	Measurement (dBuV/m)	Margin (dB)	Limit (dBuV/m)	Height (cm)	Angle (deg)	Remark (QP/PK/AV)
1	2387.220	55.09	-2.05	53.04	-20.96	74.00	170	235	Peak
2	* 2390.000	56.32	-2.04	54.28	-19.72	74.00	170	235	Peak
3	2402.290	101.03	-1.99	99.04	N/A	N/A	170	235	Peak

Note:

1. " \*" , means this data is the worst emission level.
2. C.F (Correction Factor) = Antenna Factor (dB)+ Cable Loss (dB) – Preamplifier(dB).
3. Measurement (dBuV/m) = Reading(dBuV) + C.F (Correction Factor).
4. The emission levels of other frequencies are very lower than the limit and not show in test report.

EUT	Digital Wireless Observation Monitor	Date of Test	2021-08-26
Factor	BBHA 9120D	Temp. / Humidity	24°C /65%
Polarity	Horizontal	Site / Test Engineer	AC1 / Kaunaz
Test Mode	FHSS 2.4G_QPSK_TX_2403MHz	Test Voltage	DC 12V

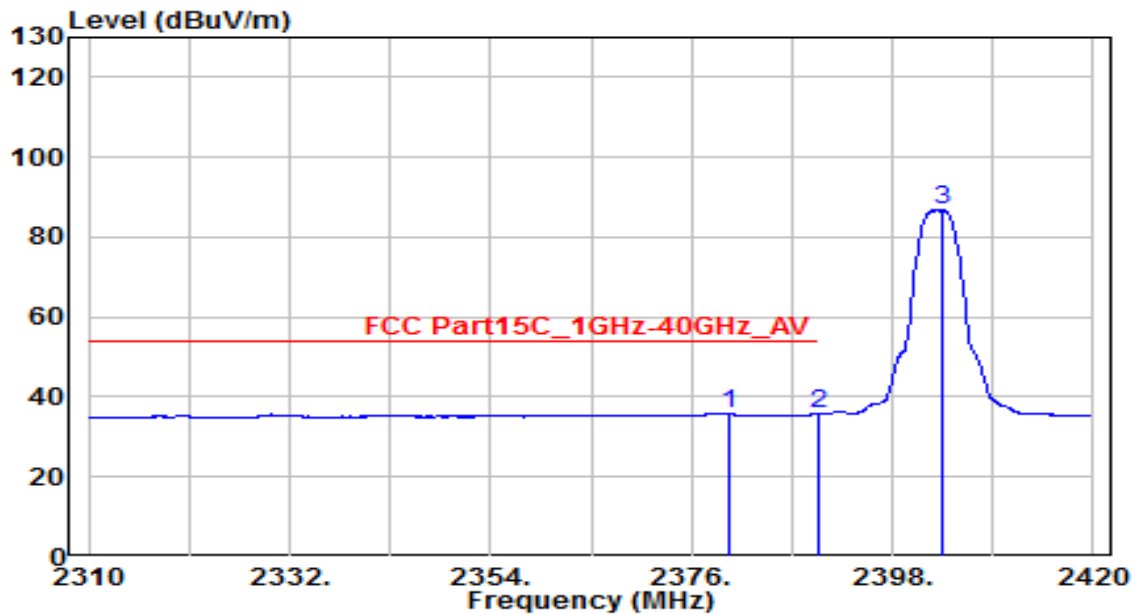

No	Frequency (MHz)	Reading (dBuV)	C.F (dB)	Measurement (dBuV/m)	Margin (dB)	Limit (dBuV/m)	Height (cm)	Angle (deg)	Remark (QP/PK/AV)
1	2380.180	37.89	-2.08	35.81	-18.19	54.00	170	235	Average
2	* 2390.000	38.01	-2.04	35.97	-18.03	54.00	170	235	Average
3	2403.500	88.69	-1.99	86.70	N/A	N/A	170	235	Average

Note:

1. " \*", means this data is the worst emission level.
2. C.F (Correction Factor) = Antenna Factor (dB)+ Cable Loss (dB) – Preamplifier(dB).
3. Measurement (dBuV/m) = Reading(dBuV) + C.F (Correction Factor).
4. The emission levels of other frequencies are very lower than the limit and not show in test report.

EUT	Digital Wireless Observation Monitor	Date of Test	2021-08-26
Factor	BBHA 9120D	Temp. / Humidity	24°C /65%
Polarity	Vertical	Site / Test Engineer	AC1 / Kaunaz
Test Mode	FHSS 2.4G_QPSK_TX_2403MHz	Test Voltage	DC 12V

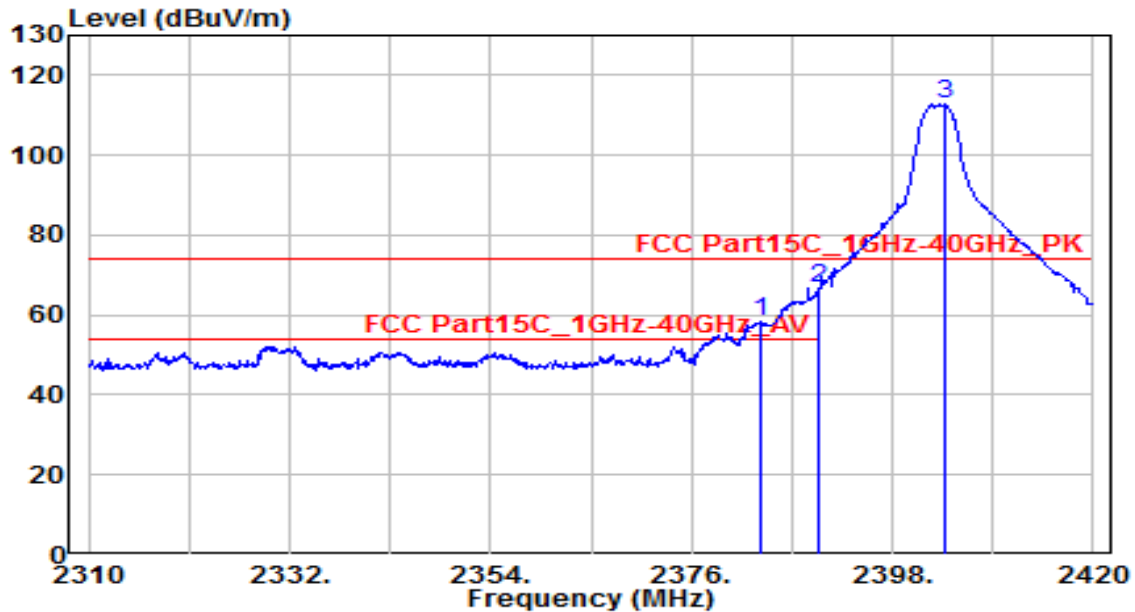

No	Frequency (MHz)	Reading (dBuV)	C.F (dB)	Measurement (dBuV/m)	Margin (dB)	Limit (dBuV/m)	Height (cm)	Angle (deg)	Remark (QP/PK/AV)
1	2383.700	60.38	-2.06	58.32	-15.68	74.00	140	90	Peak
2	* 2390.000	68.78	-2.04	66.74	-7.26	74.00	140	90	Peak
3	2403.720	114.64	-1.99	112.65	N/A	N/A	140	90	Peak

Note:

1. " \*", means this data is the worst emission level.
2. C.F (Correction Factor) = Antenna Factor (dB)+ Cable Loss (dB) – Pre-amplifier(dB).
3. Measurement (dBuV/m) = Reading(dBuV) + C.F (Correction Factor).
4. The emission levels of other frequencies are very lower than the limit and not show in test report.

EUT	Digital Wireless Observation Monitor	Date of Test	2021-08-26
Factor	BBHA 9120D	Temp. / Humidity	24°C /65%
Polarity	Vertical	Site / Test Engineer	AC1 / Kaunaz
Test Mode	FHSS 2.4G_QPSK_TX_2403MHz	Test Voltage	DC 12V

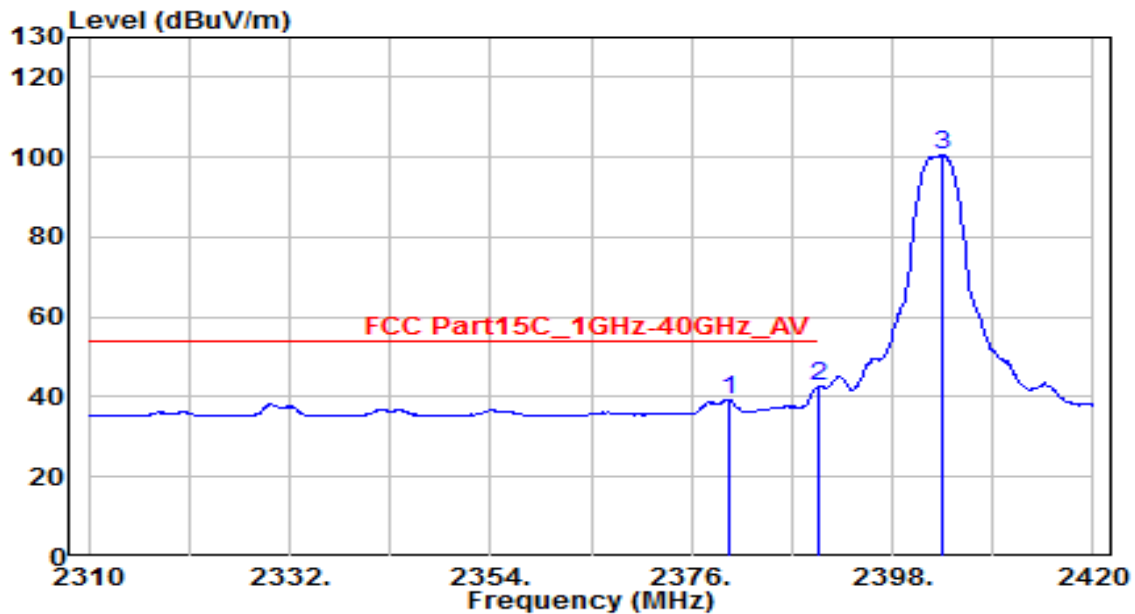

No	Frequency (MHz)	Reading (dBuV)	C.F (dB)	Measurement (dBuV/m)	Margin (dB)	Limit (dBuV/m)	Height (cm)	Angle (deg)	Remark (QP/PK/AV)
1	2380.070	41.40	-2.08	39.32	-14.68	54.00	140	90	Average
2	* 2390.000	44.95	-2.04	42.92	-11.08	54.00	140	90	Average
3	2403.610	102.38	-1.99	100.40	N/A	N/A	140	90	Average

Note:

1. " \*", means this data is the worst emission level.
2. C.F (Correction Factor) = Antenna Factor (dB)+ Cable Loss (dB) – Preamplifier(dB).
3. Measurement (dBuV/m) = Reading(dBuV) + C.F (Correction Factor).
4. The emission levels of other frequencies are very lower than the limit and not show in test report.

EUT	Digital Wireless Observation Monitor	Date of Test	2021-08-26
Factor	BBHA 9120D	Temp. / Humidity	24°C /65%
Polarity	Horizontal	Site / Test Engineer	AC1 / Kaunaz
Test Mode	FHSS 2.4G_QPSK_TX_2472MHz	Test Voltage	DC 12V

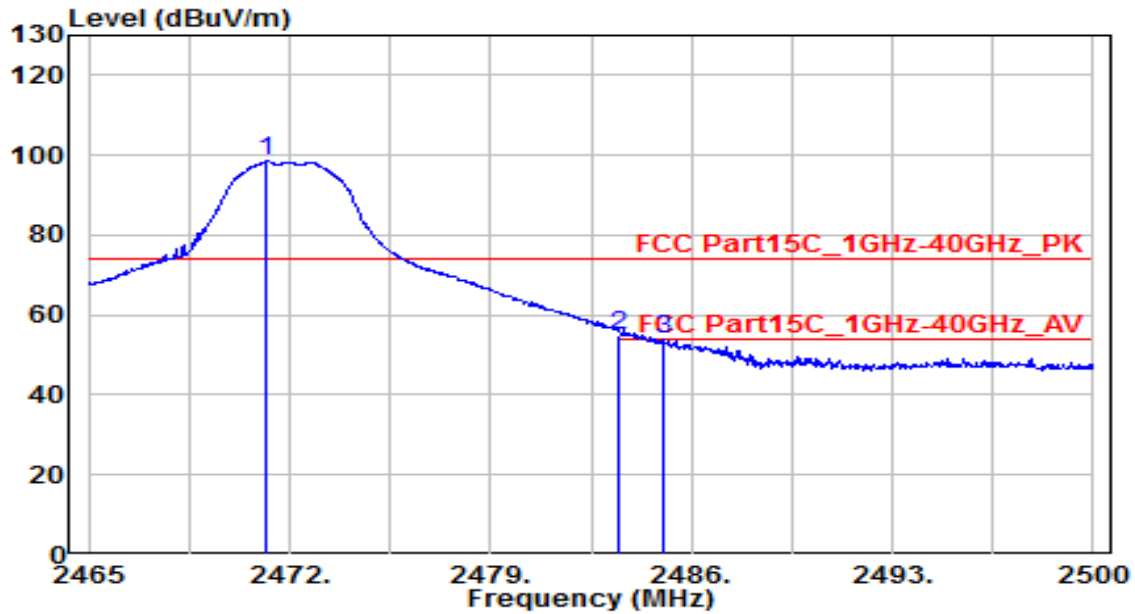

No	Frequency (MHz)	Reading (dBuV)	C.F (dB)	Measurement (dBuV/m)	Margin (dB)	Limit (dBuV/m)	Height (cm)	Angle (deg)	Remark (QP/PK/AV)
1	2471.195	100.17	-1.73	98.44	N/A	N/A	100	35	Peak
2	* 2483.500	56.85	-1.68	55.17	-18.83	74.00	100	35	Peak
3	2484.985	55.84	-1.68	54.16	-19.84	74.00	100	35	Peak

Note:

- "\*" means this data is the worst emission level.
- C.F (Correction Factor) = Antenna Factor (dB)+ Cable Loss (dB) – Pre-amplifier(dB).
- Measurement (dBuV/m) = Reading(dBuV) + C.F (Correction Factor).
- The emission levels of other frequencies are very lower than the limit and not show in test report.

EUT	Digital Wireless Observation Monitor	Date of Test	2021-08-26
Factor	BBHA 9120D	Temp. / Humidity	24°C /65%
Polarity	Horizontal	Site / Test Engineer	AC1 / Kaunaz
Test Mode	FHSS 2.4G_QPSK_TX_2472MHz	Test Voltage	DC 12V

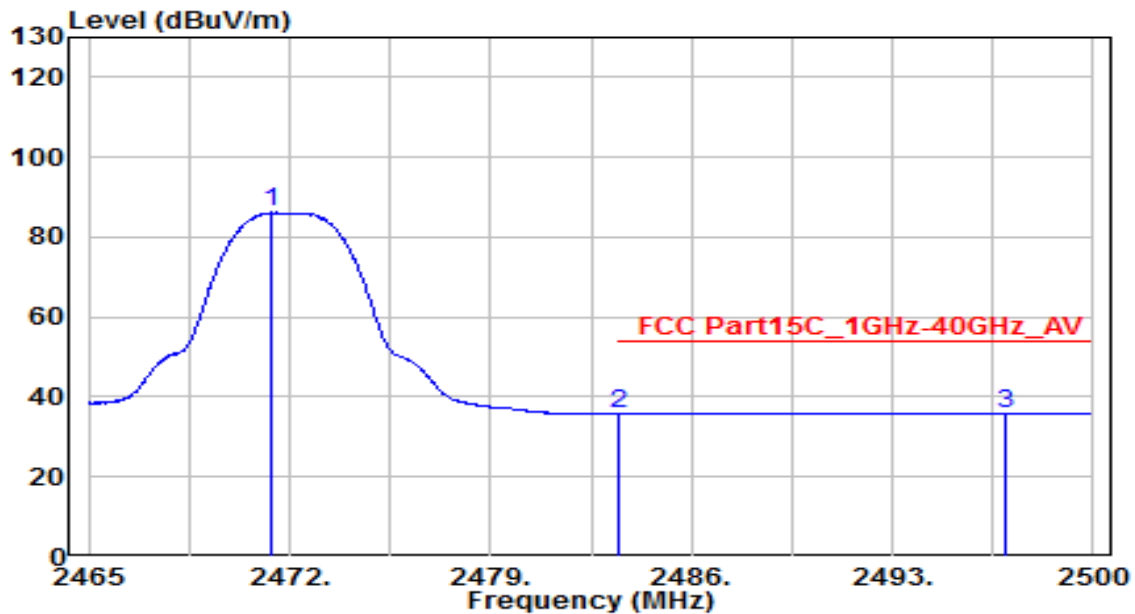

No	Frequency (MHz)	Reading (dBuV)	C.F (dB)	Measurement (dBuV/m)	Margin (dB)	Limit (dBuV/m)	Height (cm)	Angle (deg)	Remark (QP/PK/AV)
1	2471.405	87.86	-1.73	86.13	N/A	N/A	100	35	Average
2	2483.500	37.58	-1.68	35.89	-18.11	54.00	100	35	Average
3	* 2496.955	37.64	-1.63	36.01	-17.99	54.00	100	35	Average

Note:

1. " \*", means this data is the worst emission level.
2. C.F (Correction Factor) = Antenna Factor (dB)+ Cable Loss (dB) – Preamplifier(dB).
3. Measurement (dBuV/m) = Reading(dBuV) + C.F (Correction Factor).
4. The emission levels of other frequencies are very lower than the limit and not show in test report.



EUT	Digital Wireless Observation Monitor	Date of Test	2021-08-26
Factor	BBHA 9120D	Temp. / Humidity	24°C /65%
Polarity	Vertical	Site / Test Engineer	AC1 / Kaunaz
Test Mode	FHSS 2.4G_QPSK_TX_2472MHz	Test Voltage	DC 12V

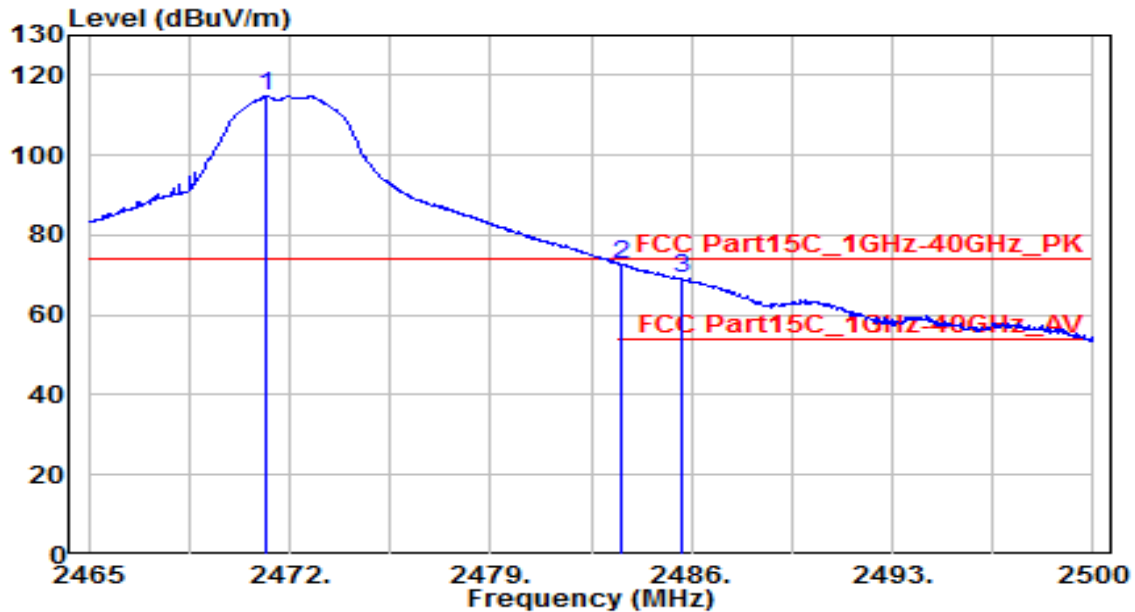

No	Frequency (MHz)	Reading (dBuV)	C.F (dB)	Measurement (dBuV/m)	Margin (dB)	Limit (dBuV/m)	Height (cm)	Angle (deg)	Remark (QP/PK/AV)
1	2471.195	116.38	-1.73	114.66	N/A	N/A	120	95	Peak
2	* 2483.515	74.48	-1.68	72.80	-1.20	74.00	120	90	Peak
3	2485.650	70.85	-1.67	69.17	-4.83	74.00	120	95	Peak

Note:

- "\*" means this data is the worst emission level.
- C.F (Correction Factor) = Antenna Factor (dB)+ Cable Loss (dB) – Pre-amplifier(dB).
- Measurement (dBuV/m) = Reading(dBuV) + C.F (Correction Factor).
- The emission levels of other frequencies are very lower than the limit and not show in test report.

EUT	Digital Wireless Observation Monitor	Date of Test	2021-08-26
Factor	BBHA 9120D	Temp. / Humidity	24°C /65%
Polarity	Vertical	Site / Test Engineer	AC1 / Kaunaz
Test Mode	FHSS 2.4G_QPSK_TX_2472MHz	Test Voltage	DC 12V

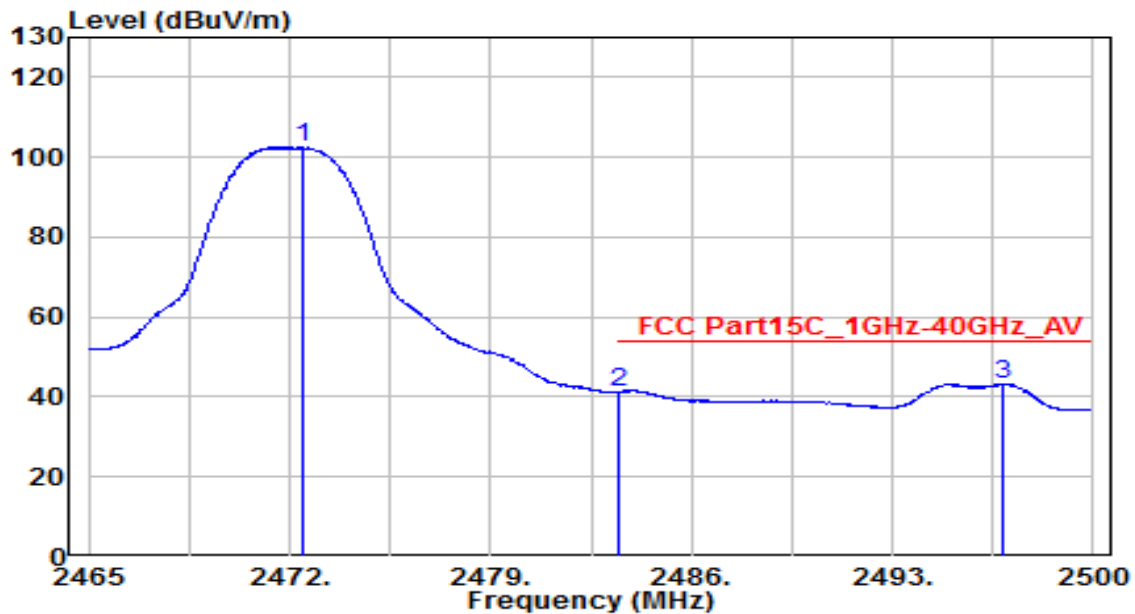

No	Frequency (MHz)	Reading (dBuV)	C.F (dB)	Measurement (dBuV/m)	Margin (dB)	Limit (dBuV/m)	Height (cm)	Angle (deg)	Remark (QP/PK/AV)
1	2472.490	104.15	-1.72	102.43	N/A	N/A	120	95	Average
2	2483.500	42.94	-1.68	41.25	-12.75	54.00	120	95	Average
3	* 2496.885	44.90	-1.63	43.27	-10.73	54.00	120	95	Average

Note:

1. "\*" , means this data is the worst emission level.
2. C.F (Correction Factor) = Antenna Factor (dB)+ Cable Loss (dB) – Pre-amplifier(dB).
3. Measurement (dBuV/m) = Reading(dBuV) + C.F (Correction Factor).
4. The emission levels of other frequencies are very lower than the limit and not show in test report.

## 7.10. AC Conducted Emissions Measurement

### 7.10.1. Test Limit

FCC Part 15 Subpart C Paragraph 15.207 / RSS-Gen Limits		
Frequency (MHz)	QP (dB $\mu$ V)	Average (dB $\mu$ V)
0.15 - 0.50	66 - 56	56 - 46
0.50 - 5.0	56	46
5.0 - 30	60	50

Note 1: The lower limit shall apply at the transition frequencies.

Note 2: The limit decreases linearly with the logarithm of the frequency in the range 0.15MHz to 0.5MHz.

### 7.10.2. Test Setup

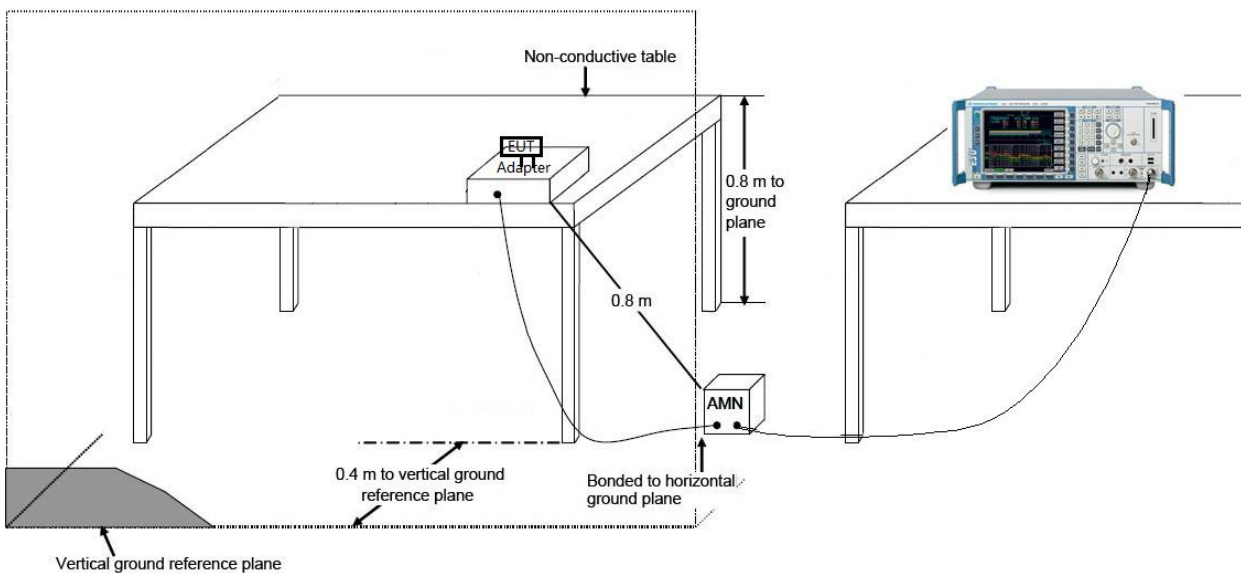

### 7.10.3. Test Result

Note: The EUT Power Input DC 12V, so do not need to test Conducted Emissions.

## 8. CONCLUSION

The data collected relate only the item(s) tested and show that the **Digital Wireless Observation Monitor** is in compliance with Part 15C of the FCC Rules.

————— The End —————