



TESTING LABORATORY
CERTIFICATE #4820.01



FCC PART 15.247

TEST REPORT

For

ASA Electronics Shenzhen Limited

Room 503, 5/F., Unit A, Skyworth Building, Gaoxin Avenue.1.S.,Nanshan District,Shen Zhen, Nanshan District, 518057, China

FCC ID: 2AHU2UM2

Report Type: Original Report	Product Name: Marine Audio System
Report Number: RDG181109010-00B	
Report Date: 2019-01-10	
Reviewed By: Allen Qiao RF Supervisor	<i>Allen Qiao</i>
Test Laboratory:	Bay Area Compliance Laboratories Corp. (Dongguan) No.69 Pulongcun, Puxinhu Industry Area, Tangxia, Dongguan, Guangdong, China Tel: +86-769-86858888 Fax: +86-769-86858891 www.baclcorp.com.cn

Note: This test report is prepared for the customer shown above and for the device described herein. It may not be duplicated or used in part without prior written consent from Bay Area Compliance Laboratories Corp. (Dongguan). This report must not be used by the customer to claim product certification, approval, or endorsement by A2LA* or any agency of the Federal Government. * This report may contain data that are not covered by the A2LA accreditation and are marked with an asterisk “*”.

TABLE OF CONTENTS

GENERAL INFORMATION.....	4
PRODUCT DESCRIPTION FOR EQUIPMENT UNDER TEST (EUT).....	4
OBJECTIVE	4
RELATED SUBMITTAL(S)/GRANT(S).....	4
TEST METHODOLOGY	4
MEASUREMENT UNCERTAINTY	4
TEST FACILITY	5
SYSTEM TEST CONFIGURATION.....	6
DESCRIPTION OF TEST CONFIGURATION	6
EUT EXERCISE SOFTWARE	6
EQUIPMENT MODIFICATIONS	6
SUPPORT EQUIPMENT LIST AND DETAILS	7
SUPPORT CABLE LIST AND DETAILS	7
BLOCK DIAGRAM OF TEST SETUP	8
SUMMARY OF TEST RESULTS	9
FCC §15.247 (i) & §1.1310 & §2.1091- MAXIMUM PERMISSIBLE EXPOSURE (MPE).....	10
APPLICABLE STANDARD	10
FCC §15.203 - ANTENNA REQUIREMENT.....	11
APPLICABLE STANDARD	11
ANTENNA CONNECTOR CONSTRUCTION	11
FCC §15.209, §15.205 & §15.247(d) - SPURIOUS EMISSIONS.....	12
APPLICABLE STANDARD	12
EUT SETUP	12
EMI TEST RECEIVER & SPECTRUM ANALYZER SETUP	13
TEST PROCEDURE	13
TEST EQUIPMENT LIST AND DETAILS.....	13
CORRECTED AMPLITUDE & MARGIN CALCULATION	14
TEST DATA	14
FCC §15.247(a) (1) - CHANNEL SEPARATION TEST	20
APPLICABLE STANDARD	20
TEST EQUIPMENT LIST AND DETAILS.....	20
TEST PROCEDURE	20
TEST DATA	20
FCC §15.247(a) (1) – 20 dB BANDWIDTH TESTING	26
APPLICABLE STANDARD	26
TEST PROCEDURE	26
TEST EQUIPMENT LIST AND DETAILS.....	26
TEST DATA	26
FCC §15.247(a) (1) (iii) - QUANTITY OF HOPPING CHANNEL TEST	32
APPLICABLE STANDARD	32
TEST PROCEDURE	32
TEST EQUIPMENT LIST AND DETAILS.....	32
TEST DATA	32
FCC §15.247(a) (1) (iii) - TIME OF OCCUPANCY (DWELL TIME).....	36

APPLICABLE STANDARD36
TEST PROCEDURE36
TEST EQUIPMENT LIST AND DETAILS.....36
TEST DATA36

FCC §15.247(b) (1) - PEAK OUTPUT POWER MEASUREMENT43

APPLICABLE STANDARD43
TEST PROCEDURE43
TEST EQUIPMENT LIST AND DETAILS.....43
TEST DATA43

FCC §15.247(d) - BAND EDGES TESTING45

APPLICABLE STANDARD45
TEST PROCEDURE45
TEST EQUIPMENT LIST AND DETAILS.....45
TEST DATA46

GENERAL INFORMATION

Product Description for Equipment under Test (EUT)

EUT Name:	Marine Audio System
EUT Model:	UM2
Rated Input Voltage:	12Vdc from system
External Dimension:	132mm(L)*65mm(W)*87mm(H)
Serial Number:	181109010
EUT Received Date:	2018.11.10

Objective

This report is prepared on behalf of *ASA Electronics Shenzhen Limited* in accordance with Part 2-Subpart J, Part 15-Subparts A and C of the Federal Communications Commission's rules

The tests were performed in order to determine the Bluetooth BDR and EDR mode of EUT compliance with FCC Rules Part 15, Subpart C, and section 15.203, 15.205, 15.209 and 15.247 rules.

Related Submittal(s)/Grant(s)

N/A

Test Methodology

All measurements detailed in this test report were performed in accordance with ANSI C63.10-2013 "American National Standard of Procedures for Compliance Testing of Unlicensed Wireless Devices" and 558074 D01 15.247 Meas Guidance v05.

All emissions measurement was performed and Bay Area Compliance Laboratories Corp. (Dongguan).

Measurement Uncertainty

Parameter	Measurement Uncertainty
Occupied Channel Bandwidth	±5 %
RF output power, conducted	±0.61dB
Unwanted Emissions, radiated	30M~200MHz: 4.58 dB for Horizontal, 4.59 dB for Vertical 200M~1GHz: 4.83 dB for Horizontal, 5.85 dB for Vertical 1G~6GHz: 4.45 dB, 6G~26.5GHz: 5.23 dB
Unwanted Emissions, conducted	±1.5 dB
Temperature	±1 °C
Humidity	±5%
DC and low frequency voltages	±0.4%
Duty Cycle	1%
AC Power Lines Conducted Emission	3.12 dB (150 kHz to 30 MHz)

Test Facility

The Test site used by Bay Area Compliance Laboratories Corp. (Dongguan) to collect test data is located on the No.69 Pulongcun, Puxinhu Industry Area, Tangxia, Dongguan, Guangdong, China.

The lab has been recognized as the FCC accredited lab under the KDB 974614 D01 and is listed in the FCC Public Access Link (PAL) database, FCC Registration No. : 897218, the FCC Designation No. : CN1220.

The lab has been recognized by Innovation, Science and Economic Development Canada to test to Canadian radio equipment requirements, the CAB identifier: CN0022.

SYSTEM TEST CONFIGURATION

Description of Test Configuration

The system was configured for testing in engineering mode. For 2.4GHz BT, 79 channels are provided to testing.

Channel	Frequency (MHz)	Channel	Frequency (MHz)
0	2402	40	2442
1	2403	41	2443
2	2404
...	...	77	2479
38	2440	78	2480
39	2441	/	/

EUT was tested with channel 0, 39 and 78.

EUT Exercise Software

The software 'BK80xx RF Test_V1.5.exe' was used during test, which was provided by manufacturer. The maximum power level was configured by the software as below table:

Mode	Channel	Frequency (MHz)	Power Level
GFSK	Low	2402	33
	Middle	2441	33
	High	2480	33
$\pi/4$ DQPSK	Low	2402	33
	Middle	2441	33
	High	2480	33
8DPSK	Low	2402	33
	Middle	2441	33
	High	2480	33

Equipment Modifications

No modification was made to the EUT.

Support Equipment List and Details

Manufacturer	Description	Model	Serial Number
Panasonic	Battery	12V	/
ASA	Marine Audio System	UM2DSP	/
ASA	UM2 Commander	UM2 Commander	/
Audioengine	Speaker 1	A2	/
Unknown	Speaker 2	/	/
KingSton	USB Flash	/	/
Unknown	FM Antenna	/	/
Unknown	Load	/	/

Support Cable List and Details

Cable Description	Shielding Type	Ferrite Core	Length (m)	From Port	To
Power Cable	Yes	Yes	1.2	Battery	EUT / UM2DSP
Audio Cable	Yes	No	2.0	EUT	Speaker 1
Audio Cable	Yes	No	0.3	EUT	Load
Audio Cable	Yes	No	5.0	EUT	Load
Audio Cable	Yes	No	0.3	Marine Audio System	Speaker 2
AUX Cable	Yes	No	2.0	Commander	EUT
FM Antenna Cable	Yes	No	0.5	EUT	FM Antenna

Block Diagram of Test Setup

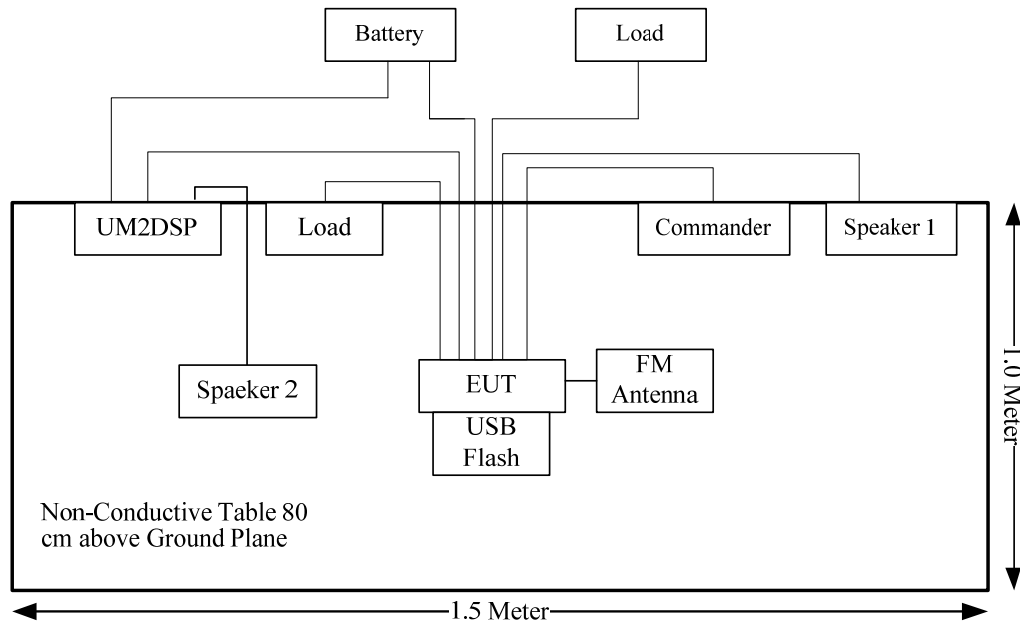

SUMMARY OF TEST RESULTS

FCC Rules	Description of Test	Result
FCC §15.247 (i) & §1.1310 & §2.1091	Maximum Permissible Exposure (MPE)	Compliance
§15.203	Antenna Requirement	Compliance
§15.207 (a)	Conducted Emissions	Not Applicable
§15.205, §15.209, §15.247(d)	Spurious Emissions	Compliance
§15.247 (a)(1)	20 dB Bandwidth	Compliance
§15.247(a)(1)	Channel Separation Test	Compliance
§15.247(a)(1)(iii)	Time of Occupancy (Dwell Time)	Compliance
§15.247(a)(1)(iii)	Quantity of hopping channel Test	Compliance
§15.247(b)(1)	Peak Output Power Measurement	Compliance
§15.247(d)	Band Edges	Compliance

Note:

Not Applicable: The device was powered by DC which was used in marine system.

FCC §15.247 (i) & §1.1310 & §2.1091- MAXIMUM PERMISSIBLE EXPOSURE (MPE)

Applicable Standard

According to subpart 15.247(i) and subpart §1.1310, systems operating under the provisions of this section shall be operated in a manner that ensures that the public is not exposed to radio frequency energy level in excess of the Commission’s guidelines.

Limits for Maximum Permissible Exposure (MPE) (§1.1310, §2.1091)

(B) Limits for General Population/Uncontrolled Exposure				
Frequency Range (MHz)	Electric Field Strength (V/m)	Magnetic Field Strength (A/m)	Power Density (mW/cm²)	Averaging Time (minutes)
0.3–1.34	614	1.63	*(100)	30
1.34–30	824/f	2.19/f	*(180/f ²)	30
30–300	27.5	0.073	0.2	30
300–1500	/	/	f/1500	30
1500–100,000	/	/	1.0	30

f = frequency in MHz; * = Plane-wave equivalent power density;

According to §1.1310 and §2.1091 RF exposure is calculated.

Calculated Formulary:

Prediction of power density at the distance of the applicable MPE limit:

$S = PG/4\pi R^2$ = power density (in appropriate units, e.g. mW/cm²);

P = power input to the antenna (in appropriate units, e.g., mW);

G = power gain of the antenna in the direction of interest relative to an isotropic radiator, the power gain factor, is normally numeric gain;

R = distance to the center of radiation of the antenna (appropriate units, e.g., cm);

Calculated Data:

Frequency Range (MHz)	Antenna Gain		Maximum Power Including Tolerance		Evaluation Distance (cm)	Power Density (mW/cm²)	MPE Limit (mW/cm²)
	(dBi)	(numeric)	(dBm)	(mW)			
2402-2480	3	2	7	5.01	20.00	0.002	1.0

Note: The Maximum Power Including Tolerance was declared by manufacturer.

Result: Compliance,The device meets MPE requirement for Devices Used by the General Public (Uncontrolled Environment) at distance ≥20 cm.

FCC §15.203 - ANTENNA REQUIREMENT

Applicable Standard

According to FCC § 15.203, an intentional radiator shall be designed to ensure that no antenna other than that furnished by the responsible party shall be used with the device. The use of a permanently attached antenna or of an antenna that uses a unique coupling to the intentional radiator shall be considered sufficient to comply with the provisions of this Section. The manufacturer may design the unit so that a broken antenna can be replaced by the user, but the use of a standard antenna jack or electrical connector is prohibited.

Antenna Connector Construction

The EUT has one internal antenna arrangement for BT, and the antenna gain is 3 dBi, fulfill the requirement of this section. Please refer to the EUT photos.

Result: Compliance.

FCC §15.209, §15.205 & §15.247(d) - SPURIOUS EMISSIONS

Applicable Standard

FCC §15.247 (d); §15.209; §15.205;

EUT Setup

Below 1GHz:

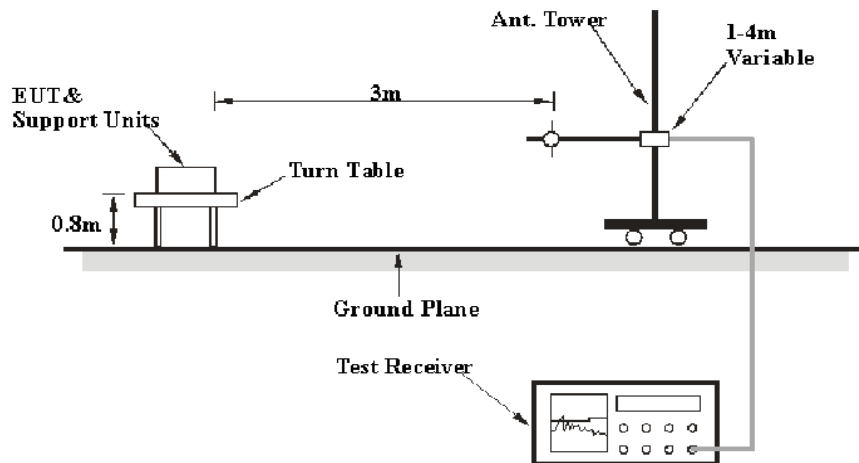

Above 1GHz:

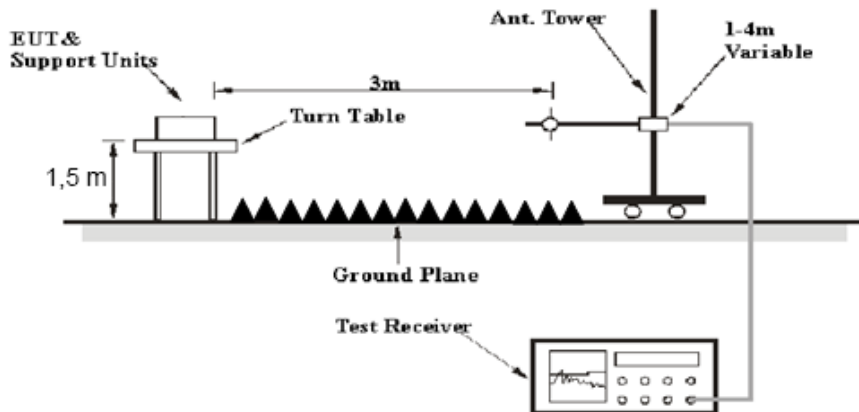

The radiated emission Below 1GHz tests were performed in the 10 meters chamber test site, above 1GHz tests were performed in the 3 meters chamber test site, using the setup accordance with the ANSI C63.10-2013. The specification used was the FCC 15.209, and FCC 15.247 limits.

The external I/O cables were draped along the test table and formed a bundle 30 to 40 cm long in the middle.

The spacing between the peripherals was 10 cm.

EMI Test Receiver & Spectrum Analyzer Setup

The system was investigated from 30 MHz to 25 GHz.

According to FCC public notice: DA-00-705, during the radiated emission test, the EMI test receiver & Spectrum Analyzer Setup were set with the following configurations:

Frequency Range	RBW	Video B/W	IF B/W	Measurement
30 MHz – 1000 MHz	120 kHz	300 kHz	120 kHz	QP
Above 1 GHz	1MHz	3 MHz	/	PK
	1MHz	10 Hz	/	AV

Test Procedure

Maximizing procedure was performed on the highest emissions to ensure that the EUT complied with all installation combinations.

Data was recorded in Quasi-peak detection mode for frequency range of 30 MHz - 1 GHz, peak and average detection modes for frequencies above 1 GHz.

Test Equipment List and Details

Manufacturer	Description	Model	Serial Number	Calibration Date	Calibration Due Date
R&S	EMI Test Receiver	ESCI	100035	2018-08-03	2019-08-03
Farad	Test Software	EZ-EMC	V1.1.4.2	N/A	N/A
Sunol Sciences	Antenna	JB3	A060611-3	2017-07-21	2019-07-21
Unknown	Coaxial Cable	C-NJNJ-50	C-1000-01	2018-09-05	2019-09-05
Unknown	Coaxial Cable	C-NJNJ-50	C-0400-02	2018-09-05	2019-09-05
Unknown	Coaxial Cable	C-NJNJ-50	C-0530-01	2018-09-24	2019-09-24
Sonoma	Amplifier	310N	185914	2018-10-13	2019-10-13
R&S	Spectrum Analyzer	E4440A	SG43360054	2018-01-04	2019-01-04
ETS-Lindgren	Horn Antenna	3115	000 527 35	2016-01-05	2019-01-04
MITEQ	Amplifier	AFS42-00101800-25-S-42	2001271	2018-09-05	2019-09-05
Ducommun Technologies	Horn Antenna	ARH-4223-02	1007726-02 1304	2017-06-16	2020-06-15
Quinstar	Amplifier	QLW-18405536-JO	15964001001	2018-06-27	2019-06-27
Unknown	Coaxial Cable	C-SJSJ-50	C-0800-01	2018-09-05	2019-09-05
E-Microwave	Band-stop Filters	OBSF-2400-2483.5-S	OE01601525	2018-06-16	2019-06-16
Micro-tronics	High Pass Filter	HPM50111	S/N-G217	2018-06-16	2019-06-16

* **Statement of Traceability:** Bay Area Compliance Laboratories Corp. (Dongguan) attests that all calibrations have been performed, traceable to National Primary Standards and International System of Units (SI).

Corrected Amplitude & Margin Calculation

The Corrected Amplitude is calculated by adding the Antenna Factor and Cable Loss, and subtracting the Amplifier Gain from the Meter Reading. The basic equation is as follows:

$$\text{Corrected Amplitude} = \text{Meter Reading} + \text{Antenna Factor} + \text{Cable Loss} - \text{Amplifier Gain}$$

The “**Margin**” column of the following data tables indicates the degree of compliance with the applicable limit. For example, a margin of 7dB means the emission is 7dB below the limit. The equation for margin calculation is as follows:

$$\text{Margin} = \text{Limit} - \text{Corrected Amplitude}$$

Test Data

Environmental Conditions

Temperature:	25.9 °C
Relative Humidity:	51%
ATM Pressure:	100.7kPa

* The testing was performed by Vito Chen&Tyler Pan on 2018-11-20.

Test Mode: Transmitting

1) 30MHz-1GHz (8DPSK High channel was the worst)

Horizontal:

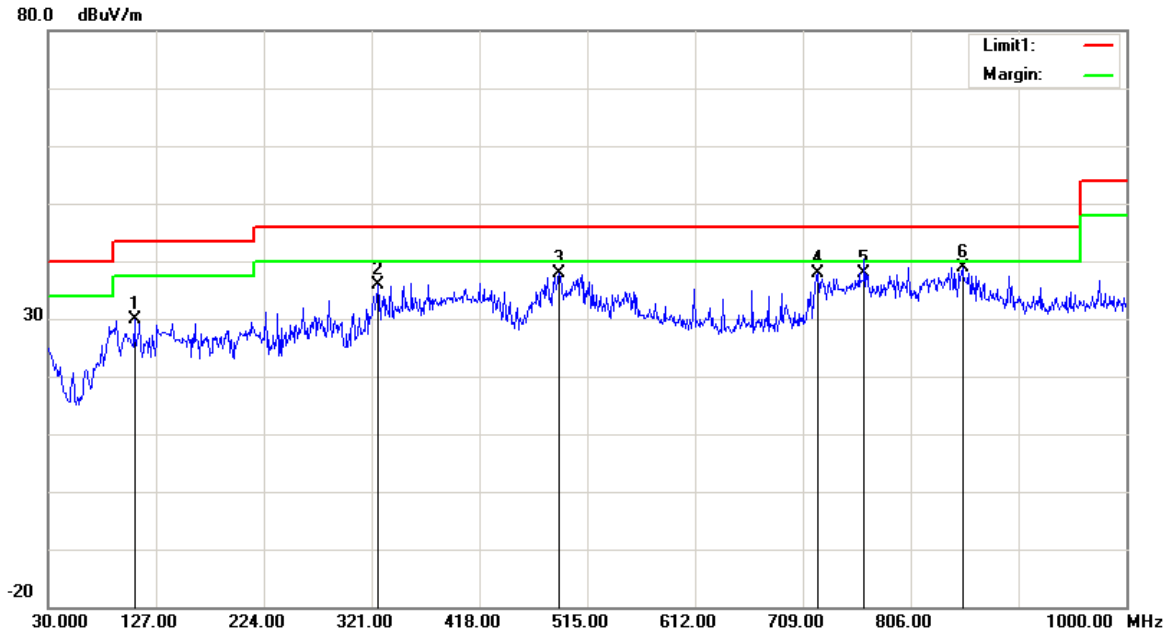

Frequency (MHz)	Receiver Reading (dBμV)	Detector	Correction Factor (dB/m)	Cord. Amp. (dBμV/m)	Limit (dBμV/m)	Margin (dB)
107.6000	43.47	peak	-13.65	29.82	43.50	13.68
326.8200	43.06	peak	-7.10	35.96	46.00	10.04
489.7800	41.39	peak	-3.53	37.86	46.00	8.14
722.5800	37.20	peak	0.66	37.86	46.00	8.14
764.2900	36.99	QP	0.91	37.90	46.00	8.10
852.5600	37.00	peak	1.98	38.98	46.00	7.02

Note: Peak value meets QP limit, so QP value doesn't need to be recorded.

Vertical:

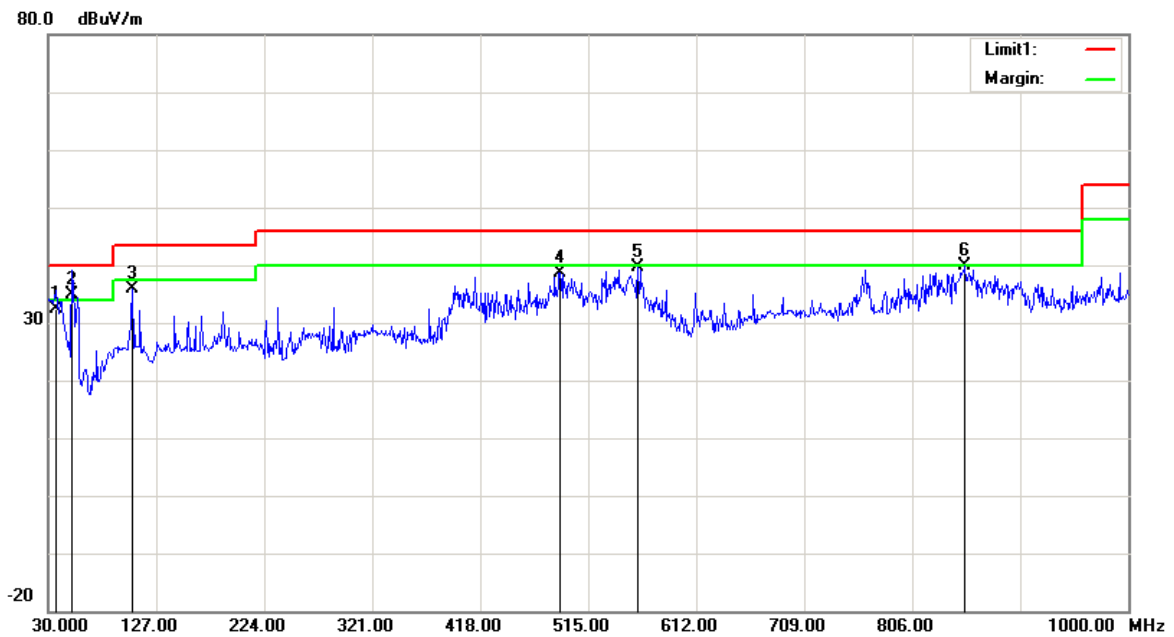

Frequency (MHz)	Receiver Reading (dBµV)	Detector	Correction Factor (dB/m)	Cord. Amp. (dBµV/m)	Limit (dBµV/m)	Margin (dB)
36.7900	40.14	QP	-7.84	32.30	40.00	7.70
51.3400	50.74	QP	-15.74	35.00	40.00	5.00
105.6600	49.73	peak	-13.92	35.81	43.50	7.69
489.7800	42.20	peak	-3.53	38.67	46.00	7.33
559.6200	41.14	peak	-1.52	39.62	46.00	6.38
853.5300	38.01	peak	1.98	39.99	46.00	6.01

Note: Peak value meets QP limit, so QP value doesn't need to be recorded.

2)1GHz-25GHz:

EDR Mode (8DPSK) was worst:

Frequency (MHz)	Receiver		Rx Antenna		Cable loss (dB)	Amplifier Gain (dB)	Corrected Amplitude (dBµV/m)	Limit (dBµV/m)	Margin (dB)
	Reading (dBµV)	Detector	Polar (H/V)	Factor (dB/m)					
Low Channel: 2402 MHz									
2402.00	65.04	PK	H	28.10	1.80	0.00	94.94	N/A	N/A
2402.00	53.17	AV	H	28.10	1.80	0.00	83.07	N/A	N/A
2402.00	61.87	PK	V	28.10	1.80	0.00	91.77	N/A	N/A
2402.00	50.04	AV	V	28.10	1.80	0.00	79.94	N/A	N/A
2390.00	25.86	PK	H	28.08	1.80	0.00	55.74	74.00	18.26
2390.00	13.27	AV	H	28.08	1.80	0.00	43.15	54.00	10.85
4804.00	47.66	PK	H	32.91	3.17	37.20	46.54	74.00	27.46
4804.00	35.43	AV	H	32.91	3.17	37.20	34.31	54.00	19.69
7206.00	46.44	PK	H	35.74	4.82	37.23	49.77	74.00	24.23
7206.00	33.87	AV	H	35.74	4.82	37.23	37.20	54.00	16.80
Middle Channel: 2441 MHz									
2441.00	64.88	PK	H	28.18	1.82	0.00	94.88	N/A	N/A
2441.00	52.74	AV	H	28.18	1.82	0.00	82.74	N/A	N/A
2441.00	61.74	PK	V	28.18	1.82	0.00	91.74	N/A	N/A
2441.00	50.08	AV	V	28.18	1.82	0.00	80.08	N/A	N/A
4882.00	47.32	PK	H	33.06	3.27	37.21	46.44	74.00	27.56
4882.00	35.18	AV	H	33.06	3.27	37.21	34.30	54.00	19.70
7323.00	46.21	PK	H	36.04	4.62	37.38	49.49	74.00	24.51
7323.00	33.54	AV	H	36.04	4.62	37.38	36.82	54.00	17.18
High Channel: 2480 MHz									
2480.00	66.27	PK	H	28.26	1.84	0.00	96.37	N/A	N/A
2480.00	53.89	AV	H	28.26	1.84	0.00	83.99	N/A	N/A
2480.00	64.31	PK	V	28.26	1.84	0.00	94.41	N/A	N/A
2480.00	52.13	AV	V	28.26	1.84	0.00	82.23	N/A	N/A
2483.50	26.24	PK	H	28.27	1.84	0.00	56.35	74.00	17.65
2483.50	13.31	AV	H	28.27	1.84	0.00	43.42	54.00	10.58
4960.00	48.51	PK	H	33.22	3.23	37.25	47.71	74.00	26.29
4960.00	36.07	AV	H	33.22	3.23	37.25	35.27	54.00	18.73
7440.00	46.28	PK	H	36.34	4.41	37.52	49.51	74.00	24.49
7440.00	33.83	AV	H	36.34	4.41	37.52	37.06	54.00	16.94

Worst plots (8DPSK high channel)
Horizontal

Fundamental with band reject filter

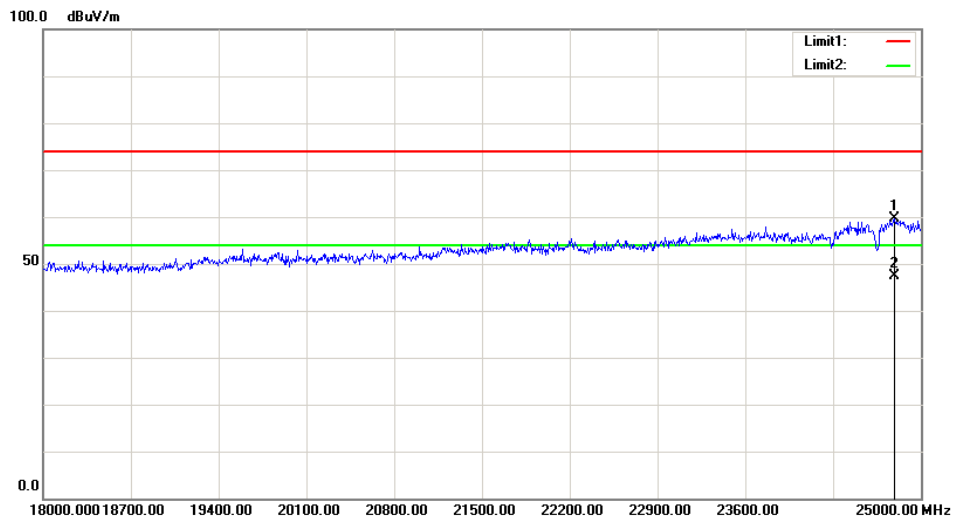
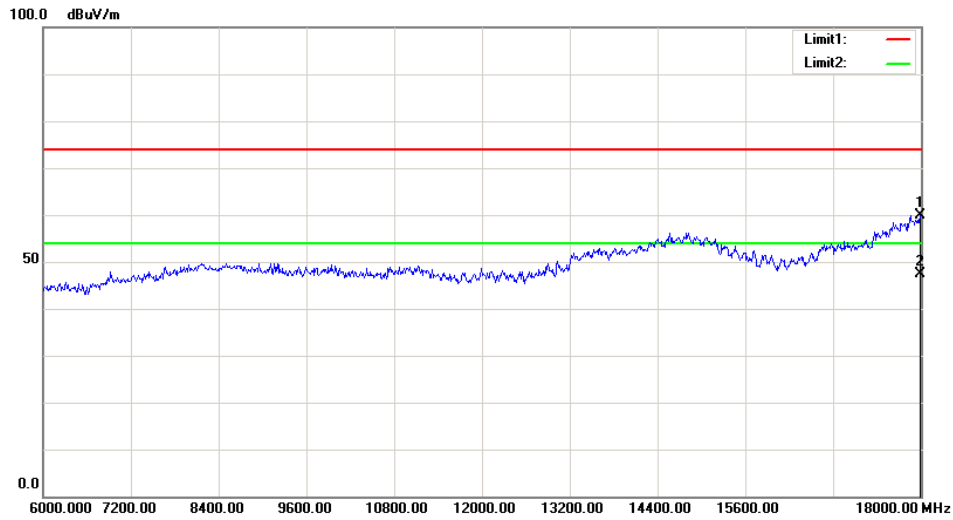
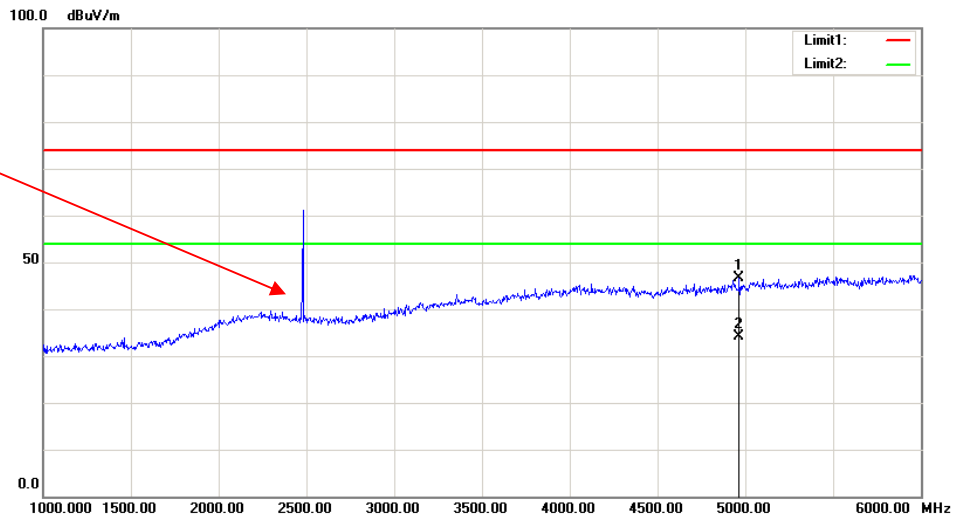

Vertical

Fundamental with band reject filter

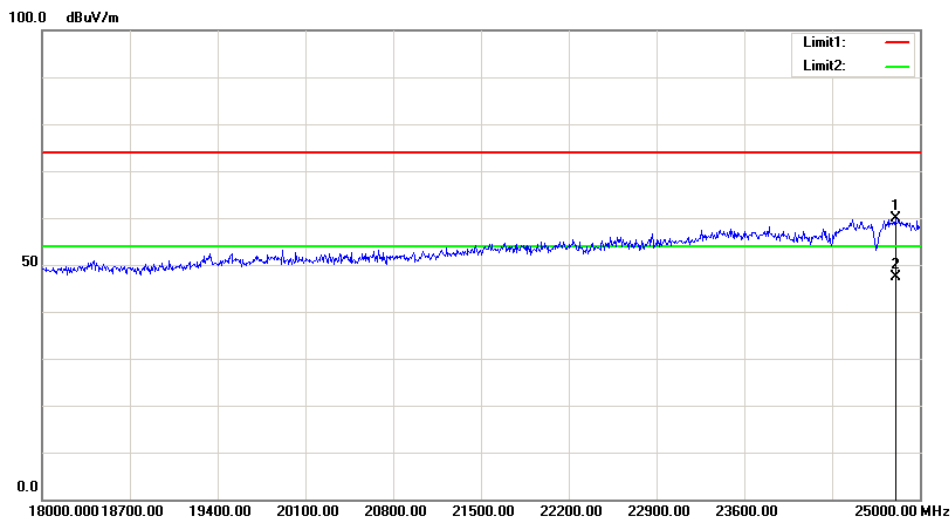
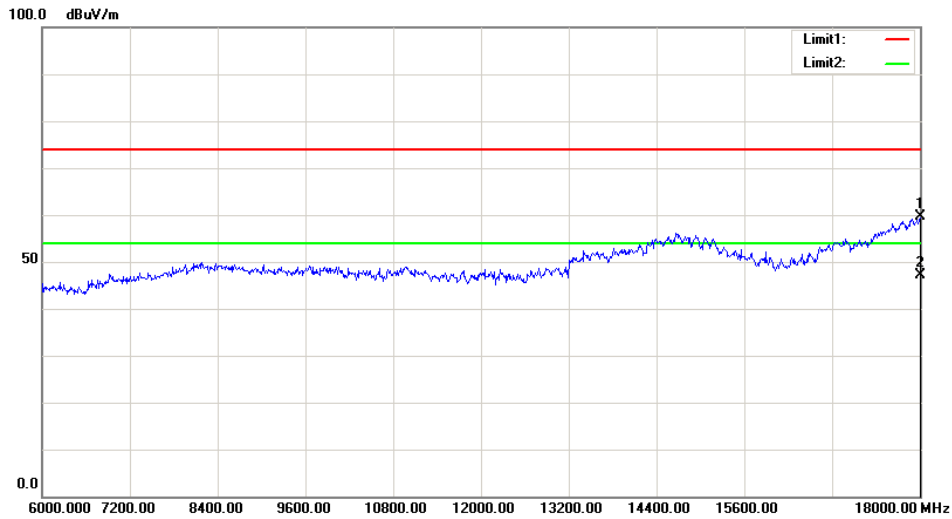
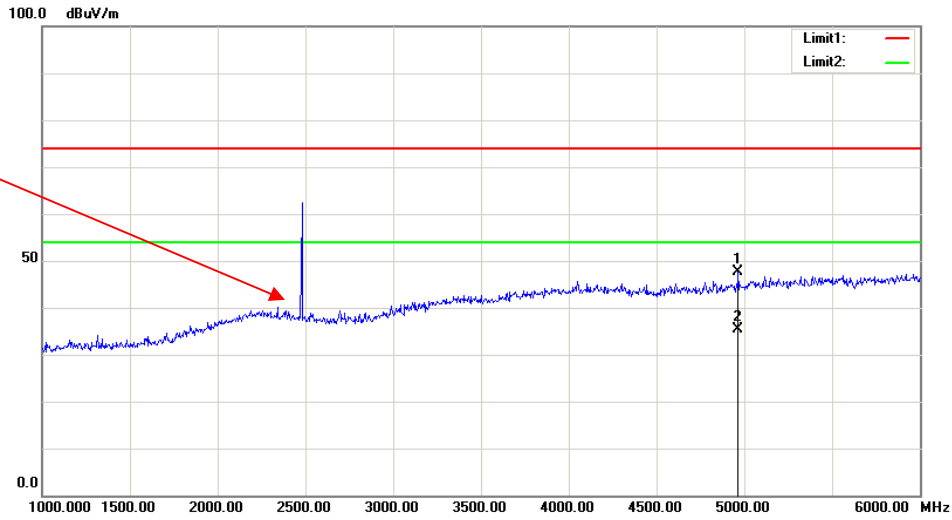

FCC §15.247(a) (1) - CHANNEL SEPARATION TEST

Applicable Standard

Frequency hopping systems shall have hopping channel carrier frequencies separated by a minimum of 25 kHz or the 20dB bandwidth of the hopping channel, whichever is greater. Alternatively, frequency hopping systems operating in the 2400-2483.50 MHz band may have hopping channel carrier frequencies that are separated by 25 kHz or two-thirds of the 20dB bandwidth of the hopping channel, whichever is greater provided the systems operate with an output power no greater than 125 mW.

Test Equipment List and Details

Manufacturer	Description	Model	Serial Number	Calibration Date	Calibration Due Date
R&S	EMI Test Receiver	ESPI	100120	2017-12-11	2018-12-11
Unknown	Coaxial Cable	C-SJ00-0010	C0010/01	Each Time	/

* **Statement of Traceability:** Bay Area Compliance Laboratories Corp. (Dongguan) attests that all calibrations have been performed, traceable to National Primary Standards and International System of Units (SI).

Test Procedure

1. Set the EUT in transmitting mode, spectrum Bandwidth was set at 30 kHz, maxhold the channel.
2. Set the adjacent channel of the EUT maxhold another trace.
3. Measure the channel separation.

Test Data

Environmental Conditions

Temperature:	25.9 °C
Relative Humidity:	51%
ATM Pressure:	100.7kPa

* The testing was performed by Vito Chen&Tyler Pan on 2018-11-20.

Test Result: Compliance.

Please refer to following tables and plots

Test Mode: Transmitting

Mode	Channel	Frequency (MHz)	Channel Separation (MHz)	Limit (MHz)
BDR (GFSK)	Low	2402	1.000	0.59
	Middle	2441	1.004	0.59
	High	2480	1.004	0.59
EDR ($\pi/4$ -DQPSK)	Low	2402	1.004	0.87
	Middle	2441	1.000	0.87
	High	2480	1.000	0.87
EDR (8DPSK)	Low	2402	1.004	0.85
	Middle	2441	1.004	0.85
	High	2480	1.000	0.85

Note: Limit = $(2/3) \times 20\text{dB bandwidth}$

BDR Mode (GFSK):

Low Channel

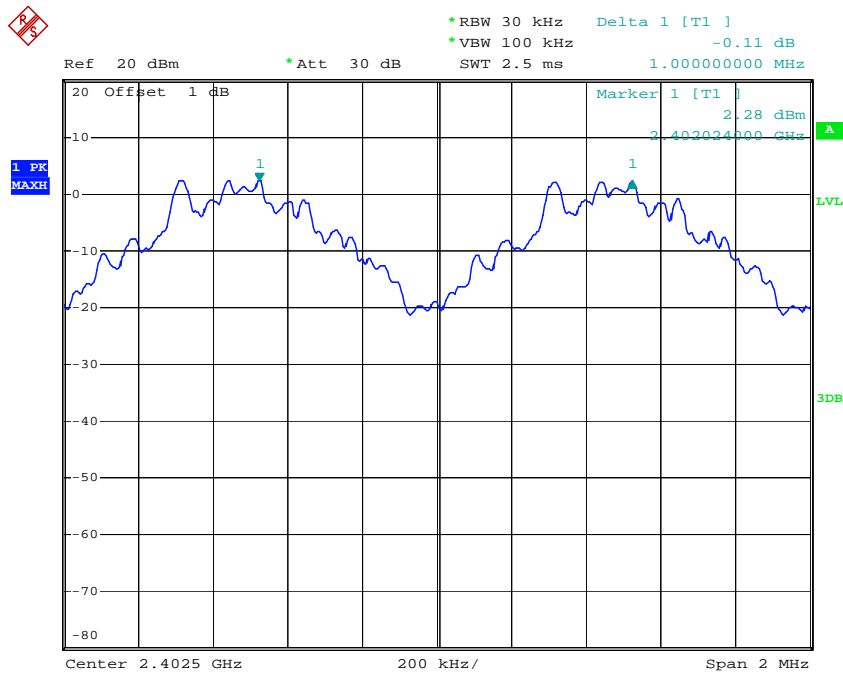

Date: 20.NOV.2018 20:16:44

Middle Channel

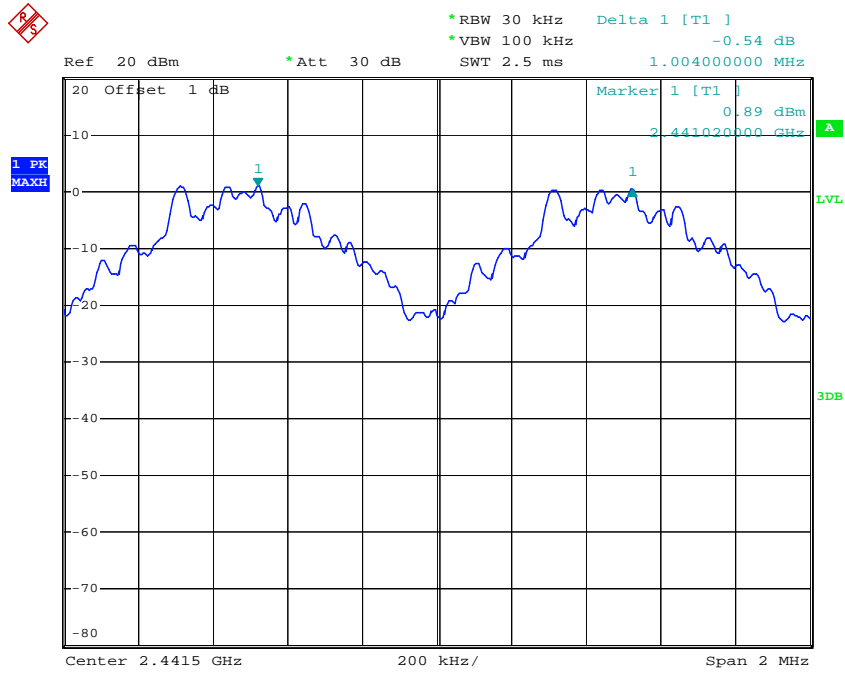

Date: 20.NOV.2018 20:17:46

High Channel

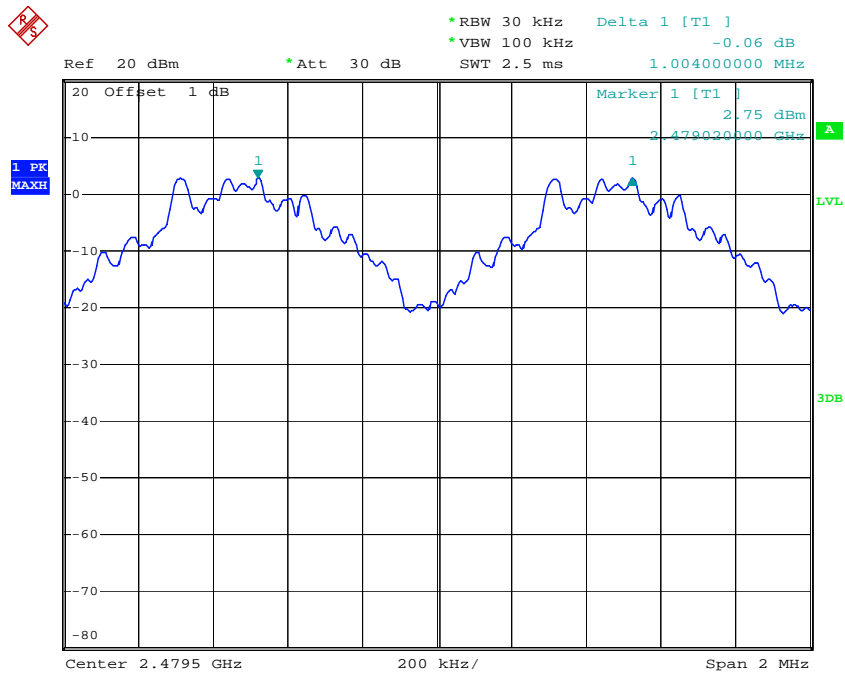

Date: 20.NOV.2018 20:19:04

EDR Mode ($\pi/4$ -DQPSK):

Low Channel

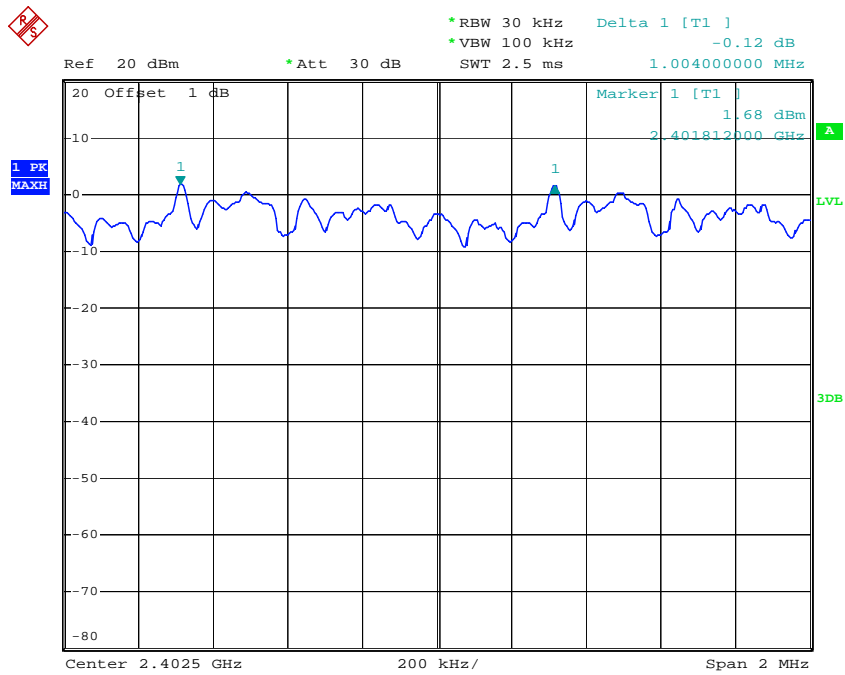

Date: 20.NOV.2018 20:20:23

Middle Channel

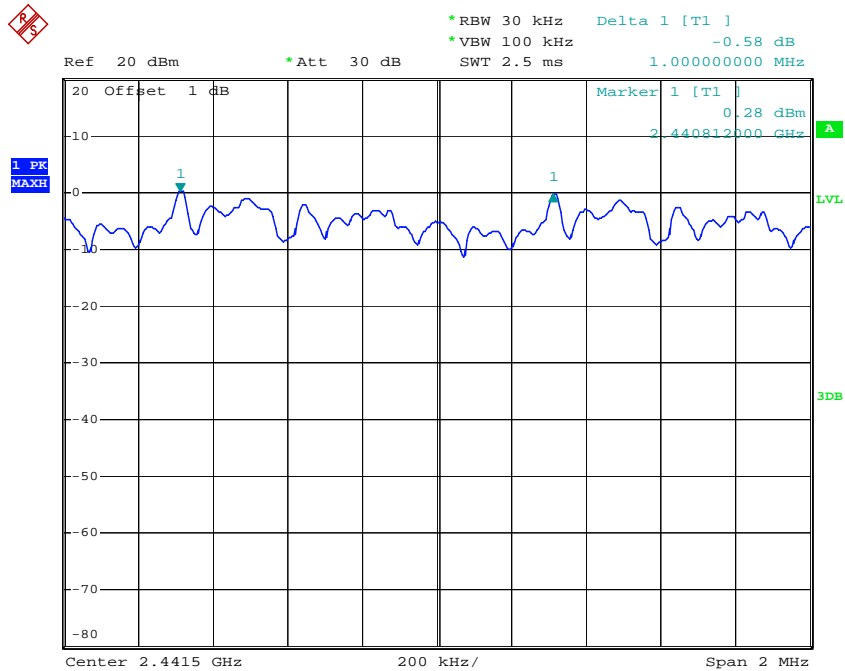

Date: 20.NOV.2018 20:21:20

High Channel

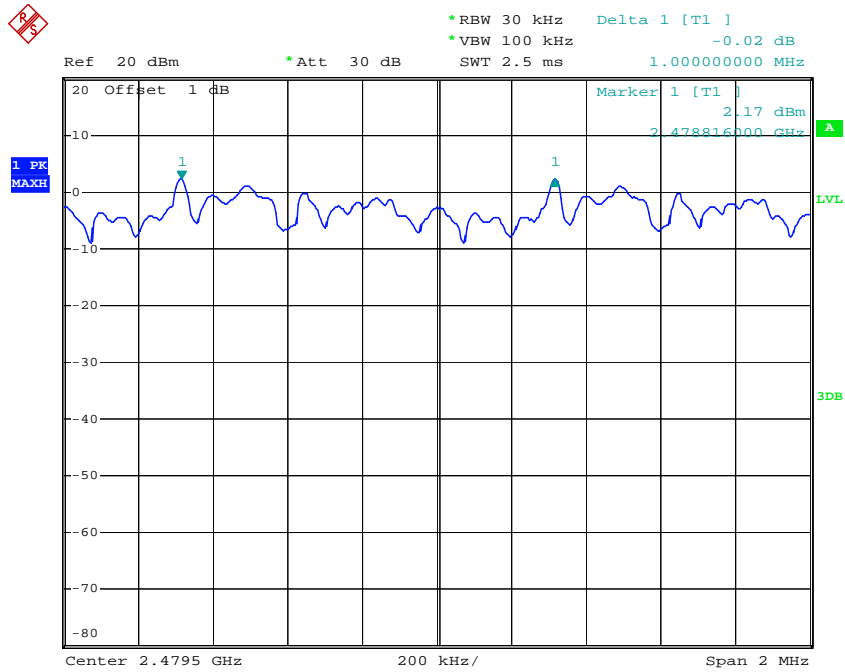

Date: 20.NOV.2018 20:23:16

EDR Mode (8DPSK):

Low Channel

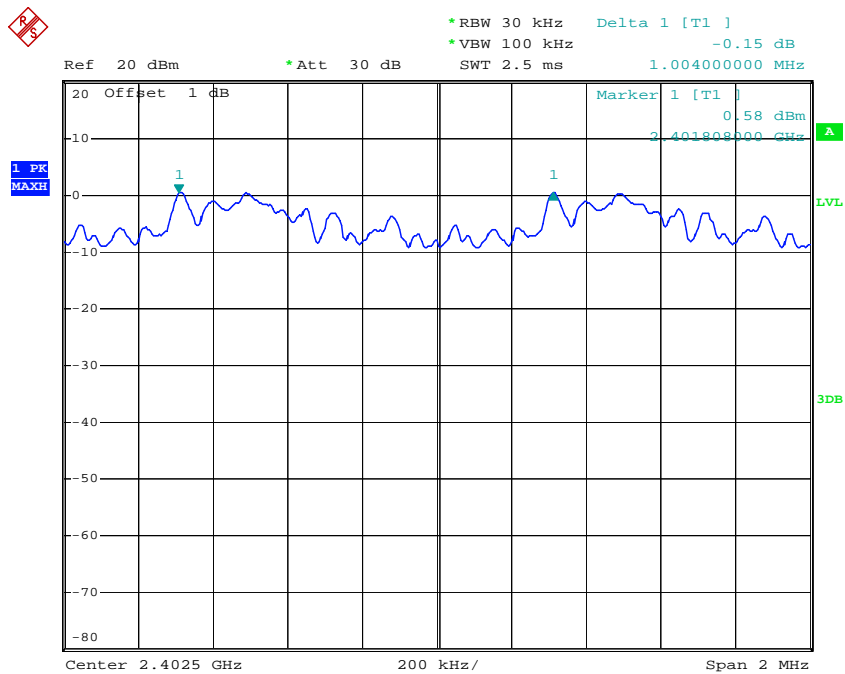

Date: 20.NOV.2018 20:24:35

Middle Channel

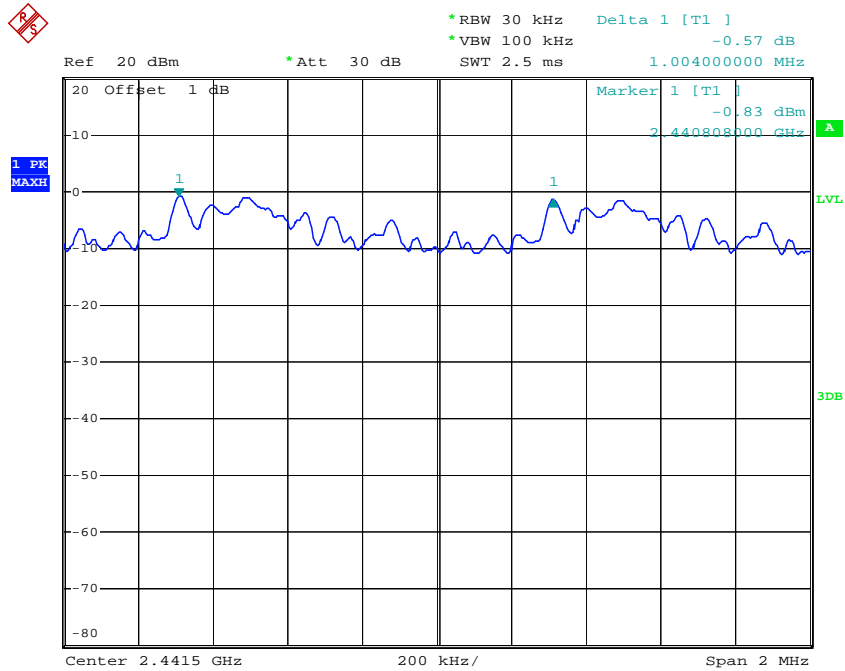

Date: 20.NOV.2018 20:26:46

High Channel

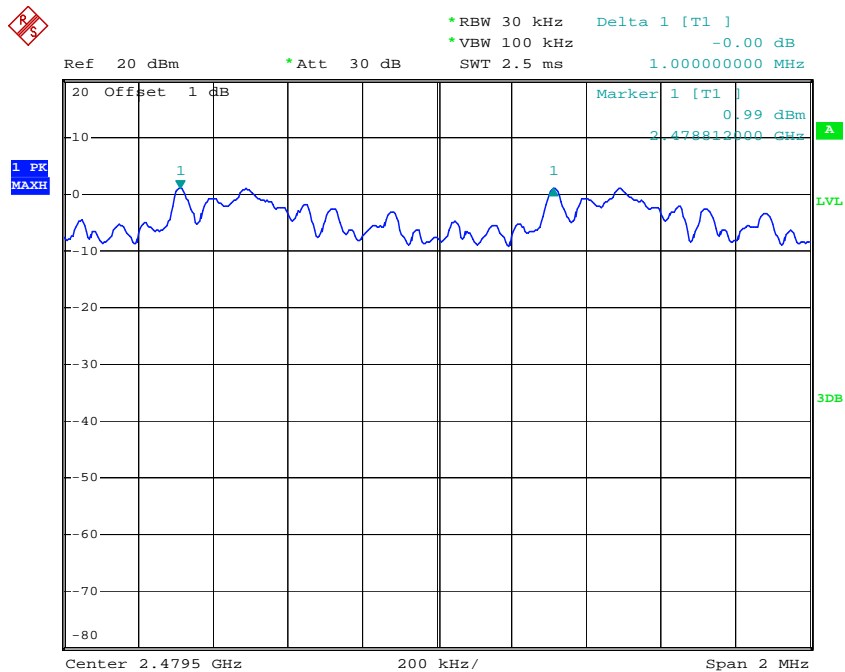

Date: 20.NOV.2018 20:25:47

FCC §15.247(a) (1) – 20 dB BANDWIDTH TESTING

Applicable Standard

Alternatively, frequency hopping systems operating in the 2400–2483.5 MHz band may have hopping channel carrier frequencies that are separated by 25 kHz or two-thirds of the 20 dB bandwidth of the hopping channel, whichever is greater, provided the systems operate with an output power no greater than 125 mW.

Test Procedure

1. Check the calibration of the measuring instrument using either an internal calibrator or a known signal from an external generator.
2. Position the EUT on the test table without connection to measurement instrument. Turn on the EUT. Then set it to any one convenient frequency within its operating range. Set a reference level on the measuring instrument equal to the highest peak value.
3. Measure the frequency difference of two frequencies that were attenuated 20 dB from the reference level. Record the frequency difference as the emission bandwidth.
4. Repeat above procedures until all frequencies measured were complete.

Test Equipment List and Details

Manufacturer	Description	Model	Serial Number	Calibration Date	Calibration Due Date
R&S	EMI Test Receiver	ESPI	100120	2017-12-11	2018-12-11
Unknown	Coaxial Cable	C-SJ00-0010	C0010/01	Each Time	/

* **Statement of Traceability:** Bay Area Compliance Laboratories Corp. (Dongguan) attests that all calibrations have been performed, traceable to National Primary Standards and International System of Units (SI).

Test Data

Environmental Conditions

Temperature:	25.9 °C
Relative Humidity:	51%
ATM Pressure:	100.7kPa

* *The testing was performed by Vito Chen&Tyler Pan on 2018-11-20.*

Test Result: Compliance.

Please refer to following tables and plots

Test Mode: Transmitting

Mode	Channel	Frequency (MHz)	20 dB Bandwidth (MHz)
BDR Mode (GFSK)	Low	2402	0.880
	Middle	2441	0.880
	High	2480	0.880
EDR Mode ($\pi/4$ -DQPSK)	Low	2402	1.312
	Middle	2441	1.312
	High	2480	1.308
EDR Mode (8DPSK)	Low	2402	1.276
	Middle	2441	1.276
	High	2480	1.280

BDR Mode (GFSK):

Low Channel

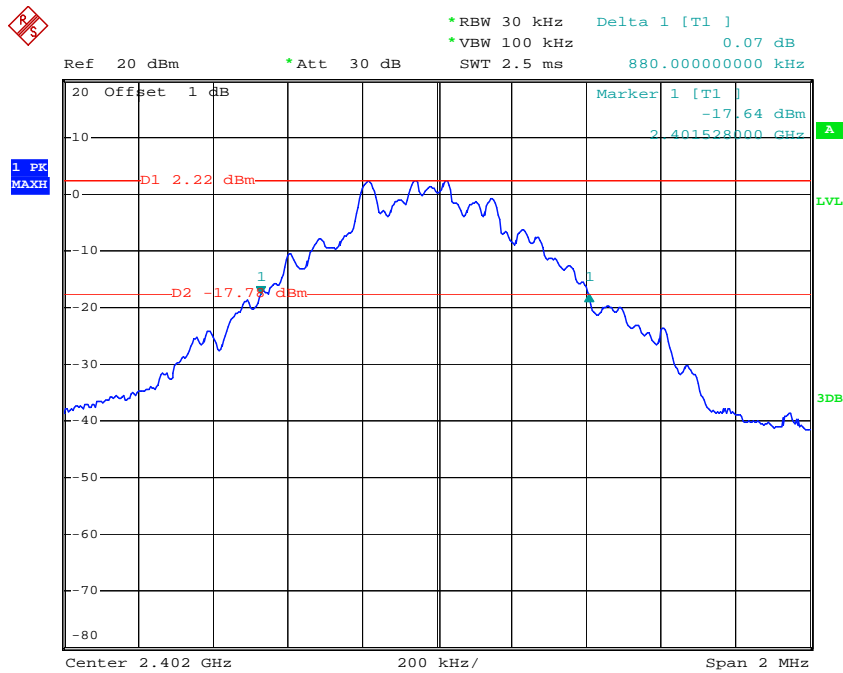

Date: 20.NOV.2018 19:46:26

Middle Channel

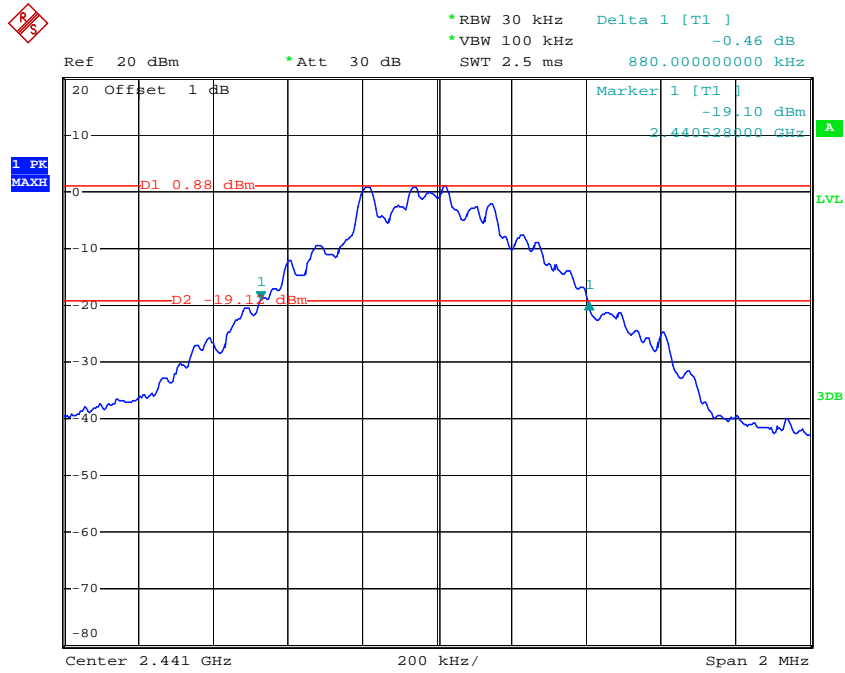

Date: 20.NOV.2018 19:47:37

High Channel

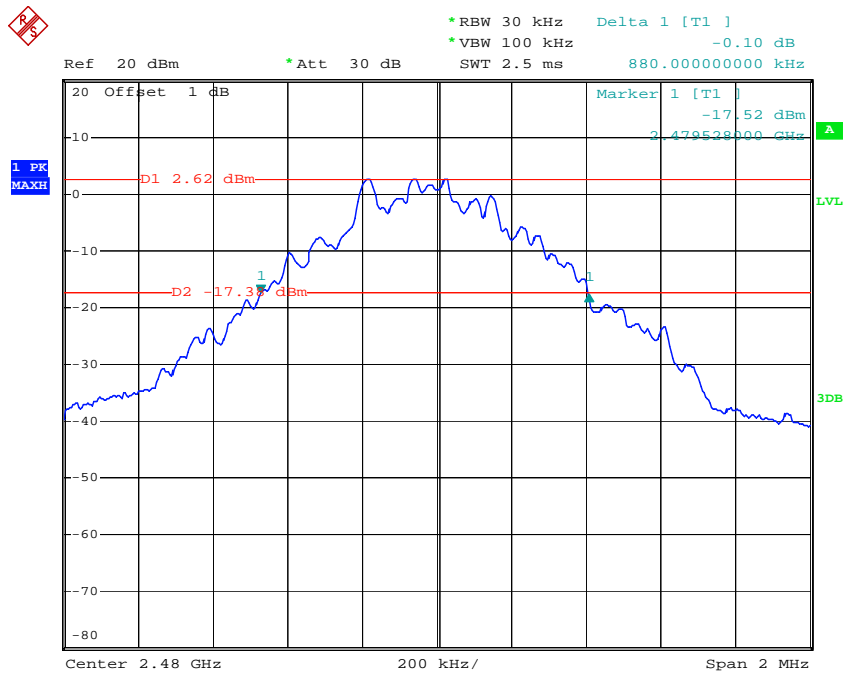

Date: 20.NOV.2018 19:48:59

EDR Mode ($\pi/4$ -DQPSK):

Low Channel

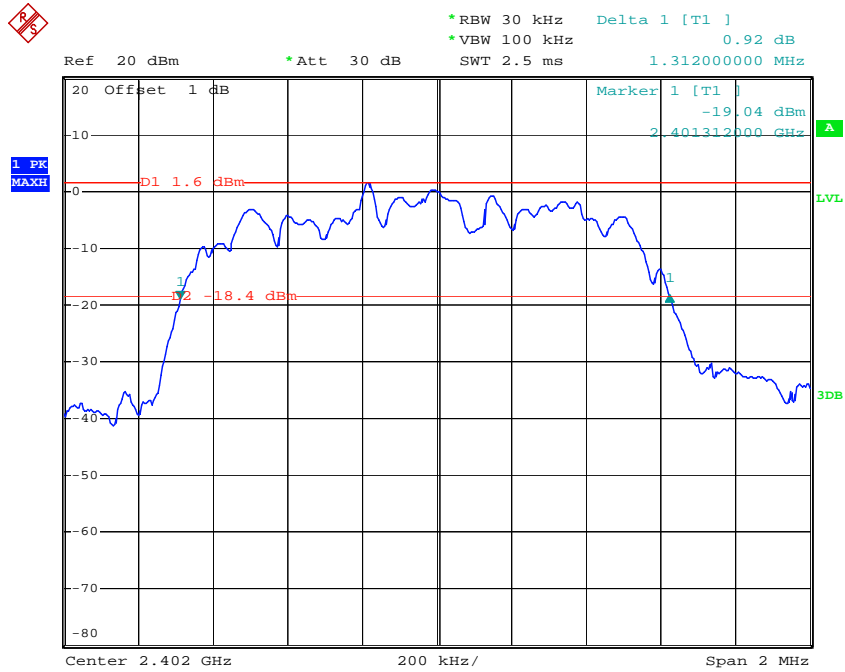

Date: 20.NOV.2018 19:51:50

Middle Channel

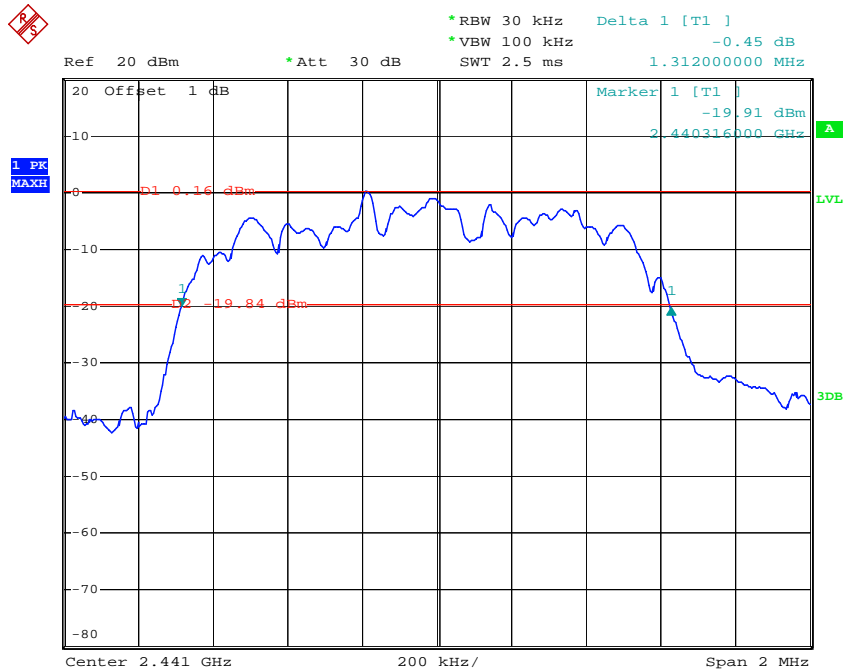

Date: 20.NOV.2018 19:53:32

High Channel

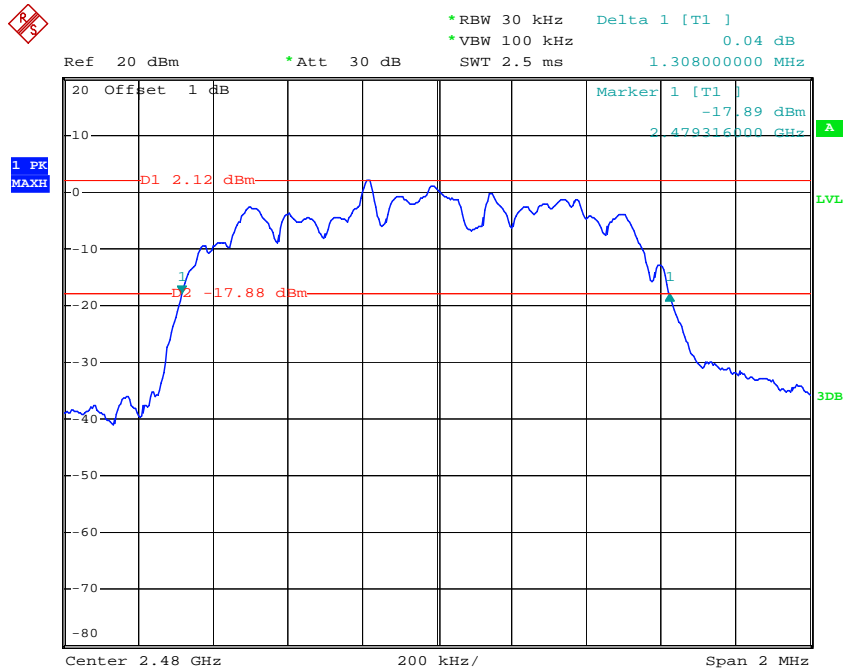

Date: 20.NOV.2018 19:54:47

EDR Mode (8DPSK):

Low Channel

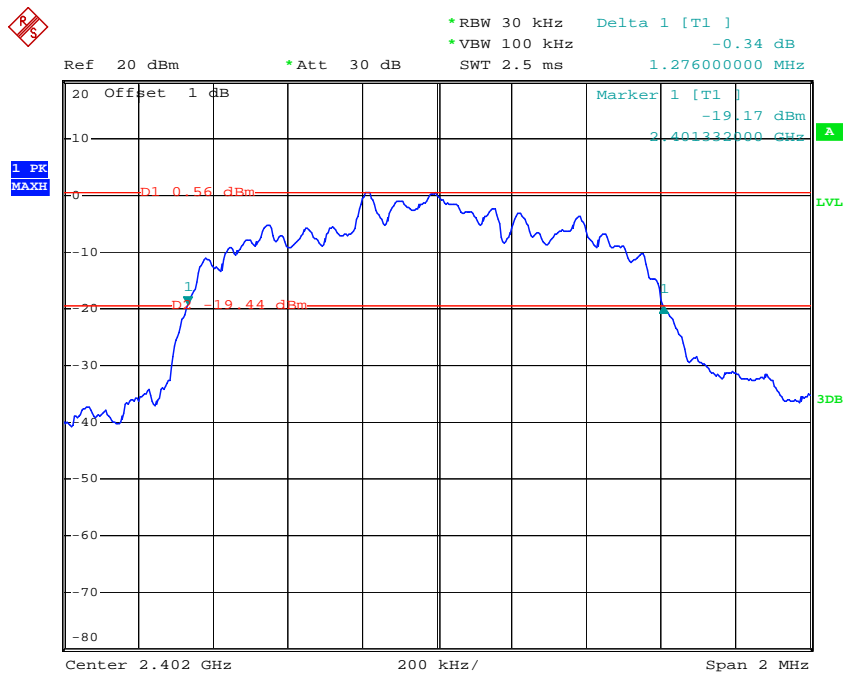

Date: 20.NOV.2018 19:59:42

Middle Channel

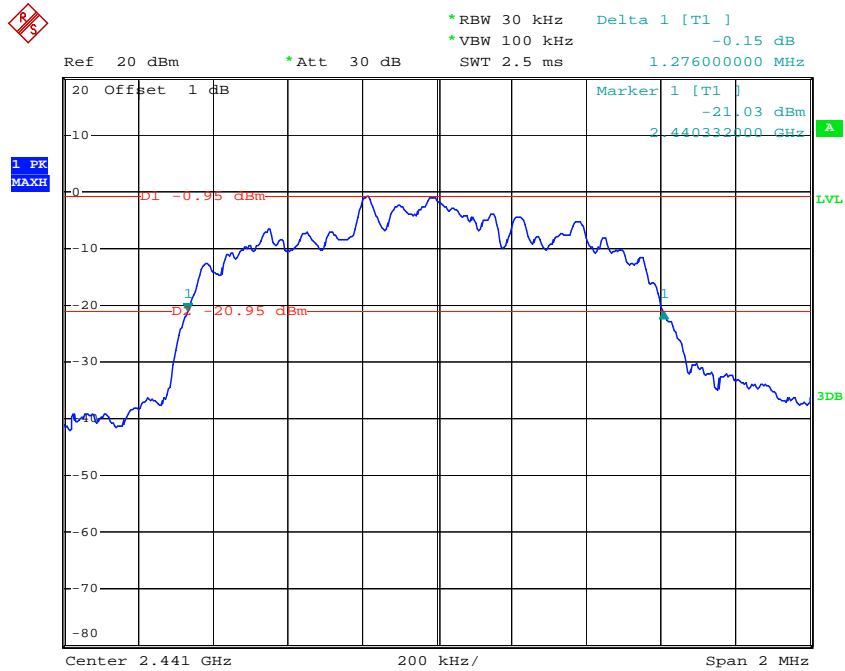

Date: 20.NOV.2018 19:58:24

High Channel

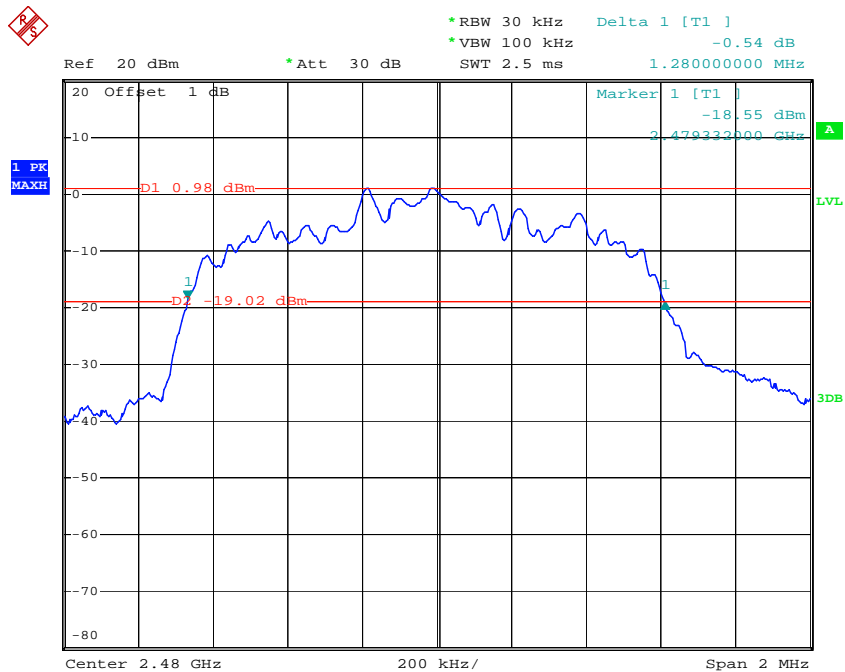

Date: 20.NOV.2018 19:56:40

FCC §15.247(a) (1) (iii) - QUANTITY OF HOPPING CHANNEL TEST

Applicable Standard

Frequency hopping systems in the 2400–2483.5 MHz band shall use at least 15 channels. The average time of occupancy on any channel shall not be greater than 0.4 seconds within a period of 0.4 seconds multiplied by the number of hopping channels employed. Frequency hopping systems may avoid or suppress transmissions on a particular hopping frequency provided that a minimum of 15 channels are used.

Test Procedure

1. Check the calibration of the measuring instrument (SA) using either an internal calibrator or a known signal from an external generator.
2. Set the EUT in hopping mode from first channel to last.
3. By using the Max-Hold function record the Quantity of the channel.

Test Equipment List and Details

Manufacturer	Description	Model	Serial Number	Calibration Date	Calibration Due Date
R&S	EMI Test Receiver	ESPI	100120	2017-12-11	2018-12-11
Unknown	Coaxial Cable	C-SJ00-0010	C0010/01	Each Time	/

* **Statement of Traceability:** Bay Area Compliance Laboratories Corp. (Dongguan) attests that all calibrations have been performed, traceable to National Primary Standards and International System of Units (SI).

Test Data

Environmental Conditions

Temperature:	25.9 °C
Relative Humidity:	51%
ATM Pressure:	100.7kPa

* *The testing was performed by Vito Chen&Tyler Pan on 2018-11-20.*

Test Result: Compliance.

Please refer to following tables and plots

Test Mode: Transmitting

BDR Mode (GFSK):

Frequency Range (MHz)	Number of Hopping Channel	Limit
2400-2483.5	79	≥15

Number of Hopping Channels

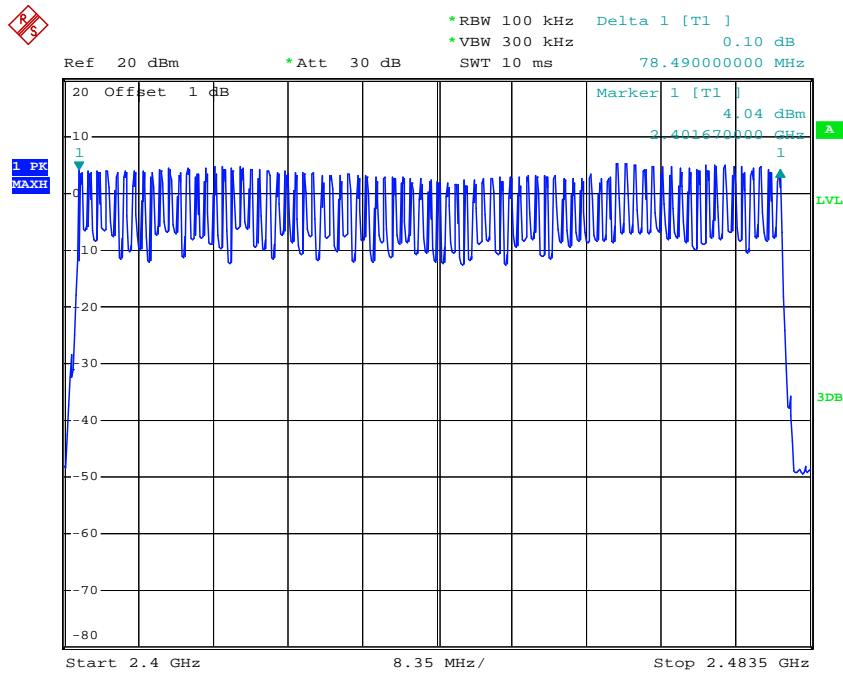

Date: 20.NOV.2018 20:14:41

EDR Mode ($\pi/4$ -DQPSK):

Frequency Range (MHz)	Number of Hopping Channel	Limit
2400-2483.5	79	≥ 15

Number of Hopping Channels

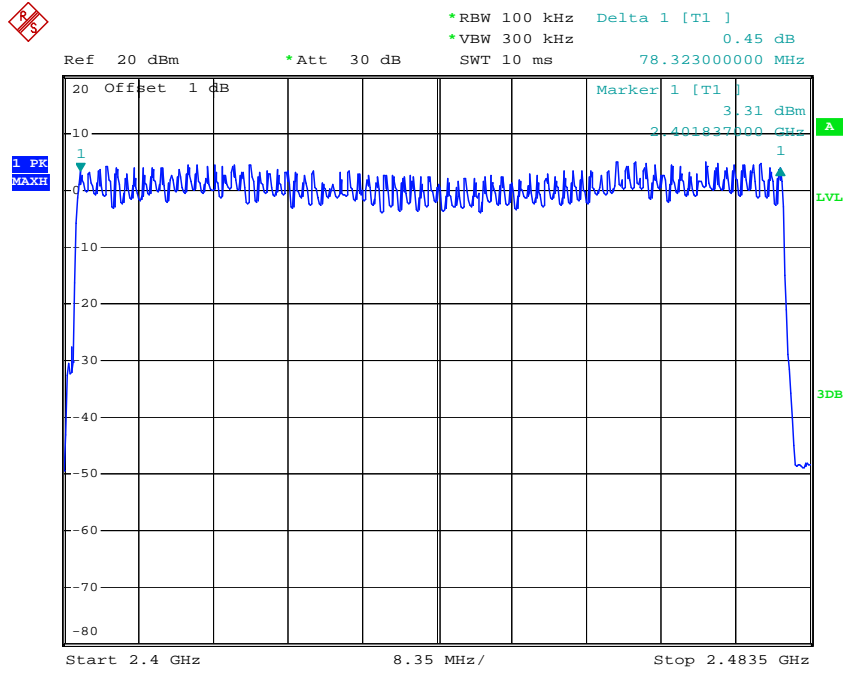

Date: 20.NOV.2018 20:10:10

EDR Mode (8DPSK):

Frequency Range (MHz)	Number of Hopping Channel	Limit
2400-2483.5	79	≥15

Number of Hopping Channels

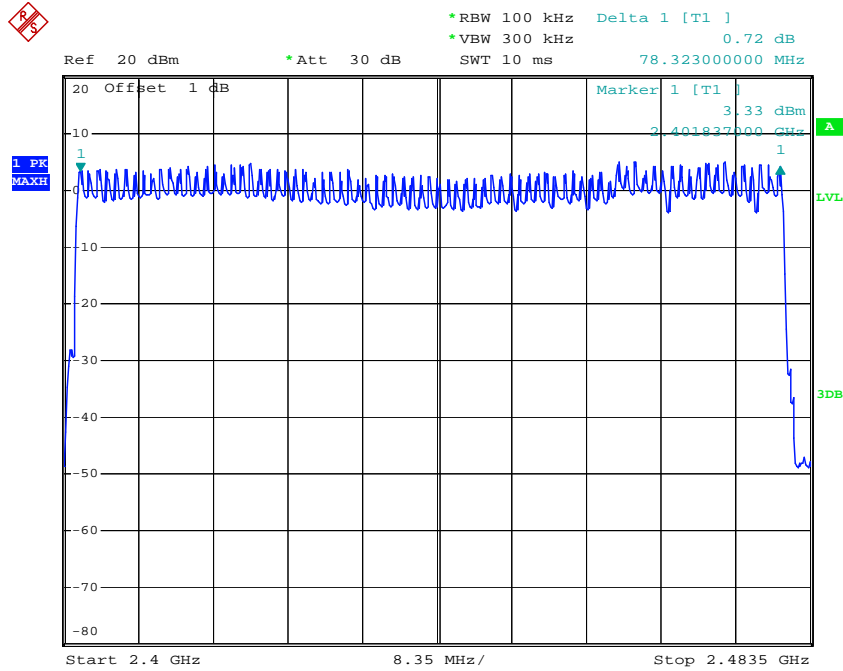

Date: 20.NOV.2018 20:05:51

FCC §15.247(a) (1) (iii) - TIME OF OCCUPANCY (DWELL TIME)

Applicable Standard

Frequency hopping systems in the 2400-2483.5 MHz shall use at least 15 channels. The average time of occupancy on any channel shall not be greater than 0.4 seconds within a period of 0.4 seconds multiplied by the number of hopping channels employed. Frequency hopping systems may avoid or suppress transmissions on a particular hopping frequency provided that a minimum of 15 channels are used.

Test Procedure

The EUT was worked in channel hopping; the time of single pulses was tested.

Test Equipment List and Details

Manufacturer	Description	Model	Serial Number	Calibration Date	Calibration Due Date
R&S	EMI Test Receiver	ESPI	100120	2017-12-11	2018-12-11
Unknown	Coaxial Cable	C-SJ00-0010	C0010/01	Each Time	/

* **Statement of Traceability:** Bay Area Compliance Laboratories Corp. (Dongguan) attests that all calibrations have been performed, traceable to National Primary Standards and International System of Units (SI).

Test Data

Environmental Conditions

Temperature:	25.9 °C
Relative Humidity:	51%
ATM Pressure:	100.7kPa

* *The testing was performed by Vito Chen&Tyler Pan on 2018-11-20.*

Test Result: Compliance.

Please refer to following tables and plots

Test Mode: Transmitting

BDR Mode (GFSK):

Mode	Channel	Pulse Width (ms)	Dwell Time (s)	Limit (s)	Result
DH1	Middle	0.412	0.132	0.4	Compliance
	Note: Dwell time=Pulse time (ms) × (1600/2/79) × 31.6 s				
DH3	Middle	1.686	0.270	0.4	Compliance
	Note: Dwell time=Pulse time (ms) × (1600/4/79) × 31.6 s				
DH5	Middle	2.940	0.314	0.4	Compliance
	Note: Dwell time=Pulse time (ms) × (1600/6/79) × 31.6 s				

DH1: Middle Channel

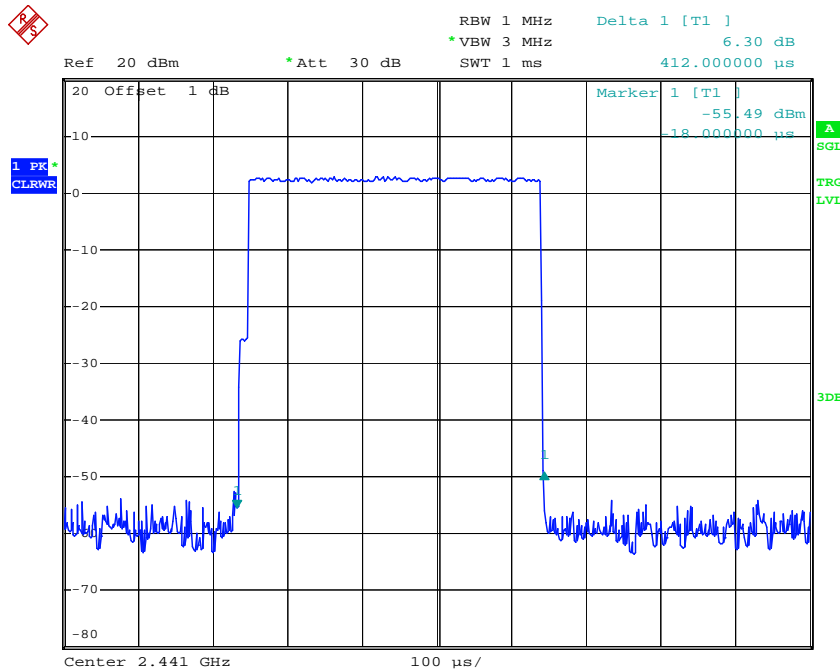

Date: 20.NOV.2018 20:29:26

DH3: Middle Channel

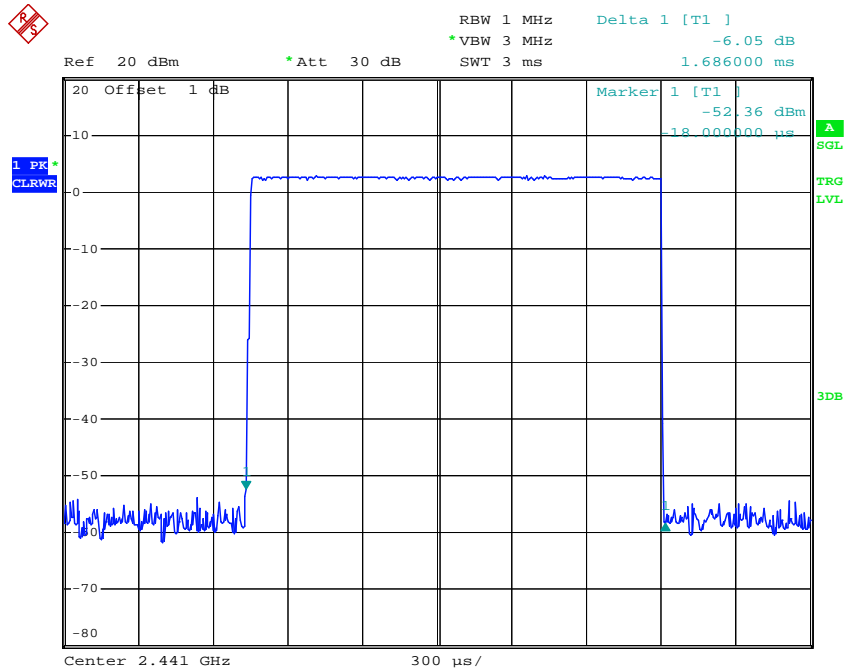

Date: 20.NOV.2018 20:33:05

DH5: Middle Channel

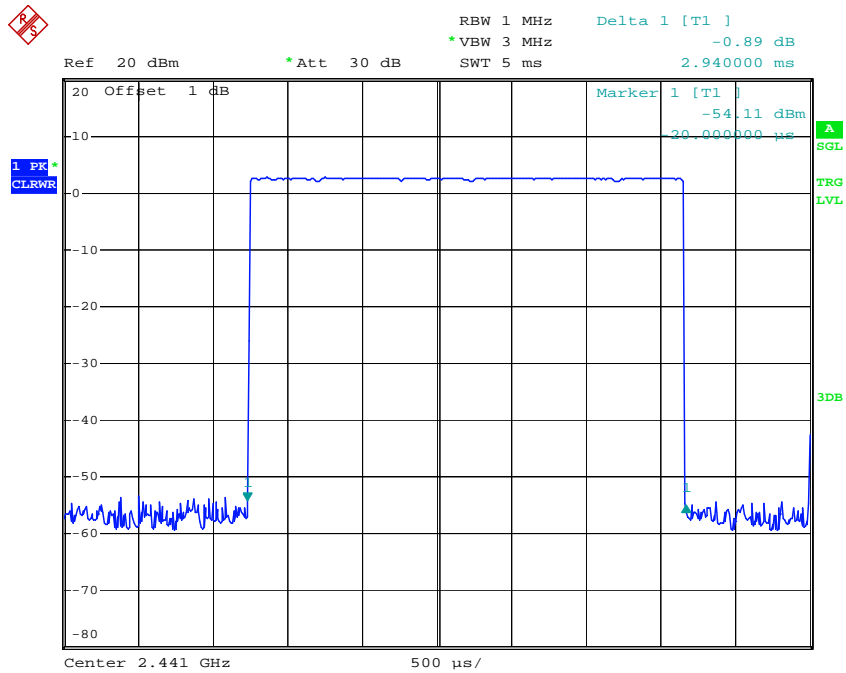

Date: 20.NOV.2018 20:34:20

EDR Mode ($\pi/4$ -DQPSK):

Mode	Channel	Pulse Width (ms)	Dwell Time (s)	Limit (s)	Result
2DH1	Middle	0.406	0.130	0.4	Compliance
	Note: Dwell time=Pulse time (ms) \times (1600/2/79) \times 31.6 s				
2DH3	Middle	1.674	0.268	0.4	Compliance
	Note: Dwell time=Pulse time (ms) \times (1600/4/79) \times 31.6 s				
2DH5	Middle	2.930	0.313	0.4	Compliance
	Note: Dwell time=Pulse time (ms) \times (1600/6/79) \times 31.6 s				

2DH1: Middle Channel

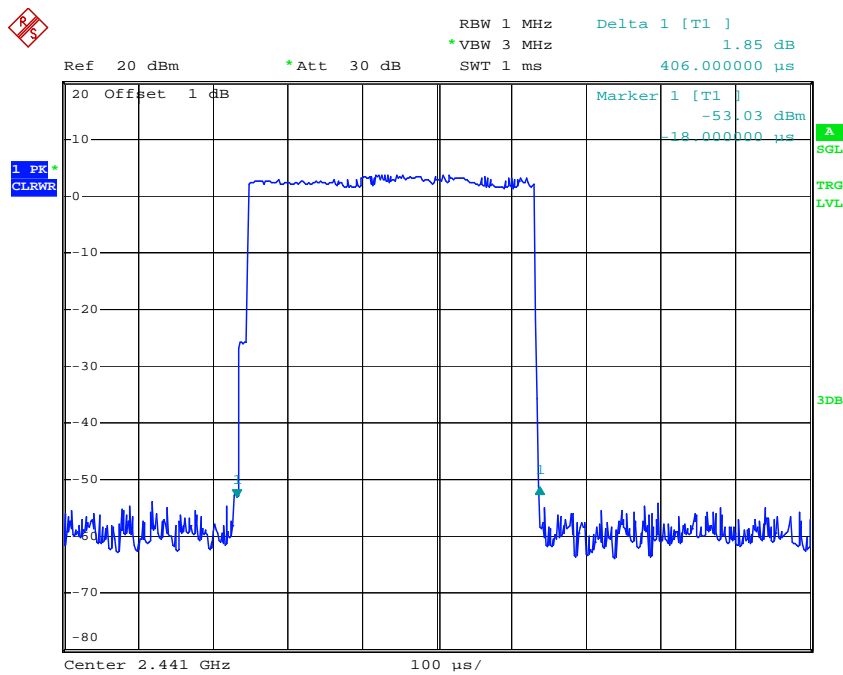

Date: 20.NOV.2018 20:28:42

2DH3: Middle Channel

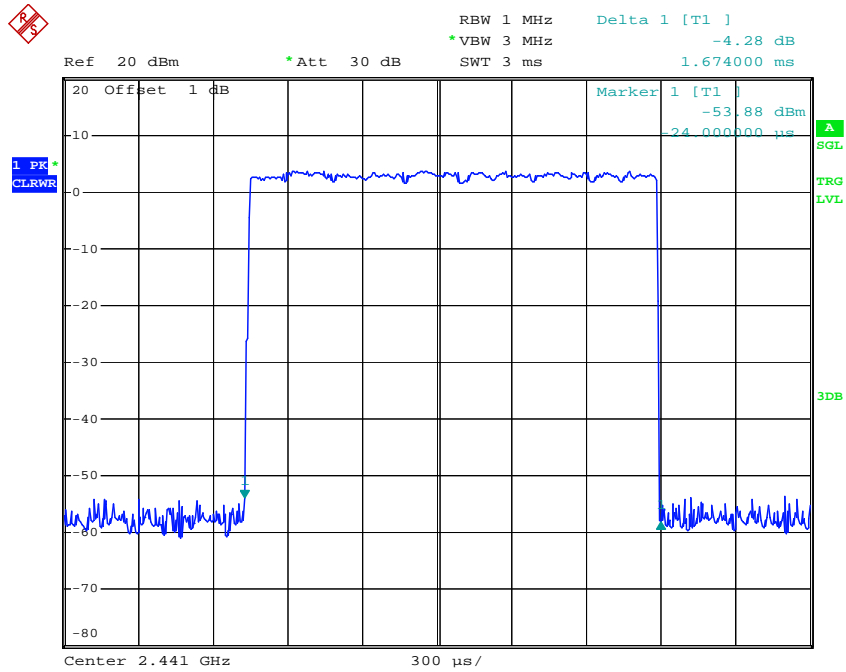

Date: 20.NOV.2018 20:35:30

2DH5: Middle Channel

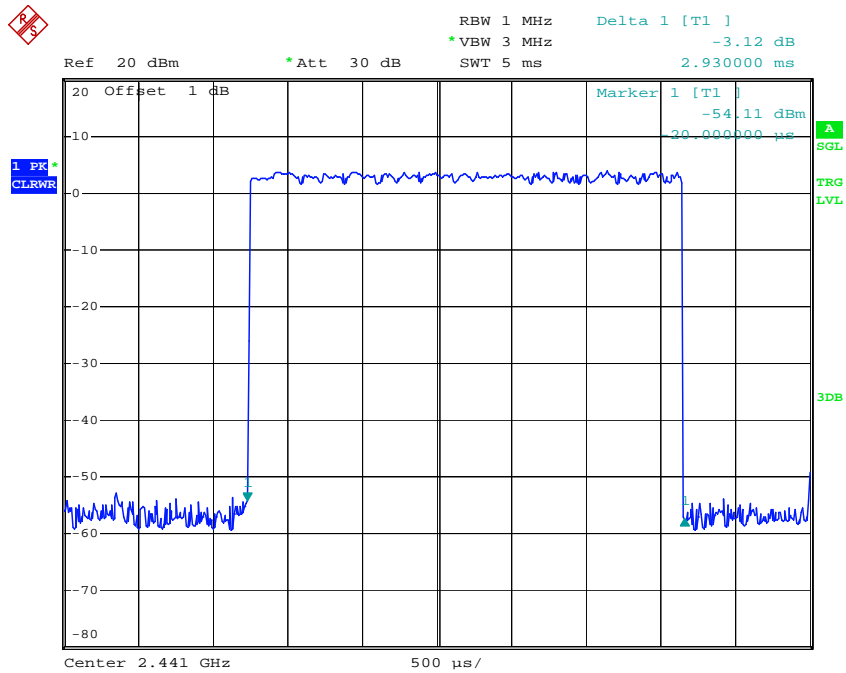

Date: 20.NOV.2018 20:36:46

EDR Mode (8DPSK):

Mode	Channel	Pulse Width (ms)	Dwell Time (s)	Limit (s)	Result
3DH1	Middle	0.402	0.129	0.4	Compliance
	Note: Dwell time=Pulse time (ms) × (1600/2/79) × 31.6 s				
3DH3	Middle	1.668	0.267	0.4	Compliance
	Note: Dwell time=Pulse time (ms) × (1600/4/79) × 31.6 s				
3DH5	Middle	2.920	0.311	0.4	Compliance
	Note: Dwell time=Pulse time (ms) × (1600/6/79) × 31.6 s				

3DH1: Middle Channel

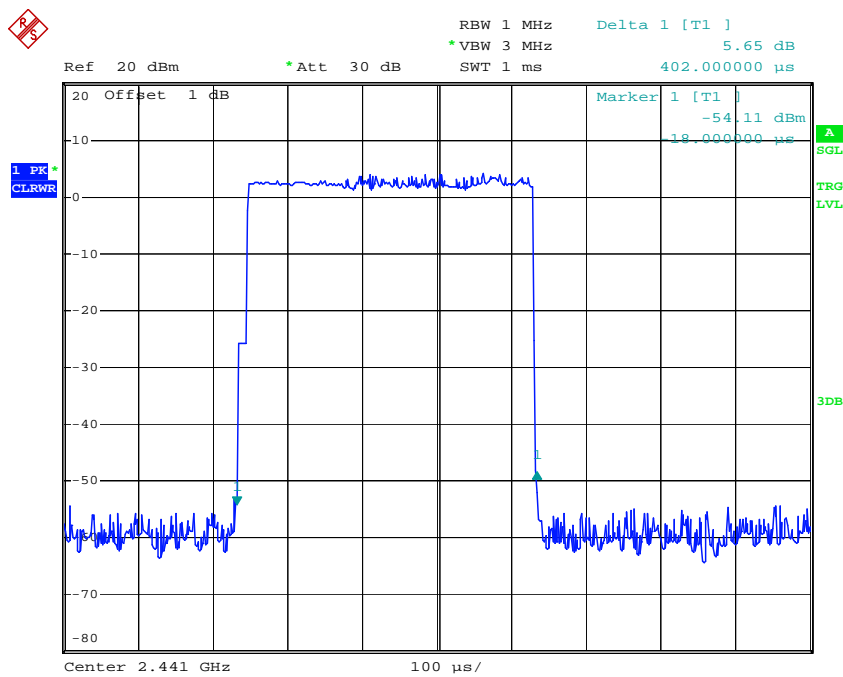

Date: 20.NOV.2018 20:27:51

3DH3: Middle Channel

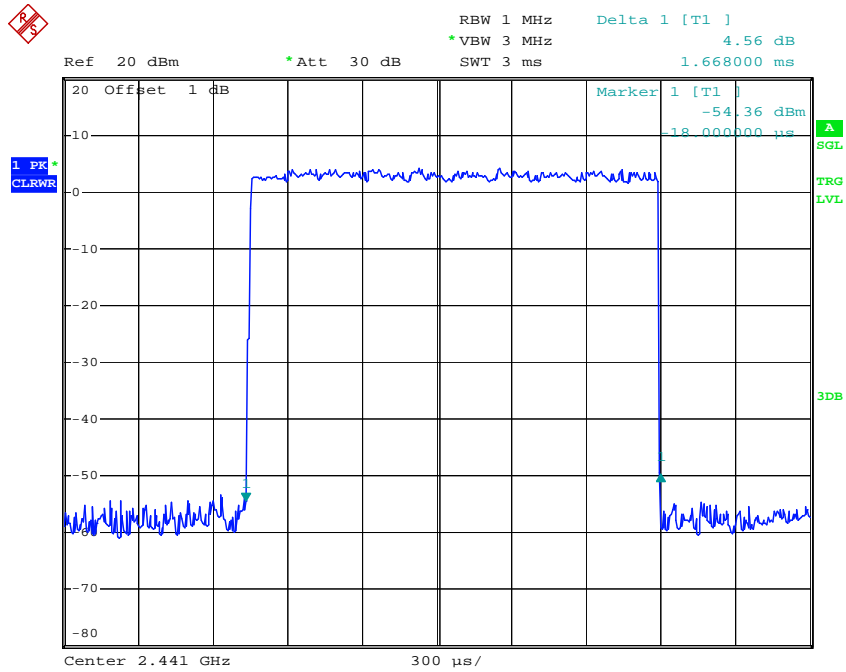

Date: 20.NOV.2018 20:38:39

3DH5: Middle Channel

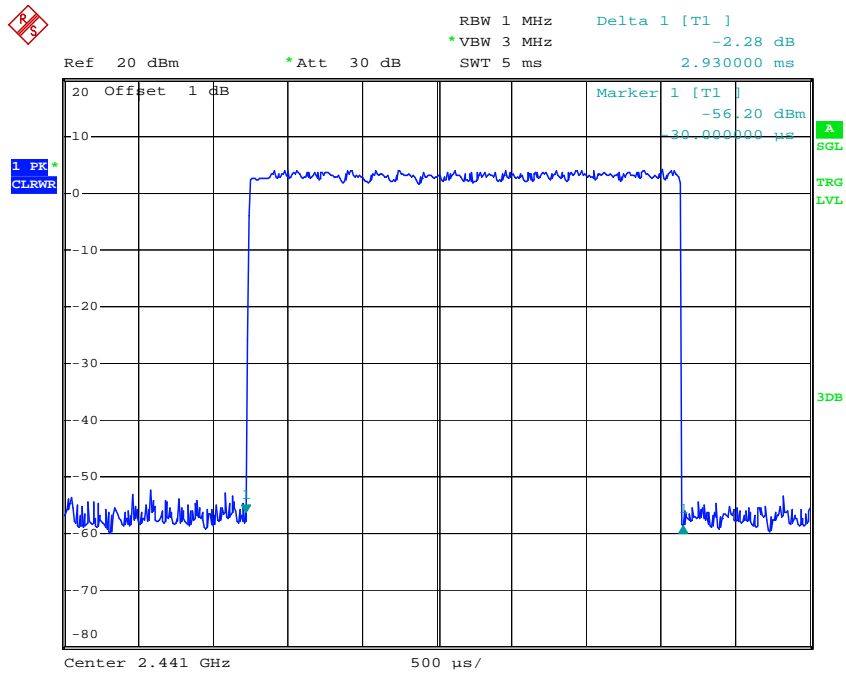

Date: 20.NOV.2018 20:40:00

FCC §15.247(b) (1) - PEAK OUTPUT POWER MEASUREMENT

Applicable Standard

According to §15.247(b) (1), for frequency hopping systems operating in the 2400–2483.5 MHz band employing at least 75 non-overlapping hopping channels, and all frequency hopping systems in the 5725–5850 MHz band: 1 watt. For all other frequency hopping systems in the 2400–2483.5 MHz band: 0.125 watts

Test Procedure

1. Place the EUT on a bench and set in transmitting mode.
2. Remove the antenna from the EUT and then connect a low loss RF cable from the antenna port to one test equipment.
3. Add a correction factor to the display.

Test Equipment List and Details

Manufacturer	Description	Model	Serial Number	Calibration Date	Calibration Due Date
Agilent	USB Wideband Power Sensor	U2022XA	MY5417006	2017-12-11	2018-12-11
Unknown	Coaxial Cable	C-SJ00-0010	C0010/01	Each Time	/

* **Statement of Traceability:** Bay Area Compliance Laboratories Corp. (Dongguan) attests that all calibrations have been performed, traceable to National Primary Standards and International System of Units (SI).

Test Data

Environmental Conditions

Temperature:	25.9 °C
Relative Humidity:	51%
ATM Pressure:	100.7kPa

* The testing was performed by Vito Chen&Tyler Pan on 2018-11-20.

Test Result: Compliance.

Test Mode: Transmitting

Mode	Frequency (MHz)	Peak Conducted Output power (dBm)	Limit (dBm)
BDR Mode (GFSK)	2402	4.25	21
	2441	2.85	21
	2480	4.62	21
EDR Mode ($\pi/4$ -DQPSK)	2402	5.59	21
	2441	4.43	21
	2480	6.14	21
EDR Mode (8DPSK)	2402	5.96	21
	2441	4.74	21
	2480	6.42	21

Note: The data above was tested in conducted mode.

FCC §15.247(d) - BAND EDGES TESTING

Applicable Standard

In any 100 kHz bandwidth outside the frequency band in which the spread spectrum or digitally modulated intentional radiator is operating, the radio frequency power that is produced by the intentional radiator shall be at least 20 dB below that in the 100 kHz bandwidth within the band that contains the highest level of the desired power, based on either an RF conducted or a radiated measurement, provided the transmitter demonstrates compliance with the peak conducted power limits. If the transmitter complies with the conducted power limits based on the use of RMS averaging over a time interval, as permitted under paragraph (b)(3) of this section, the attenuation required under this paragraph shall be 30 dB instead of 20 dB. Attenuation below the general limits specified in §15.209(a) is not required. In addition, radiated emissions which fall in the restricted bands, as defined in §15.205(a), must also comply with the radiated emission limits specified in §15.209(a) (see §15.205(c)).

Test Procedure

1. Check the calibration of the measuring instrument using either an internal calibrator or a known signal from an external generator.
2. Remove the antenna from the EUT and then connect to a low loss RF cable from the antenna port to a EMI test receiver, then turn on the EUT and make it operate in transmitting mode. Then set it to Low Channel and High Channel within its operating range, and make sure the instrument is operated in its linear range.
3. Set RBW/ VBW of spectrum analyzer to 100/300 kHz with a convenient frequency span including 100 kHz bandwidth from band edge.
4. Measure the highest amplitude appearing on spectral display and set it as a reference level. Plot the graph with marking the highest point and edge frequency.
5. Repeat above procedures until all measured frequencies were complete.

Test Equipment List and Details

Manufacturer	Description	Model	Serial Number	Calibration Date	Calibration Due Date
R&S	EMI Test Receiver	ESPI	100120	2017-12-11	2018-12-11
Unknown	Coaxial Cable	C-SJ00-0010	C0010/01	Each Time	/

* **Statement of Traceability:** Bay Area Compliance Laboratories Corp. (Dongguan) attests that all calibrations have been performed, traceable to National Primary Standards and International System of Units (SI).

Test Data

Environmental Conditions

Temperature:	25.9 °C
Relative Humidity:	51%
ATM Pressure:	100.7kPa

* The testing was performed by Vito Chen&Tyler Pan on 2018-11-20.

Test Result: Compliance

Single mode, BDR Mode (GFSK):

Band Edge, Left Side

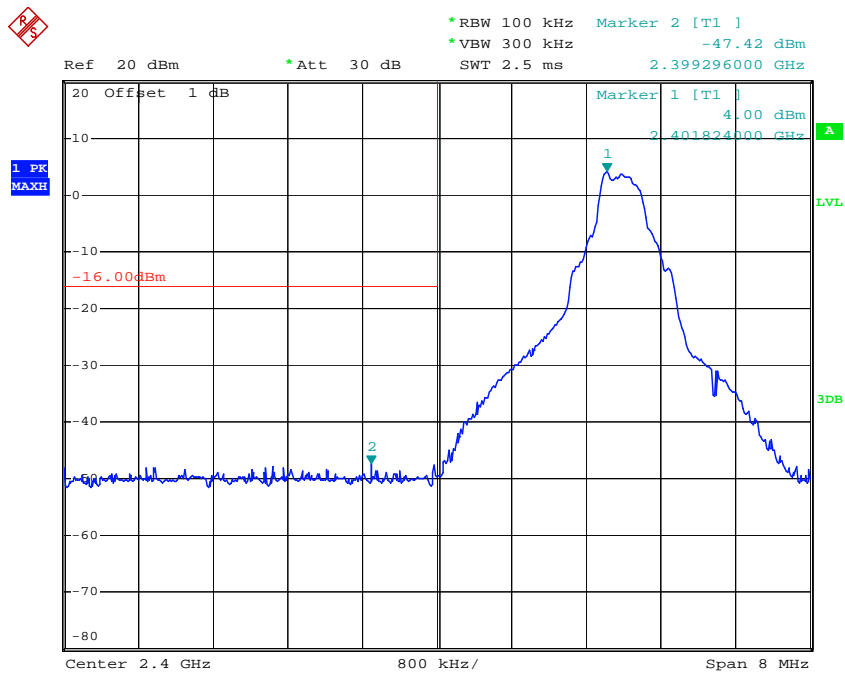

Date: 20.NOV.2018 19:50:54

Band Edge, Right Side

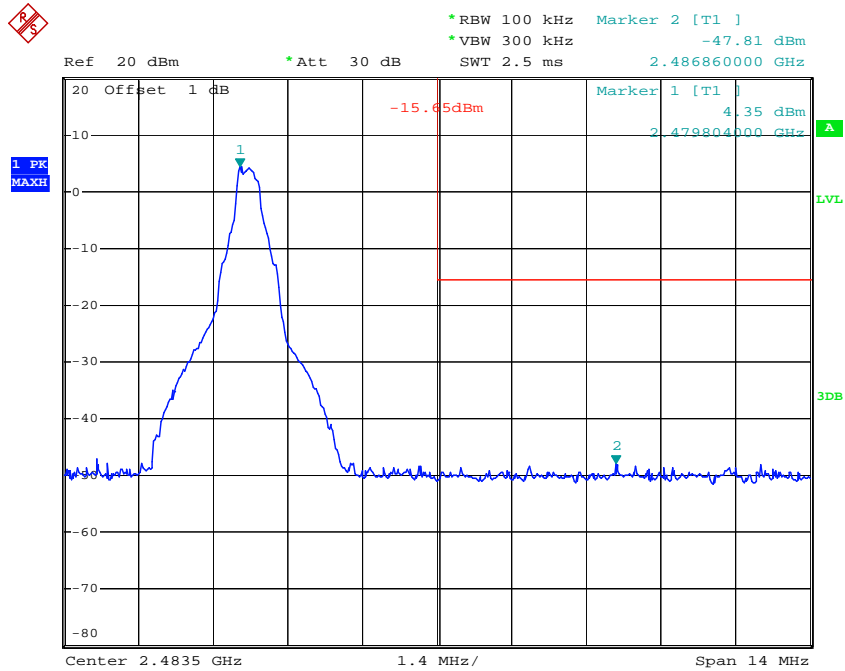

Date: 20.NOV.2018 19:50:01

EDR Mode ($\pi/4$ -DQPSK):

Band Edge, Left Side

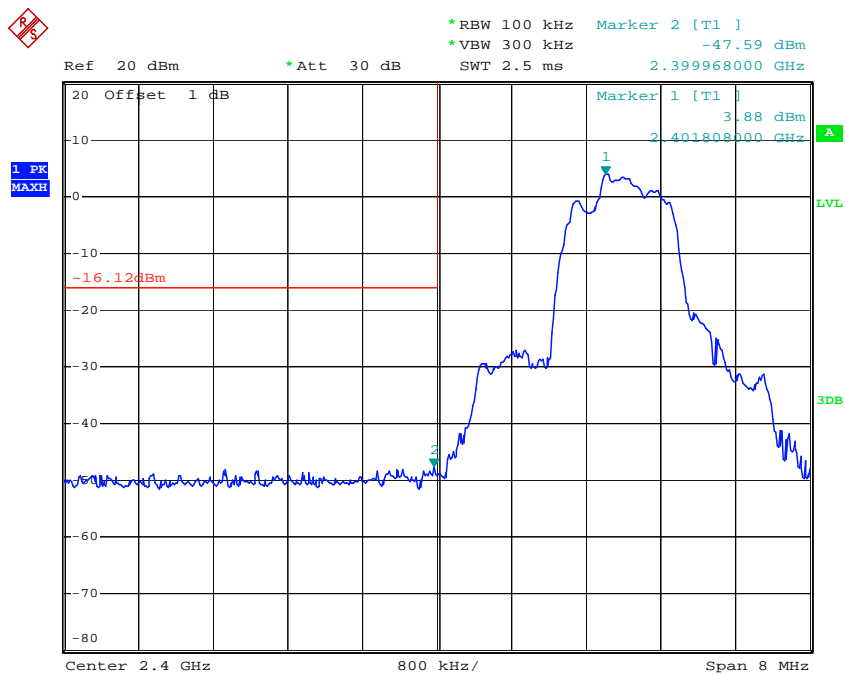

Date: 20.NOV.2018 19:52:47

Band Edge, Right Side

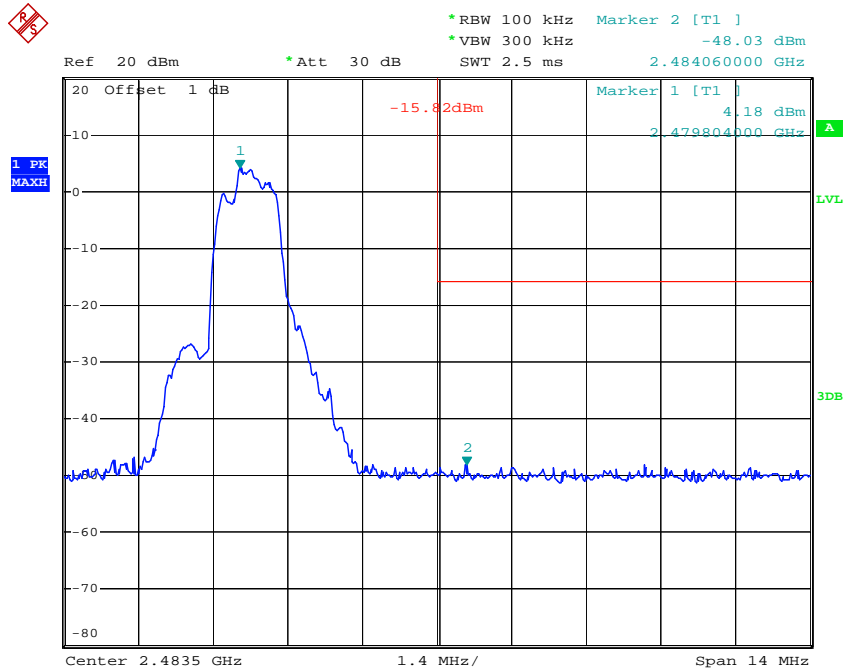

Date: 20.NOV.2018 19:55:49

EDR Mode (8DPSK):

Band Edge, Left Side

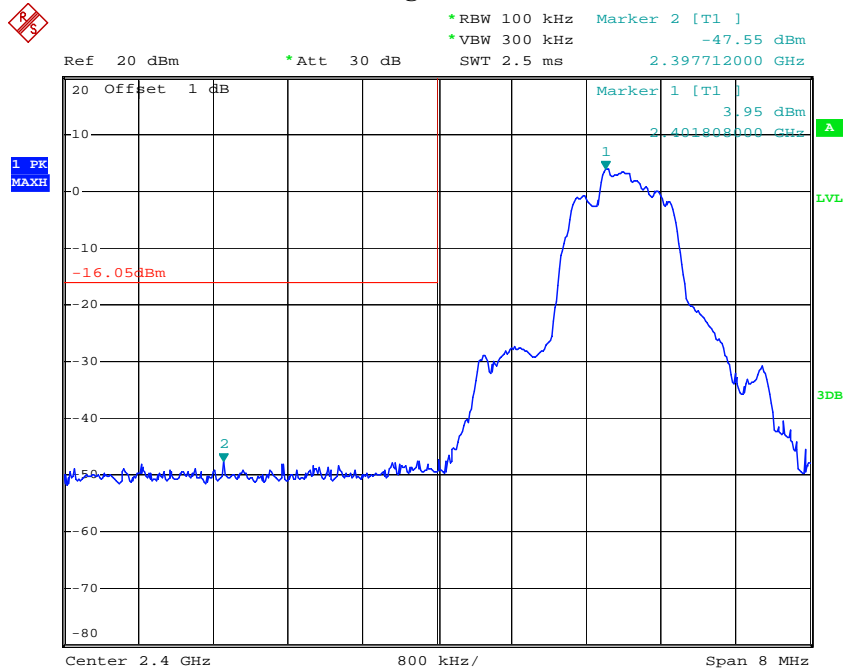

Date: 20.NOV.2018 20:00:45

Band Edge, Right Side

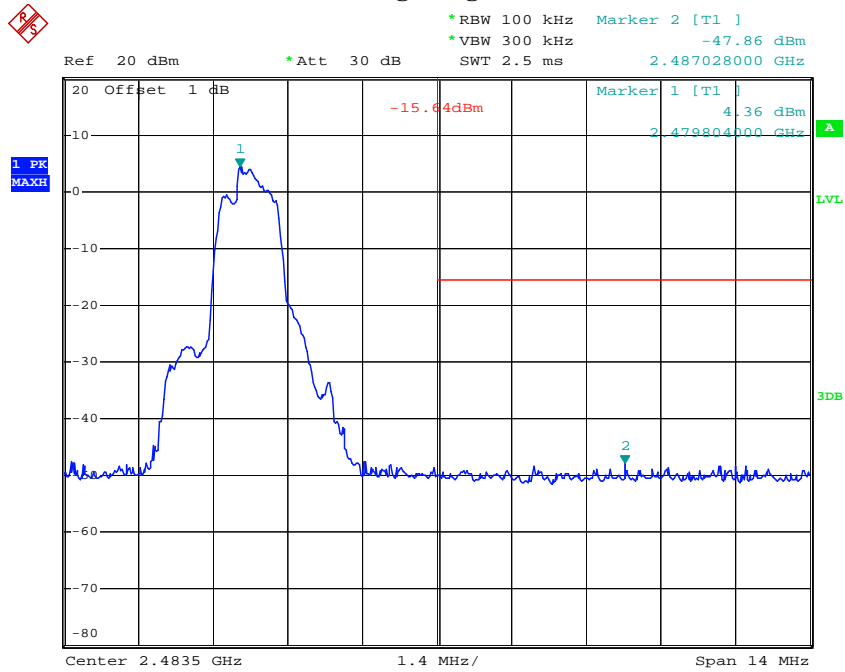

Date: 20.NOV.2018 19:57:33

Hopping channel mode, BDR Mode (GFSK):

Band Edge, Left Side

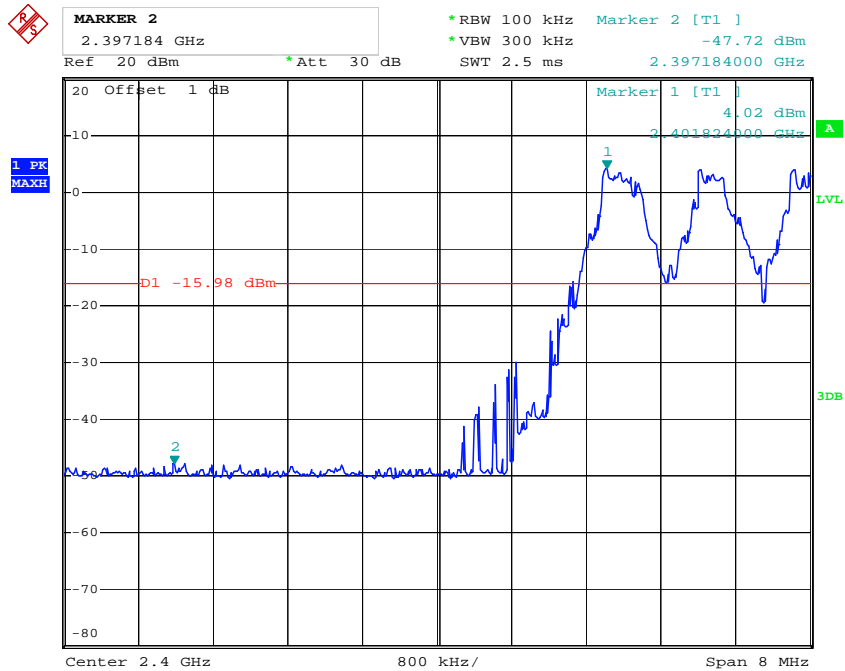

Date: 20.NOV.2018 20:49:27

Band Edge, Right Side

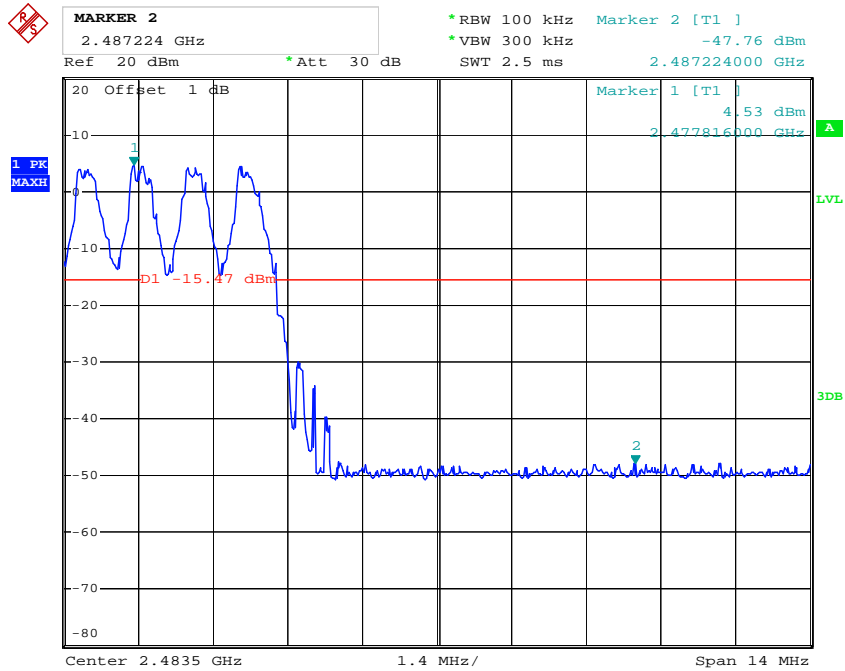

Date: 20.NOV.2018 20:50:58

EDR Mode ($\pi/4$ -DQPSK):

Band Edge, Left Side

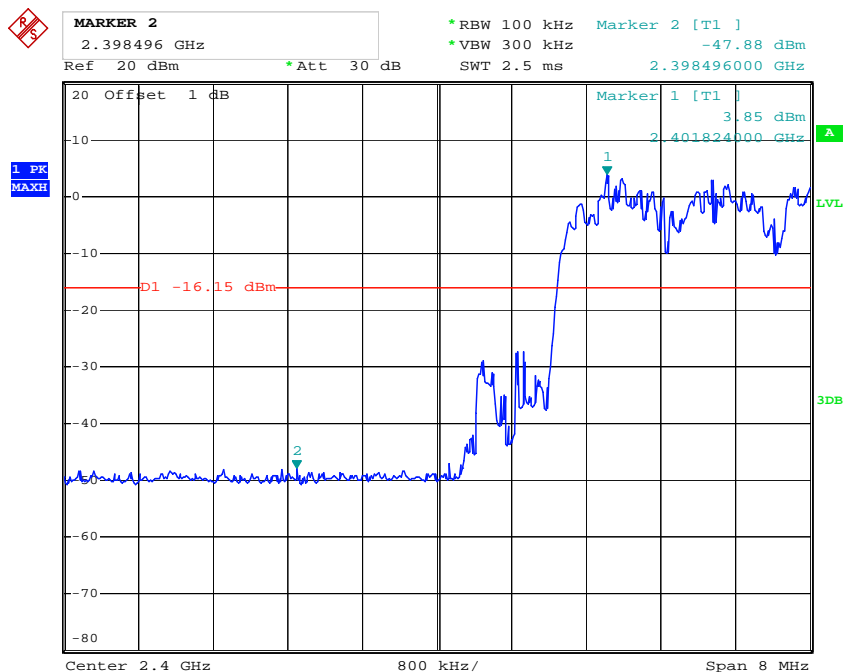

Date: 20.NOV.2018 20:54:45

Band Edge, Right Side

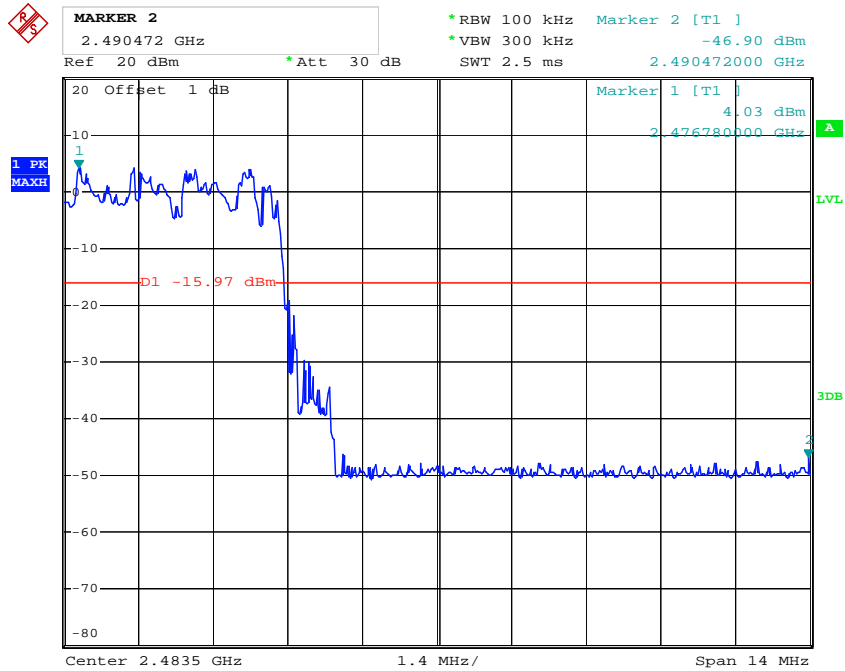

Date: 20.NOV.2018 20:56:18

EDR Mode (8DPSK):

Band Edge, Left Side

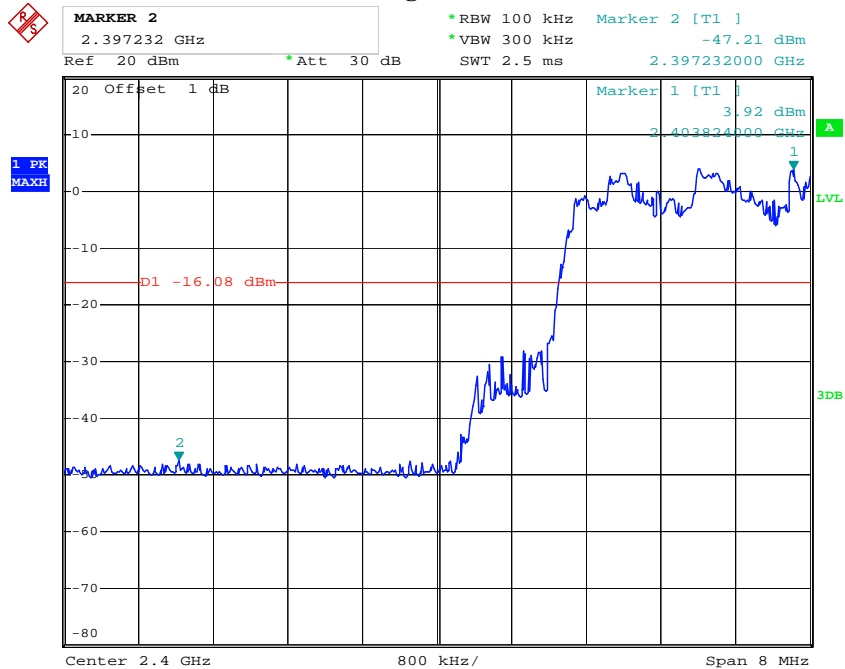

Date: 20.NOV.2018 21:00:11

Band Edge, Right Side

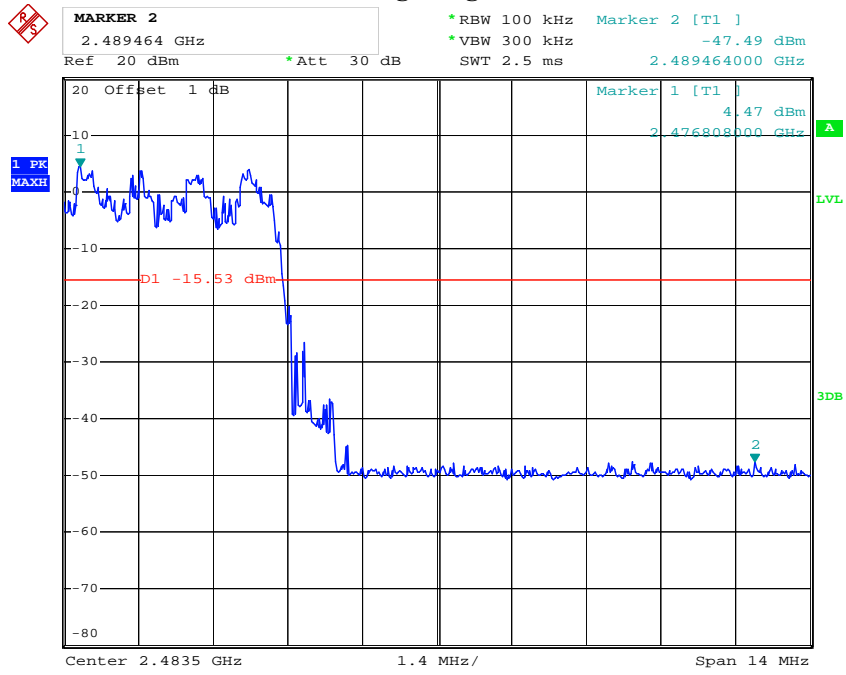

Date: 20.NOV.2018 21:01:52

***** END OF REPORT *****