



# MEASUREMENT REPORT

## FCC PART 15.247 WLAN 802.11b/g/n

---

**FCC ID:** 2AHU2NCSP3DC  
**APPLICANT:** ASA Electronics Shenzhen Limited  
**Application Type:** Certification  
**Product:** NCSP3 Display Commander  
**Model No.:** NCSP3DC  
**Brand Name:** iN • Command  
**FCC Classification:** (DTS) Digital Transmission System  
**FCC Rule Part(s):** Part 15.247  
**Test Procedure(s):** ANSI C63.10-2013  
**Received Date:** September 7, 2020  
**Test Date:** September 8, 2020 ~ September 24, 2020

**Tested By** : *Peter Syu*

( Peter Syu )

**Reviewed By** : *Paddy Chen*

( Paddy Chen )

**Approved By** : *Chenz Ker*

( Chenz Ker )



Testing Laboratory  
3261

The test results only relate to the samples tested.

This equipment has been shown to be capable of compliance with the applicable technical standards as indicated in the measurement report and was tested in accordance with the measurement procedures specified in ANSI C63.10. Test results reported herein relate only to the item(s) tested.

The test report shall not be reproduced except in full without the written approval of MRT Technology (Taiwan) Co., Ltd.

### Revision History

Report No.	Version	Description	Issue Date	Note
2009TW5501-U3	1.0	Original Report	2020-10-05	

---

# CONTENTS

Description	Page
<b>§2.1033 General Information .....</b>	<b>5</b>
<b>1. INTRODUCTION .....</b>	<b>6</b>
1.1. Scope.....	6
1.2. MRT Test Location.....	6
<b>2. PRODUCT INFORMATION .....</b>	<b>7</b>
2.1. Equipment Description .....	7
2.2. Working Frequencies for this Report .....	8
2.3. Test Mode.....	9
2.4. Test Software .....	9
2.5. Test Configuration.....	10
2.6. EMI Suppression Device(s)/Modifications .....	10
2.7. Labeling Requirements .....	10
<b>3. DESCRIPTION of TEST .....</b>	<b>11</b>
3.1. Evaluation Procedure.....	11
3.2. AC Line Conducted Emissions .....	11
3.3. Radiated Emissions .....	12
<b>4. ANTENNA REQUIREMENTS.....</b>	<b>13</b>
<b>5. TEST EQUIPMENT CALIBRATION DATE.....</b>	<b>14</b>
<b>6. MEASUREMENT UNCERTAINTY.....</b>	<b>15</b>
<b>7. TEST RESULT .....</b>	<b>16</b>
7.1. Summary.....	16
7.2. 6dB Bandwidth Measurement .....	17
7.2.1. Test Limit.....	17
7.2.2. Test Procedure used .....	17
7.2.3. Test Setting .....	17
7.2.4. Test Setup.....	17
7.2.5. Test Result .....	18
7.3. Output Power Measurement.....	21
7.3.1. Test Limit.....	21
7.3.2. Test Procedure Used.....	21
7.3.3. Test Setting .....	21
7.3.4. Test Setup.....	21
7.3.5. Test Result of Output Power.....	22
7.4. Power Spectral Density Measurement .....	23
7.4.1. Test Limit.....	23
7.4.2. Test Procedure Used.....	23
7.4.3. Test Setting .....	23
7.4.4. Test Setup.....	23
7.4.5. Test Result .....	24
7.5. Out-of-Band Spurious Emissions Emissions Measurement.....	27

---

7.5.1.	Test Limit .....	27
7.5.2.	Test Procedure Used .....	27
7.5.3.	Test Settintg .....	27
7.5.4.	Test Setup .....	27
7.5.5.	Test Result .....	28
7.6.	Radiated Spurious Emission Measurement.....	35
7.6.1.	Test Limit .....	35
7.6.2.	Test Procedure Used .....	35
7.6.3.	Test Setting .....	35
7.6.4.	Test Setup .....	37
7.6.5.	Test Result .....	39
7.7.	Radiated Restricted Band Edge Measurement.....	59
7.7.1.	Test Limit .....	59
7.7.2.	Test Procedure Used .....	59
7.7.3.	Test Setting .....	59
7.7.4.	Test Setup .....	61
7.7.5.	Test Result .....	62
7.8.	AC Conducted Emissions Measurement .....	86
7.8.1.	Test Limit .....	86
7.8.2.	Test Setup .....	86
7.8.3.	Test Result .....	87
<b>8.</b>	<b>CONCLUSION .....</b>	<b>88</b>

## §2.1033 General Information

<b>Applicant</b>	ASA Electronics Shenzhen Limited
<b>Applicant Address</b>	Room 503, 5/F., Unit A, Skyworth Building, Gaoxin Avenue.1.S.,Nanshan District, Shen Zhen 518057, China
<b>Manufacturer</b>	SYSGRATION LTD.
<b>Manufacturer Address</b>	6F, No.1 , Sec. 1 , Tiding Blvd. , Neihu Dist. , Taipei City 11494, Taiwan
<b>Test Site</b>	MRT Technology (Taiwan) Co., Ltd
<b>Test Site Address</b>	No. 38, Fuxing Second Rd., Guishan Dist., Taoyuan City 333, Taiwan (R.O.C)
<b>MRT FCC Registration No.</b>	291082
<b>FCC Rule Part(s)</b>	Part 15.247
<b>Model No.</b>	NCSP3DC
<b>Test Device Serial No.</b>	#1 <input type="checkbox"/> Production <input checked="" type="checkbox"/> Pre-Production <input type="checkbox"/> Engineering

### Test Facility / Accreditations

1. MRT facility is a FCC registered (Reg. No. 291082) test facility with the site description report on file and is designated by the FCC as an Accredited Test Firm.
2. MRT facility is an IC registered (MRT Reg. No. 21723) test laboratory with the site description on file at Industry Canada.
3. MRT Lab is accredited to ISO 17025 by the Taiwan Accreditation Foundation (TAF Cert. No. 3261) in EMC, Telecommunications and Radio testing for FCC (Designation Number: TW3261), Industry Taiwan, EU and TELEC Rules.

## 1. INTRODUCTION

### 1.1. Scope

Measurement and determination of electromagnetic emissions (EMC) of radio frequency devices including intentional and/or unintentional radiators for compliance with the technical rules and regulations of the Federal Communications Commission and the Industry Canada Certification and Engineering Bureau.

### 1.2. MRT Test Location

The map below shows the location of the MRT LABORATORY, its proximity to the Taoyuan City. These measurement tests were conducted at the MRT Technology (Taiwan) Co., Ltd. Facility located at No.38, Fuxing 2nd Rd., Guishan Dist., Taoyuan City 33377, Taiwan (R.O.C).

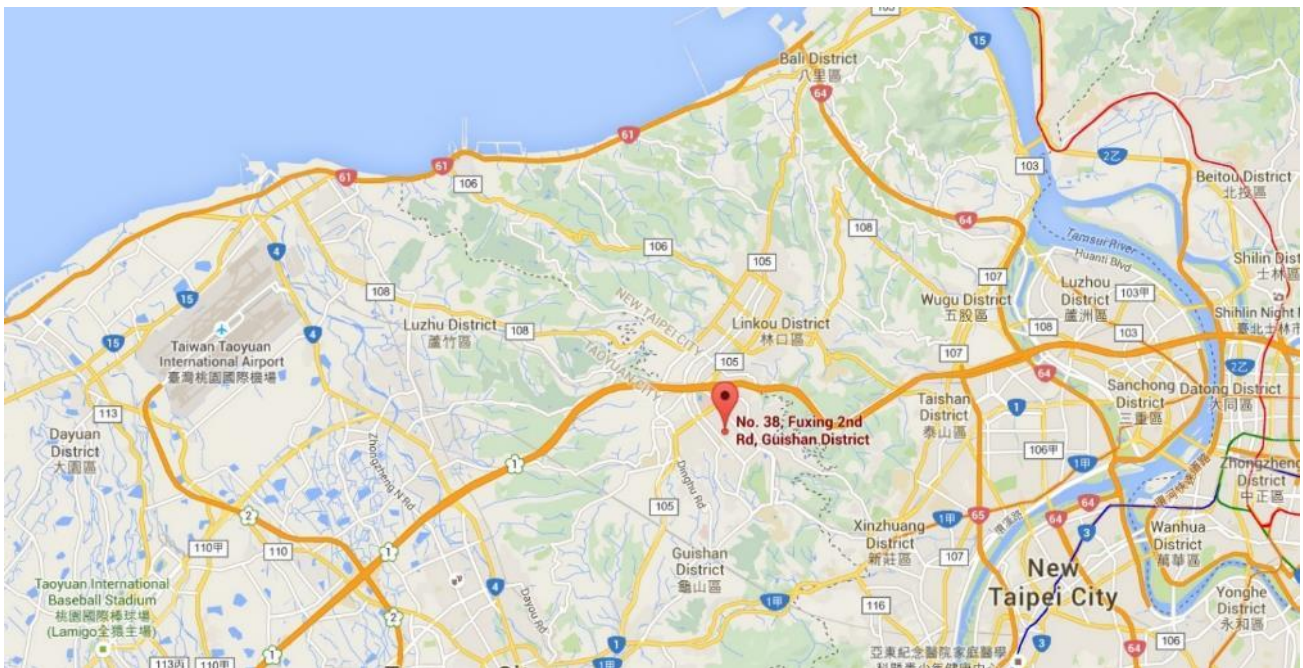

## 2. PRODUCT INFORMATION

### 2.1. Equipment Description

Product Name	NCSP3 Display Commander
Model No.	NCSP3DC
Brand Name	iN • Command
Supports Radios Spec.	2.4G: 802.11b/g/n-20 (1TX/1RX) Bluetooth Dual Mode: V4.2
Wi-Fi Specification	802.11a/b/g/n
Frequency Range	<b><u>2.4GHz:</u></b> For 802.11b/g/n-HT20: 2412 ~ 2462 MHz
2.4GHz Maximum Output Power	802.11b: 18.78dBm 802.11g: 24.13dBm 802.11n-HT20: 22.73dBm
Type of Modulation	802.11b: DSSS, DBPSK, DQPSK, CCK 802.11g/n-20M: OFDM, BPSK, QPSK, 16QAM, 64QAM
Operation Voltage	DC 12V, 1.5A

## 2.2. Working Frequencies for this Report

802.11b/g/n-20M

Channel	Frequency	Channel	Frequency	Channel	Frequency
01	2412 MHz	02	2417 MHz	03	2422 MHz
04	2427 MHz	05	2432 MHz	06	2437 MHz
07	2442 MHz	08	2447 MHz	09	2452 MHz
10	2457 MHz	11	2462 MHz	--	--

Duty Cycle

Test Mode	Duty Cycle
802.11b	100%
802.11g	98%
802.11 n-HT20	98%

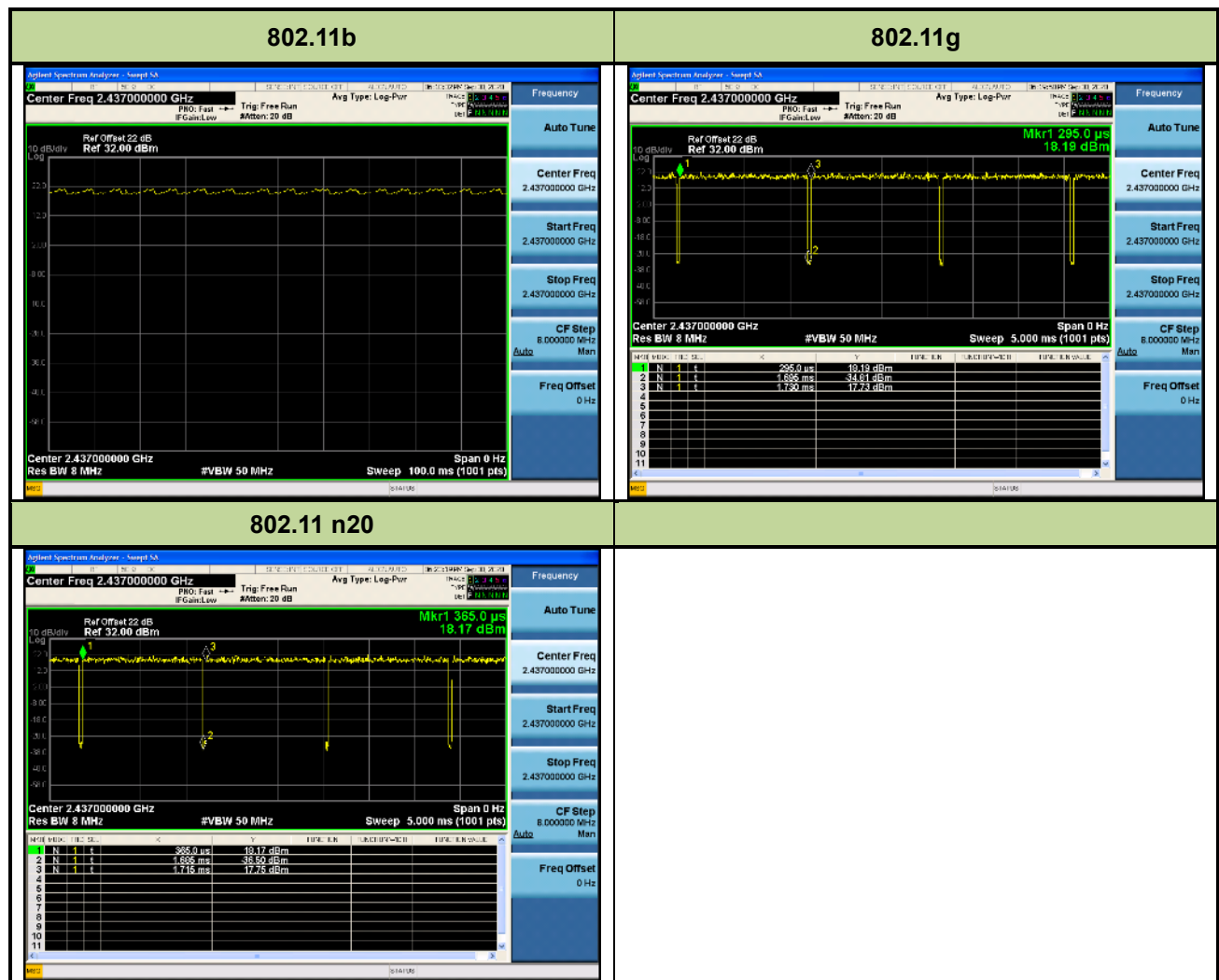



### 2.3. Test Mode

Test Mode	Mode 1: Transmit by 802.11b
	Mode 2: Transmit by 802.11g
	Mode 3: Transmit by 802.11n-20M

Note:

1. Regarding to the operation frequency, the lowest, middle and highest frequency are selected to perform the test.

### 2.4. Test Software

The test utility software used during testing was “Ampak”.

## **2.5. Test Configuration**

This device was tested per the guidance of ANSI C63.10-2013. ANSI C63.10-2013 was used to reference the appropriate EUT setup for radiated spurious emissions testing and AC line conducted testing.

## **2.6. EMI Suppression Device(s)/Modifications**

No EMI suppression device(s) were added and/or no modifications were made during testing.

## **2.7. Labeling Requirements**

Per 2.1074 & 15.19; Docket 95-19

The label shall be permanently affixed at a conspicuous location on the device; instruction manual or pamphlet supplied to the user and be readily visible to the purchaser at the time of purchase. However, when the device is so small wherein placement of the label with specified statement is not practical, only the FCC ID must be displayed on the device per Section 15.19(a)(5). Please see attachment for FCC ID label and label location.

### 3. DESCRIPTION of TEST

#### 3.1. Evaluation Procedure

The measurement procedures described in the American National Standard for Testing Unlicensed Wireless Devices (ANSI C63.10-2013), and the guidance provided in KDB 558074 D01v05r02 were used in the measurement of the device.

**Deviation from measurement procedure.....None**

#### 3.2. AC Line Conducted Emissions

The line-conducted facility is located inside an 9'x4'x3' shielded enclosure. A 1m x 2m wooden table 80cm high is placed 40cm away from the vertical wall and 80cm away from the sidewall of the shielded room. Two 10kHz-30MHz, 50Ω/50uH Line-Impedance Stabilization Networks (LISNs) are bonded to the shielded room floor. Power to the LISNs is filtered by external high-current high-insertion loss power line filters. These filters attenuate ambient signal noise from entering the measurement lines. These filters are also bonded to the shielded enclosure.

The EUT is powered from one LISN and the support equipment is powered from the second LISN. All interconnecting cables more than 1 meter were shortened to a 1 meter length by non-inductive bundling (serpentine fashion) and draped over the back edge of the test table. All cables were at least 40cm above the horizontal reference ground-plane. Power cables for support equipment were routed down to the second LISN while ensuring that that cables were not draped over the second LISN.

Sufficient time for the EUT, support equipment, and test equipment was allowed in order for them to warm up to their normal operating condition. The RF output of the LISN was connected to the receiver and exploratory measurements were made to determine the frequencies producing the maximum emission from the EUT. The receiver was scanned from 150kHz to 30MHz. The detector function was set to peak mode for exploratory measurements while the bandwidth of the analyzer was set to 9kHz. The EUT, support equipment, and interconnecting cables were arranged and manipulated to maximize each emission. Each emission was also maximized by varying: power lines, the mode of operation or data exchange speed, or support equipment which determined the worst-case emission. Once the worst case emissions have been identified, the one EUT cable configuration/arrangement and mode of operation that produced these emissions are used for final measurements on the same test site. The analyzer is set to CISPR quasi-peak and average detectors with a 9kHz resolution bandwidth for final measurements.

An extension cord was used to connect to a single LISN which powered by EUT. The extension cord was calibrated with LISN, the impedance and insertion loss are compliance with the requirements as stated in ANSI C63.10-2013.

Line conducted emissions test results are shown in Section 7.8.

### 3.3. Radiated Emissions

The radiated test facilities consisted of an indoor 3 meter semi-anechoic chamber used for final measurements and exploratory measurements, when necessary. The measurement area is contained within the semi-anechoic chamber which is shielded from any ambient interference. For measurements above 1GHz absorbers are arranged on the floor between the turn table and the antenna mast in such a way so as to maximize the reduction of reflections. For measurements below 1GHz, the absorbers are removed. A MF Model 210SS turntable is used for radiated measurement. It is a continuously rotatable, remote controlled, metallic turntable and 2 meters (6.56 ft.) in diameter. The turn table is flush with the raised floor of the chamber in order to maintain its function as a ground plane. An 80cm high PVC support structure is placed on top of the turntable. For all measurements, the spectrum was scanned through all EUT azimuths and from 1 to 4 meter receive antenna height using a broadband antenna from 30MHz up to the upper frequency shown in 15.33(b)(1) depending on the highest frequency generated or used in the device or on which the device operates or tunes. For frequencies above 1GHz, linearly polarized double ridge horn antennas were used. For frequencies below 30MHz, a calibrated loop antenna was used. When exploratory measurements were necessary, they were performed at 1 meter test distance inside the semi-anechoic chamber using broadband antennas, broadband amplifiers, and spectrum analyzers to determine the frequencies and modes producing the maximum emissions. Sufficient time for the EUT, support equipment, and test equipment was allowed in order for them to warm up to their normal operating condition. The test set-up for frequencies below 1GHz was placed on top of the 0.8 meter high, 1 x 1.5 meter table; and test set-up for frequencies 1-40GHz was placed on top of the 1.5 meter high, 1 x 1.5 meter table. The EUT, support equipment, and interconnecting cables were arranged and manipulated to maximize each emission. Appropriate precaution was taken to ensure that all emissions from the EUT were maximized and investigated. The system configuration, clock speed, mode of operation or video resolution, if applicable, turntable azimuth, and receive antenna height was noted for each frequency found.

Final measurements were made in the semi-anechoic chamber using calibrated, linearly polarized broadband and horn antennas. The test setup was configured to the setup that produced the worst case emissions. The spectrum analyzer was set to investigate all frequencies required for testing to compare the highest radiated disturbances with respect to the specified limits. The turntable containing the EUT was rotated through 360 degrees and the height of the receive antenna was varied 1 to 4 meters and stopped at the azimuth and height producing the maximum emission. Each emission was maximized by changing the orientation of the EUT through three orthogonal planes and changing the polarity of the receive antenna, which produced the worst-case emissions.

According to 3dB Beam-Width of horn antenna, the horn antenna should be always directed to the EUT when rising height.

Radiated emissions test results are shown in Section 7.6 & 7.7 .

## 4. ANTENNA REQUIREMENTS

### Excerpt from §15.203 of the FCC Rules/Regulations:

“An intentional radiator antenna shall be designed to ensure that no antenna other than that furnished by the responsible party can be used with the device. The use of a permanently attached antenna or of an antenna that uses a unique coupling to the intentional radiator shall be considered sufficient to comply with the provisions of this section.”

- The antenna of the **NCSP3 Display Commander**, is permanently attached.
- There are no provisions for connection to an external antenna.

### **Conclusion:**

The EUT unit complies with the requirement of §15.203.

### **Antenna List**

No.	Manufacturer	Part No.	Antenna Type	Peak Gain
1	Master Wave Technology Co.,Ltd	CL-1105-03-1R	PCB	4.6dBi

## 5. TEST EQUIPMENT CALIBRATION DATE

### Conducted Emissions – SR2

Instrument	Manufacturer	Type No.	Asset No.	Cali. Interval	Cali. Due Date
Two-Line V-Network	R&S	ENV216	MRTTWA00019	1 year	2021/3/26
Cable	Rosnol	N1C50-RG400- B1C50-500CM	MRTTWE00013	1 year	2021/6/21
EMI Test Receiver	R&S	ESR3	MRTTWA00009	1 year	2021/3/25

### Radiated Emissions – AC1

Instrument	Manufacturer	Type No.	Asset No.	Cali. Interval	Cali. Due Date
Broadband TRILOG Antenna	SCHWARZBECK	VULB 9162	MRTTWA00001	1 year	2020/11/4
EMI Test Receiver	R&S	ESR3	MRTTWA00009	1 year	2021/3/25
Active Loop Antenna	Schwarzbeck	FMZB 1519B	MRTTWA00002	1 year	2021/4/27
Broadband Horn antenna	SCHWARZBECK	BBHA 9120D	MRTTWA00003	1 year	2021/4/24
Breitband Hornantenna	Schwarzbeck	BBHA 9170	MRTTWA00004	1 year	2021/4/24
Broadband Amplifier	Schwarzbeck	BBV 9721	MRTTWA00006	1 year	2021/4/24
Broadband Preamplifier	SCHWARZBECK	BBV 9718	MRTTWA00005	1 year	2021/4/24
Cable	HUBERSUHNER	SF106	MRTTWE00010	1 year	2021/6/16
Cable	Rosnol	K1K50-UP0264- K1K50-4M	MRTTWE00012	1 year	2021/5/29

### Conducted Test Equipment – SR2

Instrument	Manufacturer	Type No.	Asset No.	Cali. Interval	Cali. Due Date
EXA Signal Analyzer	KEYSIGHT	N9010A	MRTTWA00012	1 year	2020/10/2
EXA Signal Analyzer	KEYSIGHT	N9010B	MRTTWA00074	1 year	2021/7/14
USB Wideband Power Sensor	KEYSIGHT	U2021XA	MRTTWA00015	1 year	2021/3/26

### Test Software

Software	Version	Function
e3	9.160520a	EMI Test Software
EMI	V3	EMI Test Software

## 6. MEASUREMENT UNCERTAINTY

Where relevant, the following test uncertainty levels have been estimated for tests performed on the EUT as specified in CISPR 16-4-2. This uncertainty represents an expanded uncertainty expressed at approximately the 95% confidence level using a coverage factor of  $k = 2$ .

<b>Conducted Emission- Power Line</b>
Measuring Uncertainty for a Level of Confidence of 95% ( $U=2Uc(y)$ ): 0.15MHz~30MHz: $\pm 2.53\text{dB}$
<b>Radiated Spurious Emission</b>
Measuring Uncertainty for a Level of Confidence of 95% ( $U=2Uc(y)$ ): 9kHz~30MHz: $\pm 3.92\text{dB}$ 30MHz~1GHz: $\pm 4.25\text{dB}$ 1GHz~18GHz: $\pm 4.40\text{dB}$ 18GHz~40GHz: $\pm 4.45\text{dB}$
<b>Frequency Error</b>
Measuring Uncertainty for a Level of Confidence of 95% ( $U=2Uc(y)$ ): $\pm 78.4\text{Hz}$
<b>Conducted Power</b>
Measuring Uncertainty for a Level of Confidence of 95% ( $U=2Uc(y)$ ): $\pm 0.84\text{dB}$
<b>Conducted Spurious Emission</b>
Measuring Uncertainty for a Level of Confidence of 95% ( $U=2Uc(y)$ ): $\pm 2.65\text{ dB}$
<b>Occupied Bandwidth</b>
Measuring Uncertainty for a Level of Confidence of 95% ( $U=2Uc(y)$ ): 3.3%
<b>Temp. / Humidity</b>
Measuring Uncertainty for a Level of Confidence of 95% ( $U=2Uc(y)$ ): $\pm 0.82^\circ\text{C} / \pm 3\%$
<b>DC Voltage</b>
Measuring Uncertainty for a Level of Confidence of 95% ( $U=2Uc(y)$ ): $\pm 0.3\%$

## 7. TEST RESULT

### 7.1. Summary

**Product Name:** NCSP3 Display Commander  
**FCC Classification:** (DTS) Digital Transmission System  
**Data Rate(s) Tested:** 1Mbps ~ 11Mbps (b); 6Mbps ~ 54Mbps (g);  
6.5/7.2Mbps ~ 130/144.4Mbps (n-20M);

FCC Part Section(s)	Test Description	Test Limit	Test Condition	Test Result	Reference
15.247(a)(2)	6dB Bandwidth	$\geq 500\text{kHz}$	Conducted	Pass	Section 7.2
15.247(b)(3)	Output Power	$\leq 30.00\text{dBm}$		Pass	Section 7.3
15.247(e)	Power Spectral Density	$\leq 8.00\text{dBm}/3\text{kHz}$		Pass	Section 7.4
15.247(d)	Out-of-Band Emissions	Conducted $\geq 20\text{dBc}$		Pass	Section 7.5
15.205 15.209	Spurious Emission	< FCC 15.209 limits	Radiated	Pass	Section 7.6
15.205 15.209	Band Edge Measurement	$\cong 74\text{dBuV/m(Peak)}$ $\cong 54\text{dBuV/m(Average)}$		Pass	Section 7.7
15.207	AC Conducted Emissions 150kHz - 30MHz	< FCC 15.207 limits	Line Conducted	N/A	Section 7.8

#### Notes:

- Determining compliance is based on the test results met the regulation limits or requirements declared by clients, and the test results don't take into account the value of measurement uncertainty.
- All modes of operation and data rates were investigated. For radiated emission test, every axis (X, Y, Z) was also verified. The test results shown in the following sections represent the worst case emissions.
- The analyzer plots shown in this section were all taken with a correction table loaded into the analyzer. The correction table was used to account for the losses of the cables and attenuators used as part of the system to connect the EUT to the analyzer at all frequencies of interest.
- All antenna port conducted emissions testing was performed on a test bench with the antenna port of the EUT connected to the spectrum analyzer through calibrated cables and attenuators.



## 7.2. 6dB Bandwidth Measurement

### 7.2.1. Test Limit

The minimum 6dB bandwidth shall be at least 500 kHz.

### 7.2.2. Test Procedure used

KDB 558074 D01v05r02- Section 8.2 Option 2

### 7.2.3. Test Setting

1. The Spectrum's automatic bandwidth measurement capability was used to perform the 6dB bandwidth measurement. The "X" dB bandwidth parameter was set to  $X = 6$ . The bandwidth measurement was not influenced by any intermediate power nulls in the fundamental emission.
2. Set RBW = 100 kHz
3. VBW  $\geq 3 \times$  RBW
4. Detector = Peak
5. Trace mode = max hold
6. Sweep = auto couple
7. Allow the trace was allowed to stabilize

### 7.2.4. Test Setup

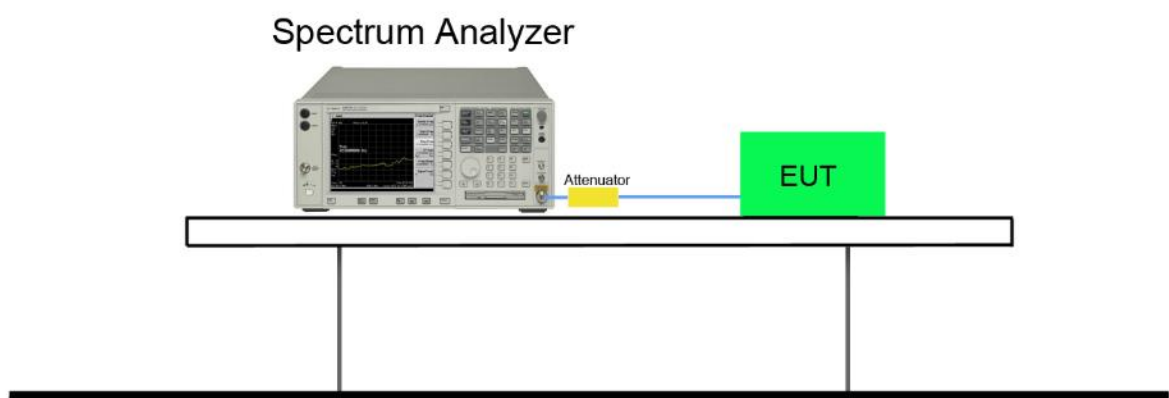

**7.2.5. Test Result**

Test Mode	Channel No.	Frequency (MHz)	6dB Bandwidth (MHz)	Limit (MHz)	Result
802.11b	01	2412	8.080	$\geq 0.5$	Pass
802.11b	06	2437	8.101	$\geq 0.5$	Pass
802.11b	11	2462	8.035	$\geq 0.5$	Pass
802.11g	01	2412	15.020	$\geq 0.5$	Pass
802.11g	06	2437	15.150	$\geq 0.5$	Pass
802.11g	11	2462	15.030	$\geq 0.5$	Pass
802.11n-20M	01	2412	15.120	$\geq 0.5$	Pass
802.11n-20M	06	2437	15.370	$\geq 0.5$	Pass
802.11n-20M	11	2462	15.130	$\geq 0.5$	Pass

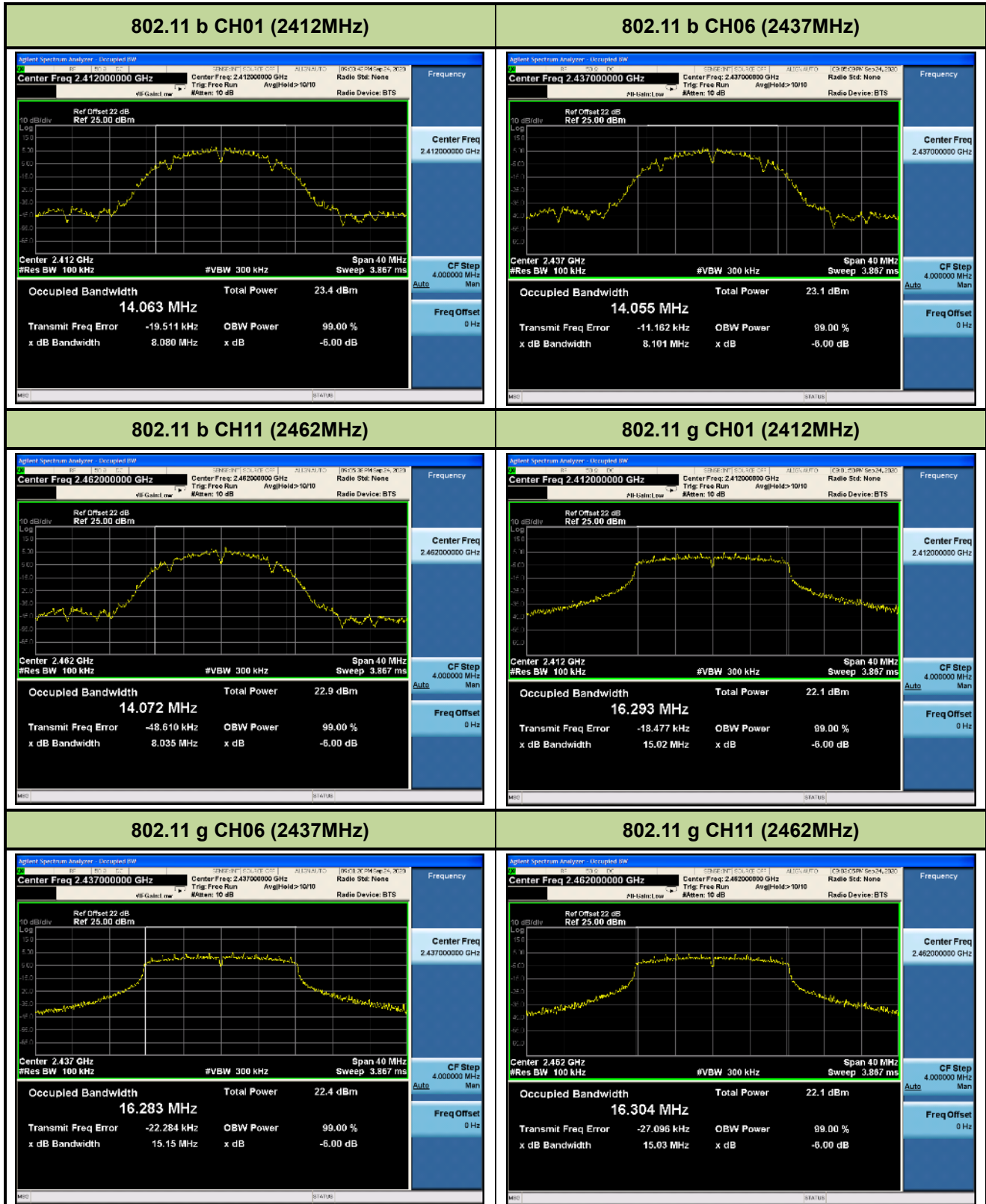

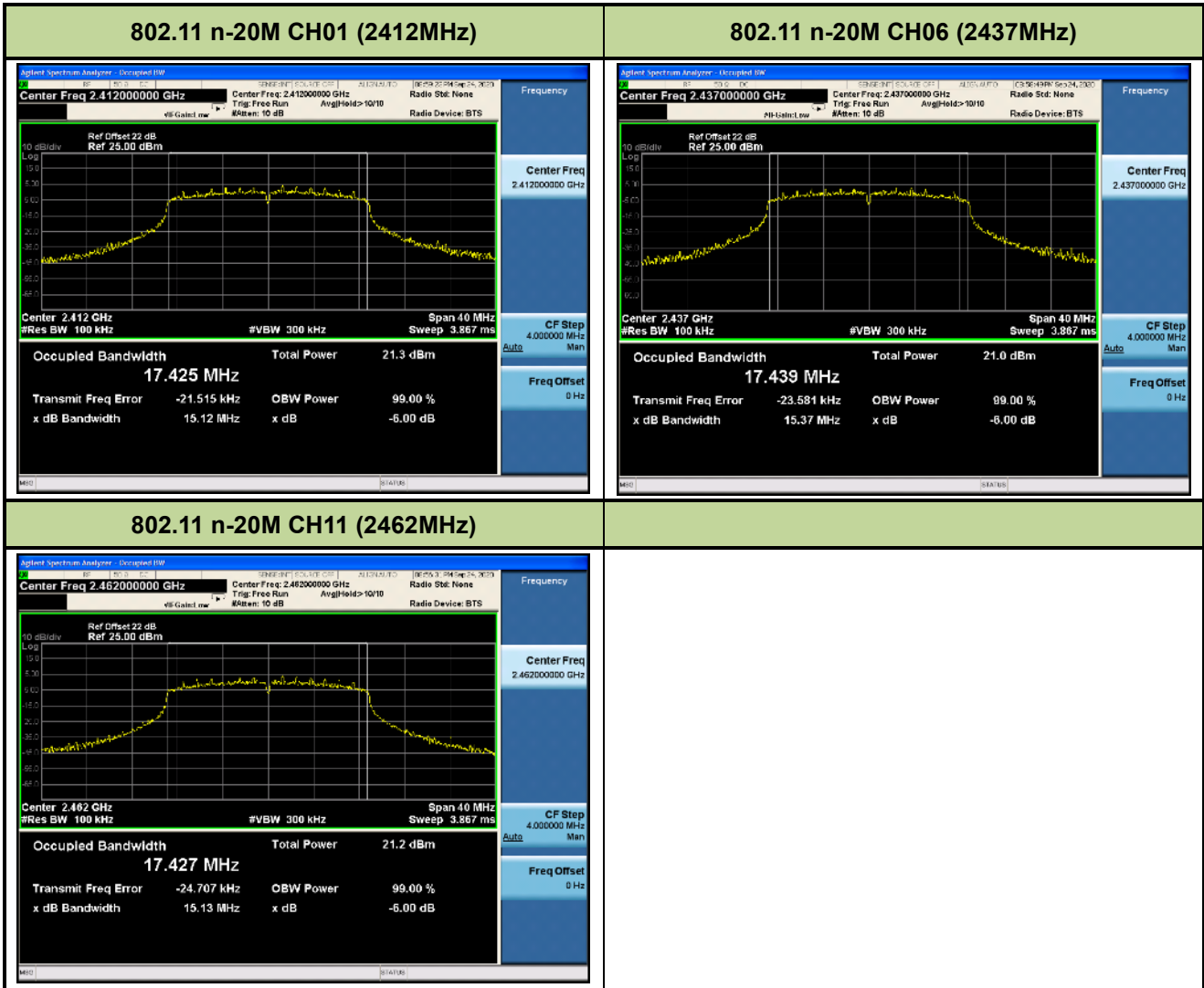

### 7.3. Output Power Measurement

#### 7.3.1. Test Limit

The maximum out power shall be less 1 Watt (30dBm).

#### 7.3.2. Test Procedure Used

KDB 558074 D01v05r02 - Section 9.1.2 & 9.2.3.2

#### 7.3.3. Test Setting

##### Peak Power Measurement

The maximum peak conducted output power may be measured using a broadband peak RF power meter. The power meter shall have a video bandwidth that is greater than or equal to the DTS bandwidth and shall utilize a fast-responding diode detector.

##### Average Power Measurement

Average power measurements were performed only when the EUT was transmitting at its maximum power control level using a broadband power meter with a pulse sensor. The power meter implemented triggering and gating capabilities which were set up such that power measurements were recorded only during the ON time of the transmitter. The trace was averaged over 100 traces to obtain the final measured average power.

#### 7.3.4. Test Setup

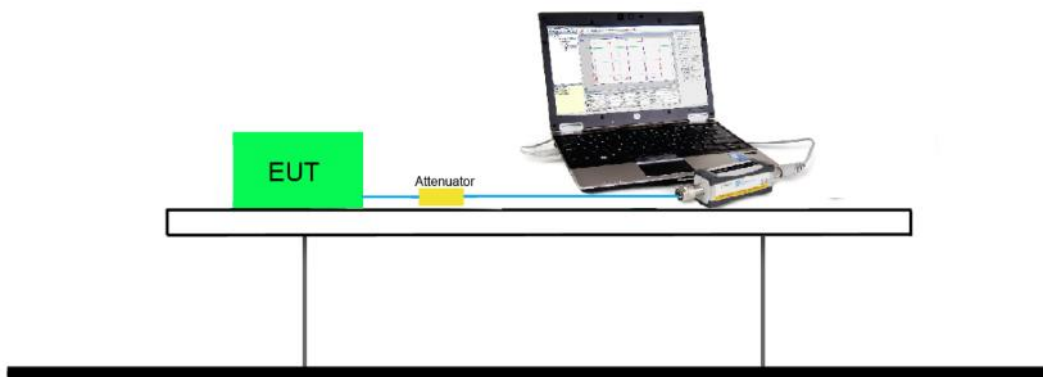

**7.3.5. Test Result of Output Power**

<b>2.4GHz 802.11b RF Output Power (dBm)</b>											
Channel No.	Frequency (MHz)	Average Power For different Data Rate (Mbps)				Peak Power	Required Limit				
		1	2	5.5	11						
01	2412	15.98	--	--	--	18.50	1Watt= 30 dBm				
06	2437	16.20	16.18	16.16	16.14	18.52	1Watt= 30 dBm				
11	2462	16.32	--	--	--	18.78	1Watt= 30 dBm				
<b>2.4GHz 802.11g RF Output Power (dBm)</b>											
Channel No.	Frequency (MHz)	Average Power For different Data Rate (Mbps)								Peak Power	Required Limit
		6	9	12	18	24	36	48	54		
01	2412	14.98	--	--	--	--	--	--	--	23.69	1Watt= 30 dBm
06	2437	15.20	15.19	15.18	15.17	15.16	14.95	14.70	14.45	24.13	1Watt= 30 dBm
11	2462	15.26	--	--	--	--	--	--	--	23.85	1Watt= 30 dBm
<b>2.4GHz 802.11n-20M RF Output Power (dBm)</b>											
Channel No.	Frequency (MHz)	Average Power For different Data Rate (Mbps)								Peak Power	Required Limit
		MCS0	MCS1	MCS2	MCS3	MCS4	MCS5	MCS6	MCS7		
01	2412	14.04	--	--	--	--	--	--	--	22.73	1Watt= 30 dBm
06	2437	14.25	14.19	14.08	13.94	13.85	13.65	13.47	13.39	22.68	1Watt= 30 dBm
11	2462	14.04	--	--	--	--	--	--	--	21.96	1Watt= 30 dBm

Note: Output power = Reading value on power meter + duty cycle factor + cable loss ◦

## 7.4. Power Spectral Density Measurement

### 7.4.1. Test Limit

The maximum permissible power spectral density is 8dBm in any 3 kHz band.

### 7.4.2. Test Procedure Used

KDB 558074 D01v05r02 - Section 10.2 Method PKPSD

### 7.4.3. Test Setting

This procedure shall be used if maximum peak conducted output power was used to demonstrate compliance, and is optional if the maximum conducted (average) output power was used to demonstrate compliance.

- a) Set analyzer center frequency to DTS channel center frequency.
- b) Set the span to 1.5 times the DTS bandwidth.
- c) Set the RBW to: 3 kHz.
- d) Set the VBW  $\geq 3 \times$  RBW.
- e) Detector = peak.
- f) Sweep time = auto couple.
- g) Trace mode = max hold.
- h) Allow trace to fully stabilize.
- i) Use the peak marker function to determine the maximum amplitude level within the RBW.

### 7.4.4. Test Setup

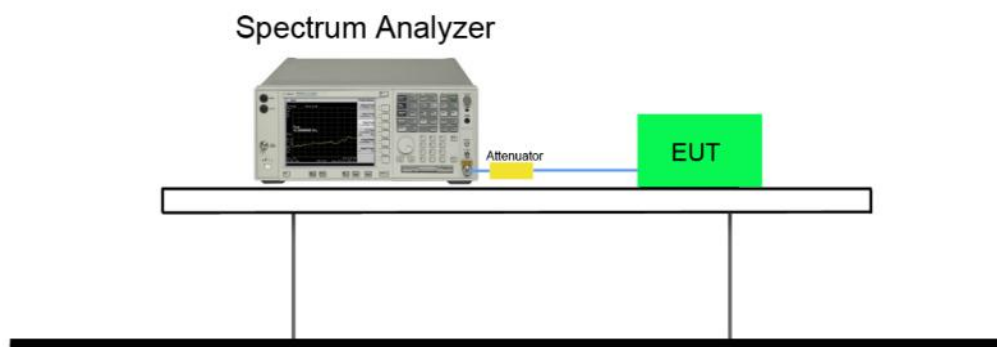

**7.4.5. Test Result**

Test Mode	Channel No.	Freq. (MHz)	PSD (dBm)	Limit (dBm)	Result
11b	1	2412	-5.068	≤ 8	Pass
11b	6	2437	-6.129	≤ 8	Pass
11b	11	2462	-4.592	≤ 8	Pass
11g	1	2412	-9.579	≤ 8	Pass
11g	6	2437	-8.929	≤ 8	Pass
11g	11	2462	-8.905	≤ 8	Pass
11n-20M	1	2412	-9.869	≤ 8	Pass
11n-20M	6	2437	-10.031	≤ 8	Pass
11n-20M	11	2462	-9.762	≤ 8	Pass



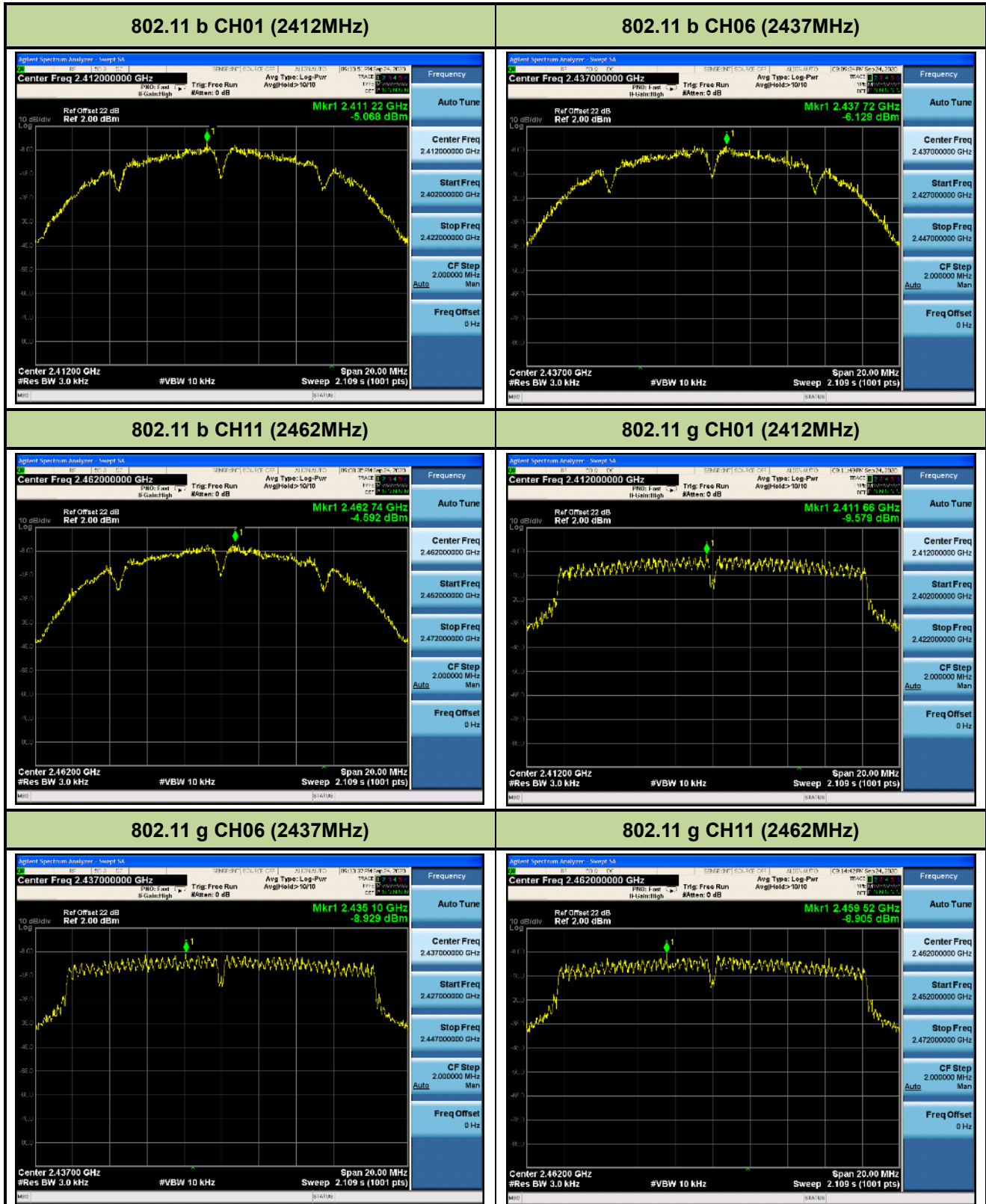

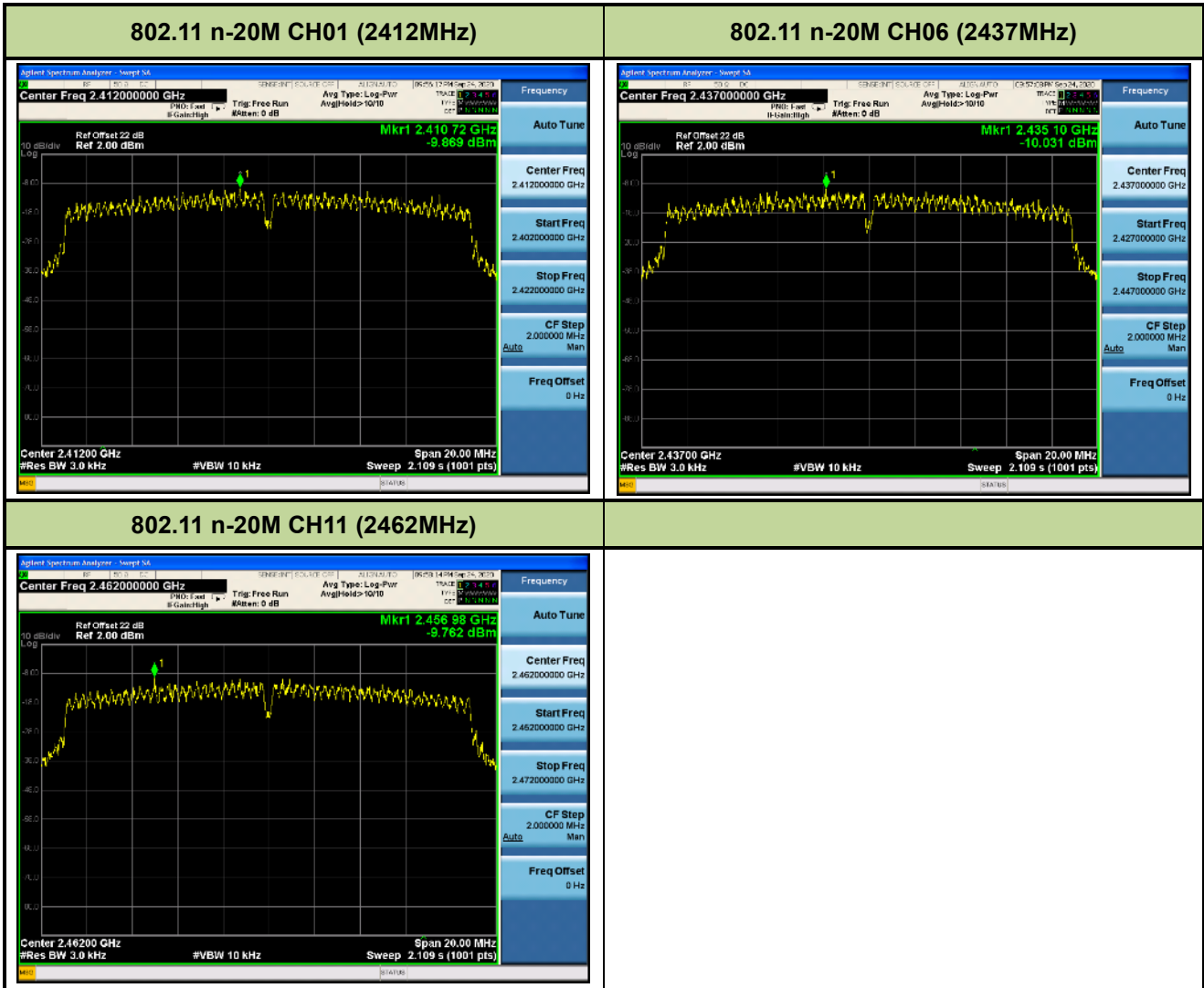

## 7.5. Out-of-Band Spurious Emissions Emissions Measurement

### 7.5.1. Test Limit

In any 100 kHz bandwidth outside the frequency band in which the spread spectrum or digitally modulated intentional radiator is operating, the radio frequency power that is produced by the intentional radiator shall be at least 20 dB below that in the 100 kHz bandwidth within the band that contains the highest level of the desired power, based on RF conducted measurement, provided the transmitter demonstrates compliance with the peak conducted power limits.

### 7.5.2. Test Procedure Used

KDB 558074 D01v05r02- Section 11.1 & 11.2

### 7.5.3. Test Setting

- (a) Set instrument center frequency to DTS channel center frequency
- (b) Set the span to  $\geq 1.5$  times the DTS bandwidth
- (c) Set the RBW = 100 kHz
- (d) Set the VBW  $\geq 3 \times$  RBW
- (e) Detector = peak
- (f) Sweep time = auto couple
- (g) Trace mode = max hold
- (h) Allow trace to fully stabilize

### 7.5.4. Test Setup

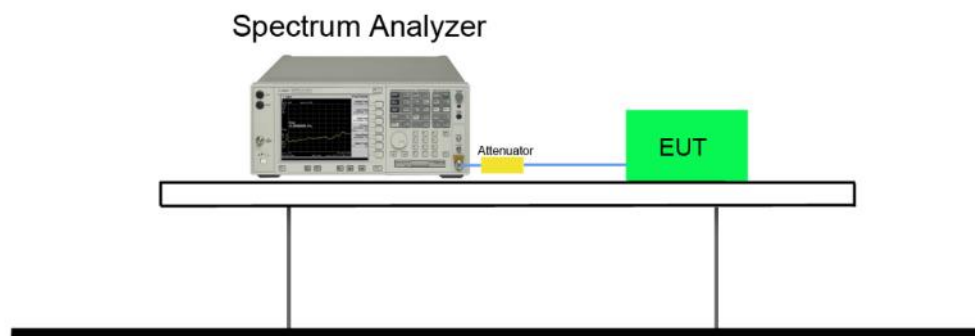

**7.5.5. Test Result**

Test Mode	Channel No.	Frequency (MHz)	Limit	Result
802.11b	01	2412	20dBc	Pass
802.11b	06	2437	20dBc	Pass
802.11b	11	2462	20dBc	Pass
802.11g	01	2412	20dBc	Pass
802.11g	06	2437	20dBc	Pass
802.11g	11	2462	20dBc	Pass
802.11n-20M	01	2412	20dBc	Pass
802.11n-20M	06	2437	20dBc	Pass
802.11n-20M	11	2462	20dBc	Pass

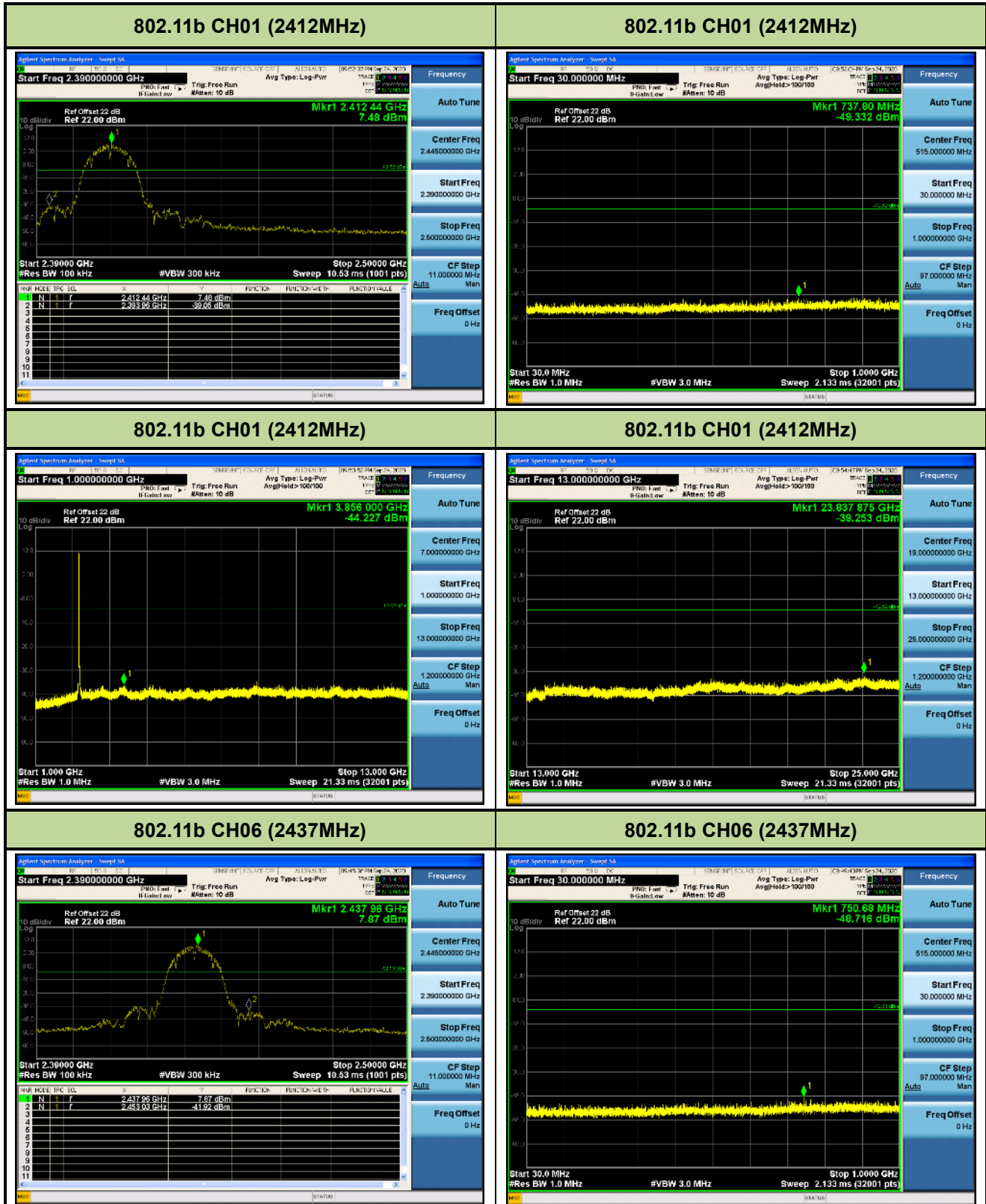

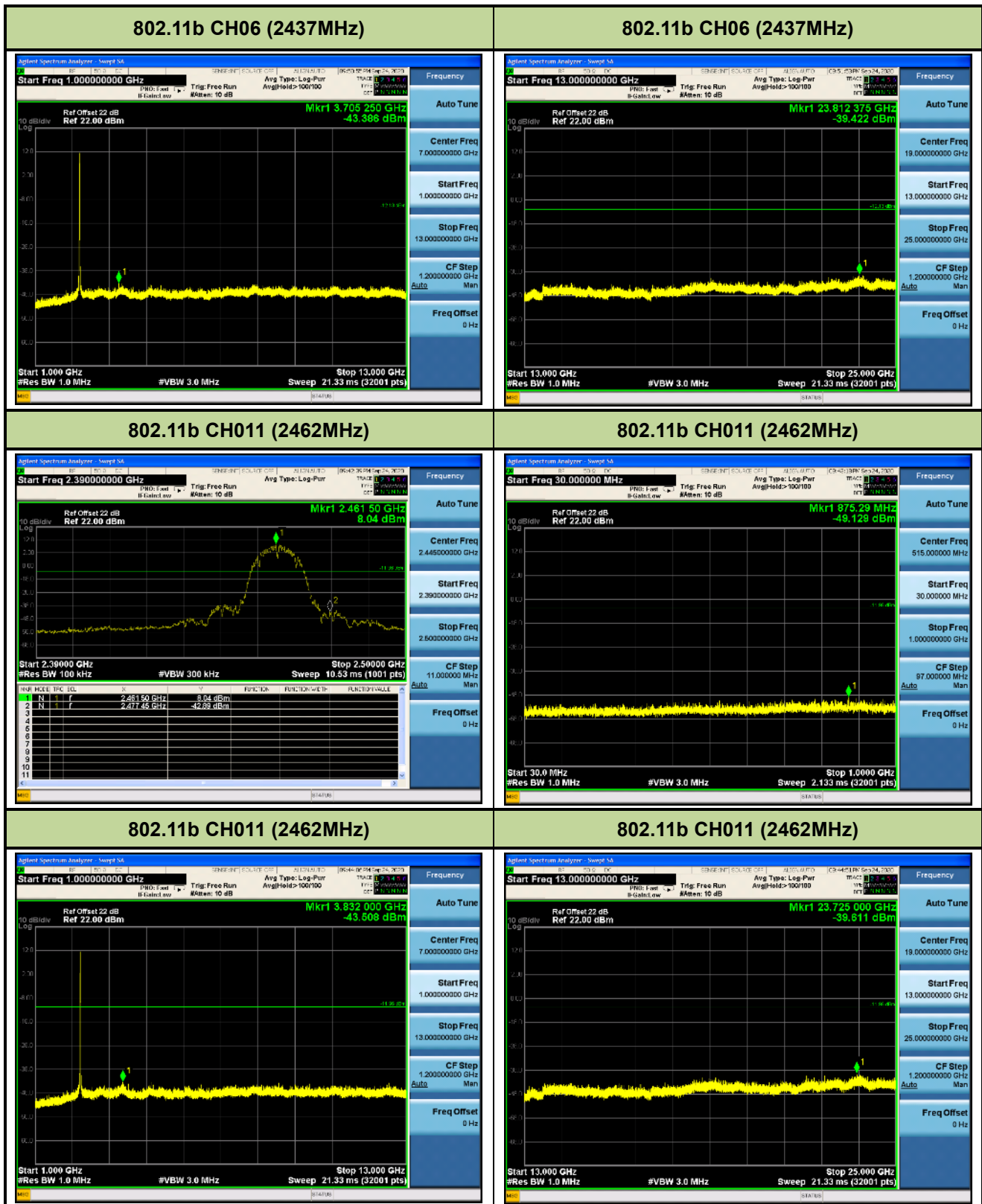

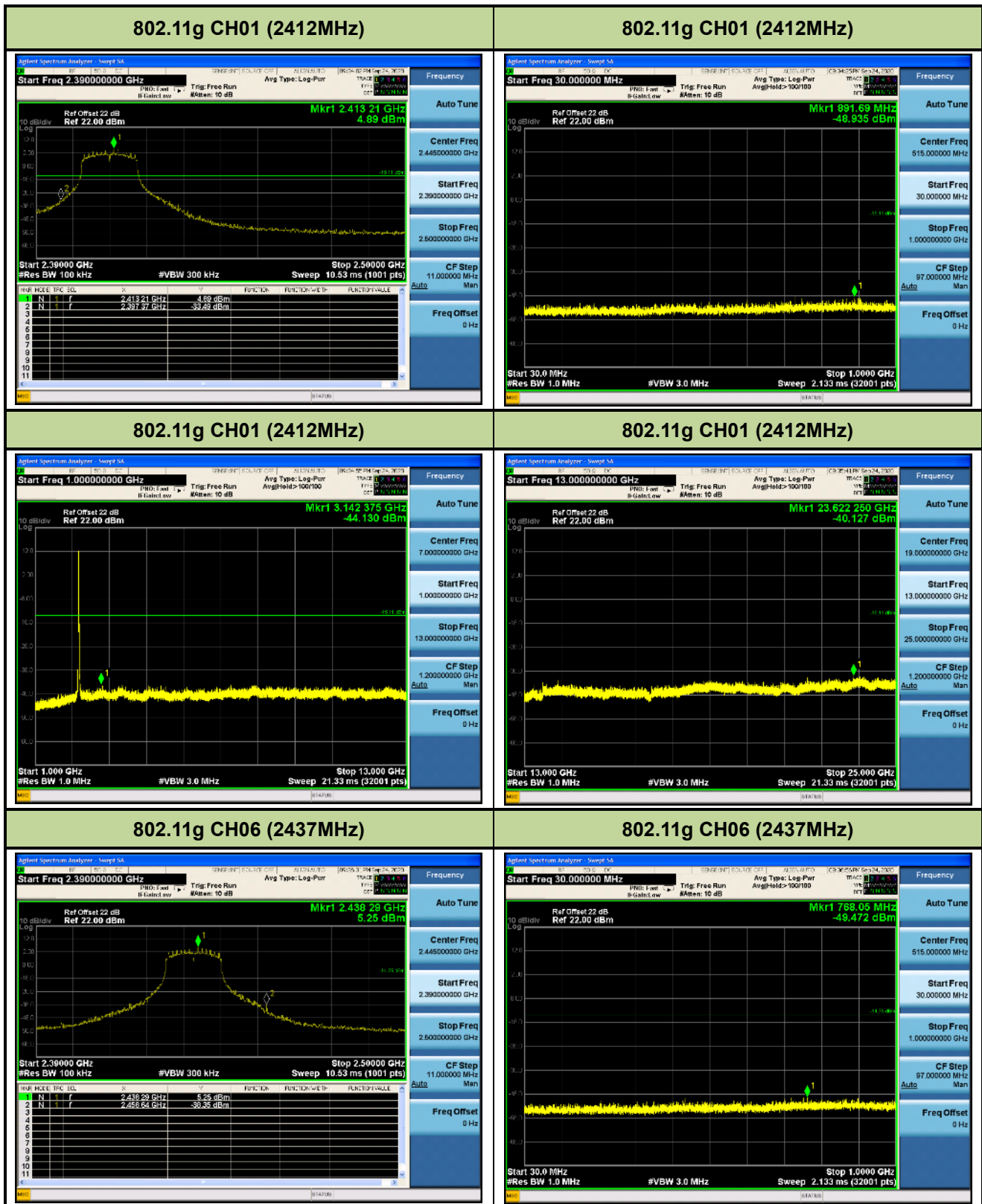

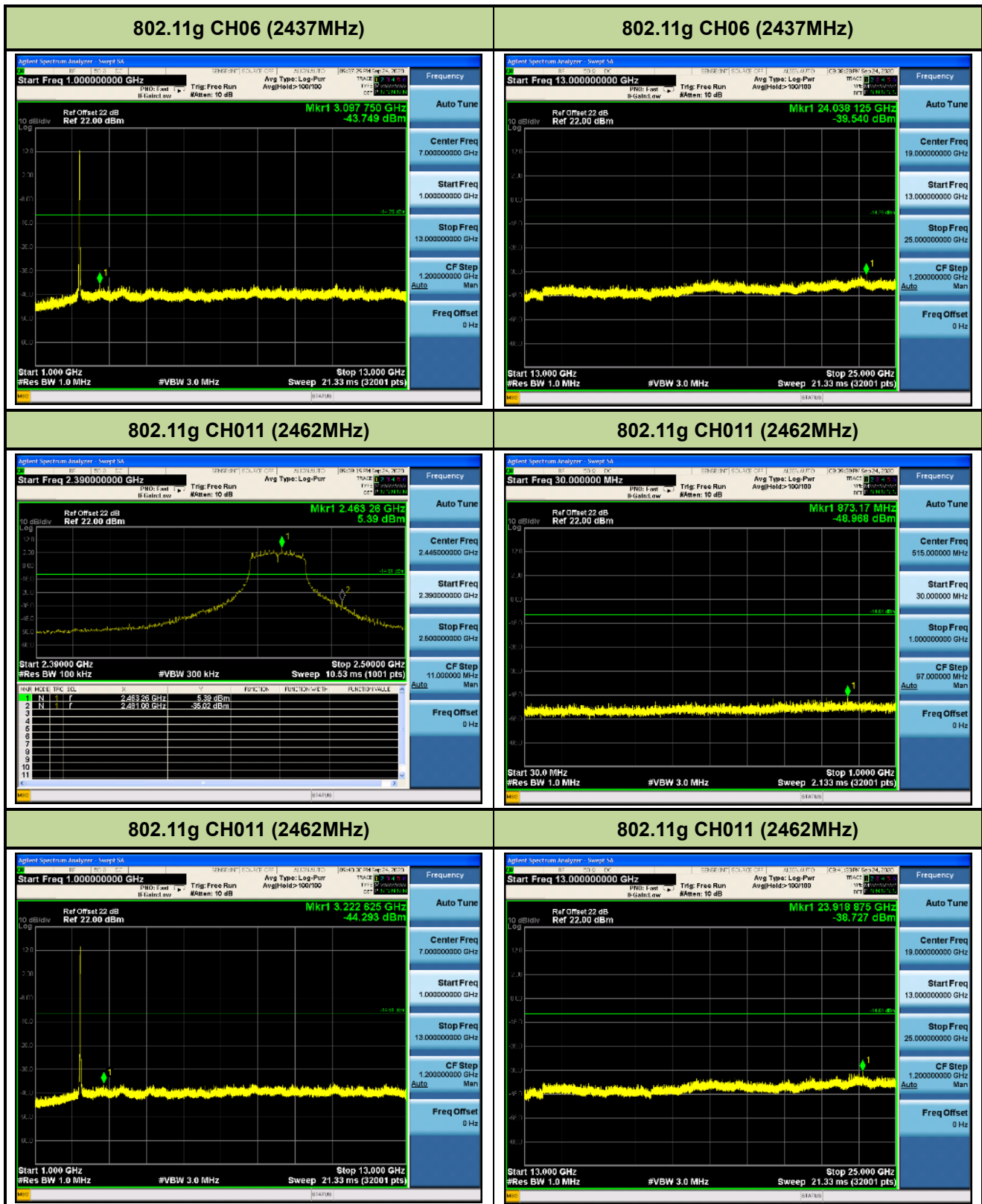



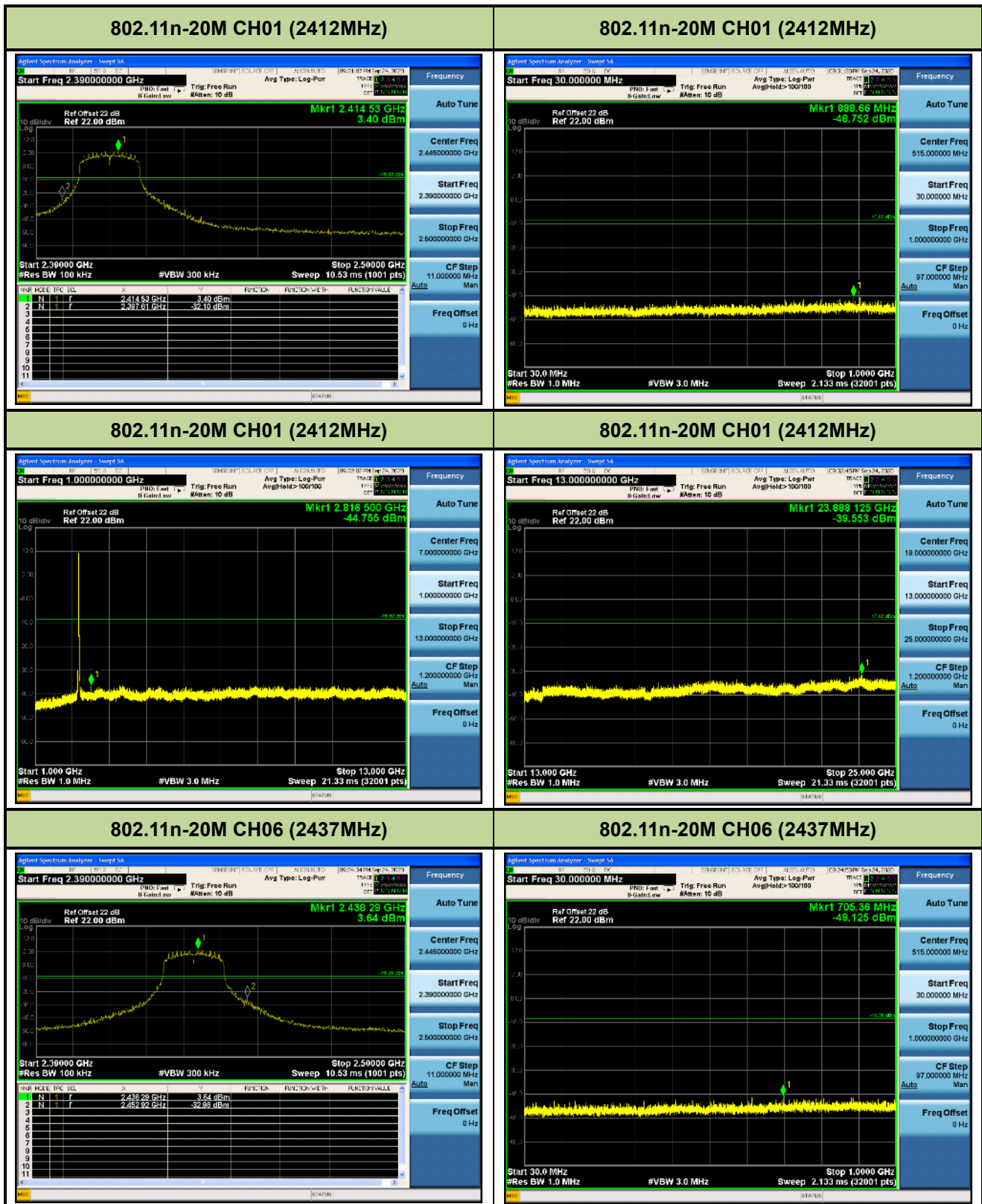

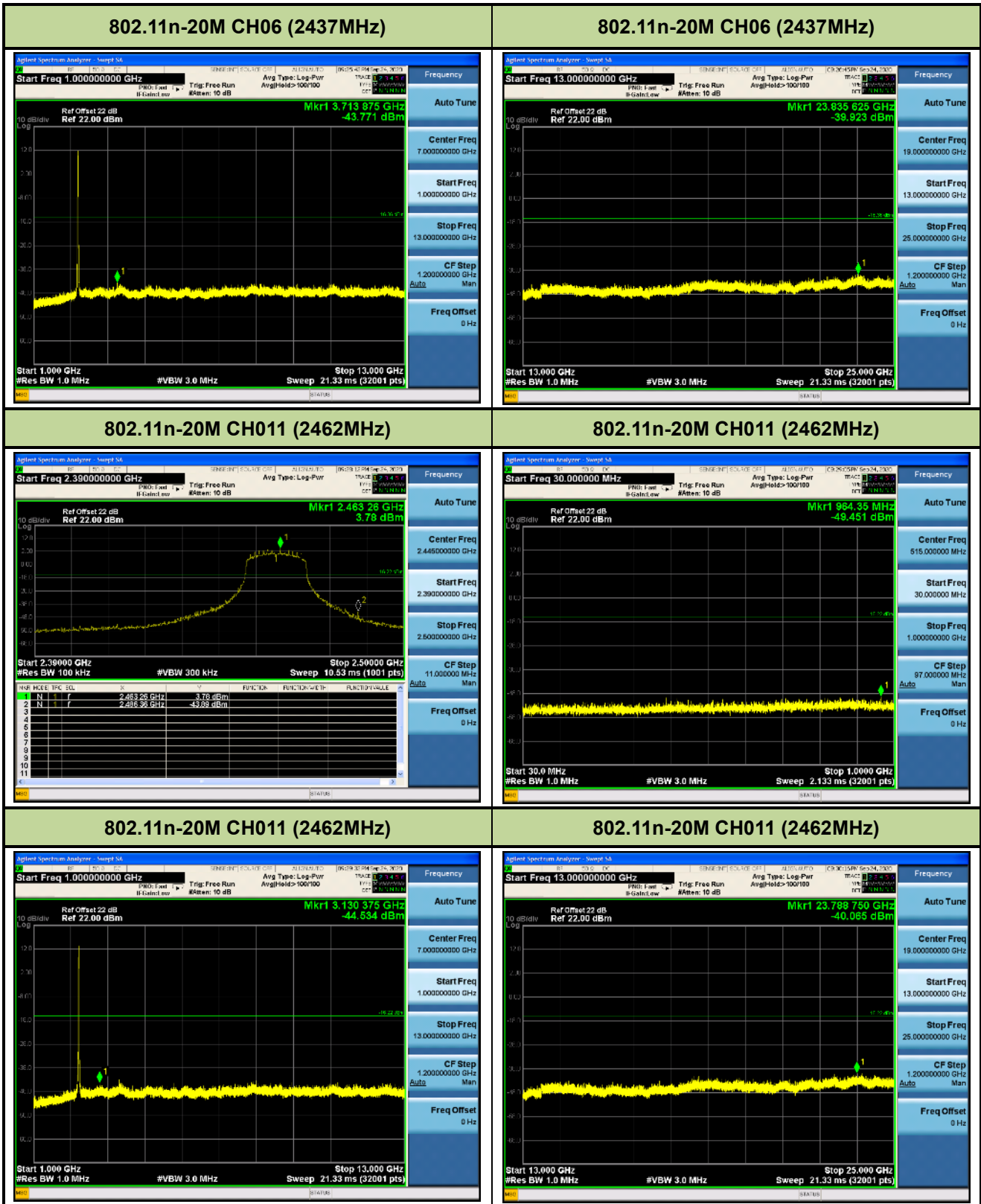

## 7.6. Radiated Spurious Emission Measurement

### 7.6.1. Test Limit

All out of band emissions appearing in a restricted band as specified in Section 15.205 of the Title 47 CFR must not exceed the limits shown in Table per Section 15.209.

FCC Part 15 Subpart C Paragraph 15.209		
Frequency [MHz]	Field Strength [V/m]	Measured Distance [Meters]
0.009 - 0.490	2400/F (kHz)	300
0.490 - 1.705	24000/F (kHz)	30
1.705 - 30	30	30
30 - 88	100	3
88 - 216	150	3
216 - 960	200	3
Above 960	500	3

### 7.6.2. Test Procedure Used

KDB 558074 D01v05r02- Section 12.2.3 (quasi-peak measurements)

KDB 558074 D01v05r02- Section 12.2.4 (peak power measurements)

KDB 558074 D01v05r02- Section 12.2.5 (average power measurements)

### 7.6.3. Test Setting

#### Peak Field Strength Measurements

1. Analyzer center frequency was set to the frequency of the radiated spurious emission of interest
2. RBW = as specified in Table 1
3. VBW = 3MHz
4. Detector = peak
5. Sweep time = auto couple

6. Trace mode = max hold

7. Trace was allowed to stabilize

**Table 1 - RBW as a function of frequency**

Frequency	RBW
9 ~ 150 kHz	200 ~ 300 Hz
0.15 ~ 30 MHz	9 ~ 10 kHz
30 ~ 1000 MHz	100 ~ 120 kHz
> 1000 MHz	1 MHz

**Average Field Strength Measurements**

1. Analyzer center frequency was set to the frequency of the radiated spurious emission of interest

2. RBW = 1MHz

3. VBW  $\geq$  1/T

4. De As an alternative, the instrument may be set to linear detector mode. Ensure that video filtering is applied in linear voltage domain (rather than in a log or dB domain). Some instruments require linear display mode in order to accomplish this. Others have a setting for Average-VBW Type, which can be set to "Voltage" regardless of the display mode

5. Detector = Peak

6. Sweep time = auto

7. Trace mode = max hold

8. Allow max hold to run for at least 50 times (1/duty cycle) traces

#### 7.6.4. Test Setup

##### 9kHz ~ 30MHz Test Setup:

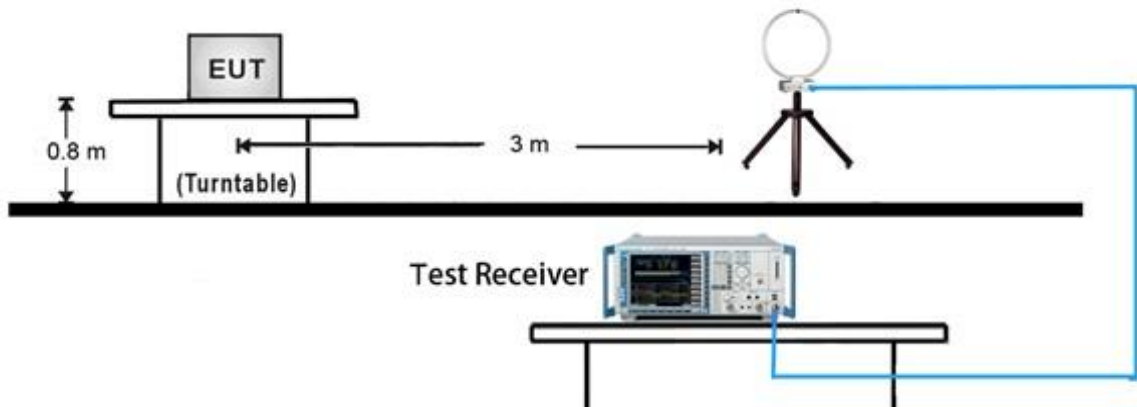

##### 30MHz ~ 1GHz Test Setup:

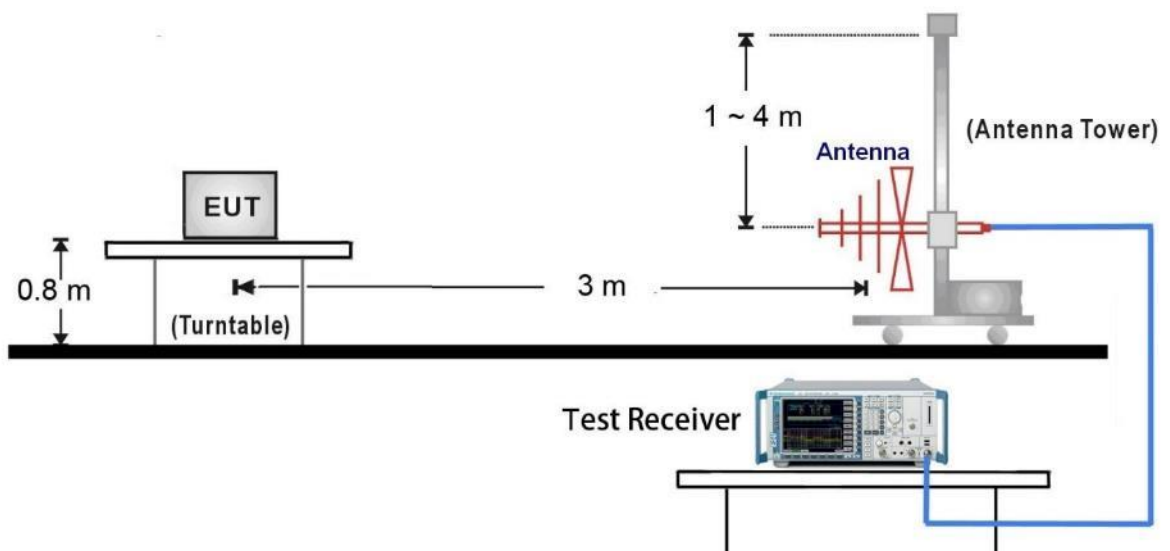

1GHz ~ 18GHz Test Setup:

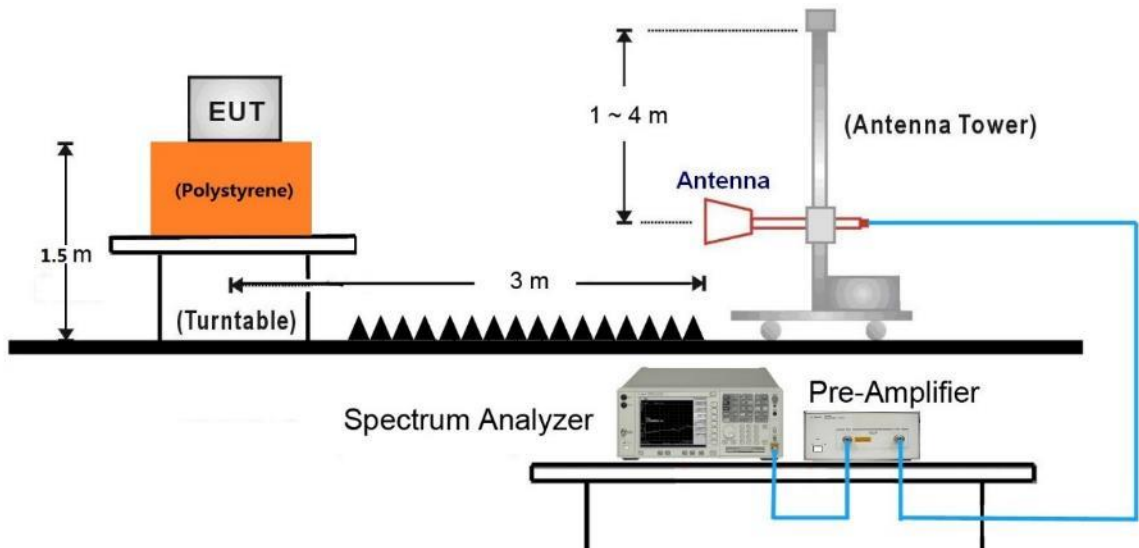

18GHz ~ 25GHz Test Setup:

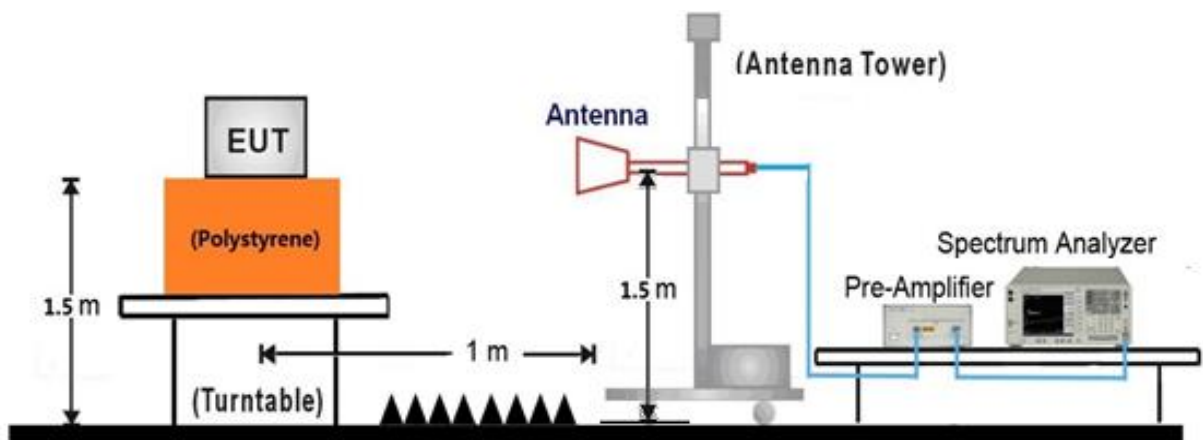

**7.6.5. Test Result**

EUT	NCSP3DC	Date of Test	2020-09-14
Factor	VULB 9162	Temp. / Humidity	25°C /55%
Polarity	Horizontal	Site / Test Engineer	AC1 / Jay
Test Mode	802.11n-20MHz_TX_CH 6_ANT 0	Test Voltage	DC 12V

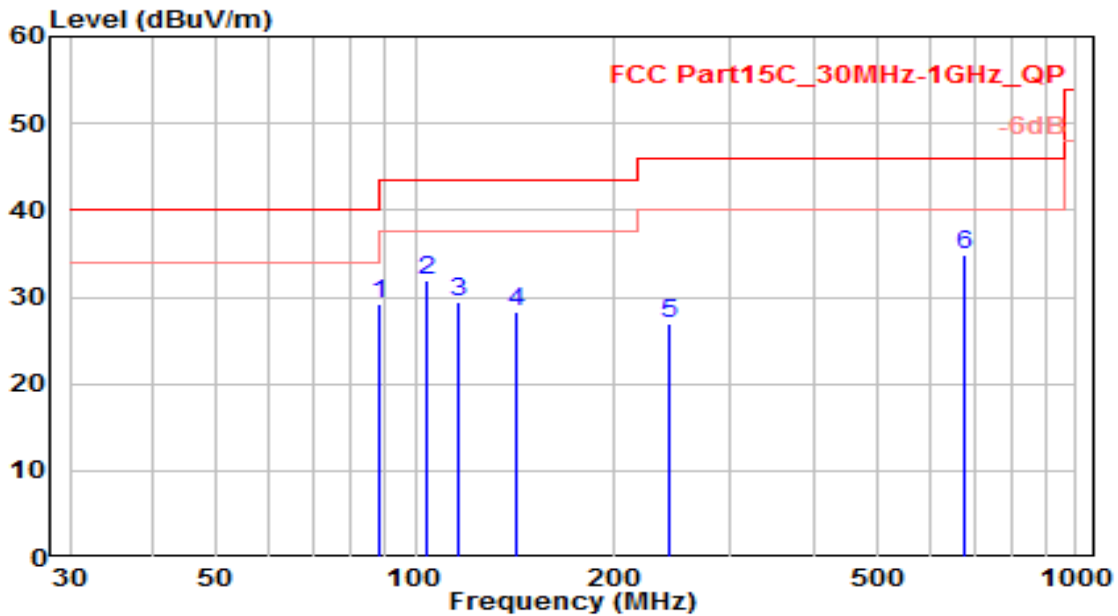

No	Frequency (MHz)	Reading (dBUV)	C.F (dB)	Measurement (dBUV/m)	Margin (dB)	Limit (dBUV/m)	Height (cm)	Angle (deg)	Remark (QP/PK/AV)
1	88.200	12.83	16.46	29.29	-14.21	43.50	100	110	QP
2	103.720	12.64	19.32	31.96	-11.54	43.50	100	250	QP
3	116.330	11.89	17.59	29.48	-14.02	43.50	100	280	QP
4	142.520	12.75	15.52	28.26	-15.24	43.50	100	365	QP
5	242.430	6.57	20.28	26.85	-19.15	46.00	100	20	QP
6	* 678.930	5.96	28.84	34.80	-11.20	46.00	100	0	QP

Note:

1. " \*", means this data is the worst emission level.
2. C.F (Correction Factor) = Antenna Factor (dB)+ Cable Loss (dB).
3. Measurement (dBUV/m) = Reading(dBUV) + C.F (Correction Factor).
4. The emission levels of other frequencies are very lower than the limit and not show in test report.

EUT	NCSP3DC	Date of Test	2020-09-14
Factor	VULB 9162	Temp. / Humidity	25°C /55%
Polarity	Vertical	Site / Test Engineer	AC1 / Jay
Test Mode	802.11n-20MHz_TX_CH 6_ANT 0	Test Voltage	DC 12V

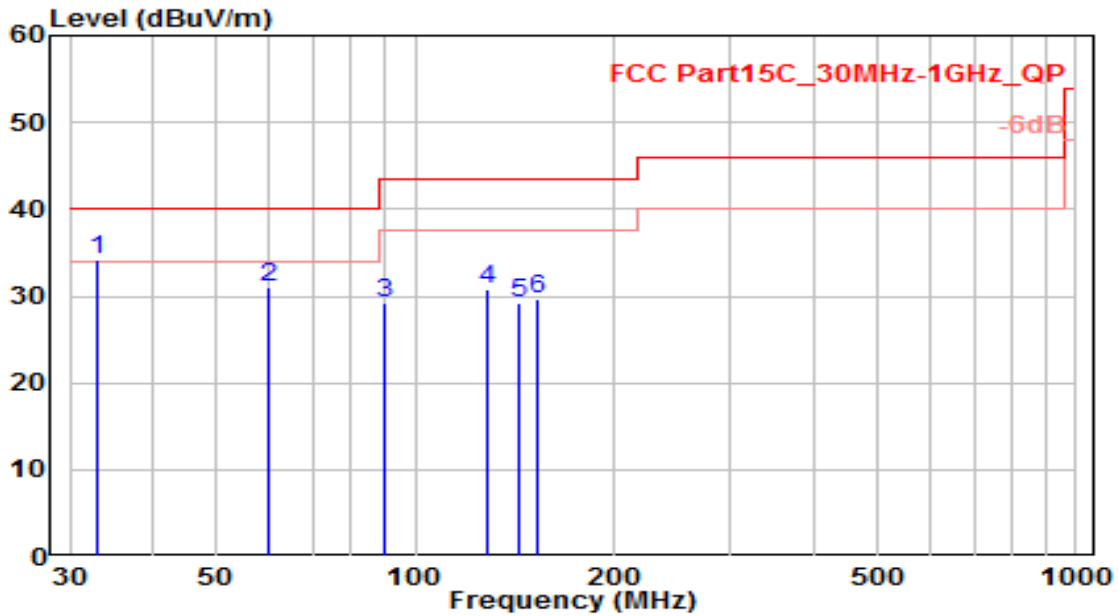

No	Frequency (MHz)	Reading (dBuV)	C.F (dB)	Measurement (dBuV/m)	Margin (dB)	Limit (dBuV/m)	Height (cm)	Angle (deg)	Remark (QP/PK/AV)
1	* 32.910	15.49	18.59	34.08	-5.92	40.00	100	0	QP
2	60.070	10.91	20.08	30.99	-9.01	40.00	100	100	QP
3	90.140	12.21	17.03	29.24	-14.26	43.50	100	225	QP
4	128.940	14.64	16.09	30.73	-12.77	43.50	100	360	QP
5	143.490	13.68	15.55	29.23	-14.27	43.50	100	280	QP
6	153.190	13.67	15.89	29.56	-13.94	43.50	100	95	QP

Note:

- "\*" means this data is the worst emission level.
- C.F (Correction Factor) = Antenna Factor (dB)+ Cable Loss (dB).
- Measurement (dBuV/m) = Reading(dBuV) + C.F (Correction Factor).
- The emission levels of other frequencies are very lower than the limit and not show in test report.



EUT	NCSP3DC	Date of Test	2020-09-24
Factor	BBHA 9120D & BBHA 9170	Temp. / Humidity	25°C /55%
Polarity	Horizontal	Site / Test Engineer	AC1 / Jay
Test Mode	802.11b_TX_CH 1_ANT 0	Test Voltage	DC 12V

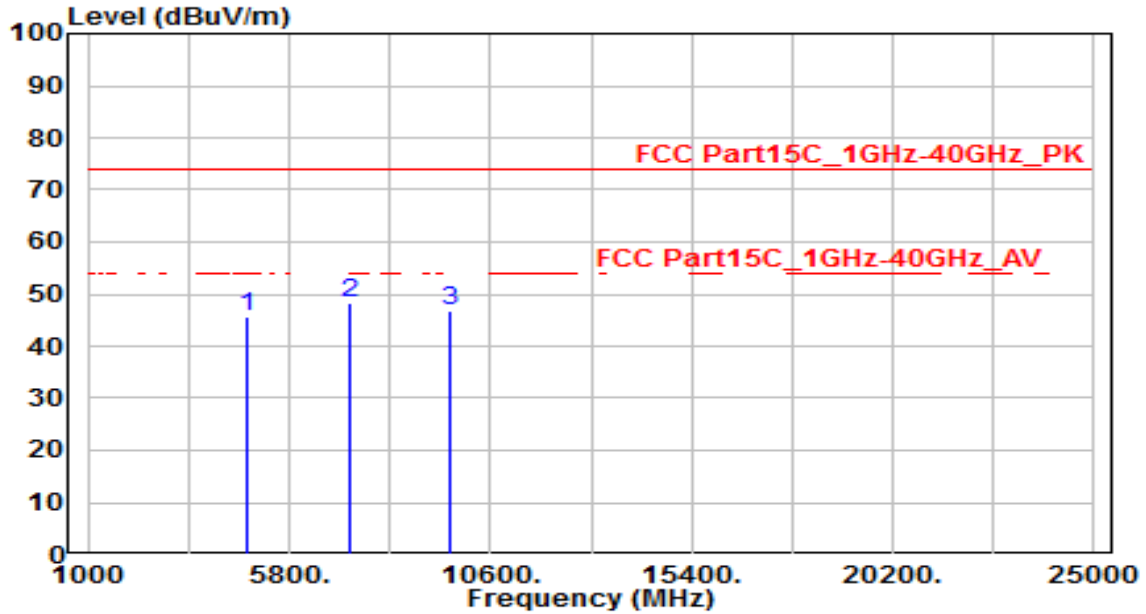

No	Frequency (MHz)	Reading (dBuV)	C.F (dB)	Measurement (dBuV/m)	Margin (dB)	Limit (dBuV/m)	Height (cm)	Angle (deg)	Remark (QP/PK/AV)
1	4824.000	42.21	3.33	45.54	-28.46	74.00	150	400	Peak
2	* 7236.000	37.30	10.97	48.27	-25.73	74.00	150	400	Peak
3	9648.000	31.93	14.70	46.63	-27.37	74.00	150	400	Peak

Note:

1. " \*", means this data is the worst emission level.
2. C.F (Correction Factor) = Antenna Factor (dB)+ Cable Loss (dB) – Pre-amplifier(dB).
3. Measurement (dBuV/m) = Reading(dBuV) + C.F (Correction Factor).
4. The emission levels of other frequencies are very lower than the limit and not show in test report.

EUT	NCSP3DC	Date of Test	2020-09-24
Factor	BBHA 9120D & BBHA 9170	Temp. / Humidity	25°C /55%
Polarity	Vertical	Site / Test Engineer	AC1 / Jay
Test Mode	802.11b_TX_CH 1_ANT 0	Test Voltage	DC 12V

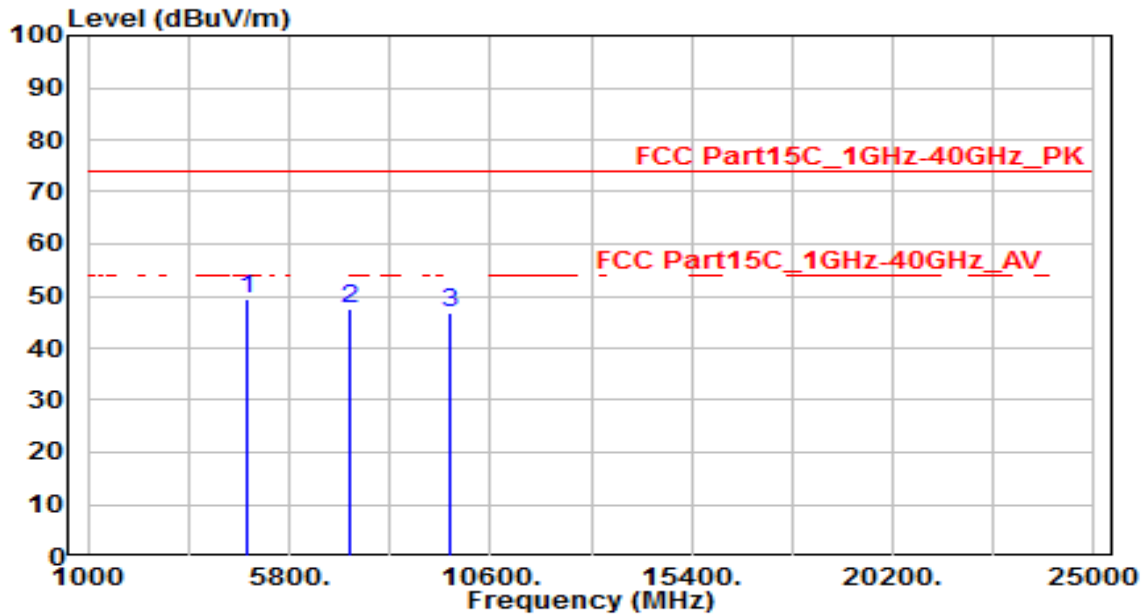

No	Frequency (MHz)	Reading (dBuV)	C.F (dB)	Measurement (dBuV/m)	Margin (dB)	Limit (dBuV/m)	Height (cm)	Angle (deg)	Remark (QP/PK/AV)
1	* 4824.000	46.03	3.33	49.35	-24.65	74.00	150	400	Peak
2	7236.000	36.58	10.97	47.54	-26.46	74.00	150	400	Peak
3	9648.000	31.91	14.70	46.61	-27.39	74.00	150	400	Peak

Note:

- "\*", means this data is the worst emission level.
- C.F (Correction Factor) = Antenna Factor (dB)+ Cable Loss (dB) – Pre-amplifier(dB).
- Measurement (dBuV/m) = Reading(dBuV) + C.F (Correction Factor).
- The emission levels of other frequencies are very lower than the limit and not show in test report.

EUT	NCSP3DC	Date of Test	2020-09-24
Factor	BBHA 9120D & BBHA 9170	Temp. / Humidity	25°C /55%
Polarity	Horizontal	Site / Test Engineer	AC1 / Jay
Test Mode	802.11b_TX_CH 6_ANT 0	Test Voltage	DC 12V

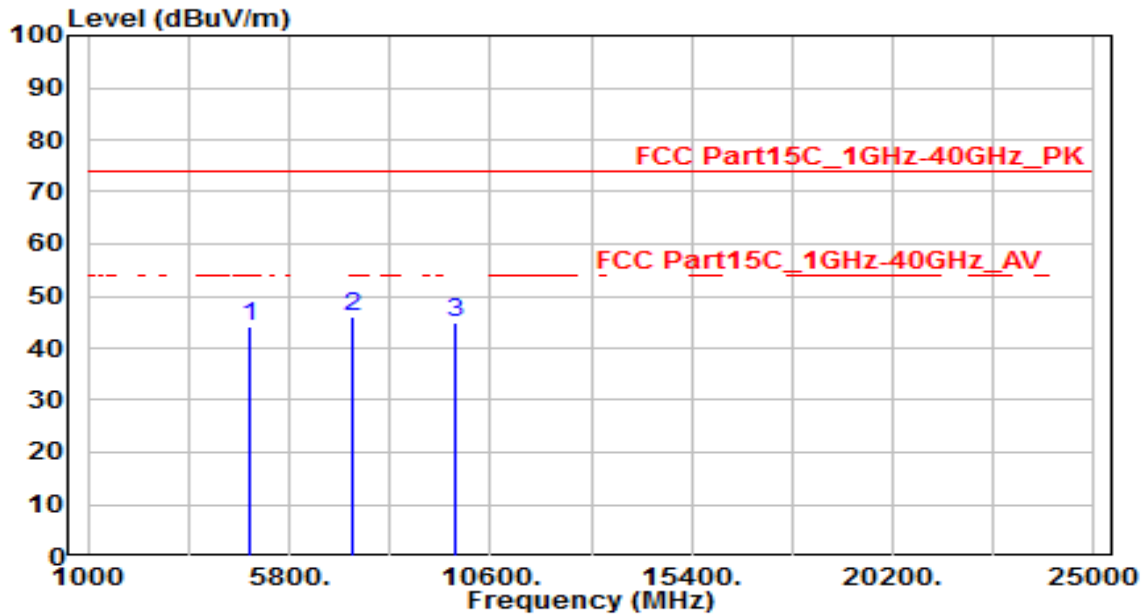

No	Frequency (MHz)	Reading (dBuV)	C.F (dB)	Measurement (dBuV/m)	Margin (dB)	Limit (dBuV/m)	Height (cm)	Angle (deg)	Remark (QP/PK/AV)
1	4874.000	40.84	3.45	44.29	-29.71	74.00	150	400	Peak
2	* 7311.000	35.04	11.18	46.22	-27.78	74.00	150	400	Peak
3	9748.000	30.06	14.89	44.94	-29.06	74.00	150	400	Peak

Note:

- "\*", means this data is the worst emission level.
- C.F (Correction Factor) = Antenna Factor (dB)+ Cable Loss (dB) – Preamplifier(dB).
- Measurement (dBuV/m) = Reading(dBuV) + C.F (Correction Factor).
- The emission levels of other frequencies are very lower than the limit and not show in test report.

EUT	NCSP3DC	Date of Test	2020-09-24
Factor	BBHA 9120D & BBHA 9170	Temp. / Humidity	25°C /55%
Polarity	Vertical	Site / Test Engineer	AC1 / Jay
Test Mode	802.11b_TX_CH 6_ANT 0	Test Voltage	DC 12V

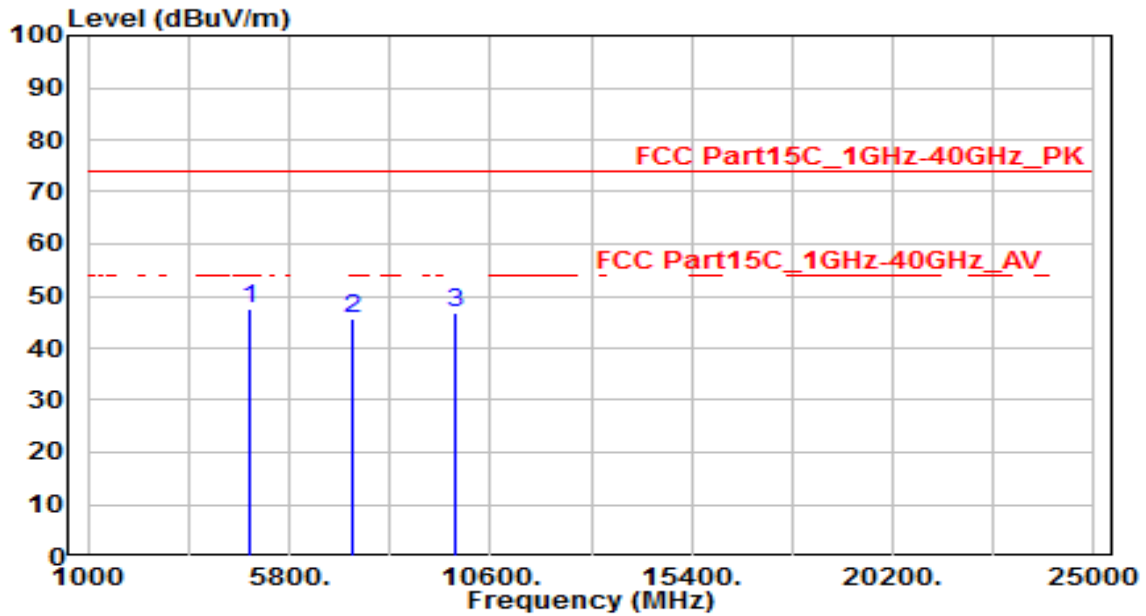

No	Frequency (MHz)	Reading (dBuV)	C.F (dB)	Measurement (dBuV/m)	Margin (dB)	Limit (dBuV/m)	Height (cm)	Angle (deg)	Remark (QP/PK/AV)
1	* 4874.000	44.16	3.45	47.61	-26.39	74.00	150	400	Peak
2	7311.000	34.56	11.18	45.74	-28.26	74.00	150	400	Peak
3	9748.000	31.88	14.89	46.77	-27.23	74.00	150	400	Peak

Note:

- "\*", means this data is the worst emission level.
- C.F (Correction Factor) = Antenna Factor (dB)+ Cable Loss (dB) – Preampifier(dB).
- Measurement (dBuV/m) = Reading(dBuV) + C.F (Correction Factor).
- The emission levels of other frequencies are very lower than the limit and not show in test report.

EUT	NCSP3DC	Date of Test	2020-09-24
Factor	BBHA 9120D & BBHA 9170	Temp. / Humidity	25°C /55%
Polarity	Horizontal	Site / Test Engineer	AC1 / Jay
Test Mode	802.11b_TX_CH 11_ANT 0	Test Voltage	DC 12V

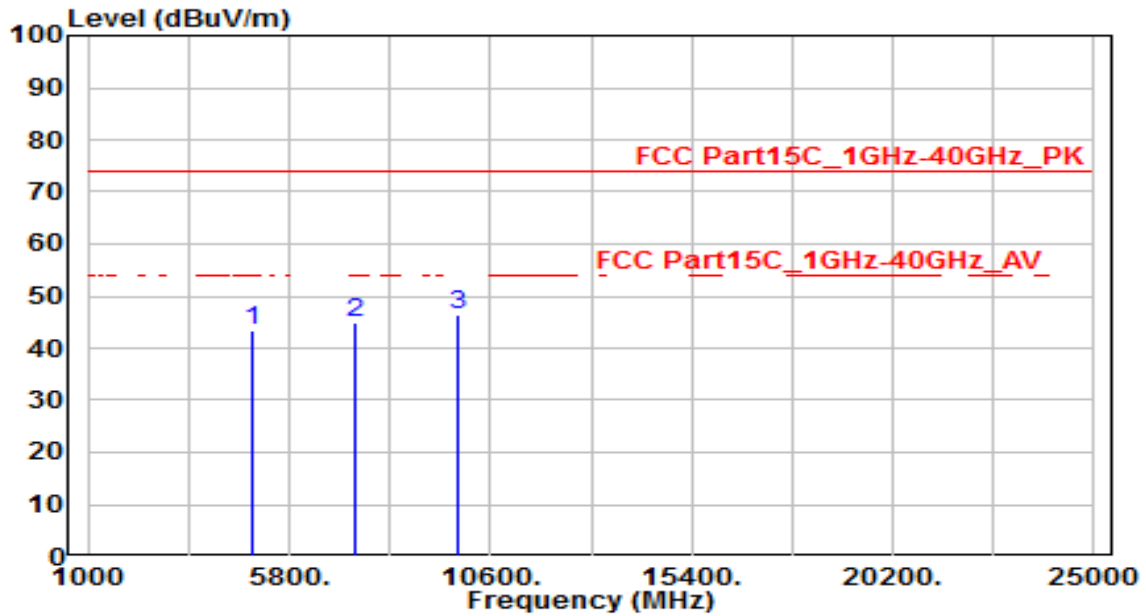

No	Frequency (MHz)	Reading (dBUV)	C.F (dB)	Measurement (dBUV/m)	Margin (dB)	Limit (dBUV/m)	Height (cm)	Angle (deg)	Remark (QP/PK/AV)
1	4924.000	39.88	3.57	43.45	-30.55	74.00	150	400	Peak
2	7386.000	33.52	11.39	44.91	-29.09	74.00	150	400	Peak
3	* 9848.000	31.50	15.07	46.57	-27.43	74.00	150	400	Peak

Note:

1. " \*", means this data is the worst emission level.
2. C.F (Correction Factor) = Antenna Factor (dB)+ Cable Loss (dB) – Preamplifier(dB).
3. Measurement (dBUV/m) = Reading(dBUV) + C.F (Correction Factor).
4. The emission levels of other frequencies are very lower than the limit and not show in test report.

EUT	NCSP3DC	Date of Test	2020-09-24
Factor	BBHA 9120D & BBHA 9170	Temp. / Humidity	25°C /55%
Polarity	Vertical	Site / Test Engineer	AC1 / Jay
Test Mode	802.11b_TX_CH 11_ANT 0	Test Voltage	DC 12V

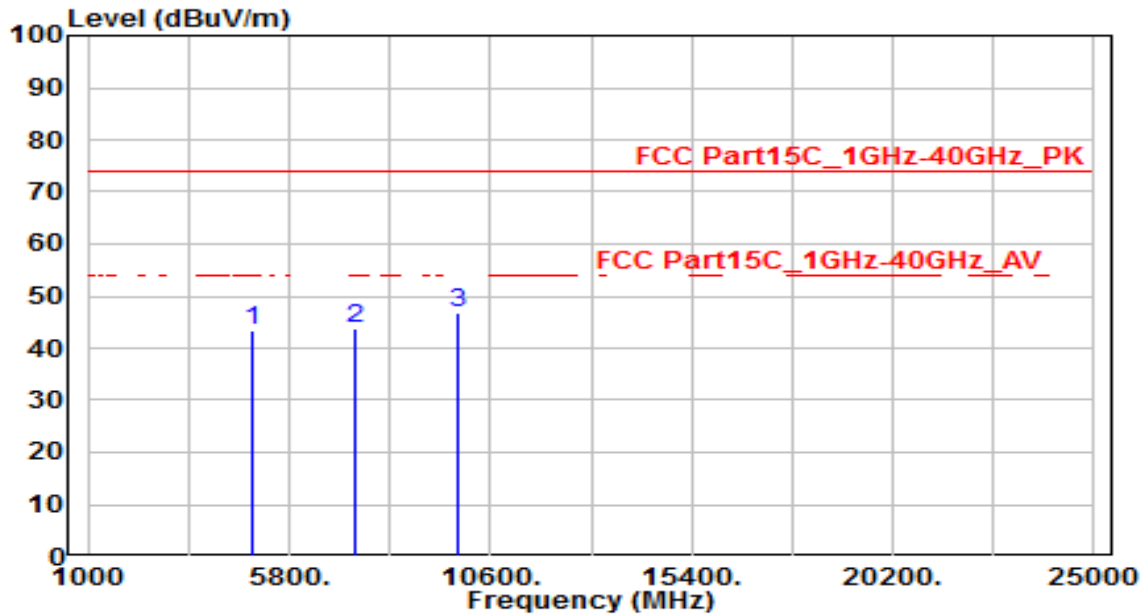

No	Frequency (MHz)	Reading (dBUV)	C.F (dB)	Measurement (dBUV/m)	Margin (dB)	Limit (dBUV/m)	Height (cm)	Angle (deg)	Remark (QP/PK/AV)
1	4924.000	39.83	3.57	43.40	-30.60	74.00	150	400	Peak
2	7386.000	32.49	11.39	43.88	-30.12	74.00	150	400	Peak
3	* 9848.000	31.71	15.07	46.78	-27.22	74.00	150	400	Peak

Note:

- "\*", means this data is the worst emission level.
- C.F (Correction Factor) = Antenna Factor (dB)+ Cable Loss (dB) – Pre-amplifier(dB).
- Measurement (dBUV/m) = Reading(dBUV) + C.F (Correction Factor).
- The emission levels of other frequencies are very lower than the limit and not show in test report.

EUT	NCSP3DC	Date of Test	2020-09-24
Factor	BBHA 9120D & BBHA 9170	Temp. / Humidity	25°C /55%
Polarity	Horizontal	Site / Test Engineer	AC1 / Jay
Test Mode	802.11g_TX_CH 1_ANT 0	Test Voltage	DC 12V

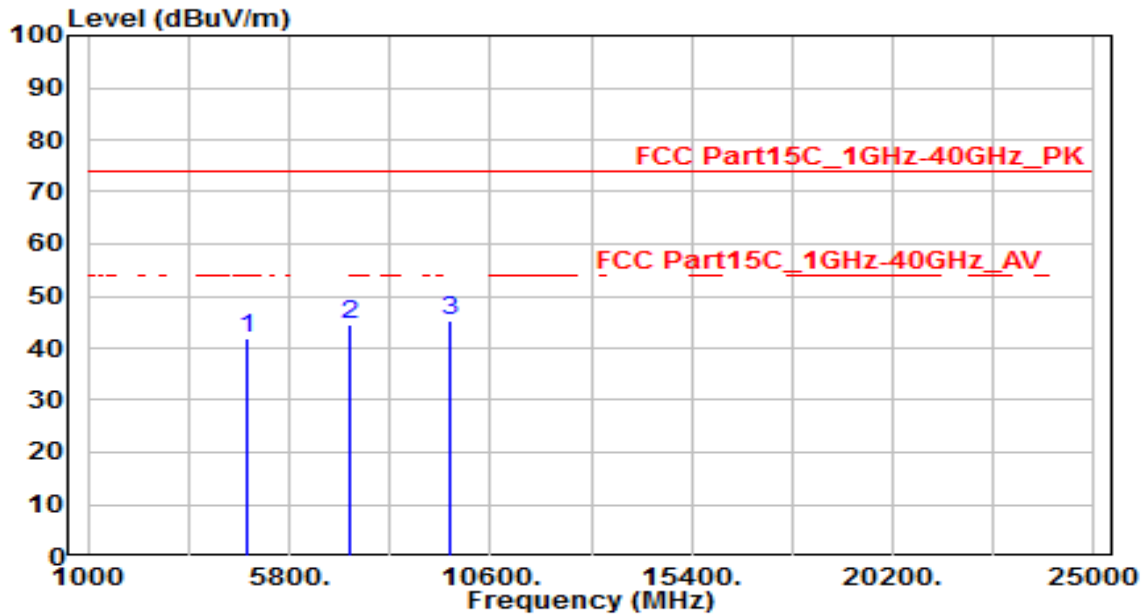

No	Frequency (MHz)	Reading (dBuV)	C.F (dB)	Measurement (dBuV/m)	Margin (dB)	Limit (dBuV/m)	Height (cm)	Angle (deg)	Remark (QP/PK/AV)
1	4824.000	38.58	3.33	41.91	-32.09	74.00	150	400	Peak
2	7236.000	33.66	10.97	44.63	-29.37	74.00	150	400	Peak
3	* 9648.000	30.40	14.70	45.10	-28.90	74.00	150	400	Peak

Note:

- "\*", means this data is the worst emission level.
- C.F (Correction Factor) = Antenna Factor (dB)+ Cable Loss (dB) – Pre-amplifier(dB).
- Measurement (dBuV/m) = Reading(dBuV) + C.F (Correction Factor).
- The emission levels of other frequencies are very lower than the limit and not show in test report.

EUT	NCSP3DC	Date of Test	2020-09-24
Factor	BBHA 9120D & BBHA 9170	Temp. / Humidity	25°C /55%
Polarity	Vertical	Site / Test Engineer	AC1 / Jay
Test Mode	802.11g_TX_CH 1_ANT 0	Test Voltage	DC 12V

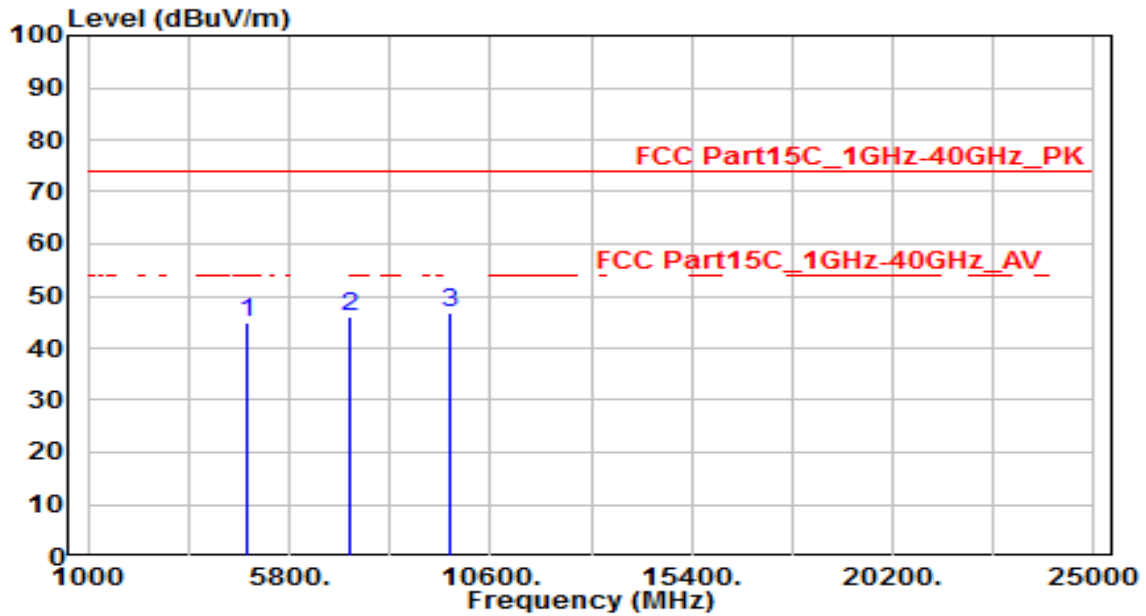

No	Frequency (MHz)	Reading (dBuV)	C.F (dB)	Measurement (dBuV/m)	Margin (dB)	Limit (dBuV/m)	Height (cm)	Angle (deg)	Remark (QP/PK/AV)
1	4824.000	41.47	3.33	44.80	-29.20	74.00	150	400	Peak
2	7236.000	34.89	10.97	45.85	-28.15	74.00	150	400	Peak
3	* 9648.000	32.17	14.70	46.87	-27.13	74.00	150	400	Peak

Note:

- "\*", means this data is the worst emission level.
- C.F (Correction Factor) = Antenna Factor (dB)+ Cable Loss (dB) – Pre-amplifier(dB).
- Measurement (dBuV/m) = Reading(dBuV) + C.F (Correction Factor).
- The emission levels of other frequencies are very lower than the limit and not show in test report.



EUT	NCSP3DC	Date of Test	2020-09-24
Factor	BBHA 9120D & BBHA 9170	Temp. / Humidity	25°C /55%
Polarity	Horizontal	Site / Test Engineer	AC1 / Jay
Test Mode	802.11g_TX_CH 6_ANT 0	Test Voltage	DC 12V

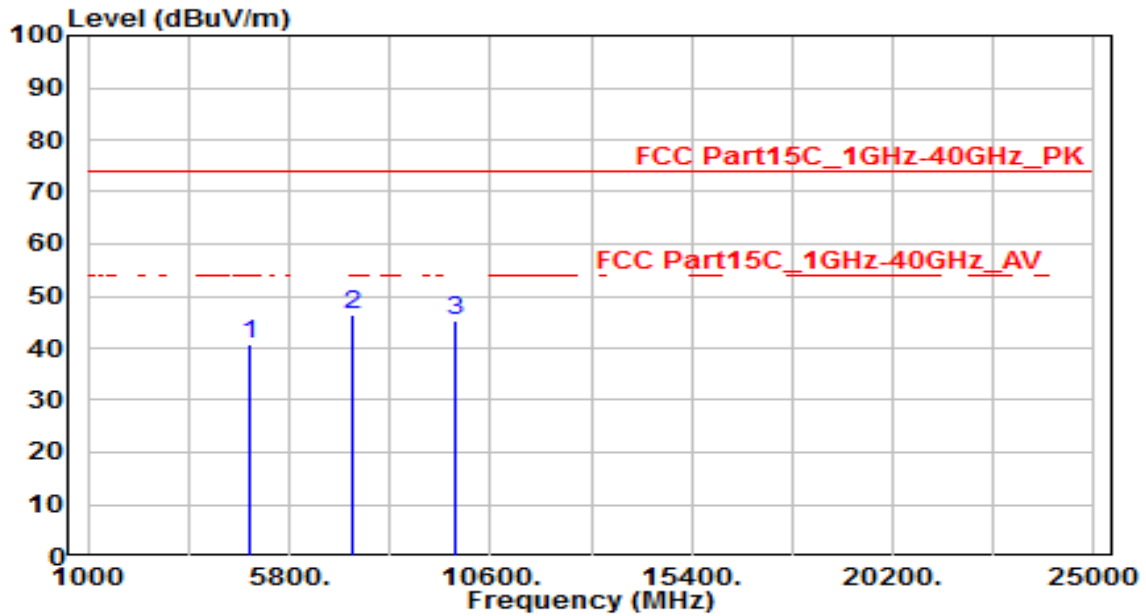

No	Frequency (MHz)	Reading (dBUV)	C.F (dB)	Measurement (dBUV/m)	Margin (dB)	Limit (dBUV/m)	Height (cm)	Angle (deg)	Remark (QP/PK/AV)
1	4874.000	37.26	3.45	40.71	-33.29	74.00	150	400	Peak
2	* 7311.000	35.38	11.18	46.56	-27.44	74.00	150	400	Peak
3	9748.000	30.24	14.89	45.13	-28.87	74.00	150	400	Peak

Note:

1. " \*", means this data is the worst emission level.
2. C.F (Correction Factor) = Antenna Factor (dB)+ Cable Loss (dB) – Preamplifier(dB).
3. Measurement (dBUV/m) = Reading(dBUV) + C.F (Correction Factor).
4. The emission levels of other frequencies are very lower than the limit and not show in test report.

EUT	NCSP3DC	Date of Test	2020-09-24
Factor	BBHA 9120D & BBHA 9170	Temp. / Humidity	25°C /55%
Polarity	Vertical	Site / Test Engineer	AC1 / Jay
Test Mode	802.11g_TX_CH 6_ANT 0	Test Voltage	DC 12V

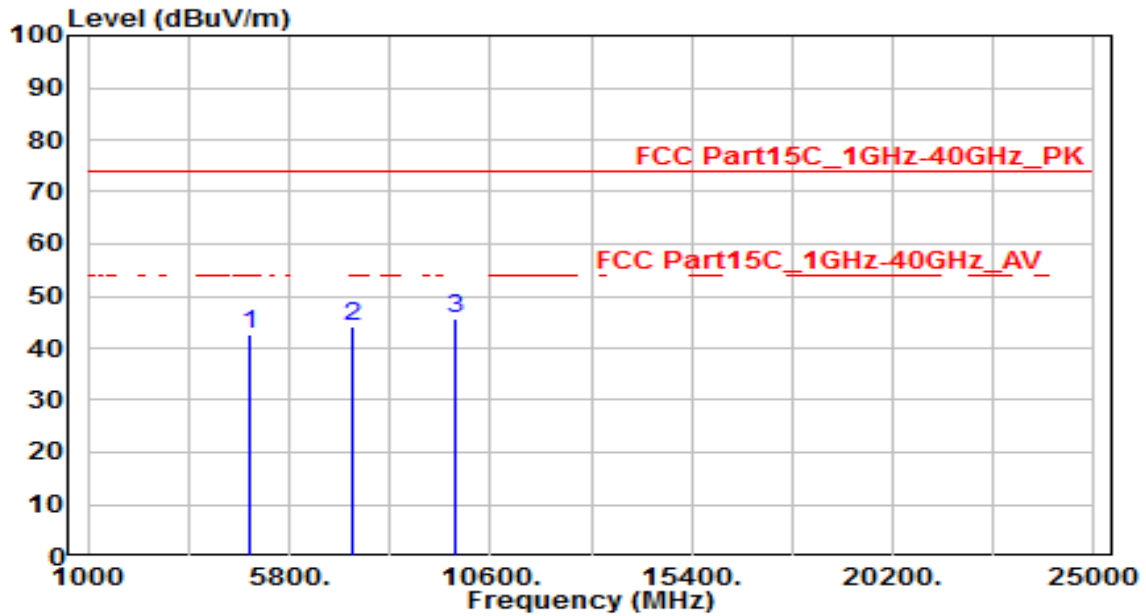

No	Frequency (MHz)	Reading (dBuV)	C.F (dB)	Measurement (dBuV/m)	Margin (dB)	Limit (dBuV/m)	Height (cm)	Angle (deg)	Remark (QP/PK/AV)
1	4874.000	39.38	3.45	42.82	-31.18	74.00	150	400	Peak
2	7311.000	32.83	11.18	44.01	-29.99	74.00	150	400	Peak
3	* 9748.000	30.78	14.89	45.67	-28.33	74.00	150	400	Peak

Note:

- "\*", means this data is the worst emission level.
- C.F (Correction Factor) = Antenna Factor (dB)+ Cable Loss (dB) – Pre-amplifier(dB).
- Measurement (dBuV/m) = Reading(dBuV) + C.F (Correction Factor).
- The emission levels of other frequencies are very lower than the limit and not show in test report.

EUT	NCSP3DC	Date of Test	2020-09-24
Factor	BBHA 9120D & BBHA 9170	Temp. / Humidity	25°C /55%
Polarity	Horizontal	Site / Test Engineer	AC1 / Jay
Test Mode	802.11g_TX_CH 11_ANT 0	Test Voltage	DC 12V

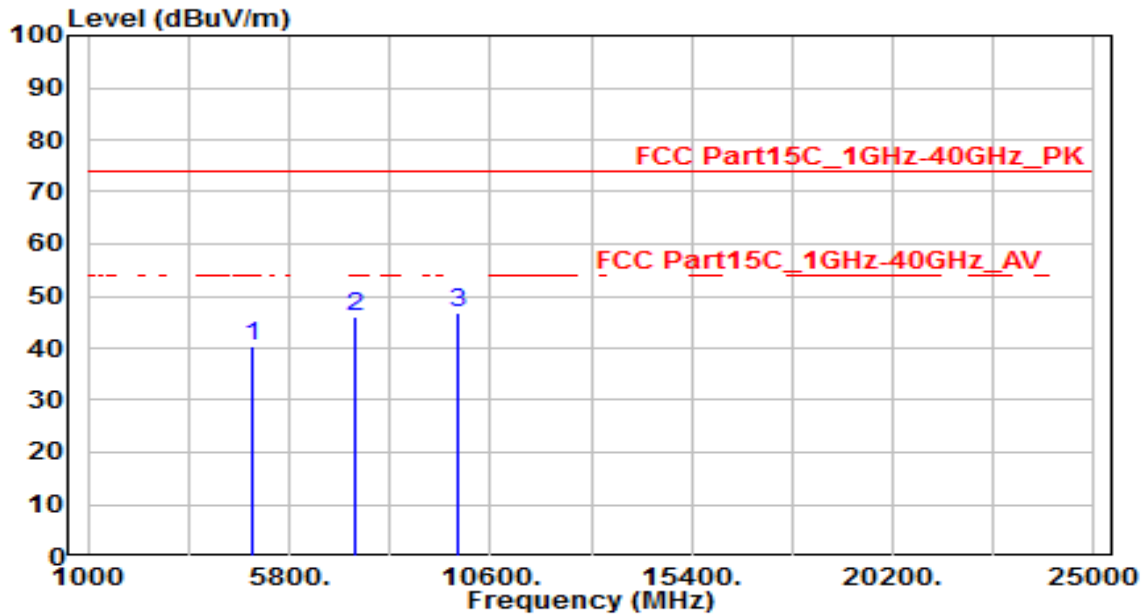

No	Frequency (MHz)	Reading (dBuV)	C.F (dB)	Measurement (dBuV/m)	Margin (dB)	Limit (dBuV/m)	Height (cm)	Angle (deg)	Remark (QP/PK/AV)
1	4924.000	36.88	3.57	40.45	-33.55	74.00	150	400	Peak
2	7386.000	34.53	11.39	45.92	-28.08	74.00	150	400	Peak
3	* 9848.000	31.85	15.07	46.93	-27.07	74.00	150	400	Peak

Note:

- "\*", means this data is the worst emission level.
- C.F (Correction Factor) = Antenna Factor (dB)+ Cable Loss (dB) – Pre-amplifier(dB).
- Measurement (dBuV/m) = Reading(dBuV) + C.F (Correction Factor).
- The emission levels of other frequencies are very lower than the limit and not show in test report.

EUT	NCSP3DC	Date of Test	2020-09-24
Factor	BBHA 9120D & BBHA 9170	Temp. / Humidity	25°C /55%
Polarity	Vertical	Site / Test Engineer	AC1 / Jay
Test Mode	802.11g_TX_CH 11_ANT 0	Test Voltage	DC 12V

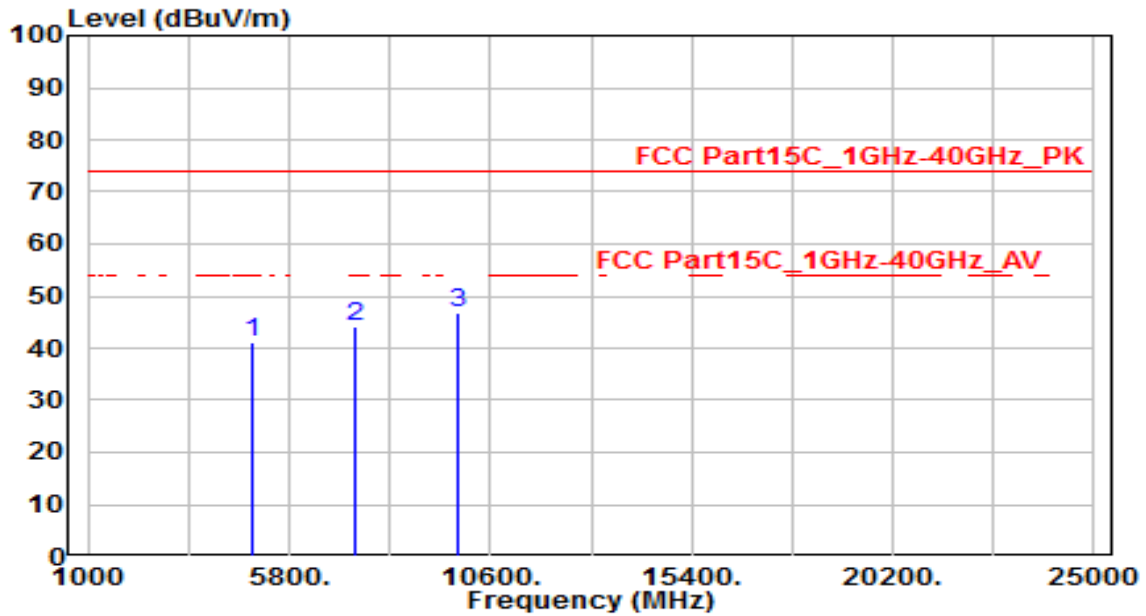

No	Frequency (MHz)	Reading (dBuV)	C.F (dB)	Measurement (dBuV/m)	Margin (dB)	Limit (dBuV/m)	Height (cm)	Angle (deg)	Remark (QP/PK/AV)
1	4924.000	37.46	3.57	41.02	-32.98	74.00	150	400	Peak
2	7386.000	32.59	11.39	43.98	-30.02	74.00	150	400	Peak
3	* 9848.000	31.68	15.07	46.75	-27.25	74.00	150	400	Peak

Note:

- "\*", means this data is the worst emission level.
- C.F (Correction Factor) = Antenna Factor (dB)+ Cable Loss (dB) – Pre-amplifier(dB).
- Measurement (dBuV/m) = Reading(dBuV) + C.F (Correction Factor).
- The emission levels of other frequencies are very lower than the limit and not show in test report.

EUT	NCSP3DC	Date of Test	2020-09-24
Factor	BBHA 9120D & BBHA 9170	Temp. / Humidity	25°C /55%
Polarity	Horizontal	Site / Test Engineer	AC1 / Jay
Test Mode	802.11n-20MHz_TX_CH 1_ANT 0	Test Voltage	DC 12V

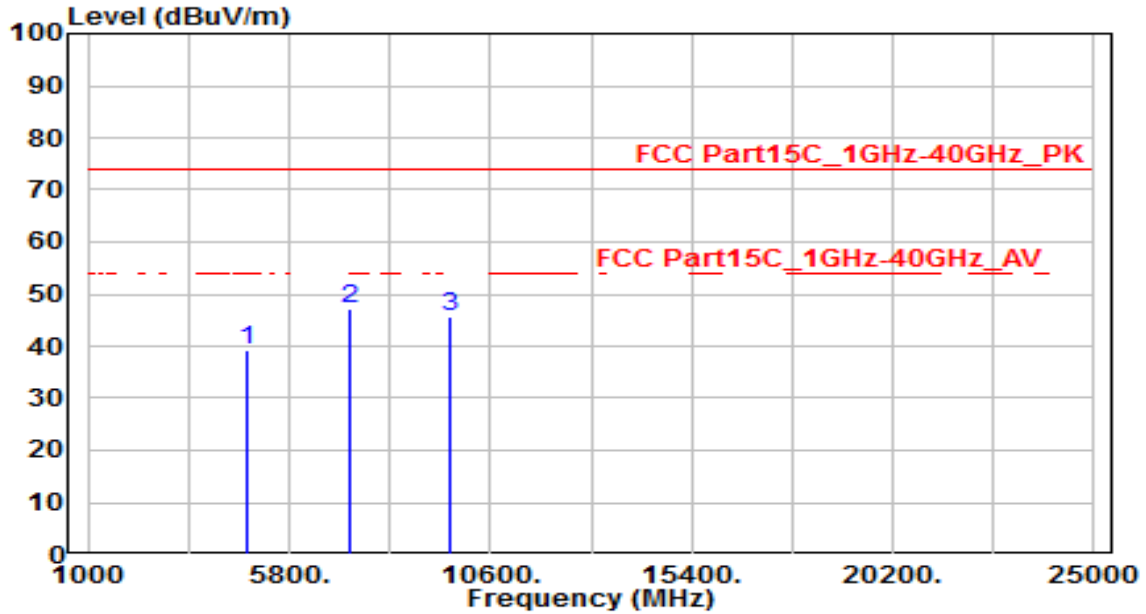

No	Frequency (MHz)	Reading (dBuV)	C.F (dB)	Measurement (dBuV/m)	Margin (dB)	Limit (dBuV/m)	Height (cm)	Angle (deg)	Remark (QP/PK/AV)
1	4824.000	35.88	3.33	39.21	-34.79	74.00	150	400	Peak
2	* 7236.000	36.10	10.97	47.07	-26.93	74.00	150	400	Peak
3	9648.000	31.11	14.70	45.81	-28.19	74.00	150	400	Peak

Note:

- "\*", means this data is the worst emission level.
- C.F (Correction Factor) = Antenna Factor (dB)+ Cable Loss (dB) – Pre-amplifier(dB).
- Measurement (dBuV/m) = Reading(dBuV) + C.F (Correction Factor).
- The emission levels of other frequencies are very lower than the limit and not show in test report.

EUT	NCSP3DC	Date of Test	2020-09-24
Factor	BBHA 9120D & BBHA 9170	Temp. / Humidity	25°C /55%
Polarity	Vertical	Site / Test Engineer	AC1 / Jay
Test Mode	802.11n-20MHz_TX_CH 1_ANT 0	Test Voltage	DC 12V

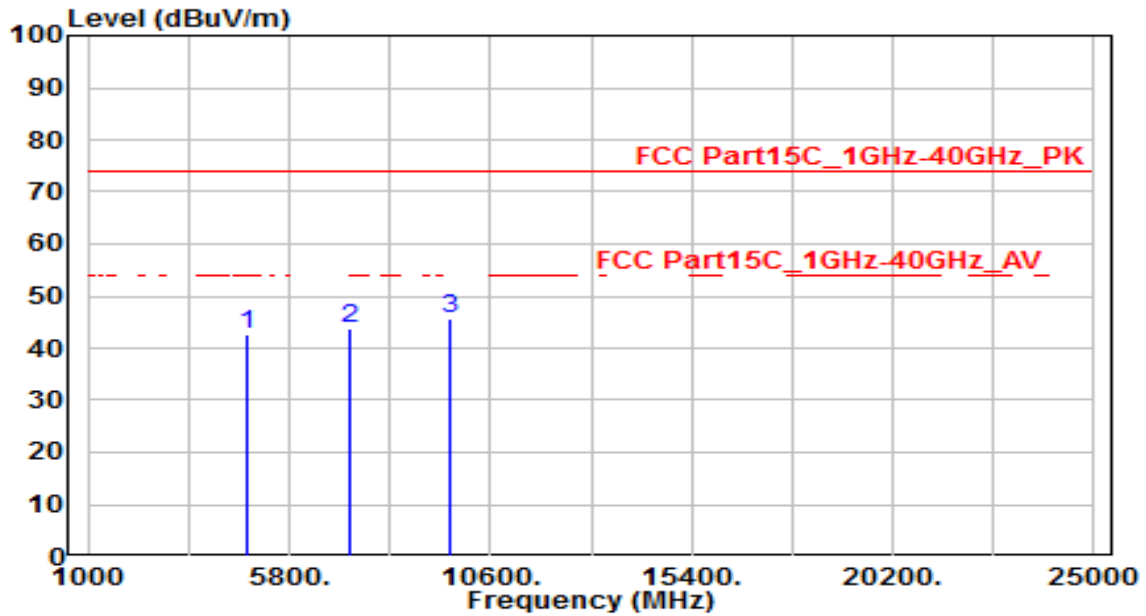

No	Frequency (MHz)	Reading (dBuV)	C.F (dB)	Measurement (dBuV/m)	Margin (dB)	Limit (dBuV/m)	Height (cm)	Angle (deg)	Remark (QP/PK/AV)
1	4824.000	39.38	3.33	42.71	-31.29	74.00	150	400	Peak
2	7236.000	32.88	10.97	43.85	-30.15	74.00	150	400	Peak
3	* 9648.000	31.12	14.70	45.82	-28.18	74.00	150	400	Peak

Note:

- "\*", means this data is the worst emission level.
- C.F (Correction Factor) = Antenna Factor (dB)+ Cable Loss (dB) – Pre-amplifier(dB).
- Measurement (dBuV/m) = Reading(dBuV) + C.F (Correction Factor).
- The emission levels of other frequencies are very lower than the limit and not show in test report.

EUT	NCSP3DC	Date of Test	2020-09-24
Factor	BBHA 9120D & BBHA 9170	Temp. / Humidity	25°C /55%
Polarity	Horizontal	Site / Test Engineer	AC1 / Jay
Test Mode	802.11n-20MHz_TX_CH 6_ANT 0	Test Voltage	DC 12V

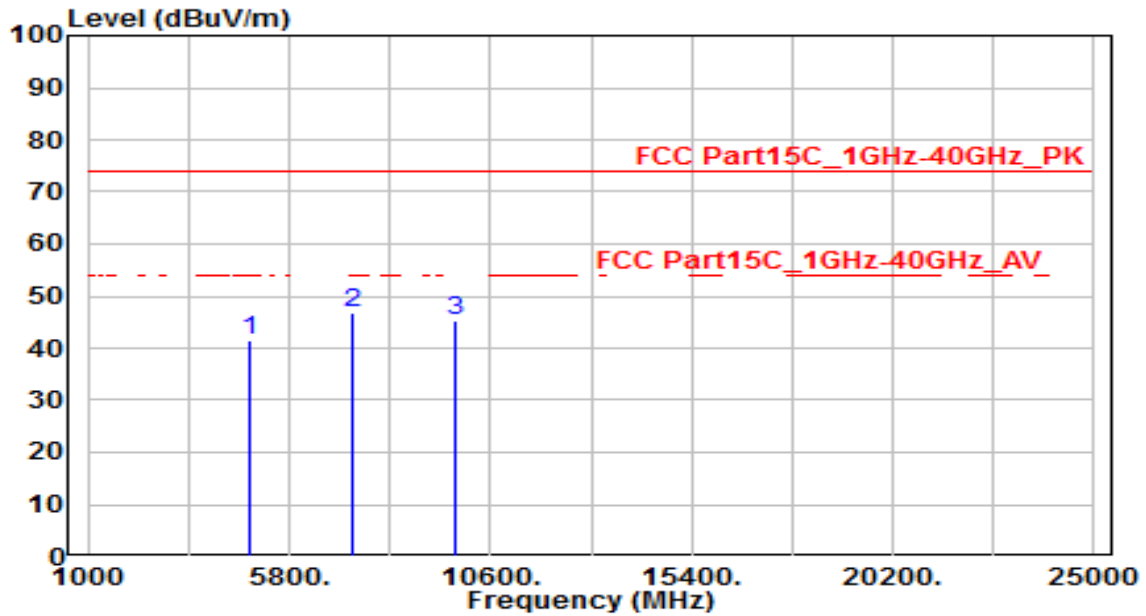

No	Frequency (MHz)	Reading (dBuV)	C.F (dB)	Measurement (dBuV/m)	Margin (dB)	Limit (dBuV/m)	Height (cm)	Angle (deg)	Remark (QP/PK/AV)
1	4874.000	38.10	3.45	41.55	-32.45	74.00	150	400	Peak
2	* 7311.000	35.74	11.18	46.92	-27.08	74.00	150	400	Peak
3	9748.000	30.26	14.89	45.15	-28.85	74.00	150	400	Peak

Note:

- "\*", means this data is the worst emission level.
- C.F (Correction Factor) = Antenna Factor (dB)+ Cable Loss (dB) – Preamplifier(dB).
- Measurement (dBuV/m) = Reading(dBuV) + C.F (Correction Factor).
- The emission levels of other frequencies are very lower than the limit and not show in test report.

EUT	NCSP3DC	Date of Test	2020-09-24
Factor	BBHA 9120D & BBHA 9170	Temp. / Humidity	25°C /55%
Polarity	Vertical	Site / Test Engineer	AC1 / Jay
Test Mode	802.11n-20MHz_TX_CH 6_ANT 0	Test Voltage	DC 12V

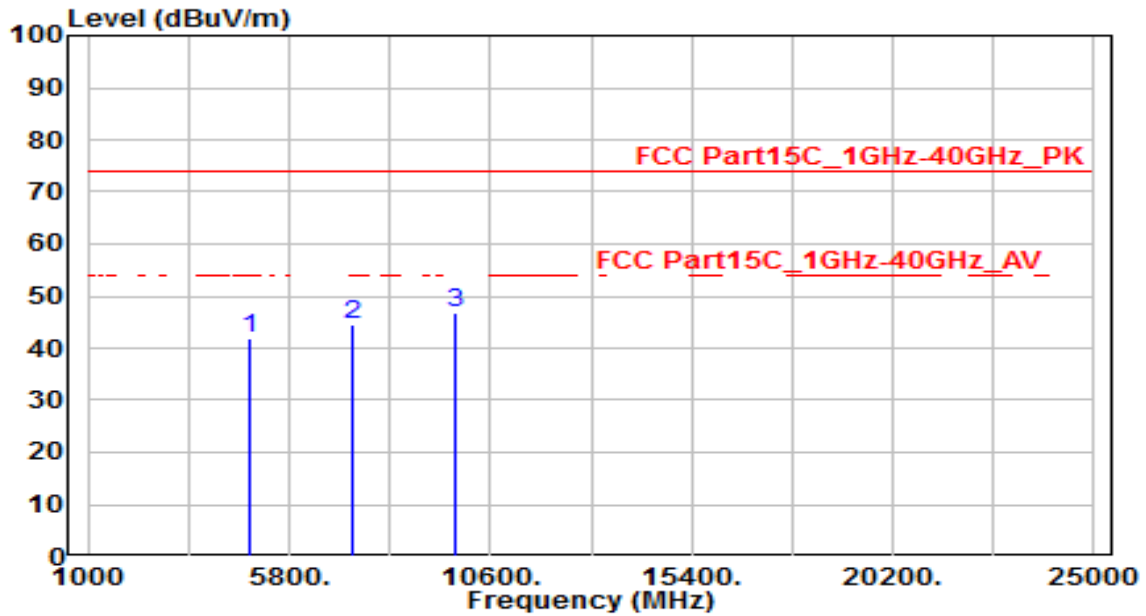

No	Frequency (MHz)	Reading (dBuV)	C.F (dB)	Measurement (dBuV/m)	Margin (dB)	Limit (dBuV/m)	Height (cm)	Angle (deg)	Remark (QP/PK/AV)
1	4874.000	38.40	3.45	41.85	-32.15	74.00	150	400	Peak
2	7311.000	33.45	11.18	44.63	-29.37	74.00	150	400	Peak
3	* 9748.000	31.92	14.89	46.81	-27.19	74.00	150	400	Peak

Note:

- "\*", means this data is the worst emission level.
- C.F (Correction Factor) = Antenna Factor (dB)+ Cable Loss (dB) – Preamplifier(dB).
- Measurement (dBuV/m) = Reading(dBuV) + C.F (Correction Factor).
- The emission levels of other frequencies are very lower than the limit and not show in test report.



EUT	NCSP3DC	Date of Test	2020-09-24
Factor	BBHA 9120D & BBHA 9170	Temp. / Humidity	25°C /55%
Polarity	Horizontal	Site / Test Engineer	AC1 / Jay
Test Mode	802.11n-20MHz_TX_CH 11_ANT 0	Test Voltage	DC 12V

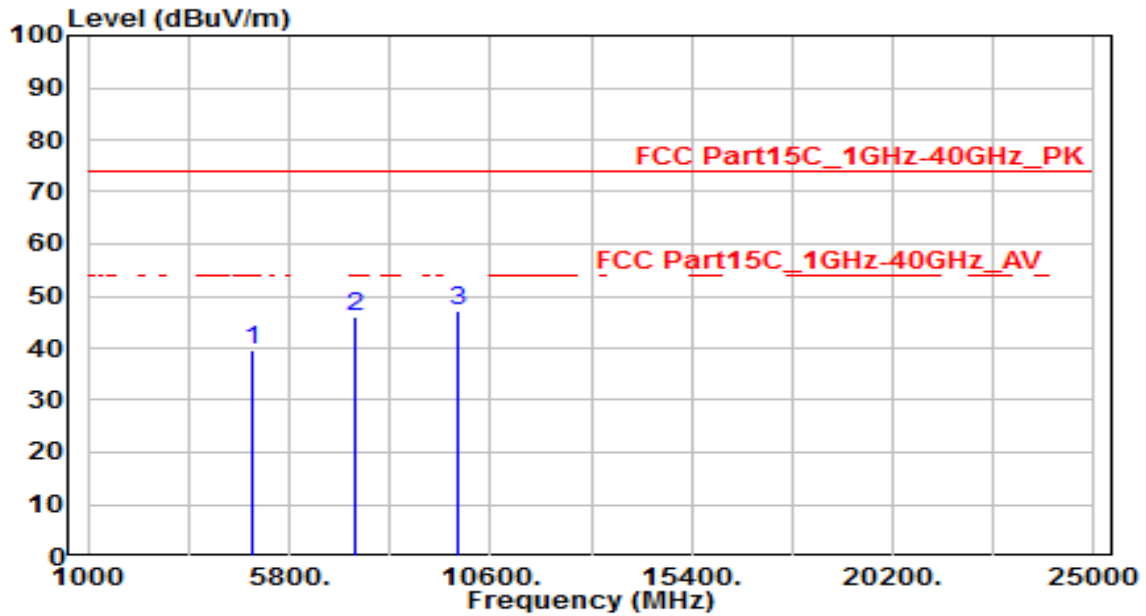

No	Frequency (MHz)	Reading (dBuV)	C.F (dB)	Measurement (dBuV/m)	Margin (dB)	Limit (dBuV/m)	Height (cm)	Angle (deg)	Remark (QP/PK/AV)
1	4924.000	36.13	3.57	39.70	-34.30	74.00	150	400	Peak
2	7386.000	34.83	11.39	46.22	-27.78	74.00	150	400	Peak
3	* 9848.000	32.28	15.07	47.35	-26.65	74.00	150	400	Peak

Note:

- "\*", means this data is the worst emission level.
- C.F (Correction Factor) = Antenna Factor (dB)+ Cable Loss (dB) – Pre-amplifier(dB).
- Measurement (dBuV/m) = Reading(dBuV) + C.F (Correction Factor).
- The emission levels of other frequencies are very lower than the limit and not show in test report.

EUT	NCSP3DC	Date of Test	2020-09-24
Factor	BBHA 9120D & BBHA 9170	Temp. / Humidity	25°C /55%
Polarity	Vertical	Site / Test Engineer	AC1 / Jay
Test Mode	802.11n-20MHz_TX_CH 11_ANT 0	Test Voltage	DC 12V

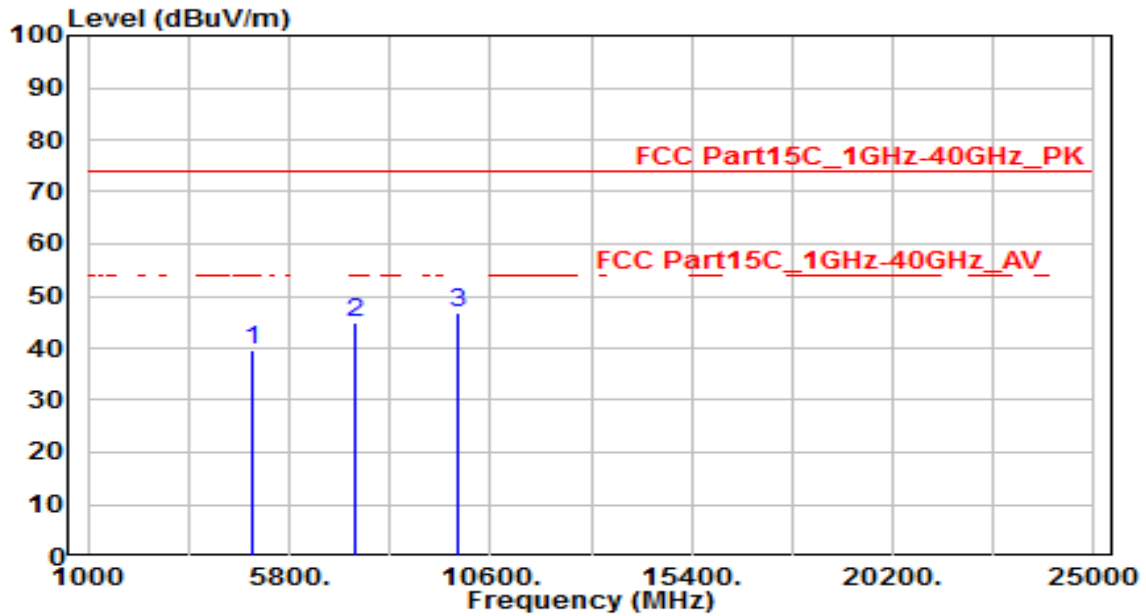

No	Frequency (MHz)	Reading (dBuV)	C.F (dB)	Measurement (dBuV/m)	Margin (dB)	Limit (dBuV/m)	Height (cm)	Angle (deg)	Remark (QP/PK/AV)
1	4924.000	35.92	3.57	39.49	-34.51	74.00	150	400	Peak
2	7386.000	33.46	11.39	44.86	-29.14	74.00	150	400	Peak
3	* 9848.000	31.54	15.07	46.62	-27.38	74.00	150	400	Peak

Note:

- "\*", means this data is the worst emission level.
- C.F (Correction Factor) = Antenna Factor (dB)+ Cable Loss (dB) – Pre-amplifier(dB).
- Measurement (dBuV/m) = Reading(dBuV) + C.F (Correction Factor).
- The emission levels of other frequencies are very lower than the limit and not show in test report.

## 7.7. Radiated Restricted Band Edge Measurement

### 7.7.1. Test Limit

All out of band emissions appearing in a restricted band as specified in Section 15.205 of the Title 47 CFR must not exceed the limits shown in Table per Section 15.209.

FCC Part 15 Subpart C Paragraph 15.209		
Frequency [MHz]	Field Strength [V/m]	Measured Distance [Meters]
0.009 - 0.490	2400/F (kHz)	300
0.490 - 1.705	24000/F (kHz)	30
1.705 – 30	30	30
30 – 88	100	3
88 – 216	150	3
216 – 960	200	3
Above 960	500	3

### 7.7.2. Test Procedure Used

ANSI C63.10-2013 - Section 11.12.1

### 7.7.3. Test Setting

#### Peak Field Strength Measurements

1. Analyzer center frequency was set to the frequency of the radiated spurious emission of interest
2. RBW = as specified in Table 1
3. VBW = 3 \* RBW
4. Detector = peak
5. Sweep time = auto couple
6. Trace mode = max hold

- Trace was allowed to stabilize

**Table 1 - RBW as a function of frequency**

Frequency	RBW
9 ~ 150 kHz	200 ~ 300 Hz
0.15 ~ 30 MHz	9 ~ 10 kHz
30 ~ 1000 MHz	100 ~ 120 kHz
> 1000 MHz	1 MHz

**Average Field Strength Measurements**

- Analyzer center frequency was set to the frequency of the radiated spurious emission of interest
- RBW = 1MHz
- VBW  $\geq 1/T$
- De As an alternative, the instrument may be set to linear detector mode. Ensure that video filtering is applied in linear voltage domain (rather than in a log or dB domain). Some instruments require linear display mode in order to accomplish this. Others have a setting for Average-VBW Type, which can be set to "Voltage" regardless of the display mode
- Detector = Peak
- Sweep time = auto
- Trace mode = max hold
- Allow max hold to run for at least 50 times (1/duty cycle) traces

### 7.7.4. Test Setup

1GHz ~ 18GHz Test Setup:

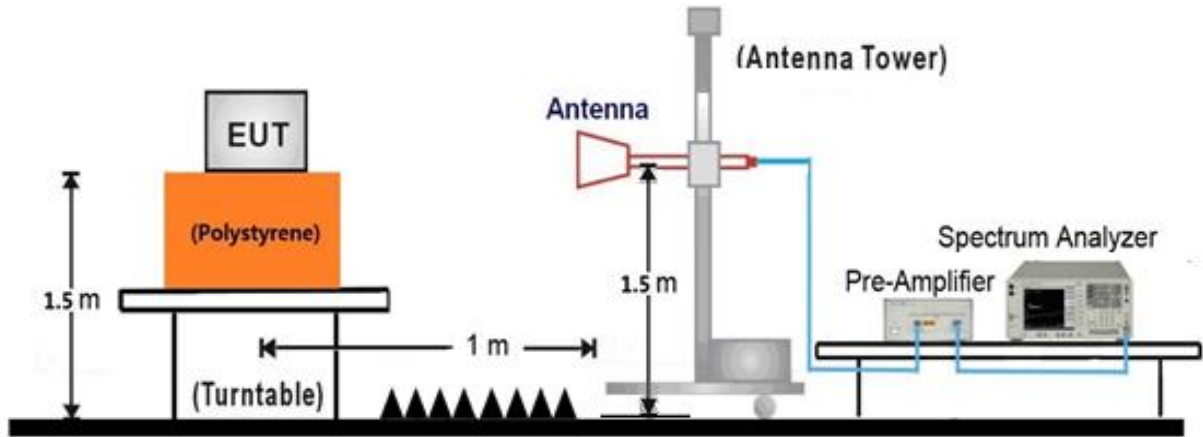

**7.7.5. Test Result**

EUT	NCSP3DC	Date of Test	2020-09-24
Factor	BBHA 9120D	Temp. / Humidity	25°C /55%
Polarity	Horizontal	Site / Test Engineer	AC1 / Jay
Test Mode	802.11b_TX_CH 1_ANT 0	Test Voltage	DC 12V

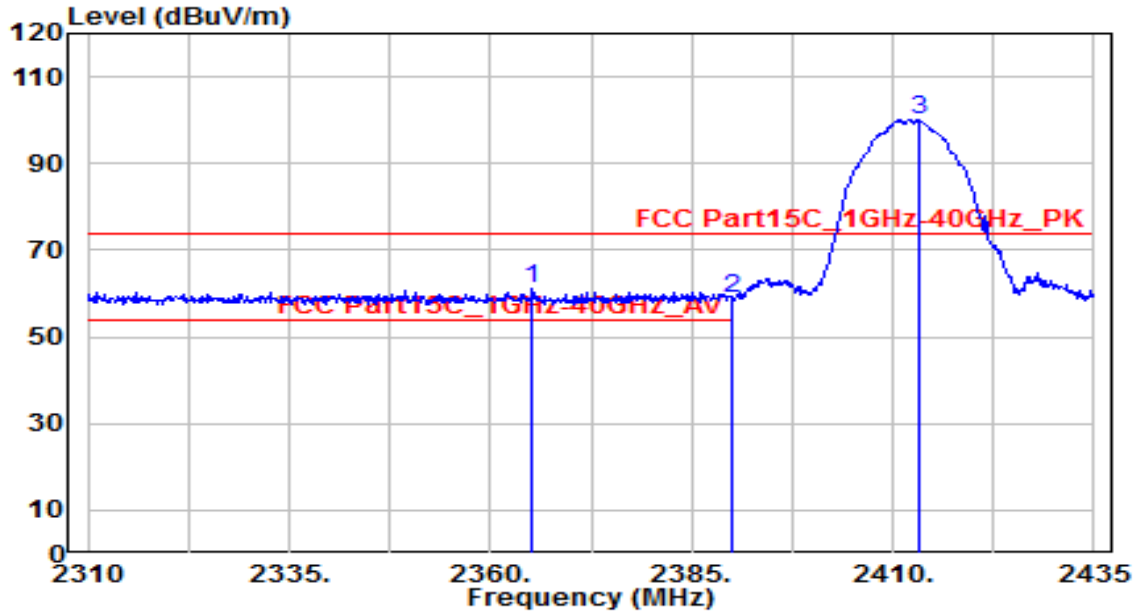

No	Frequency (MHz)	Reading (dBuV)	C.F (dB)	Measurement (dBuV/m)	Margin (dB)	Limit (dBuV/m)	Height (cm)	Angle (deg)	Remark (QP/PK/AV)	
1	*	2365.125	28.99	32.19	61.18	-12.82	74.00	145	330	Peak
2		2390.000	26.60	32.30	58.89	-15.11	74.00	145	330	Peak
3		2413.125	67.56	32.40	99.95	N/A	N/A	145	330	Peak

Note:

- "\*" means this data is the worst emission level.
- C.F (Correction Factor) = Antenna Factor (dB)+ Cable Loss (dB).
- Measurement (dBuV/m) = Reading(dBuV) + C.F (Correction Factor).
- The emission levels of other frequencies are very lower than the limit and not show in test report.

EUT	NCSP3DC	Date of Test	2020-09-24
Factor	BBHA 9120D	Temp. / Humidity	25°C /55%
Polarity	Horizontal	Site / Test Engineer	AC1 / Jay
Test Mode	802.11b_TX_CH 1_ANT 0	Test Voltage	DC 12V

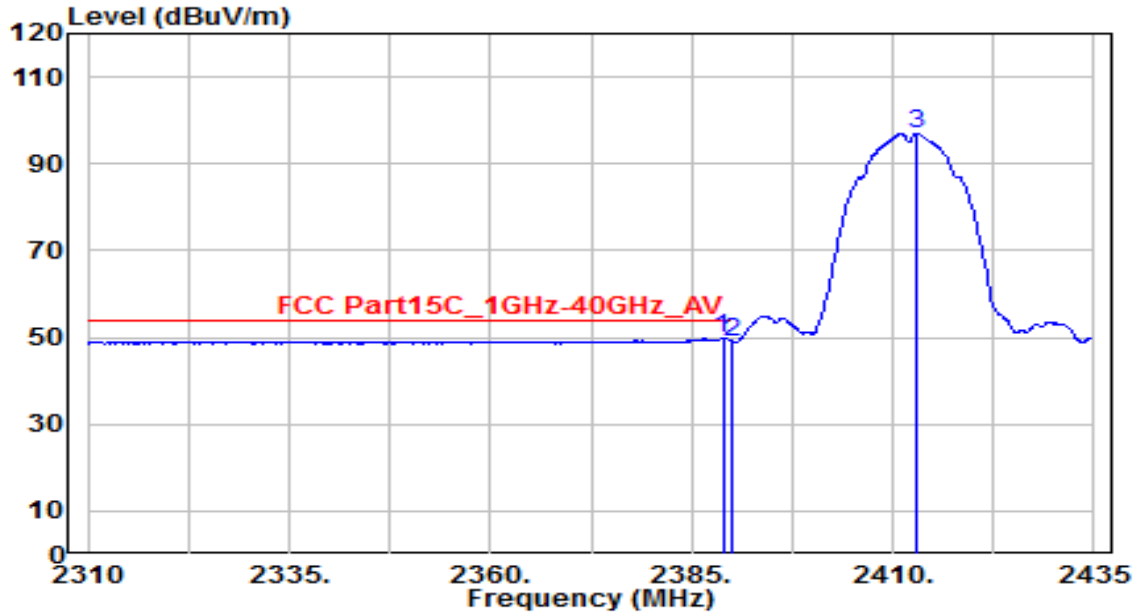

No	Frequency (MHz)	Reading (dBuV)	C.F (dB)	Measurement (dBuV/m)	Margin (dB)	Limit (dBuV/m)	Height (cm)	Angle (deg)	Remark (QP/PK/AV)	
1	*	2388.875	17.50	32.29	49.79	-4.21	54.00	145	330	Average
2		2390.000	16.77	32.30	49.07	-4.93	54.00	145	330	Average
3		2413.000	64.60	32.40	97.00	N/A	N/A	145	330	Average

Note:

1. " \*", means this data is the worst emission level.
2. C.F (Correction Factor) = Antenna Factor (dB)+ Cable Loss (dB).
3. Measurement (dBuV/m) = Reading(dBuV) + C.F (Correction Factor).
4. The emission levels of other frequencies are very lower than the limit and not show in test report.

EUT	NCSP3DC	Date of Test	2020-09-24
Factor	BBHA 9120D	Temp. / Humidity	25°C /55%
Polarity	Vertical	Site / Test Engineer	AC1 / Jay
Test Mode	802.11b_TX_CH 1_ANT 0	Test Voltage	DC 12V

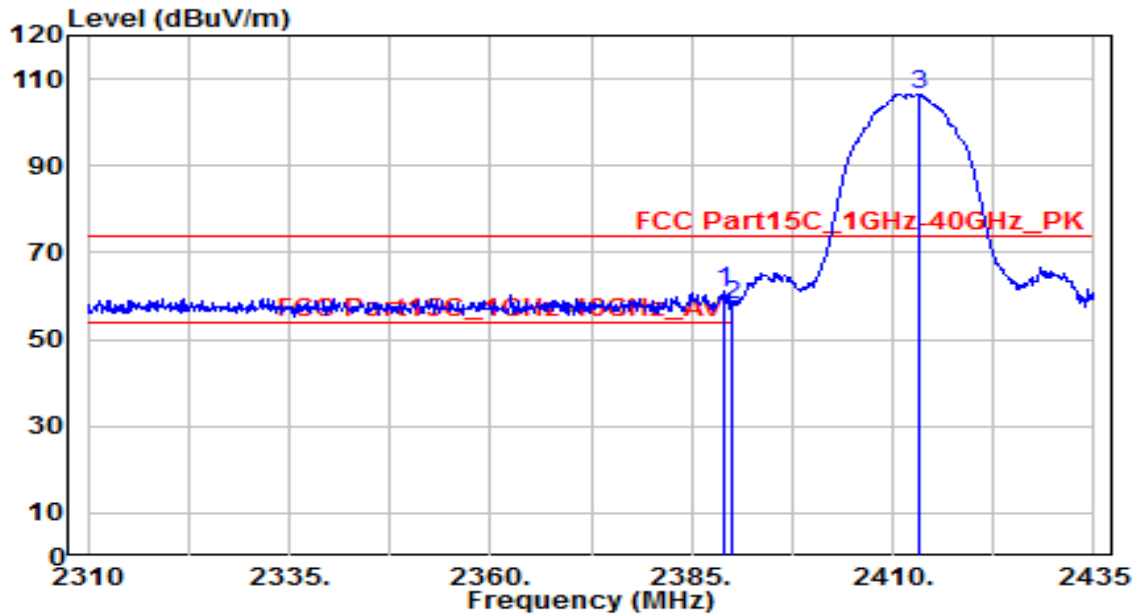

No	Frequency (MHz)	Reading (dBuV)	C.F (dB)	Measurement (dBuV/m)	Margin (dB)	Limit (dBuV/m)	Height (cm)	Angle (deg)	Remark (QP/PK/AV)
1	* 2389.125	28.65	32.29	60.94	-13.06	74.00	170	280	Peak
2	2390.000	25.47	32.30	57.77	-16.23	74.00	170	280	Peak
3	2413.125	74.19	32.40	106.59	N/A	N/A	170	280	Peak

Note:

1. " \*", means this data is the worst emission level.
2. C.F (Correction Factor) = Antenna Factor (dB)+ Cable Loss (dB).
3. Measurement (dBuV/m) = Reading(dBuV) + C.F (Correction Factor).
4. The emission levels of other frequencies are very lower than the limit and not show in test report.



EUT	NCSP3DC	Date of Test	2020-09-24
Factor	BBHA 9120D	Temp. / Humidity	25°C /55%
Polarity	Vertical	Site / Test Engineer	AC1 / Jay
Test Mode	802.11b_TX_CH 1_ANT 0	Test Voltage	DC 12V

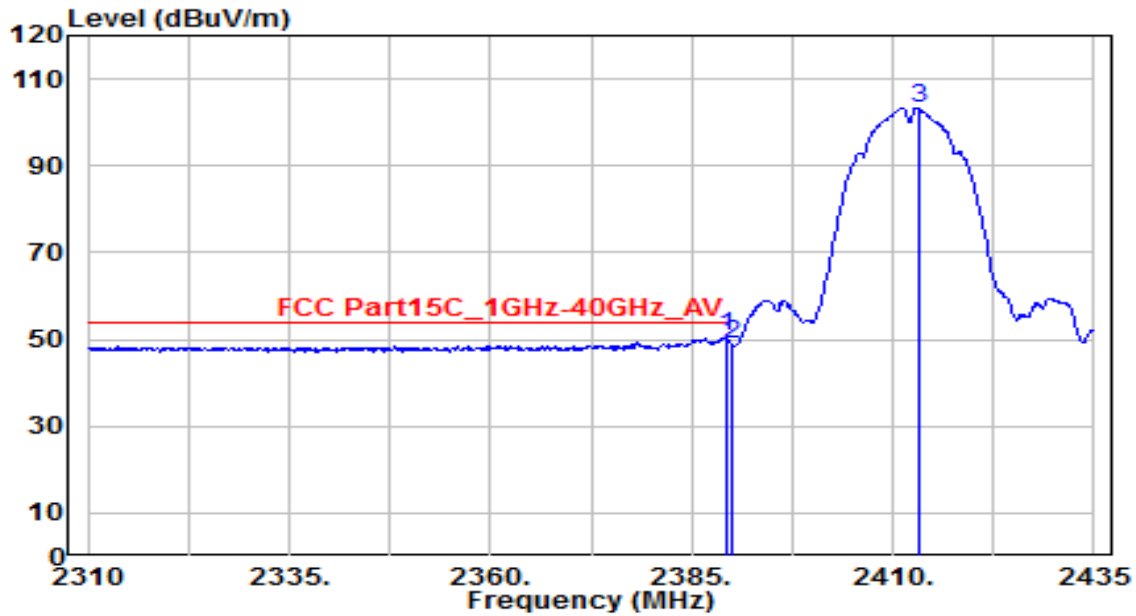

No	Frequency (MHz)	Reading (dBuV)	C.F (dB)	Measurement (dBuV/m)	Margin (dB)	Limit (dBuV/m)	Height (cm)	Angle (deg)	Remark (QP/PK/AV)
1	* 2389.250	18.55	32.29	50.84	-3.16	54.00	170	280	Average
2	2390.000	16.80	32.30	49.10	-4.90	54.00	170	280	Average
3	2413.125	70.91	32.40	103.31	N/A	N/A	170	280	Average

Note:

1. " \*", means this data is the worst emission level.
2. C.F (Correction Factor) = Antenna Factor (dB)+ Cable Loss (dB).
3. Measurement (dBuV/m) = Reading(dBuV) + C.F (Correction Factor).
4. The emission levels of other frequencies are very lower than the limit and not show in test report.

EUT	NCSP3DC	Date of Test	2020-09-24
Factor	BBHA 9120D	Temp. / Humidity	25°C /55%
Polarity	Horizontal	Site / Test Engineer	AC1 / Jay
Test Mode	802.11b_TX_CH 11_ANT 0	Test Voltage	DC 12V

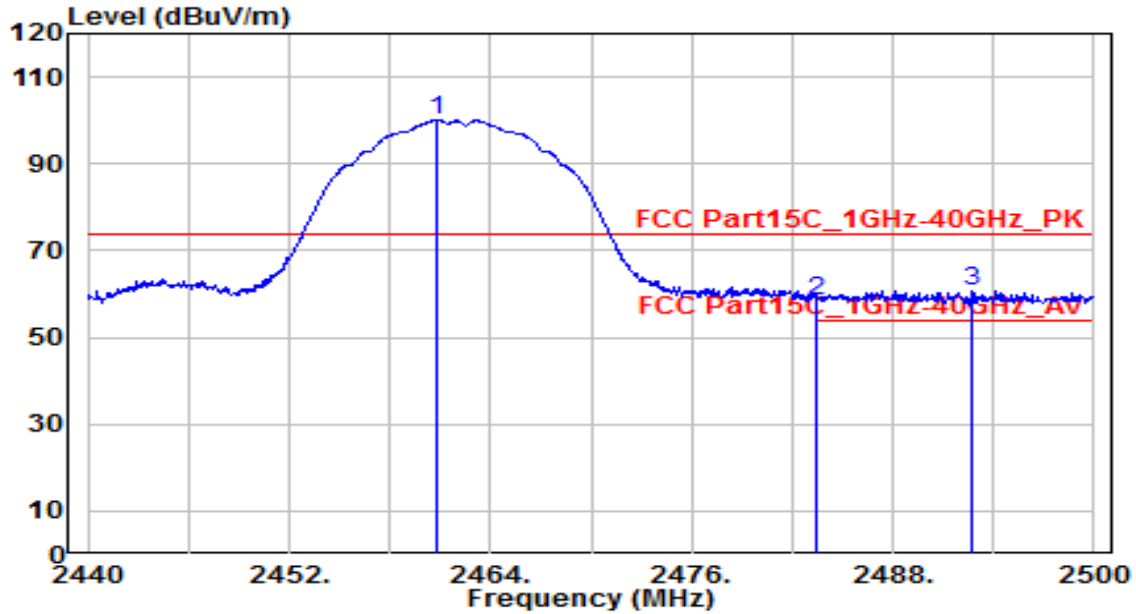

No	Frequency (MHz)	Reading (dBUV)	C.F (dB)	Measurement (dBUV/m)	Margin (dB)	Limit (dBUV/m)	Height (cm)	Angle (deg)	Remark (QP/PK/AV)
1	2460.880	67.41	32.61	100.02	N/A	N/A	200	305	Peak
2	2483.500	25.69	32.71	58.40	-15.60	74.00	200	305	Peak
3	* 2492.680	27.94	32.75	60.69	-13.31	74.00	200	305	Peak

Note:

- "\*", means this data is the worst emission level.
- C.F (Correction Factor) = Antenna Factor (dB)+ Cable Loss (dB).
- Measurement (dBUV/m) = Reading(dBUV) + C.F (Correction Factor).
- The emission levels of other frequencies are very lower than the limit and not show in test report.

EUT	NCSP3DC	Date of Test	2020-09-24
Factor	BBHA 9120D	Temp. / Humidity	25°C /55%
Polarity	Horizontal	Site / Test Engineer	AC1 / Jay
Test Mode	802.11b_TX_CH 11_ANT 0	Test Voltage	DC 12V

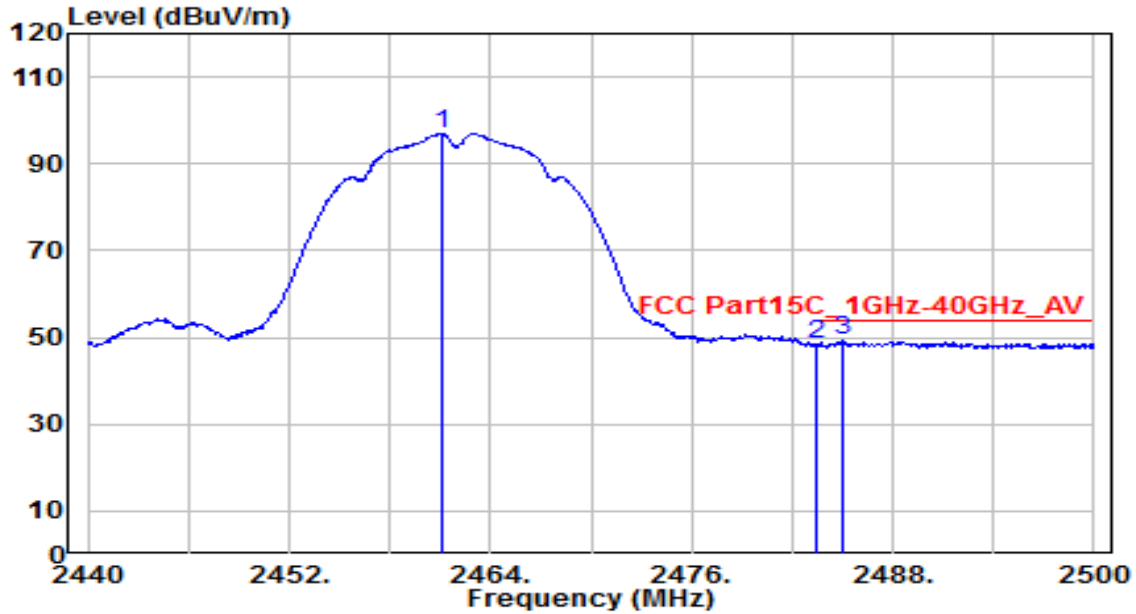

No	Frequency (MHz)	Reading (dBUV)	C.F (dB)	Measurement (dBUV/m)	Margin (dB)	Limit (dBUV/m)	Height (cm)	Angle (deg)	Remark (QP/PK/AV)
1	2461.060	64.37	32.61	96.97	N/A	N/A	200	305	Average
2	2483.500	15.58	32.71	48.28	-5.72	54.00	200	305	Average
3	* 2484.940	16.44	32.71	49.16	-4.84	54.00	200	305	Average

Note:

- "\*", means this data is the worst emission level.
- C.F (Correction Factor) = Antenna Factor (dB)+ Cable Loss (dB).
- Measurement (dBUV/m) = Reading(dBUV) + C.F (Correction Factor).
- The emission levels of other frequencies are very lower than the limit and not show in test report.

EUT	NCSP3DC	Date of Test	2020-09-24
Factor	BBHA 9120D	Temp. / Humidity	25°C /55%
Polarity	Vertical	Site / Test Engineer	AC1 / Jay
Test Mode	802.11b_TX_CH 11_ANT 0_PW67	Test Voltage	DC 12V

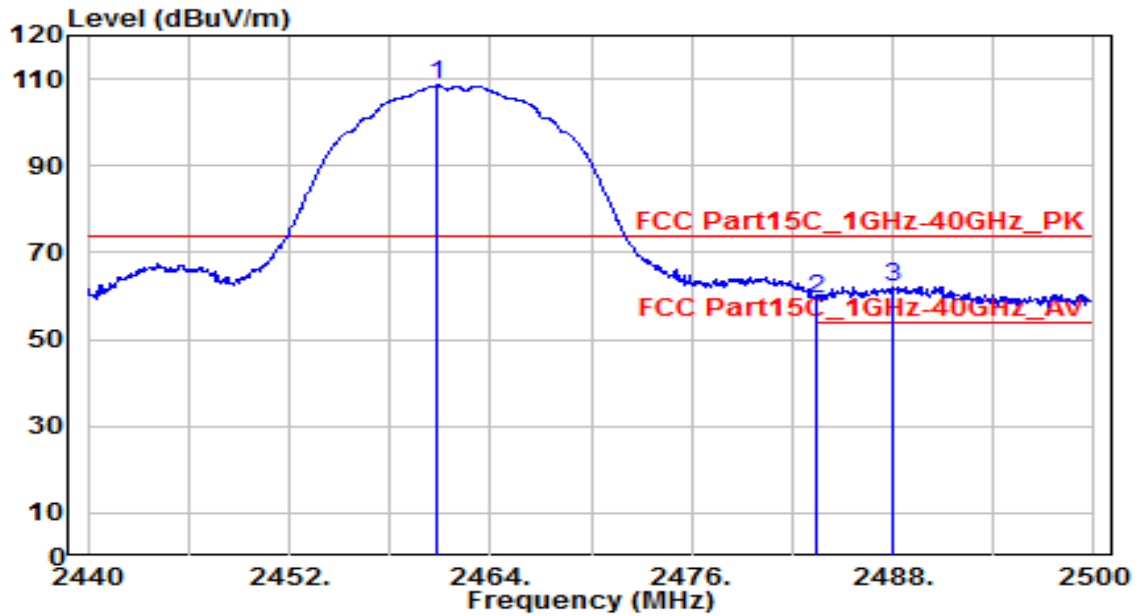

No	Frequency (MHz)	Reading (dBUV)	C.F (dB)	Measurement (dBUV/m)	Margin (dB)	Limit (dBUV/m)	Height (cm)	Angle (deg)	Remark (QP/PK/AV)
1	2460.760	75.87	32.61	108.48	N/A	N/A	200	260	Peak
2	2483.500	26.62	32.71	59.33	-14.67	74.00	200	260	Peak
3	* 2488.060	29.33	32.73	62.06	-11.94	74.00	200	260	Peak

Note:

1. " \*", means this data is the worst emission level.
2. C.F (Correction Factor) = Antenna Factor (dB)+ Cable Loss (dB).
3. Measurement (dBUV/m) = Reading(dBUV) + C.F (Correction Factor).
4. The emission levels of other frequencies are very lower than the limit and not show in test report.

EUT	NCSP3DC	Date of Test	2020-09-24
Factor	BBHA 9120D	Temp. / Humidity	25°C /55%
Polarity	Vertical	Site / Test Engineer	AC1 / Jay
Test Mode	802.11b_TX_CH 11_ANT 0_PW67	Test Voltage	DC 12V

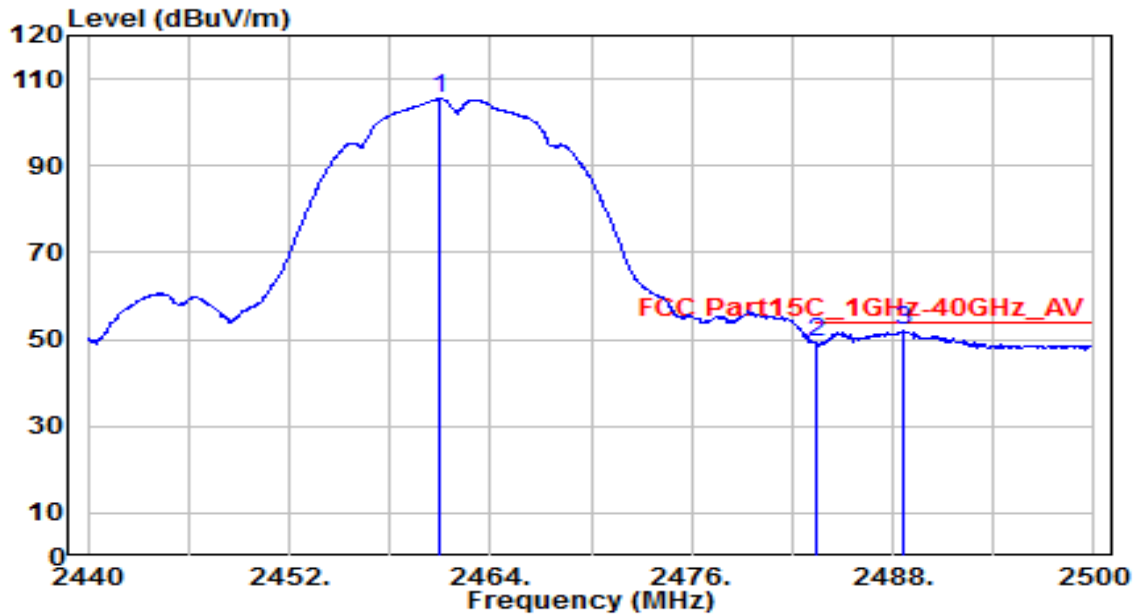

No	Frequency (MHz)	Reading (dBUV)	C.F (dB)	Measurement (dBUV/m)	Margin (dB)	Limit (dBUV/m)	Height (cm)	Angle (deg)	Remark (QP/PK/AV)
1	2460.940	72.79	32.61	105.39	N/A	N/A	200	260	Average
2	2483.500	16.49	32.71	49.19	-4.81	54.00	200	260	Average
3	* 2488.660	19.13	32.73	51.86	-2.14	54.00	200	260	Average

Note:

1. " \*", means this data is the worst emission level.
2. C.F (Correction Factor) = Antenna Factor (dB)+ Cable Loss (dB).
3. Measurement (dBUV/m) = Reading(dBUV) + C.F (Correction Factor).
4. The emission levels of other frequencies are very lower than the limit and not show in test report.

EUT	NCSP3DC	Date of Test	2020-09-24
Factor	BBHA 9120D	Temp. / Humidity	25°C /55%
Polarity	Horizontal	Site / Test Engineer	AC1 / Jay
Test Mode	802.11g_TX_CH 1_ANT 0	Test Voltage	DC 12V

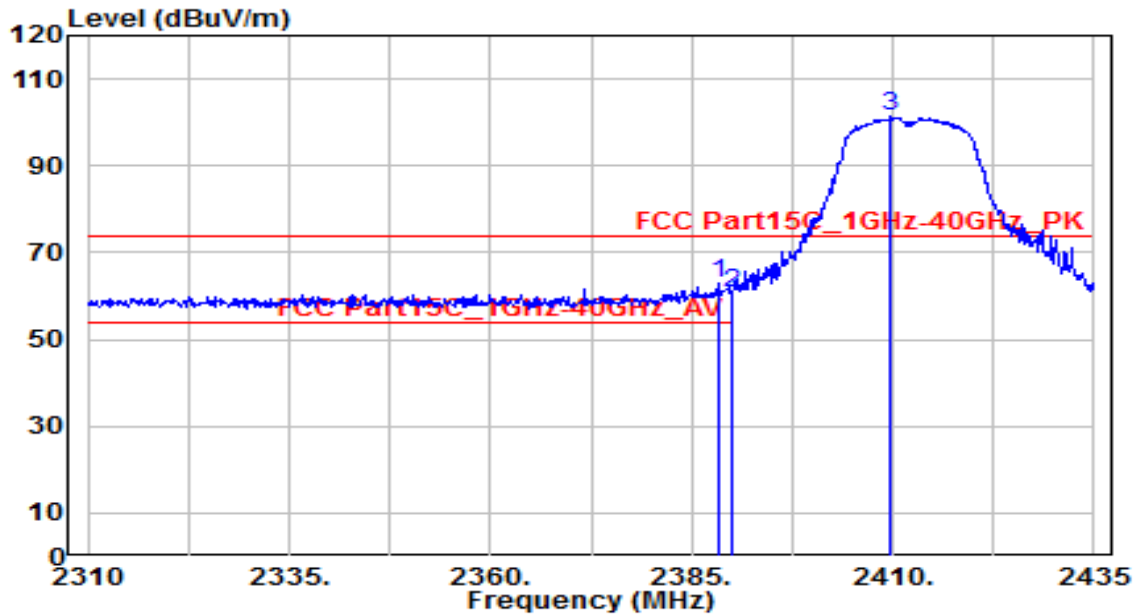

No	Frequency (MHz)	Reading (dBuV)	C.F (dB)	Measurement (dBuV/m)	Margin (dB)	Limit (dBuV/m)	Height (cm)	Angle (deg)	Remark (QP/PK/AV)
1	* 2388.500	30.65	32.29	62.94	-11.06	74.00	145	330	Peak
2	2390.000	28.41	32.30	60.71	-13.29	74.00	145	330	Peak
3	2409.750	68.87	32.38	101.26	N/A	N/A	145	330	Peak

Note:

1. " \*", means this data is the worst emission level.
2. C.F (Correction Factor) = Antenna Factor (dB)+ Cable Loss (dB).
3. Measurement (dBuV/m) = Reading(dBuV) + C.F (Correction Factor).
4. The emission levels of other frequencies are very lower than the limit and not show in test report.

EUT	NCSP3DC	Date of Test	2020-09-24
Factor	BBHA 9120D	Temp. / Humidity	25°C /55%
Polarity	Horizontal	Site / Test Engineer	AC1 / Jay
Test Mode	802.11g_TX_CH 1_ANT 0	Test Voltage	DC 12V

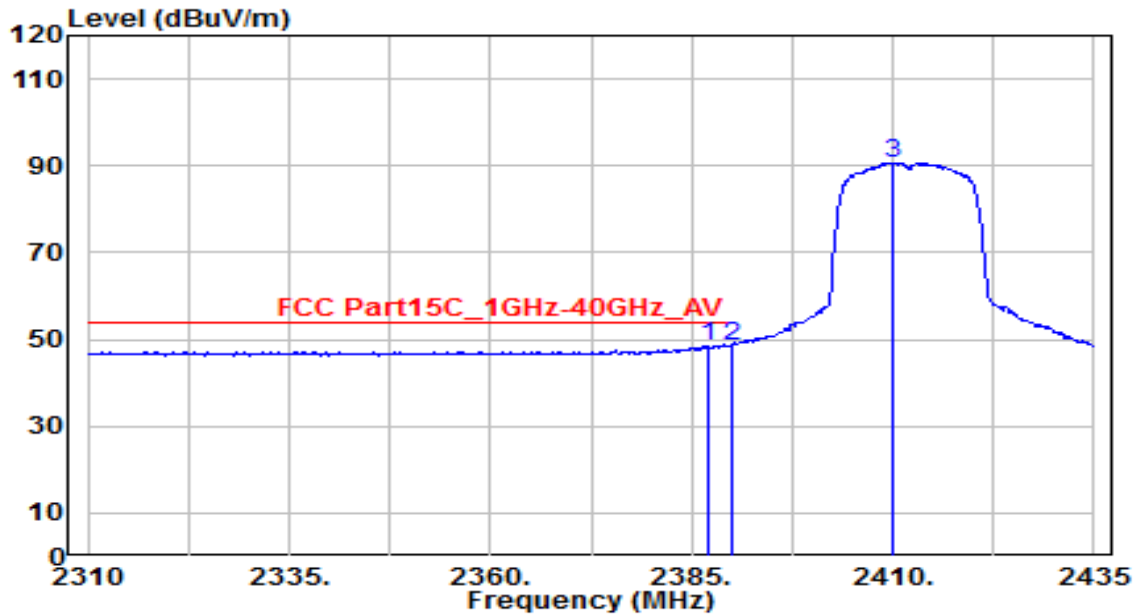

No	Frequency (MHz)	Reading (dBUV)	C.F (dB)	Measurement (dBUV/m)	Margin (dB)	Limit (dBUV/m)	Height (cm)	Angle (deg)	Remark (QP/PK/AV)
1	*	16.31	32.28	48.59	-5.41	54.00	145	330	Average
2		16.20	32.30	48.49	-5.51	54.00	145	330	Average
3		58.34	32.38	90.72	N/A	N/A	145	330	Average

Note:

1. " \*", means this data is the worst emission level.
2. C.F (Correction Factor) = Antenna Factor (dB)+ Cable Loss (dB).
3. Measurement (dBUV/m) = Reading(dBUV) + C.F (Correction Factor).
4. The emission levels of other frequencies are very lower than the limit and not show in test report.

EUT	NCSP3DC	Date of Test	2020-09-24
Factor	BBHA 9120D	Temp. / Humidity	25°C /55%
Polarity	Vertical	Site / Test Engineer	AC1 / Jay
Test Mode	802.11g_TX_CH 1_ANT 0	Test Voltage	DC 12V

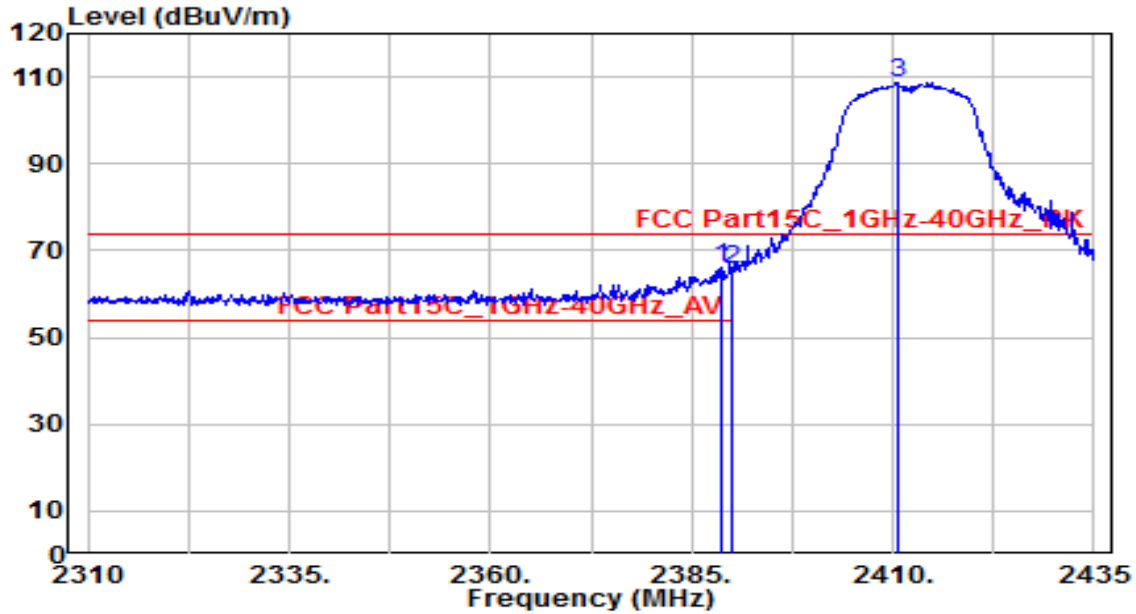

No	Frequency (MHz)	Reading (dBuV)	C.F (dB)	Measurement (dBuV/m)	Margin (dB)	Limit (dBuV/m)	Height (cm)	Angle (deg)	Remark (QP/PK/AV)
1	* 2388.625	33.60	32.29	65.89	-8.11	74.00	170	280	Peak
2	2390.000	33.50	32.30	65.79	-8.21	74.00	170	280	Peak
3	2410.625	76.33	32.39	108.72	N/A	N/A	170	280	Peak

Note:

- "\*", means this data is the worst emission level.
- C.F (Correction Factor) = Antenna Factor (dB)+ Cable Loss (dB).
- Measurement (dBuV/m) = Reading(dBuV) + C.F (Correction Factor).
- The emission levels of other frequencies are very lower than the limit and not show in test report.



EUT	NCSP3DC	Date of Test	2020-09-24
Factor	BBHA 9120D	Temp. / Humidity	25°C /55%
Polarity	Vertical	Site / Test Engineer	AC1 / Jay
Test Mode	802.11g_TX_CH 1_ANT 0	Test Voltage	DC 12V

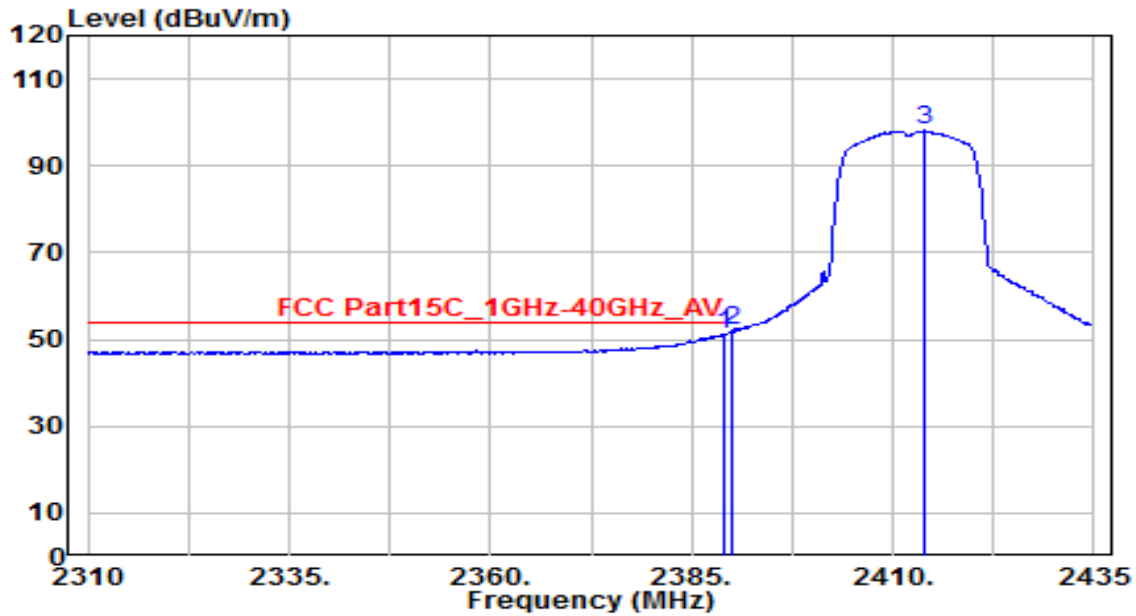

No	Frequency (MHz)	Reading (dBuV)	C.F (dB)	Measurement (dBuV/m)	Margin (dB)	Limit (dBuV/m)	Height (cm)	Angle (deg)	Remark (QP/PK/AV)
1	2389.000	19.05	32.29	51.34	-2.66	54.00	170	280	Average
2	* 2390.000	19.59	32.30	51.89	-2.11	54.00	170	280	Average
3	2414.000	65.67	32.40	98.07	N/A	N/A	170	280	Average

Note:

- "\*", means this data is the worst emission level.
- C.F (Correction Factor) = Antenna Factor (dB)+ Cable Loss (dB).
- Measurement (dBuV/m) = Reading(dBuV) + C.F (Correction Factor).
- The emission levels of other frequencies are very lower than the limit and not show in test report.

EUT	NCSP3DC	Date of Test	2020-09-24
Factor	BBHA 9120D	Temp. / Humidity	25°C /55%
Polarity	Horizontal	Site / Test Engineer	AC1 / Jay
Test Mode	802.11g_TX_CH 11_ANT 0	Test Voltage	DC 12V

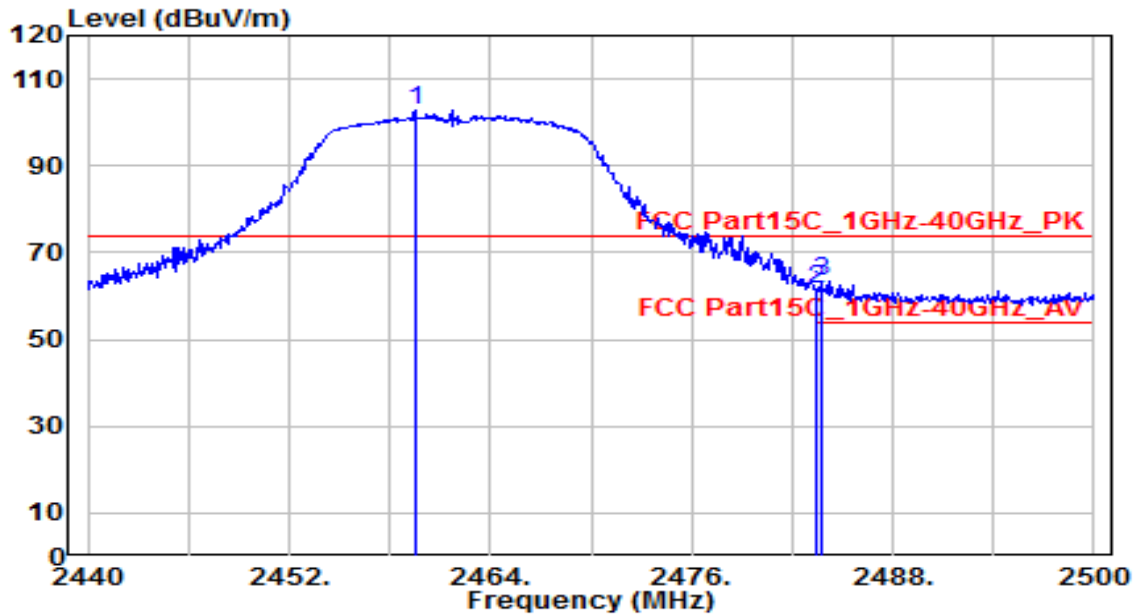

No	Frequency (MHz)	Reading (dBUV)	C.F (dB)	Measurement (dBUV/m)	Margin (dB)	Limit (dBUV/m)	Height (cm)	Angle (deg)	Remark (QP/PK/AV)
1	2459.500	70.24	32.60	102.84	N/A	N/A	200	305	Peak
2	2483.500	28.66	32.71	61.37	-12.63	74.00	200	305	Peak
3	* 2483.740	30.88	32.71	63.58	-10.42	74.00	200	305	Peak

Note:

- "\*", means this data is the worst emission level.
- C.F (Correction Factor) = Antenna Factor (dB)+ Cable Loss (dB).
- Measurement (dBUV/m) = Reading(dBUV) + C.F (Correction Factor).
- The emission levels of other frequencies are very lower than the limit and not show in test report.

EUT	NCSP3DC	Date of Test	2020-09-24
Factor	BBHA 9120D	Temp. / Humidity	25°C /55%
Polarity	Horizontal	Site / Test Engineer	AC1 / Jay
Test Mode	802.11g_TX_CH 11_ANT 0	Test Voltage	DC 12V

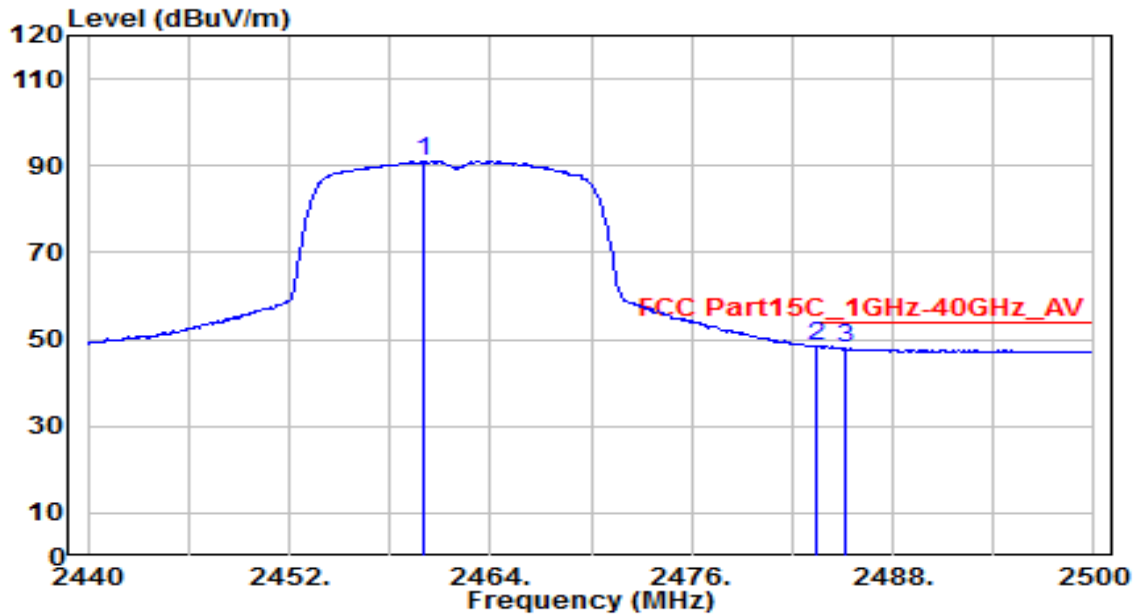

No	Frequency (MHz)	Reading (dBUV)	C.F (dB)	Measurement (dBUV/m)	Margin (dB)	Limit (dBUV/m)	Height (cm)	Angle (deg)	Remark (QP/PK/AV)
1	2459.980	58.39	32.60	90.99	N/A	N/A	200	305	Average
2	* 2483.500	15.71	32.71	48.42	-5.58	54.00	200	305	Average
3	2485.180	15.13	32.71	47.84	-6.16	54.00	200	305	Average

Note:

- "\*", means this data is the worst emission level.
- C.F (Correction Factor) = Antenna Factor (dB)+ Cable Loss (dB).
- Measurement (dBUV/m) = Reading(dBUV) + C.F (Correction Factor).
- The emission levels of other frequencies are very lower than the limit and not show in test report.

EUT	NCSP3DC	Date of Test	2020-09-24
Factor	BBHA 9120D	Temp. / Humidity	25°C /55%
Polarity	Vertical	Site / Test Engineer	AC1 / Jay
Test Mode	802.11g_TX_CH 11_ANT 0	Test Voltage	DC 12V

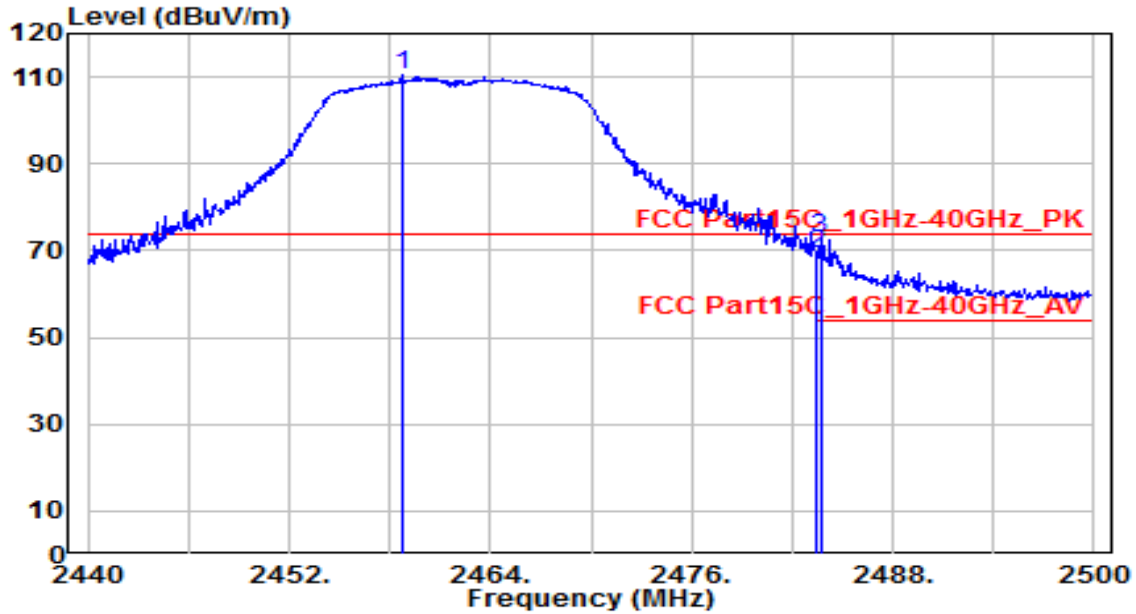

No	Frequency (MHz)	Reading (dBuV)	C.F (dB)	Measurement (dBuV/m)	Margin (dB)	Limit (dBuV/m)	Height (cm)	Angle (deg)	Remark (QP/PK/AV)
1	2458.720	77.94	32.60	110.54	N/A	N/A	200	260	Peak
2	2483.500	36.36	32.71	69.07	-4.93	74.00	200	260	Peak
3	* 2483.680	40.17	32.71	72.88	-1.12	74.00	200	260	Peak

Note:

1. " \*", means this data is the worst emission level.
2. C.F (Correction Factor) = Antenna Factor (dB)+ Cable Loss (dB).
3. Measurement (dBuV/m) = Reading(dBuV) + C.F (Correction Factor).
4. The emission levels of other frequencies are very lower than the limit and not show in test report.

EUT	NCSP3DC	Date of Test	2020-09-24
Factor	BBHA 9120D	Temp. / Humidity	25°C /55%
Polarity	Vertical	Site / Test Engineer	AC1 / Jay
Test Mode	802.11g_TX_CH 11_ANT 0	Test Voltage	DC 12V

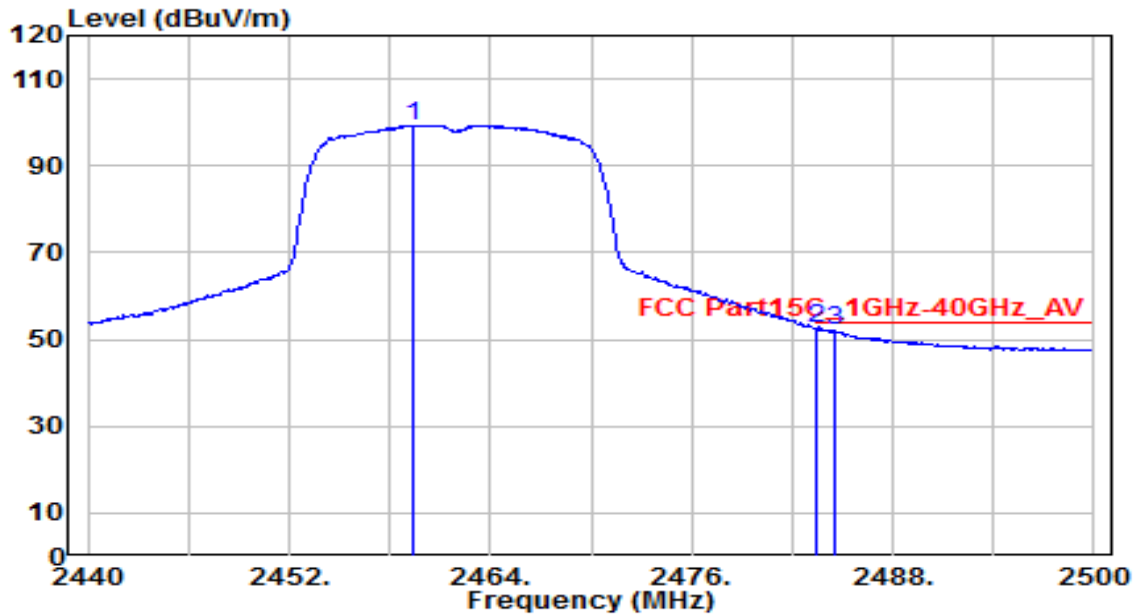

No	Frequency (MHz)	Reading (dBUV)	C.F (dB)	Measurement (dBUV/m)	Margin (dB)	Limit (dBUV/m)	Height (cm)	Angle (deg)	Remark (QP/PK/AV)
1	2459.320	66.76	32.60	99.36	N/A	N/A	200	260	Average
2	* 2483.500	19.92	32.71	52.62	-1.38	54.00	200	260	Average
3	2484.520	19.52	32.71	52.23	-1.77	54.00	200	260	Average

Note:

- "\*", means this data is the worst emission level.
- C.F (Correction Factor) = Antenna Factor (dB)+ Cable Loss (dB).
- Measurement (dBUV/m) = Reading(dBUV) + C.F (Correction Factor).
- The emission levels of other frequencies are very lower than the limit and not show in test report.

EUT	NCSP3DC	Date of Test	2020-09-24
Factor	BBHA 9120D	Temp. / Humidity	25°C /55%
Polarity	Horizontal	Site / Test Engineer	AC1 / Jay
Test Mode	802.11n-20MHz_TX_CH 1_ANT 0	Test Voltage	DC 12V

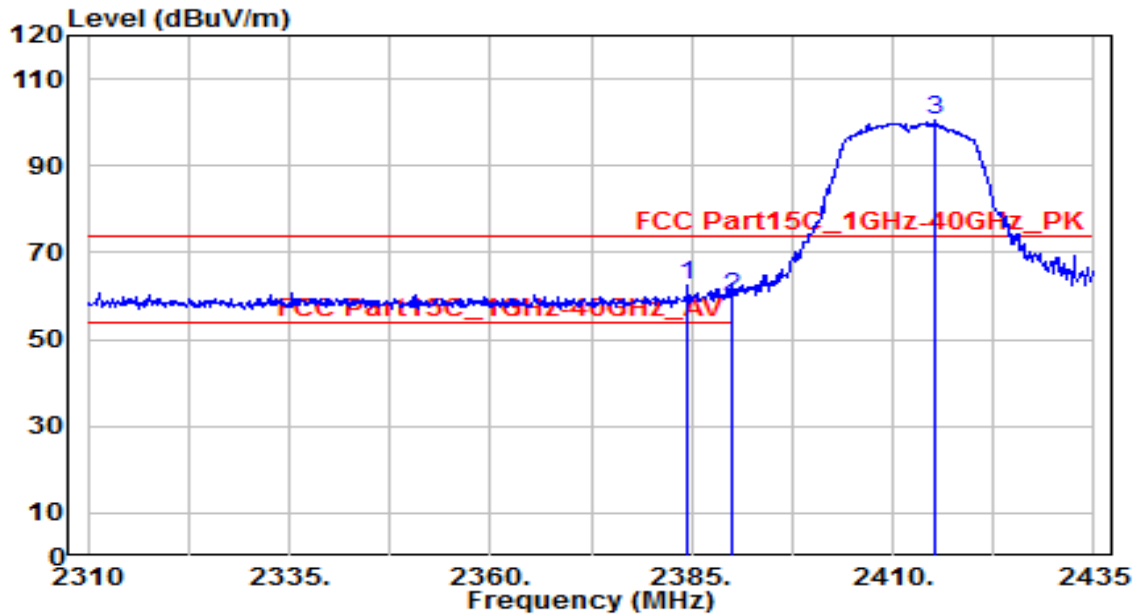

No	Frequency (MHz)	Reading (dBUV)	C.F (dB)	Measurement (dBUV/m)	Margin (dB)	Limit (dBUV/m)	Height (cm)	Angle (deg)	Remark (QP/PK/AV)
1	* 2384.500	30.35	32.27	62.63	-11.37	74.00	145	330	Peak
2	2390.000	27.39	32.30	59.68	-14.32	74.00	145	330	Peak
3	2415.375	67.92	32.41	100.33	N/A	N/A	145	330	Peak

Note:

1. " \*", means this data is the worst emission level.
2. C.F (Correction Factor) = Antenna Factor (dB)+ Cable Loss (dB).
3. Measurement (dBUV/m) = Reading(dBUV) + C.F (Correction Factor).
4. The emission levels of other frequencies are very lower than the limit and not show in test report.

EUT	NCSP3DC	Date of Test	2020-09-24
Factor	BBHA 9120D	Temp. / Humidity	25°C /55%
Polarity	Horizontal	Site / Test Engineer	AC1 / Jay
Test Mode	802.11n-20MHz_TX_CH 1_ANT 0	Test Voltage	DC 12V

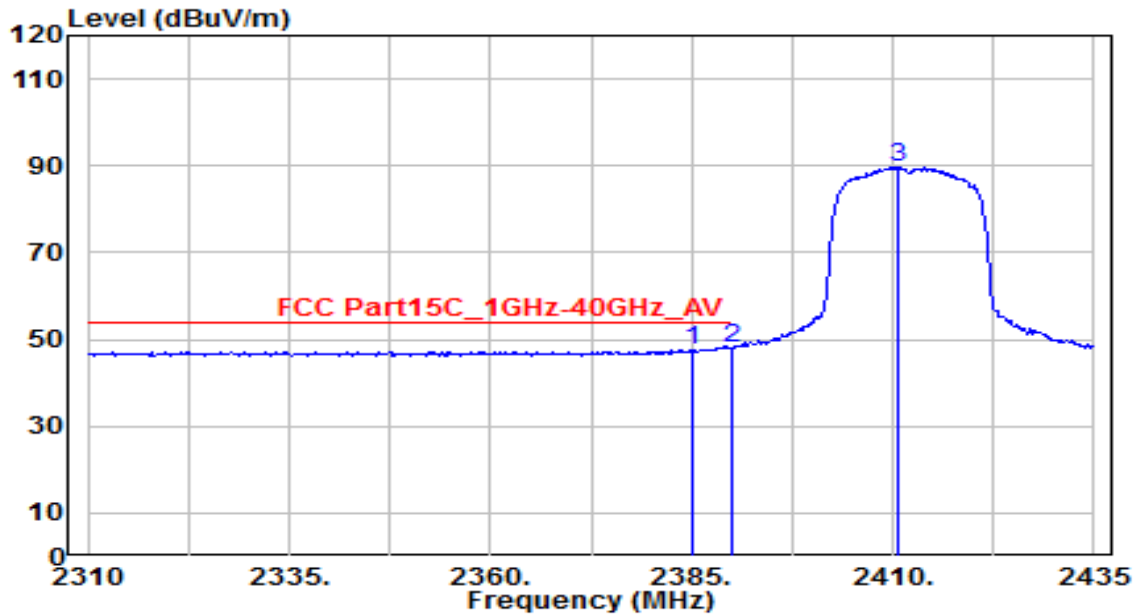

No	Frequency (MHz)	Reading (dBuV)	C.F (dB)	Measurement (dBuV/m)	Margin (dB)	Limit (dBuV/m)	Height (cm)	Angle (deg)	Remark (QP/PK/AV)
1	2385.000	15.48	32.27	47.75	-6.25	54.00	145	330	Average
2	* 2390.000	15.58	32.30	47.87	-6.13	54.00	145	330	Average
3	2410.750	57.43	32.39	89.81	N/A	N/A	145	330	Average

Note:

- "\*", means this data is the worst emission level.
- C.F (Correction Factor) = Antenna Factor (dB)+ Cable Loss (dB).
- Measurement (dBuV/m) = Reading(dBuV) + C.F (Correction Factor).
- The emission levels of other frequencies are very lower than the limit and not show in test report.

EUT	NCSP3DC	Date of Test	2020-09-24
Factor	BBHA 9120D	Temp. / Humidity	25°C /55%
Polarity	Vertical	Site / Test Engineer	AC1 / Jay
Test Mode	802.11n-20MHz_TX_CH 1_ANT 0	Test Voltage	DC 12V

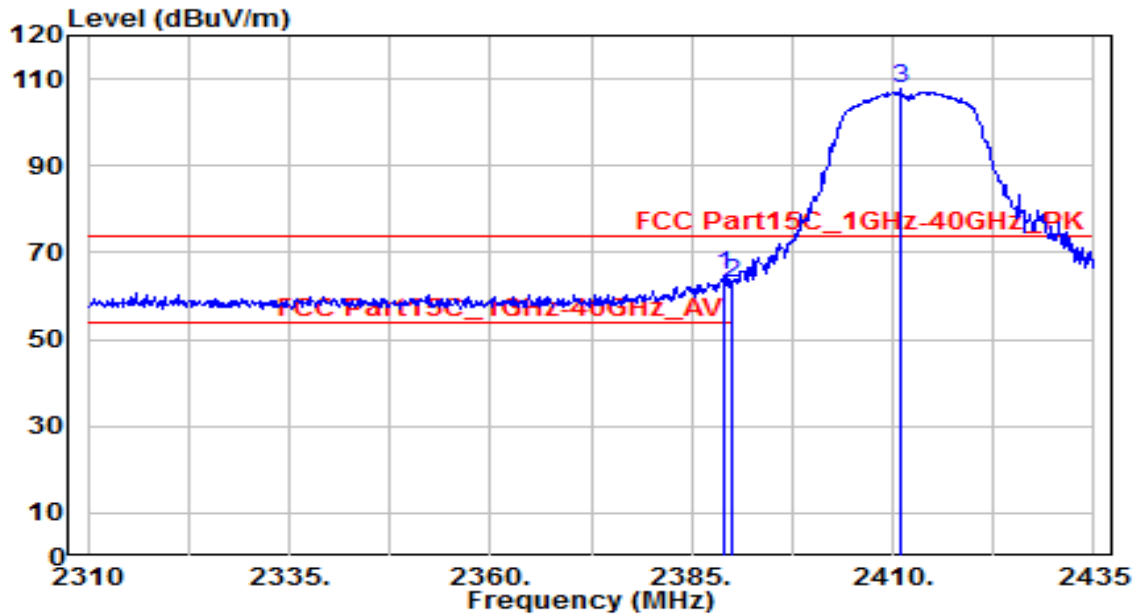

No	Frequency (MHz)	Reading (dBuV)	C.F (dB)	Measurement (dBuV/m)	Margin (dB)	Limit (dBuV/m)	Height (cm)	Angle (deg)	Remark (QP/PK/AV)
1	* 2389.000	32.25	32.29	64.54	-9.46	74.00	170	280	Peak
2	2390.000	30.74	32.30	63.04	-10.96	74.00	170	280	Peak
3	2410.875	75.19	32.39	107.58	N/A	N/A	170	280	Peak

Note:

- "\*", means this data is the worst emission level.
- C.F (Correction Factor) = Antenna Factor (dB)+ Cable Loss (dB).
- Measurement (dBuV/m) = Reading(dBuV) + C.F (Correction Factor).
- The emission levels of other frequencies are very lower than the limit and not show in test report.



EUT	NCSP3DC	Date of Test	2020-09-24
Factor	BBHA 9120D	Temp. / Humidity	25°C /55%
Polarity	Vertical	Site / Test Engineer	AC1 / Jay
Test Mode	802.11n-20MHz_TX_CH 1_ANT 0	Test Voltage	DC 12V

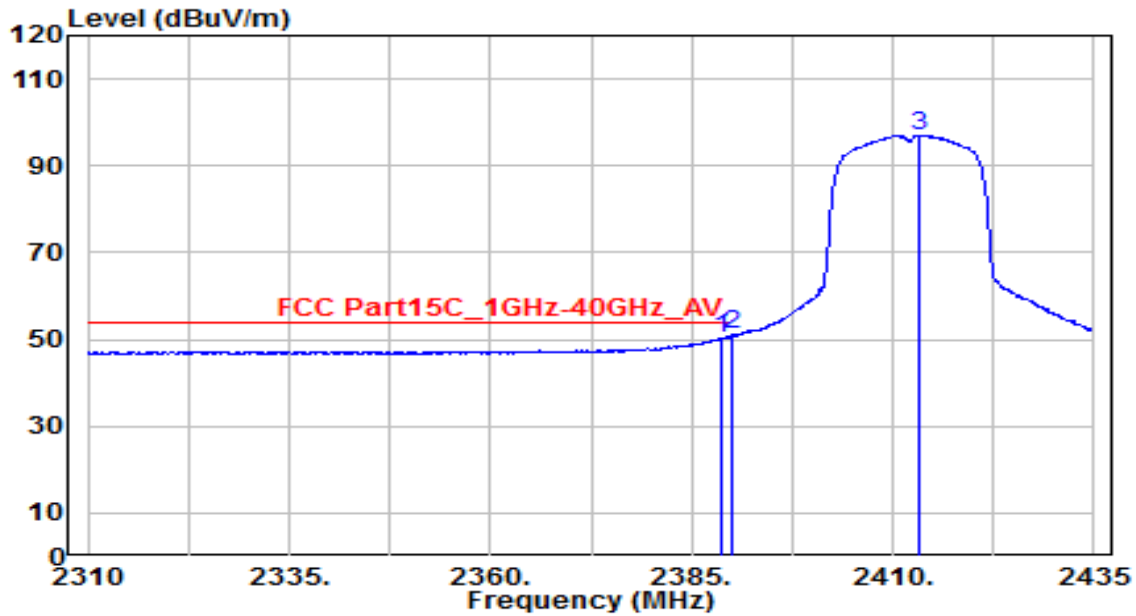

No	Frequency (MHz)	Reading (dBuV)	C.F (dB)	Measurement (dBuV/m)	Margin (dB)	Limit (dBuV/m)	Height (cm)	Angle (deg)	Remark (QP/PK/AV)
1	2388.750	17.83	32.29	50.12	-3.88	54.00	170	280	Average
2	* 2390.000	18.69	32.30	50.99	-3.01	54.00	170	280	Average
3	2413.375	64.63	32.40	97.03	N/A	N/A	170	280	Average

Note:

- "\*", means this data is the worst emission level.
- C.F (Correction Factor) = Antenna Factor (dB)+ Cable Loss (dB).
- Measurement (dBuV/m) = Reading(dBuV) + C.F (Correction Factor).
- The emission levels of other frequencies are very lower than the limit and not show in test report.

EUT	NCSP3DC	Date of Test	2020-09-24
Factor	BBHA 9120D	Temp. / Humidity	25°C /55%
Polarity	Horizontal	Site / Test Engineer	AC1 / Jay
Test Mode	802.11n-20MHz_TX_CH 11_ANT 0	Test Voltage	DC 12V

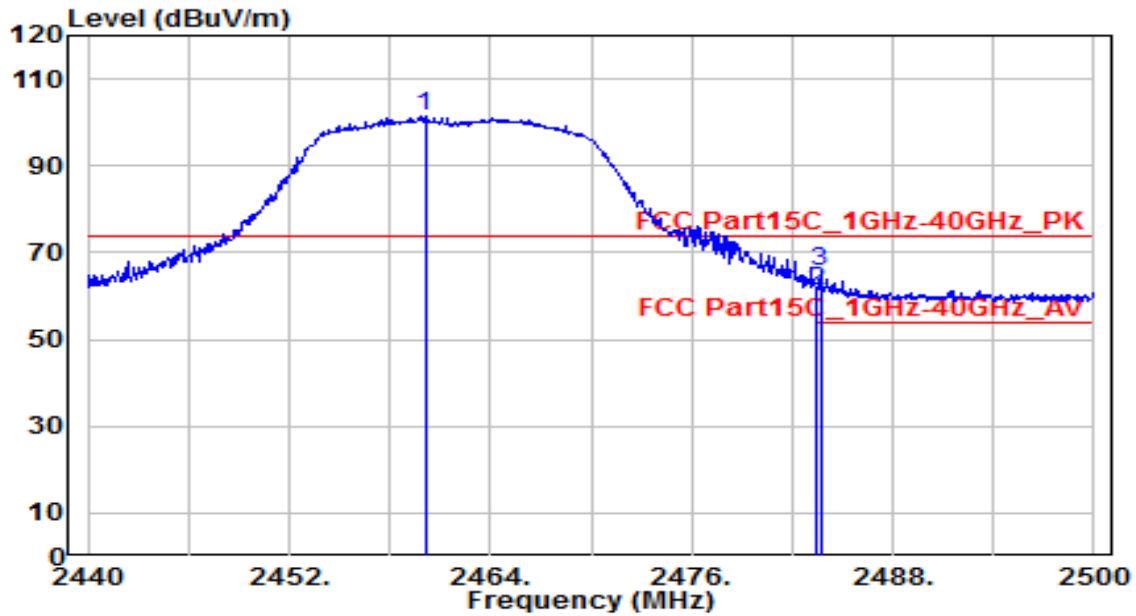

No	Frequency (MHz)	Reading (dBuV)	C.F (dB)	Measurement (dBuV/m)	Margin (dB)	Limit (dBuV/m)	Height (cm)	Angle (deg)	Remark (QP/PK/AV)
1	2460.100	68.87	32.60	101.48	N/A	N/A	200	305	Peak
2	2483.500	28.36	32.71	61.07	-12.93	74.00	200	305	Peak
3	* 2483.680	32.79	32.71	65.50	-8.50	74.00	200	305	Peak

Note:

1. " \*", means this data is the worst emission level.
2. C.F (Correction Factor) = Antenna Factor (dB)+ Cable Loss (dB).
3. Measurement (dBuV/m) = Reading(dBuV) + C.F (Correction Factor).
4. The emission levels of other frequencies are very lower than the limit and not show in test report.

EUT	NCSP3DC	Date of Test	2020-09-24
Factor	BBHA 9120D	Temp. / Humidity	25°C /55%
Polarity	Horizontal	Site / Test Engineer	AC1 / Jay
Test Mode	802.11n-20MHz_TX_CH 11_ANT 0	Test Voltage	DC 12V

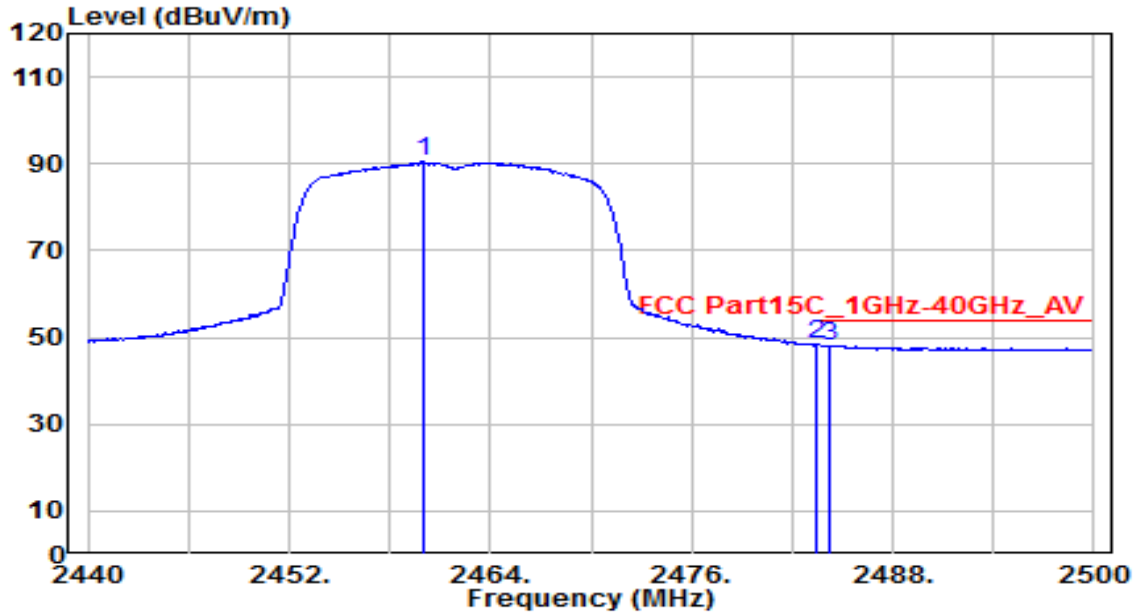

No	Frequency (MHz)	Reading (dBuV)	C.F (dB)	Measurement (dBuV/m)	Margin (dB)	Limit (dBuV/m)	Height (cm)	Angle (deg)	Remark (QP/PK/AV)
1	2460.040	57.86	32.60	90.47	N/A	N/A	200	305	Average
2	* 2483.500	15.74	32.71	48.45	-5.55	54.00	200	305	Average
3	2484.220	15.43	32.71	48.14	-5.86	54.00	200	305	Average

Note:

1. " \*", means this data is the worst emission level.
2. C.F (Correction Factor) = Antenna Factor (dB)+ Cable Loss (dB).
3. Measurement (dBuV/m) = Reading(dBuV) + C.F (Correction Factor).
4. The emission levels of other frequencies are very lower than the limit and not show in test report.

EUT	NCSP3DC	Date of Test	2020-09-24
Factor	BBHA 9120D	Temp. / Humidity	25°C /55%
Polarity	Vertical	Site / Test Engineer	AC1 / Jay
Test Mode	802.11n-20MHz_TX_CH 11_ANT 0	Test Voltage	DC 12V

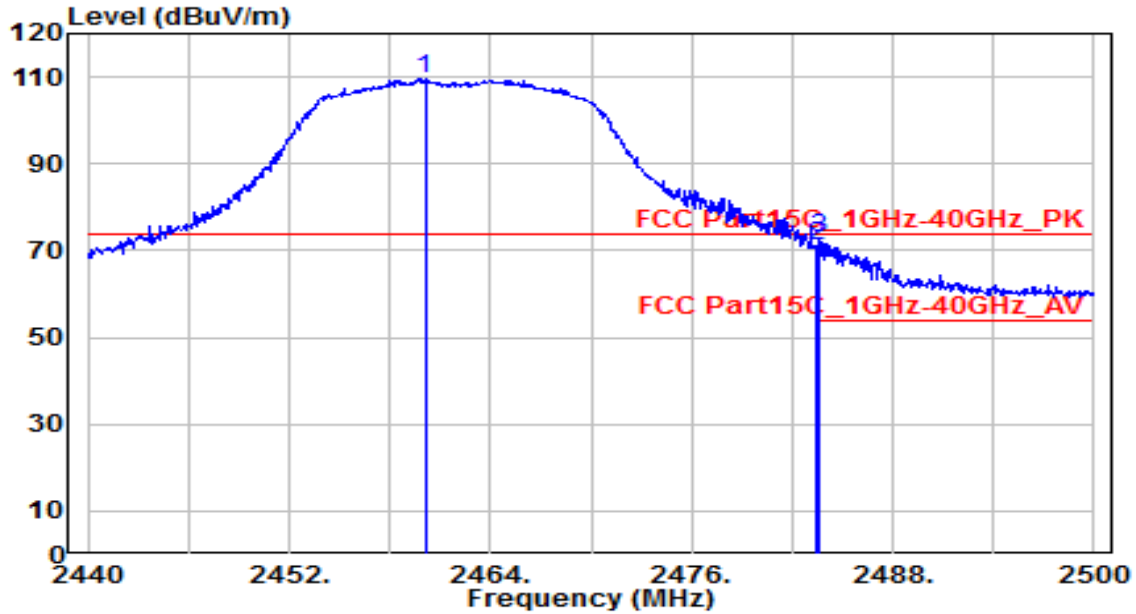

No	Frequency (MHz)	Reading (dBUV)	C.F (dB)	Measurement (dBUV/m)	Margin (dB)	Limit (dBUV/m)	Height (cm)	Angle (deg)	Remark (QP/PK/AV)
1	2460.100	76.86	32.60	109.46	N/A	N/A	200	260	Peak
2	2483.500	38.46	32.71	71.17	-2.83	74.00	200	260	Peak
3	* 2483.620	40.20	32.71	72.90	-1.10	74.00	200	260	Peak

Note:

- "\*", means this data is the worst emission level.
- C.F (Correction Factor) = Antenna Factor (dB)+ Cable Loss (dB).
- Measurement (dBUV/m) = Reading(dBUV) + C.F (Correction Factor).
- The emission levels of other frequencies are very lower than the limit and not show in test report.

EUT	NCSP3DC	Date of Test	2020-09-24
Factor	BBHA 9120D	Temp. / Humidity	25°C /55%
Polarity	Vertical	Site / Test Engineer	AC1 / Jay
Test Mode	802.11n-20MHz_TX_CH 11_ANT 0	Test Voltage	DC 12V

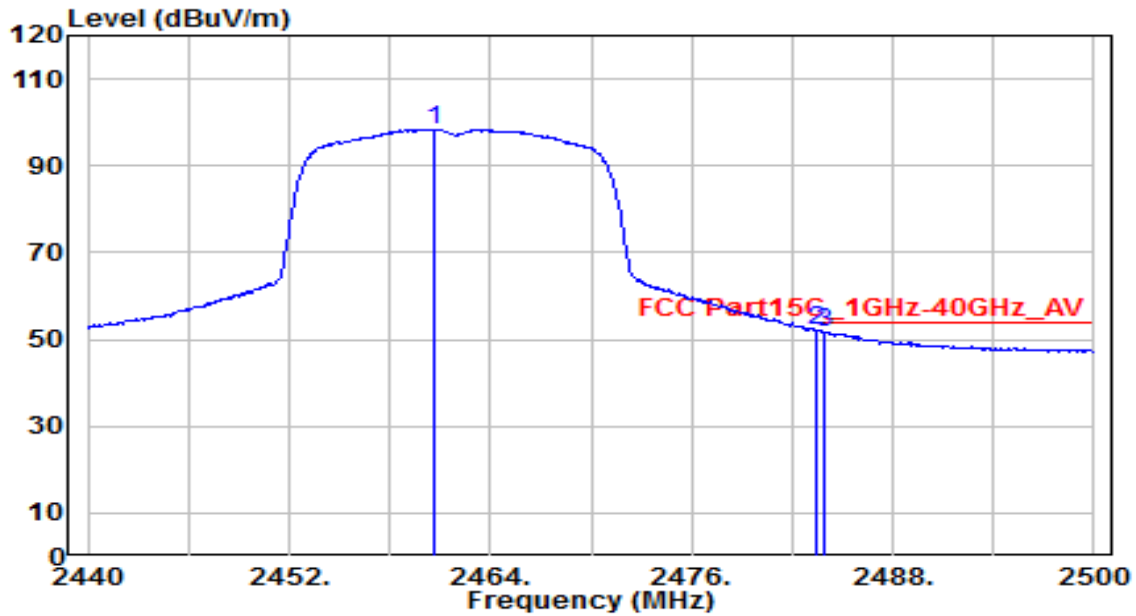

No	Frequency (MHz)	Reading (dBUV)	C.F (dB)	Measurement (dBUV/m)	Margin (dB)	Limit (dBUV/m)	Height (cm)	Angle (deg)	Remark (QP/PK/AV)
1	2460.700	65.85	32.61	98.46	N/A	N/A	200	260	Average
2	* 2483.500	19.32	32.71	52.03	-1.97	54.00	200	260	Average
3	2483.860	19.03	32.71	51.74	-2.26	54.00	200	260	Average

Note:

- "\*", means this data is the worst emission level.
- C.F (Correction Factor) = Antenna Factor (dB)+ Cable Loss (dB).
- Measurement (dBUV/m) = Reading(dBUV) + C.F (Correction Factor).
- The emission levels of other frequencies are very lower than the limit and not show in test report.

## 7.8. AC Conducted Emissions Measurement

### 7.8.1. Test Limit

FCC Part 15 Subpart C Paragraph 15.207 / RSS-Gen Limits		
Frequency (MHz)	QP (dB $\mu$ V)	Average (dB $\mu$ V)
0.15 - 0.50	66 - 56	56 - 46
0.50 - 5.0	56	46
5.0 - 30	60	50

Note 1: The lower limit shall apply at the transition frequencies.

Note 2: The limit decreases linearly with the logarithm of the frequency in the range 0.15MHz to 0.5MHz.

### 7.8.2. Test Setup

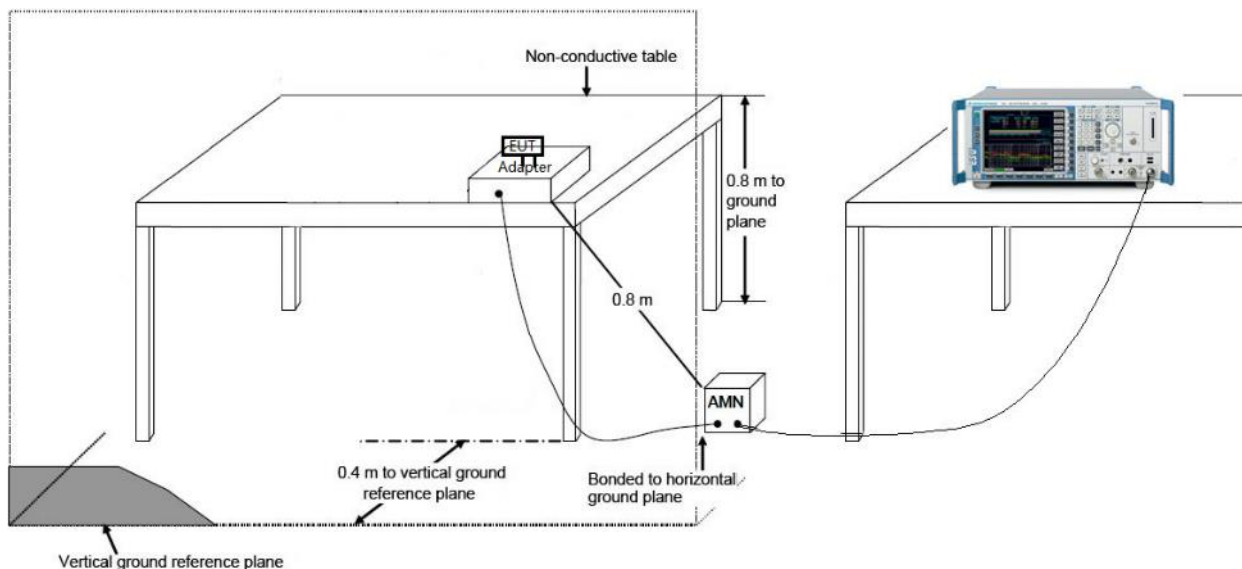

### 7.8.3. Test Result

Note: The EUT Power Input DC 12V, so do not need to test Conducted Emissions.

## 8. CONCLUSION

The data collected relate only the item(s) tested and show that the **NCSP3 Display Commander** is in compliance with Part 15C of the FCC Rules.

————— The End —————