



MA110

MARINE AUDIO SYSTEM

Installation and Operation Manual



CONTENTS

Warning and Compliance	1
Introduction	2
Installation	3
Wiring Diagram.....	4
Basic Operation	5
Tuner Operation	7
Bluetooth Operation	8
APP Operation	10
Care and Maintenance	10
Troubleshooting	11
Specification	11

WARNING AND COMPLIANCE

Important Safety Instructions

- To ensure full satisfaction with the product, please read the entire instruction manual.
- Keep instructions for future reference.
- Follow all operation guidelines and adhere to all safety warnings and cautions to ensure safe use.
- Do not install near any heat sources such as radiators, heat registers, stoves, or other apparatus (including amplifiers) that produce heat.
- Only use attachments/accessories specified by the manufacturer.
- Never use harsh cleaning agents. Clean only with a dry cloth.

When Driving

- Keep the volume level low enough to be aware of your surroundings.

Protect from Water

- Do not submerge, as this can cause electrical shorts, fire or other damage.

Protect from High Temperatures

- Exposure to direct sunlight for an extended period of time can produce very high temperatures inside your vehicle. Give the interior a chance to cool down before starting playback. Do not mount the radio within close proximity of the engine compartment.

Use the Proper Power Supply

- This product is designed to operate with a 12 volt DC negative ground battery system.

WARNING:

- DO NOT OPEN, DISASSEMBLE OR ALTER THE UNIT IN ANY WAY. Doing so may result in fire, electric shock or product damage.
- USE THE CORRECT AMPERE RATING WHEN REPLACING FUSE. Failure to do so may result in fire, electric shock or product damage.
- DO NOT INSTALL IN LOCATIONS THAT MIGHT HINDER VEHICLE OPERATION. Doing so may obstruct vision or hamper movement which can result in a serious accident.
- INSTALL THE WIRING SO THAT IT IS NOT CRIMPED OR PINCHED BY SCREWS OR SHARP METAL EDGES. Route the cables away from moving parts or sharp pointed edges. This will prevent crimping and damage to the wiring. If the wiring must pass through a metal hole, be sure to use a rubber grommet to prevent the wire's insulation from being cut by the metal edge of the hole. It is also recommended to apply sealing caulk to any opening that may potentially allow water to enter.

- Be sure to choose a location that is flat and has clearance above the unit to prevent any damage, as well as allow for ventilation.
- Before drilling any holes, carefully inspect the area underneath and behind the mounting surface where the device will be mounted to make sure it will not interfere with existing wires, fuel lines, the fuel tank or any other objects that could be damaged.
- Always disconnect the vehicle negative battery terminal during installation to prevent accidental shorting.

Compliance with FCC Rules (U.S.A Only)

This device complies with Part 15 of the FCC rules. Operation is subject to the following two conditions: (1) This device may not cause harmful interference, and (2) this device must accept any interference received), including interference that may cause undesired operation.

This equipment has been tested and found to comply with the limits for a Class B digital device, pursuant to Part 15 of the FCC Rules. These limits are designed to provide reasonable protection against Harmful interference in a residential installation. This equipment generates uses and can radiate radio frequency energy and, if not installed and used in accordance with the instructions, may cause harmful Interference to radio communications.

However, there is no guarantee that interference will not occur in a particular installation. If this equipment does cause harmful interference to radio or television reception, which can be determined by turning the equipment off and on, the user is encouraged to try to correct the interference by one or more of the following measures:

Reorient or relocate the receiving antenna.

Increase the separation between the equipment and receiver.

Connect the equipment into an outlet on a circuit different from that to which the receiver is connected.

Consult the dealer or an experienced radio/TV technician for help.

FCC WARNING

- Changes or modifications to this unit not expressly approved by the party responsible for compliance could void the user's authority to operate the equipment.
- Proper connections must be used for connection to a host computer and/or peripherals in order to meet FCC emission limits.

FCC Radiation Exposure Statement

This equipment complies with FCC radiation exposure limits set forth for an uncontrolled environment

This equipment should be installed and operated with minimum distance 20cm between the radiator & your body.

INTRODUCTION

Thank You!

Thank for choosing a Jensen product. We hope you will find the instructions in this owner's manual clear and easy to follow. If you take a few minutes to look through it, you'll learn how to use all the features of your new Jensen receiver for maximum enjoyment.

Features

Features of the Marine Audio MA110 include:

- Dimmable LCD Backlit Control, TFT Display
- Waterproof iPx6
- Low Battery Alarm
- AM/FM Tuner (US/EURO) with 36 Presets (18 AM, 18 FM)
- Bluetooth (Supports A2DP and AVRCP)
- APP Ready
- Electronic Bass, Treble, Balance and Fader Controls
- Illumination Control (Day and Night)
- UV and Corrosion Resistant
- Rear Auxiliary Audio Input (RCA)
- Rear Auxiliary Audio Output (RCA)
- 4-Channel Amplified Audio Output

Box Content

- Marine Audio MA110 Radio
- Radio Mounting Bracket
- Screw Posts (x2)
- Locking Hex Nuts (x2)
- Washers (x2)
- Quick Reference Guide
- Warranty Card

HARDWARE KIT CONTENTS

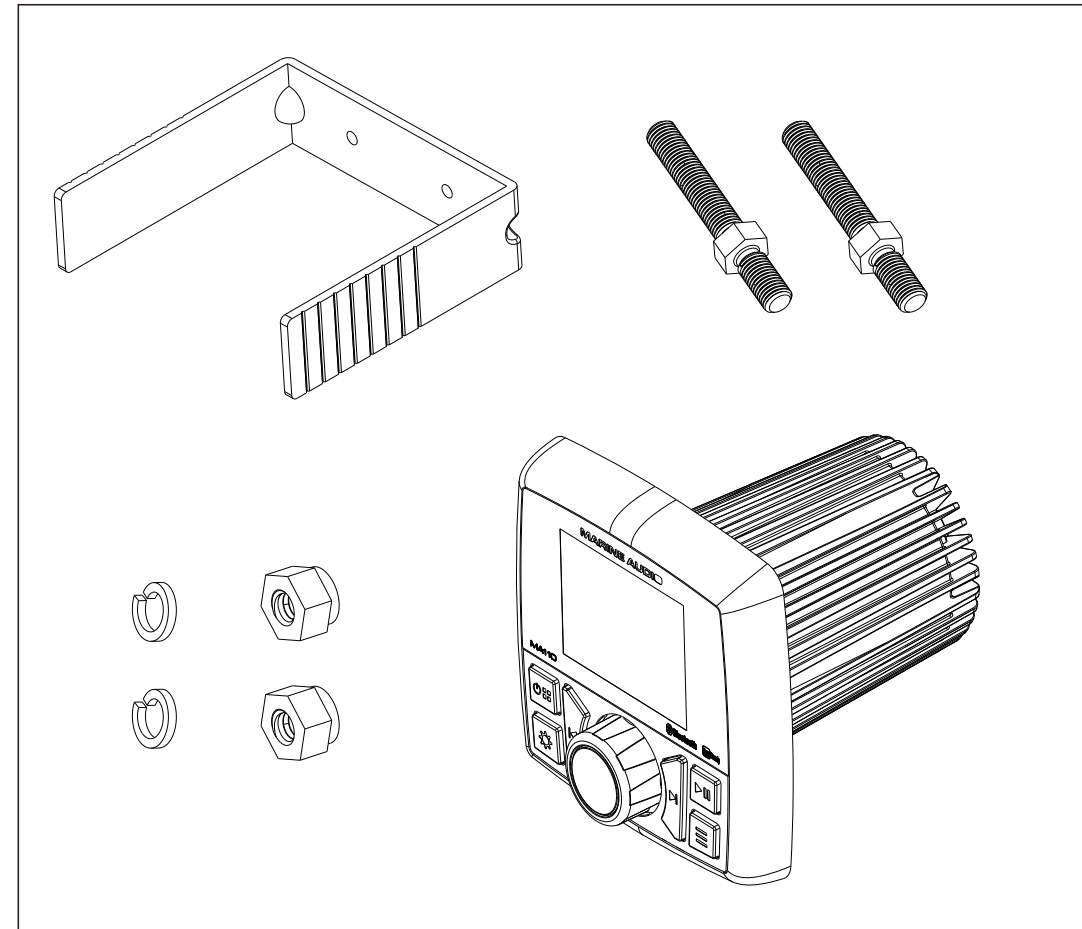

INSTALLATION

Important Notes

- Before you begin, always disconnect the negative battery terminal.
- Before final installation, test the wiring connections to make sure the unit is connected properly and the system works.
- Consult with your nearest dealer if installation requires the drilling of holes or other modification to your vehicle.
- Install the unit where it does not interfere with driving and cannot injure passengers if there is a sudden or emergency stop.

Mounting the Radio

1. Choose a mounting location on the dash board or instrument panel that will allow room behind to run radio cables to the power source. Consider how you will use the AUX IN, LINE OUT and USB connectors and route the appropriate extension cables to an accessible area.
2. Refer to the dimensioned diagram on the right to cut the installation opening.

IMPORTANT! Do not mount this unit where it can be submerged in water.

3. Cut a hole in the dash board using the template provided in the back of this manual. At least 3 3/4" depth is needed to mount the radio.
4. Slide the included spring washers (B) over the screw posts (A) and attach the screw posts to the back of the radio.
5. Place the radio in front of the dashboard opening so the wiring can be brought through the opening.

NOTE: Before final installation, test the wiring connections to make sure the unit is connected properly and the system works.

6. After completing the wiring connections, turn the radio on to confirm operation (vehicle accessory switch must be on). If the radio does not operate, recheck all wiring until the problem is corrected. Once proper operation is achieved, turn the accessory switch off and proceed with final mounting of the radio. Refer to the "Wiring Diagram" on page 4.
7. Insert the radio into the mounting hole and make sure it is right-side-up.
8. Place the "U" bracket (C) over the screw posts and secure the radio to the dash using the included hex nuts (D). If necessary, cut the score marks (E) on either side of the mounting bracket to custom fit the bracket length for your application. See Figure A.

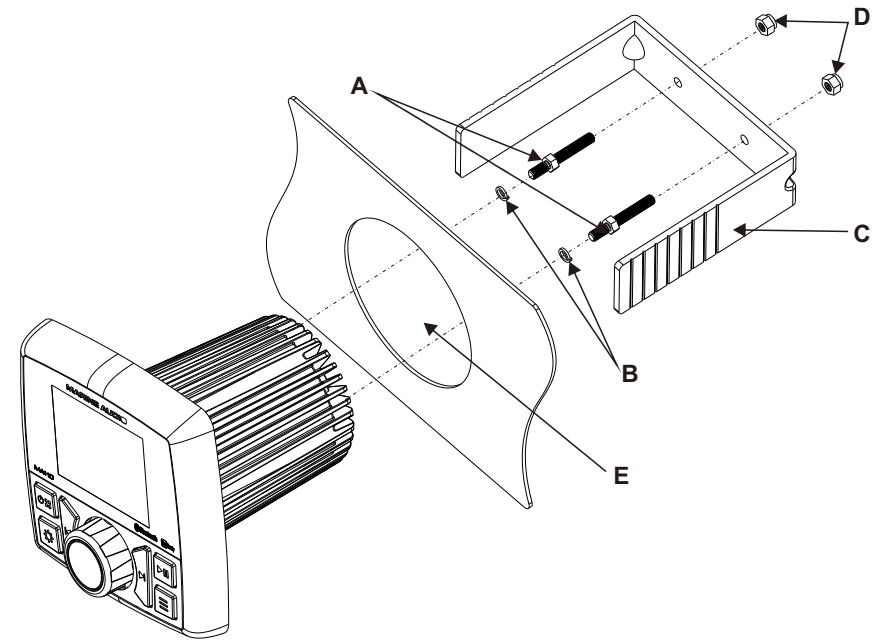

Figure A - Installation

Auxiliary Input

Connect a portable audio device to the Audio Input (AUX IN RIGHT/LEFT) on the back of the unit using RCA cables.

Line Output

The Line Out connectors (LINE OUT RIGHT/LEFT) on the back of the unit output a line-level analog signal. Use this output to connect to an external amplifier

WIRING DIAGRAM

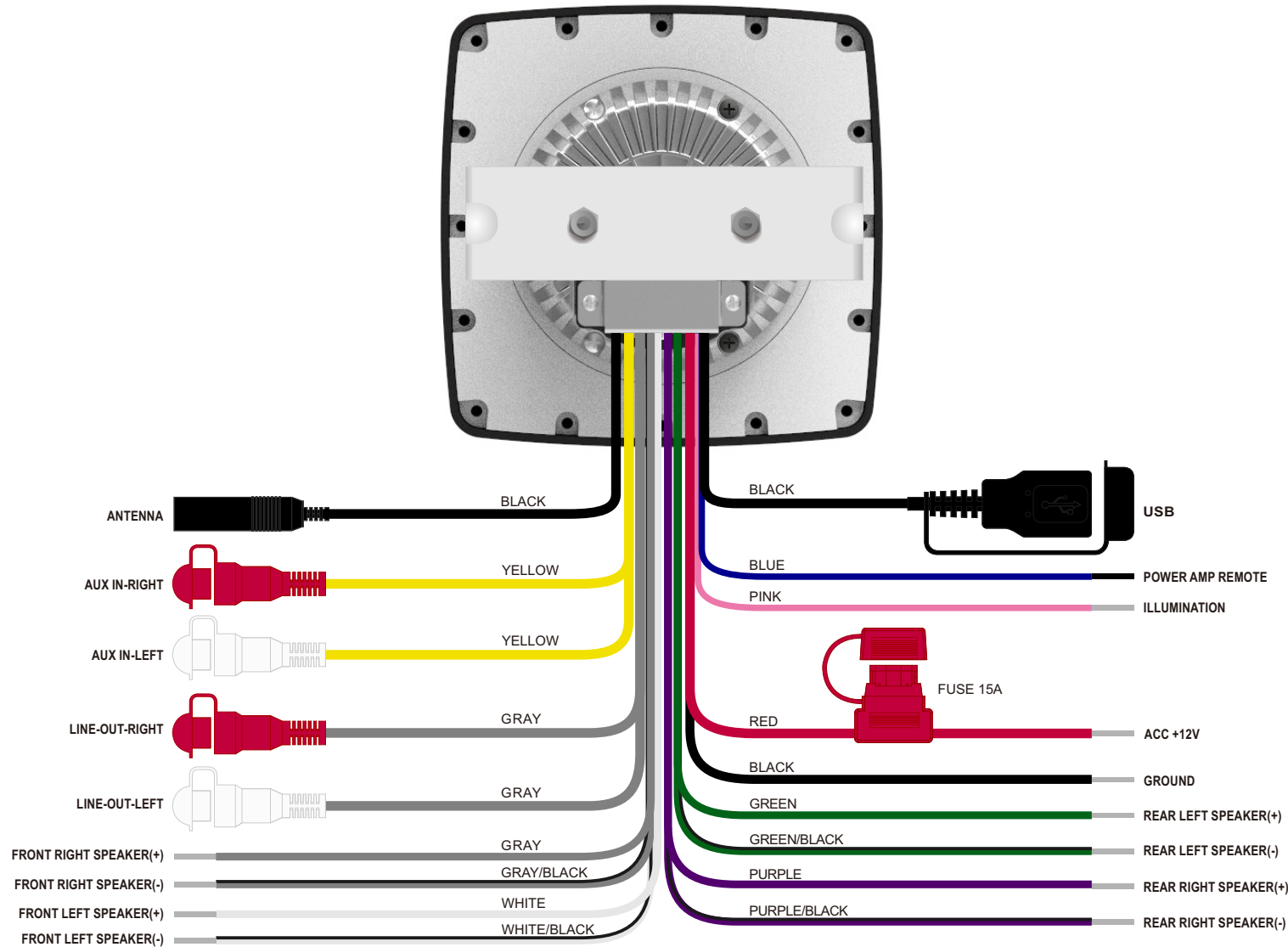



WIRE COLOR	DESCRIPTION
PURPLE	RIGHT REAR SPEAKER(+)
PURPLE/BLACK	RIGHT REAR SPEAKER(-)
GRAY	RIGHT FRONT SPEAKER(+)
GRAY/BLACK	RIGHT FRONT SPEAKER(-)
WHITE	LEFT FRONT SPEAKER(+)
WHITE/BLACK	LEFT FRONT SPEAKER(-)
GREEN	LEFT REAR SPEAKER(+)
GREEN/BLACK	LEFT REAR SPEAKER(-)
RED	ACC +12V
BLACK	GROUND
BLUE	POWER AMP REMOTE
PINK	ILLUMINATION

Note: Do not connect the red wire to a constant power connection. The red wire should be connected to a vehicle connection with switched power such as IGN or ACC.

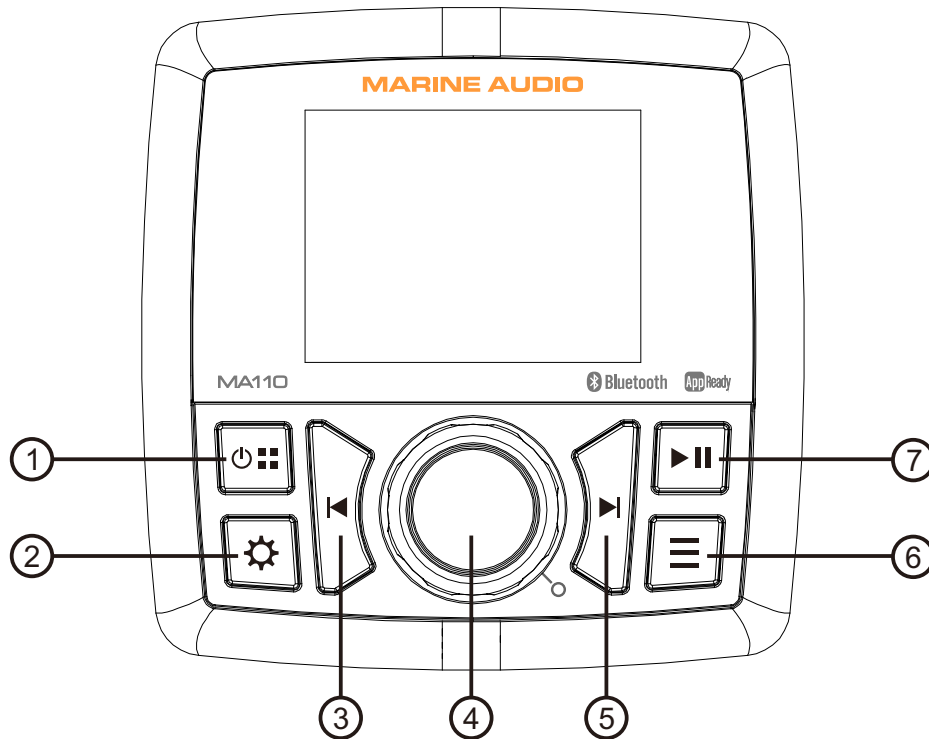
BASIC OPERATION



Power On/Off

Press the  power button (1) to turn the unit on.
Press and hold the  power button (1) to turn the unit off.

Volume Control

Rotate the **VOL/ENTER** knob (4) clockwise to increase or counter-clockwise to decrease the volume.

Play/Pause/Mute

Press the  button (7) to silence the audio output in Tuner, AUX or Bluetooth mode. Press again to restore the previous volume level.

Mode

Press the  button (1) to enter source menu. Rotate the **VOL/ENTER** knob (4) to navigate through the available modes and press the **VOL/ENTER** knob (4) to select the desired mode. Available modes are AM, FM, Bluetooth and AUX input.

Audio Settings

Equalizer 

Loudness On

Balance & Fade 

System Settings 

 Back  Select

Audio Settings

Press  button (2) to access the audio settings. Rotate **VOL/ENTER** knob (4) to navigate through the following menu setting items: Equalizer (TREBLE, BASS), Loudness (ON/OFF), Balance & Fade and System Settings. Press **VOL/ENTER** buttons (4) to select the item. The unit will automatically exit the Audio Settings after seven seconds of inactivity.

The following Audio setting items can be adjusted.

Equalizer

TREBLE: Press **VOL/ENTER** button (4) to activate the Treble control. Rotate **VOL/ENTER** knob (4) to adjust the Treble level from “-7” to “+7”.

BASS: Press **VOL/ENTER** button (4) to activate the Bass control. Rotate **VOL/ENTER** knob (4) to adjust the Bass level from “-7” to “+7”.

Loudness

Press the **VOL/ENTER** button (4) to toggle loudness on/off/ when listening to music at low volumes, this feature will boost the bass and treble ranges.

Balance & Fade

BALANCE: Press **VOL/ENTER** knob button (4) to activate the Balance control. Rotate **VOL/ENTER** knob (4) to adjust the Balance level from “L7” to “R7”.

FADE: Press **VOL/ENTER** knob button (4) to activate the Fade control. Rotate the **VOL/ENTER** knob (4) to adjust the Fade level from “R7” to “F7”.

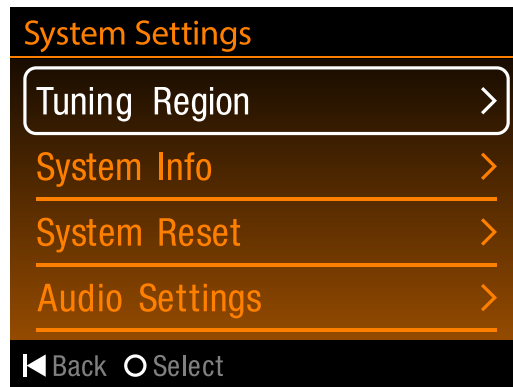
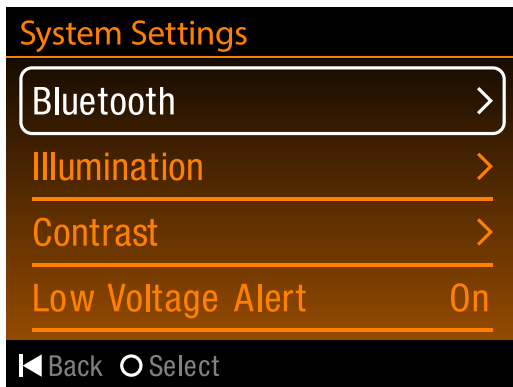

System Settings

Press **VOL/ENTER** knob button (4) to enter the system settings. Rotate the **VOL/ENTER** button (4) to navigate through the following menu setting items: Bluetooth, Illumination, Contrast, Low Voltage Alert, Tuning Region, System Info, System Reset and Audio Settings. Press the **VOL/ENTER** buttons (4) to select the item. The unit will automatically exit the Audio Settings after seven seconds of inactivity.

The following System Setting items can be adjusted.

BLUETOOTH

Pair Device: Press the Enter button to pair a device.

Paired Device: View, lock and delete from a list of previously paired mobile device models.

ILLUMINATION

Press the **VOL/ENTER** encoder button (4) to cycle through DAY, NIGHT or AUTO mode.

Day Mode

Display: Adjust the display brightness.

Buttons: Adjust the buttons brightness.

Press **VOL/ENTER** knob button (4) to activate the brightness control, then rotate **VOL/ENTER** knob (4) clockwise or counter-clockwise to adjust desire brightness from level "1" to "10" for day mode.

Night Mode

Display: Adjust the display brightness.

Buttons: Adjust the buttons brightness.

Press **VOL/ENTER** knob button (4) to activate the brightness control, then rotate **VOL/ENTER** knob (4) clockwise or counter-clockwise to adjust desire brightness from level "1" to "10" for night mode.

Auto Mode

Automatically switches illumination from Day mode to Night mode when illumination trigger lead is energized +12VDC.

CONTRAST

Rotate the **VOL/ENTER** knob (4) clockwise or counter-clockwise to adjust desire display contrast.

LOW VOLTAGE ALERT

Press **VOL/ENTER** knob button (4) to turn the low voltage alert on or off. When low voltage alert turn on, it will monitor input voltage on ACC line. When the battery voltage is low (drops below 10.5V (+/-0.3V), the audible beep tone will sound interval from speaker and the display will flash LOW VOLTAGE on the bottom of the display.

TUNING REGION

Rotate the **VOL/ENTER** knob (4) to select the tuner region frequency step: North America or Europe, press **VOL/ENTER** button (4) to confirm selection.

SYSTEM INFO

Press the **VOL/ENTER** button (4) to view software version information.

SYSTEM RESET

Press the **VOL/ENTER** button (4) to enter system reset menu. Rotate the **VOL/ENTER** knob (4) to select "Confirm" and press **VOL/ENTER** button (4) to confirm factory default restore. This function will time out after 5 seconds of inactivity and the unit will resume normal operation. After reset, the unit will default to FM mode.

AUDIO SETTINGS

Press **VOL/ENTER** button (4) to enter Audio Settings menu.

Back Key

Press **◀** button (3) to return previous settings menu.

Auxiliary Input

Connect the portable audio device to the AUX IN cable routed from the rear of the radio. Press the **📶** button (1) to enter the source menu. Then rotate the **VOL/ENTER** knob (4) to select Auxiliary mode and press **VOL/ENTER** button (4) to enter Auxiliary playback mode.



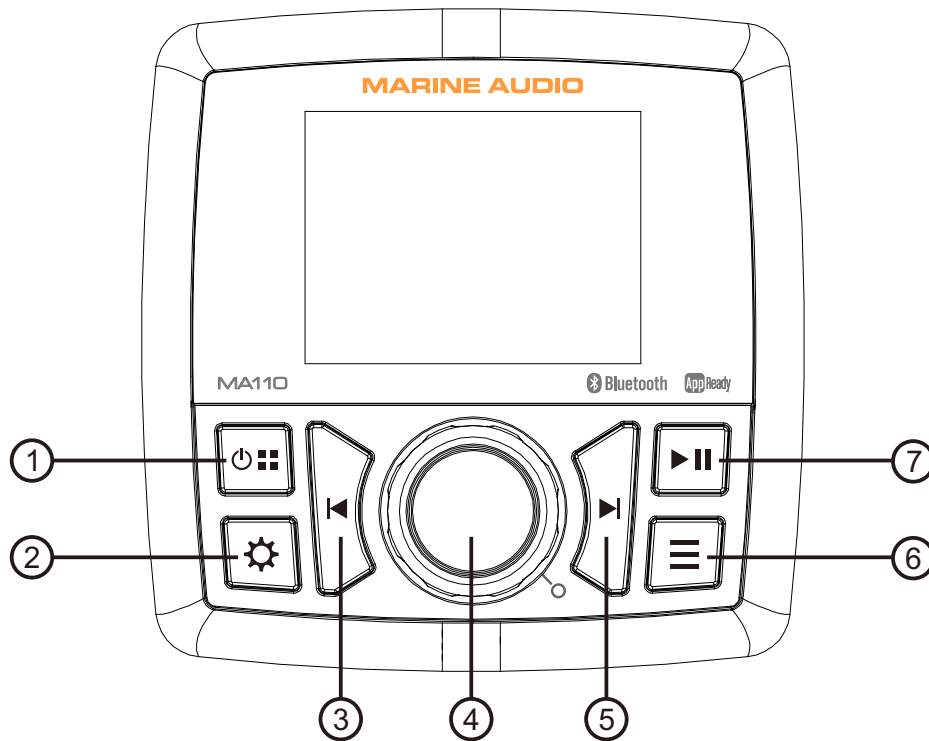

TUNER OPERATION





Select a Band

Press the  button (1) to enter source menu. Then rotate the **VOL/ENTER** knob (4) to select AM/FM radio mode and press **VOL/ENTER** button (4) to confirm entering AM or FM radio mode.

Manual Tuning

Press and hold the  or  buttons (3, 5) to enter manual tune mode, press  or  buttons (3, 5) again to seek stations up/down step by step.

Auto Seek Tuning

Press the  or  buttons (3, 5) to automatically seek the next or previous strong station.

Preset Station

Press and hold the **VOL/ENTER** button (4) to enter Preset Station menu.

Save Presets

Rotate **VOL/ENTER** knob (4) to select desired location, press and hold **VOL/ENTER** button (4) to save current station in the selected desired Preset Stations.

Delete Presets

Rotate **VOL/ENTER** knob (4) to select the location, press and hold  button (5) to delete the station saved in the location.

Recall Presets

Rotate **VOL/ENTER** knob (4) to navigate through the memorized preset stations, press **VOL/ENTER** button (4) to confirm selection and playback the preset frequency.

Auto save Presets / Scan Presets

Press the  menu button (6) to enter radio menu, then rotate the **VOL/ENTER** knob (4) to navigate through following menu items: AUTOSAVE PRESETS and SCAN PRESETS.

Scan Presets

Rotate **VOL/ENTER** knob (4) to select Scan Presets, press **VOL/ENTER** button (4) to scan stations stored in current band. The unit will play for ten seconds at each preset station. Press  button (7) to stop scanning when the desired station is reached.

AutoSave Presets

Rotate **VOL/ENTER** knob (4) to select AutoSave Presets, press **VOL/ENTER** button (4) to confirm selection. The screen will display "Autosaving Presets..." while the unit scanning the frequency. The unit will automatically scan for and store 18 strongest stations for AM or FM.

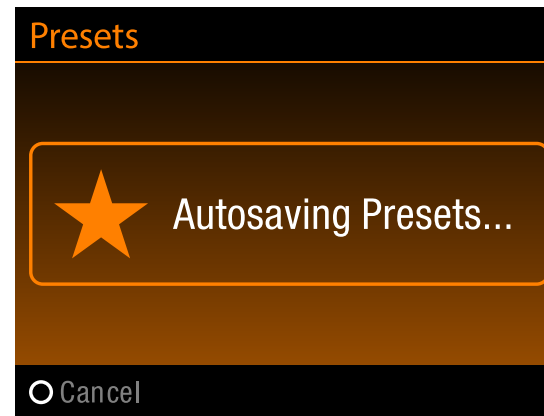

NOTE: Only stations detected with sufficient signal strength will be stored in the preset channels automatically.

BLUETOOTH OPERATION



The MA110 includes built-in Bluetooth technology that allows you to connect this unit to Bluetooth devices for streaming audio playback.

About Bluetooth Technology

Bluetooth is a short-range wireless radio connectivity technology. Operating in the 2.4 GHz frequency range, it transmits voice and data at speeds up to 2.1 Mbit/s over a range of up to 10 meters.

Bluetooth Menu Option

NOTE: Please note that some Bluetooth menu options are only available while the unit is in Bluetooth Audio mode.

Press and hold the  button (1) to enter the source menu. Then rotate the **VOL/ENTER** knob (4) to select Bluetooth mode and press **VOL/ENTER** button (4) to confirm entering Bluetooth playback mode. Press  button (6) to enter Bluetooth menu. Press **VOL/ENTER** button to enter Bluetooth Settings. Then rotate the **VOL/ENTER** knob (4) to select Paired Devices and press **VOL/ENTER** button to view list of previously paired mobile devices model.

Paired Devices List

Rotate the **VOL/ENTER** knob (4) to navigate through the Paired Devices list and press **VOL/ENTER** button (4) to enter Bluetooth Paired Device menu. Then rotate the **VOL/ENTER** knob (4) to navigate through following menu items: Connect/Disconnect, Lock/Unlock, and Delete.

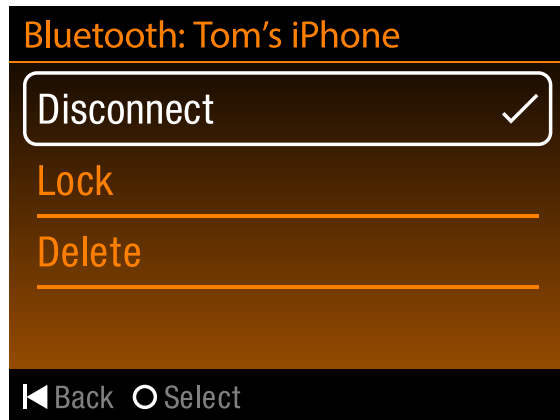

CONNECT/DISCONNECT: To disconnect a paired device, press the **VOL/ENTER** button (4) to temporarily remove the Bluetooth connection. The connection can be re-established through your phone menu by selecting the MA110 for connection or select the phone device name on pairing list through the radio unit and press **VOL/ENTER** button (4) select CONNECT for connection.

LOCK/UNLOCK: The MA110 can store up to 5 devices for Bluetooth connection. The devices are stored in a FIFO (First In First Out) order. To prevent a device from being bumped from the list when more than 5 devices are used, you can lock the device. To Lock/Unlock a device, press the **VOL/ENTER** button (4) to change between Lock/Unlock.

DELETE: Deleting a device removes it from the paired devices list. To delete a device from the list, press the **VOL/ENTER** button (4). To reconnect with a deleted device it must be paired again.

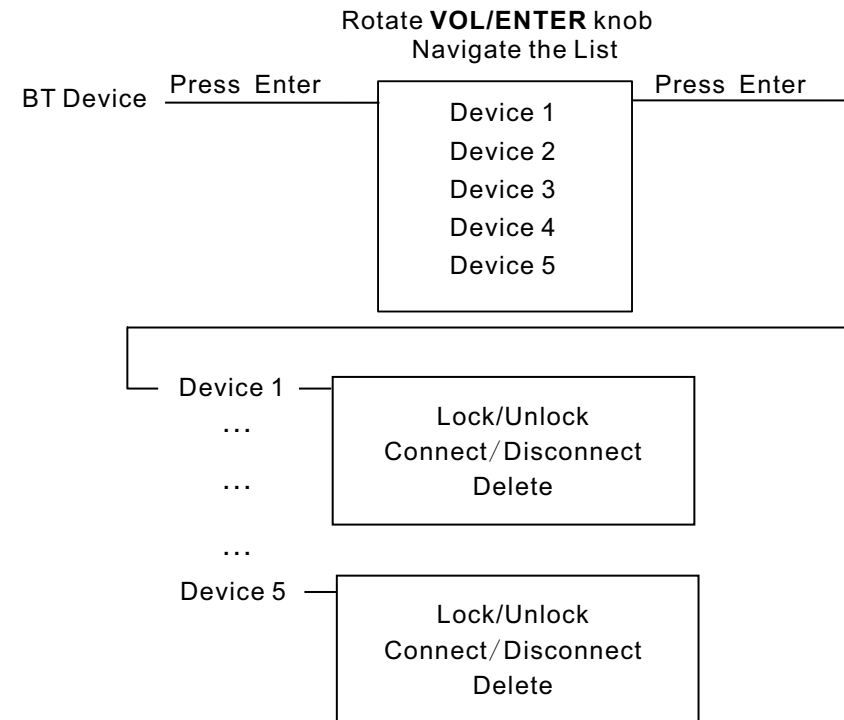

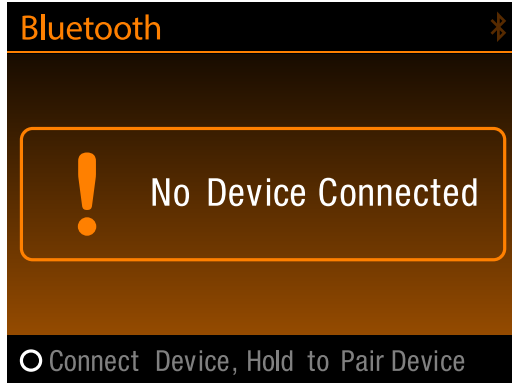

Pairing a Bluetooth Device

The screen will display “No Device Connected” if the unit is not connected with a mobile device through Bluetooth. Press **VOL/ENTER** button (4) to connect the unit with the last connected Bluetooth device.

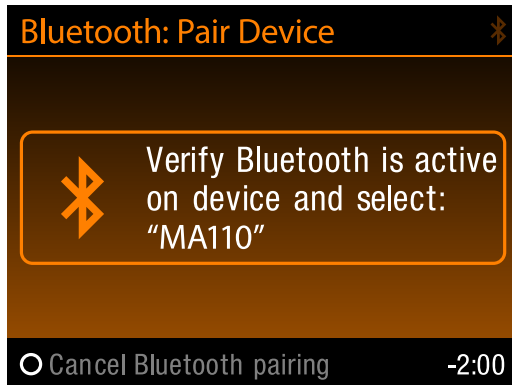

Press and hold **VOL/ENTER** button (4) to enter Bluetooth quick pair. The screen will display message “Verify Bluetooth is active on device and select: “MA110”” and will be available to pair for 2 minutes.



While the unit counts from time -2:00 use your mobile device Bluetooth function to search for a Bluetooth device. The mobile device will display the Bluetooth device name (MA110). Select MA110. Once connected the Bluetooth Audio icon  will light up on the display.



After connecting successfully, you will be able to listen to audio stored on your Bluetooth enabled device through the radio.

Answering a Call



When answering a call using the connected phone, Bluetooth audio playback will pause. After hanging up from the call, Bluetooth audio will continue on some phones. It may be necessary to press the  button (7) to resume Bluetooth audio playback.

Bluetooth Audio (A2DP)

Selecting Tracks

During playback, press  or  buttons (3, 5) to play the previous or next track.

Pausing Playback

During playback, press  button (7) to pause the Bluetooth audio playback. “PAUSE” will appear on the LCD. Press  button (7) again to resume playback. If you change to another mode, playback will automatically pause. Press the  button (1) to enter the source menu. Then rotate the **VOL/ENTER** knob (4) to select Bluetooth mode and press **VOL/ENTER** button (4) to return to Bluetooth mode and resume audio playback from your Bluetooth enabled device.

NOTE: If a Bluetooth device is disconnected due to the power being turned off or if the device goes out of range, the unit will automatically search for the matching Bluetooth mobile device when the power is restored.

APP OPERATION

MARINE AUDIO® Specialty Controller is the ultimate wireless remote control for your MARINE AUDIO stereo system. Store away your old remotes and enjoy the convenience of all the primary functions of your MARINE AUDIO stereo right from your phone or tablet by transforming your mobile device into a functional stereo remote control!

Features

This app controls all of the primary functions of your stereo features including:

- Power on/off
- Mode Selection
- Volume control
- Play/Pause or Mute
- AM/FM radio tuner: access radio menu: Auto Store, Preset Scan, recall a preset, store presets, auto seek and manual seek
- Bluetooth streaming audio
- Audio menu control: Bass, Treble, Balance, Fader, and Loudness on/off.
- Visual display feedback, so you can see artist, title and album on your mobile screen

Connecting and using MARINE AUDIO App

After downloading and installing MARINE AUDIO app on your device, pair your device to the MA110 as stated above for Bluetooth pairing. Once your device is paired you can open the app and use with your MA110 radio.

When Marine Audio is installed on Android operating system, close the app before Bluetooth pairing, otherwise there may be errors on Bluetooth connection.

CARE AND MAINTENANCE

- Keep the product away from dust and dirt, which can cause premature wear of parts.
- Handle the product gently and carefully. Dropping it can damage circuit boards and cases, and can cause the product to work improperly.
- Wipe the product with a dampened cloth occasionally to keep it looking new. Do not use harsh chemicals, cleaning solvents, or strong detergents to clean the product.
- Use and store the product only in normal temperature environments. High temperature can shorten the life of electronic devices, damage batteries and distort or melt plastic parts.

Ignition

The most common source of noise in reception is the ignition system. This is a result of the radio being placed close to the ignition system (engine). This type of noise can be easily detected because it will vary in intensity of pitch with the speed of the engine.

Usually, the ignition noise can be suppressed considerably by using a radio suppression type high voltage ignition wire and suppressor resistor in the ignition system. (Most vessels employ this wire and resistor but it may be necessary to check them for correct operation). Another method of suppression is the use of additional noise suppressors. These can be obtained from most CB/A radio or electronic supply shops.

Interference

Radio reception in a moving environment is very different from reception in a stationary environment (home). It is very important to understand the difference. AM reception will deteriorate when passing under a bridge or when passing under high voltage lines. Although AM is subject to environmental noise, it has the ability to be received at great distance. This is because broadcasting signals follow the curvature of the earth and are reflected back by the upper atmosphere.

TROUBLESHOOTING

Problem	Solution
No power	If the power supply is properly connected to the vessel's accessory terminal. but the engine is not on, switch the ignition key to "ACC" Fuse may be blown. Replace with 15 AMP ATP fuse.
No AM/FM Reception	Antenna cable not connected; insert antenna cable firmly. Check Power; make sure device is on.
No sound	Check volume level; increase volume if necessary. Check Power; make sure device is on. Check device; press the play/pause button to ensure unit is not in Pause mode.
Cannot tune to radio station, auto-seek does not work	Check Power; make sure device is on. Select a station manually, if signals are too weak.
Cannot connect or pair a Bluetooth Device	Check the radio to ensure not connecting to any Bluetooth devices. Refer to page 8 for disconnect the Bluetooth device.

SPECIFICATIONS

FM Tuner

Tuning Range (USA).....87.5 to 107.9 MHz
 Tuning Range (Europe).....87.5 to 108.0 MHz
 Sensitivity.....<5µV
 Stereo Separation.....>30dB

AM Tuner

Tuning Range (USA).....530 to 1710 KHz
 Tuning Range (Europe).....522 to 1620 KHz
 Sensitivity.....<63µV

Amplifier

Output Power..... 15 Watts x 4 Channels
 Speaker Impedance.....4-8 Ω (ohms) per channel

General

Frequency band(s) (for Bluetooth)..... 2402MHz~2480MHz
 Maximum radio frequency power transmitted (for Bluetooth).....10 dBm
 Power Supply Requirements.....DC 12 Volts, Negative Ground
 Operating Voltage.....10-16V DC
 Fuse Rating..... 15 Ampere (Max)
 Chassis Dimensions..... 4.51" Diameter, 4.67" Deep
 Mounting Dimensions..... 3.866" Wide, 4.465" Deep
 Weight.....1.39 lb

Specifications are subject to change without prior notice.



www.asaelectronics.com
877.305.0445