



DESIGNED TO MOVE [YOU][®]

JMS3

FCC ID: 2AHU2JMS3

Owner's Manual





CONTENTS

Introduction.....	1
Features	1
Box Content.....	1
Compliance	1
Safety Information	2
Installation	3
Mounting the Radio.....	3
Auxiliary Input	3
Line Output.....	3
Wiring Diagram.....	4
Operation.....	5
Basic Functions	5
Audio Menu	5
System Menu	5
Radio Mode	6
USB Mode.....	6
Playback Menu (Repeat/ Random)	7
Auxiliary Input Mode	7
Bluetooth Operation.....	8
Troubleshooting	10
Specifications	11



INTRODUCTION

Thank for choosing a Jensen product. We hope you will find the instructions in this owner's manual clear and easy to follow. If you take a few minutes to look through it, you'll learn how to use all the features of your new Jensen receiver for maximum enjoyment.

Features

- Waterproof iPx6
- UV and Corrosion Resistant
- Dimmable Backlit LCD Control
- AM/FM Tuner (US/ EURO)
- 24 Programmable Presets (12 AM, 12 FM)
- Weather Band Tuner
- Electronic Bass, Treble, Balance and Fader Controls
- USB MP3/WMA Player
- Rear Auxiliary Audio Input (RCA)
- Rear Auxiliary Audio Output (RCA)
- 4-Channel Amplified Audio Output
- Bluetooth (Supports A2DP and AVRCP)

Box Content

- JMS3 Radio
- Radio Mounting Bracket
- Screw Posts (x2)
- Locking Hex Nuts (x2)
- Washers (x2)

Compliance with FCC Rules

Compliance with FCC Rules (U.S.A. Only)

This device complies with Part 15 of the FCC rules. Operation is subjected to the following two conditions: (1) This device may not cause harmful interference, and (2) this device must accept any interference received, including interference that may cause undesired operation.

NOTICE

This equipment has been tested and found to comply with the limits for a Class B digital device, pursuant to Part 15 of the FCC Rules. These limits are designed to provide reasonable protection against Harmful interference in a residential installation. This equipment generates uses and can radiate radio frequency energy and, if not installed and used in accordance with the instructions, may cause harmful Interference to radio communications.

However, there is no guarantee that interference will not occur in a particular installation. If this equipment does cause harmful interference to radio or television reception, which can be determined by turning the equipment off and on, the user is encouraged to try to correct the interference by one or more of the following measures:

- Reorient or relocate the receiving antenna.
- Increase the separation between the equipment and receiver.
- Connect the equipment into an outlet on a circuit different from that to which the receiver is connected.
- Consult the dealer or an experienced radio/TV technician for help.

FCC Radiation Exposure Statement

This equipment complied with FCC radiation exposure limits set forth for an uncontrolled environment. This equipment should be installed and operated with minimum distance 20cm between the radiator & your body.

FCC WARNING

- Changes or modifications to this unit not expressly approved by the party responsible for compliance could void the user's authority to operate the equipment.
- Proper connections must be used for connection to a host computer and/or peripherals in order to meet FCC emission limits.



Safety Information

- To ensure full satisfaction with the product, please read the entire instruction manual.
- Keep instructions for future reference.
- Follow all operation guidelines and adhere to all safety warnings and cautions to ensure safe use.
- Do not install near any heat sources such as radiators, heat registers, stoves, or other apparatus (including amplifiers) that produce heat.
- Only use attachments/accessories specified by the manufacturer.
- Never use harsh cleaning agents. Clean only with a dry cloth.

When Driving

Keep the volume level low enough to be aware of the road and traffic conditions.

Protect from Water

Do not submerge, as this can cause electrical shorts, fire or other damage.

Protect from High Temperatures

Exposure to direct sunlight for an extended period of time can produce very high temperatures inside your vehicle. Give the interior a chance to cool down before starting playback. Do not mount the radio within close proximity of the engine compartment.

Use the Proper Power Supply

This product is designed to operate with a 12 volt DC negative ground battery system.

WARNING:

- DO NOT OPEN, DISASSEMBLE OR ALTER THE UNIT IN ANY WAY. Doing so may result in fire, electric shock or product damage.
- USE THE CORRECT AMPERE RATING WHEN REPLACING FUSE. Failure to do so may result in fire, electric shock or product damage.
- DO NOT INSTALL IN LOCATIONS THAT MIGHT HINDER VEHICLE OPERATION. Doing so may obstruct vision or hamper movement which can result in a serious accident.
- INSTALL THE WIRING SO THAT IT IS NOT CRIMPED OR PINCHED BY SCREWS OR SHARP METAL EDGES. Route the cables away from moving parts or sharp pointed edges. This will prevent crimping and damage to the wiring. If the wiring must pass through a metal hole, be sure to use a rubber grommet to prevent the wire's insulation from being cut by the metal edge of the hole. It is also recommended to apply sealing caulk to any opening that may potentially allow water to enter.
- Be sure to choose a location that is flat and has clearance above the unit to prevent any damage, as well as allow for ventilation.
- Before drilling any holes, carefully inspect the area underneath and behind the mounting surface where the device will be mounted to make sure it will not interfere with existing wires, fuel lines, the fuel tank or any other objects that could be damaged.
- Always disconnect the vehicle negative battery terminal during installation to prevent accidental shorting.

INSTALLATION

Mounting the Radio

1. Choose a mounting location on the dash board or instrument panel that will allow room behind to run radio cables to the power source. Consider how you will use the AUX IN, LINE OUT and USB connectors and route the appropriate extension cables to an accessible area.
2. Cut a hole in the dash board using the template provided in the back of this manual. At least 3 3/4" depth is needed to mount the radio.

IMPORTANT! Do not mount this unit where it can be submerged in water.

3. Slide the included spring washers (B) over the screw posts (A) and attach the screw posts to the back of the radio.
4. Place the radio in front of the dashboard opening so the wiring can be brought through the opening.
5. After completing the wiring connections, turn the radio on to confirm operation (vehicle accessory switch must be on). If the radio does not operate, recheck all wiring until the problem is corrected. Once proper operation is achieved, turn the accessory switch off and proceed with final mounting of the radio. Refer to the "Wiring Diagram" on page 4.

NOTE: Before final installation, test the wiring connections to make sure the unit is connected properly and the system works.

6. Insert the radio into the mounting hole.
7. Place the "U" bracket (C) over the screw posts and secure the radio to the dash using the included hex nuts (D). If necessary, cut the score marks (E) on either side of the mounting bracket to custom fit the bracket length for your application. See Figure A.

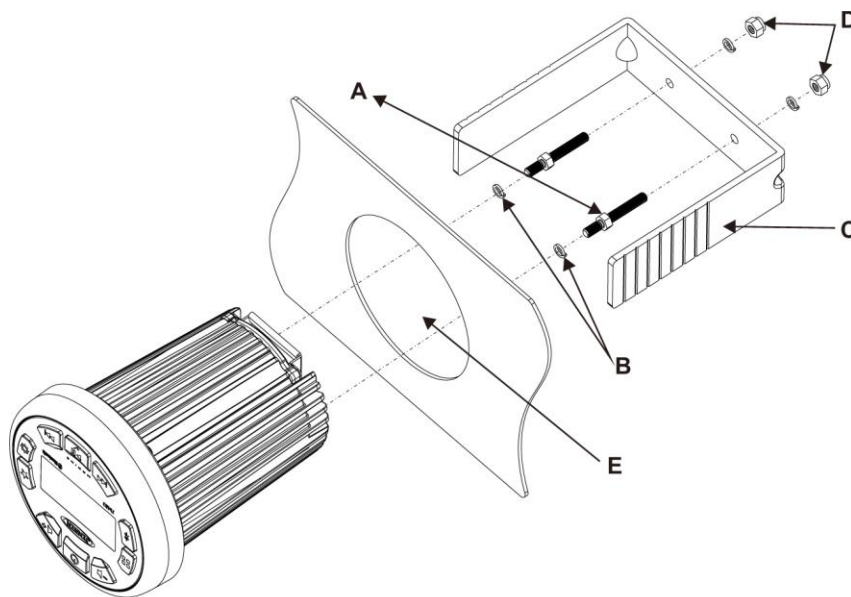

Figure A - Installation

Auxiliary Input

Connect a portable audio device to the Audio Input (AUX IN RIGHT/LEFT) on the back of the unit using RCA cables.

Line Output

The Line Out connectors (LINE OUT RIGHT/LEFT) on the back of the unit output a line-level analog signal. Use this output to connect to an external amplifier.

Wiring Diagram

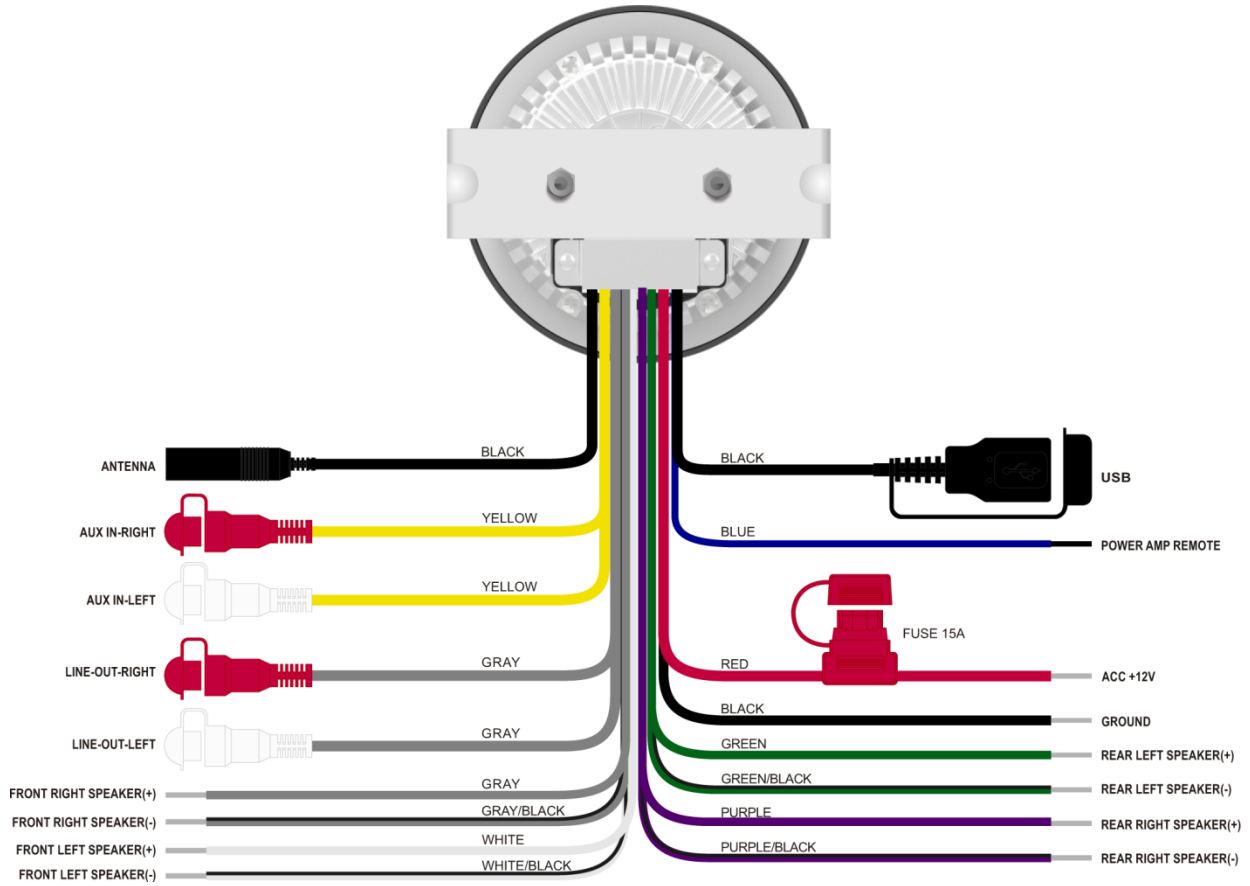

WIRE COLOR	DESCRIPTION
PURPLE	RIGHT REAR SPEAKER (+)
PURPLE/ BLACK	RIGHT REAR SPEAKER (-)
GRAY	RIGHT FRONT SPEAKER (+)
GRAY/ BLACK	RIGHT FRONT SPEAKER (-)
WHITE	LEFT FRONT SPEAKER (+)
WHITE/ BLACK	LEFT FRONT SPEAKER (-)
GREEN	LEFT REAR SPEAKER (+)
GREEN/ BLACK	LEFT REAR SPEAKER (-)
RED	ACC +12V
BLACK	GROUND
BLUE	POWER AMP REMOTE

Note: Do not connect the red wire to a constant power connection. The red wire should be connected to a vehicle connection with switched power such as IGN or ACC.

OPERATION

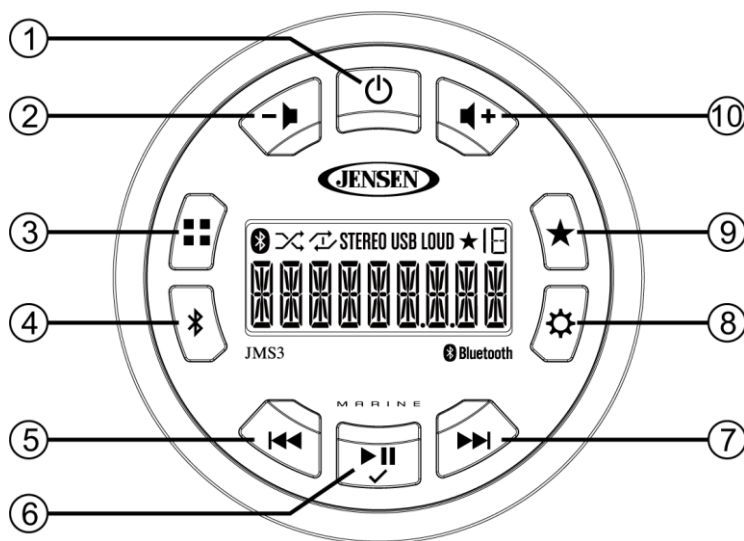

Basic Functions

Power

Press the power button (1) to turn the unit on.

Press and hold the power button (1) to enter standby mode.

Volume

Press the button (10) to increase the volume.

Press the button (2) to decrease the volume.

Press and hold either button to change the volume level continuously.

Pause/ Mute

Press the button (6) to silence the audio output in tuner, AUX or USB mode. Press again to restore the previous volume level.

Mode

Press the button (3) to select a mode of operation: AM, FM, WX, Bluetooth, AUX IN and USB.

Dimming Control

Press the button (1) to turn the dimmer on (Selected brightness level) and press again to turn the dimmer off (maximum brightness level).

Audio Menu

Press button (8) to access the audio menu. Press the button repeatedly to adjust the following audio menu settings: BASS, TREBLE, BALANCE, FADER and LOUD. Use the or buttons (5, 7) to choose a value for each setting.

System Menu

Press and hold button (8) to access the system menu. Press the button (8) once again to adjust the following system menu settings: BT DEVICE, BT PAIR, DIMMER ON/ OFF, DIMMER LEVEL (0 – 8), REGION (USA/ EURO), PRESET VOLUME and RESET. Use the or buttons (5, 7) to choose a value for each setting. Press the button (6) to confirm selection and exit menu.





Reset

Press the button to confirm factory default restore. This function will time out after 5 seconds of inactivity and the unit will resume normal operation. After reset, the unit will default to FM mode.



Radio Mode

USA/Europe (EURO) Tuning Mode Selection



To change from USA to European tuning mode, perform the following steps:

1. Press and hold the  button (8) for 3 seconds to access the system menu.
2. Press the  button (8) repeatedly to cycle through the menu options (DIM > DIM LEVEL > REGION > PRE VOL > RESET). (The Region setting will display REG USA (if set to USA frequency tuning mode) or REG EUR (if set to European Frequency mode).
3. With the display showing the current tuning mode, press the  or  buttons (5, 7) to change between (REG USA/REG EUR).
4. Press  button (6) to confirm your selection and exit menu.

Frequency Tuning







Press the  or  button (5, 7) to fine tune the radio frequency.

Channel Seek



Press and hold the  or  buttons (5, 7) to seek strong radio frequencies.

Preset Channel Store

To manually store a favorite channel to one of the twelve preset channels, perform the following steps:



1. Press the  or  button (5, 7) to tune to the radio frequency you want to store.
2. Press and hold the  button (9) to access 12 presents channel list; the favorite icon & channel  flashing at display.
3. Press the  button (9) repeatedly to select desired favorite preset channel number (1-12).
4. Press the  button (6) to save the station to the chosen preset channel and exit present channel list, the favorite icon will stop flashing.

Auto Store

Press and hold the  button (3) to access the tuner menu list (AUTO STORE & PRESET SCAN). Press  button (3) repeatedly until "AUTO STR" appears on the display. Press the  button (6) to begin the Auto Store function and store the strongest stations to the preset tuning channels.

NOTE: Only stations detected with sufficient signals will be stored in the preset channel automatically.

Preset Scan

Press and hold the  button (3) to access the tuner menu list (AUTO STORE & PRESET SCAN). Press  button (3) repeatedly until "PRE SCAN" appears on the display. Press the  button (6) to begin the Preset Scan function and listen the strongest stations to the preset tuning channels.

Favourite Preset Channel select

Press the  button (9) to select available preset channels.

USB Mode

Insert/Remove USB Device



You can connect a USB device directly to the USB interface at the rear of the radio for playback of compatible files. Playback begins automatically.

Press the  button (3) to switch to USB mode from another source.





Play/Pause (USB)

During USB playback, press the  button (9) to play or pause the selected track.

Next/Previous File

Press the  or  button (5, 7) to select the previous or next track.

Track Select

1. Press and hold the  buttons (9) to access the MP3/WMA track navigate mode.
2. Press the volume  or  button (10, 2) to select the desire track.
3. Press  button (6) to confirm to playback the track selected.

Fast Forward/Fast Reverse

Press and hold the  or  buttons (5, 7) to fast forward or fast reverse.



Playback Menu (Repeat/ Random)

Press the  button (3) to select Repeat One, Repeat ALL and Random playback.

Repeat Play

Repeat One: to continuously repeat the selected track

Repeat All: to repeat all tracks.

Random Play

Random Shuffle: to play all tracks in random, shuffle order

Auxiliary Input Mode

Press the  button (3) repeatedly until auxiliary input mode (AUX IN) is selected from any other modes, when a portable device is connected to the unit.

Bluetooth Operation

The JMS3 includes built-in Bluetooth technology that allows you to connect this unit to Bluetooth devices for streaming audio playback.

About Bluetooth Technology

Bluetooth is a short-range wireless radio connectivity technology developed as a cable replacement for various electronic devices. Bluetooth operates in 2.4 GHz frequency range and transmits voice and data at speeds up to 1 megabit per second. Bluetooth was launched by a special interest group (SIG) comprised of Ericsson Inc., Intel Corp., Nokia Corp., Toshiba and IBM in 1998, and it is currently developed by nearly 2,000 companies worldwide. The Bluetooth word mark and logos are owned by the Bluetooth SIG, Inc. and any use of such marks is under license. Other trademarks and trade names are those of their respective owners.

Bluetooth Menu Options

NOTE: Please note that some Bluetooth menu options are only available while the unit is in Bluetooth Audio mode.



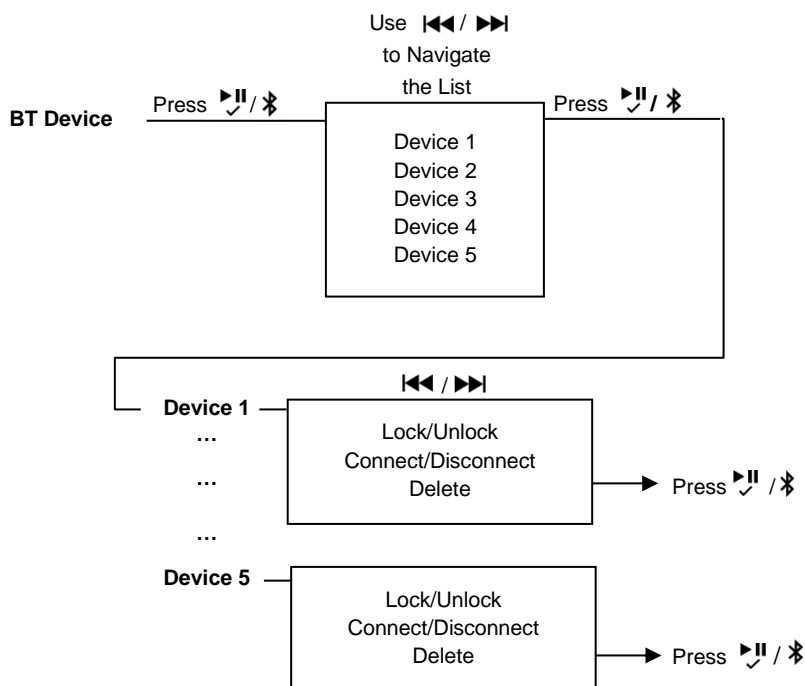

Press and hold the button (8) to enter the menu adjustment mode. The following additional menu options are available when the unit is in Bluetooth mode:

- **BT PAIR:** On the BT Pair screen press the button (6) to make pairing available for 120 seconds then connect using your Bluetooth enabled device
- **BT DEVICE:** Press the button (6) to view a list of previously paired mobile phone devices. Press the or buttons (5, 7) to view devices in the list. When viewing a specific device press button (6) again to enable the following LOCK/ UNLOCK, CONNECT/ DISCONNECT, and DELETE functions and press or buttons (5, 7) to cycle through them.
 - **CONNECT/ DISCONNECT:** To disconnect a paired device, press the button (6) to temporarily remove the Bluetooth connection. The connection can be re-established through your phone menu by selecting the JMS3 for connection or select the phone device name on pairing list through the radio unit and press button (6) and select CONNECT for connection.
 - **LOCK/ UNLOCK:** The JMS3 can store up to 5 devices for Bluetooth connection. The devices are stored in a FIFO (First In First Out) order. To prevent a device from being bumped from the list when more than 5 devices are used, you can lock the device. To Lock/ Unlock a device, press to change between Lock/ Unlock.
 - **DELETE:** Deleting a device removes it from the pairing list. To delete a device from the list, press the button (6). To reconnect with a deleted device it must be paired again.



Pairing a Bluetooth Device

Before you begin, consult the owner's manual for the Bluetooth device you want to pair with the JMS3.

1. Make sure the device you intend to pair with is on and ready to receive a signal from JMS3.
2. Press the  button (4) to enter Bluetooth mode.
3. *Press and hold* the  button (8) and press repeatedly until the unit display BT PAIR, then press  button (6). The unit will display PAIR and count down from 120 to 0. While the unit counts down, use your mobile device Bluetooth function to search for a Bluetooth function to search for Bluetooth device.
4. When your mobile device has completed its search, the mobile device will display the Bluetooth device name (JMS3).
5. Select JMS3. Once connected the Bluetooth Audio icon  will appear on the display.
6. Enter the pairing password (0000), if requested.

After connecting successfully, you will be able to listen to audio stored on your Bluetooth enabled device through the radio.

Answering a Call



When answering a call using the connected phone, Bluetooth audio playback will pause. After hanging up from the call, Bluetooth audio will continue on some phones. It may be necessary to press the  button (6) to resume Bluetooth audio playback.

Bluetooth Audio (A2DP)

Selecting Tracks

During playback, press  or  button (5, 7) to play the previous or next track.

Pausing Playback

During playback, press  button (6) to pause the Bluetooth audio playback. "PAUSE" will appear on the LCD (10). Press  button (6) again to resume playback. If you change to another mode, playback will automatically pause. Press the  button (3) to return to Bluetooth mode and resume audio playback from your Bluetooth enabled device.

NOTE: If a Bluetooth device is disconnected due to the power being turned off or if the device goes out of range, the unit will automatically search for the matching Bluetooth mobile device when the power is restored.



TROUBLESHOOTING

Table 1: Troubleshooting

Problem	Solution
No power	If the power supply is connected to the vehicle accessory circuits but the engine is not on, switch the ignition key to "ACC"
	Fuse may be blown. Replace with 15 AMP ATO fuse.
No AM/FM Reception	Antenna cable not connected; insert antenna cable firmly.
	Check power; make sure device is on.
No sound	Check volume level; increase volume if necessary.
	Check power; make sure device is on.
	Check device; press the play/pause button to ensure unit is not in Pause mode.



SPECIFICATIONS

General

Frequency band(s) (for Bluetooth) 2402-2480MHz
Maximum radio-frequency power transmitted (for Bluetooth) -0.69dBm
Power Supply Requirements DC 12 Volts, Negative Ground
Unit Dimensions 3.602" Diameter, 3.465" Deep
Mounting Dimensions 3.866" Wide, 4.465" Deep
Weight 1.3 lb.

FM Tuner (for Receiver)

Tuning Range 87.5 to 107.9 MHz
Sensitivity <5µV
Stereo Separation @1 kHz >30 dB

AM Tuner

Tuning Range 530-1710 KHz
Sensitivity <63µV

Amplifier

Max Output Power 160 Watts Total (40 Watts, 4 Channel)
Output Impedance Compatible with 4-8 Ohm Speakers, 4 Ohm Load Minimum

Specifications subject to change without notice.



www.asaelectronics.com
www.jensenheavyduty.com