

DH5_Ant1_2402_1000~26500

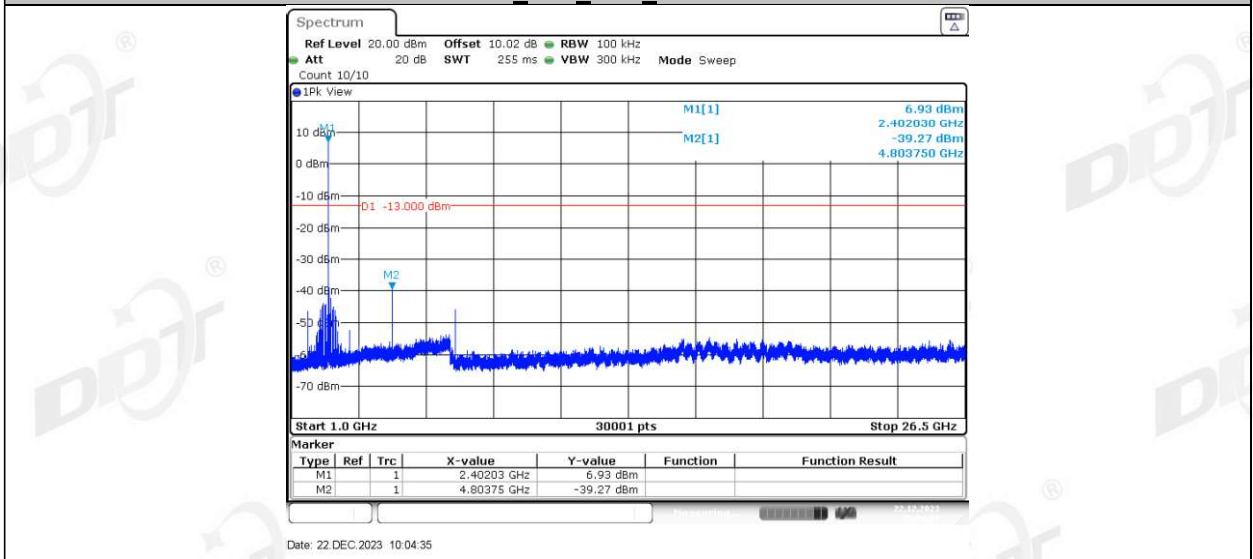

DH5_Ant1_2441_0~Reference

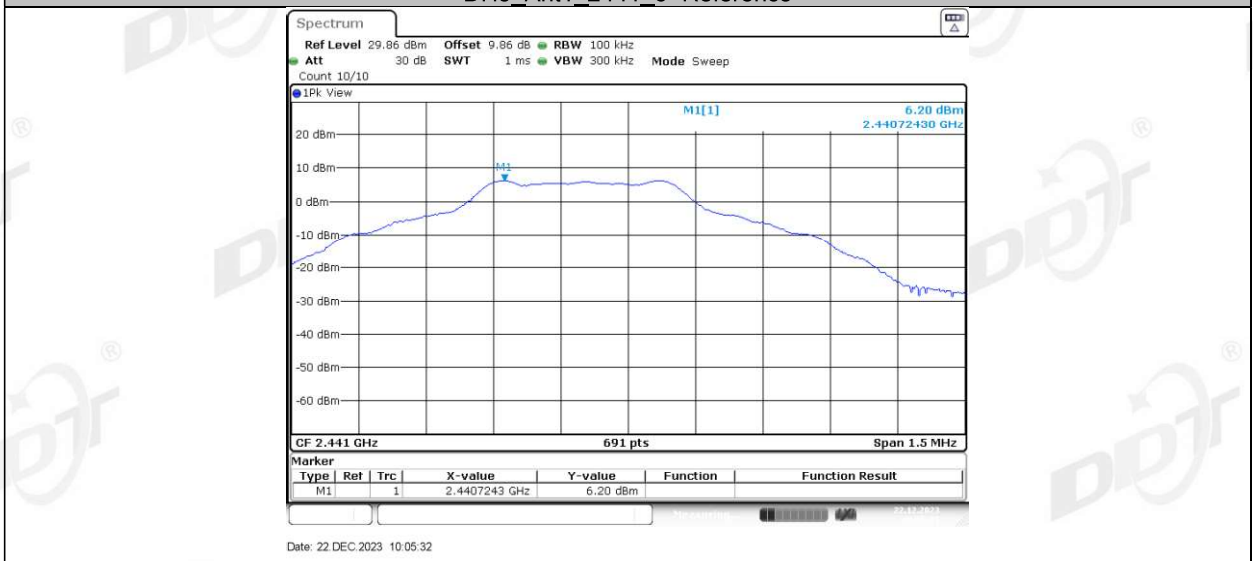

DH5_Ant1_2441_30~1000

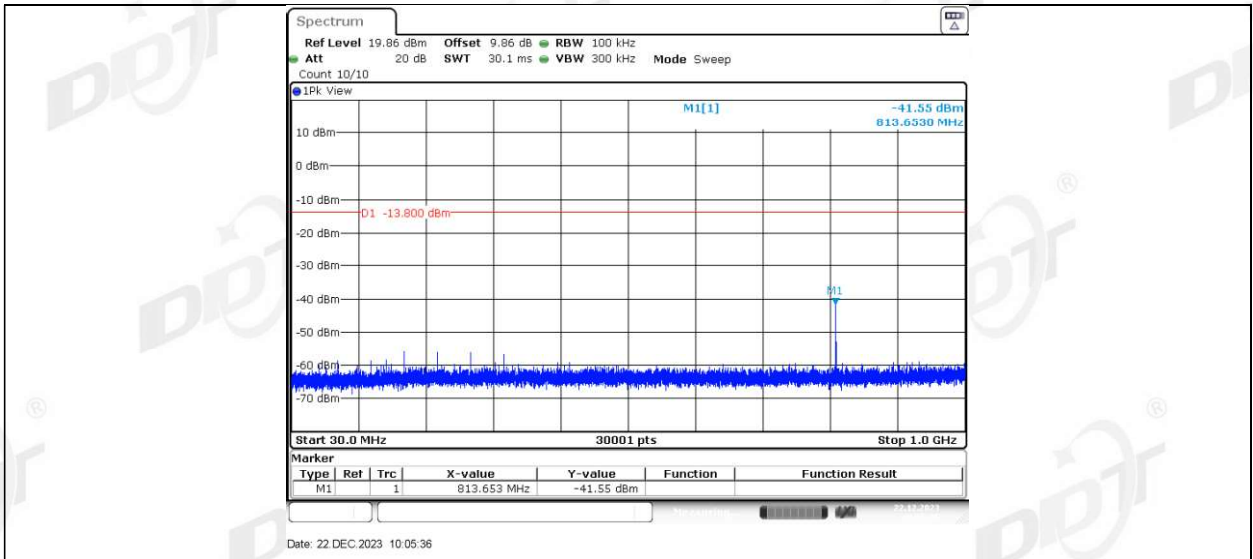

DH5_Ant1_2441_1000~26500

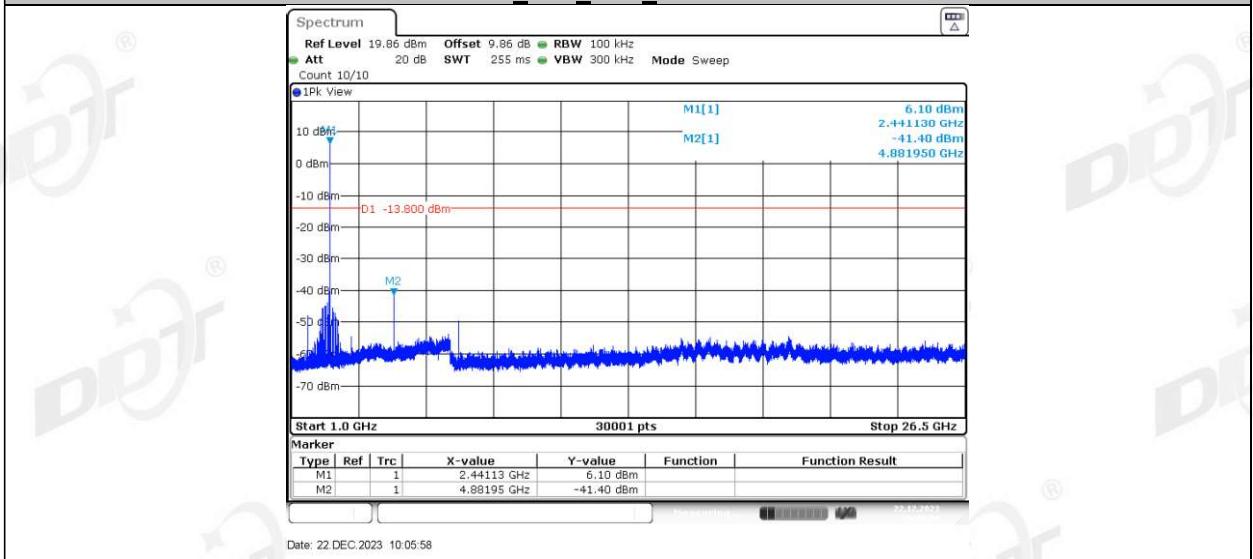

DH5_Ant1_2480_0~Reference



DH5_Ant1_2480_30~1000

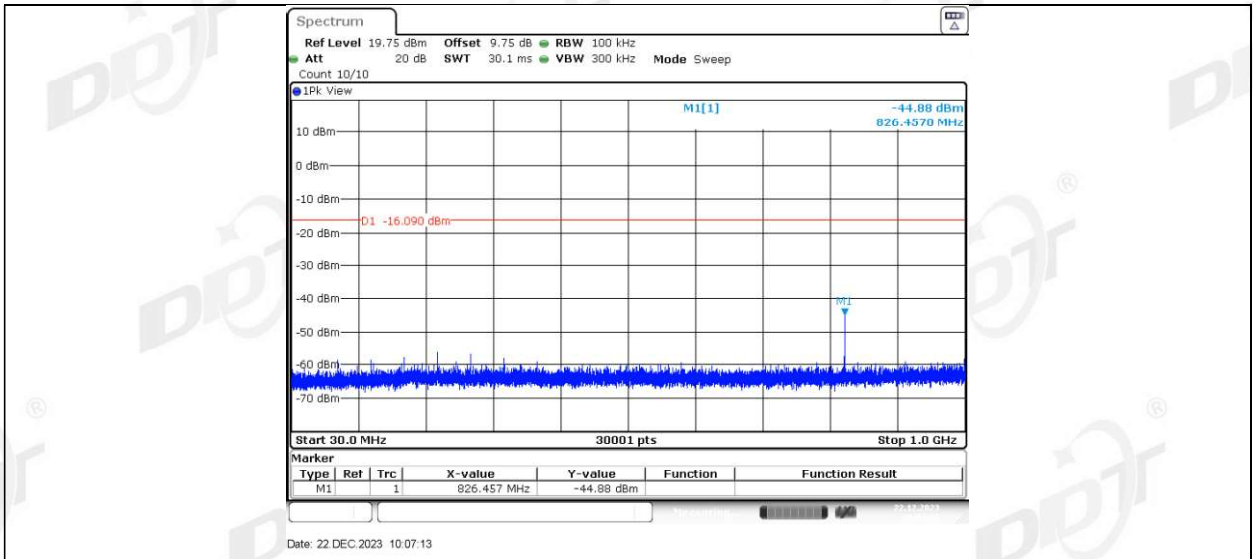

DH5_Ant1_2480_1000~26500

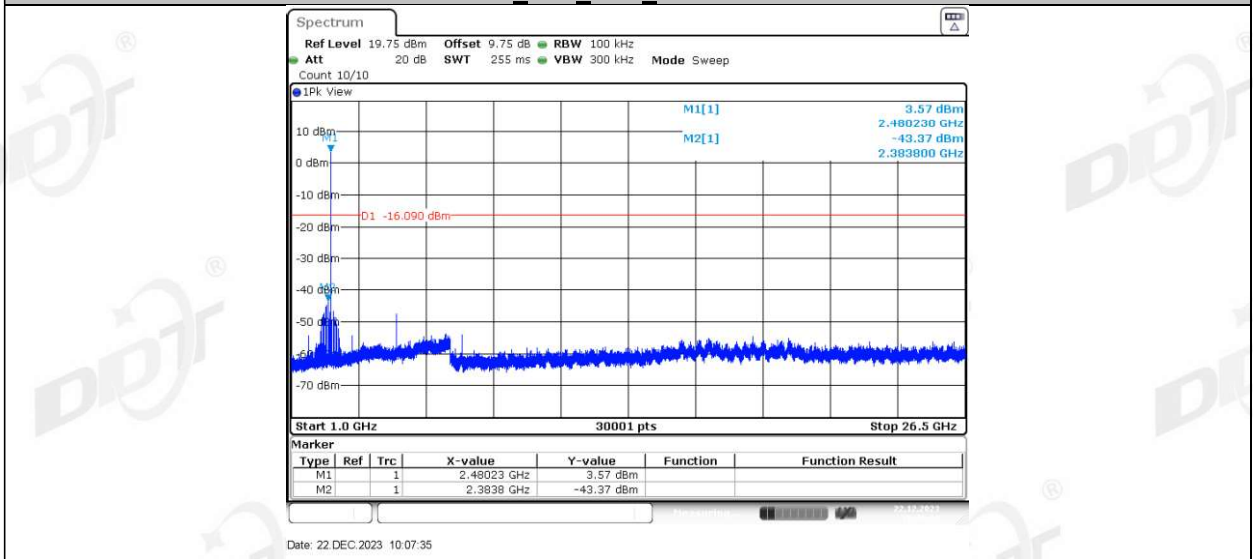

2DH5_Ant1_2402_0~Reference

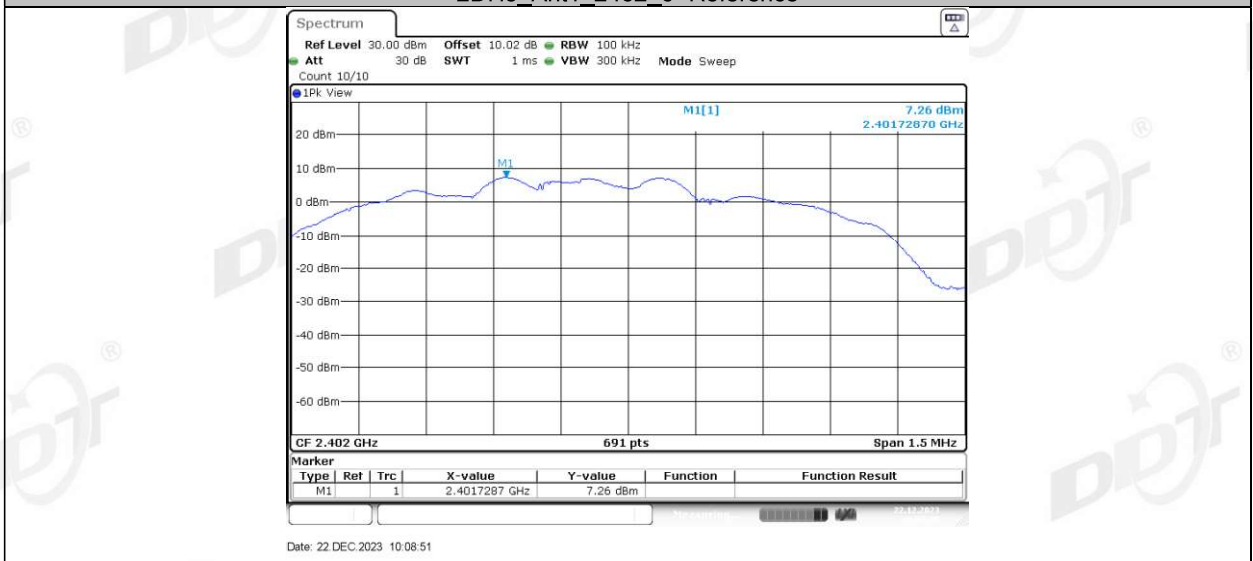

2DH5_Ant1_2402_30~1000

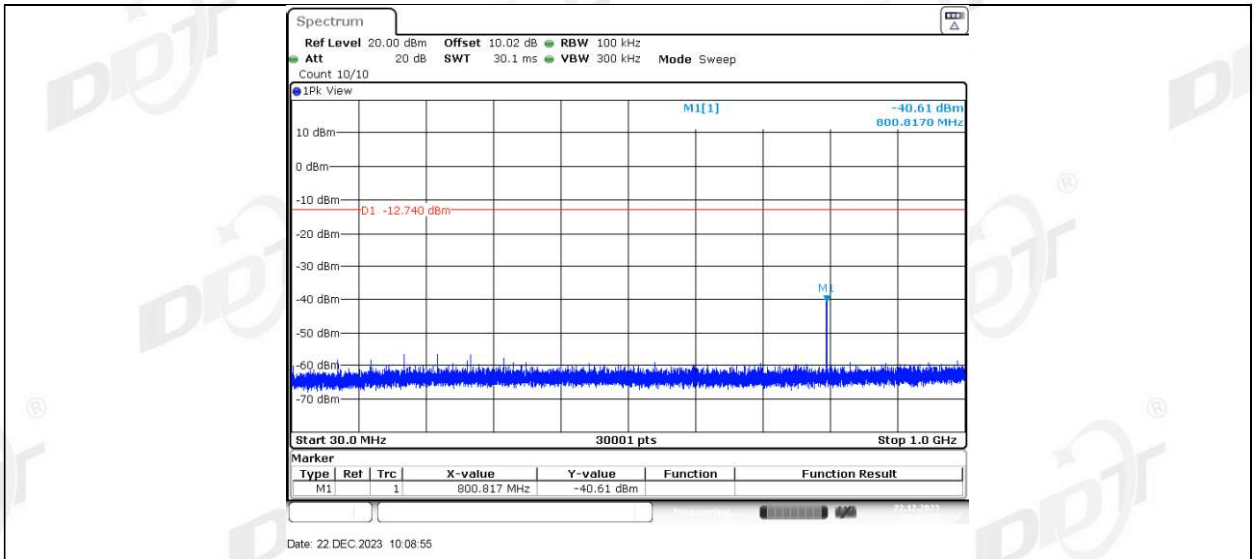

2DH5_Ant1_2402_1000~26500

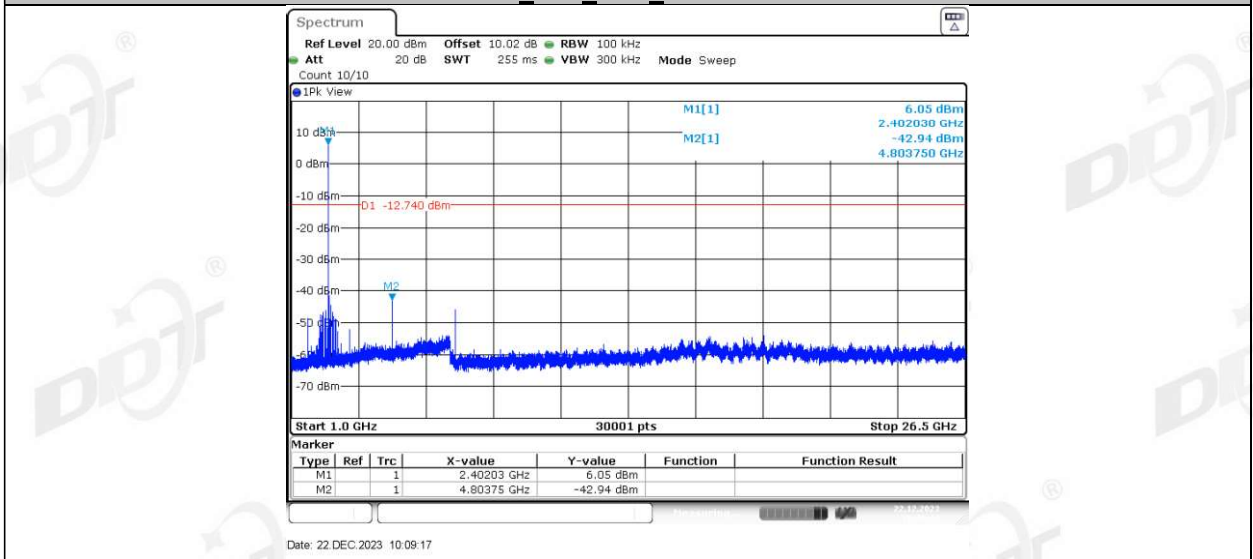

2DH5_Ant1_2441_0~Reference

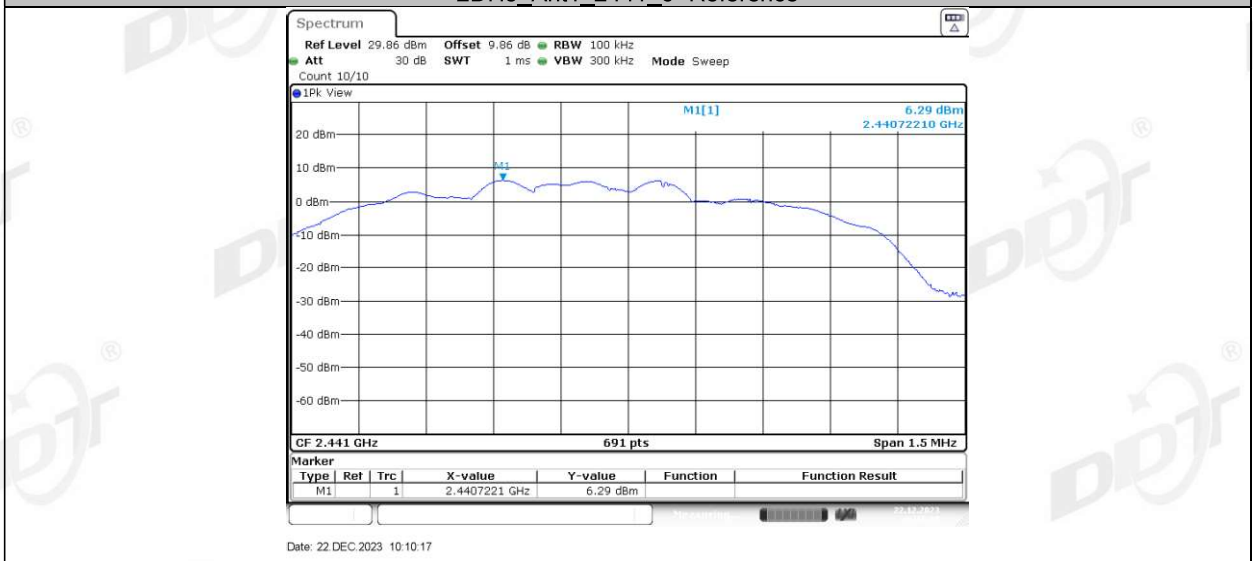

2DH5_Ant1_2441_30~1000

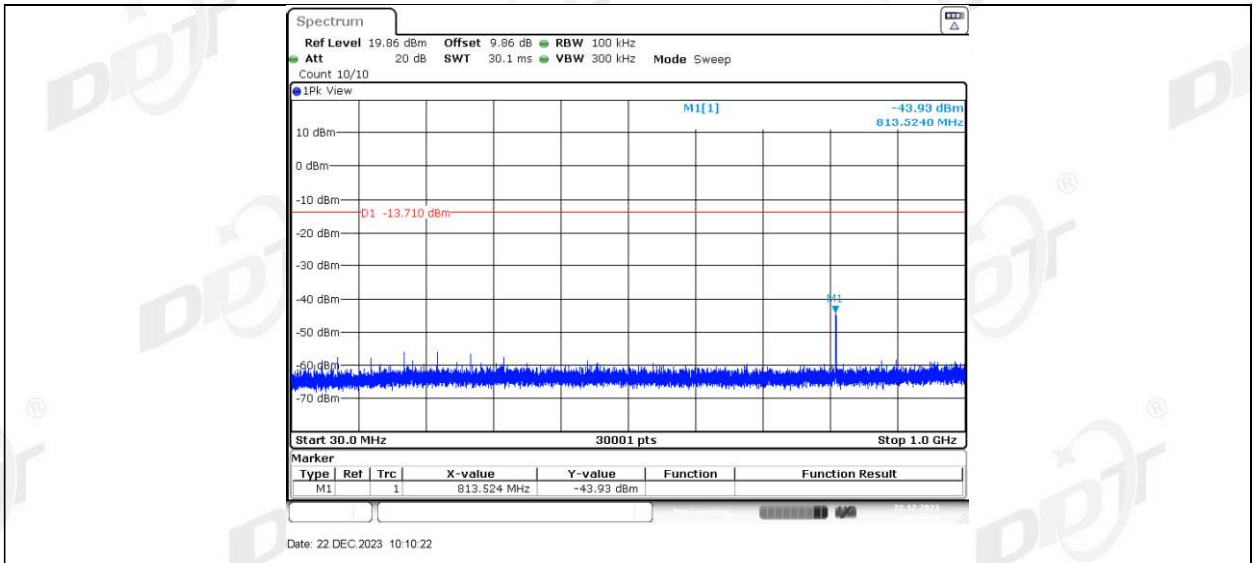

2DH5_Ant1_2441_1000~26500

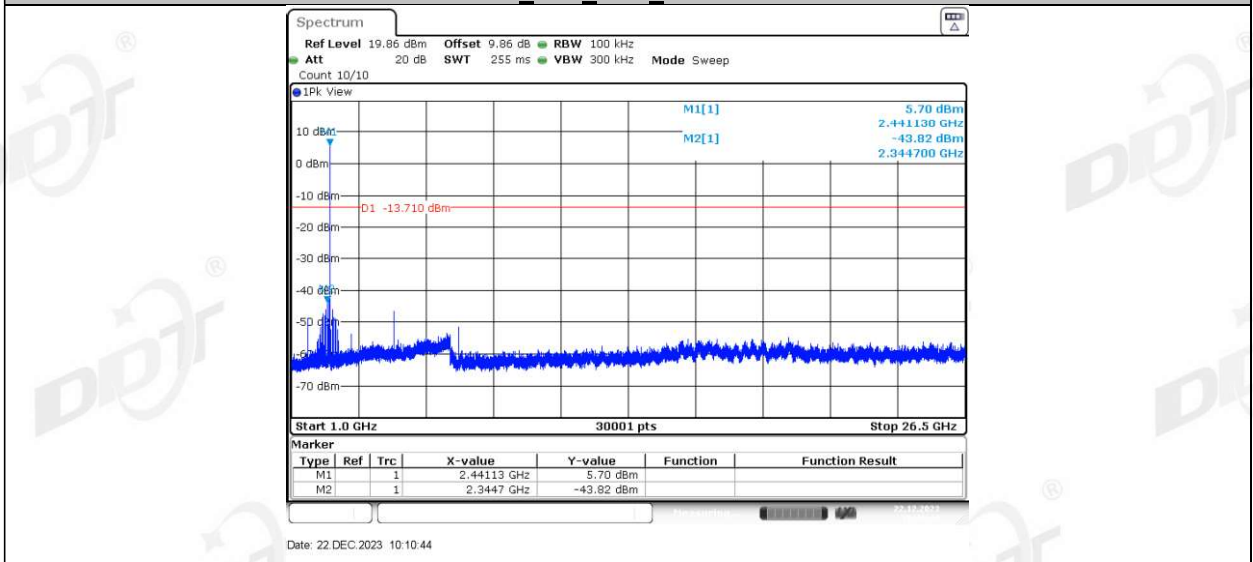

2DH5_Ant1_2480_0~Reference

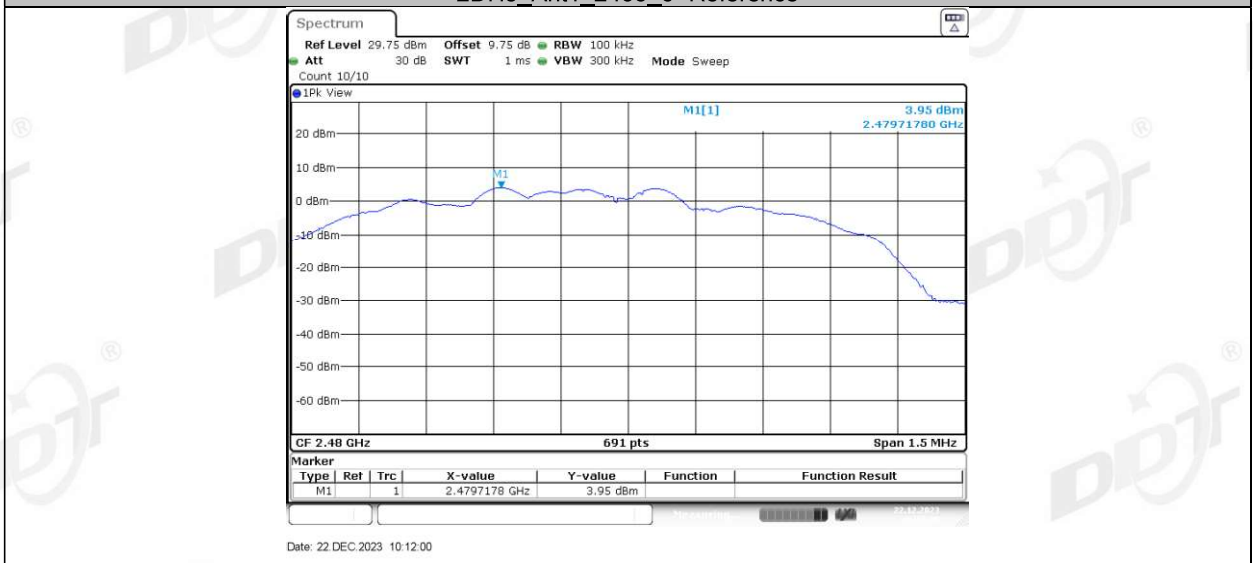

2DH5_Ant1_2480_30~1000

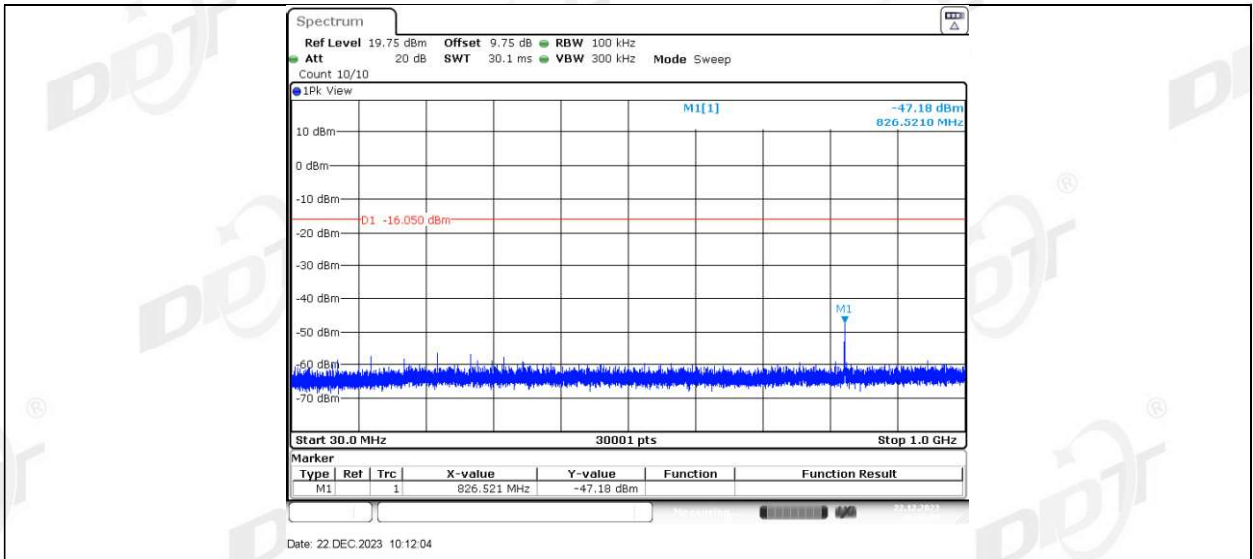

2DH5_Ant1_2480_1000~26500

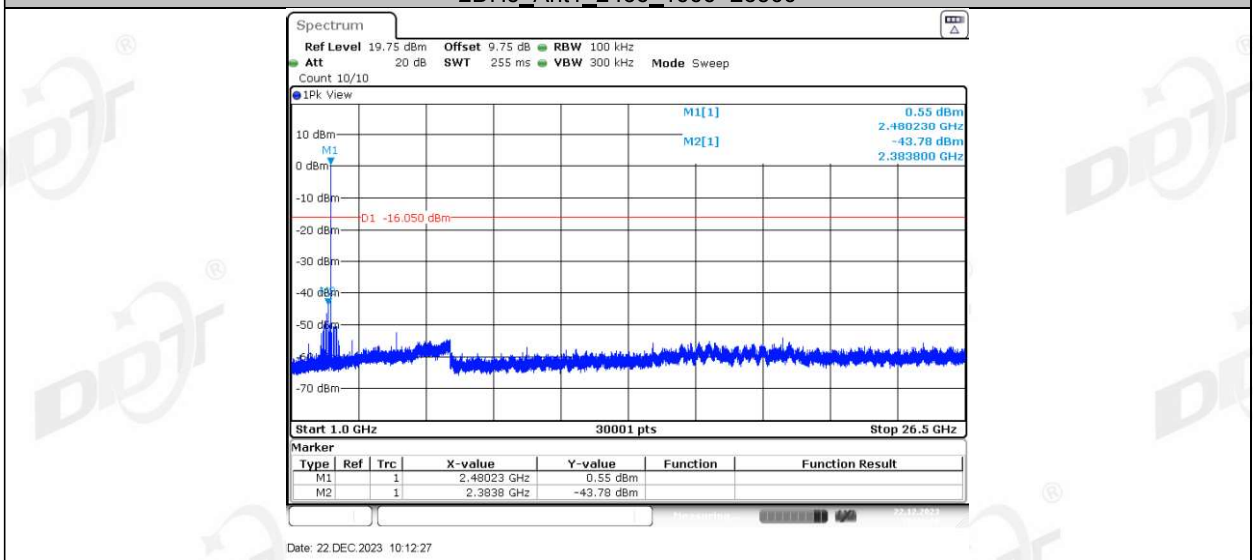

3DH5_Ant1_2402_0~Reference

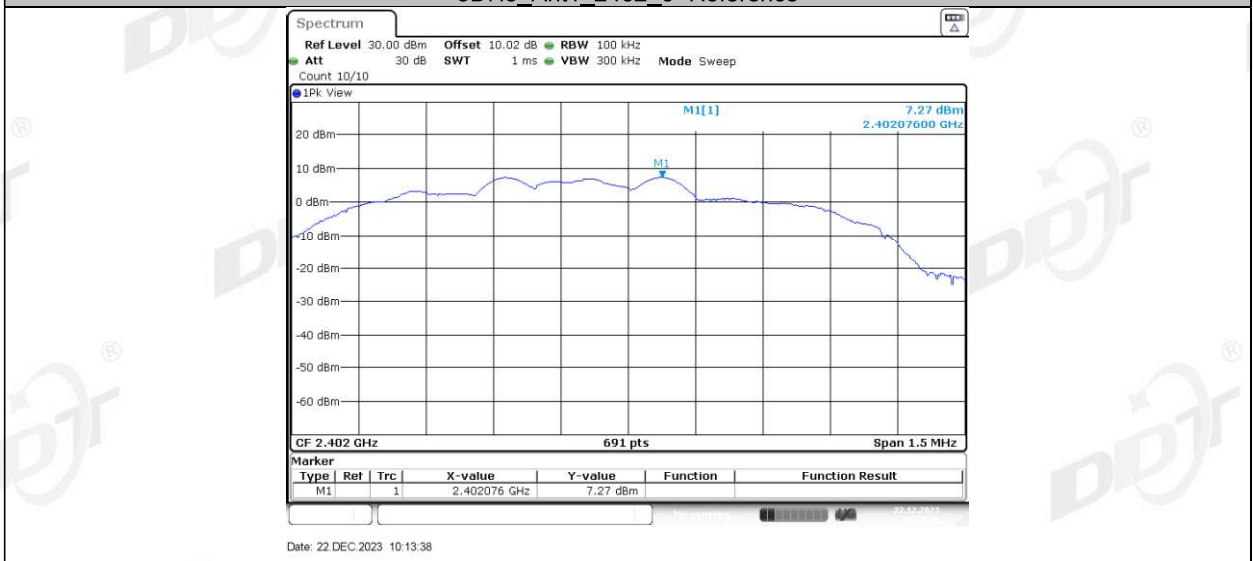

3DH5_Ant1_2402_30~1000

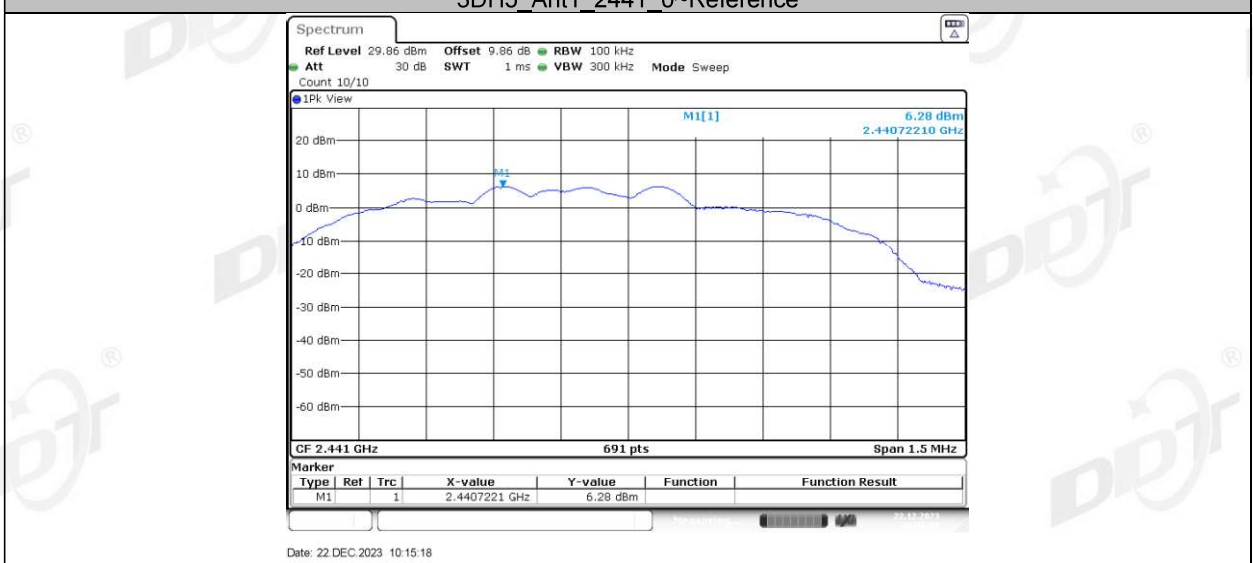
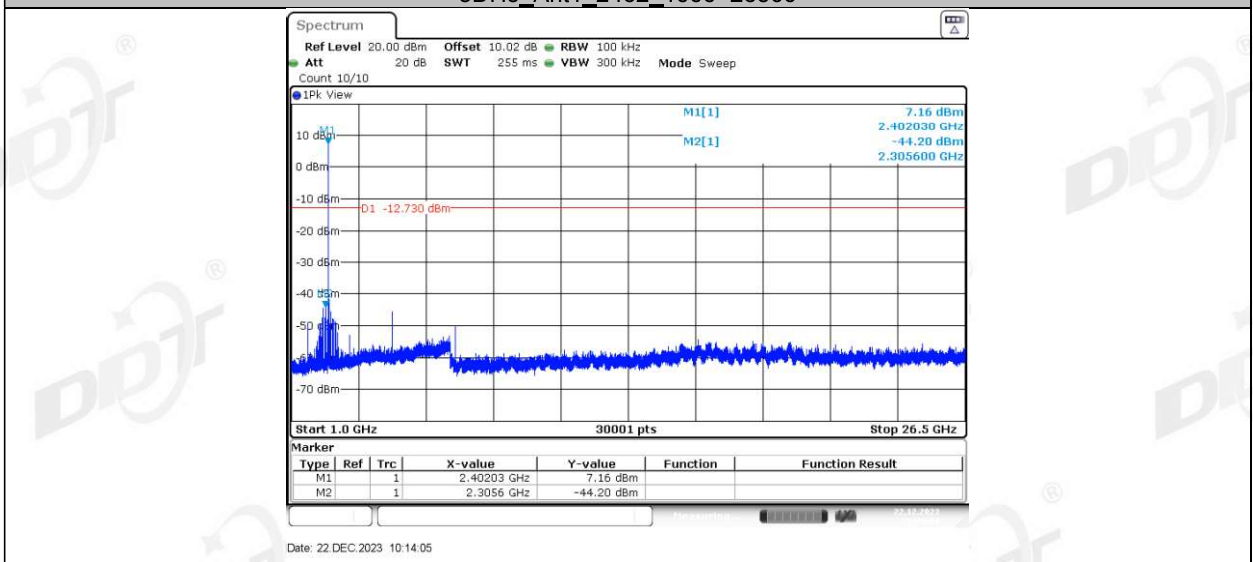
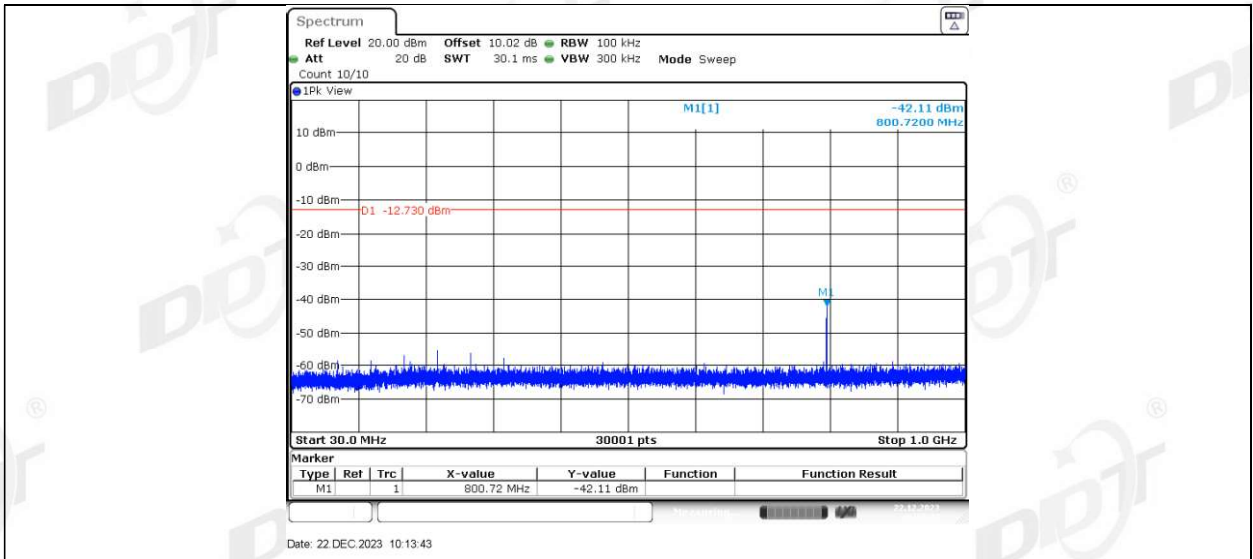

3DH5_Ant1_2441_30~1000

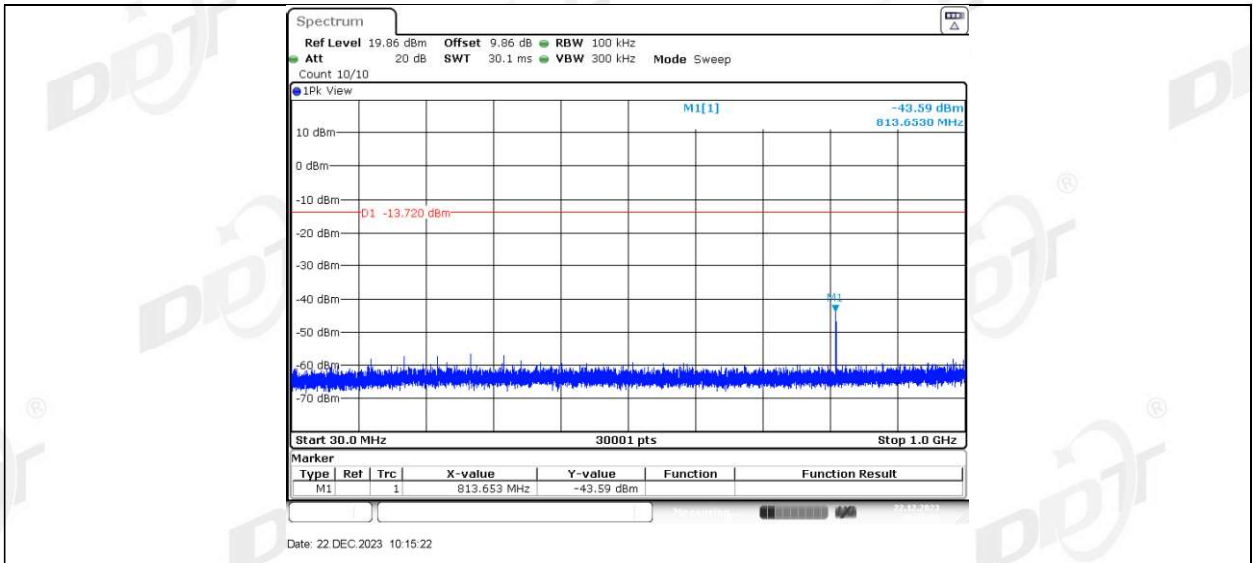

3DH5_Ant1_2441_1000~26500

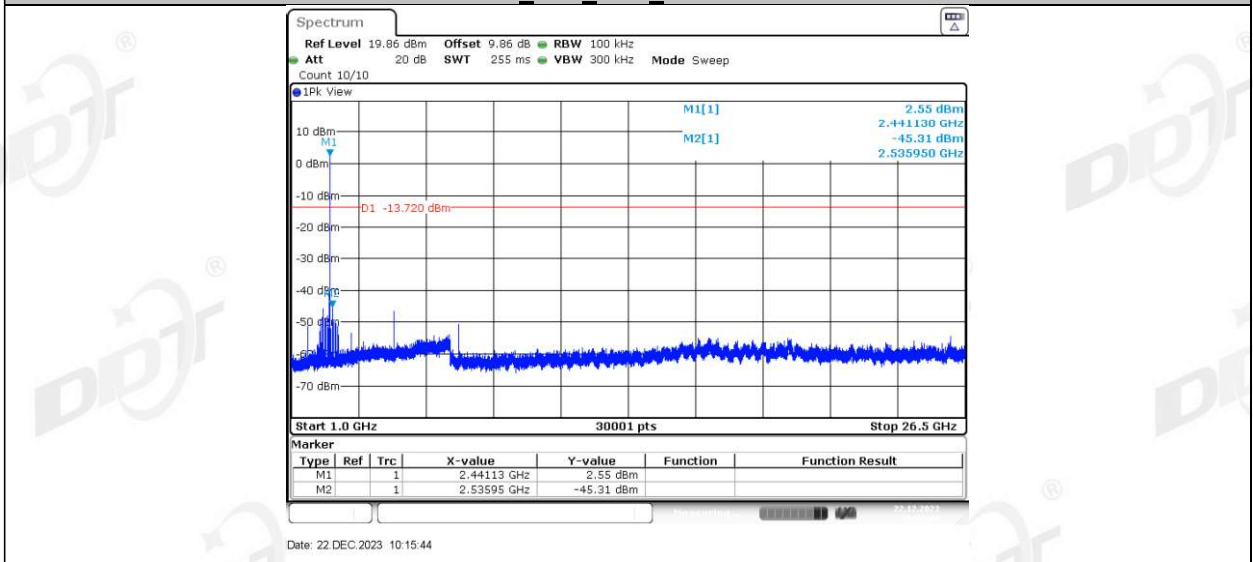

3DH5_Ant1_2480_0~Reference

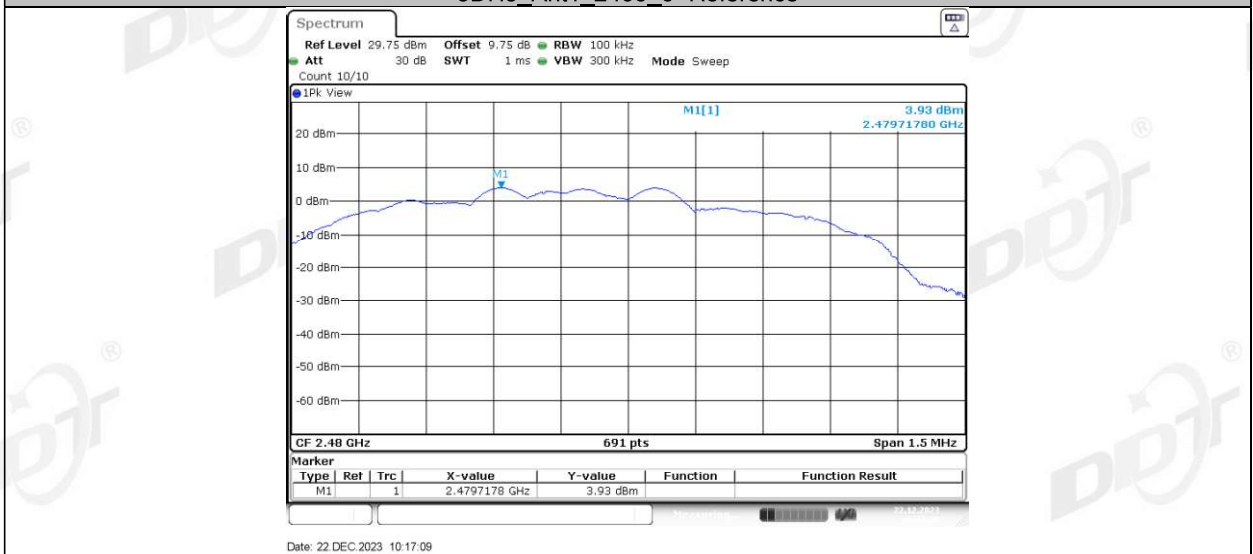

3DH5_Ant1_2480_30~1000

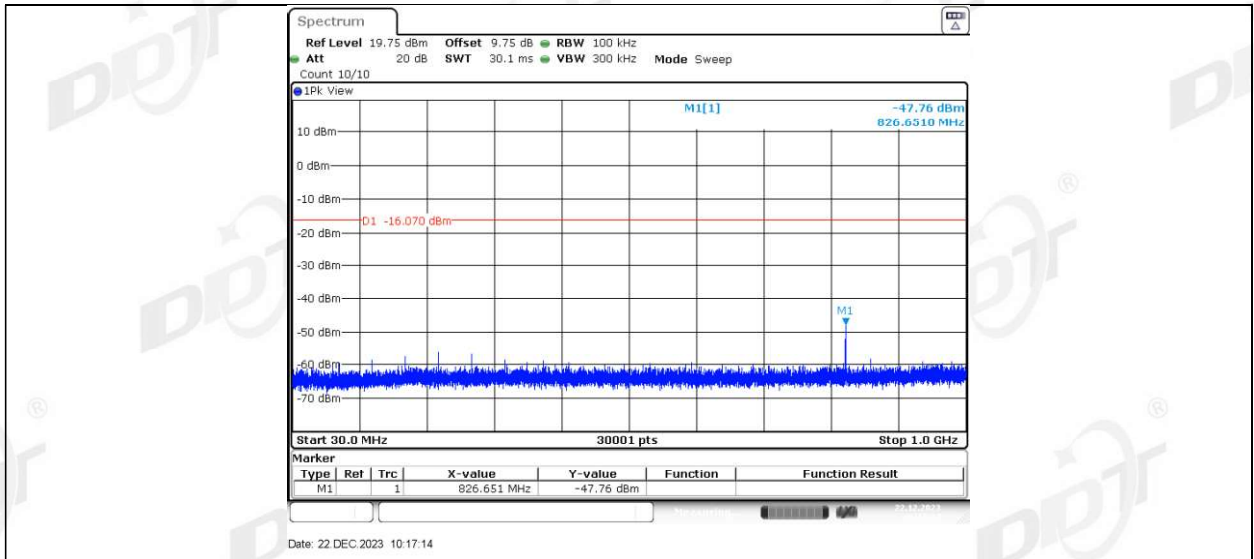

3DH5_Ant1_2480_1000~26500

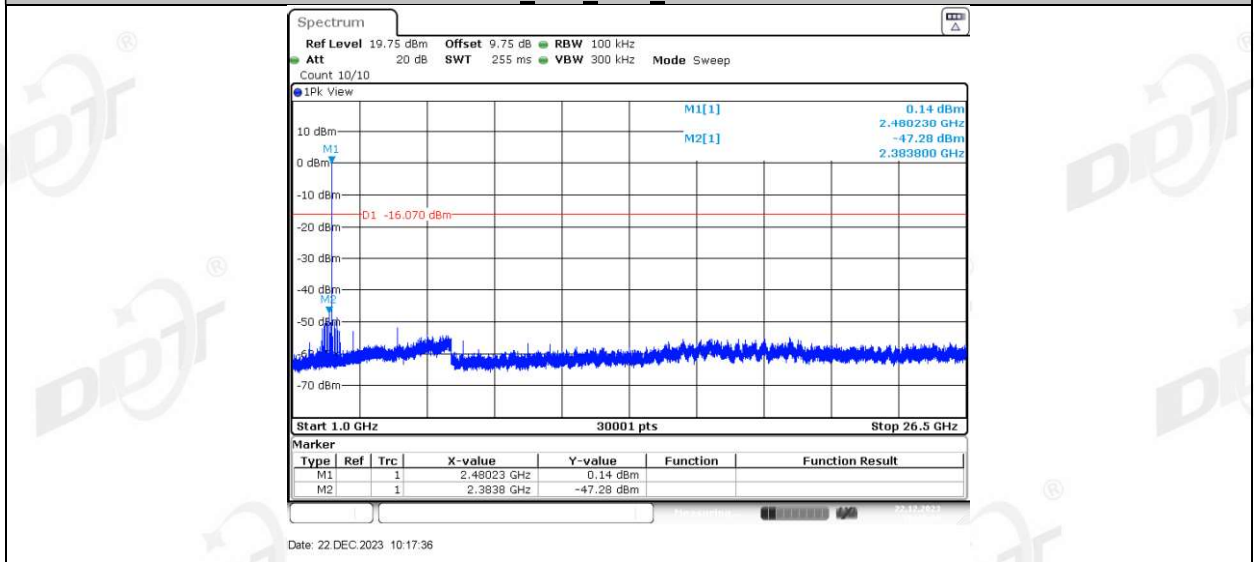

11. Duty cycle

11.1. Block diagram of test setup

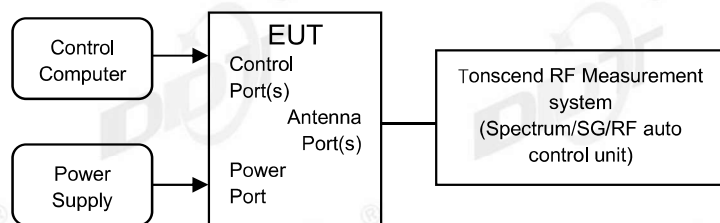

11.2. Limit

Just for Report.

11.3. Test procedure

- (1) Connected the EUT's antenna port to the Spectrum Analyzer by suitable attenuator, The cable loss and attenuator loss have been put into spectrum analyzer as amplitude offset.

set the Spectrum Analyzer as below:

Centre Frequency: The centre frequency of the middle hopping channel.

Resolution BW: 10 MHz.

Video BW: 10 MHz.

Span: Zero span.

Detector: Peak.

Trace Mode: Clear Write.

Sweep: Video Trigger

- (2) When the trace is complete, measure the sending time of 1 burst and the duty cycle of 1 burst cycle.

- (3) Calculate dwell time follow below formula:

Duty cycle= Pulse's on time / Burst cycle

11.4. Test result

| | | | |
|-----------------------|--------------------------|--------------------|------------|
| Test Site: | RF Measurement System 3# | Test Date: | 2023.12.22 |
| Ambient Condition: | 17.4 °C,27.5 %RH | Test Engineer: | Zhongyao |
| Equipment under Test: | Bluetooth Wall Plate | Model No.: | BTWP2 |
| Sample Number | S23120624-03 | Test Power Supply: | DC 12V |

| Test Mode | Antenna | Frequency [MHz] | ON Time [ms] | Period [ms] | Duty Cycle [%] | Duty Cycle Factor[dB] |
|-----------|---------|-----------------|--------------|-------------|----------------|-----------------------|
| DH5 | Ant1 | 2402 | 2.89 | 3.75 | 77.07 | 1.13 |
| | | 2441 | 2.89 | 3.75 | 77.07 | 1.13 |
| | | 2480 | 2.89 | 3.75 | 77.07 | 1.13 |
| 2DH5 | Ant1 | 2402 | 2.89 | 3.76 | 76.86 | 1.14 |
| | | 2441 | 2.90 | 3.76 | 77.13 | 1.13 |
| | | 2480 | 2.89 | 3.75 | 77.07 | 1.13 |
| 3DH5 | Ant1 | 2402 | 2.89 | 3.75 | 77.07 | 1.13 |
| | | 2441 | 2.89 | 3.75 | 77.07 | 1.13 |
| | | 2480 | 2.89 | 3.75 | 77.07 | 1.13 |

11.5. Test graphs



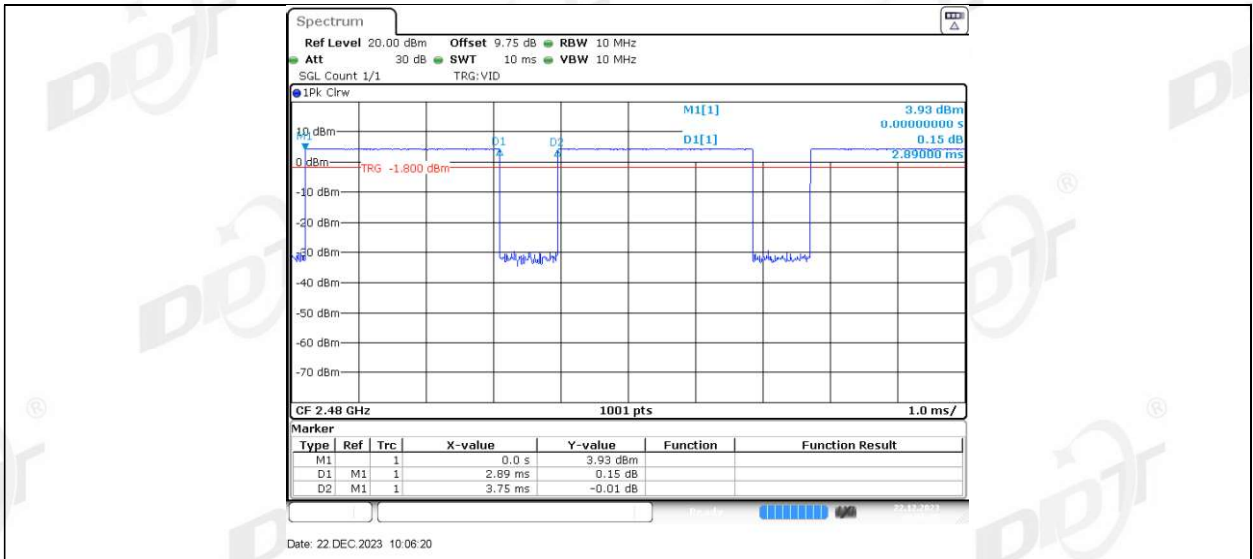

2DH5_Ant1_2402

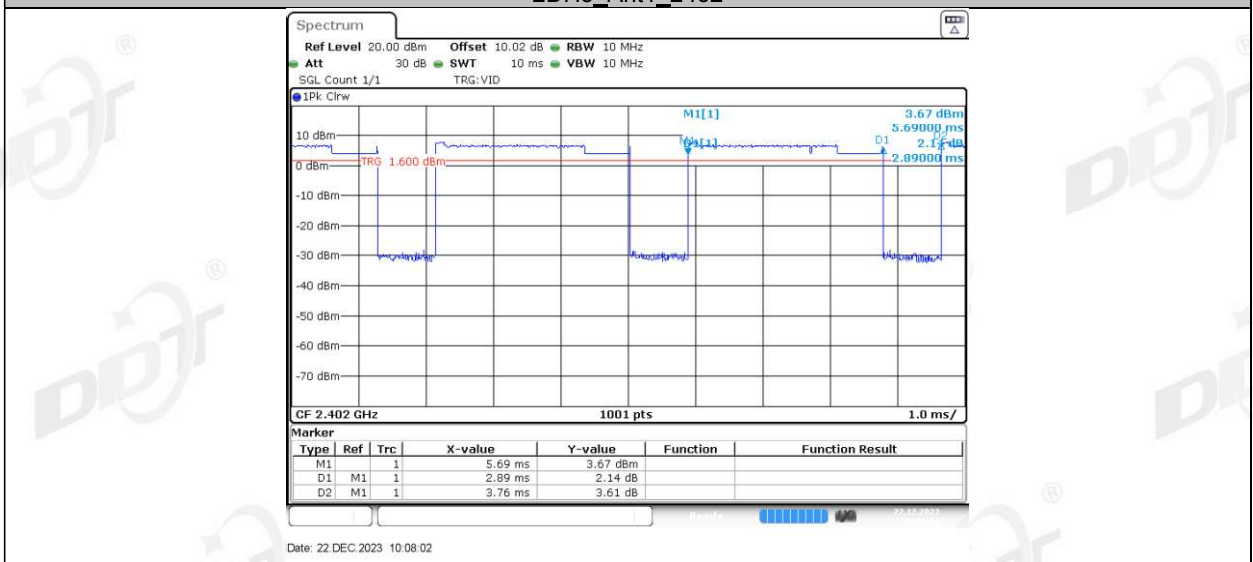

2DH5_Ant1_2441

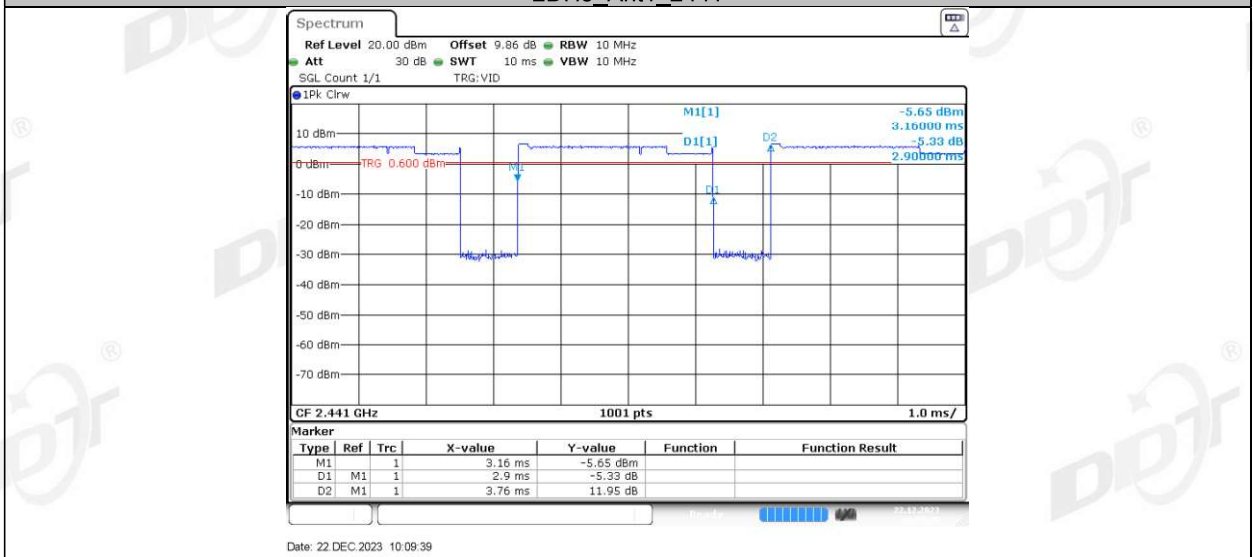

2DH5_Ant1_2480

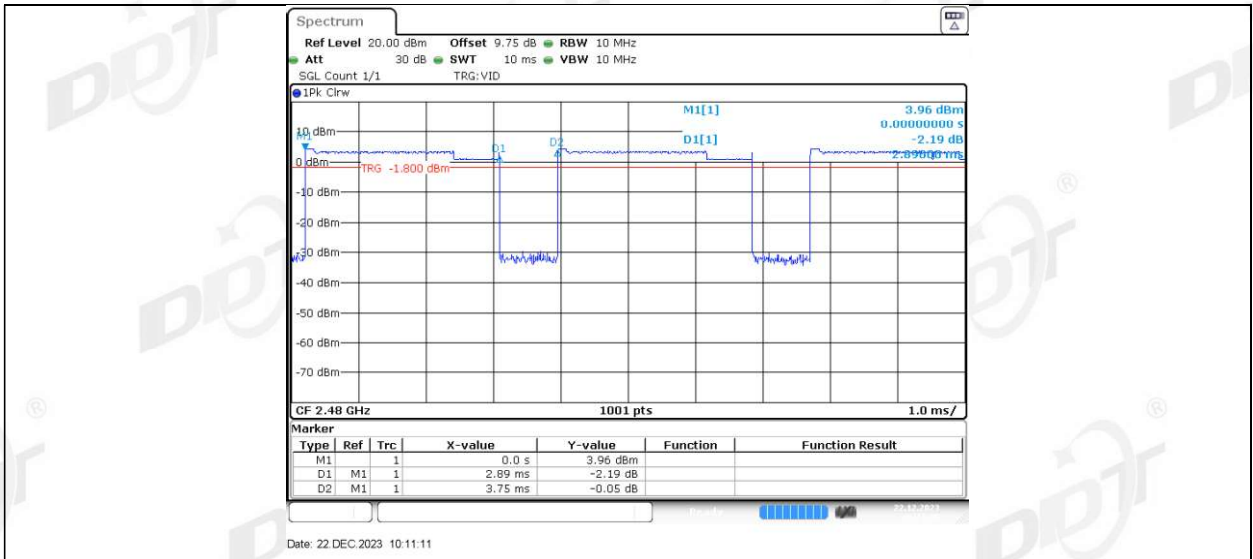

3DH5_Ant1_2402

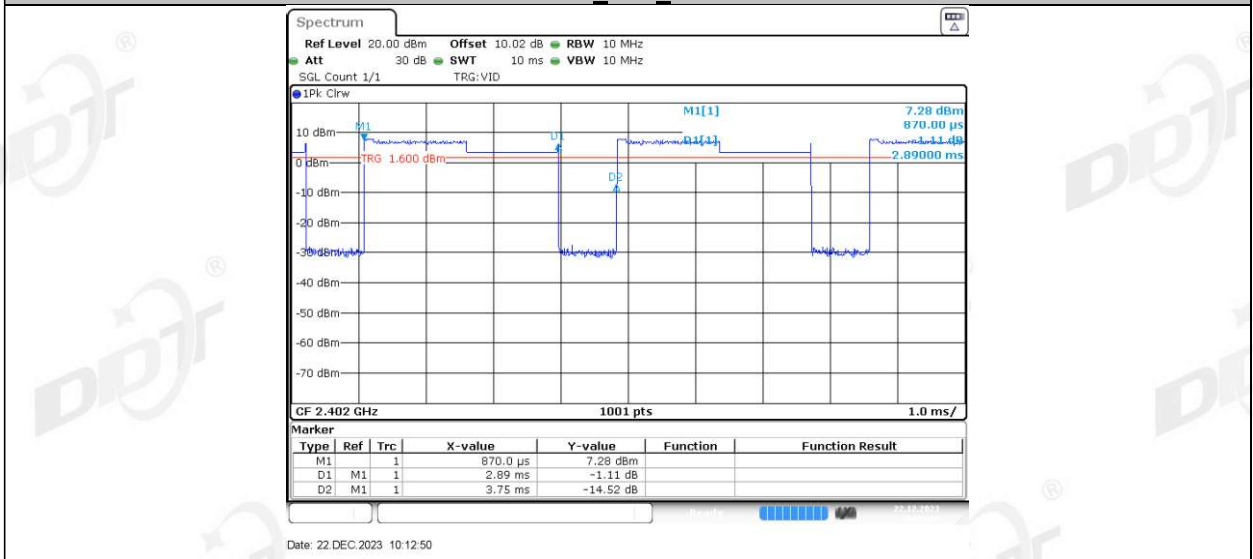

3DH5_Ant1_2441

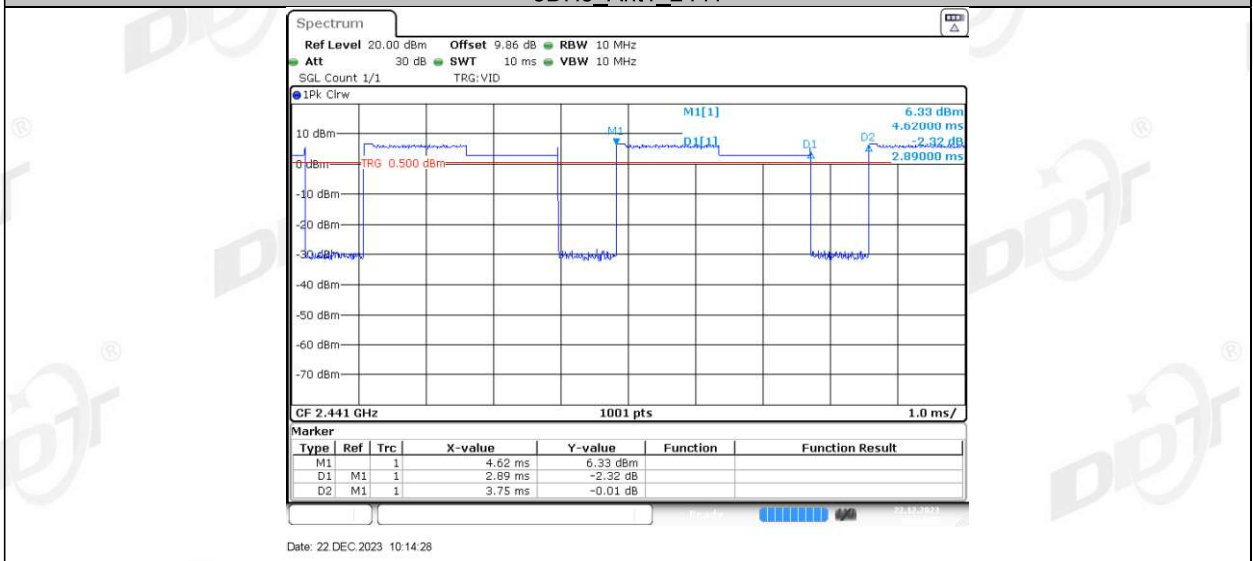

3DH5_Ant1_2480

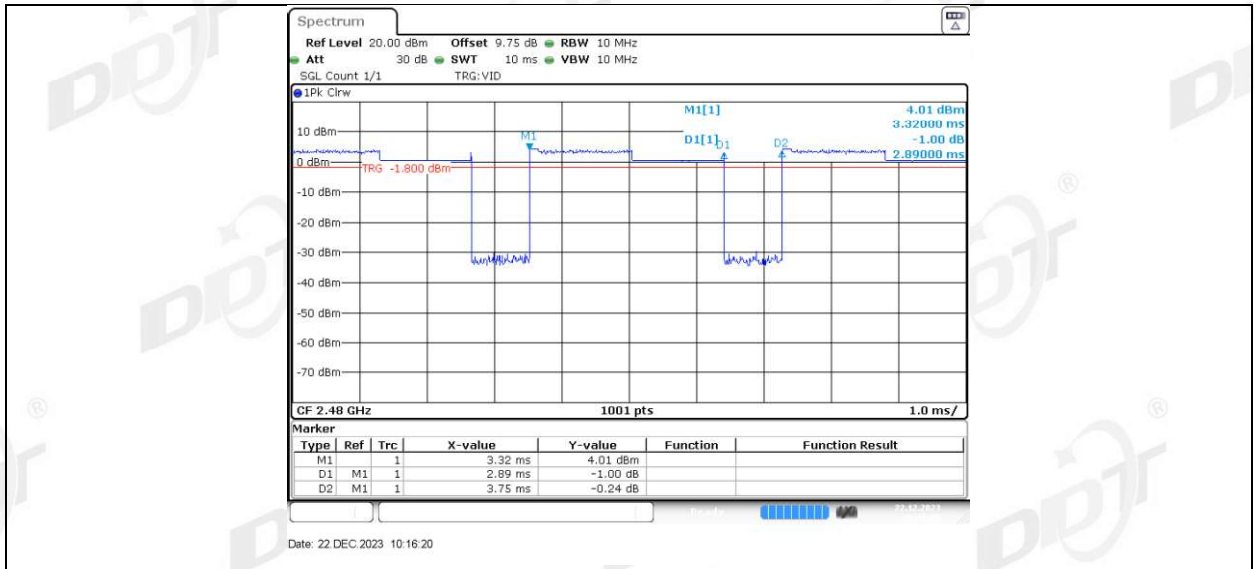

12. Radiated Emission

12.1. Test equipment

| Equipment | Manufacturer | Model No. | Serial Number | Due Date |
|-----------------------------------|--------------|--|------------------|------------|
| ☑Radiation 3#Chamber | | | | |
| EMI TEST RECEIVER | R&S | ESU26 | 100472 | 2024/04/22 |
| PSA Series Spectrum Analyzer | Agilent | E4447A | MY50180031 | 2024/04/22 |
| Active Loop Antenna | Schwarzbeck | FMZB-1519 | 1519-038 | 2024/09/10 |
| Trilog Broadband Antenna | Schwarzbeck | VULB 9163 | 01429 | 2024/07/11 |
| Double Ridged Horn Antenna | Schwarzbeck | BBHA 9120 D | 02468 | 2024/09/17 |
| Broad Band Horn Antenna | Schwarzbeck | BBHA 9170 | 790 | 2024/04/25 |
| Pre-amplifier | COM-POWER | PAM-118A | 18040084 | 2024/07/14 |
| Pre-amplifier | COM-POWER | PAM-840A | 461369 | 2024/04/26 |
| RE Cable | N/A | W23.02 CP1-X2 + W23.09 AP1-X8+ JCT26S-NJ-NJ- 1.5M | 4.5M+8M+1.5 M | 2024/04/20 |
| RF Cable | Yuhu | JCTB810-NJ-NJ- 9M+ ZT26S- SMAJ-SMAJ-1M | 21123964 | 2024/04/22 |
| Band Reject Filter(2400-2500 MHz) | REBES | BRM50702 | G555 | N/A |
| Test Software | Tonscend | JS32-RE | V 5.0.0.1 | N/A |

12.2. Block diagram of test setup

In 3 m Anechoic Chamber, test setup diagram for 9 kHz- 30 MHz:

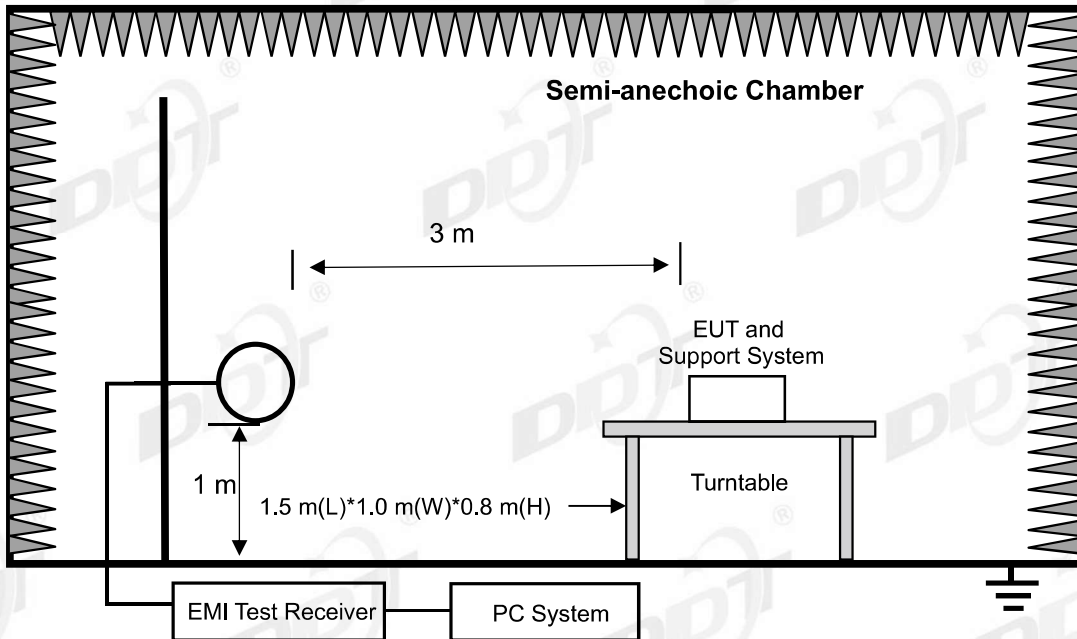

In 3 m Anechoic Chamber, test setup diagram for 30 MHz - 1 GHz:

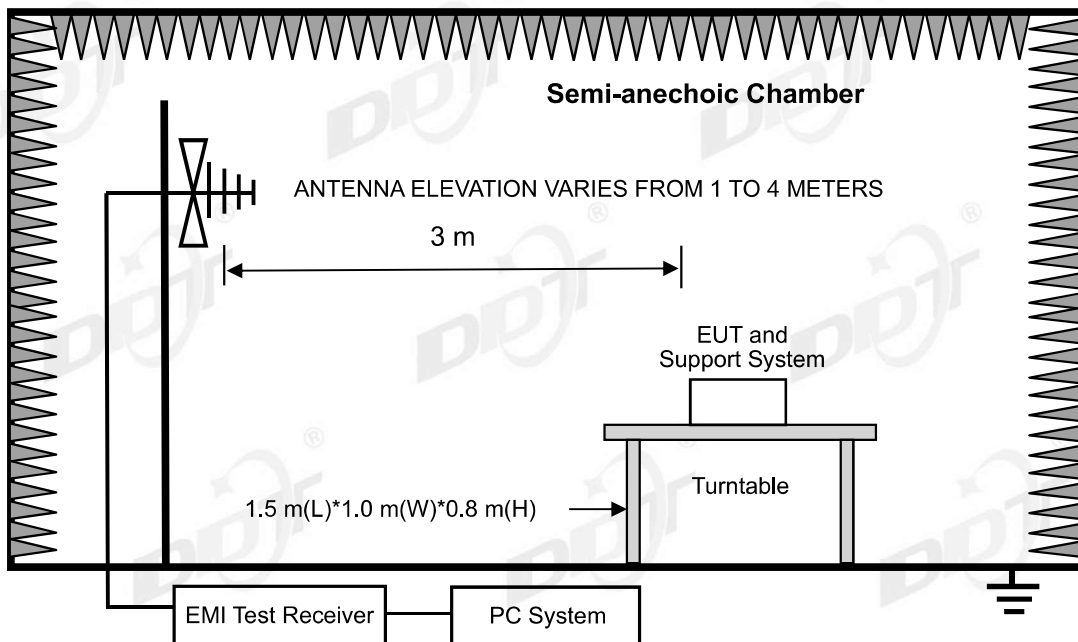

In 3 m Anechoic Chamber, test setup diagram for frequency above 1 GHz:

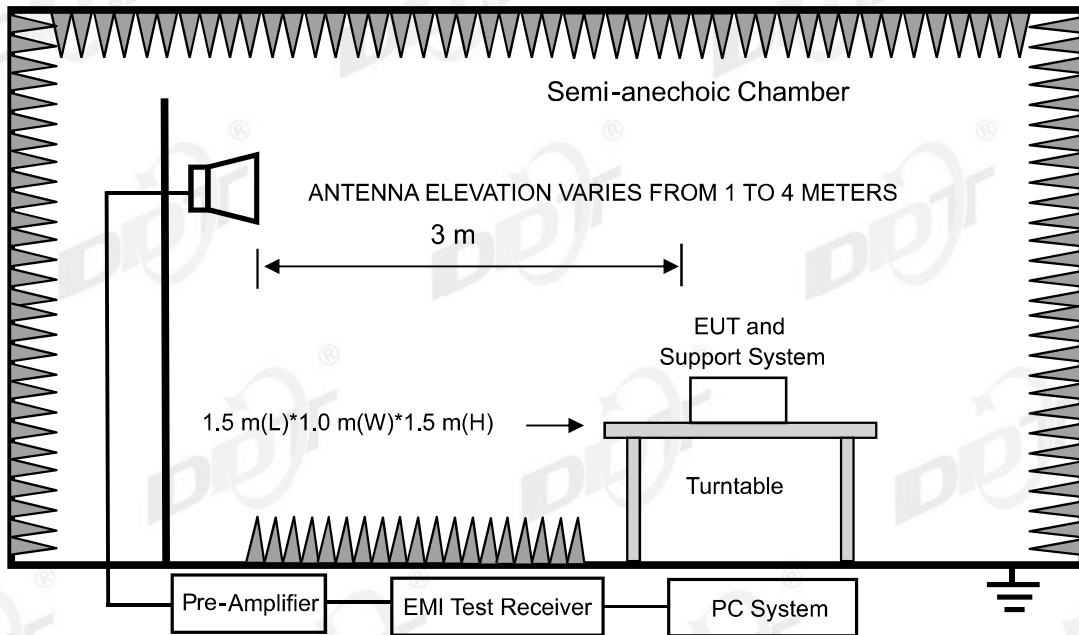

Note: Install an appropriate filter at the input of the measurement system power amplifier. This filter can attenuate the fundamental emission of the EUT and allow an accurate measurement of the associated harmonics and spurious emissions. The filter had been characterized, and the attenuation loss factors had been accounted for in the measurement results.

12.3. Limit

(1) FCC 15.205 Restricted frequency band

| MHz | MHz | MHz | GHz |
|--------------------------|---------------------|---------------|------------------|
| 0.090-0.110 | 16.42-16.423 | 399.9-410 | 4.5-5.15 |
| ¹ 0.495-0.505 | 16.69475-16.69525 | 608-614 | 5.35-5.46 |
| 2.1735-2.1905 | 16.80425-16.80475 | 960-1240 | 7.25-7.75 |
| 4.125-4.128 | 25.5-25.67 | 1300-1427 | 8.025-8.5 |
| 4.1772&4.17775 | 37.5-38.25 | 1435-1626.5 | 9.0-9.2 |
| 4.2072&4.20775 | 73-74.6 | 1645.5-1646.5 | 9.3-9.5 |
| 6.215-6.218 | 74.8-75.2 | 1660-1710 | 10.6-12.7 |
| 6.26775-6.26825 | 108-121.94 | 1718.8-1722.2 | 13.25-13.4 |
| 6.31175-6.31225 | 123-138 | 2200-2300 | 14.47-14.5 |
| 8.291-8.294 | 149.9-150.05 | 2310-2390 | 15.35-16.2 |
| 8.362-8.366 | 156.52475-156.52525 | 2483.5-2500 | 17.7-21.4 |
| 8.37625-8.38675 | 156.7-156.9 | 2690-2900 | 22.01-23.12 |
| 8.41425-8.41475 | 162.0125-167.17 | 3260-3267 | 23.6-24.0 |
| 12.29-12.293 | 167.72-173.2 | 3332-3339 | 31.2-31.8 |
| 12.51975-12.52025 | 240-285 | 3345.8-3358 | 36.43-36.5 |
| 12.57675-12.57725 | 322-335.4 | 3600-4400 | (²) |
| 13.36-13.41 | | | |

¹Until February 1, 1999, this restricted band shall be 0.490-0.510 MHz

²Above 38.6

RSS-Gen section 8.10 Restricted frequency bands*

| MHz | MHz | MHz | GHz |
|-----------------|---------------------|---------------|-------------|
| 0.090-0.110 | 12.51975-12.52025 | 240-285 | 3.5-4.4 |
| 0.495-0.505 | 12.57675-12.57725 | 322-335.4 | 4.5-5.15 |
| 2.1735-2.1905 | 13.36-13.41 | 399.9-410 | 5.35-5.46 |
| 3.020-3.026 | 16.42-16.423 | 608-614 | 7.25-7.75 |
| 4.125-4.128 | 16.69475-16.69525 | 960-1427 | 8.025-8.5 |
| 4.1772&4.17775 | 16.80425-16.80475 | 1435-1626.5 | 9.0-9.2 |
| 4.2072&4.20775 | 25.5-25.67 | 1645.5-1646.5 | 9.3-9.5 |
| 5.677-5.683 | 37.5-38.25 | 1660-1710 | 10.6-12.7 |
| 6.215-6.218 | 73-74.6 | 1718.8-1722.2 | 13.25-13.4 |
| 6.26775-6.26825 | 74.8-75.2 | 2200-2300 | 14.47-14.5 |
| 6.31175-6.31225 | 108-138 | 2310-2390 | 15.35-16.2 |
| 8.291-8.294 | 149.9-150.05 | 2483.5-2500 | 17.7-21.4 |
| 8.362-8.366 | 156.52475-156.52525 | 2655-2900 | 22.01-23.12 |
| 8.37625-8.38675 | 156.7-156.9 | 3260-3267 | 23.6-24.0 |
| 8.41425-8.41475 | 162.0125-167.17 | 3332-3339 | 31.2-31.8 |
| 12.29-12.293 | 167.72-173.2 | 3345.8-3358 | 36.43-36.5 |
| | | | Above 38.6 |

* Certain frequency bands listed in table and in bands above 38.6 GHz are designated for licence-exempt applications. These frequency bands and the requirements that apply to related devices are set out in the 200 and 300 series of RSSs.

(2) FCC 15.209 Limit & RSS-Gen section 8.9 Limit

| FREQUENCY MHz | DISTANCE Meters | FIELD STRENGTHS LIMIT | |
|------------------|--------------------|---|-----------------------------------|
| | | $\mu\text{V}/\text{m}$ | $\text{dB}(\mu\text{V})/\text{m}$ |
| 0.009 ~ 0.490 | 300 | 2400/F(kHz) | 67.6-20log(F) |
| 0.490 ~ 1.705 | 30 | 24000/F(kHz) | 87.6-20log(F) |
| 1.705 ~ 30.0 | 30 | 30 | 29.54 |
| 30 ~ 88 | 3 | 100 | 40.0 |
| 88 ~ 216 | 3 | 150 | 43.5 |
| 216 ~ 960 | 3 | 200 | 46.0 |
| 960 ~ 1000 | 3 | 500 | 54.0 |
| Above 1000 | 3 | 74.0 dB(μV)/m (Peak) 54.0 dB(μV)/m (Average) | |

Note: (1) The emission limits shown in the above table are based on measurements employing a CISPR QP detector except for the frequency bands 9 - 90 kHz, 110 - 490 kHz and above 1000 MHz, radiated emissions limits in these three bands are based on measurements employing an average detector.

(2) At frequencies below 30 MHz, measurement may be performed at a distance closer than

that specified, and the limit at closer measurement distance can be extrapolated by below formula:

$$\text{Limit}_{3\text{m}}(\text{dBuV/m}) = \text{Limit}_{30\text{m}}(\text{dBuV/m}) + 40\text{Log}(30\text{m}/3\text{m})$$

(3) Limit for this EUT

The emissions appearing within 15.205 restricted frequency bands shall not exceed the limits shown in 15.209, and the emissions appearing within RSS-Gen section 8.10 Restricted frequency bands shall not exceed the limits shown in RSS-Gen section 8.9, all the other emissions shall be at least 20 dB below the fundamental emissions or comply with 15.209 limits and RSS-Gen section 8.9 limits.

12.4. Test procedure

(1) EUT was placed on a non-metallic table, 80 cm above the ground plane inside a semi-anechoic chamber for below 1G and 150 cm above the ground plane inside a fully-anechoic chamber for above 1G.

(2) Test antenna was located 3 m from the EUT on an adjustable mast, and the antenna used as below table.

| Test frequency range | Test antenna used | Test antenna distance |
|----------------------|--|-----------------------|
| 9 kHz - 30 MHz | Active Loop antenna | 3 m |
| 30 MHz - 1 GHz | Trilog Broadband Antenna | 3 m |
| 1 GHz - 18 GHz | Double Ridged Horn Antenna(1 GHz-18 GHz) | 3 m |
| 18 GHz - 40 GHz | Horn Antenna(18 GHz-40 GHz) | 1 m |

According ANSI C63.10:2013 clause 6.4.6 and 6.5.3, for measurements below 30 MHz, Antenna was located 3 m from EUT, the loop antenna was positioned in three antenna orientations (parallel, perpendicular, and round-parallel), for each measurement antenna alignment, the EUT shall be rotated through 0° to 360° on a turntable, and the lowest height of the magnetic antenna shall be 1 m above the ground. For measurement above 30MHz, the trilog Broadband Antenna or Horn Antenna was located 3m from EUT, Measurements were made with the antenna positioned in both the horizontal and vertical planes of Polarization, and the measurement antenna was varied from 1 m to 4 m. in height above the reference ground plane to obtain the maximum signal strength.

(3) Below pre-scan procedure was first performed in order to find prominent frequency spectrum radiated emissions from 9 kHz to 25 GHz:

(a) Scanning the peak frequency spectrum with the antenna specified in step (3), and the EUT was rotated 360 degree, the antenna height was varied from 1 m to 4 m (Except loop antenna, it's fixed 1 m above ground.)

(b) Change work frequency or channel of device if practicable.

(c) Change modulation type of device if practicable.

(d) Change power supply range from 85% to 115% of the rated supply voltage

(e) Rotated EUT though three orthogonal axes to determine the attitude of EUT arrangement produces highest emissions.

Spectrum frequency from 9 kHz to 25 GHz (tenth harmonic of fundamental frequency) was investigated, and no any obvious emission were detected from 18 GHz to 25 GHz, so below final test was performed with frequency range from 9 kHz to 18 GHz.

(4) For final emissions measurements at each frequency of interest, the EUT was rotated and the

antenna height was varied between 1 m and 4 m in order to maximize the emission. Measurements in both horizontal and vertical polarities were made and the data was recorded. In order to find the maximum emission, the relative positions of equipment and all of the interface cables were changed according to ANSI C63.10:2013 on Radiated Emission test.

(5) The emissions from 9 kHz to 1 GHz were measured based on CISPR QP detector except for the frequency bands 9 - 90 kHz, 110 - 490 kHz, for emissions from 9 kHz - 90 kHz, 110 kHz - 490 kHz and above 1 GHz were measured based on average detector, for emissions above 1 GHz, peak emissions also be measured and need comply with Peak limit.

(6) The emissions from 9 kHz to 1 GHz, QP or average values were measured with EMI receiver with below RBW.

| Frequency band | RBW |
|------------------|---------|
| 9 kHz - 150 kHz | 200 Hz |
| 150 kHz - 30 MHz | 9 kHz |
| 30 MHz - 1 GHz | 120 kHz |

(7) For emissions above 1GHz, both Peak and Average level were measured with Spectrum Analyzer, and the RBW is set at 1 MHz, VBW is set at 3 MHz for Peak measure; According ANSI C63.10:2013 clause 4.1.4.2.2 procedure for average measure.

(8) For portable device, X axis, Y axis, Z axis are tested, and worse setup is reported.

12.5. Test result

Pass. (See below detailed test result)

All the emissions except fundamental emission from 9 kHz to 25 GHz were comply with 15.209 limits and RSS-Gen section 8.9 limits.

Note1: According exploratory test, the emission levels are 20 dB below the limit detected from 9 kHz to 30 MHz and 18 GHz to 25 GHz, so the final test was performed with frequency range from 30 MHz to 18 GHz and recorded in below.

Note2: 30 MHz ~ 25 GHz: (Scan with GFSK, $\pi/4$ -DQPSK and 8DPSK, the worst case is GFSK Mode)

Note3: For emissions below 1 GHz, according exploratory explorer test, when change Tx mode and channel, have no distinct influence on emissions level, so for emissions below 1 GHz, the final test was only performed with EUT working in GFSK, Tx 2480 MHz mode.

Note4: For emissions above 1 GHz. If peak results comply with AV limit, AV Result is deemed to comply with AV limit.

TR-4-E-009 Radiated Emission Test Result

Test Date: 2023-12-22 **Tested By:** Junchang Du
EUT: Bluetooth Wall Plate **Model Number:** BTWP2
Test Mode: BT **Power Supply:** DC 12V
Condition: Temp:23.7°C;Humi:50.8% **Test Site:** DDT 3# Chamber
File Path: d:\ts\2023 report data\Q23120624-2E BTWP2\FCC BELOW 1G\20231222-001048_V
Memo: Sample Number:S23120624-03 Power Setting:2

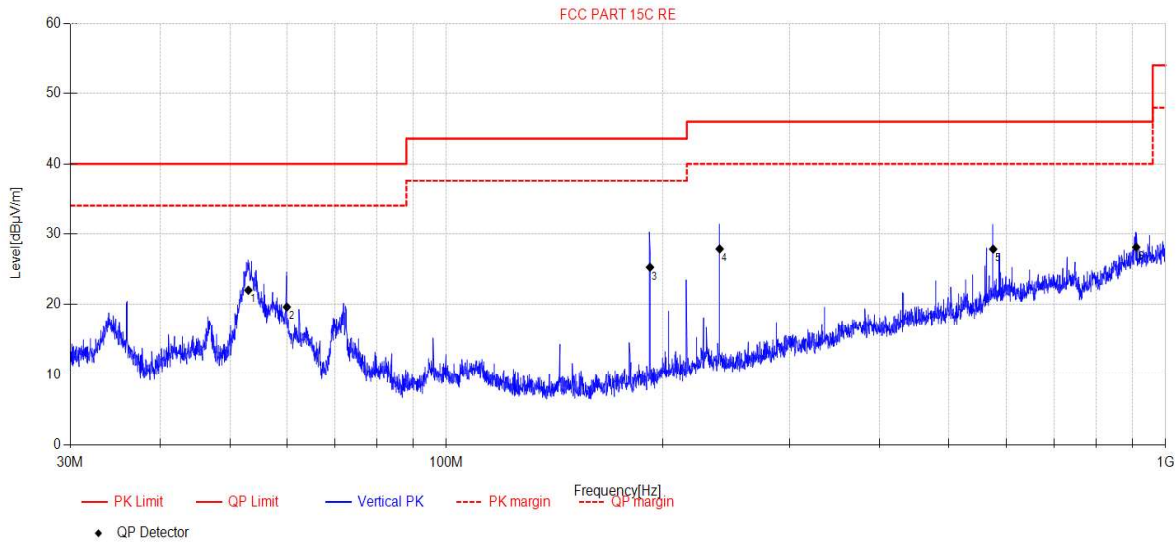

| Data List | | | | | | | | | | |
|-----------|-------------|------------------|---------------------|-----------------|----------|-----------------|----------------|-------------|----------|----------|
| NO. | Freq. [MHz] | Reading [dBµV/m] | Antenna Factor [dB] | Cable Loss [dB] | AMP [dB] | Result [dBµV/m] | Limit [dBµV/m] | Margin [dB] | Detector | Polarity |
| 1 | 53.05 | 34.42 | 13.53 | 4.74 | -30.68 | 22.01 | 40.00 | 17.99 | QP | Vertical |
| 2 | 60.02 | 32.72 | 12.79 | 4.76 | -30.63 | 19.64 | 40.00 | 20.36 | QP | Vertical |
| 3 | 191.94 | 40.52 | 9.71 | 5.66 | -30.62 | 25.27 | 43.50 | 18.23 | QP | Vertical |
| 4 | 239.89 | 40.65 | 11.79 | 5.90 | -30.48 | 27.86 | 46.00 | 18.14 | QP | Vertical |
| 5 | 575.90 | 31.99 | 18.51 | 7.23 | -29.90 | 27.83 | 46.00 | 18.17 | QP | Vertical |
| 6 | 910.32 | 27.25 | 21.38 | 8.38 | -28.91 | 28.10 | 46.00 | 17.90 | QP | Vertical |

Note:

1. Result Level = Reading + Cable loss + Antenna Factor + AMP
2. If Peak Result complies with QP limit, QP Result is deemed to comply with QP limit.
3. Test setup: RBW: 120 kHz, VBW: 300 kHz, Sweep time: auto.

Radiated Emission Test Result (above 1 GHz)

TR-4-E-009 Radiated Emission Test Result

Test Date: 2023-12-21 **Tested By:** Junchang Du
EUT: Bluetooth Wall Plate **Model Number:** BTWP2
Test Mode: DH5 TX 2402MHz **Power Supply:** DC 12V
Condition: Temp:23.7°C;Humi:50.8% **Test Site:** DDT 3# Chamber
File Path: d:\ts\2023 report data\Q23120624-2E BTWP2\FCC ABOVE 1G\3
Memo: Sample Number:S23120624-03 Power Setting:2

Test Graph

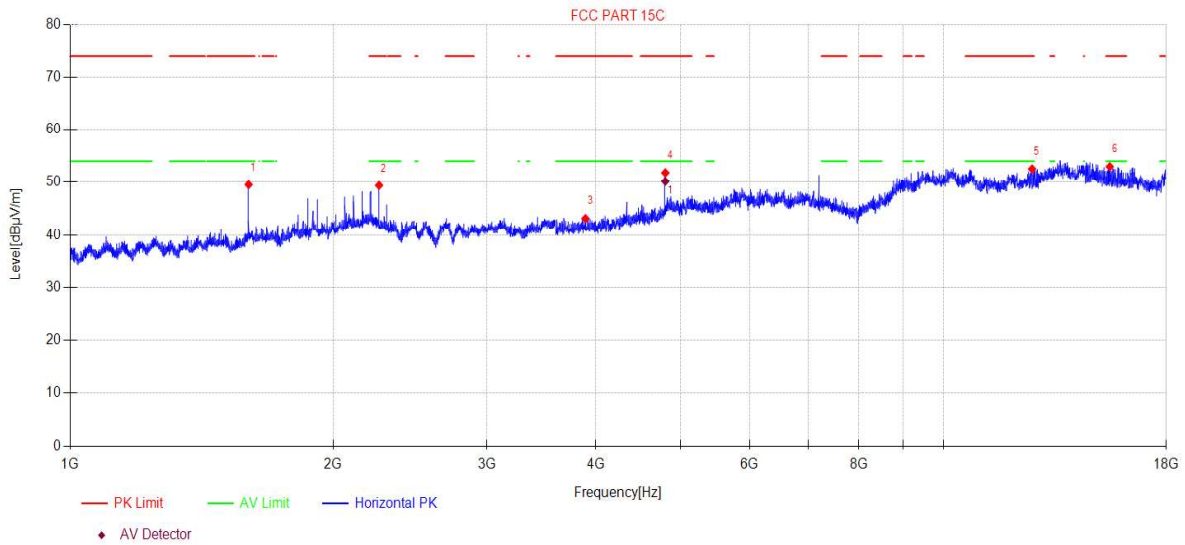

| Data List | | | | | | | | | | |
|-----------|-------------|------------------|---------------------|-----------------|----------|----------------|----------------|-------------|----------|------------|
| N O. | Freq. [MHz] | Reading [dBµV/m] | Antenna Factor [dB] | Cable loss [dB] | AMP [dB] | Level [dBµV/m] | Limit [dBµV/m] | Margin [dB] | Detector | Polarity |
| 1 | 1600.80 | 56.08 | 25.60 | 4.81 | -36.96 | 49.53 | 74.00 | 24.47 | PK | Horizontal |
| 2 | 2257.88 | 53.95 | 27.22 | 5.96 | -37.74 | 49.39 | 74.00 | 24.61 | PK | Horizontal |
| 3 | 3890.85 | 46.60 | 31.15 | 5.83 | -40.38 | 43.20 | 74.00 | 30.80 | PK | Horizontal |
| 4 | 4803.36 | 51.92 | 32.59 | 7.47 | -40.15 | 51.83 | 74.00 | 22.17 | PK | Horizontal |
| 5 | 12633.31 | 42.36 | 39.47 | 10.54 | -39.81 | 52.56 | 74.00 | 21.44 | PK | Horizontal |
| 6 | 15506.25 | 39.62 | 38.79 | 13.64 | -39.06 | 52.99 | 74.00 | 21.01 | PK | Horizontal |

| Data List | | | | | | | | | | |
|-----------|-------------|------------------|---------------------|-----------------|----------|----------------|----------------|-------------|----------|------------|
| N O. | Freq. [MHz] | Reading [dBµV/m] | Antenna Factor [dB] | Cable loss [dB] | AMP [dB] | Level [dBµV/m] | Limit [dBµV/m] | Margin [dB] | Detector | Polarity |
| 1 | 4803.36 | 50.26 | 32.59 | 7.47 | -40.15 | 50.17 | 54.00 | 3.83 | AV | Horizontal |

- Note:
1. Level = Reading + Cable loss + Antenna Factor + AMP
 2. If Peak Result complies with AV limit, AV Result is deemed to comply with AV limit.
 3. Test setup: RBW: 1 MHz, VBW: 3 MHz, Sweep time: auto.

TR-4-E-009 Radiated Emission Test Result

Test Date: 2023-12-21 **Tested By:** Junchang Du
EUT: Bluetooth Wall Plate **Model Number:** BTWP2
Test Mode: DH5 TX 2402MHz **Power Supply:** DC 12V
Condition: Temp:23.7°C;Humi:50.8% **Test Site:** DDT 3# Chamber
File Path: d:\ts\2023 report data\Q23120624-2E BTWP2\FCC ABOVE 1G4
Memo: Sample Number:S23120624-03 Power Setting:2

Test Graph

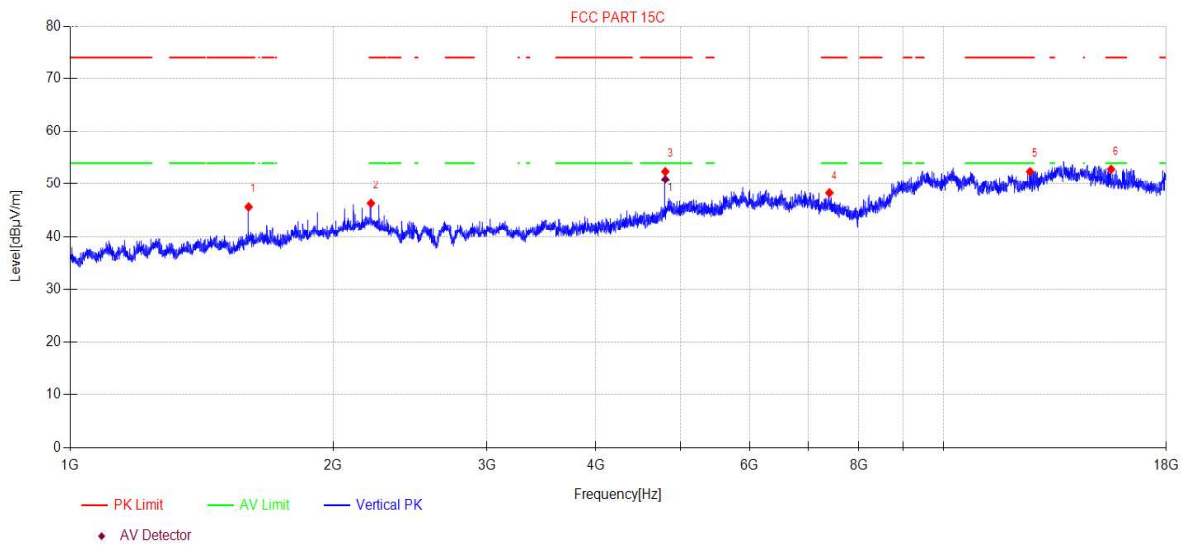

| Data List | | | | | | | | | | |
|-----------|-------------|------------------|---------------------|-----------------|----------|----------------|----------------|-------------|----------|----------|
| N O. | Freq. [MHz] | Reading [dBµV/m] | Antenna Factor [dB] | Cable loss [dB] | AMP [dB] | Level [dBµV/m] | Limit [dBµV/m] | Margin [dB] | Detector | Polarity |
| 1 | 1600.80 | 52.27 | 25.60 | 4.81 | -36.96 | 45.72 | 74.00 | 28.28 | PK | Vertical |
| 2 | 2210.10 | 50.31 | 27.70 | 5.98 | -37.60 | 46.39 | 74.00 | 27.61 | PK | Vertical |
| 3 | 4803.36 | 52.52 | 32.59 | 7.47 | -40.15 | 52.43 | 74.00 | 21.57 | PK | Vertical |
| 4 | 7403.56 | 45.71 | 36.69 | 7.64 | -41.71 | 48.33 | 74.00 | 25.67 | PK | Vertical |
| 5 | 12567.76 | 42.26 | 39.40 | 10.54 | -39.78 | 52.42 | 74.00 | 21.58 | PK | Vertical |
| 6 | 15560.13 | 39.40 | 38.68 | 13.89 | -39.10 | 52.87 | 74.00 | 21.13 | PK | Vertical |

| Data List | | | | | | | | | | |
|-----------|-------------|------------------|---------------------|-----------------|----------|----------------|----------------|-------------|----------|----------|
| N O. | Freq. [MHz] | Reading [dBµV/m] | Antenna Factor [dB] | Cable loss [dB] | AMP [dB] | Level [dBµV/m] | Limit [dBµV/m] | Margin [dB] | Detector | Polarity |
| 1 | 4803.82 | 51.01 | 32.59 | 7.47 | -40.15 | 50.92 | 54.00 | 3.08 | AV | Vertical |

Note:

1. Level = Reading + Cable loss + Antenna Factor + AMP
2. If Peak Result complies with AV limit, AV Result is deemed to comply with AV limit.
3. Test setup: RBW: 1 MHz, VBW: 3 MHz, Sweep time: auto.

TR-4-E-009 Radiated Emission Test Result

Test Date: 2023-12-21 **Tested By:** Junchang Du
EUT: Bluetooth Wall Plate **Model Number:** BTWP2
Test Mode: DH5 TX 2441MHz **Power Supply:** DC 12V
Condition: Temp:23.7°C;Humi:50.8% **Test Site:** DDT 3# Chamber
File Path: d:\ts\2023 report data\Q23120624-2E BTWP2\FCC ABOVE 1G5
Memo: Sample Number:S23120624-03 Power Setting:2

Test Graph

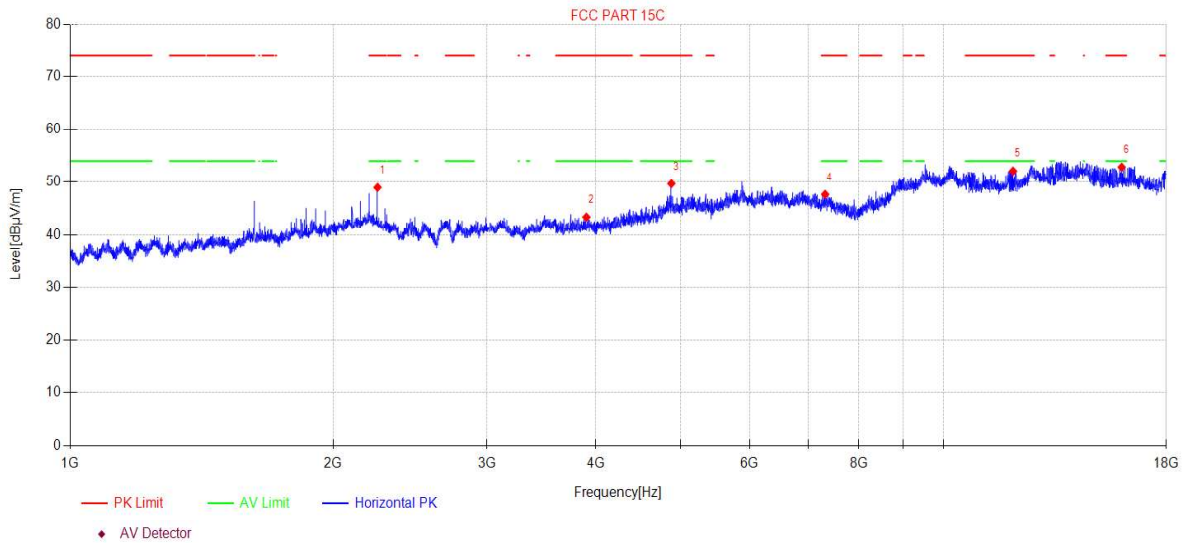

| Data List | | | | | | | | | | |
|-----------|-------------|------------------|---------------------|-----------------|----------|----------------|----------------|-------------|----------|------------|
| N O. | Freq. [MHz] | Reading [dBµV/m] | Antenna Factor [dB] | Cable loss [dB] | AMP [dB] | Level [dBµV/m] | Limit [dBµV/m] | Margin [dB] | Detector | Polarity |
| 1 | 2248.76 | 53.42 | 27.31 | 5.96 | -37.71 | 48.98 | 74.00 | 25.02 | PK | Horizontal |
| 2 | 3900.98 | 46.80 | 31.20 | 5.83 | -40.39 | 43.44 | 74.00 | 30.56 | PK | Horizontal |
| 3 | 4880.32 | 48.87 | 33.31 | 7.63 | -40.12 | 49.69 | 74.00 | 24.31 | PK | Horizontal |
| 4 | 7320.58 | 44.70 | 36.86 | 7.63 | -41.50 | 47.69 | 74.00 | 26.31 | PK | Horizontal |
| 5 | 12013.72 | 41.95 | 39.21 | 10.54 | -39.57 | 52.13 | 74.00 | 21.87 | PK | Horizontal |
| 6 | 16002.51 | 38.37 | 38.00 | 15.87 | -39.36 | 52.88 | 74.00 | 21.12 | PK | Horizontal |

Note:

1. Level = Reading + Cable loss + Antenna Factor + AMP
2. If Peak Result complies with AV limit, AV Result is deemed to comply with AV limit.
3. Test setup: RBW: 1 MHz, VBW: 3 MHz, Sweep time: auto.

TR-4-E-009 Radiated Emission Test Result

Test Date: 2023-12-21 **Tested By:** Junchang Du
EUT: Bluetooth Wall Plate **Model Number:** BTWP2
Test Mode: DH5 TX 2441MHz **Power Supply:** DC 12V
Condition: Temp:23.7°C;Humi:50.8% **Test Site:** DDT 3# Chamber
File Path: d:\ts\2023 report data\Q23120624-2E BTWP2\FCC ABOVE 1G6
Memo: Sample Number:S23120624-03 Power Setting:2

Test Graph

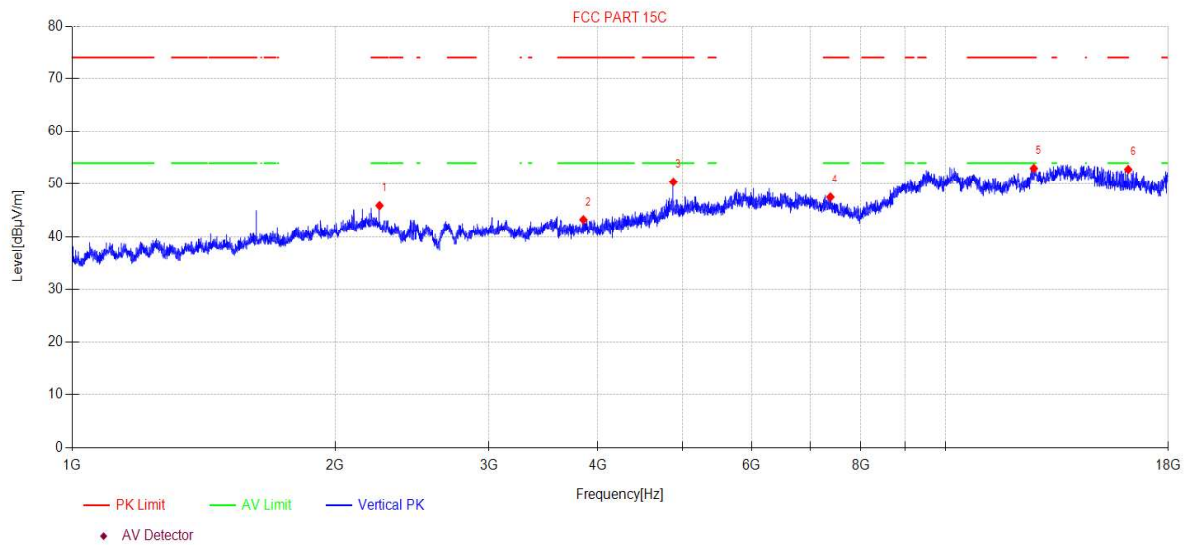

| Data List | | | | | | | | | | |
|-----------|-------------|------------------|---------------------|-----------------|----------|----------------|----------------|-------------|----------|----------|
| N O. | Freq. [MHz] | Reading [dBµV/m] | Antenna Factor [dB] | Cable loss [dB] | AMP [dB] | Level [dBµV/m] | Limit [dBµV/m] | Margin [dB] | Detector | Polarity |
| 1 | 2248.76 | 50.40 | 27.31 | 5.96 | -37.71 | 45.96 | 74.00 | 28.04 | PK | Vertical |
| 2 | 3849.47 | 46.98 | 30.90 | 5.82 | -40.36 | 43.34 | 74.00 | 30.66 | PK | Vertical |
| 3 | 4880.32 | 49.62 | 33.31 | 7.63 | -40.12 | 50.44 | 74.00 | 23.56 | PK | Vertical |
| 4 | 7384.32 | 44.85 | 36.73 | 7.64 | -41.66 | 47.56 | 74.00 | 26.44 | PK | Vertical |
| 5 | 12626.01 | 42.82 | 39.45 | 10.54 | -39.80 | 53.01 | 74.00 | 20.99 | PK | Vertical |
| 6 | 16193.25 | 39.41 | 37.81 | 15.12 | -39.52 | 52.82 | 74.00 | 21.18 | PK | Vertical |

Note:

- Level = Reading + Cable loss + Antenna Factor + AMP
- If Peak Result complies with AV limit, AV Result is deemed to comply with AV limit.
- Test setup: RBW: 1 MHz, VBW: 3 MHz, Sweep time: auto.

TR-4-E-009 Radiated Emission Test Result

Test Date: 2023-12-21 **Tested By:** Junchang Du
EUT: Bluetooth Wall Plate **Model Number:** BTWP2
Test Mode: DH5 TX 2480MHz **Power Supply:** DC 12V
Condition: Temp:23.7°C;Humi:50.8% **Test Site:** DDT 3# Chamber
File Path: d:\ts\2023 report data\Q23120624-2E BTWP2\FCC ABOVE 1G7
Memo: Sample Number:S23120624-03 Power Setting:2

Test Graph

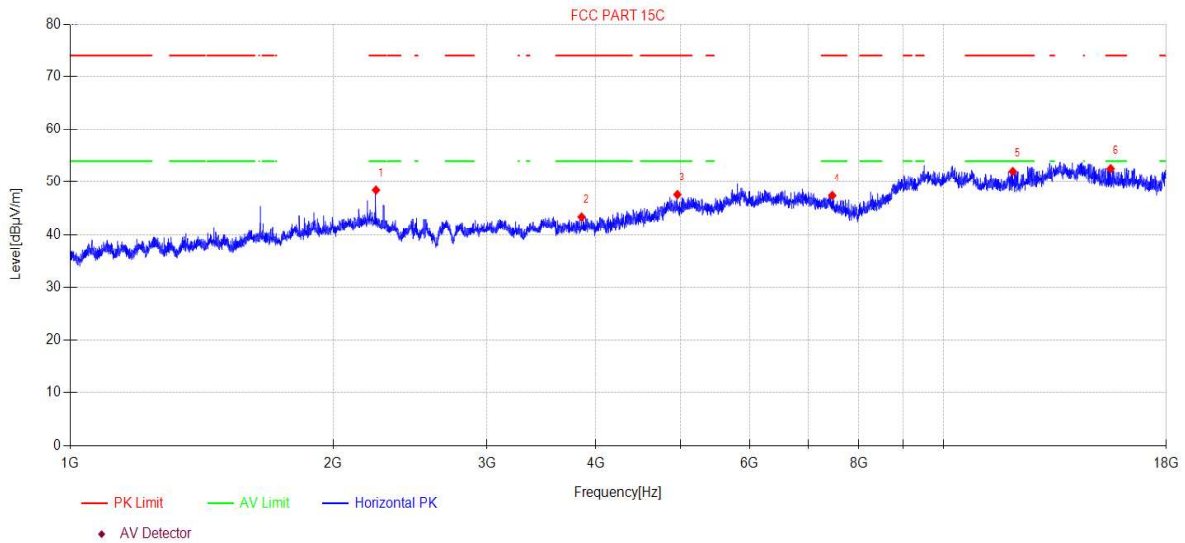

| Data List | | | | | | | | | | |
|-----------|-------------|------------------|---------------------|-----------------|----------|----------------|----------------|-------------|----------|------------|
| N O. | Freq. [MHz] | Reading [dBµV/m] | Antenna Factor [dB] | Cable loss [dB] | AMP [dB] | Level [dBµV/m] | Limit [dBµV/m] | Margin [dB] | Detector | Polarity |
| 1 | 2239.68 | 52.80 | 27.40 | 5.96 | -37.69 | 48.47 | 74.00 | 25.53 | PK | Horizontal |
| 2 | 3851.69 | 47.12 | 30.91 | 5.82 | -40.36 | 43.49 | 74.00 | 30.51 | PK | Horizontal |
| 3 | 4958.51 | 46.82 | 33.12 | 7.79 | -40.10 | 47.63 | 74.00 | 26.37 | PK | Horizontal |
| 4 | 7459.40 | 45.09 | 36.58 | 7.64 | -41.85 | 47.46 | 74.00 | 26.54 | PK | Horizontal |
| 5 | 12006.78 | 41.90 | 39.21 | 10.54 | -39.56 | 52.09 | 74.00 | 21.91 | PK | Horizontal |
| 6 | 15542.15 | 39.17 | 38.72 | 13.81 | -39.09 | 52.61 | 74.00 | 21.39 | PK | Horizontal |

Note:

1. Level = Reading + Cable loss + Antenna Factor + AMP
2. If Peak Result complies with AV limit, AV Result is deemed to comply with AV limit.
3. Test setup: RBW: 1 MHz, VBW: 3 MHz, Sweep time: auto.

TR-4-E-009 Radiated Emission Test Result

Test Date: 2023-12-21 **Tested By:** Junchang Du
EUT: Bluetooth Wall Plate **Model Number:** BTWP2
Test Mode: DH5 TX 2480MHz **Power Supply:** DC 12V
Condition: Temp:23.7°C;Humi:50.8% **Test Site:** DDT 3# Chamber
File Path: d:\ts\2023 report data\Q23120624-2E BTWP2\FCC ABOVE 1G8
Memo: Sample Number:S23120624-03 Power Setting:2

Test Graph

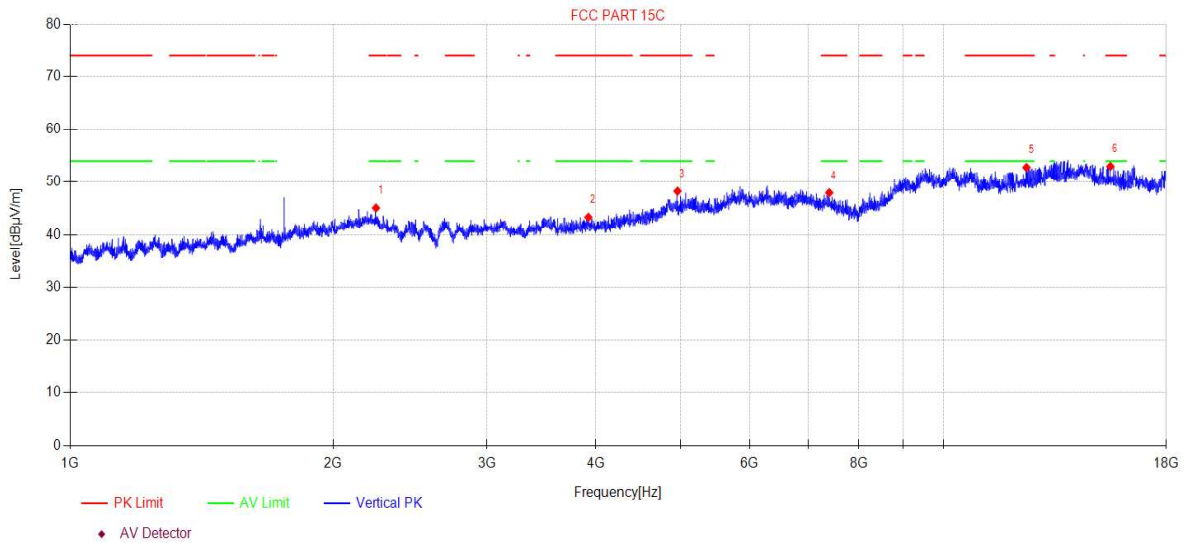

| Data List | | | | | | | | | | |
|-----------|-------------|------------------|---------------------|-----------------|----------|----------------|----------------|-------------|----------|----------|
| N O. | Freq. [MHz] | Reading [dBµV/m] | Antenna Factor [dB] | Cable loss [dB] | AMP [dB] | Level [dBµV/m] | Limit [dBµV/m] | Margin [dB] | Detector | Polarity |
| 1 | 2239.68 | 49.49 | 27.40 | 5.96 | -37.69 | 45.16 | 74.00 | 28.84 | PK | Vertical |
| 2 | 3921.33 | 46.84 | 31.16 | 5.83 | -40.40 | 43.43 | 74.00 | 30.57 | PK | Vertical |
| 3 | 4959.95 | 47.46 | 33.12 | 7.79 | -40.09 | 48.28 | 74.00 | 25.72 | PK | Vertical |
| 4 | 7401.42 | 45.34 | 36.70 | 7.64 | -41.70 | 47.98 | 74.00 | 26.02 | PK | Vertical |
| 5 | 12448.46 | 42.64 | 39.35 | 10.54 | -39.73 | 52.80 | 74.00 | 21.20 | PK | Vertical |
| 6 | 15533.17 | 39.60 | 38.73 | 13.77 | -39.08 | 53.02 | 74.00 | 20.98 | PK | Vertical |

Note:

1. Level = Reading + Cable loss + Antenna Factor + AMP
2. If Peak Result complies with AV limit, AV Result is deemed to comply with AV limit.
3. Test setup: RBW: 1 MHz, VBW: 3 MHz, Sweep time: auto.

13. Band Edge Compliance (Radiated Method)

13.1. Test equipment

| Equipment | Manufacturer | Model No. | Serial Number | Due Date |
|----------------------------|--------------|---|---------------|------------|
| ☒Radiation 3#Chamber | | | | |
| EMI TEST RECEIVER | R&S | ESU26 | 100472 | 2024/04/22 |
| Double Ridged Horn Antenna | Schwarzbeck | BBHA 9120 D | 02468 | 2024/09/17 |
| Pre-amplifier | COM-POWER | PAM-118A | 18040084 | 2024/07/14 |
| RF Cable | Yuhu | JCTB810-NJ-NJ-9M+ ZT26S-SMAJ-SMAJ-1M | 21123964 | 2024/04/22 |
| Test Software | Tonscend | JS32-RE | V 5.0.0.1 | N/A |

13.2. Block diagram of test setup

In 3 m Anechoic Chamber, test setup diagram for frequency above 1 GHz:

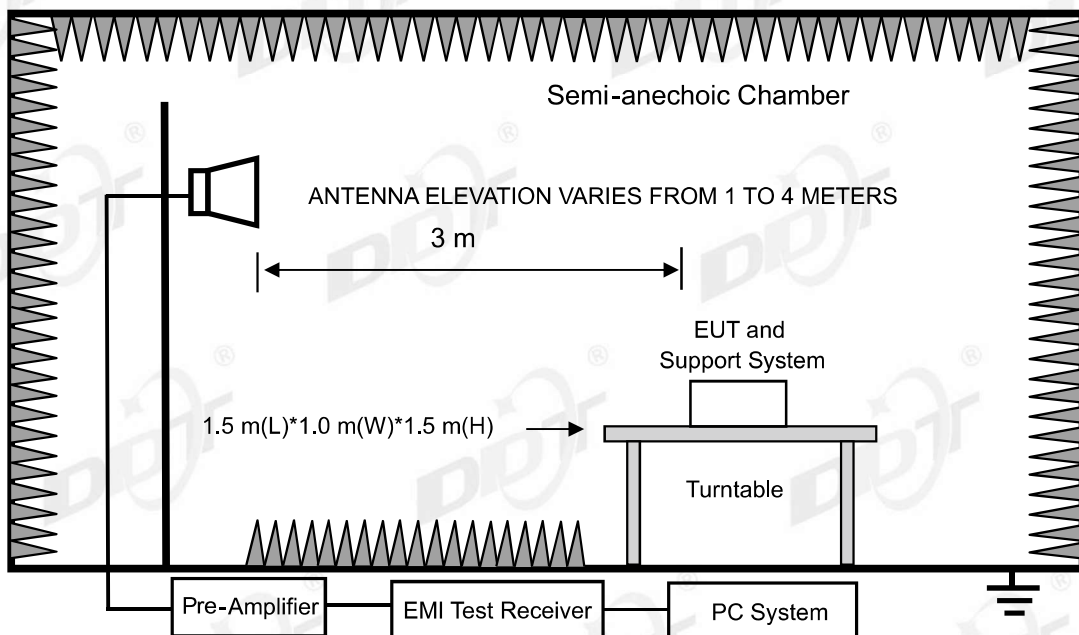

13.3. Limit

All restriction band should comply with 15.209 and RSS-Gen section 8.9 limits, other emission should be at least 20 dB below the fundamental.

13.4. Test procedure

Same with Radiated Emission except change investigated frequency range.

Remark: All restriction band have been tested, and only the worst case is shown in report.

13.5. Test result

Pass. (See below detailed test result)

Remark: hopping on and hopping off mode all have been test, hopping off mode is worse and reported only. Scan with all mode, the worst case is recorded in this report.

TR-4-E-009 Radiated Emission Test Result

Test Date: 2023-12-21 **Tested By:** Junchang Du
EUT: Bluetooth Wall Plate **Model Number:** BTWP2
Test Mode: DH5 TX 2402MHz **Power Supply:** DC 12V
Condition: Temp:23.7°C;Humi:50.8% **Test Site:** DDT 3# Chamber
File Path: d:\ts\2023 report data\Q23120624-2E BTWP2\FCC ABOVE 1G\11
Memo: Sample Number:S23120624-03 Power Setting:2

Test Graph

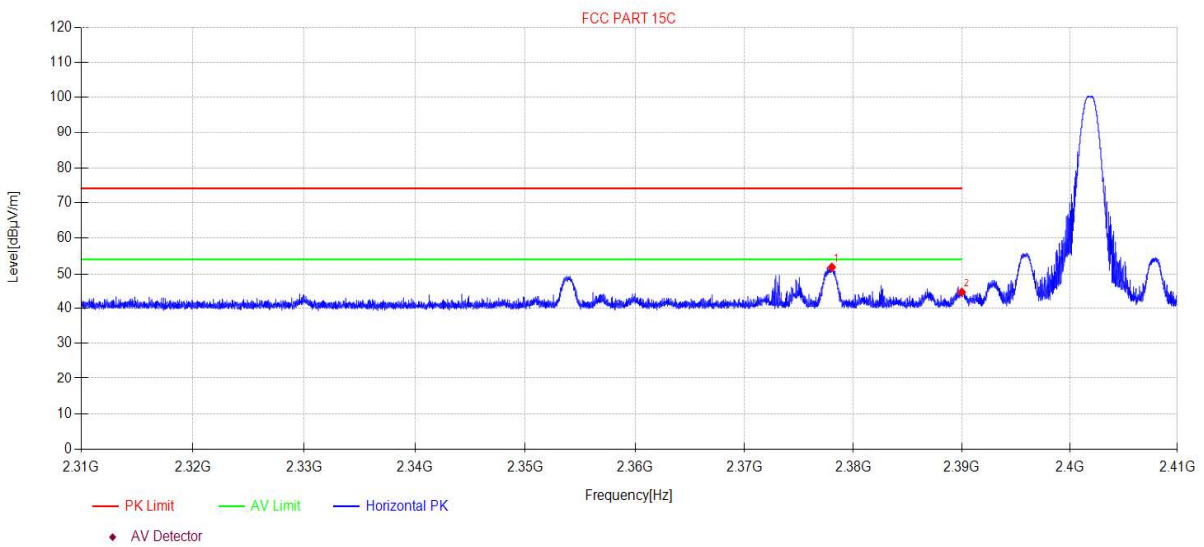

| Data List | | | | | | | | | | |
|-----------|-------------|------------------|---------------------|-----------------|----------|----------------|----------------|-------------|----------|------------|
| N O. | Freq. [MHz] | Reading [dBµV/m] | Antenna Factor [dB] | Cable loss [dB] | AMP [dB] | Level [dBµV/m] | Limit [dBµV/m] | Margin [dB] | Detector | Polarity |
| 1 | 2378.02 | 58.86 | 27.21 | 3.86 | -38.08 | 51.85 | 74.00 | 22.15 | PK | Horizontal |
| 2 | 2390.00 | 51.55 | 27.26 | 3.87 | -38.11 | 44.57 | 74.00 | 29.43 | PK | Horizontal |

Note:

1. Level = Reading + Cable loss + Antenna Factor + AMP
2. If Peak Result complies with AV limit, AV Result is deemed to comply with AV limit.
3. Test setup: RBW: 1 MHz, VBW: 3 MHz, Sweep time: auto.

TR-4-E-009 Radiated Emission Test Result

Test Date: 2023-12-21 **Tested By:** Junchang Du
EUT: Bluetooth Wall Plate **Model Number:** BTWP2
Test Mode: DH5 TX 2402MHz **Power Supply:** DC 12V
Condition: Temp:23.7°C;Humi:50.8% **Test Site:** DDT 3# Chamber
File Path: d:\ts\2023 report data\Q23120624-2E BTWP2\FCC ABOVE 1G\12
Memo: Sample Number:S23120624-03 Power Setting:2

Test Graph

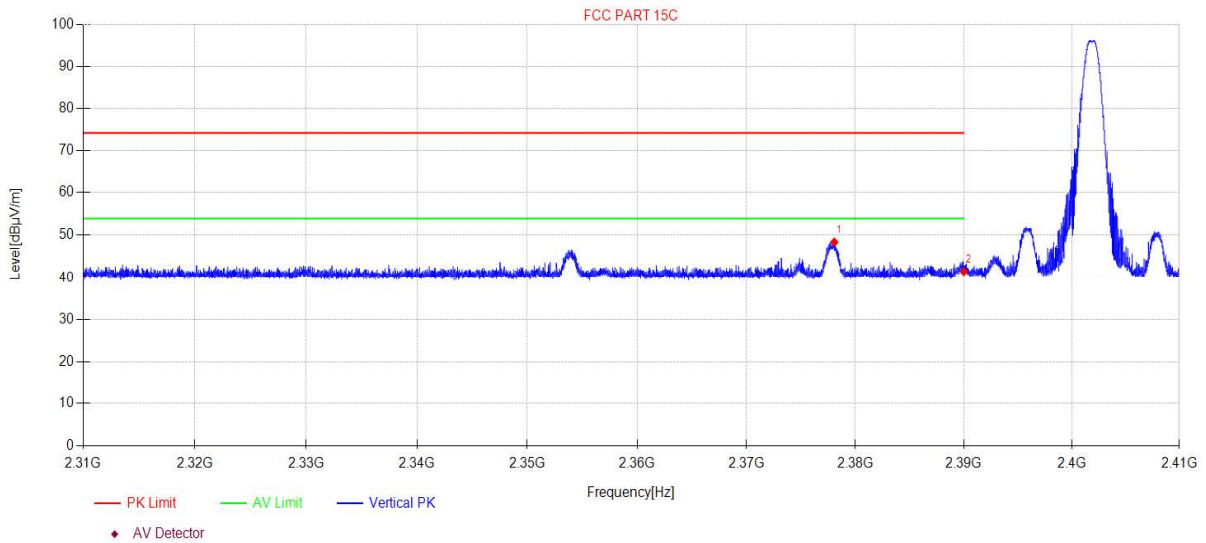

| Data List | | | | | | | | | | |
|-----------|-------------|------------------|---------------------|-----------------|----------|----------------|----------------|-------------|----------|----------|
| N O. | Freq. [MHz] | Reading [dBµV/m] | Antenna Factor [dB] | Cable loss [dB] | AMP [dB] | Level [dBµV/m] | Limit [dBµV/m] | Margin [dB] | Detector | Polarity |
| 1 | 2378.06 | 55.33 | 27.21 | 3.86 | -38.08 | 48.32 | 74.00 | 25.68 | PK | Vertical |
| 2 | 2390.00 | 48.47 | 27.26 | 3.87 | -38.11 | 41.49 | 74.00 | 32.51 | PK | Vertical |

Note:

1. Level = Reading + Cable loss + Antenna Factor + AMP
2. If Peak Result complies with AV limit, AV Result is deemed to comply with AV limit.
3. Test setup: RBW: 1 MHz, VBW: 3 MHz, Sweep time: auto.

TR-4-E-009 Radiated Emission Test Result

Test Date: 2023-12-21 **Tested By:** Junchang Du
EUT: Bluetooth Wall Plate **Model Number:** BTWP2
Test Mode: 2DH5 TX 2402MHz **Power Supply:** DC 12V
Condition: Temp:23.7°C;Humi:50.8% **Test Site:** DDT 3# Chamber
File Path: d:\ts\2023 report data\Q23120624-2E BTWP2\FCC ABOVE 1G\13
Memo: Sample Number:S23120624-03 Power Setting:2

Test Graph

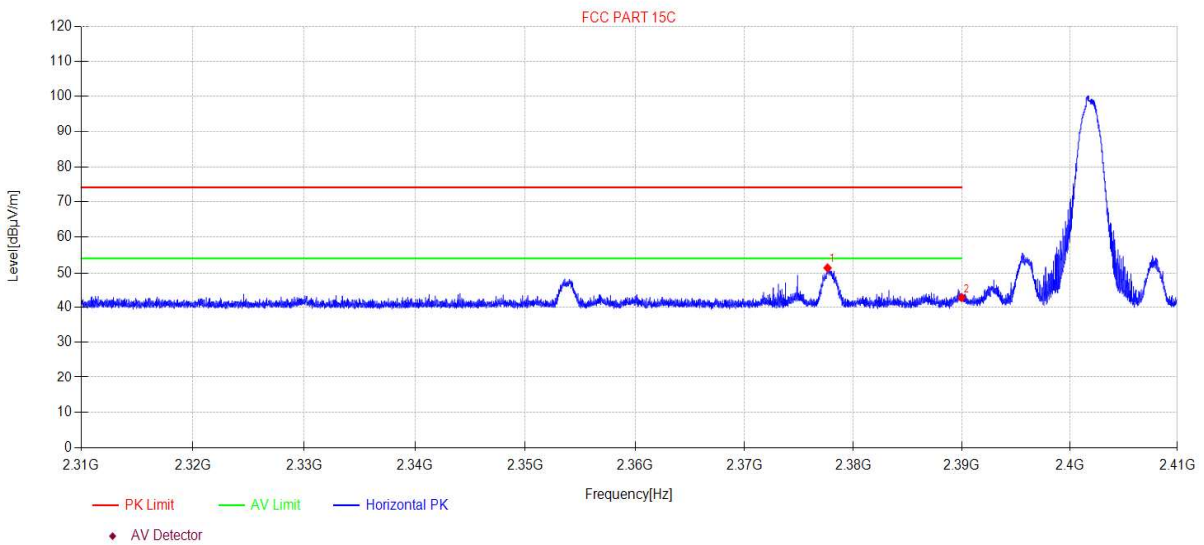

| Data List | | | | | | | | | | |
|-----------|-------------|------------------|---------------------|-----------------|----------|----------------|----------------|-------------|----------|------------|
| N O. | Freq. [MHz] | Reading [dBµV/m] | Antenna Factor [dB] | Cable loss [dB] | AMP [dB] | Level [dBµV/m] | Limit [dBµV/m] | Margin [dB] | Detector | Polarity |
| 1 | 2377.63 | 58.38 | 27.21 | 3.86 | -38.08 | 51.37 | 74.00 | 22.63 | PK | Horizontal |
| 2 | 2390.00 | 49.73 | 27.26 | 3.87 | -38.11 | 42.75 | 74.00 | 31.25 | PK | Horizontal |

Note:

1. Level = Reading + Cable loss + Antenna Factor + AMP
2. If Peak Result complies with AV limit, AV Result is deemed to comply with AV limit.
3. Test setup: RBW: 1 MHz, VBW: 3 MHz, Sweep time: auto.

TR-4-E-009 Radiated Emission Test Result

Test Date: 2023-12-21 **Tested By:** Junchang Du
EUT: Bluetooth Wall Plate **Model Number:** BTWP2
Test Mode: 2DH5 TX 2402MHz **Power Supply:** DC 12V
Condition: Temp:23.7°C;Humi:50.8% **Test Site:** DDT 3# Chamber
File Path: d:\ts\2023 report data\Q23120624-2E BTWP2\FCC ABOVE 1G\14
Memo: Sample Number:S23120624-03 Power Setting:2

Test Graph

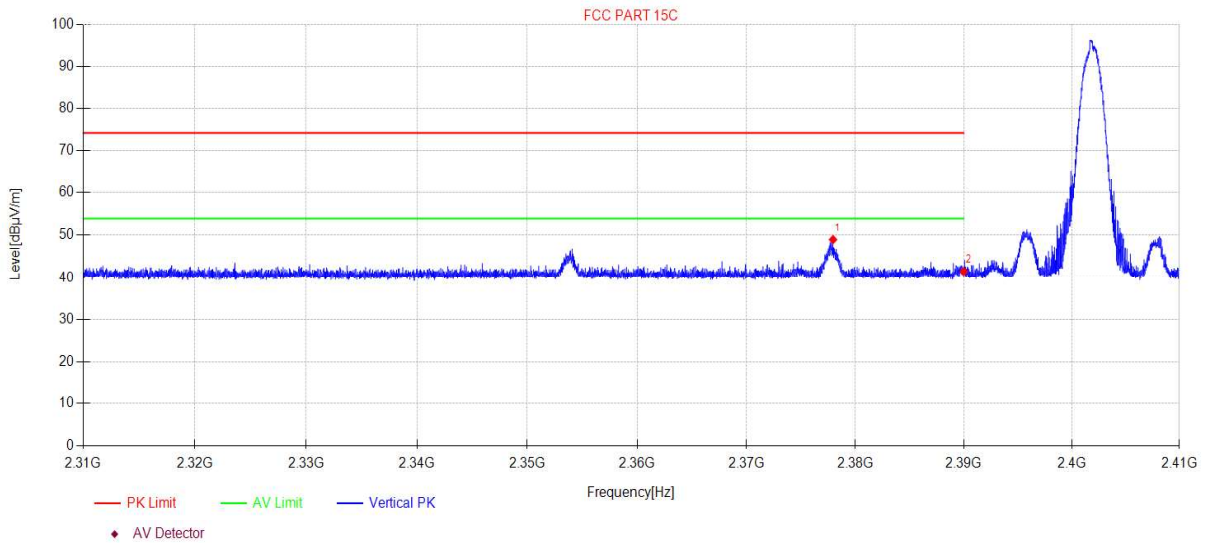

| Data List | | | | | | | | | | |
|-----------|-------------|------------------|---------------------|-----------------|----------|----------------|----------------|-------------|----------|----------|
| N O. | Freq. [MHz] | Reading [dBµV/m] | Antenna Factor [dB] | Cable loss [dB] | AMP [dB] | Level [dBµV/m] | Limit [dBµV/m] | Margin [dB] | Detector | Polarity |
| 1 | 2377.95 | 55.91 | 27.21 | 3.86 | -38.08 | 48.90 | 74.00 | 25.10 | PK | Vertical |
| 2 | 2390.00 | 48.48 | 27.26 | 3.87 | -38.11 | 41.50 | 74.00 | 32.50 | PK | Vertical |

Note:

1. Level = Reading + Cable loss + Antenna Factor + AMP
2. If Peak Result complies with AV limit, AV Result is deemed to comply with AV limit.
3. Test setup: RBW: 1 MHz, VBW: 3 MHz, Sweep time: auto.

TR-4-E-009 Radiated Emission Test Result

Test Date: 2023-12-21 **Tested By:** Junchang Du
EUT: Bluetooth Wall Plate **Model Number:** BTWP2
Test Mode: 3DH5 TX 2402MHz **Power Supply:** DC 12V
Condition: Temp:23.7°C;Humi:50.8% **Test Site:** DDT 3# Chamber
File Path: d:\ts\2023 report data\Q23120624-2E BTWP2\FCC ABOVE 1G\15
Memo: Sample Number:S23120624-03 Power Setting:2

Test Graph

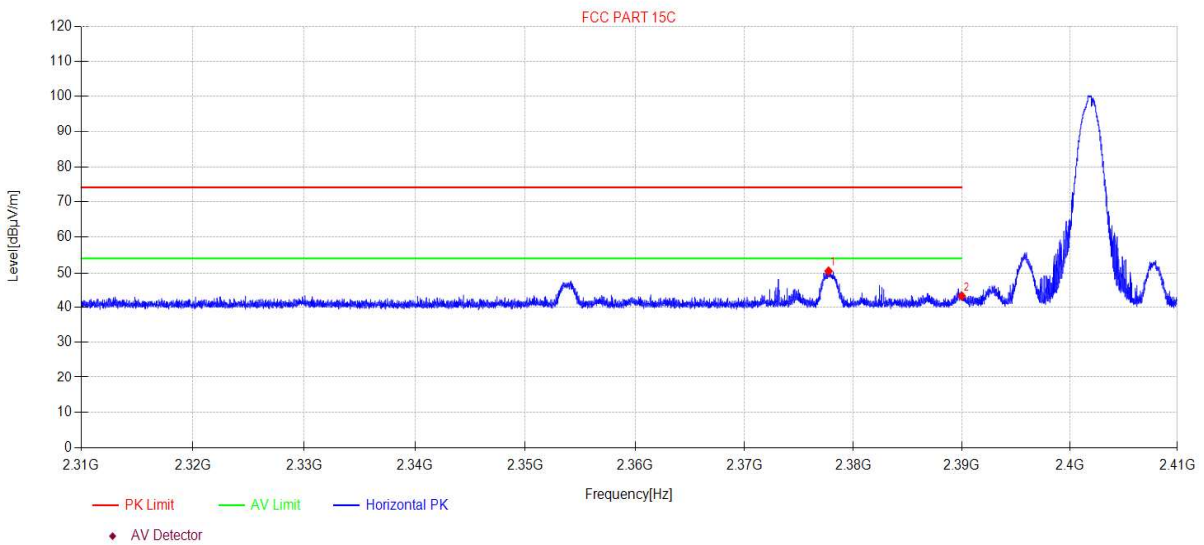

| Data List | | | | | | | | | | |
|-----------|-------------|------------------|---------------------|-----------------|----------|----------------|----------------|-------------|----------|------------|
| N O. | Freq. [MHz] | Reading [dBµV/m] | Antenna Factor [dB] | Cable loss [dB] | AMP [dB] | Level [dBµV/m] | Limit [dBµV/m] | Margin [dB] | Detector | Polarity |
| 1 | 2377.72 | 57.52 | 27.21 | 3.86 | -38.08 | 50.51 | 74.00 | 23.49 | PK | Horizontal |
| 2 | 2390.00 | 50.19 | 27.26 | 3.87 | -38.11 | 43.21 | 74.00 | 30.79 | PK | Horizontal |

Note:

1. Level = Reading + Cable loss + Antenna Factor + AMP
2. If Peak Result complies with AV limit, AV Result is deemed to comply with AV limit.
3. Test setup: RBW: 1 MHz, VBW: 3 MHz, Sweep time: auto.

TR-4-E-009 Radiated Emission Test Result

Test Date: 2023-12-21 **Tested By:** Junchang Du
EUT: Bluetooth Wall Plate **Model Number:** BTWP2
Test Mode: 3DH5 TX 2402MHz **Power Supply:** DC 12V
Condition: Temp:23.7°C;Humi:50.8% **Test Site:** DDT 3# Chamber
File Path: d:\ts\2023 report data\Q23120624-2E BTWP2\FCC ABOVE 1G\16
Memo: Sample Number:S23120624-03 Power Setting:2

Test Graph

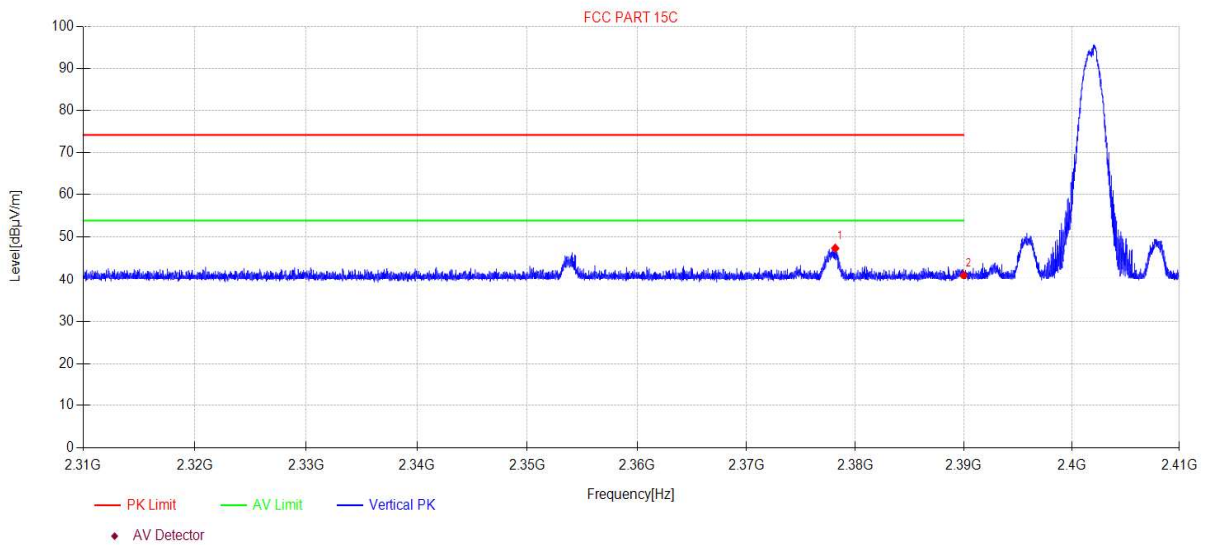

| Data List | | | | | | | | | | |
|-----------|-------------|------------------|---------------------|-----------------|----------|----------------|----------------|-------------|----------|----------|
| N O. | Freq. [MHz] | Reading [dBµV/m] | Antenna Factor [dB] | Cable loss [dB] | AMP [dB] | Level [dBµV/m] | Limit [dBµV/m] | Margin [dB] | Detector | Polarity |
| 1 | 2378.15 | 54.37 | 27.21 | 3.86 | -38.08 | 47.36 | 74.00 | 26.64 | PK | Vertical |
| 2 | 2390.00 | 48.04 | 27.26 | 3.87 | -38.11 | 41.06 | 74.00 | 32.94 | PK | Vertical |

Note:

1. Level = Reading + Cable loss + Antenna Factor + AMP
2. If Peak Result complies with AV limit, AV Result is deemed to comply with AV limit.
3. Test setup: RBW: 1 MHz, VBW: 3 MHz, Sweep time: auto.

TR-4-E-009 Radiated Emission Test Result

Test Date: 2023-12-21 **Tested By:** Junchang Du
EUT: Bluetooth Wall Plate **Model Number:** BTWP2
Test Mode: DH5 TX 2480MHz **Power Supply:** DC 12V
Condition: Temp:23.7°C;Humi:50.8% **Test Site:** DDT 3# Chamber
File Path: d:\ts\2023 report data\Q23120624-2E BTWP2\FCC ABOVE 1G\17
Memo: Sample Number:S23120624-03 Power Setting:2

Test Graph

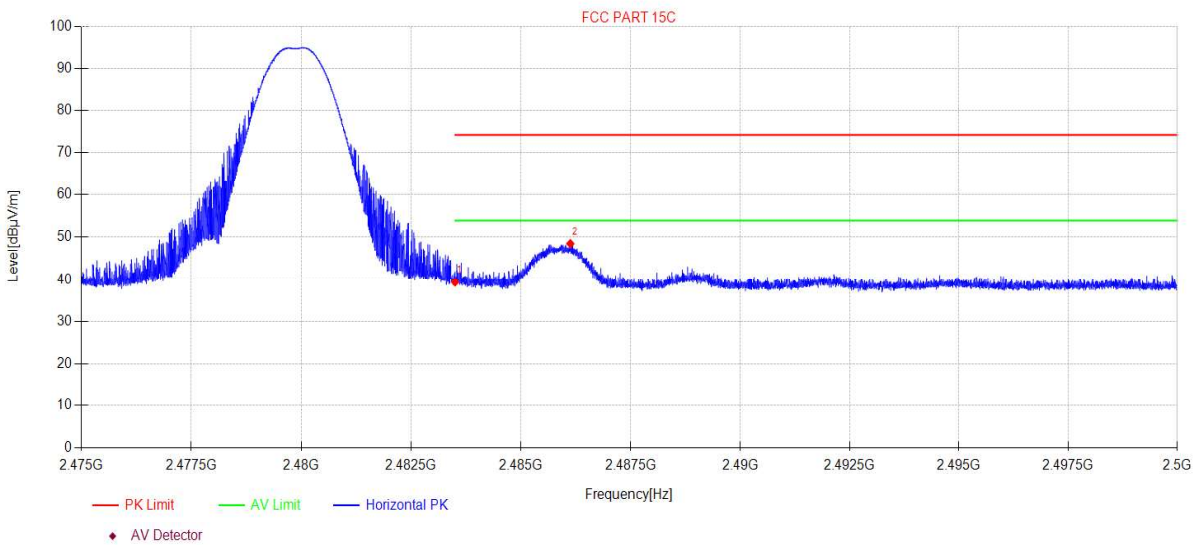

| Data List | | | | | | | | | | |
|-----------|-------------|------------------|---------------------|-----------------|----------|----------------|----------------|-------------|----------|------------|
| N O. | Freq. [MHz] | Reading [dBµV/m] | Antenna Factor [dB] | Cable loss [dB] | AMP [dB] | Level [dBµV/m] | Limit [dBµV/m] | Margin [dB] | Detector | Polarity |
| 1 | 2483.50 | 46.24 | 27.53 | 3.94 | -38.38 | 39.33 | 74.00 | 34.67 | PK | Horizontal |
| 2 | 2486.13 | 55.33 | 27.54 | 3.94 | -38.39 | 48.42 | 74.00 | 25.58 | PK | Horizontal |

Note:

1. Level = Reading + Cable loss + Antenna Factor + AMP
2. If Peak Result complies with AV limit, AV Result is deemed to comply with AV limit.
3. Test setup: RBW: 1 MHz, VBW: 3 MHz, Sweep time: auto.

TR-4-E-009 Radiated Emission Test Result

Test Date: 2023-12-21 **Tested By:** Junchang Du
EUT: Bluetooth Wall Plate **Model Number:** BTWP2
Test Mode: DH5 TX 2480MHz **Power Supply:** DC 12V
Condition: Temp:23.7°C;Humi:50.8% **Test Site:** DDT 3# Chamber
File Path: d:\ts\2023 report data\Q23120624-2E BTWP2\FCC ABOVE 1G\18
Memo: Sample Number:S23120624-03 Power Setting:2

Test Graph

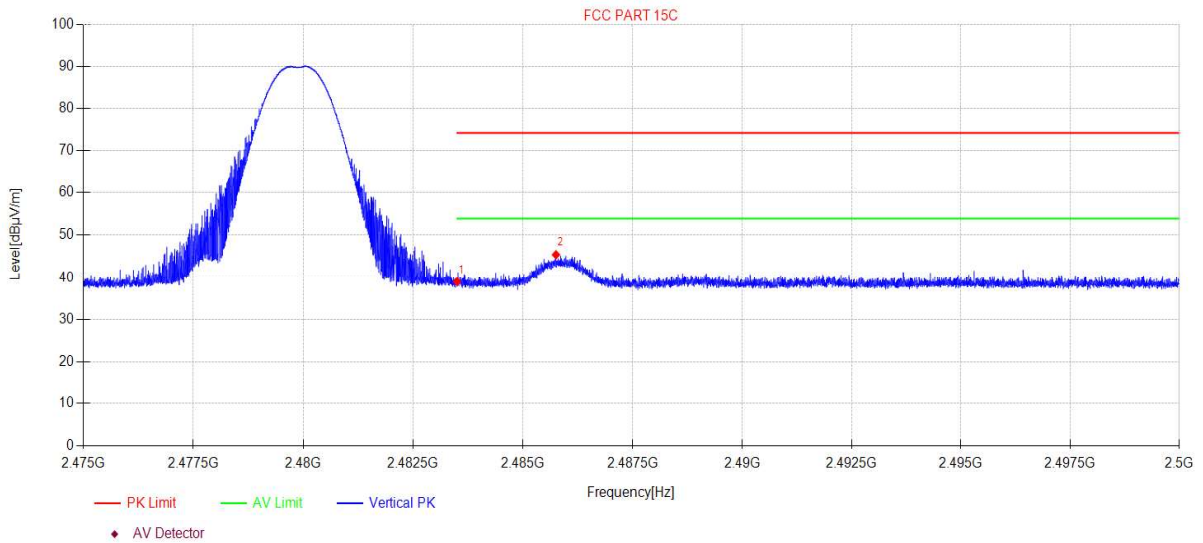

| Data List | | | | | | | | | | |
|-----------|-------------|------------------|---------------------|-----------------|----------|----------------|----------------|-------------|----------|----------|
| N O. | Freq. [MHz] | Reading [dBµV/m] | Antenna Factor [dB] | Cable loss [dB] | AMP [dB] | Level [dBµV/m] | Limit [dBµV/m] | Margin [dB] | Detector | Polarity |
| 1 | 2483.50 | 45.87 | 27.53 | 3.94 | -38.38 | 38.96 | 74.00 | 35.04 | PK | Vertical |
| 2 | 2485.75 | 52.29 | 27.54 | 3.94 | -38.38 | 45.39 | 74.00 | 28.61 | PK | Vertical |

Note:

1. Level = Reading + Cable loss + Antenna Factor + AMP
2. If Peak Result complies with AV limit, AV Result is deemed to comply with AV limit.
3. Test setup: RBW: 1 MHz, VBW: 3 MHz, Sweep time: auto.

TR-4-E-009 Radiated Emission Test Result

Test Date: 2023-12-21 **Tested By:** Junchang Du
EUT: Bluetooth Wall Plate **Model Number:** BTWP2
Test Mode: 2DH5 TX 2402MHz **Power Supply:** DC 12V
Condition: Temp:23.7°C;Humi:50.8% **Test Site:** DDT 3# Chamber
File Path: d:\ts\2023 report data\Q23120624-2E BTWP2\FCC ABOVE 1G\19
Memo: Sample Number:S23120624-03 Power Setting:2

Test Graph

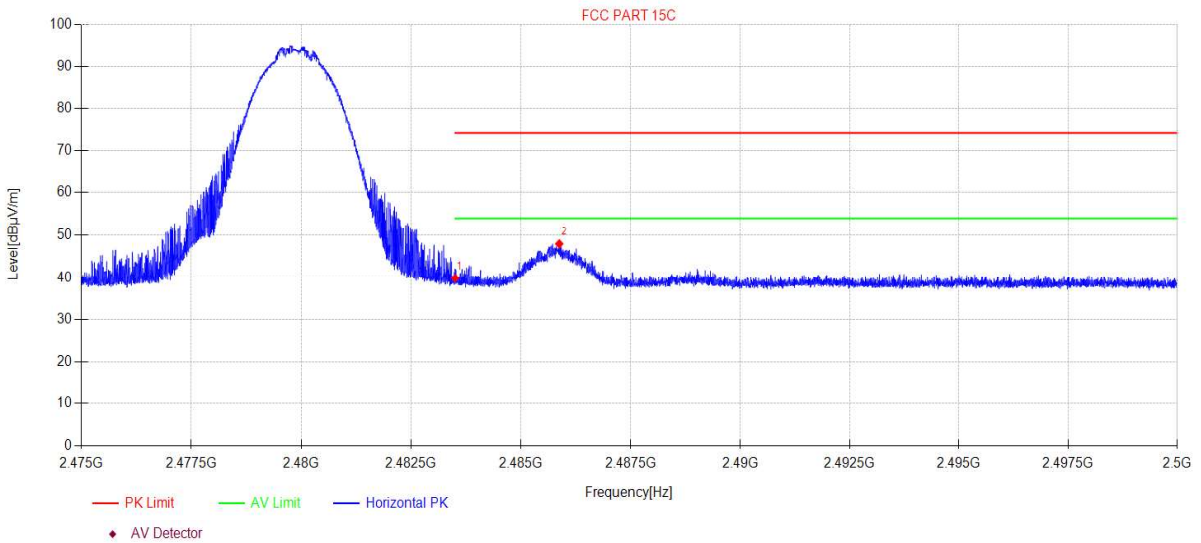

| Data List | | | | | | | | | | |
|-----------|-------------|------------------|---------------------|-----------------|----------|----------------|----------------|-------------|----------|------------|
| N O. | Freq. [MHz] | Reading [dBµV/m] | Antenna Factor [dB] | Cable loss [dB] | AMP [dB] | Level [dBµV/m] | Limit [dBµV/m] | Margin [dB] | Detector | Polarity |
| 1 | 2483.50 | 46.78 | 27.53 | 3.94 | -38.38 | 39.87 | 74.00 | 34.13 | PK | Horizontal |
| 2 | 2485.87 | 54.83 | 27.54 | 3.94 | -38.39 | 47.92 | 74.00 | 26.08 | PK | Horizontal |

Note:

1. Level = Reading + Cable loss + Antenna Factor + AMP
2. If Peak Result complies with AV limit, AV Result is deemed to comply with AV limit.
3. Test setup: RBW: 1 MHz, VBW: 3 MHz, Sweep time: auto.

TR-4-E-009 Radiated Emission Test Result

Test Date: 2023-12-21 **Tested By:** Junchang Du
EUT: Bluetooth Wall Plate **Model Number:** BTWP2
Test Mode: 2DH5 TX 2480MHz **Power Supply:** DC 12V
Condition: Temp:23.7°C;Humi:50.8% **Test Site:** DDT 3# Chamber
File Path: d:\ts\2023 report data\Q23120624-2E BTWP2\FCC ABOVE 1G\20
Memo: Sample Number:S23120624-03 Power Setting:2

Test Graph

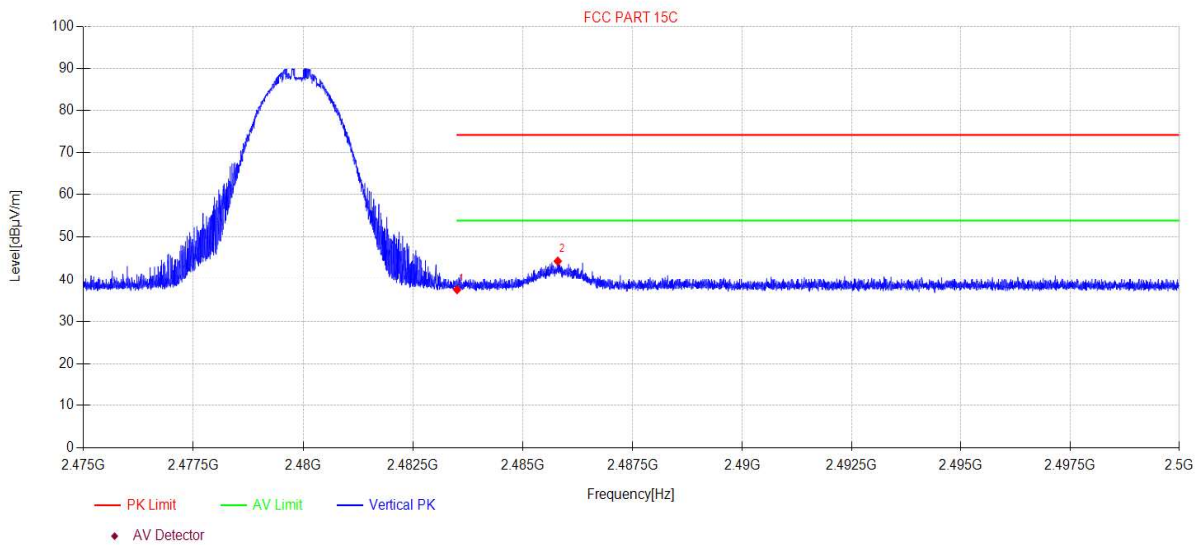

| Data List | | | | | | | | | | |
|-----------|-------------|------------------|---------------------|-----------------|----------|----------------|----------------|-------------|----------|----------|
| N O. | Freq. [MHz] | Reading [dBµV/m] | Antenna Factor [dB] | Cable loss [dB] | AMP [dB] | Level [dBµV/m] | Limit [dBµV/m] | Margin [dB] | Detector | Polarity |
| 1 | 2483.50 | 44.40 | 27.53 | 3.94 | -38.38 | 37.49 | 74.00 | 36.51 | PK | Vertical |
| 2 | 2485.79 | 51.27 | 27.54 | 3.94 | -38.38 | 44.37 | 74.00 | 29.63 | PK | Vertical |

Note:

1. Level = Reading + Cable loss + Antenna Factor + AMP
2. If Peak Result complies with AV limit, AV Result is deemed to comply with AV limit.
3. Test setup: RBW: 1 MHz, VBW: 3 MHz, Sweep time: auto.

TR-4-E-009 Radiated Emission Test Result

Test Date: 2023-12-21 **Tested By:** Junchang Du
EUT: Bluetooth Wall Plate **Model Number:** BTWP2
Test Mode: 3DH5 TX 2480MHz **Power Supply:** DC 12V
Condition: Temp:23.7°C;Humi:50.8% **Test Site:** DDT 3# Chamber
File Path: d:\ts\2023 report data\Q23120624-2E BTWP2\FCC ABOVE 1G\21
Memo: Sample Number:S23120624-03 Power Setting:2

Test Graph

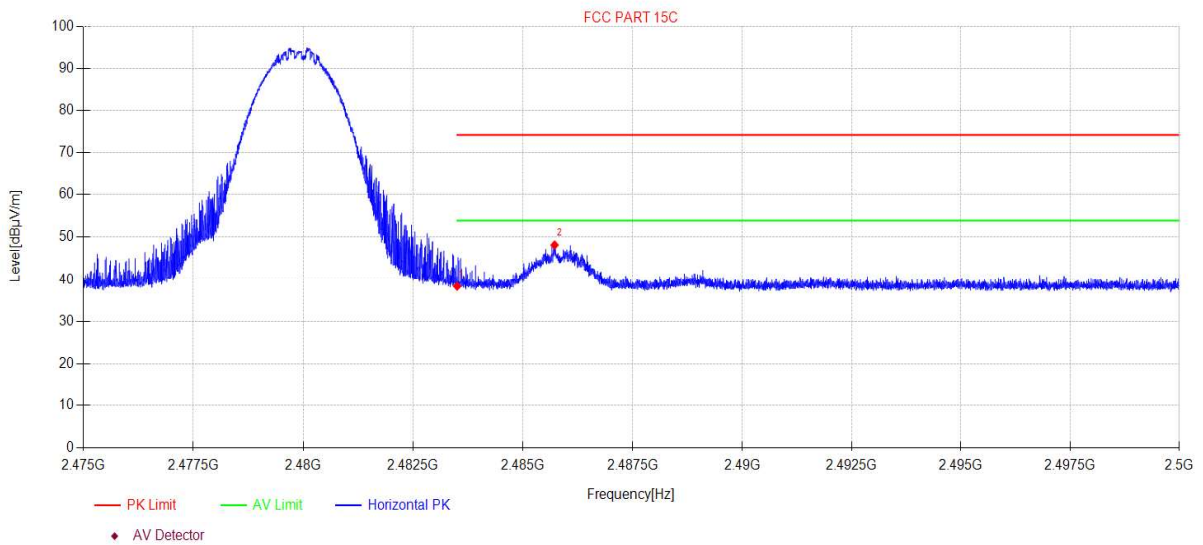

| Data List | | | | | | | | | | |
|-----------|-------------|------------------|---------------------|-----------------|----------|----------------|----------------|-------------|----------|------------|
| N O. | Freq. [MHz] | Reading [dBµV/m] | Antenna Factor [dB] | Cable loss [dB] | AMP [dB] | Level [dBµV/m] | Limit [dBµV/m] | Margin [dB] | Detector | Polarity |
| 1 | 2483.50 | 45.25 | 27.53 | 3.94 | -38.38 | 38.34 | 74.00 | 35.66 | PK | Horizontal |
| 2 | 2485.72 | 55.00 | 27.54 | 3.94 | -38.38 | 48.10 | 74.00 | 25.90 | PK | Horizontal |

Note:

1. Level = Reading + Cable loss + Antenna Factor + AMP
2. If Peak Result complies with AV limit, AV Result is deemed to comply with AV limit.
3. Test setup: RBW: 1 MHz, VBW: 3 MHz, Sweep time: auto.

TR-4-E-009 Radiated Emission Test Result

Test Date: 2023-12-21 **Tested By:** Junchang Du
EUT: Bluetooth Wall Plate **Model Number:** BTWP2
Test Mode: 3DH5 TX 2480MHz **Power Supply:** DC 12V
Condition: Temp:23.7°C;Humi:50.8% **Test Site:** DDT 3# Chamber
File Path: d:\ts\2023 report data\Q23120624-2E BTWP2\FCC ABOVE 1G\22
Memo: Sample Number:S23120624-03 Power Setting:2

Test Graph

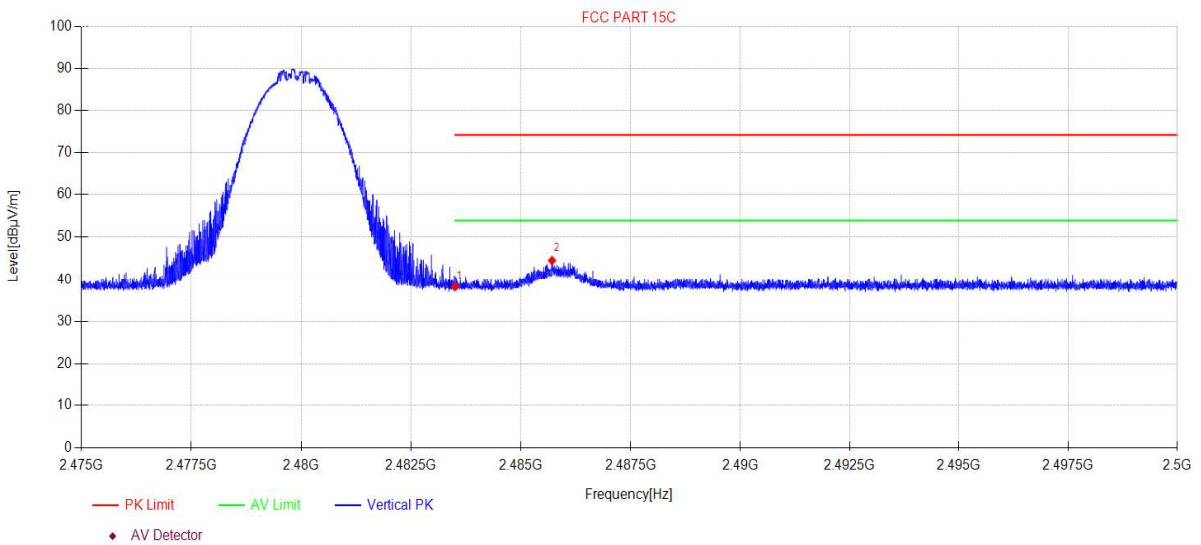

| Data List | | | | | | | | | | |
|-----------|-------------|------------------|---------------------|-----------------|----------|----------------|----------------|-------------|----------|----------|
| N O. | Freq. [MHz] | Reading [dBµV/m] | Antenna Factor [dB] | Cable loss [dB] | AMP [dB] | Level [dBµV/m] | Limit [dBµV/m] | Margin [dB] | Detector | Polarity |
| 1 | 2483.50 | 45.10 | 27.53 | 3.94 | -38.38 | 38.19 | 74.00 | 35.81 | PK | Vertical |
| 2 | 2485.71 | 51.43 | 27.54 | 3.94 | -38.38 | 44.53 | 74.00 | 29.47 | PK | Vertical |

Note:

1. Level = Reading + Cable loss + Antenna Factor + AMP
2. If Peak Result complies with AV limit, AV Result is deemed to comply with AV limit.
3. Test setup: RBW: 1 MHz, VBW: 3 MHz, Sweep time: auto.

14. Power Line Conducted Emission

14.1. Test equipment

| Equipment | Manufacturer | Model No. | Serial Number | Due Date |
|--|--------------|-----------|---------------|------------|
| □ Power Line Conducted Emissions Test 1# | | | | |
| Test Receiver | R&S | ESCI | 100551 | 2024/07/10 |
| LISN 1 | R&S | ENV216 | 101109 | 2024/07/10 |
| LISN 2 | R&S | ESH2-Z5 | 100309 | 2024/07/11 |
| Pulse Limiter | R&S | ESH3-Z2 | 101242 | 2024/07/14 |
| CE Cable 1 | HUBSER | N/A | W10.01 | 2024/07/14 |
| Test software | Audix | E3 | V 6.11111b | N/A |

14.2. Block diagram of test setup

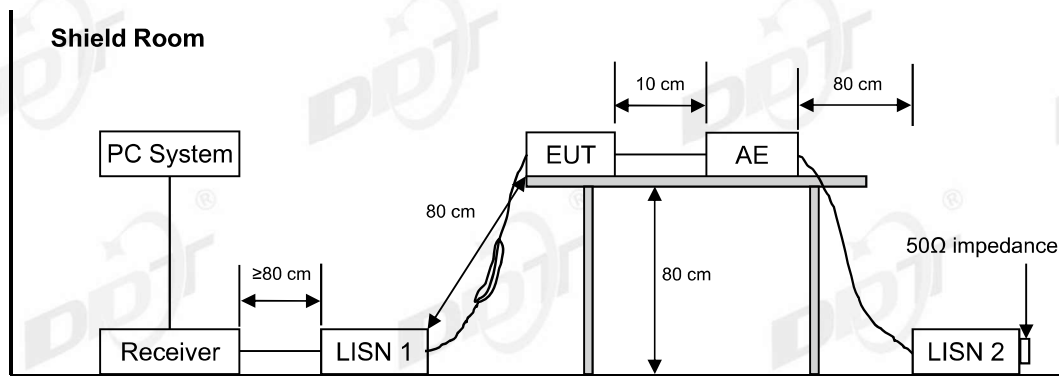

14.3. Power line conducted emission limits

| Frequency | Quasi-Peak Level dB(μV) | Average Level dB(μV) |
|-------------------|----------------------------|-------------------------|
| 150 kHz ~ 500 kHz | 66 ~ 56* | 56 ~ 46* |
| 500 kHz ~ 5 MHz | 56 | 46 |
| 5 MHz ~ 30 MHz | 60 | 50 |

Note 1: * Decreasing linearly with logarithm of frequency.

Note 2: The lower limit shall apply at the transition frequencies.

14.4. Test procedure

The EUT and Support equipment, if needed, were put placed on a non-metallic table, 80cm above the ground plane.

All support equipment power received from a second LISN.

Emissions were measured on each current carrying line of the EUT using an EMI Test Receiver connected to the LISN powering the EUT.

The Receiver scanned from 150 kHz to 30 MHz for emissions in each of the test modes.

During the above scans, the emissions were maximized by cable manipulation.

The test mode(s) described in clause 2.4 were scanned during the preliminary test.

After the preliminary scan, we found the test mode producing the highest emission level.

The EUT configuration and worse cable configuration of the above highest emission levels were recorded for reference of the final test.

EUT and support equipment were set up on the test bench as per the configuration with highest emission level in the preliminary test.

A scan was taken on both power lines, Neutral and Line, recording at least the six highest emissions.

Emission frequency and amplitude were recorded into a computer in which correction factors were used to calculate the emission level and compare reading to the applicable limit.

The test data of the worst-case condition(s) was recorded.

The bandwidth of test receiver is set at 9 kHz.

14.5. Test result

N/A

Measurements to demonstrate compliance with the conducted limits are not required for devices which only employ Battery power for operation and which do not operate from the AC power lines or contain provisions for operation while connected to the AC power lines.

15. Antenna Requirements

15.1. Limit

For intentional device, according to FCC 47 CFR Section 15.203, an intentional radiator shall be designed to ensure that no antenna other than that furnished by the responsible party shall be used with the device. And according to FCC 47 CFR Section 15.247 (b), if transmitting antennas of directional gain greater than 6 dBi are used, the power shall be reduced by the amount in dB that the directional gain of the antenna exceeds 6 dBi.

For intentional device, according to RSS-Gen issue 5 section 6.8.

The applicant for equipment certification shall provide a list of all antenna types that may be used with the transmitter, where applicable (i.e. for transmitters with detachable antenna), indicating the maximum permissible antenna gain (in dBi) and the required impedance for each antenna. The test report shall demonstrate the compliance of the transmitter with the limit for maximum equivalent isotropically radiated power (e.i.r.p.) specified in the applicable RSS, when the transmitter is equipped with any antenna type, selected from this list.

15.2. Result

The antenna used for this product as Antenna information described in section 2.1 of the report, and there is no other antenna than that furnished by the responsible party shall be used with the device.

17. Photos of the EUT

Please refer to appendix I: DDT-Q24042610-1E

END OF REPORT