

FCC Radio Test Report

FCC ID: XMR202112EC200AAU

This report concerns: Original Grant

Project No. : 2110H020
Equipment : LTE Module
Brand Name : Quectel
Test Model : EC200A-AU
Series Model : N/A
Applicant : Quectel Wireless Solutions Co., Ltd
Address : Building 5, Shanghai Business Park Phase III (Area B), No.1016 Tianlin Road, Minhang District, Shanghai, China 200233.
Manufacturer : Quectel Wireless Solutions Co., Ltd
Address : Building 5, Shanghai Business Park Phase III (Area B), No.1016 Tianlin Road, Minhang District, Shanghai, China 200233.
Date of Receipt : Nov. 15, 2021
Date of Test : Nov. 16, 2021 ~ Dec. 06, 2021
Issued Date : Dec. 09, 2021
Report Version : R00
Test Sample : Engineering Sample No.: SH20211115155 for EUT, SH20211115153-3 for adapter.
Standard(s) : 47 CFR FCC Part 24 Subpart E
ANSI/TIA/EIA-603-E-2016
FCC KDB 971168 D01 Power Meas License Digital Systems v03r01

The above equipment has been tested and found compliance with the requirement of the relative standards by BTL Inc.

Maker Qi

Prepared by : Maker Qi

Ryan Wang

Approved by : Ryan Wang



TESTING CERT #5123.03

Add: No. 29, Jintang Road, Tangzhen Industry Park, Pudong New Area, Shanghai 201210, China

TEL: +86-021-61765666

Web: www.newbtl.com

Declaration

BTL represents to the client that testing is done in accordance with standard procedures as applicable and that test instruments used has been calibrated with standards traceable to international standard(s) and/or national standard(s).

BTL's reports apply only to the specific samples tested under conditions. It is manufacture's responsibility to ensure that additional production units of this model are manufactured with the identical electrical and mechanical components. **BTL** shall have no liability for any declarations, inferences or generalizations drawn by the client or others from **BTL** issued reports.

The report must not be used by the client to claim product certification, approval, or endorsement by NIST, A2LA, or any agency of the U.S. Government.

This report is the confidential property of the client. As a mutual protection to the clients, the public and ourselves, the test report shall not be reproduced, except in full, without our written approval.

BTL's laboratory quality assurance procedures are in compliance with the **ISO/IEC 17025** requirements, and accredited by the conformity assessment authorities listed in this test report.

BTL is not responsible for the sampling stage, so the results only apply to the sample as received.

The information, data and test plan are provided by manufacturer which may affect the validity of results, so it is manufacturer's responsibility to ensure that the apparatus meets the essential requirements of applied standards and in all the possible configurations as representative of its intended use.

Limitation

For the use of the authority's logo is limited unless the Test Standard(s)/Scope(s)/Item(s) mentioned in this test report is (are) included in the conformity assessment authorities acceptance respective.

Please note that the measurement uncertainty is provided for informational purpose only and is not use in determining the Pass/Fail results.

Table of Contents	Page
REPORT ISSUED HISTORY	5
1 . SUMMARY OF TEST RESULTS	6
1.1 TEST FACILITY	7
1.2 MEASUREMENT UNCERTAINTY	7
1.3 TEST ENVIRONMENT CONDITIONS	7
2 . GENERAL INFORMATION	8
2.1 GENERAL DESCRIPTION OF EUT	8
2.2 DESCRIPTION OF TEST MODES AND TEST CONDITION	10
2.3 BLOCKDIAGRAMSHOWINGTHECONFIGURATIONOFSYSTEMTESTED	13
3.4 DESCRIPTION OF SUPPORT UNITS	13
3 . TEST RESULT	14
3.1 OUTPUT POWER MEASUREMENT	14
3.1.1 LIMIT	14
3.1.2 TEST PROCEDURE	14
3.1.3 TEST SETUP LAYOUT	14
3.1.4 TEST DEVIATION	14
3.1.5 TEST RESULTS	14
3.2 OCCUPIED BANDWIDTH MEASUREMENT	15
3.2.1 TEST PROCEDURE	15
3.2.2 TEST SETUP LAYOUT	15
3.2.3 TEST DEVIATION	15
3.2.4 TEST RESULTS	15
3.3 CONDUCTED EMISSIONS MEASUREMENT	16
3.3.1 LIMIT	16
3.3.2 TEST PROCEDURES	16
3.3.3 TEST SETUP LAYOUT	16
3.3.4 TEST DEVIATION	16
3.3.5 TEST RESULTS	16
3.4 RADIATED EMISSIONS MEASUREMENT	17
3.4.1 LIMIT	17
3.4.2 TEST PROCEDURES	17
3.4.3 TEST SETUP LAYOUT	18
3.4.4 TEST DEVIATION	19
3.4.5 TEST RESULTS (9KHZ TO 30MHZ)	19
3.4.6 TEST RESULTS (30MHZ TO 1000MHZ)	19
3.4.7 TEST RESULTS (ABOVE 1000MHZ)	19
3.5 BAND EDGE MEASUREMENT	20
3.5.1 LIMIT	20

Table of Contents	Page
3.5.2 TEST PROCEDURES	20
3.5.3 TEST SETUP LAYOUT	20
3.5.4 TEST DEVIATION	20
3.5.5 TEST RESULTS	20
3.6 PEAK TO AVERAGE RATIO MEASUREMENT	21
3.6.1 LIMIT	21
3.6.2 TEST PROCEDURES	21
3.6.3 TEST SETUP LAYOUT	21
3.6.4 TEST DEVIATION	21
3.6.5 TEST RESULTS	21
3.7 FREQUENCY STABILITY MEASUREMENT	22
3.7.1 LIMIT	22
3.7.2 TEST PROCEDURES	22
3.7.3 TEST SETUP LAYOUT	22
3.7.4 TEST DEVIATION	22
3.7.5 TEST RESULTS	22
5. LIST OF MEASUREMENT EQUIPMENTS	23
6. EUT TEST PHOTO	26
APPENDIX A - OUTPUT POWER	28
APPENDIX B - OCCUPIED BANDWIDTH	37
APPENDIX C - CONDUCTED EMISSIONS	53
APPENDIX D - RADIATED EMISSION (9KHZ TO 30MHZ)	59
APPENDIX E - RADIATED EMISSION (30MHZ TO 1GHZ)	60
APPENDIX F - RADIATED EMISSION (ABOVE 1GHZ)	67
APPENDIX G - BAND EDGE	74
APPENDIX H - PEAK TO AVERAGE RATIO	83
APPENDIX I - FREQUENCY STABILITY	92

REPORT ISSUED HISTORY

Report Version	Description	Issued Date
R00	Original Issue.	Dec. 09, 2021

1. SUMMARY OF TEST RESULTS

Test procedures according to the technical standard(s):

FCC Part 24 Subpart E			
Standard(s) Section	Test Item	Judgment	Remark
2.1046 & 24.232(c)	Equivalent Isotropic Radiated Power	PASS	-----
2.1049	Occupied Bandwidth	PASS	-----
2.1051 & 24.238(a)	Conducted Spurious Emissions	PASS	-----
2.1053 & 24.238(a)	Radiated Spurious Emissions	PASS	-----
24.238(a)	Band Edge Measurements	PASS	-----
24.232(d)	Peak To Average Ratio	PASS	-----
2.1055 & 24.235	Frequency Stability	PASS	-----

Note:

For the verdict, the "N/A" denotes "not applicable", the "N/T" denotes "not tested".

1.1 TEST FACILITY

The test facilities used to collect the test data in this report is at the location of No. 29, Jintang Road, Tangzhen Industry Park, Pudong New Area, Shanghai 201210, China.
 BTL's Test Firm Registration Number for FCC: 476765
 BTL's Designation Number for FCC: CN1241

1.2 MEASUREMENT UNCERTAINTY

The measurement uncertainty figures shall be calculated according the methods described in the ETSI TR 100 028 and shall correspond to an expansion factor (coverage factor) $k=1.96$ or $k=2$ (which provide confidence levels of respectively 90% and 95.45% in the case where the distributions characterizing the actual measurement uncertainties are normal (Gaussian)).

Measurement Uncertainty for a Level of Confidence of 95 %, $U=2xUc(y)$.

The BTL measurement uncertainty as below table:

A. Radiated Measurement :

Test Site	Method	Measurement Frequency Range	Ant. H / V	U,(dB)
SH-CB02	CISPR	9 KHz~30 MHz	-	2.16
		30 MHz~200 MHz	V	4.04
		30 MHz~200 MHz	H	2.90
		200 MHz~1,000 MHz	V	3.76
		200 MHz~1,000 MHz	H	3.82

Test Site	Method	Measurement Frequency Range	U,(dB)
SH-CB02 (3m)	CISPR	1GHz ~ 6GHz	4.56
		6GHz ~ 18GHz	4.14

Note: Unless specifically mentioned, the uncertainty of measurement has not been taken into account to declare the compliance or non-compliance to the specification.

1.3 TEST ENVIRONMENT CONDITIONS

Test Item	Temperature	Humidity	Test Voltage	Tested By
Output Power & ERP	24°C	35%	DC 3.8V	Danny Dang
Occupied Bandwidth	24°C	35%	DC 3.8V	Danny Dang
Conducted Spurious Emissions	24°C	35%	DC 3.8V	Danny Dang
Radiated Spurious Emissions	26°C	61%	DC 3.8V	Jane Wang
Band Edge	24°C	35%	DC 3.8V	Danny Dang
Peak to Average Ratio	24°C	35%	DC 3.8V	Danny Dang
Frequency Stability	Normal and Extreme			Danny Dang

2. GENERAL INFORMATION

2.1 GENERAL DESCRIPTION OF EUT

Equipment	LTE Module	
Brand Name	Quectel	
Test Model	EC200A-AU	
Series Model	N/A	
Model Difference(s)	N/A	
Software Version	EC200AAUHAR01A01M16	
Hardware Version	R1.0	
Power Source	DC Voltage supplied from AC/DC adapter(support unit)	
Power Rating	Supply voltage: 3.4–4.5V, Typical supply voltage: 3.8 V	
Antenna Type	Dipole	
Antenna Gain	PCS1900	1.59 dBi
	WCDMA II	
	LTE Band 2	
Modulation Type	GSM	GMSK
	GPRS	GMSK
	EDGE	GMSK, 8PSK
	WCDMA	UL: QPSK DL: QPSK, 16QAM
	LTE	UL: QPSK, 16QAM DL: QPSK, 16QAM, 64QAM
Operation Frequency	EDGE/GSM/GPRS	1850.2MHz ~ 1909.8MHz
	WCDMA Band II	1852.4MHz ~ 1907.6MHz
	LTE Band 2 (Channel Bandwidth: 1.4MHz)	1850.7MHz ~ 1909.3MHz
	LTE Band 2 (Channel Bandwidth: 3MHz)	1851.5MHz ~ 1908.5MHz
	LTE Band 2 (Channel Bandwidth: 5MHz)	1852.5MHz ~ 1907.5MHz
	LTE Band 2 (Channel Bandwidth: 10MHz)	1855.0MHz ~ 1905.0MHz
	LTE Band 2 (Channel Bandwidth: 15MHz)	1857.5MHz ~ 1902.5MHz
	LTE Band 2 (Channel Bandwidth: 20MHz)	1860.0MHz ~ 1900.0MHz

Max. EIRP Power	GSM	GMSK	31.43	dBm
	GPRS	GMSK	31.29	dBm
	EDGE	8PSK	28.17	dBm
	WCDMA	QPSK	25.64	dBm
	LTE Band 2 (Channel Bandwidth: 1.4MHz)	QPSK	25.49	dBm
		16QAM	24.69	dBm
	LTE Band 2 (Channel Bandwidth: 3MHz)	QPSK	25.09	dBm
		16QAM	24.49	dBm
	LTE Band 2 (Channel Bandwidth: 5MHz)	QPSK	25.19	dBm
		16QAM	24.69	dBm
	LTE Band 2 (Channel Bandwidth: 10MHz)	QPSK	25.29	dBm
		16QAM	24.69	dBm
	LTE Band 2 (Channel Bandwidth: 15MHz)	QPSK	25.19	dBm
		16QAM	24.49	dBm
LTE Band 2 (Channel Bandwidth: 20MHz)	QPSK	25.49	dBm	
	16QAM	24.99	dBm	

Note:

1. For a more detailed features description, please refer to the manufacturer's specifications or the user's manual.
2. GSM (GMSK) mode was found to be the worst case and recorded.

2.2 DESCRIPTION OF TEST MODES AND TEST CONDITION

Following channel(s) was (were) selected for the final test as listed below:

GSM MODE			
Test Item	Available Channel	Tested Channel	Mode
EIRP	512 to 810	512, 661, 810	GSM, GPRS, EDGE
Output Power	512 to 810	512, 661, 810	GSM, GPRS, EDGE
Occupied Bandwidth	512 to 810	512, 661, 810	GSM,EDGE
Condcudeted Emission	512 to 810	661	GSM,EDGE
Radiated Emission	512 to 810	661	GSM
Band Edge	512 to 810	512, 810	GSM,EDGE
Peak to Average Ratio	512 to 810	512, 661, 810	GSM,EDGE
Frequency Stability	512 to 810	661	GSM

WCDMA MODE			
Test Item	Available Channel	Tested Channel	Mode
EIRP	9262 to 9538	9262, 9400, 9538	WCDMA, HSDPA,HSUPA
Output Power	9262 to 9538	9262, 9400, 9538	WCDMA, HSDPA,HSUPA
Conducted Emission	9262 to 9538	9400	WCDMA
Radiated Emission	9262 to 9538	9400	WCDMA
Band Edge	9262 to 9538	9262, 9538	WCDMA
Peak to Average Ratio	9262 to 9538	9262, 9400, 9538	WCDMA
Frequency Stability	9262 to 9538	9400	WCDMA

LTE BAND 2 MODE					
Test Item	Available Channel	Tested Channel	Channel Bandwidth	Modulation	Mode
Output Power & EIRP	18607 to 19193	18607, 18900, 19193	1.4MHz	QPSK, 16QAM	1RB/3RB/6RB
	18615 to 19185	18615, 18900, 19185	3MHz	QPSK, 16QAM	1RB/8RB/15RB
	18625 to 19175	18625, 18900, 19175	5MHz	QPSK, 16QAM	1RB/12RB/25RB
	18650 to 19150	18650, 18900, 19150	10MHz	QPSK, 16QAM	1RB/25RB/50RB
	18675 to 19125	18675, 18900, 19125	15MHz	QPSK, 16QAM	1RB/36RB/75RB
	18700 to 19100	18700, 18900, 19100	20MHz	QPSK, 16QAM	1RB/50RB/100RB
Occupied Bandwidth	18607 to 19193	18607, 18900, 19193	1.4MHz	QPSK, 16QAM	6RB
	18615 to 19185	18615, 18900, 19185	3MHz	QPSK, 16QAM	15RB
	18625 to 19175	18625, 18900, 19175	5MHz	QPSK, 16QAM	25RB
	18650 to 19150	18650, 18900, 19150	10MHz	QPSK, 16QAM	50RB
	18675 to 19125	18675, 18900, 19125	15MHz	QPSK, 16QAM	75 RB
	18700 to 19100	18700, 18900, 19100	20MHz	QPSK, 16QAM	100RB
Conducted Emission	18607 to 19193	18900	1.4 MHz	QPSK	1RB
	18625 to 19175	18900	5MHz	QPSK	1RB
	18700 to 19100	18900	20MHz	QPSK	1RB
Radiated Emission	18607 to 19193	18900	1.4 MHz	QPSK	1RB
	18625 to 19175	18900	5MHz	QPSK	1RB
	18700 to 19100	18900	20MHz	QPSK	1RB
Band Edge	18607 to 19193	18607	1.4MHz	QPSK	1RB/6RB
		19193	1.4MHz	QPSK	
	18615 to 19185	18615	3MHz	QPSK	1RB/15RB
		19185	3MHz	QPSK	
	18625 to 19175	18625	5MHz	QPSK	1RB/25RB
		19175	5MHz	QPSK	
	18650 to 19150	18650	10MHz	QPSK	1RB/50RB
		19150	10MHz	QPSK	
	18675 to 19125	18675	15MHz	QPSK	1RB/75RB
		19125	15MHz	QPSK	
	18700 to 19100	18700	20MHz	QPSK	1RB/100RB
		19100	20MHz	QPSK	

LTE BAND 2 MODE					
Test Item	Available Channel	Tested Channel	Channel Bandwidth	Modulation	Mode
Peak To Average Ratio	18607 to 19193	18607, 18900, 19193	1.4MHz	QPSK, 16QAM	1RB
	18615 to 19185	18615, 18900, 19185	3MHz	QPSK, 16QAM	1RB
	18625 to 19175	18625, 18900, 19175	5MHz	QPSK, 16QAM	1RB
	18650 to 19150	18650, 18900, 19150	10MHz	QPSK, 16QAM	1RB
	18675 to 19125	18675, 18900, 19125	15MHz	QPSK, 16QAM	1RB
	18700 to 19100	18700, 18900, 19100	20MHz	QPSK, 16QAM	1RB
Frequency Stability	18607 to 19193	18900	1.4MHz	QPSK	1RB
	18615 to 19185	18900	3MHz	QPSK	1RB
	18625 to 19175	18900	5MHz	QPSK	1RB
	18650 to 19150	18900	10MHz	QPSK	1RB
	18675 to 19125	18900	15MHz	QPSK	1RB
	18700 to 19100	18900	20MHz	QPSK	1RB

2.3 BLOCKDIGRAMSHOWINGTHECONFIGURATIONOFSYSTEMTESTED

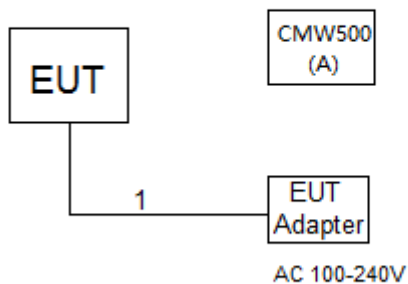

3.4 DESCRIPTION OF SUPPORT UNITS

The EUT has been tested as an independent unit together with other necessary accessories or support units. The following support units or accessories were used to form a representative test configuration during the tests.

Item	Equipment	Mfr/Brand	Model/Type No.	Series No.
A	CMW500	N/A	N/A	129246

Item	Cable Type	Shielded Type	Ferrite Core	Length
1	DC	N/A	N/A	1m

3. TEST RESULT

3.1 OUTPUT POWER MEASUREMENT

3.1.1 LIMIT

Mobile / Portable station are limited to 2 watts e.i.r.p.

3.1.2 TEST PROCEDURE

EIRP:

$EIRP = \text{Output Power} + \text{Antenan gain}$

Output Power:

The EUT was set up for the maximum power with GSM, GPRS, EDGE, WCDMA and LTE link data modulation and link up with simulator. Set the EUT to transmit under low, middle and high channel and record the power level shown on simulator.

3.1.3 TEST SETUP LAYOUT

Output Power Measurement

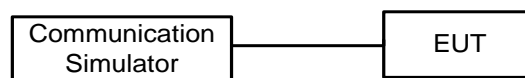

3.1.4 TEST DEVIATION

No deviation

3.1.5 TEST RESULTS

Please refer to the Appendix A.

3.2 OCCUPIED BANDWIDTH MEASUREMENT

3.2.1 TEST PROCEDURE

The EUT makes a call to the communication simulator. All measurements were done at low, middle and high operational frequency range. The communication simulator station system controlled a EUT to export maximum output power under transmission mode and specific channel frequency. Use OBW measurement function of Spectrum analyzer to measure 99 % occupied bandwidth and 26dB bandwidth.

3.2.2 TEST SETUP LAYOUT

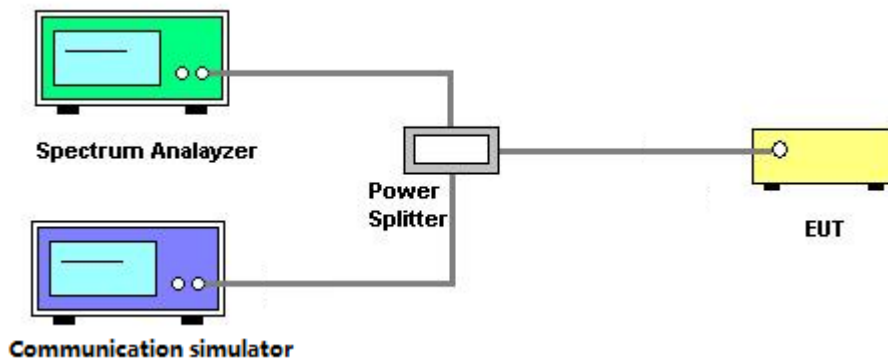

3.2.3 TEST DEVIATION

No deviation

3.2.4 TEST RESULTS

Please refer to the Appendix B.

3.3 CONDUCTED EMISSIONS MEASUREMENT

3.3.1 LIMIT

The power of any emission outside of the authorized operating frequency ranges must be attenuated below the transmitting power (P) by a factor of at least $43 + 10 \log(P)$ dB. The emission limit equal to -13dBm.

3.3.2 TEST PROCEDURES

1. The testing follows FCC KDB 971168 v03r01 Section 6.0.
2. The EUT was connected to spectrum analyzer and system simulator via a power divider.
3. The band edges of low and high channels for the highest RF powers were measured. Set RBW \geq 1% EBW in the 1MHz band immediately outside and adjacent to the band edge.
4. Set spectrum analyzer with RMS detector.
5. The RF fundamental frequency should be excluded against the limit line in the operating frequency band.

3.3.3 TEST SETUP LAYOUT

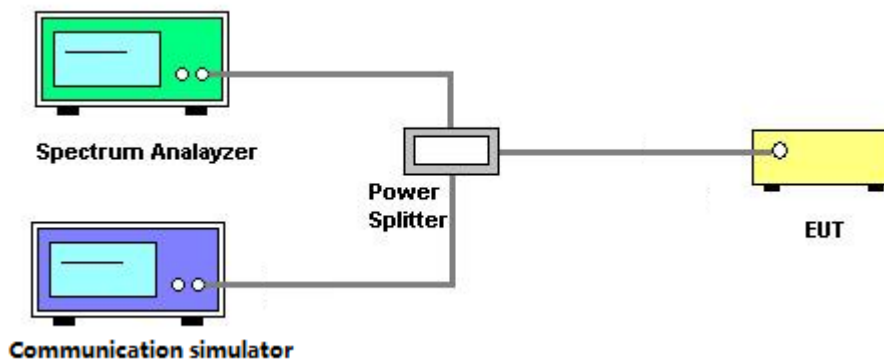

3.3.4 TEST DEVIATION

No deviation

3.3.5 TEST RESULTS

Please refer to the Appendix C.

3.4 RADIATED EMISSIONS MEASUREMENT

3.4.1 LIMIT

The power of any emission outside of the authorized operating frequency ranges must be attenuated below the transmitting power (P) by a factor of at least $43 + 10 \log(P)$ dB. The emission limit equal to -13dBm.

3.4.2 TEST PROCEDURES

1. In the semi-anechoic chamber, EUT placed on the 0.8m height of Turn Table, rotated the table around 360 degrees to search the maximum radiation power and receiver antenna shall be rotated vertical and horizontal polarization and moved height from 1m to 4m to find the maximum polar radiated power. The "Read Value" is the spectrum reading the maximum power value.
2. The substitution horn antenna is substituted for EUT at the same position and signals generator export the CW signal to the substitution antenna via a TX cable. Rotated the Turn Table and moved receiving antenna to find the maximum radiation power. Adjust output power level of S.G to get a Value of spectrum reading equal to "Read Value " of step a. Record the power level of S.G
3. EIRP = Output power level of S.G – TX cable loss + Antenna gain of substitution horn.
4. E.R.P power can be calculated form E.I.R.P power by subtracting the gain of dipole, E.R.P power = E.I.P.R power - 2.15dBi.
5. The resolution bandwidth and video bandwidth of test receiver/spectrum analyzer is 1MHz/3MHz.

3.4.3 TEST SETUP LAYOUT

Below 30MHz

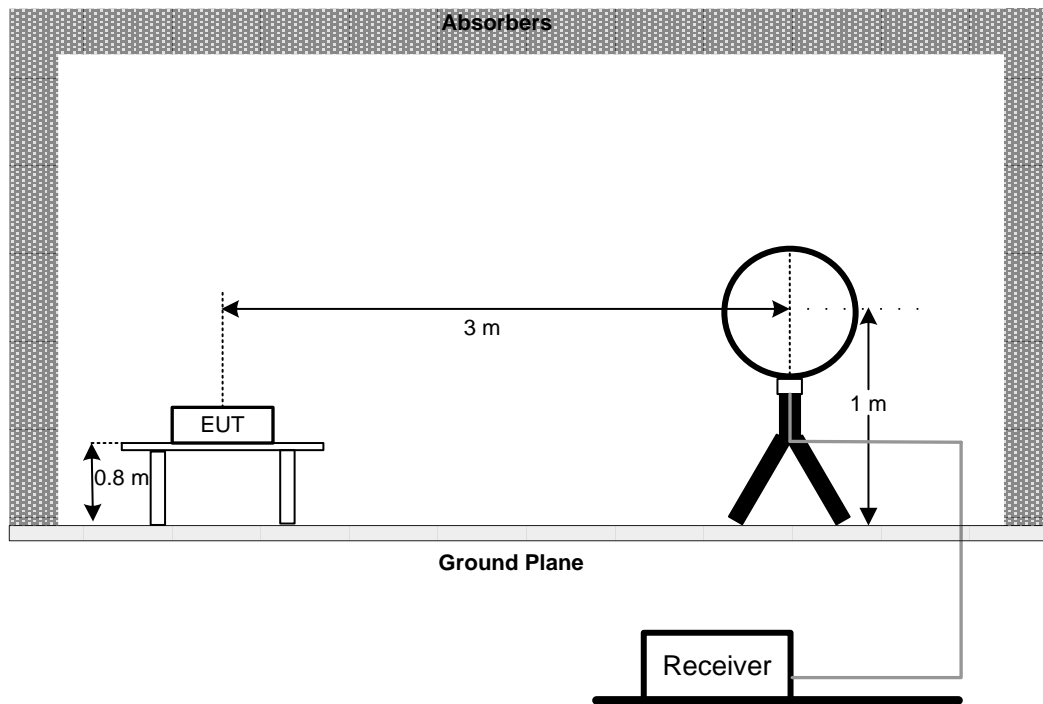

30MHz to 1GHz

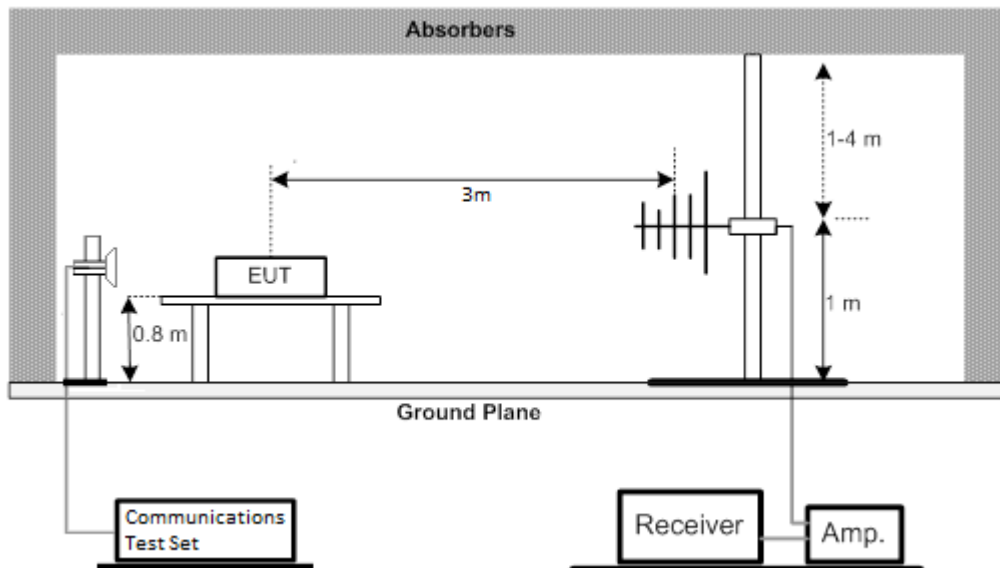

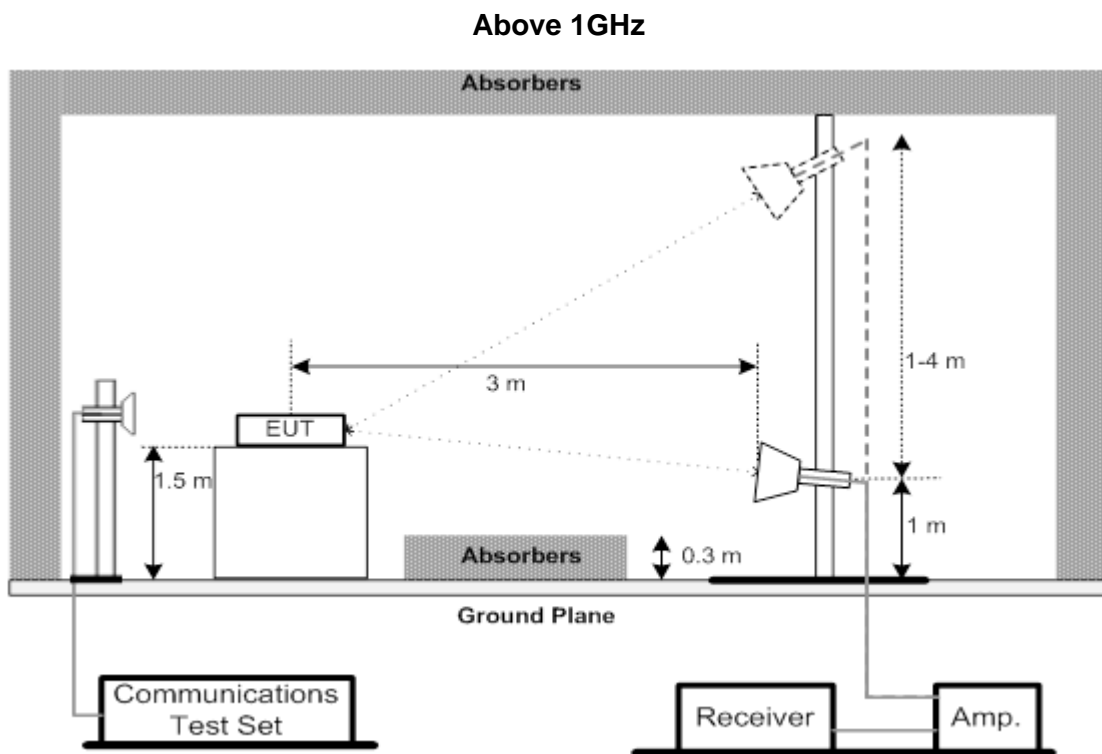

3.4.4 TEST DEVIATION

No deviation

3.4.5 TEST RESULTS (9KHZ TO 30MHZ)

Please refer to the Appendix D.

3.4.6 TEST RESULTS (30MHZ TO 1000MHZ)

Please refer to the Appendix E.

3.4.7 TEST RESULTS (ABOVE 1000MHZ)

Please refer to the Appendix F.

3.5 BAND EDGE MEASUREMENT

3.5.1 LIMIT

A Power of any emission outside of the authorized operating frequency ranges must be attenuated below the transmitting power (P) by a factor of at least $43 + 10 \log(P)$ dB. In the 1 MHz bands immediately outside and adjacent to the frequency block a resolution bandwidth of at least one percent of the emission bandwidth of the fundamental emission of the transmitter may be employed.

3.5.2 TEST PROCEDURES

1. All measurements were done at low and high operational frequency range.
2. The center frequency of spectrum is the band edge frequency and span is 1.5MHz. RB of the spectrum is 3kHz and VB of the spectrum is 10kHz (GSM/EDGE).
3. The center frequency of spectrum is the band edge frequency and span is 10MHz. RB of the spectrum is 100kHz and VB of the spectrum is 300kHz (WCDMA).
4. The center frequency of spectrum is the band edge frequency and span is 2MHz. RB of the spectrum is 15kHz and VB of the spectrum is 43kHz (LTE Bandwidth 1.4MHz).
5. The center frequency of spectrum is the band edge frequency and span is 2MHz. RB of the spectrum is 30kHz and VB of the spectrum is 91kHz (LTE Bandwidth 3MHz).
6. The center frequency of spectrum is the band edge frequency and span is 2MHz. RB of the spectrum is 51kHz and VB of the spectrum is 150kHz (LTE Bandwidth 5MHz).
7. The center frequency of spectrum is the band edge frequency and span is 2MHz. RB of the spectrum is 100kHz and VB of the spectrum is 300kHz (LTE Bandwidth 10MHz).
8. The center frequency of spectrum is the band edge frequency and span is 2MHz. RB of the spectrum is 150kHz and VB of the spectrum is 470kHz (LTE Bandwidth 15MHz).
9. The center frequency of spectrum is the band edge frequency and span is 2MHz. RB of the spectrum is 200kHz and VB of the spectrum is 620kHz (LTE Bandwidth 20MHz).
10. Record the max trace plot into the test report.

3.5.3 TEST SETUP LAYOUT

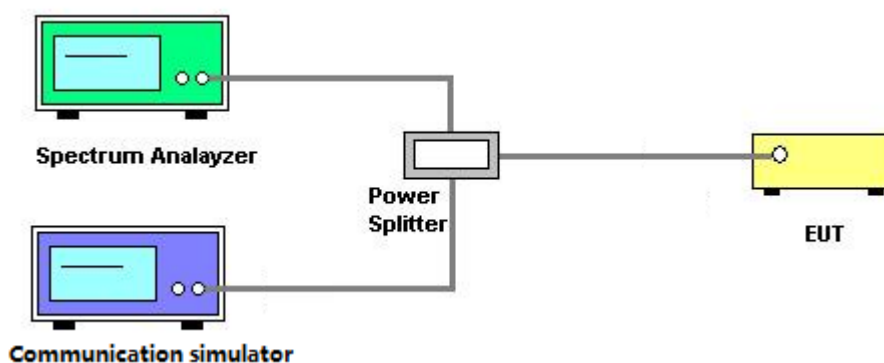

3.5.4 TEST DEVIATION

No deviation

3.5.5 TEST RESULTS

Please refer to the Appendix G.

3.6 PEAK TO AVERAGE RATIO MEASUREMENT

3.6.1 LIMIT

In measuring transmissions in this band using an average power technique, the peak to-average ratio (PAR) of the transmission may not exceed 13 dB.

3.6.2 TEST PROCEDURES

1. Set resolution/measurement bandwidth \geq signal's occupied bandwidth;
2. Set the number of counts to a value that stabilizes the measured CCDF curve;
3. Record the maximum PAPR level associated with a probability of 0.1%.

3.6.3 TEST SETUP LAYOUT

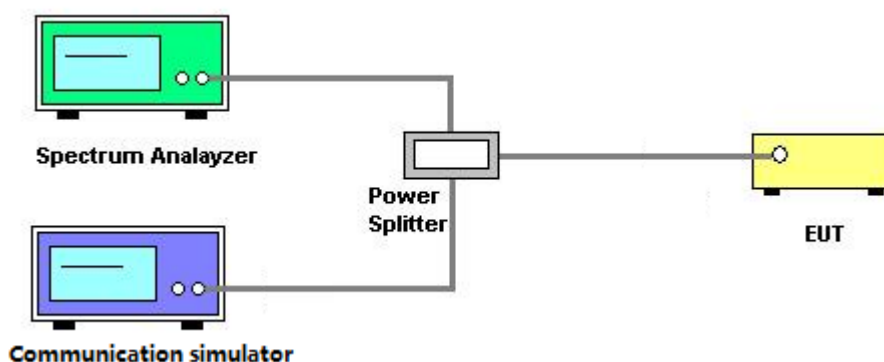

3.6.4 TEST DEVIATION

No deviation

3.6.5 TEST RESULTS

Please refer to the Appendix H.

3.7 FREQUENCY STABILITY MEASUREMENT

3.7.1 LIMIT

± 1.5 ppm is for base and fixed station. ± 2.5 ppm is for mobile station.

3.7.2 TEST PROCEDURES

1. Device is placed at the oven room. The oven room could control the temperatures and humidity. Power warm up is at least 15 min and power applied should perform before recording frequency error.
2. EUT is connected the external power supply to control the DC input power. The test voltage range is from minimum to maximum working voltage. Each step shall be record the frequency error rate.
3. The temperature range step is 10 degrees in this test items. All temperature levels shall be hold the $\pm 0.5^{\circ}\text{C}$ during the measurement testing. The each temperature step shall be at least 0.5 hours, consider the EUT could be test under the stability condition.
4. The frequency error was recorded frequency error from the communication simulator.

3.7.3 TEST SETUP LAYOUT

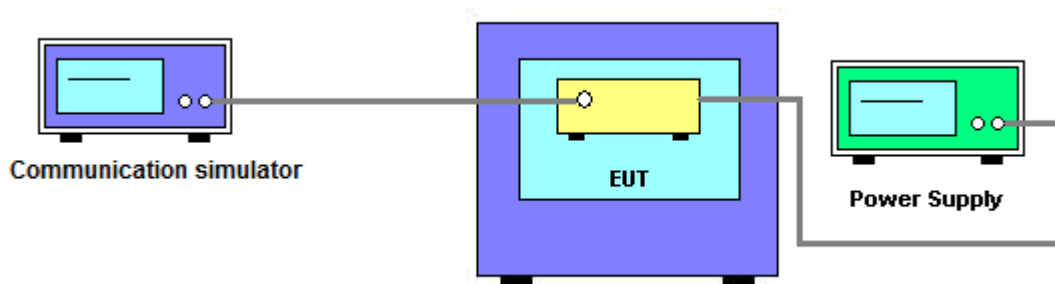

3.7.4 TEST DEVIATION

No deviation

3.7.5 TEST RESULTS

Please refer to the Appendix I.

5. LIST OF MEASUREMENT EQUIPMENTS

Radiated Emission Measurement(9K-30M)					
Item	Kind of Equipment	Manufacturer	Type No.	Serial No.	Calibrated until
1	Loop Antenna	EMCI	EMCI LPA600	275	May. 20, 2022
2	MXE EMI Receiver	Keysight	N9038A	MY56400088	Mar. 21, 2022
3	Measurement Software	Farad	EZ-EMC Ver.NB-03A1-01	N/A	N/A
4	Wideband Radio Communication Test	R&S	CMW500	129246	Aug. 23, 2022

Radiated Emission Measurement(30M-1G)					
Item	Kind of Equipment	Manufacturer	Type No.	Serial No.	Calibrated until
1	TRILOG Broadband Antenna	Schwarzbeck	VULB 9160	9160-3233	Mar. 26, 2022
2	Pre-Amplifier	emci	EMC9135	980401	Mar. 20, 2022
3	MXE EMI Receiver	Keysight	N9038A	MY56400088	Mar. 21, 2022
4	Test Cable	emci	EMC104-SM-SM-7000	181020	Apr. 11, 2022
5	Test Cable	emci	EMC104-SM-SM-2500	170618	Apr. 11, 2022
6	Test Cable	emci	EMC104-SM-SM-800	170647	Apr. 11, 2022
7	Measurement Software	Farad	EZ-EMC Ver.NB-03A1-01	N/A	N/A
8	Wideband Radio Communication Test	R&S	CMW500	129246	Aug. 23, 2022

Radiated Emission Measurement(1G-18G)					
Item	Kind of Equipment	Manufacturer	Type No.	Serial No.	Calibrated until
1	Double Ridged Broadband Horn Antenna	Schwarzbeck	BBHA 9120D	9120D-1817	Mar. 26, 2022
2	Pre-Amplifier	emci	EMC051845SE	980725	Aug. 23, 2022
3	EXA Spectrum Analyzer	Keysight	N9010A	MY56480579	Mar. 21, 2022
4	Test Cable	emci	EMC104-SM-SM-7000	181020	Apr. 11, 2022
5	Test Cable	emci	EMC104-SM-SM-2500	170618	Apr. 11, 2022
6	Test Cable	emci	EMC104-SM-SM-800	170647	Apr. 11, 2022
7	Measurement Software	Farad	EZ-EMC Ver.NB-03A1-01	N/A	N/A
8	Wideband Radio Communication Test	R&S	CMW500	129246	Aug. 23, 2022

For GSM & WCDMA

Conducted Emission & Band Edge & Occupied Bandwidth Measurement					
Item	Kind of Equipment	Manufacturer	Type No.	Serial No.	Calibrated until
1	Wideband Radio Communication Test	R&S	CMW500	129246	Aug. 23, 2022
2	EXA Spectrum Analyzer	Keysight	N9010A	MY56480579	Mar. 21, 2022
3	Power Divider	JUK	PD-2SF-2060	N/A	N/A

Frequency Stability Measurement					
Item	Kind of Equipment	Manufacturer	Type No.	Serial No.	Calibrated until
1	Wideband Radio Communication Test	R&S	CMW500	129246	Aug. 23, 2022
2	EXA Spectrum Analyzer	Keysight	N9010A	MY56480579	Mar. 21, 2022
3	Power Divider	JUK	PD-2SF-2060	N/A	N/A
4	Temperature And Humidity Box	Blue pand	BPHS-120B	170616454	Aug. 23, 2022

For LTE

Conducted Emission & Band Edge & Occupied Bandwidth Measurement					
Item	Kind of Equipment	Manufacturer	Type No.	Serial No.	Calibrated until
1	EXA Spectrum Analyzer	Keysight	N9010A	MY56480579	Mar. 21, 2022
2	Power Divider	JUK	PD-4SF-2060	N/A	N/A
3	Wideband Radio Communication Test	R&S	CMW500	129246	Aug. 23, 2022

Frequency Stability Measurement					
Item	Kind of Equipment	Manufacturer	Type No.	Serial No.	Calibrated until
1	EXA Spectrum Analyzer	Keysight	N9010A	MY56480579	Mar. 21, 2022
2	Power Divider	JUK	PD-4SF-2060	N/A	N/A
3	Wideband Radio Communication Test	R&S	CMW500	129246	Aug. 23, 2022
4	Temperature And Humidity Box	Blue pand	BPHS-120B	170616454	Aug. 23, 2022

Remark: "N/A" denotes no model name, serial no. or calibration specified.

All calibration period of equipment list is one year.

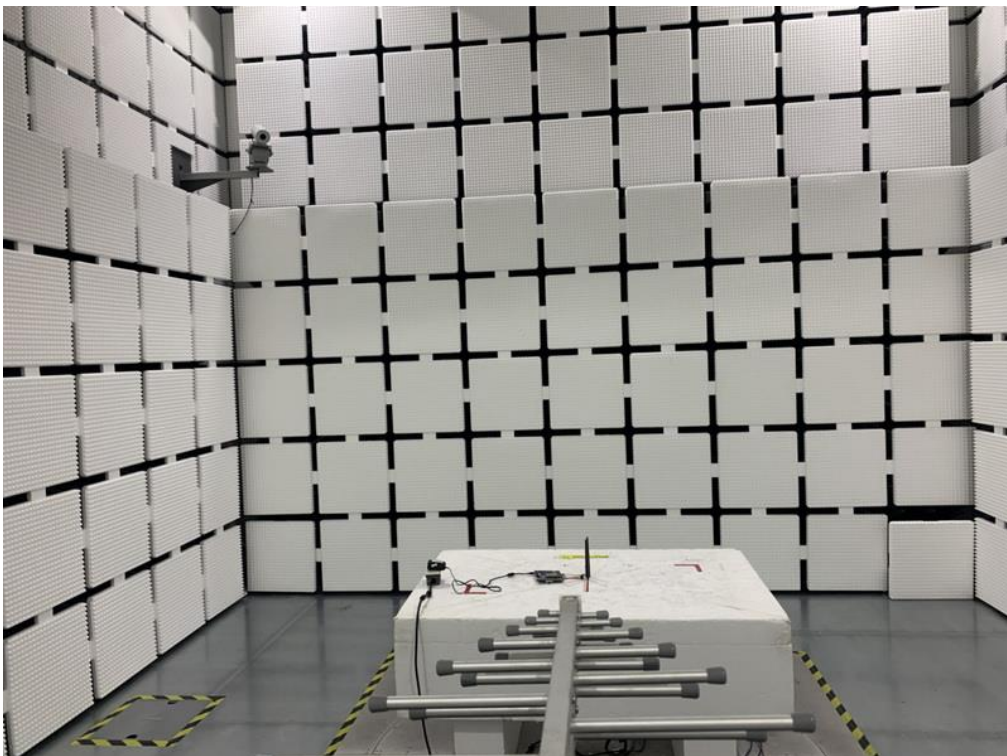
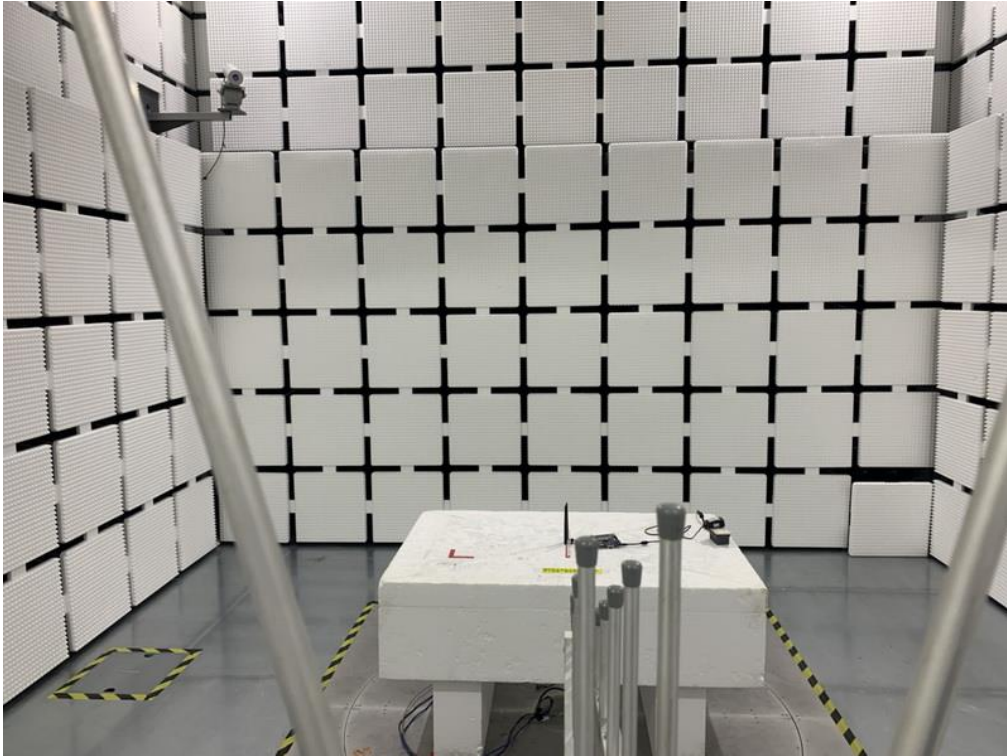
6. EUT TEST PHOTO**Radiated Emissions Test Photos****30 MHz to 1000 MHz**

Radiated Emissions Test Photos

Above 1 GHz

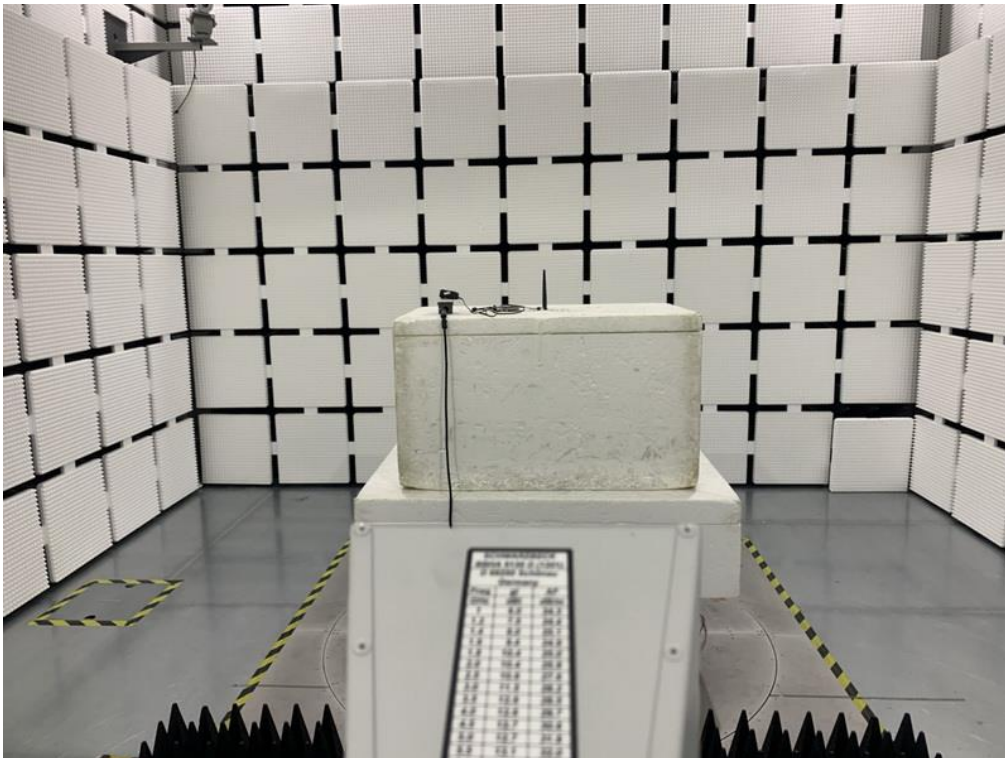
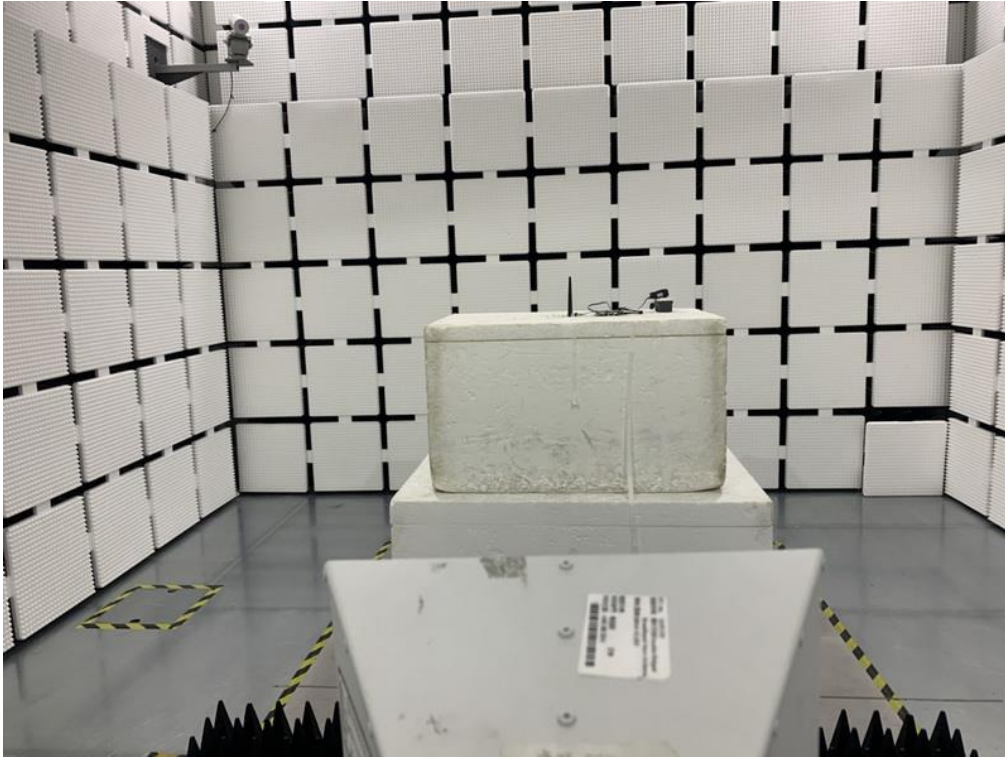

APPENDIX A - OUTPUT POWER

Output Power (dBm):

PCS1900		Burst Output Power		
		512CH	661CH	810CH
		1850.2MHz	1880MHz	1909.8MHz
GSM(GMSK)		29.42	29.70	29.84
GPRS/EDGE (GMSK)	1 Tx Slot	29.25	29.52	29.70
	2 Tx Slot	29.23	29.53	29.68
	3 Tx Slot	27.97	28.27	28.50
	4 Tx Slot	26.14	26.48	26.66
EDGE (8PSK)	1 Tx Slot	26.06	26.02	26.58
	2 Tx Slot	26.05	26.07	26.44
	3 Tx Slot	24.10	24.21	24.96
	4 Tx Slot	22.14	22.60	23.16

Modulation	Band	WCDMA Band II		
	Tx Channel	9262CH	9400CH	9538CH
	Frequency	1852.4MHz	1880MHz	1907.6MHz
QPSK	RMC 12.2K	23.34	23.73	23.81
	RMC 64K	23.39	23.38	23.63
	RMC 144K	23.44	23.63	23.25
	RMC 384K	23.44	23.77	23.67
	HSDPA Subtest-1	23.57	23.87	23.96
	HSDPA Subtest-2	23.00	23.38	23.29
	HSDPA Subtest-3	22.39	23.63	22.70
	HSDPA Subtest-4	22.38	22.72	22.69
	HSUPA Subtest-1	23.82	23.92	23.79
	HSUPA Subtest-2	23.78	23.98	23.90
	HSUPA Subtest-3	23.10	23.35	23.25
	HSUPA Subtest-4	23.85	24.05	24.01
	HSUPA Subtest-5	23.15	23.37	23.29

LTE Band / BW	Modulation	RB Size	RB Offset	Low CH	Mid CH	High CH
				18607CH	18900CH	19193CH
				1850.7MHz	1880MHz	1909.3MHz
2 / 1.4M	QPSK	1	0	22.60	23.60	23.90
		1	2	22.30	23.30	23.60
		1	5	22.80	23.50	23.90
		3	0	22.20	23.20	23.50
		3	1	22.30	23.30	23.50
		3	2	22.30	23.30	23.50
	16QAM	6	0	21.50	22.40	22.60
		1	0	22.20	23.10	23.10
		1	2	22.10	22.80	22.90
		1	5	22.40	23.10	23.10
		3	0	21.60	22.40	22.60
		3	1	21.60	22.40	22.60
		3	2	21.60	22.40	22.60
		6	0	20.70	21.60	21.90

LTE Band / BW	Modulation	RB Size	RB Offset	Low CH	Mid CH	High CH
				18615CH	18900CH	19185CH
				1851.5MHz	1880MHz	1908.5MHz
2 / 3M	QPSK	1	0	21.60	22.40	22.50
		1	7	23.20	23.30	23.40
		1	14	23.30	23.30	23.50
		8	0	21.50	22.40	22.50
		8	4	21.70	22.50	22.60
		8	7	21.70	22.40	22.60
		15	0	21.70	22.50	22.60
	16QAM	1	0	21.90	22.90	22.90
		1	7	22.20	22.90	22.90
		1	14	22.20	22.90	22.90
		8	0	20.50	21.40	21.60
		8	4	20.60	21.40	21.70
		8	7	20.60	21.40	21.80
		15	0	20.60	21.40	21.70

LTE Band / BW	Modulation	RB Size	RB Offset	Low CH	Mid CH	High CH
				18625CH	18900CH	19175CH
				1852.5MHz	1880MHz	1907.5MHz
2 / 5M	QPSK	1	0	22.40	23.40	23.40
		1	13	22.40	23.30	23.50
		1	24	22.80	23.40	23.60
		12	0	21.50	22.40	22.40
		12	6	21.70	22.50	22.50
		12	11	21.80	22.50	22.60
		25	0	21.70	22.50	22.50
	16QAM	1	0	22.10	23.00	22.80
		1	13	22.20	22.90	22.90
		1	24	22.60	23.10	23.10
		12	0	20.60	21.50	21.50
		12	6	20.70	21.50	21.70
		12	11	20.80	21.50	21.80
		25	0	20.60	21.40	21.60

LTE Band / BW	Modulation	RB Size	RB Offset	Low CH	Mid CH	High CH
				18650CH	18900CH	19150CH
				1855MHz	1880MHz	1905MHz
2 / 10M	QPSK	1	0	22.60	23.70	23.60
		1	25	22.60	23.20	23.00
		1	49	22.90	23.40	23.70
		25	0	21.40	22.30	22.10
		25	13	21.80	22.40	22.30
		25	25	21.80	22.20	22.30
		50	0	21.60	22.30	22.30
	16QAM	1	0	22.20	23.10	23.00
		1	25	22.30	22.80	22.70
		1	49	22.60	22.90	23.10
		25	0	20.40	21.20	21.00
		25	13	20.60	21.30	21.20
		25	25	20.70	21.10	21.30
		50	0	20.50	21.30	21.20

LTE Band / BW	Modulation	RB Size	RB Offset	Low CH	Mid CH	High CH
				18675CH	18900CH	19125CH
				1857.5MHz	1880MHz	1902.5MHz
2 / 15M	QPSK	1	0	22.30	23.40	23.00
		1	38	22.70	23.20	23.00
		1	74	23.10	22.90	23.60
		36	0	21.60	22.40	22.30
		36	18	21.90	22.40	22.30
		36	39	22.00	22.20	22.40
		75	0	21.80	22.40	22.40
	16QAM	1	0	22.00	22.90	22.70
		1	38	22.40	22.80	22.60
		1	74	22.70	22.60	22.90
		36	0	20.50	21.30	21.20
		36	18	20.80	21.30	21.30
		36	39	20.90	21.20	21.30
		75	0	20.60	21.40	21.40

LTE Band / BW	Modulation	RB Size	RB Offset	Low CH	Mid CH	High CH
				18700CH	18900CH	19100CH
				1860MHz	1880MHz	1900MHz
2 / 20M	QPSK	1	0	22.70	23.90	22.70
		1	50	22.70	23.20	23.20
		1	99	23.90	22.80	23.80
		50	0	23.60	22.40	22.00
		50	25	22.00	22.50	22.60
		50	50	22.10	22.10	22.30
		100	0	21.90	22.40	22.60
	16QAM	1	0	22.30	23.40	22.40
		1	50	22.50	22.80	22.90
		1	99	23.30	22.50	23.10
		50	0	20.50	21.30	20.80
		50	25	20.90	21.40	21.50
		50	50	21.00	21.00	21.20
		100	0	20.80	21.30	21.50

EIRP Power (dBm):

PCS1900		EIRP Power		
		512CH	661CH	810CH
		1850.2MHz	1880MHz	1909.8MHz
GSM(GMSK)		31.01	31.29	31.43
GPRS/EDGE (GMSK)	1 Tx Slot	30.84	31.11	31.29
	2 Tx Slot	30.82	31.12	31.27
	3 Tx Slot	29.56	29.86	30.09
	4 Tx Slot	27.73	28.07	28.25
EDGE (8PSK)	1 Tx Slot	27.65	27.61	28.17
	2 Tx Slot	27.64	27.66	28.03
	3 Tx Slot	25.69	25.80	26.55
	4 Tx Slot	23.73	24.19	24.75

Modulation	Band	WCDMA Band II		
	Tx Channel	9262CH	9400CH	9538CH
	Frequency	1852.4MHz	1880MHz	1907.6MHz
QPSK	RMC 12.2K	24.93	25.32	25.40
	RMC 64K	24.98	24.97	25.22
	RMC 144K	25.03	25.22	24.84
	RMC 384K	25.03	25.36	25.26
	HSDPA Subtest-1	25.16	25.46	25.55
	HSDPA Subtest-2	24.59	24.97	24.88
	HSDPA Subtest-3	23.98	25.22	24.29
	HSDPA Subtest-4	23.97	24.31	24.28
	HSUPA Subtest-1	25.41	25.51	25.38
	HSUPA Subtest-2	25.37	25.57	25.49
	HSUPA Subtest-3	24.69	24.94	24.84
	HSUPA Subtest-4	25.44	25.64	25.60
	HSUPA Subtest-5	24.74	24.96	24.88

LTE Band / BW	Modulation	RB Size	RB Offset	Low CH	Mid CH	High CH
				18607CH	18900CH	19193CH
				1850.7MHz	1880MHz	1909.3MHz
2 / 1.4M	QPSK	1	0	24.19	25.19	25.49
		1	2	23.89	24.89	25.19
		1	5	24.39	25.09	25.49
		3	0	23.79	24.79	25.09
		3	1	23.89	24.89	25.09
		3	2	23.89	24.89	25.09
	16QAM	6	0	23.09	23.99	24.19
		1	0	23.79	24.69	24.69
		1	2	23.69	24.39	24.49
		1	5	23.99	24.69	24.69
		3	0	23.19	23.99	24.19
		3	1	23.19	23.99	24.19
		3	2	23.19	23.99	24.19
		6	0	22.29	23.19	23.49

LTE Band / BW	Modulation	RB Size	RB Offset	Low CH	Mid CH	High CH
				18615CH	18900CH	19185CH
				1851.5MHz	1880MHz	1908.5MHz
2 / 3M	QPSK	1	0	23.19	23.99	24.09
		1	7	24.79	24.89	24.99
		1	14	24.89	24.89	25.09
		8	0	23.09	23.99	24.09
		8	4	23.29	24.09	24.19
		8	7	23.29	23.99	24.19
		15	0	23.29	24.09	24.19
	16QAM	1	0	23.49	24.49	24.49
		1	7	23.79	24.49	24.49
		1	14	23.79	24.49	24.49
		8	0	22.09	22.99	23.19
		8	4	22.19	22.99	23.29
		8	7	22.19	22.99	23.39
		15	0	22.19	22.99	23.29

LTE Band / BW	Modulation	RB Size	RB Offset	Low CH	Mid CH	High CH
				18625CH	18900CH	19175CH
				1852.5MHz	1880MHz	1907.5MHz
2 / 5M	QPSK	1	0	23.99	24.99	24.99
		1	13	23.99	24.89	25.09
		1	24	24.39	24.99	25.19
		12	0	23.09	23.99	23.99
		12	6	23.29	24.09	24.09
		12	11	23.39	24.09	24.19
		25	0	23.29	24.09	24.09
	16QAM	1	0	23.69	24.59	24.39
		1	13	23.79	24.49	24.49
		1	24	24.19	24.69	24.69
		12	0	22.19	23.09	23.09
		12	6	22.29	23.09	23.29
		12	11	22.39	23.09	23.39
		25	0	22.19	22.99	23.19

LTE Band / BW	Modulation	RB Size	RB Offset	Low CH	Mid CH	High CH
				18650CH	18900CH	19150CH
				1855MHz	1880MHz	1905MHz
2 / 10M	QPSK	1	0	24.19	25.29	25.19
		1	25	24.19	24.79	24.59
		1	49	24.49	24.99	25.29
		25	0	22.99	23.89	23.69
		25	13	23.39	23.99	23.89
		25	25	23.39	23.79	23.89
		50	0	23.19	23.89	23.89
	16QAM	1	0	23.79	24.69	24.59
		1	25	23.89	24.39	24.29
		1	49	24.19	24.49	24.69
		25	0	21.99	22.79	22.59
		25	13	22.19	22.89	22.79
		25	25	22.29	22.69	22.89
		50	0	22.09	22.89	22.79

LTE Band / BW	Modulation	RB Size	RB Offset	Low CH	Mid CH	High CH
				18675CH	18900CH	19125CH
				1857.5MHz	1880MHz	1902.5MHz
2 / 15M	QPSK	1	0	23.89	24.99	24.59
		1	38	24.29	24.79	24.59
		1	74	24.69	24.49	25.19
		36	0	23.19	23.99	23.89
		36	18	23.49	23.99	23.89
		36	39	23.59	23.79	23.99
		75	0	23.39	23.99	23.99
	16QAM	1	0	23.59	24.49	24.29
		1	38	23.99	24.39	24.19
		1	74	24.29	24.19	24.49
		36	0	22.09	22.89	22.79
		36	18	22.39	22.89	22.89
		36	39	22.49	22.79	22.89
		75	0	22.19	22.99	22.99

LTE Band / BW	Modulation	RB Size	RB Offset	Low CH	Mid CH	High CH
				18700CH	18900CH	19100CH
				1860MHz	1880MHz	1900MHz
2 / 20M	QPSK	1	0	24.29	25.49	24.29
		1	50	24.29	24.79	24.79
		1	99	25.49	24.39	25.39
		50	0	25.19	23.99	23.59
		50	25	23.59	24.09	24.19
		50	50	23.69	23.69	23.89
		100	0	23.49	23.99	24.19
	16QAM	1	0	23.89	24.99	23.99
		1	50	24.09	24.39	24.49
		1	99	24.89	24.09	24.69
		50	0	22.09	22.89	22.39
		50	25	22.49	22.99	23.09
		50	50	22.59	22.59	22.79
		100	0	22.39	22.89	23.09

APPENDIX B - OCCUPIED BANDWIDTH

PCS1900					
GSM			EDGE		
GMSK			8PSK		
Channel	Frequency (MHz)	99% Occupied Bandwidth (MHz)	Channel	Frequency (MHz)	99% Occupied Bandwidth (MHz)
512	1850.2	0.2438	512	1850.2	0.2451
661	1880	0.2426	661	1880	0.2439
810	1909.8	0.2459	810	1909.8	0.2448
Channel	Frequency (MHz)	26dB Bandwidth (MHz)	Channel	Frequency (MHz)	26dB Bandwidth (MHz)
512	1850.2	0.3001	512	1850.2	0.3214
661	1880	0.2985	661	1880	0.2976
810	1909.8	0.3096	810	1909.8	0.3066

Spectrum Plot

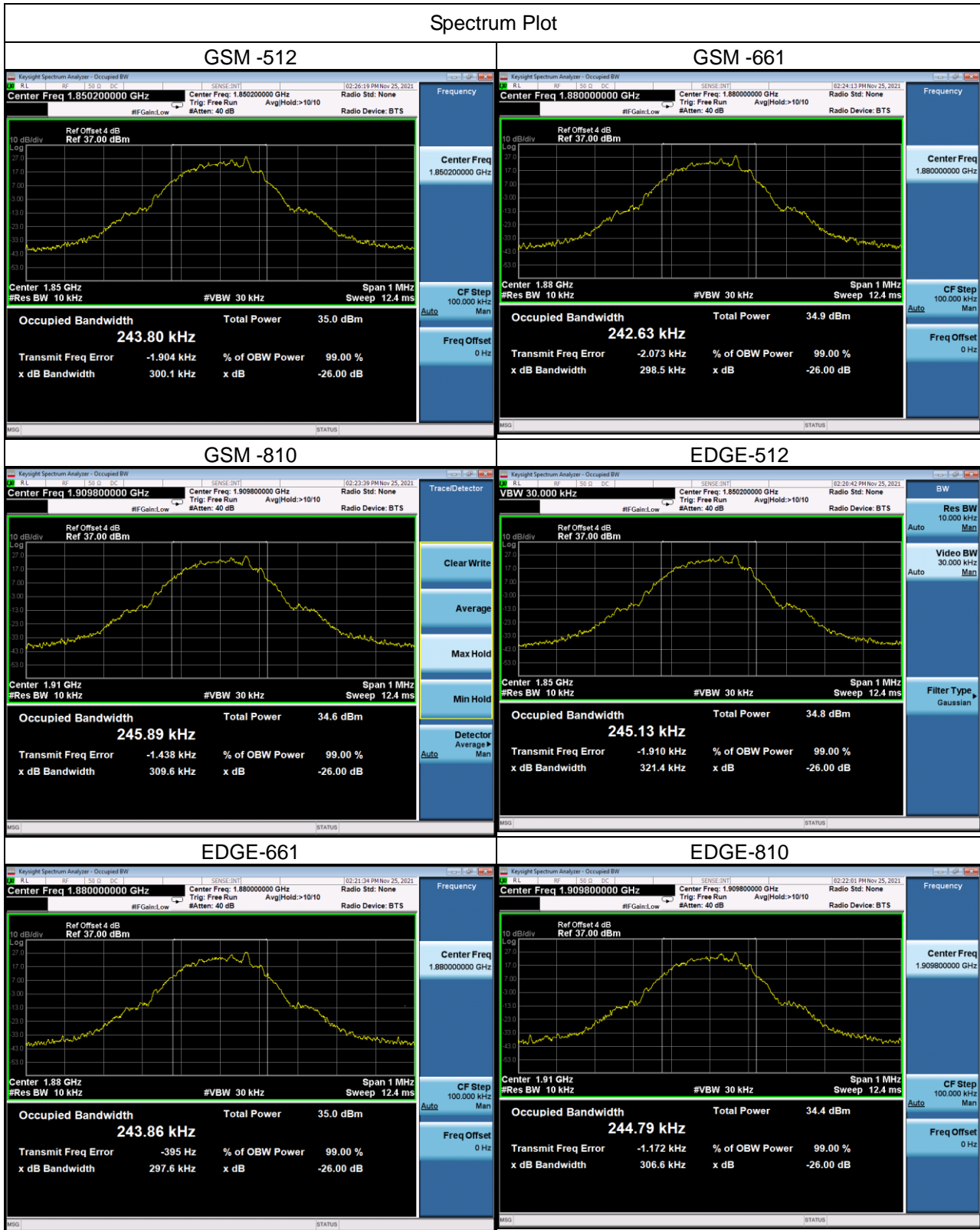

WCDMA Band II					
QPSK					
Channel	Frequency (MHz)	99% Occupied Bandwidth (MHz)	Channel	Frequency (MHz)	26dB Bandwidth (MHz)
9262	1852.4	4.3122	9262	1852.4	4.8510
9400	1880	4.3650	9400	1880	5.0300
9538	1907.6	4.4129	9538	1907.6	7.5570



LTE Band 2_1.4M					
QPSK			16QAM		
Channel	Frequency (MHz)	99% Occupied Bandwidth (MHz)	Channel	Frequency (MHz)	99% Occupied Bandwidth (MHz)
18607	1850.7	1.0899	18607	1850.7	1.1029
18900	1880	1.1065	18900	1880	1.0951
19193	1909.3	1.0975	19193	1909.3	1.1009
Channel	Frequency (MHz)	26dB Bandwidth (MHz)	Channel	Frequency (MHz)	26dB Bandwidth (MHz)
18607	1850.7	1.261	18607	1850.7	1.259
18900	1880	1.272	18900	1880	1.255
19193	1909.3	1.254	19193	1909.3	1.268

Spectrum Plot

QPSK-18607

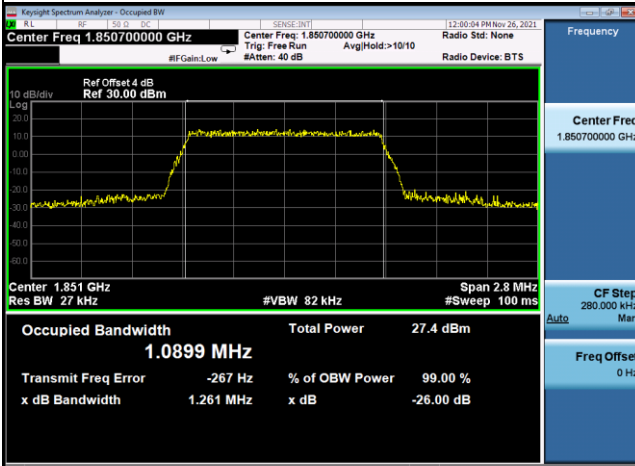

QPSK-18900

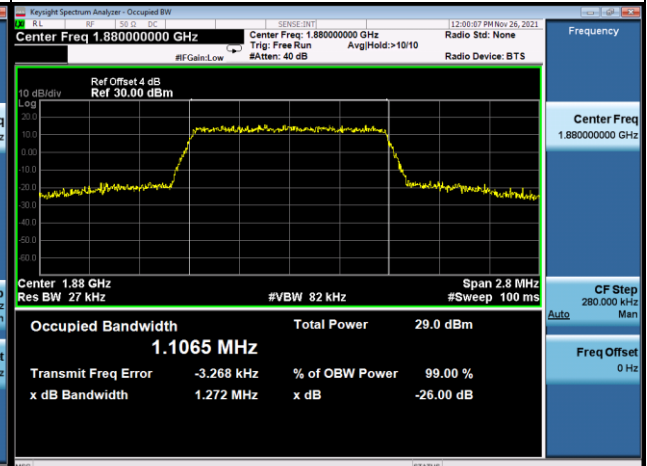

QPSK-19193

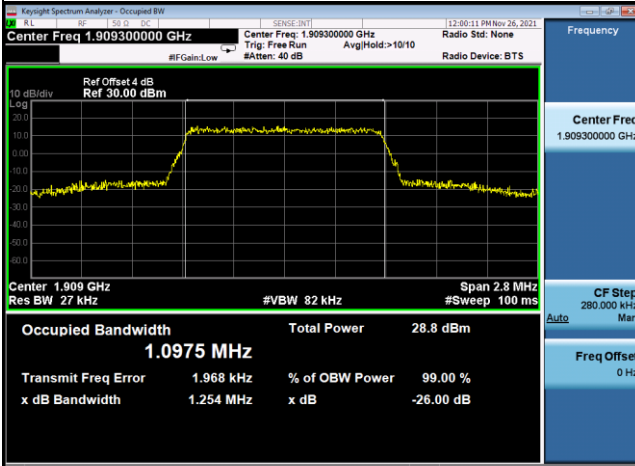

16QAM-18607

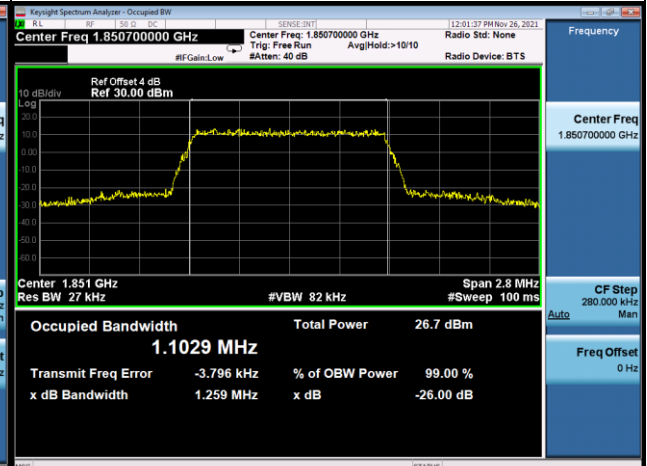

16QAM-18900



16QAM-19193

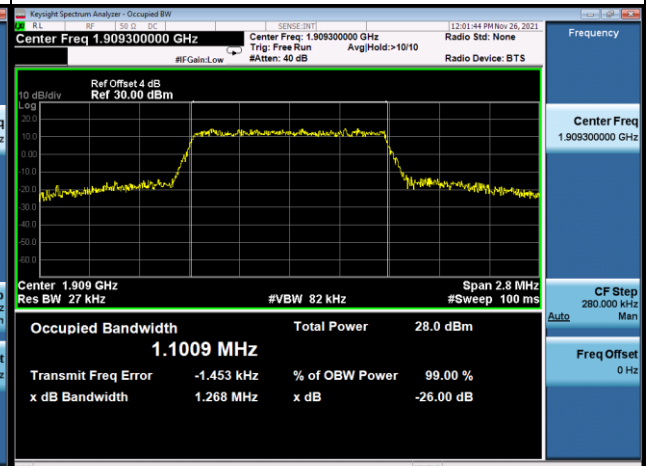

LTE Band 2_3M					
QPSK			16QAM		
Channel	Frequency (MHz)	99% Occupied Bandwidth (MHz)	Channel	Frequency (MHz)	99% Occupied Bandwidth (MHz)
18615	1851.5	2.6962	18615	1851.5	2.6985
18900	1880	2.7009	18900	1880	2.6992
19185	1908.5	2.6972	19185	1908.5	2.6998
Channel	Frequency (MHz)	26dB Bandwidth (MHz)	Channel	Frequency (MHz)	26dB Bandwidth (MHz)
18615	1851.5	2.919	18615	1851.5	2.925
18900	1880	2.922	18900	1880	2.923
19185	1908.5	2.911	19185	1908.5	3.095

Spectrum Plot

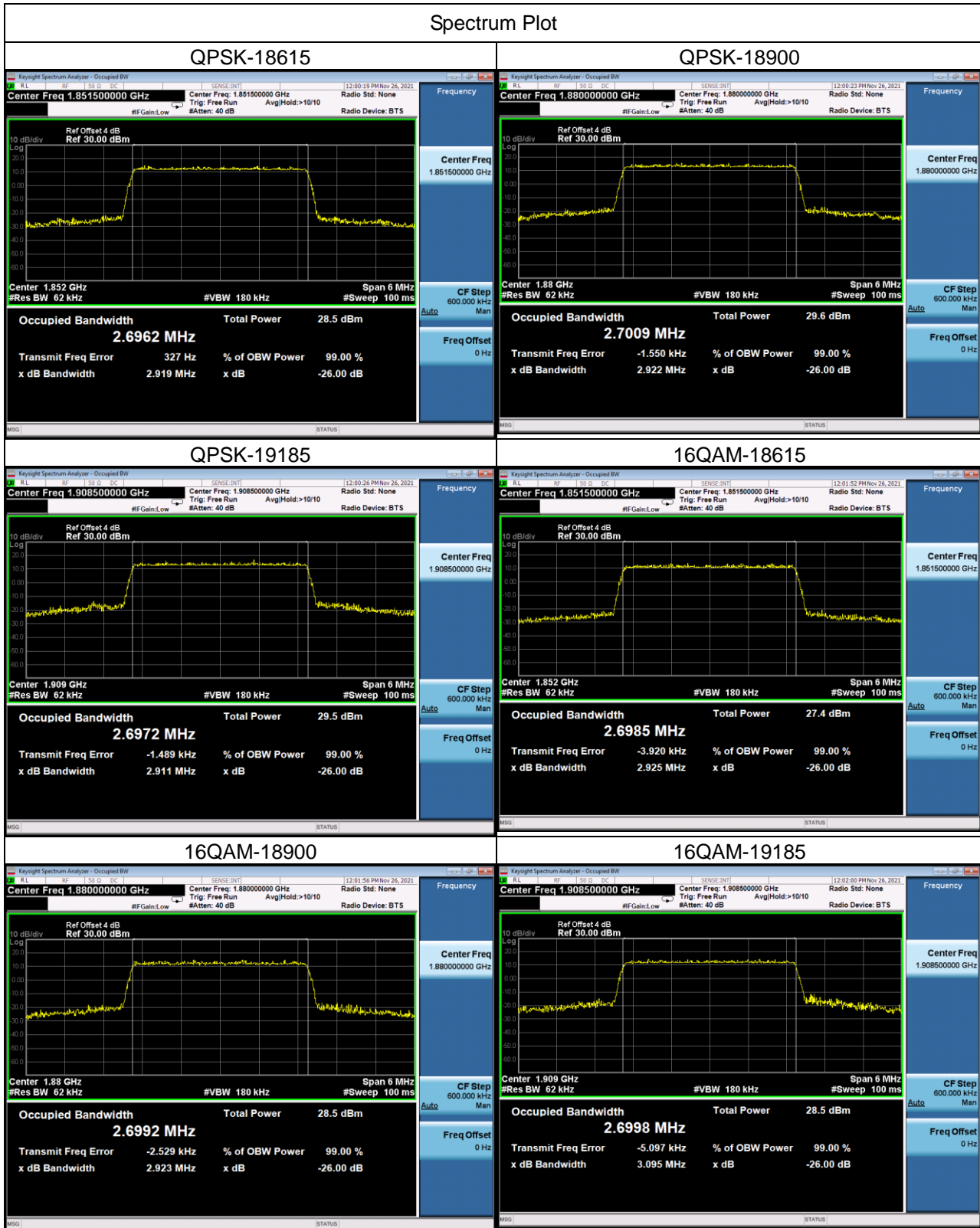

LTE Band 2_5M					
QPSK			16QAM		
Channel	Frequency (MHz)	99% Occupied Bandwidth (MHz)	Channel	Frequency (MHz)	99% Occupied Bandwidth (MHz)
18625	1852.5	4.5014	18625	1852.5	4.4902
18900	1880	4.4972	18900	1880	4.4983
19175	1907.5	4.5024	19175	1907.5	4.4972
Channel	Frequency (MHz)	26dB Bandwidth (MHz)	Channel	Frequency (MHz)	26dB Bandwidth (MHz)
18625	1852.5	4.836	18625	1852.5	4.858
18900	1880	4.851	18900	1880	4.846
19175	1907.5	4.838	19175	1907.5	4.834

Spectrum Plot

QPSK-18625

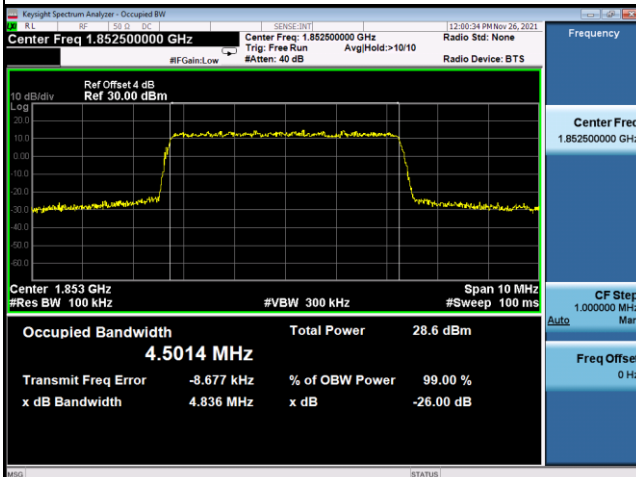

QPSK-18900

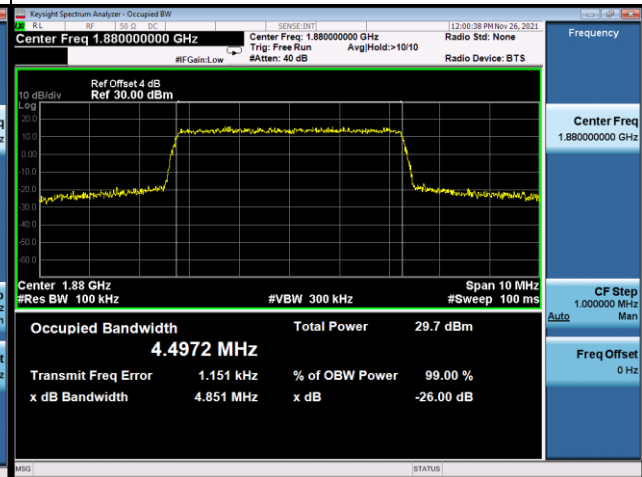

QPSK-19175

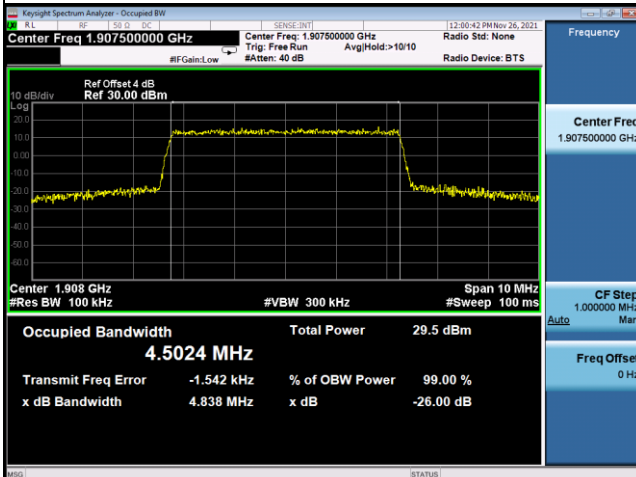

16QAM-18625



16QAM-18900

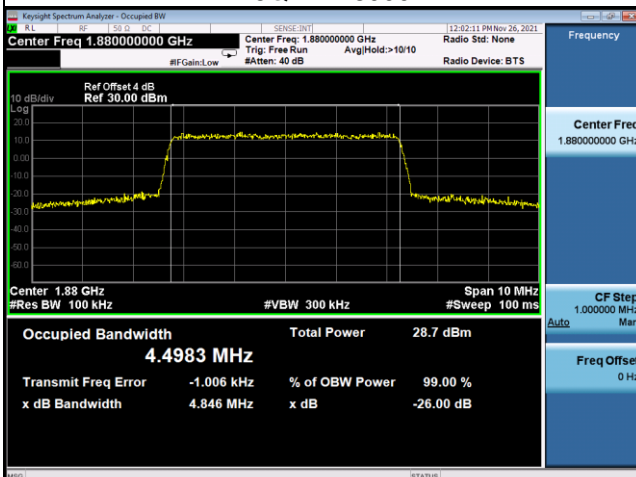

16QAM-19175

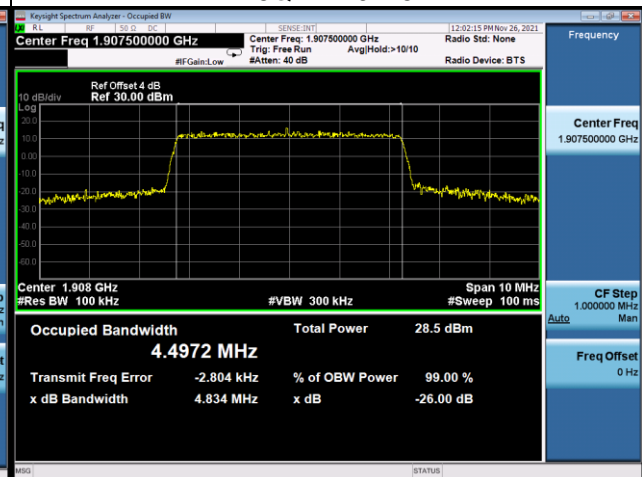

LTE Band 2_10M					
QPSK			16QAM		
Channel	Frequency (MHz)	99% Occupied Bandwidth (MHz)	Channel	Frequency (MHz)	99% Occupied Bandwidth (MHz)
18650	1855	8.9520	18650	1855	8.9365
18900	1880	8.9613	18900	1880	8.9431
19150	1905	8.9702	19150	1905	8.9684
Channel	Frequency (MHz)	26dB Bandwidth (MHz)	Channel	Frequency (MHz)	26dB Bandwidth (MHz)
18650	1855	9.691	18650	1855	9.657
18900	1880	9.657	18900	1880	9.653
19150	1905	9.656	19150	1905	9.637

Spectrum Plot

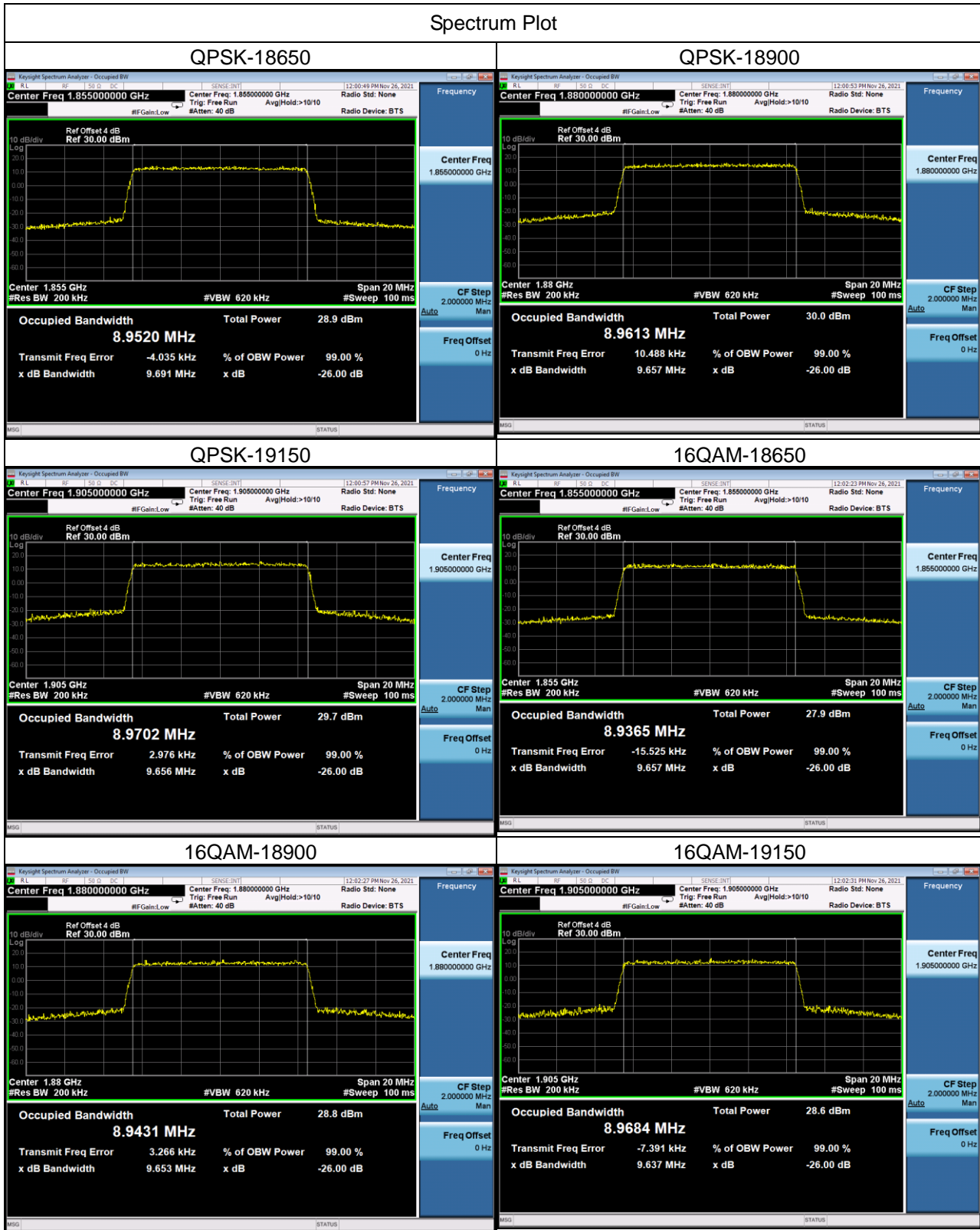

LTE Band 2_15M					
QPSK			16QAM		
Channel	Frequency (MHz)	99% Occupied Bandwidth (MHz)	Channel	Frequency (MHz)	99% Occupied Bandwidth (MHz)
18675	1857.5	13.4370	18675	1857.5	13.4380
18900	1880	13.4350	18900	1880	13.4150
19125	1902.5	13.4510	19125	1902.5	13.4310
Channel	Frequency (MHz)	26dB Bandwidth (MHz)	Channel	Frequency (MHz)	26dB Bandwidth (MHz)
18675	1857.5	14.540	18675	1857.5	14.430
18900	1880	14.410	18900	1880	14.460
19125	1902.5	14.420	19125	1902.5	14.470