

# RF wireless LED remote controller

Model:SR-2819S with SR-1009Fxx



- Four zones/areas
- Press-button RGB+W controller
- Receivers work with WIFI-RF converter to be controlled by smart phone



## Product introduction

SR-2819S RGBW remote controller has 4 different zones. It can get Red/ Green/ Blue/ White color directly. The remote controller can save up to 3 colors or 3 modes into corresponding buttons (S1,S2,S3) for each zone.

You can choose any color through color wheel. you can set the system as RGB 3-channeloutput, or RGBW 4-channel output.

## Parameter

### Remote

| Part No. | Operation Voltage | Operation Frequency | DIMENSIONS<br>ø/h (mm) | Remarks                          |
|----------|-------------------|---------------------|------------------------|----------------------------------|
| SR-2819S | 4.5VDC            | 916.66MHz           | 48x140x16              | load 3pcs 7 AAA (1.5V) batteries |

### Receiver

| Part No.   | Input Voltage | Output Current | Output Power  | Remarks          |
|------------|---------------|----------------|---------------|------------------|
| SR-1009FA  | 12-36VDC      | 4x5A           | 4x(60-180)W   | Constant voltage |
| SR-1009EA  | 12-36VDC      | 4x8A           | 4x(96-288)W   | Constant voltage |
| SR-1009FA3 | 12-36VDC      | 4x350mA        | 4x(4.2-12.6)W | Constant current |
| SR-1009FA7 | 12-36VDC      | 4x700mA        | 4x(8.4-25.2)W | Constant current |

## Product Size

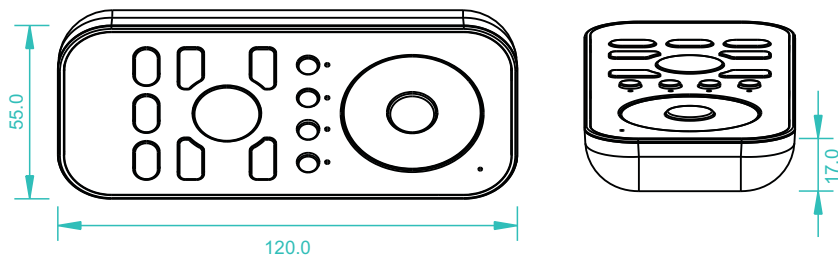

## Brief introduction of buttons

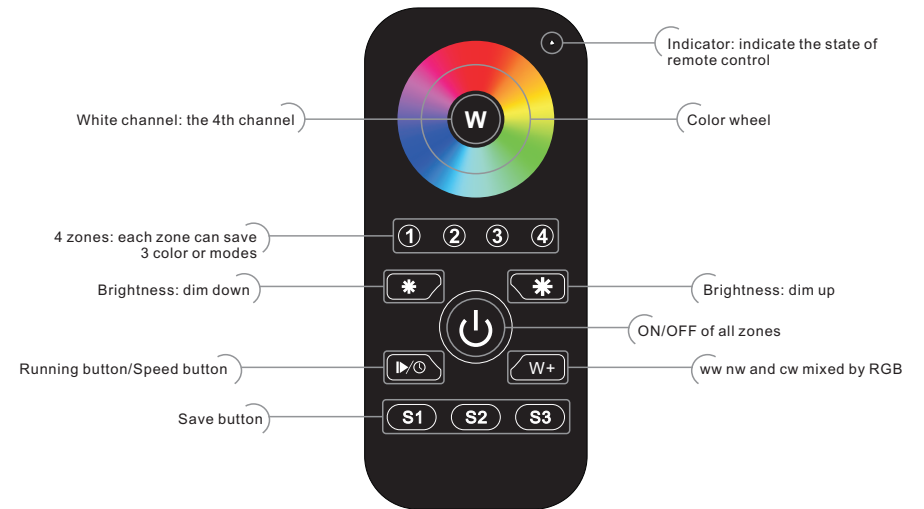

## Wiring diagram

### 1)Receiver Connection Diagram for Single Unit

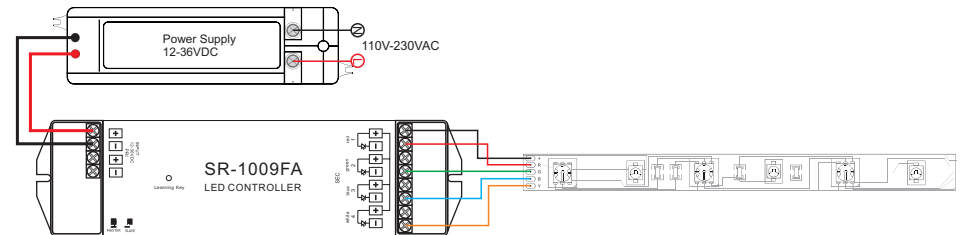

### 2)Receiver Connection Diagram for Multiple Units

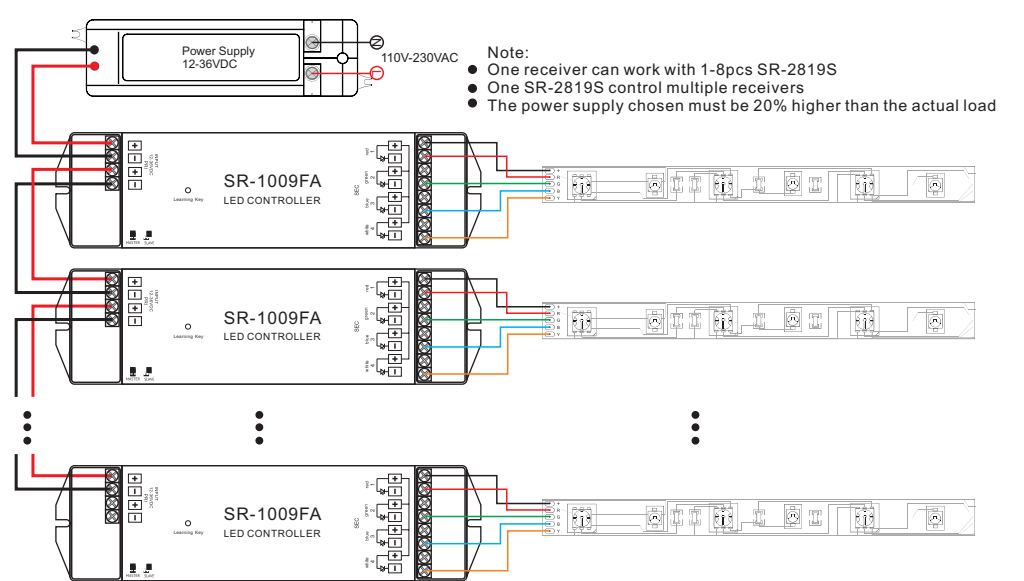

## Operation

### Learning (matching)

- Do wiring according to connection diagram
- Wake up the remote control by touching ON/OFF button.
- Press learning button on receiver.
- Touch any zone button on remote control.
- Then touch color wheel.
- Connected LED light will blink to confirm zone designation.
- Press at learning button on receiver over 5 seconds until LED light flash, then delete the learned ID.

**Note 1: To choose a master from slaves by jumper for each zone.**

**Short circuit for master.**

**Open circuit for slave.**

**Each zone only can set one master controller. After a period of time, the master will do synchronization operation to keep the same color or mode of all slaves in one zone.**



**Note 2: Each remote control 4 zones (areas) receivers, each area can be learned as many receivers as we can.**

**Each receiver maximally can be controlled by 8 different remote controllers.**

### Color wheel



Choose zone number ① ② ③ ④, for example, ① and ③, then touch , choose the color you want, zone 1 and 3 will indicate corresponding color as we touched.

### Brightness Up & Down Button

Short/Long press button  to dim down brightness of RGB channels, Short/long press  button to dim up RGB channels.

"W" channel is separated from RGB channels, so we can only long press button to dimming "W" channel.

### Running Mode & Speed Button

- Short press , mode will run. Press it once, it runs one mode. Press button again, it stops, then press one more time, it will enter next mode. There are total 10 build-in modes.
- Long press  when mode is running, First long press will speed up the color moving, long press again to speed down the color moving.



### W+ Button

a. RGB channel will mix to three different white: warm white, nature white and cold white by short press 

For example: first press---warm white, press again---nature white, third press again---cold white, fourth press---warm white.....

b. Fast click twice  to switch off RGB channel.

### Save and recall button

- Save color: select zones from ① ② ③ ④ → select a color from  → long press one save button from S1,S2,S3 for 2-3 second → LED lighting flash twice indicate save successful
  - Save running mold: select zones from ① ② ③ ④ → select a moving mode from  → long press one save button from S1,S2,S3 for 2-3 second → LED lighting flash twice indicate save successful
- c. Recall: select zone button which we want recall from 1-4, then short press save button S1,S2,S3.

## Safety & Warnings

- The product shall be installed and serviced by a qualified person.
- IP20. Please avoid the sun and rain. When installed outdoors, please ensure it is mounted in a water proof enclosure.
- Always be sure to mount this unit in an area with proper ventilation to avoid overheating.
- Please check if the output voltage of any LED power supplies used comply with the working voltage of the product.
- Never connect any cables while power is on and always assure correct connections to avoid short circuits before switching on.
- Please ensure that the cable is secured tightly in the connector
- For update information please consult your supplier.

## Warranty Agreement

- We provide lifelong technical assistance with this product:
  - 5-year warranty. We print date on every products, for example :1125 means year 2011, week 25. The warranty is for free repair or replacement and covers manufacturing faults only.
  - For faults beyond the 5-year warranty we reserve the right to charge for time and parts.
- Limited Warranty
  - Any defects caused by wrong operation.
  - Any damages caused by unauthorized removal, maintenance, modifying, incorrect connection and replacement of chips.
  - Any damages due to transportation, vibration etc. after purchase.
  - Any damages caused by earthquake, fire, lightning, pollution and abnormal voltage.
  - Any damages caused by negligence, inappropriate storing at high temperatures and humidity or near harmful chemicals.
  - Product has been updated
- Repair or replacement as provided under this warranty is the exclusive remedy to the customer.

This equipment has been tested and found to comply with the limits for a Class B digital device, pursuant to part 15 of the FCC Rules. These limits are designed to provide reasonable protection against harmful interference in a residential installation. This equipment generates, uses and can radiate radio frequency energy and, if not installed and used in accordance with the instructions, may cause harmful interference to radio communications. However, there is no guarantee that interference will not occur in a particular installation. If this equipment does cause harmful interference to radio or television reception, which can be determined by turning the equipment off and on, the user is encouraged to try to correct the interference by one or more of the following measures:

- Reorient or relocate the receiving antenna.
- Increase the separation between the equipment and receiver.
- Connect the equipment into an outlet on a circuit different from that to which the receiver is connected.
- Consult the dealer or an experienced radio/TV technician for help.

Caution: Any changes or modifications to this device not explicitly approved by manufacturer could void your authority to operate this equipment.

This device complies with part 15 of the FCC Rules. Operation is subject to the following two conditions: (1) This device may not cause harmful interference, and (2) this device must accept any interference received, including interference that may cause undesired operation.