

# FCC TEST REPORT

## FCC ID: 2AHRVF7

Product	:	Smart Media Player
Model Name	:	F7,F7I
Brand	:	N/A
Report No.	:	PT800491160309E-FC01
<b>Prepared for</b>		
Shenzhen Chiptrip technology Co., Ltd.		
8F,VIA BUILDING,NO.9966,SHENNAN BOULEVARD,NANSHAN DISTRICT,		
SHENZHEN, GUANGDONG, CHINA.		
<b>Prepared by</b>		
DongGuan Precise Testing Service Co.,Ltd.		
Building D, Baoding Technology Park, Guangming Road 2, Guangming Community		
Dongcheng District, Dongguan, Guangdong, China		



TEST RESULT CERTIFICATION		
Applicant's name	:	Shenzhen Chiptrip technology Co., Ltd.
Address	:	8F, VIA BUILDING, NO.9966, SHENNAN BOULEVARD, NANSHAN DISTRICT, SHENZHEN, GUANGDONG, CHINA.
Manufacture's name	:	Shenzhen Chiptrip technology Co., Ltd.
Address	:	8F, VIA BUILDING, NO.9966, SHENNAN BOULEVARD, NANSHAN DISTRICT, SHENZHEN, GUANGDONG, CHINA.
Product name	:	Smart Media Player
Model name	:	F7,F7I
Standards	:	FCC CFR47 Part 15 Section 15.247
Test procedure	:	ANSI C63.10:2013, DA 00-705
Test Date	:	Apr. 03, 2016 ~ Apr.14, 2016
Date of Issue	:	Apr.15, 2016
Test Result	:	Pass
<p>This device described above has been tested by PTS, and the test results show that the equipment under test (EUT) is in compliance with the FCC requirements. And it is applicable only to the tested sample identified in the report.</p> <p>This report shall not be reproduced except in full, without the written approval of PTS, this document may be altered or revised by PTS, personal only, and shall be noted in the revision of the document.</p>		

Testing Engineer	
August Qiu	
Technical Manager	
Hack Ye	
Authorized Signatory	
Chris Du	



# Contents

	<b>Page</b>
<b>2 TEST SUMMARY.....</b>	<b>5</b>
<b>3 GENERAL INFORMATION.....</b>	<b>6</b>
3.1 GENERAL DESCRIPTION OF E.U.T.....	6
3.2 CHANNEL LIST .....	7
3.3 TEST MODE.....	7
3.4 TEST VOLTAGE .....	8
3.5 CONFIGURATION OF SYSTEM .....	8
<b>4 EQUIPMENT DURING TEST .....</b>	<b>9</b>
4.1 EQUIPMENTS LIST.....	9
4.2 DESCRIPTION OF SUPPORT UNITS.....	10
4.3 MEASUREMENT UNCERTAINTY.....	10
<b>5 CONDUCTED EMISSION.....</b>	<b>11</b>
5.1 E.U.T. OPERATION.....	11
5.2 EUT SETUP .....	11
5.3 MEASUREMENT DESCRIPTION.....	12
5.4 CONDUCTED EMISSION TEST RESULT .....	12
<b>6 RADIATED SPURIOUS EMISSIONS .....</b>	<b>14</b>
6.1 EUT OPERATION .....	14
6.2 TEST SETUP.....	15
6.3 SPECTRUM ANALYZER SETUP.....	16
6.4 TEST PROCEDURE.....	17
6.5 SUMMARY OF TEST RESULTS.....	18
<b>7 BAND EDGE MEASUREMENT .....</b>	<b>27</b>
7.1 TEST PROCEDURE.....	27
7.2 TEST RESULT.....	27
<b>8 20 DB BANDWIDTH MEASUREMENT .....</b>	<b>34</b>
8.1 TEST PROCEDURE.....	34
8.2 TEST RESULT.....	34
<b>9 MAXIMUM PEAK OUTPUT POWER .....</b>	<b>40</b>
9.1 TEST PROCEDURE.....	40
9.2 TEST RESULT.....	40
<b>10 HOPPING CHANNEL SEPARATION.....</b>	<b>46</b>



10.1	TEST PROCEDURE.....	46
10.2	TEST RESULT .....	46
<b>11</b>	<b>NUMBER OF HOPPING FREQUENCY.....</b>	<b>52</b>
11.1	TEST PROCEDURE.....	52
11.2	TEST RESULT .....	52
<b>12</b>	<b>DWELL TIME.....</b>	<b>53</b>
12.1	TEST PROCEDURE.....	53
12.2	TEST RESULT .....	53
<b>13</b>	<b>ANTENNA REQUIREMENT.....</b>	<b>56</b>
<b>14</b>	<b>TEST SETUP .....</b>	<b>57</b>
<b>15</b>	<b>EUT PHOTOS.....</b>	<b>59</b>



## 2 Test Summary

Test Items	Test Requirement	Result
Radiated Spurious Emissions	15.205(a) 15.209 15.247(d)	PASS
Band edge	15.247(d) 15.205(a)	PASS
Conduct Emission	15.207	PASS
20dB Bandwidth	15.247(a)(1)	PASS
Maximum Peak Output Power	15.247(b)(1)	PASS
Frequency Separation	15.247(a)(1)	PASS
Number of Hopping Frequency	15.247(a)(1)(iii)	PASS
Dwell time	15.247(a)(1)(iii)	PASS
Antenna Requirement	15.203	PASS

Remark:

N/A: Not Applicable



### 3 General Information

#### 3.1 General Description of E.U.T.

Product Name	:	Smart Media Player
Model Name	:	F7,F7I
Model Description	:	Just the model names are difference
Bluetooth Version	:	V4.0
Operating frequency	:	For BT(Normal) 2402-2480MHz, 79 channels For BLE: 2402-2480MHz, 40 channels For WIFI 802.11b/g/n-HT20:2412-2462MHz, 11 channels 802.11n-HT40: 2422-2452MHz:7 channels
Antenna installation:	:	Monopole Antenna
Antenna Gain:	:	1.25 dBi
Type of Modulation	:	For BT(Normal) GFSK, Pi/4DQPSK, 8DPSK For BLE: GFSK For WIFI: IEEE 802.11b CCK/QPSK/BPSK IEEE 802.11g BPSK/QPSK/16QAM/64QAM IEEE 802.11n-HT20/HT40 BPSK/QPSK/16QAM/64QAM
Power supply	:	DC 5V power by adapter
Adapter	:	Input:100-240V ~50/60Hz 0.5A max Output: DC 5V 2.0A



### 3.2 Channel List

BT(Normal)							
Channel	Frequency (MHz)	Channel	Frequency (MHz)	Channel	Frequency (MHz)	Channel	Frequency (MHz)
0	2402	1	2403	2	2404	3	2405
4	2406	5	2407	6	2408	7	2409
8	2410	9	2411	10	2412	11	2413
12	2414	13	2415	14	2416	15	2417
16	2418	17	2419	18	2420	19	2421
20	2422	21	2423	22	2424	23	2425
24	2426	25	2427	26	2428	27	2429
28	2430	29	2431	30	2432	31	2433
32	2434	33	2435	34	2436	35	2437
36	2438	37	2439	38	2440	39	2441
40	2442	41	2443	42	2444	43	2445
44	2446	45	2447	46	2448	47	2449
48	2450	49	2451	50	2452	51	2453
52	2454	53	2455	54	2456	55	2457
56	2458	57	2459	58	2460	59	2461
60	2462	61	2463	62	2464	63	2465
64	2466	65	2467	66	2468	67	2469
68	2470	69	2471	70	2472	71	2473
72	2474	73	2475	74	2476	75	2477
76	2478	77	2479	78	2480	-	-

### 3.3 Test Mode

All test mode(s) and condition(s) mentioned were considered and evaluated respectively by performing full tests, the worst data were recorded and reported.

Test mode	Low channel	Middle channel	High channel
Transmitting	2402MHz	2441MHz	2480MHz
Hopping	2402-2480MHz		
Tests Carried Out Under FCC part 15.207 & 15.209			
Test Item	Test Mode		
Conduction Emission, 0.15MHz to 30MHz	BT Communication		
Radiated Emission 30M-1GHz	BT Communication		



### 3.4 Test Voltage

Normal Test Voltage	Item
120V 60Hz	Conducted Emission & Radiated Emission
240V 60Hz	Conducted Emission & Radiated Emission

Remark: Only the worst case (120V 60Hz) was recorded in the report.

### 3.5 Configuration of System

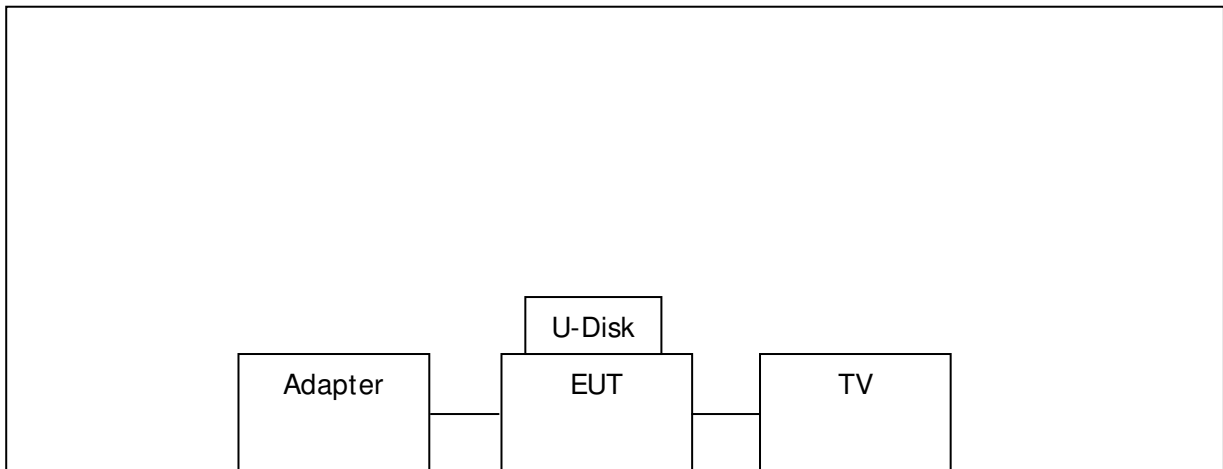





## 4 Equipment During Test

### 4.1 Equipments List

RF Conducted Test							
Item	Kind of Equipment	Manufacturer	Type No.	Serial No.	Last calibration	Calibrated until	Calibration period
1	EMC Analyzer (9k~26.5GHz)	Agilent	E4407B	MY45109572	Aug.04, 2015	Aug.03, 2016	1 year
2	EXA Signal Analyzer	Keysight	N9010A	MY50520207 526B25MPB W7X	Aug.04, 2015	Aug.03, 2016	1 year
3	EMI Test Receiver	R&S	ESCI	101155	July 15, 2015	July 14, 2016	1 year
Radiated Emissions							
Item	Kind of Equipment	Manufacturer	Type No.	Serial No.	Last calibration	Calibrated until	Calibration period
1	EMI Test Receiver	Rohde&Schwarz	ESCI	101417	July 15, 2015	July 14, 2016	1 year
2	Trilog Broadband Antenna	SCHWARZECK	VULB9160	9160-3355	July 15, 2015	July 14, 2016	1 year
3	Amplifier	EM	EM-30180	060538	July 15, 2015	July 14, 2016	1 year
4	Horn Antenna	SCHWARZECK	BBHA9120D	9120D-1246	July 15, 2015	July 14, 2016	1 year
Conducted Emissions							
Item	Kind of Equipment	Manufacturer	Type No.	Serial No.	Last calibration	Calibrated until	Calibration period
1	EMI Test Receiver	R&S	ESCI	101155	July 15, 2015	July 14, 2016	1 year
2	LISN	SCHWARZECK	NSLK 8128	8128-289	July 15, 2015	July 14, 2016	1 year
3	Cable	LARGE	RF300	-	July 15, 2015	July 14, 2016	1 year



### 4.2 Description of Support Units

Equipment	Manufacturer	Model No.	Series No.
TV	WanJia	CF-48H-18	CF754816
HDMI(shield 0.8m)	Viaip	C1016	HSC112
AC power line(1.0m)	WanJia	CF-18	CF0001
U-Disk	Kingston	DTSE9	UD001

### 4.3 Measurement Uncertainty

Parameter	Uncertainty
RF output power, conducted	±1.0dB
Power Spectral Density, conducted	±2.2dB
Radio Frequency	± 1 x 10 <sup>-6</sup>
Bandwidth	± 1.5 x 10 <sup>-6</sup>
Time	±2%
Duty Cycle	±2%
Temperature	±1°C
Humidity	±5%
DC and low frequency voltages	±3%
Conducted Emissions (150kHz~30MHz)	±3.64dB
Radiated Emission(30MHz~1GHz)	±5.03dB
Radiated Emission(1GHz~25GHz)	±4.74dB

## 5 Conducted Emission

Test Requirement: : FCC CFR 47 Part 15 Section 15.207

Test Method: : ANSI C63.10:2013

Test Result: : PASS

Frequency Range: : 150kHz to 30MHz

Class/Severity: : Class B

Limit: : 66-56 dB $\mu$ V between 0.15MHz & 0.5MHz  
 : 56 dB $\mu$ V between 0.5MHz & 5MHz  
 : 60 dB $\mu$ V between 5MHz & 30MHz

Detector: : Peak for pre-scan (9kHz Resolution Bandwidth)

### 5.1 E.U.T. Operation

Operating Environment :

Temperature: : 25.5 °C

Humidity: : 51 % RH

Atmospheric Pressure: : 101.2kPa

EUT Operation : : Refer to section 3.3

### 5.2 EUT Setup

The conducted emission tests were performed using the setup accordance with the ANSI C63.10:2013.

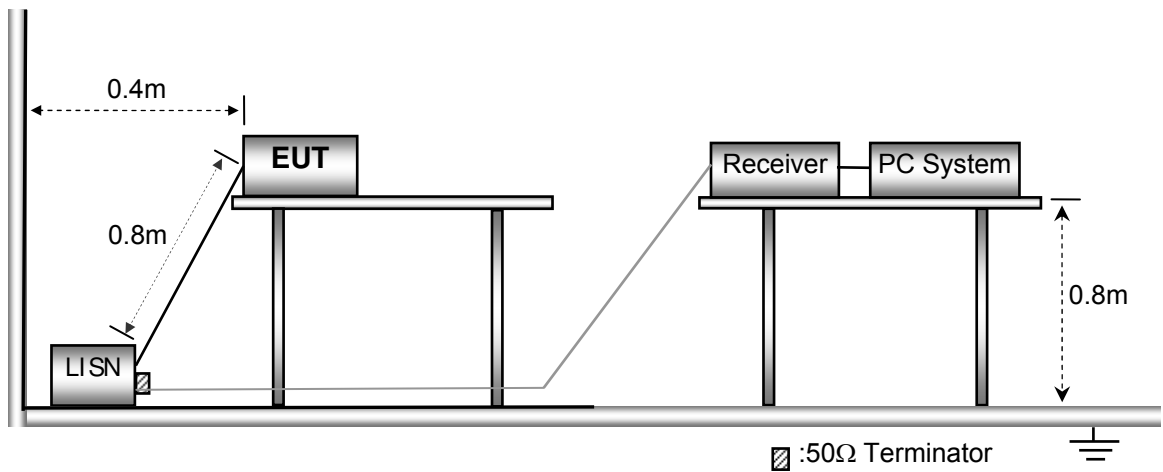



### 5.3 Measurement Description

The maximised peak emissions from the EUT was scanned and measured for both the Live and Neutral Lines. Quasi-peak & average measurements were performed if peak emissions were within 6dB of the average limit line.

### 5.4 Conducted Emission Test Result

Live line:

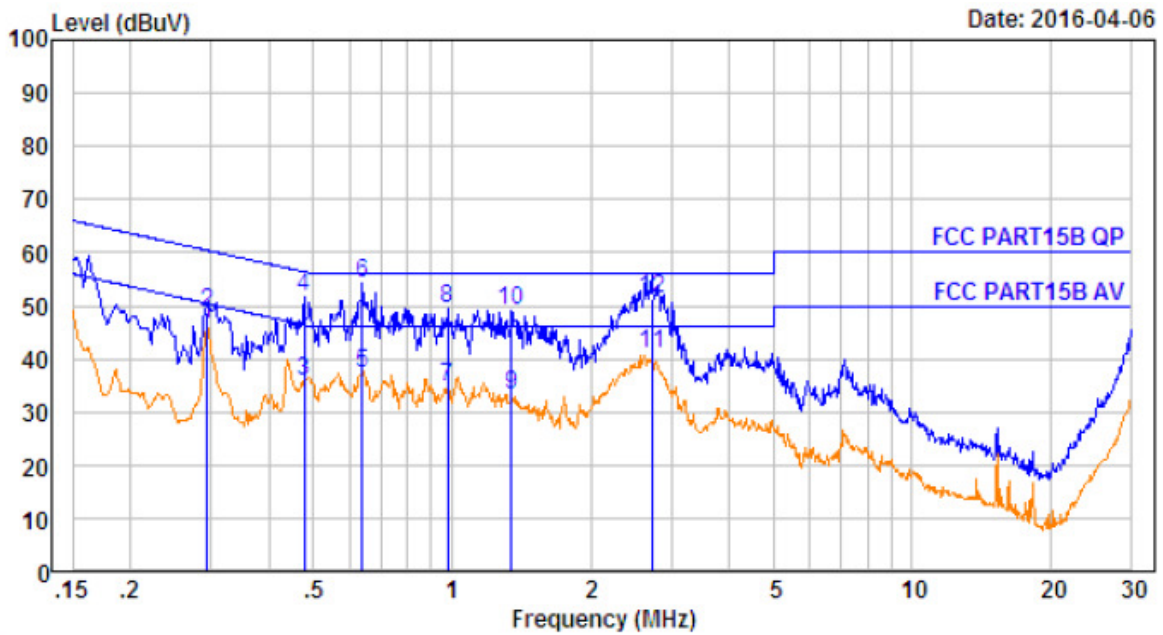

No.	Freq MHz	Cable Loss dB	AMN Factor dB	Receiver Reading dBUV	Emission Level dBUV	Limit dBUV	Over Limit dB	Remark
1.	0.294	10.63	0.60	35.20	46.43	50.41	-3.98	Average
2.	0.294	10.63	0.60	37.60	48.83	60.41	-11.58	QP
3.	0.479	10.64	0.60	24.40	35.64	46.36	-10.72	Average
4.	0.479	10.64	0.60	40.40	51.64	56.36	-4.72	QP
5.	0.637	10.66	0.60	26.03	37.29	46.00	-8.71	Average
6.	0.637	10.66	0.60	43.03	53.29	56.00	-2.71	QP
7.	0.979	10.67	0.60	23.35	34.62	46.00	-11.38	Average
8.	0.979	10.67	0.60	38.35	49.62	56.00	-6.38	QP
9.	1.345	10.68	0.60	21.77	33.05	46.00	-12.95	Average
10.	1.345	10.68	0.60	37.77	49.05	56.00	-6.95	QP
11.	2.721	10.71	0.60	29.50	40.81	46.00	-5.19	Average
12.	2.721	10.71	0.60	40.00	51.31	56.00	-4.69	QP



Neutral line:

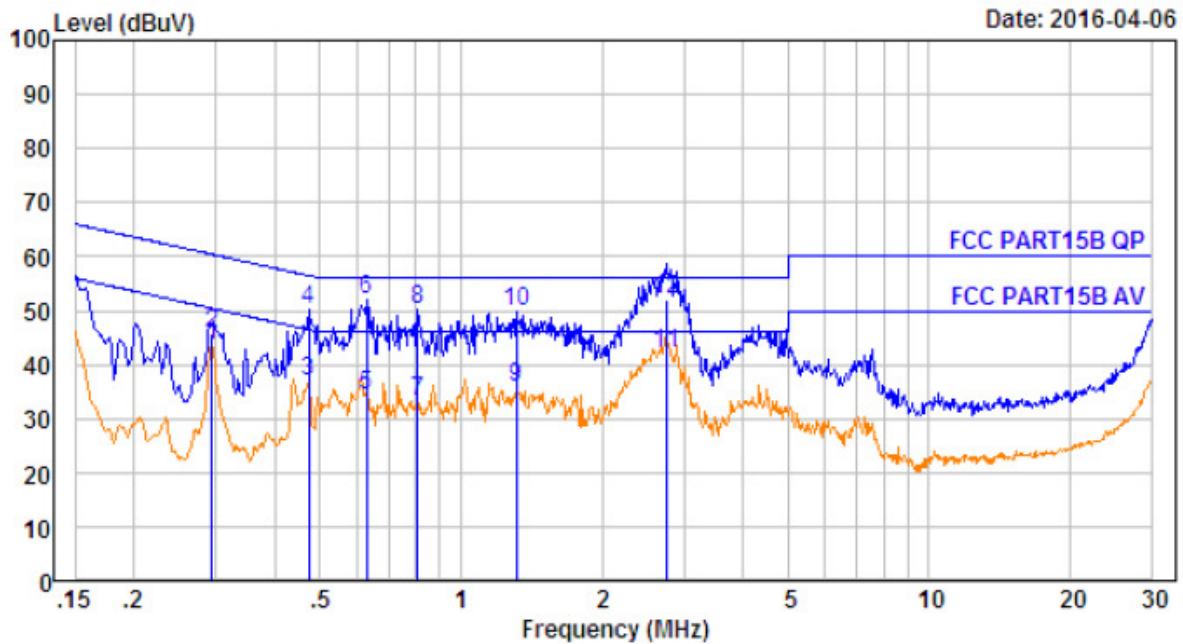

No.	Freq MHz	Cable Loss dB	AMN Factor dB	Receiver Reading dBuV	Emission Level dBuV	Limit dBuV	Over Limit dB	Remark
1.	0.294	10.63	0.60	32.40	43.63	50.41	-6.78	Average
2.	0.294	10.63	0.60	34.50	45.73	60.41	-14.68	QP
3.	0.474	10.64	0.60	25.79	37.03	46.45	-9.42	Average
4.	0.474	10.64	0.60	38.79	50.03	56.45	-6.42	QP
5.	0.630	10.66	0.60	22.91	34.17	46.00	-11.83	Average
6.	0.630	10.66	0.60	40.91	52.17	56.00	-3.83	QP
7.	0.809	10.66	0.60	21.80	33.06	46.00	-12.94	Average
8.	0.809	10.66	0.60	38.80	50.06	56.00	-5.94	QP
9.	1.317	10.68	0.60	24.38	35.66	46.00	-10.34	Average
10.	1.317	10.68	0.60	38.38	49.66	56.00	-6.34	QP
11.	2.750	10.71	0.60	30.60	41.91	46.00	-4.09	Average
12.	2.750	10.71	0.60	40.80	52.11	56.00	-3.89	QP



## 6 Radiated Spurious Emissions

Test Requirement: : FCC CFR47 Part 15 Section 15.209 & 15.247  
 Test Method: : ANSI C63.10:2013,DA 00-705  
 Test Result: : PASS  
 Measurement Distance: : 3m  
 Limit: : See the follow table

Frequency (MHz)	Field Strength		Field Strength Limit at 3m Measurement Dist	
	uV/m	Distance (m)	uV/m	dBuV/m
0.009 ~ 0.490	$2400/F(\text{kHz})$	300	$10000 * 2400/F(\text{kHz})$	$20\log^{(2400/F(\text{kHz}))} + 80$
0.490 ~ 1.705	$24000/F(\text{kHz})$	30	$100 * 24000/F(\text{kHz})$	$20\log^{(24000/F(\text{kHz}))} + 40$
1.705 ~ 30	30	30	$100 * 30$	$20\log^{(30)} + 40$
30 ~ 88	100	3	100	$20\log^{(100)}$
88 ~ 216	150	3	150	$20\log^{(150)}$
216 ~ 960	200	3	200	$20\log^{(200)}$
Above 960	500	3	500	$20\log^{(500)}$

### 6.1 EUT Operation

Operating Environment :  
 Temperature: : 23.5 °C  
 Humidity: : 51.1 % RH  
 Atmospheric Pressure: : 101.2kPa  
 EUT Operation : : Refer to section 3.3

### 6.2 Test Setup

The radiated emission tests were performed in the 3m Semi- Anechoic Chamber test site

The test setup for emission measurement below 30MHz.

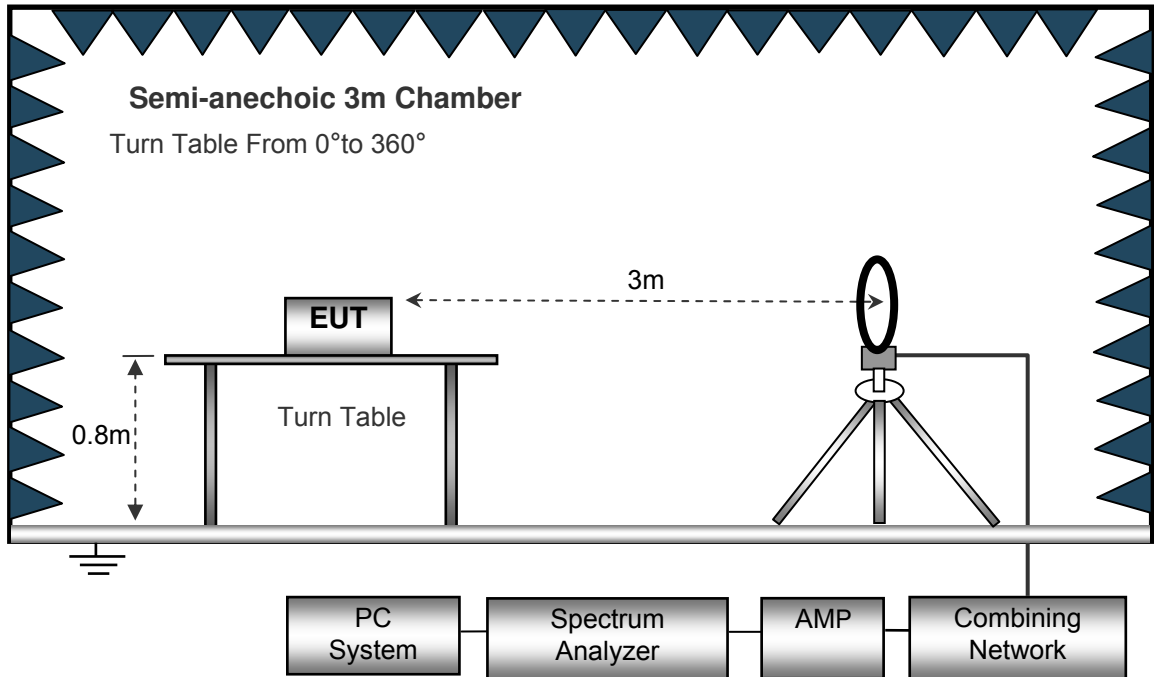

The test setup for emission measurement from 30 MHz to 1 GHz.

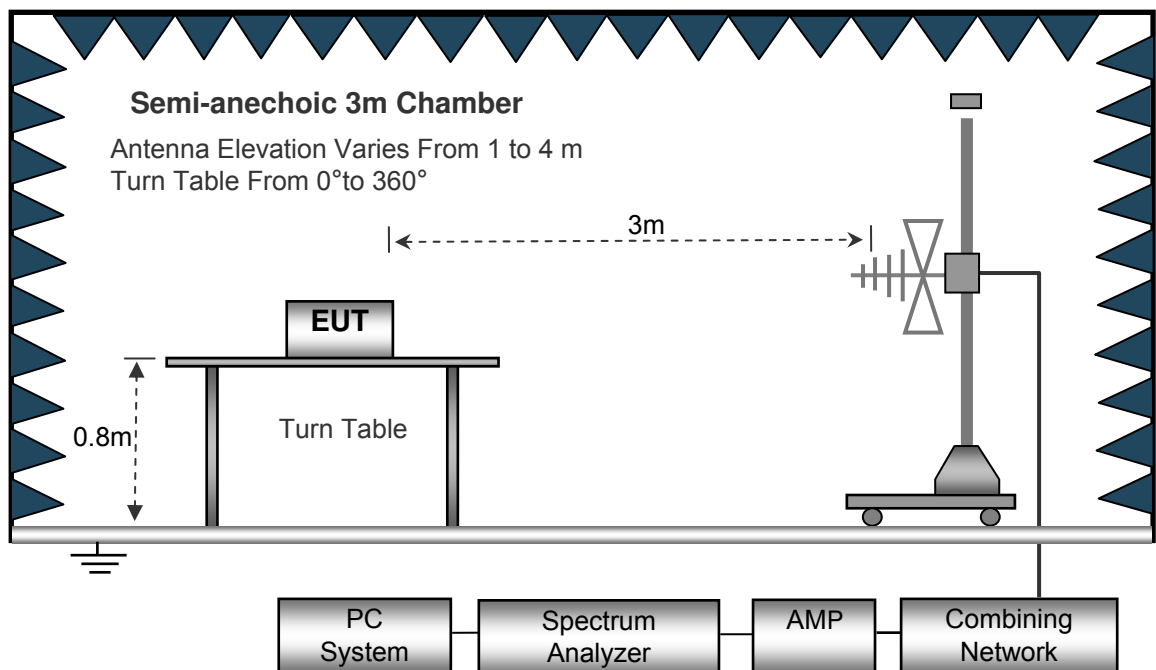

The test setup for emission measurement above 1 GHz.

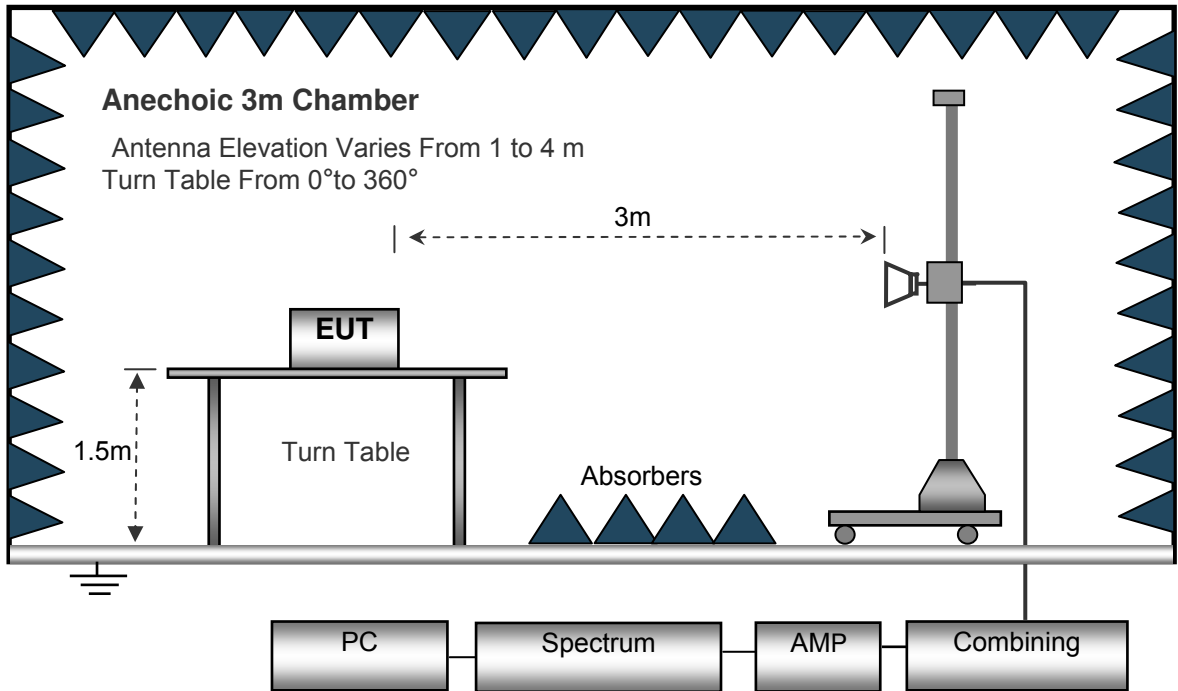

### 6.3 Spectrum Analyzer Setup

Below 30MHz

- Sweep Speed..... Auto
- IF Bandwidth.....10kHz
- Video Bandwidth .....10kHz
- Resolution Bandwidth .....10kHz

30MHz ~ 1GHz

- Sweep Speed..... Auto
- Detector.....PK
- Resolution Bandwidth .....100kHz
- Video Bandwidth .....300kHz

Above 1GHz

- Sweep Speed..... Auto
- Detector.....PK
- Resolution Bandwidth .....1MHz
- Video Bandwidth .....3MHz
- Detector.....Ave.
- Resolution Bandwidth .....1MHz
- Video Bandwidth .....10Hz





## 6.4 Test Procedure

1. The EUT is placed on a turntable, which is 0.8m above ground plane for below 1GHz and 1.5m for above 1GHz.
2. The turntable shall be rotated for 360 degrees to determine the position of maximum emission level.
3. EUT is set 3m away from the receiving antenna, which is moved from 1m to 4m to find out the maximum emissions. The spectrum was investigated from the lowest radio frequency signal generated in the device, without going below 9 kHz, up to the tenth harmonic of the highest fundamental frequency or to 40 GHz, whichever is lower.
4. Maximum procedure was performed on the six highest emissions to ensure EUT compliance.
5. And also, each emission was to be maximized by changing the polarization of receiving antenna both horizontal and vertical.
6. Repeat above procedures until the measurements for all frequencies are complete.
7. The radiation measurements are tested under 3-axes(X,Y,Z) position(X denotes lying on the table, Y denotes side stand and Z denotes vertical stand), After pre-test, It was found that the worse radiation emission was get at the X position. So the data shown was the X position only.



### 6.5 Summary of Test Results

#### Test Frequency: Below 30MHz

The measurements were more than 30 dB below the limit and not reported.

#### Test Frequency: 30MHz ~ 1GHz

Antenna Polarization: Horizontal

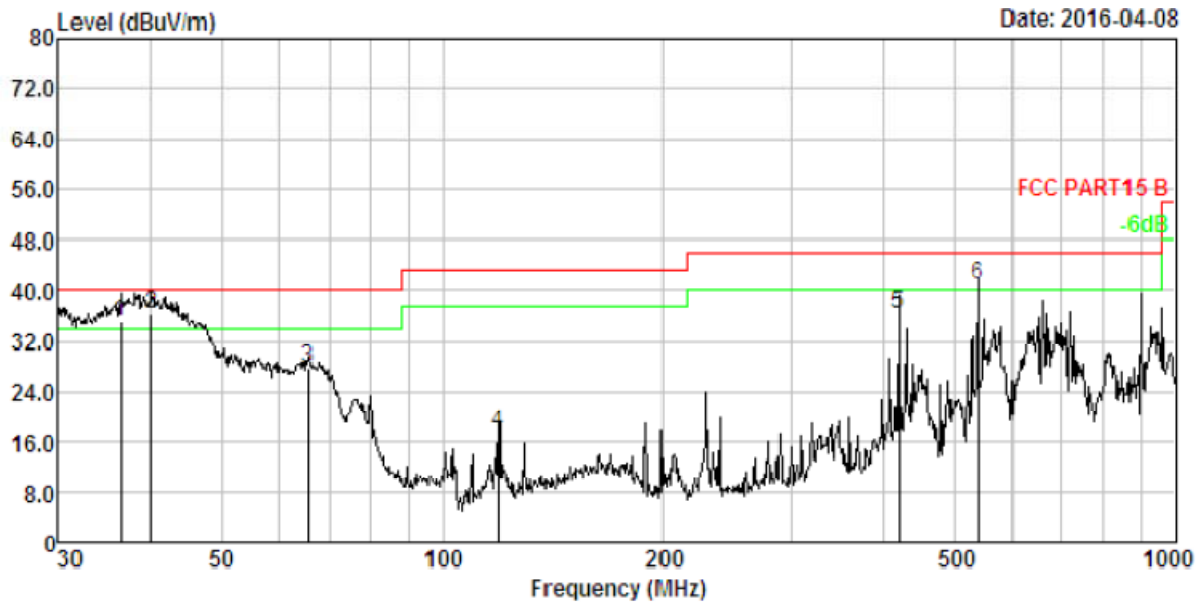

No.	Freq MHz	Cable Loss dB	ANT Factor dB/m	Receiver Reading dBUV	Preamp Factor dB	Emission Level dBUV/m	Limit dBUV/m	Over Limit dB	Remark
1.	36.381	1.23	13.46	50.50	30.04	35.15	40.00	-4.85	QP
2.	40.135	1.32	13.70	51.49	30.07	36.44	40.00	-3.56	QP
3.	65.803	1.77	11.53	44.55	30.24	27.61	40.00	-12.39	QP
4.	119.436	2.31	11.98	33.48	30.45	17.32	43.50	-26.18	QP
5.	419.108	3.44	15.68	48.03	30.89	36.26	46.00	-9.74	QP
6.	539.478	3.67	17.67	50.65	30.98	41.01	46.00	-4.99	QP



Antenna Polarization: Vertical

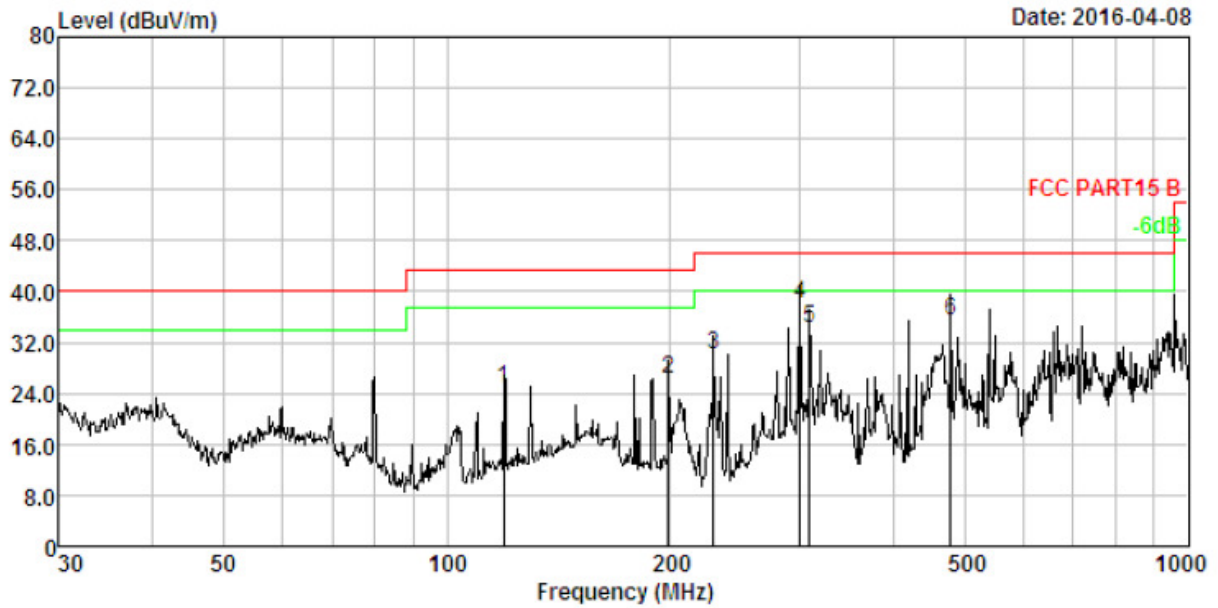

No.	Freq MHz	Cable Loss dB	ANT Factor dB/m	Receiver Reading dBuV	Preamp Factor dB	Emission Level dBuV/m	Limit dBuV/m	Over Limit dB	Remark
1.	119.436	2.31	11.98	40.88	30.45	24.72	43.50	-18.78	QP
2.	199.286	2.77	10.43	43.64	30.63	26.21	43.50	-17.29	QP
3.	229.293	2.90	11.21	46.59	30.68	30.02	46.00	-15.98	QP
4.	299.316	3.14	13.18	52.63	30.77	38.18	46.00	-7.82	QP
5.	308.913	3.17	13.40	48.48	30.78	34.27	46.00	-11.73	QP
6.	478.846	3.56	16.87	45.95	30.93	35.45	46.00	-10.55	QP



**Test Frequency: 1GHz ~ 18GHz**

Frequency	Receiver Reading	Detector	Corrected Factor	Corrected Amplitude	Limit	Margin
(MHz)	(dBμV)	(PK/QP/Ave)	(dB)	(dBμV/m)	(dBμV/m)	(dB)
GFSK Low Channel						
Harmonic & Spurious Emission						
1134.21	49.45	PK	-19.51	29.94	74.00	-44.06
1134.21	44.65	Ave	-19.51	25.14	54.00	-28.86
4804.00	50.08	PK	-1.06	49.02	74.00	-24.98
4804.00	42.59	Ave	-1.06	41.53	54.00	-12.47
7206.00	48.58	PK	1.33	49.91	74.00	-24.09
7206.00	43.14	Ave	1.33	44.47	54.00	-9.53
Restricted bands Emission						
2330.13	48.71	PK	-13.19	35.52	74.00	-38.48
2330.13	43.60	Ave	-13.19	30.41	54.00	-23.59
2711.03	49.22	PK	-12.54	36.68	74.00	-37.32
2711.03	47.51	Ave	-12.54	34.97	54.00	-19.03
3336.21	48.45	PK	-10.89	37.56	74.00	-36.44
3336.21	44.28	Ave	-10.89	33.39	54.00	-20.61
Remark:						
1. Corrected Factor=ANT Factor + Cable Loss – Amp Gain						



Frequency	Receiver Reading	Detector	Corrected Factor	Corrected Amplitude	Limit	Margin
(MHz)	(dBμV)	(PK/QP/Ave)	(dB)	(dBμV/m)	(dBμV/m)	(dB)
GFSK Middle Channel						
Harmonic & Spurious Emission						
1134.21	50.22	PK	-19.51	30.71	74.00	-43.29
1134.21	45.60	Ave	-19.51	26.09	54.00	-27.91
4882.00	49.16	PK	-0.93	48.23	74.00	-25.77
4882.00	41.61	Ave	-0.93	40.68	54.00	-13.32
7323.00	49.11	PK	1.67	50.78	74.00	-23.22
7323.00	42.36	Ave	1.67	44.03	54.00	-9.97
Restricted bands Emission						
2345.99	48.54	PK	-13.19	35.35	74.00	-38.65
2345.99	42.69	Ave	-13.19	29.50	54.00	-24.50
2713.93	49.55	PK	-12.54	37.01	74.00	-36.99
2713.93	46.83	Ave	-12.54	34.29	54.00	-19.71
3334.52	47.55	PK	-10.89	36.66	74.00	-37.34
3334.52	44.97	Ave	-10.89	34.08	54.00	-19.92
Remark:						
1. Corrected Factor=ANT Factor + Cable Loss – Amp Gain						



Frequency	Receiver Reading	Detector	Corrected Factor	Corrected Amplitude	Limit	Margin
(MHz)	(dBμV)	(PK/QP/Ave)	(dB)	(dBμV/m)	(dBμV/m)	(dB)
GFSK High Channel						
Harmonic & Spurious Emission						
1134.21	48.42	PK	-19.51	28.91	74.00	-45.09
1134.21	44.46	Ave	-19.51	24.95	54.00	-29.05
4960.00	51.80	PK	-0.87	50.93	74.00	-23.07
4960.00	40.95	Ave	-0.87	40.08	54.00	-13.92
7440.00	49.68	PK	1.84	51.52	74.00	-22.48
7440.00	43.10	Ave	1.84	44.94	54.00	-9.06
Restricted bands Emission						
2321.52	48.48	PK	-13.19	35.29	74.00	-38.71
2321.52	43.59	Ave	-13.19	30.40	54.00	-23.60
2718.58	49.01	PK	-12.54	36.47	74.00	-37.53
2718.58	46.55	Ave	-12.54	34.01	54.00	-19.99
3334.53	48.41	PK	-10.89	37.52	74.00	-36.48
3334.53	43.75	Ave	-10.89	32.86	54.00	-21.14
Remark:						
1. Corrected Factor=ANT Factor + Cable Loss – Amp Gain						



Frequency	Receiver Reading	Detector	Corrected Factor	Corrected Amplitude	Limit	Margin
(MHz)	(dBμV)	(PK/QP/Ave)	(dB)	(dBμV/m)	(dBμV/m)	(dB)
8DPSK Low Channel						
Harmonic & Spurious Emission						
1231.27	49.01	PK	-18.67	30.34	74.00	-43.66
1231.27	45.34	Ave	-18.67	26.67	54.00	-27.33
4804.00	50.16	PK	-1.06	49.10	74.00	-24.90
4804.00	43.45	Ave	-1.06	42.39	54.00	-11.61
7206.00	48.82	PK	1.33	50.15	74.00	-23.85
7206.00	43.56	Ave	1.33	44.89	54.00	-9.11
Restricted bands Emission						
2346.61	51.79	PK	-13.19	38.60	74.00	-35.40
2346.61	42.04	Ave	-13.19	28.85	54.00	-25.15
2715.50	51.40	PK	-12.54	38.86	74.00	-35.14
2715.50	45.92	Ave	-12.54	33.38	54.00	-20.62
3333.74	47.27	PK	-10.89	36.38	74.00	-37.62
3333.74	43.99	Ave	-10.89	33.10	54.00	-20.90
Remark:						
1. Corrected Factor=ANT Factor + Cable Loss – Amp Gain						



Frequency	Receiver Reading	Detector	Corrected Factor	Corrected Amplitude	Limit	Margin
(MHz)	(dBμV)	(PK/QP/Ave)	(dB)	(dBμV/m)	(dBμV/m)	(dB)
8DPSK Middle Channel						
Harmonic & Spurious Emission						
1231.27	48.17	PK	-18.67	29.50	74.00	-44.50
1231.27	45.19	Ave	-18.67	26.52	54.00	-27.48
4882.00	49.95	PK	-0.93	49.02	74.00	-24.98
4882.00	42.87	Ave	-0.93	41.94	54.00	-12.06
7323.00	49.00	PK	1.67	50.67	74.00	-23.33
7323.00	43.21	Ave	1.67	44.88	54.00	-9.12
Restricted bands Emission						
2349.93	49.99	PK	-13.19	36.80	74.00	-37.20
2349.93	42.12	Ave	-13.19	28.93	54.00	-25.07
2695.20	52.28	PK	-12.54	39.74	74.00	-34.26
2695.20	47.16	Ave	-12.54	34.62	54.00	-19.38
3338.51	46.92	PK	-10.89	36.03	74.00	-37.97
3338.51	44.40	Ave	-10.89	33.51	54.00	-20.49
Remark:						
1. Corrected Factor=ANT Factor + Cable Loss – Amp Gain						





Frequency	Receiver Reading	Detector	Corrected Factor	Corrected Amplitude	Limit	Margin
(MHz)	(dBμV)	(PK/QP/Ave)	(dB)	(dBμV/m)	(dBμV/m)	(dB)
8DPSK High Channel						
Harmonic & Spurious Emission						
1231.27	47.42	PK	-18.67	28.75	74.00	-45.25
1231.27	45.15	Ave	-18.67	26.48	54.00	-27.52
4960.00	49.44	PK	-0.87	48.57	74.00	-25.43
4960.00	42.19	Ave	-0.87	41.32	54.00	-12.68
7440.00	48.28	PK	1.84	50.12	74.00	-23.88
7440.00	42.41	Ave	1.84	44.25	54.00	-9.75
Restricted bands Emission						
2339.61	48.65	PK	-13.19	35.46	74.00	-38.54
2339.61	43.33	Ave	-13.19	30.14	54.00	-23.86
2697.68	50.51	PK	-12.54	37.97	74.00	-36.03
2697.68	47.05	Ave	-12.54	34.51	54.00	-19.49
3335.55	47.24	PK	-10.89	36.35	74.00	-37.65
3335.55	45.04	Ave	-10.89	34.15	54.00	-19.85
Remark:						
1. Corrected Factor=ANT Factor + Cable Loss – Amp Gain						



**Radiated band edge:**

Frequency	Receiver Reading	Detector	Corrected Factor	Corrected Amplitude	Limit	Margin
(MHz)	(dBµV)	(PK/QP/Ave)	(dB)	(dBµV/m)	(dBµV/m)	(dB)
<b>GFSK</b>						
2400.00	49.44	PK	-13.12	36.32	74.00	-37.68
2400.00	42.19	PK	-13.12	29.07	74.00	-44.93
2483.50	48.28	PK	-13.06	35.22	74.00	-38.78
2483.50	42.41	PK	-13.06	29.35	74.00	-44.65
<b>8DPSK</b>						
2400.00	49.94	PK	-13.12	36.82	74.00	-37.18
2400.00	42.67	PK	-13.12	29.55	74.00	-44.45
2483.50	47.06	PK	-13.06	34.00	74.00	-40.00
2483.50	43.64	PK	-13.06	30.58	74.00	-43.42
Remark: The PK margin is below the AV limit, the AV value was not recorded.						

**Test Frequency: 18-25GHz**

The measurements were more than 30 dB below the limit and not reported

- Remark :
1. The testing has been conformed to 10\*2480 =24800MHz.
  2. All other emissions more than 30dB below the limit
  - 3: Only the worst data (GFSK/8DPSK modulation mode) were reported.



## 7 Band Edge Measurement

- Test Requirement : Section 15.247(d) In addition, radiated emissions which fall in the restricted bands. as defined in Section 15.205(a), must also comply with the radiated emission limits specified in Section 15.209(a) (see Section 15.205(c)).
- Test Method : ANSI C63.10:2013,DA 00-705
- Test Limit : Regulation 15.247 (d),In any 100 kHz bandwidth outside the frequency band in which the spread spectrum or digitally modulated intentional radiator is operating, the radio frequency power that is produced by the intentional radiator shall be at least 20 dB below that in the 100 kHz bandwidth within the band that contains the highest level of the desired power, based on either an RF conducted or a radiated measurement, provided the transmitter demonstrates compliance with the peak conducted power limits. If the transmitter complies with the conducted power limits based on the use of RMS averaging over a time interval, as permitted under paragraph (b)(3) of this section, the attenuation required under this paragraph shall be 30 dB instead of 20 dB. Attenuation below the general limits specified in §15.209(a) is not required. In addition, radiated emissions which fall in the restricted bands, as defined in §15.205(a), must also comply with the radiated emission limits specified in §15.209(a) (see §15.205(c)).
- Test Mode : Transmitting & Hopping
- Remark : The worst case was recorded.

### 7.1 Test Procedure

1. Remove the antenna from the EUT and then connect a low RF cable from the antenna port to the spectrum;

2. Set the spectrum analyzer: RBW = 100kHz, VBW = 300kHz, Sweep = auto

Detector function = peak, Trace = max hold

### 7.2 Test Result

Modulation	Mode	Band edge	Value	Limit	Result
GFSK	Transmitting	Left	-42.47	-15.41	Pass
		Right	-55.14	-15.15	Pass
	Hopping	Left	-44.02	-14.52	Pass
		Right	-49.09	-15.39	Pass
Pi/4 DQPSK	Transmitting	Left	-47.80	-18.52	Pass
		Right	-58.15	-17.76	Pass
	Hopping	Left	-50.52	-17.39	Pass
		Right	-51.67	-17.93	Pass
8DPSK	Transmitting	Left	-48.01	-18.55	Pass
		Right	-56.43	-17.71	Pass
	Hopping	Left	-47.77	-17.25	Pass
		Right	-52.33	-19.84	Pass
Remark:					
The limit is 20dB below the maximum peak level, please refer to the display line of the follow plot					

TX in GFSK Band edge-left side

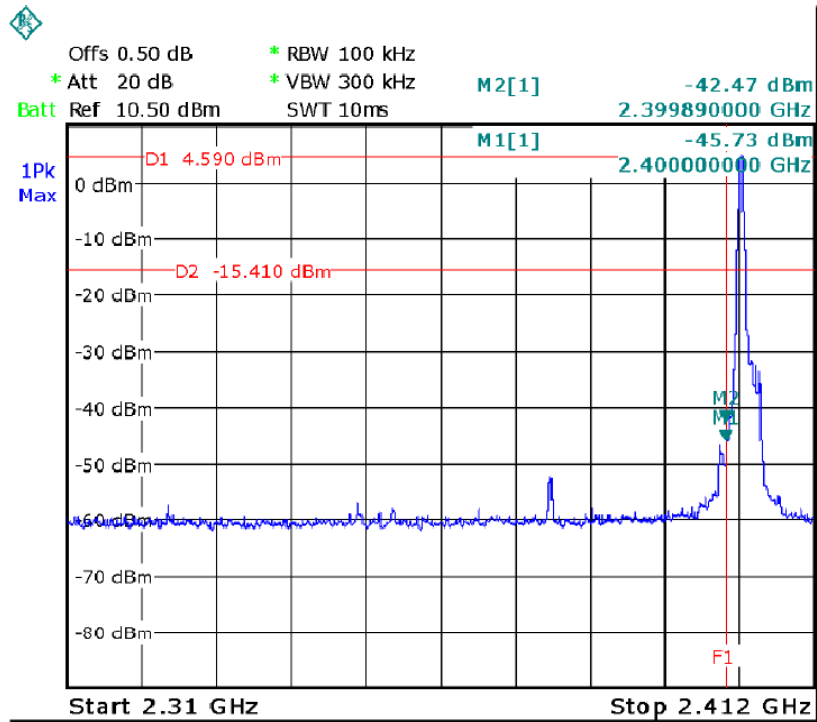

TX in GFSK Band edge-right side

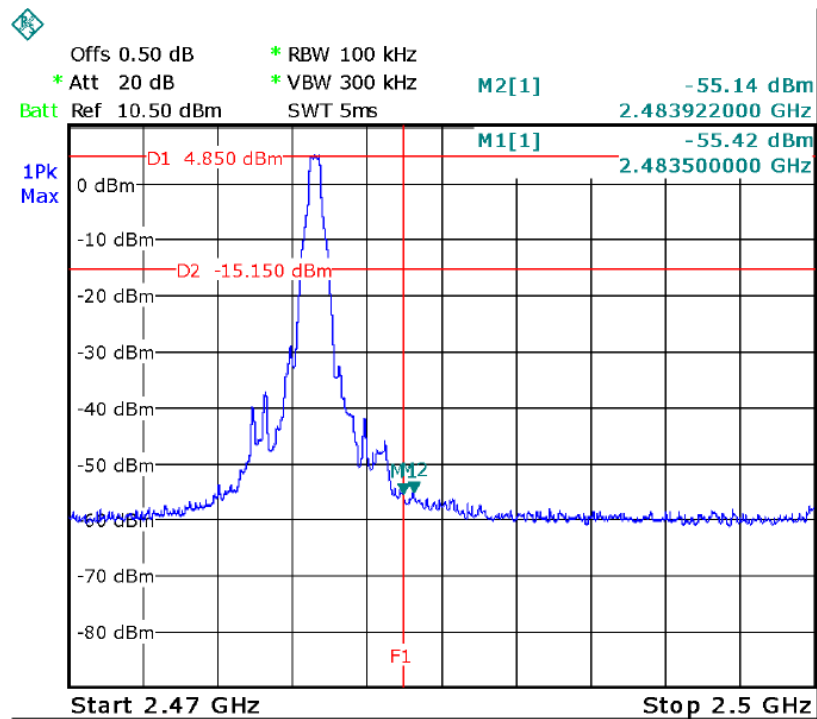

TX in Pi/4 DQPSK Band edge-left side

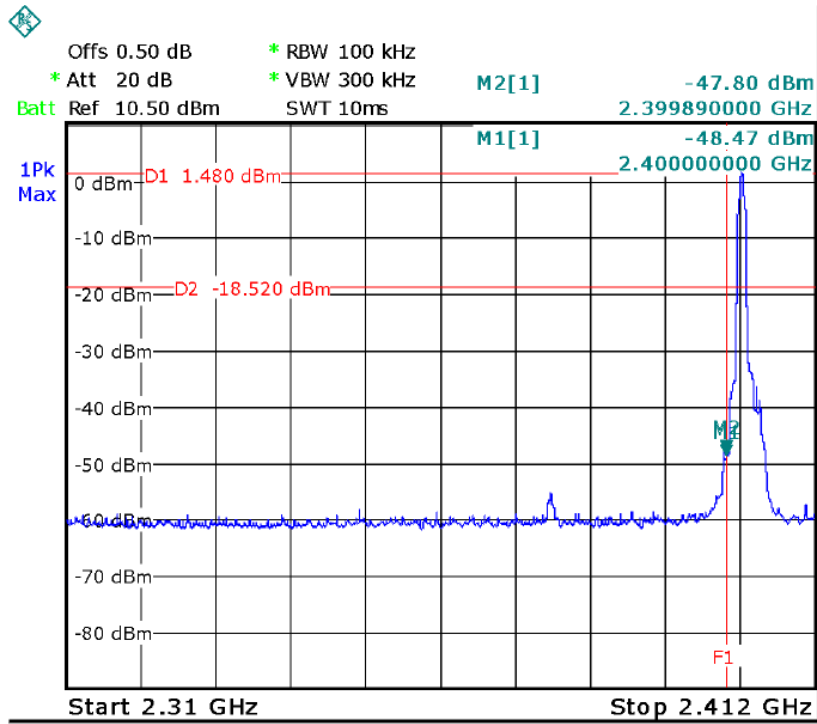

TX in Pi/4 DQPSK Band edge-right side

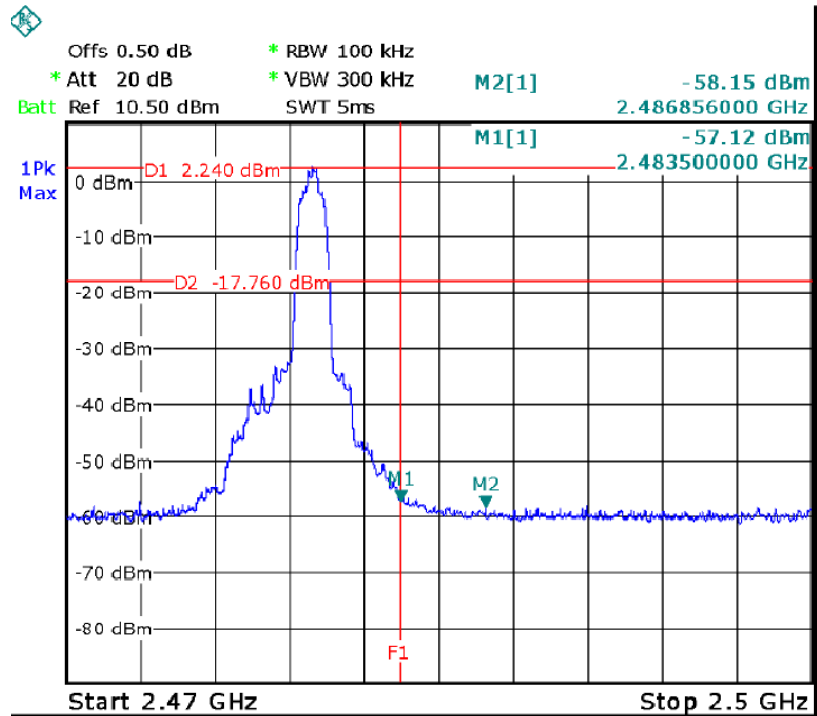

TX in 8DPSK Band edge-left side

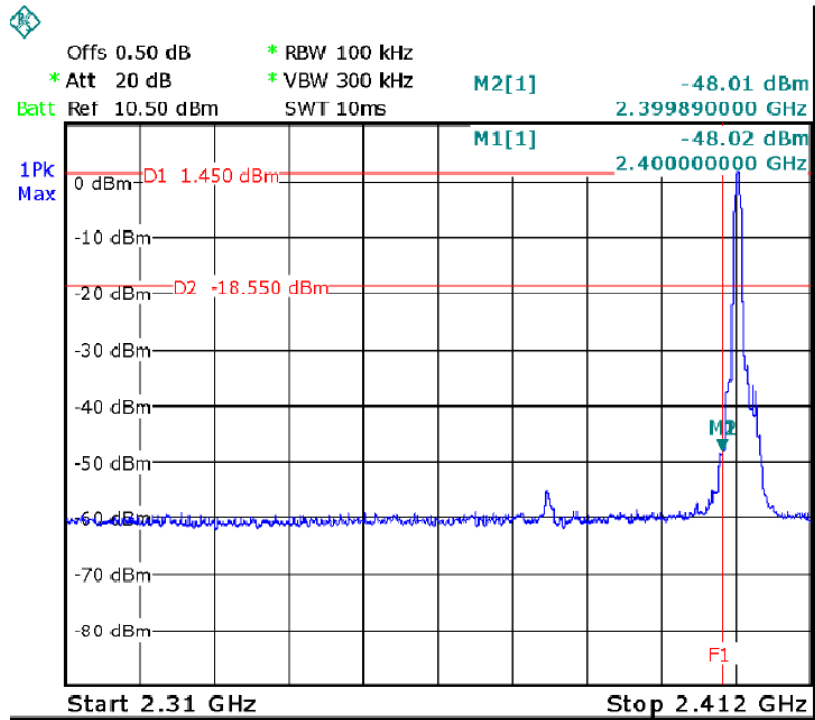

TX in 8DPSK Band edge-right side

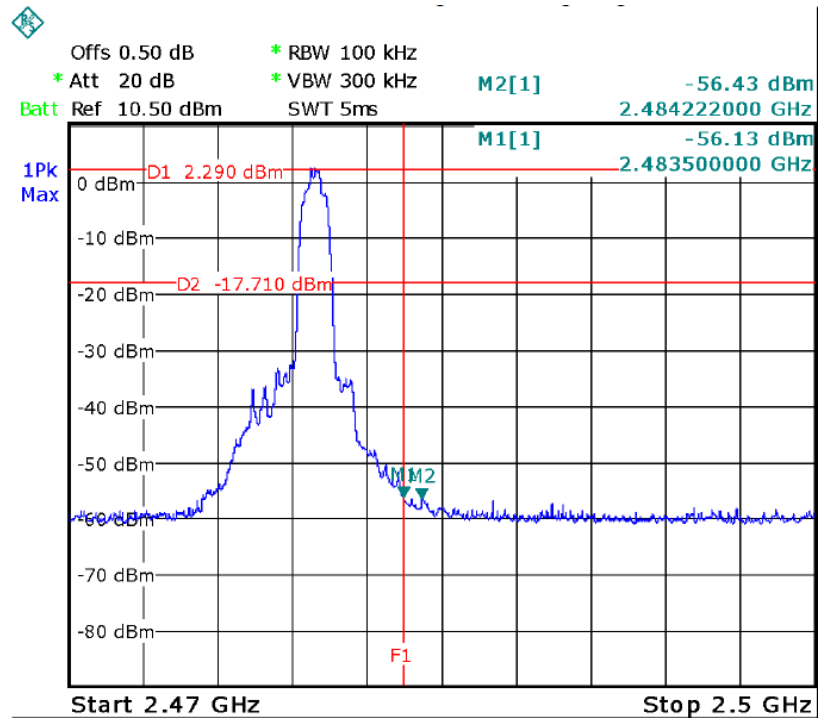

Hopping in GFSK Band edge-left side

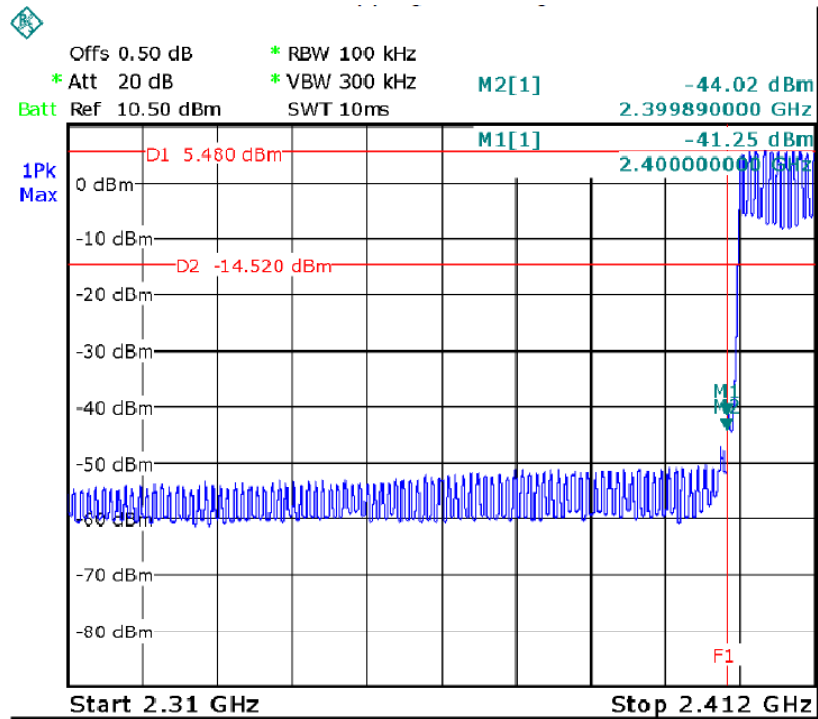

Hopping in GFSK Band edge-right side

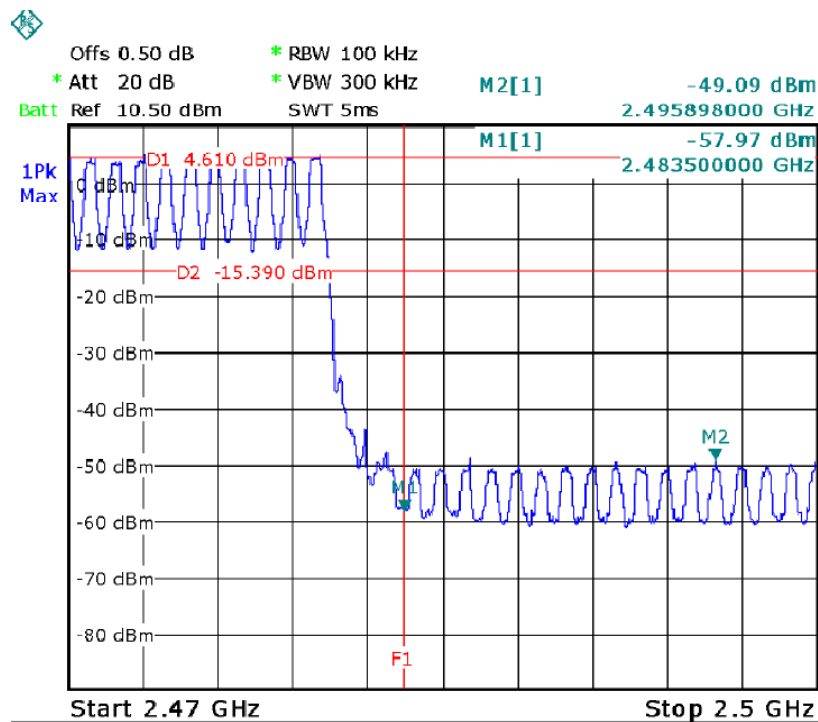

Hopping in Pi/4 DQPSK Band edge-left side

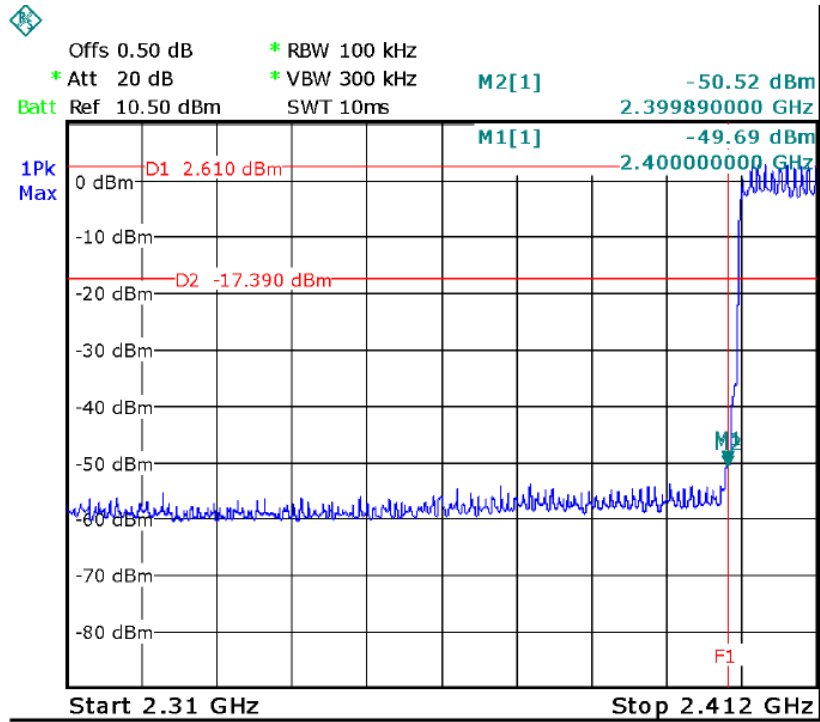

Hopping in Pi/4 DQPSK Band edge-right side

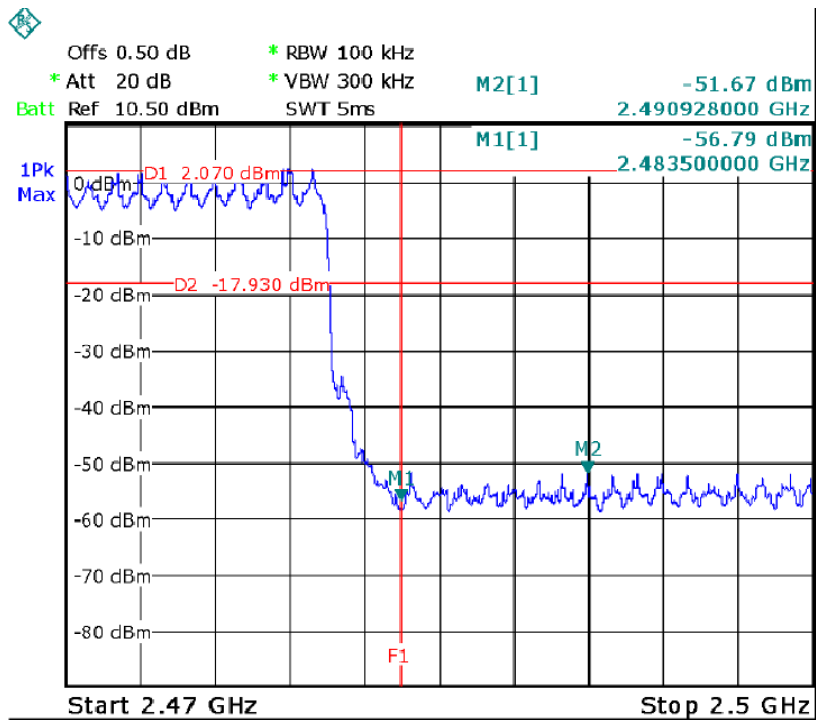



Hopping in 8DPSK Band edge-left side

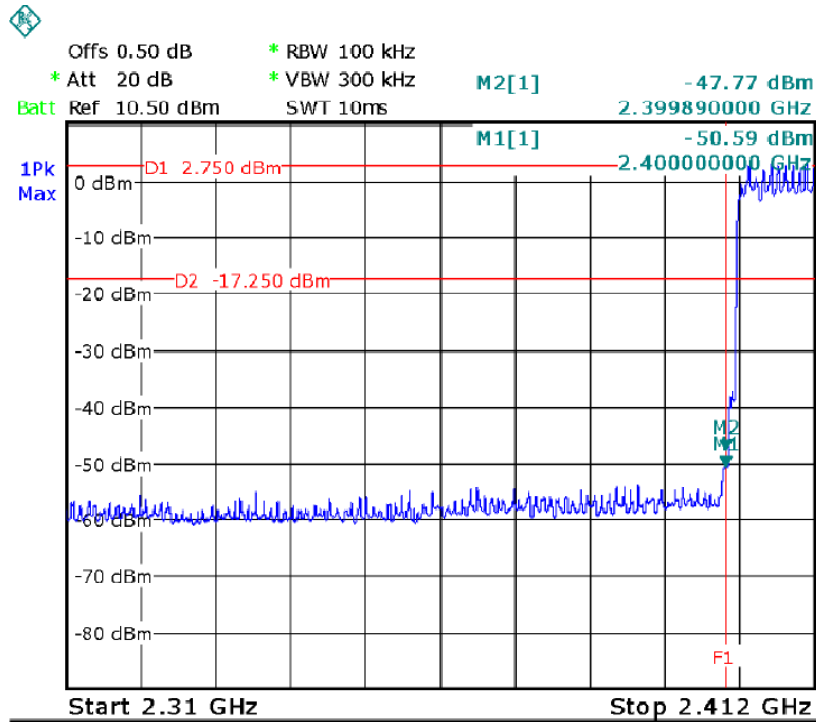

Hopping in 8DPSK Band edge-right side

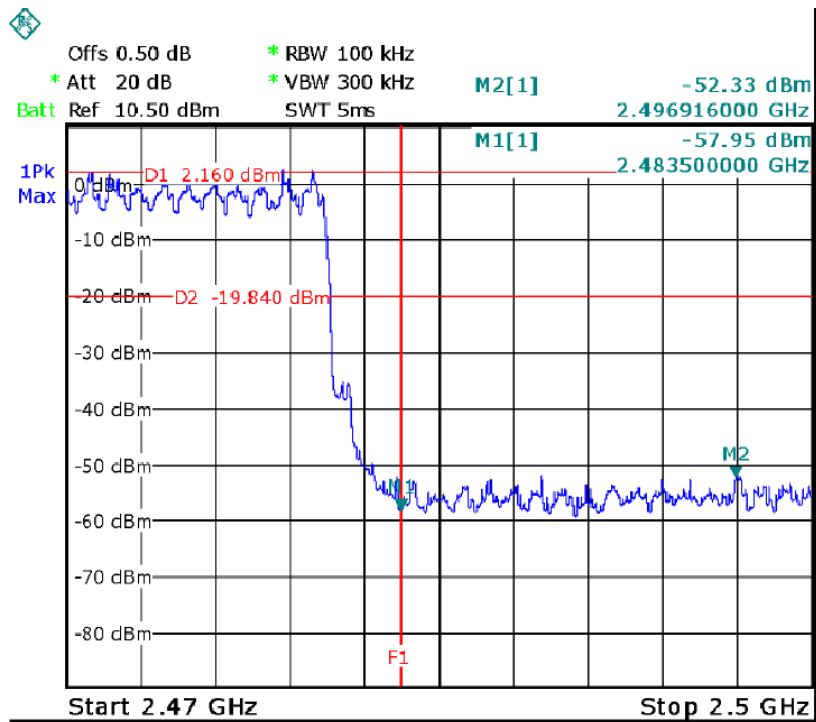



## 8 20 dB Bandwidth Measurement

Test Requirement : FCC CFR47 Part 15 Section 15.247  
Test Method : ANSI C63.10:2013, DA 00-705  
Test Mode : Refer to section 3.3

### 8.1 Test Procedure

1. Remove the antenna from the EUT and then connect a low RF cable from the antenna port to the spectrum;
2. Set the spectrum analyzer: RBW = 30kHz, VBW = 100kHz

### 8.2 Test Result

Modulation	Test Channel	Bandwidth(MHz)
GFSK	Low	0.952
GFSK	Middle	0.952
GFSK	High	0.952
Pi/4 DQPSK	Low	1.270
Pi/4 DQPSK	Middle	1.270
Pi/4 DQPSK	High	1.270
8DPSK	Low	1.275
8DPSK	Middle	1.275
8DPSK	High	1.275

GFSK Low Channel

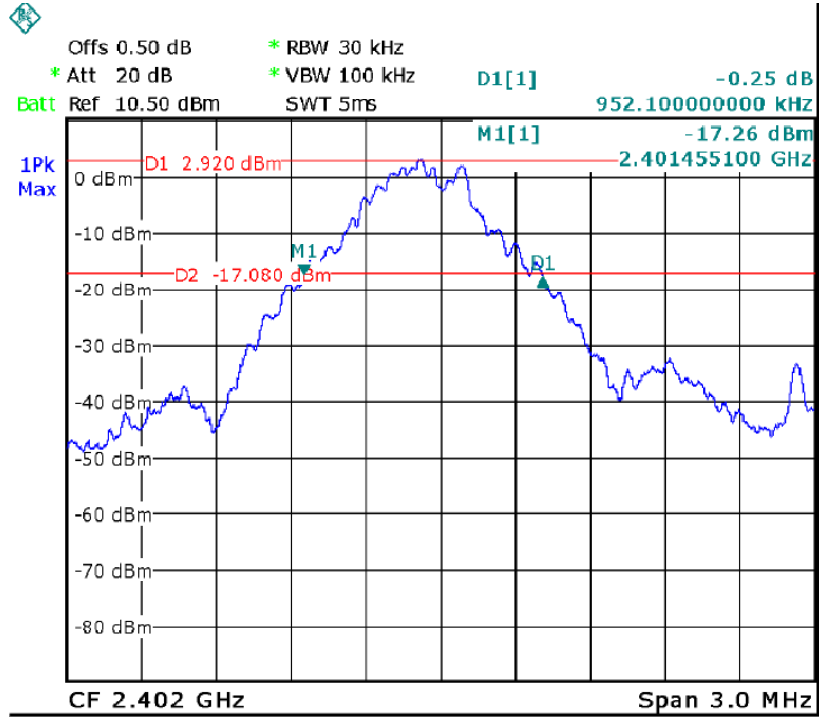

GFSK Middle Channel

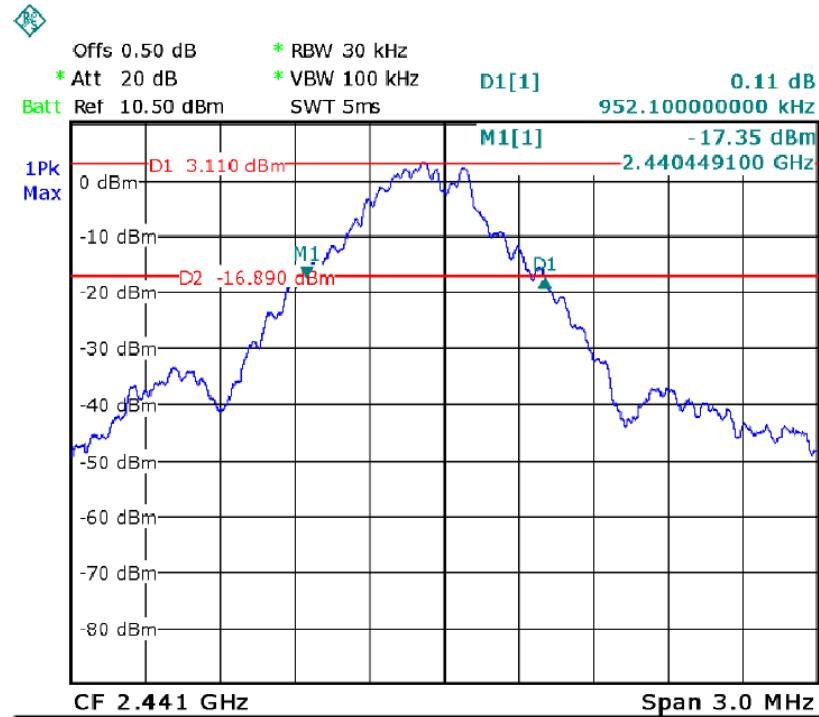

### GFSK High Channel

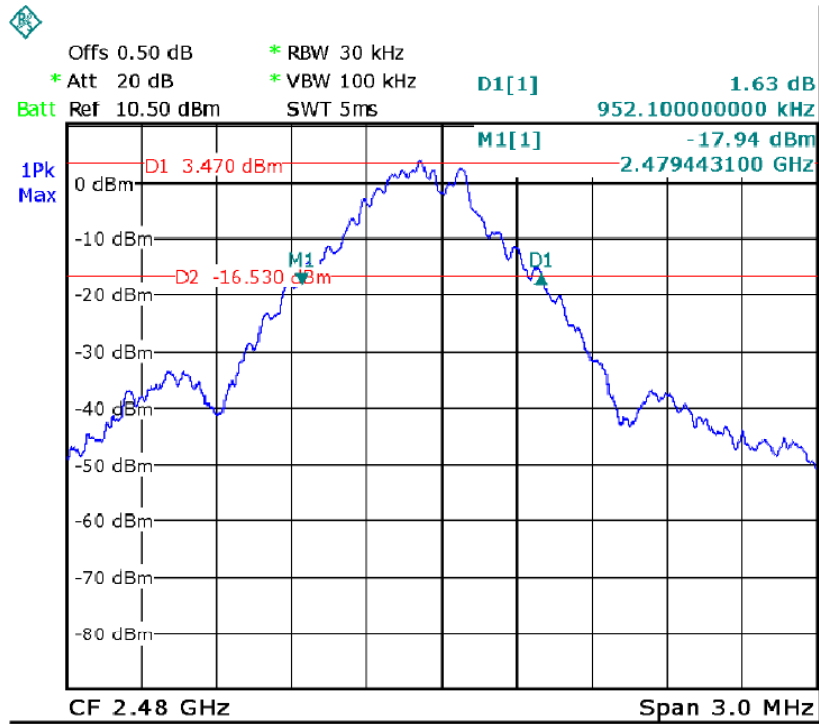

### Pi/4DQPSK Low Channel

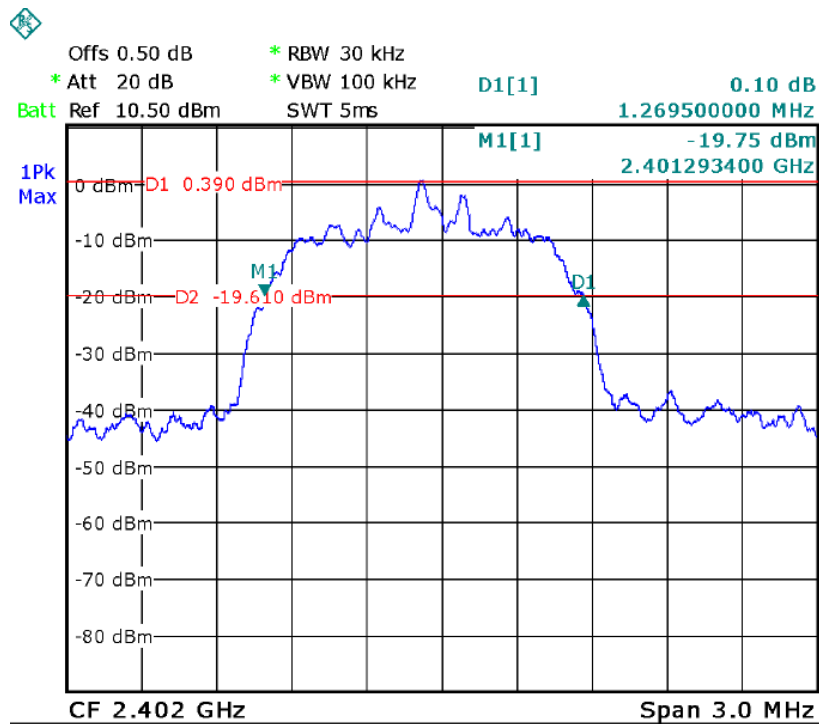

Pi/4DQPSK Middle Channel

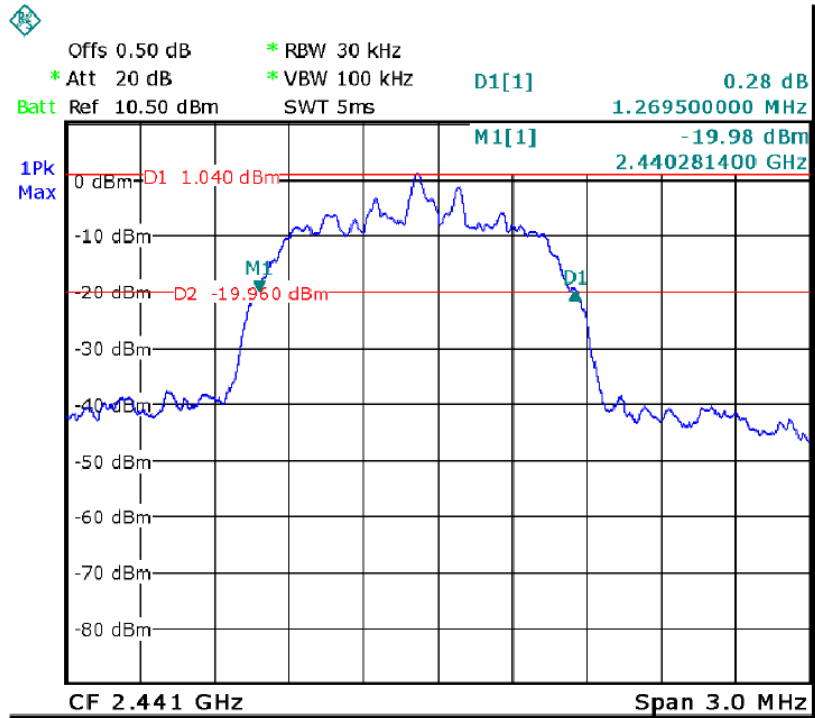

Pi/4DQPSK High Channel

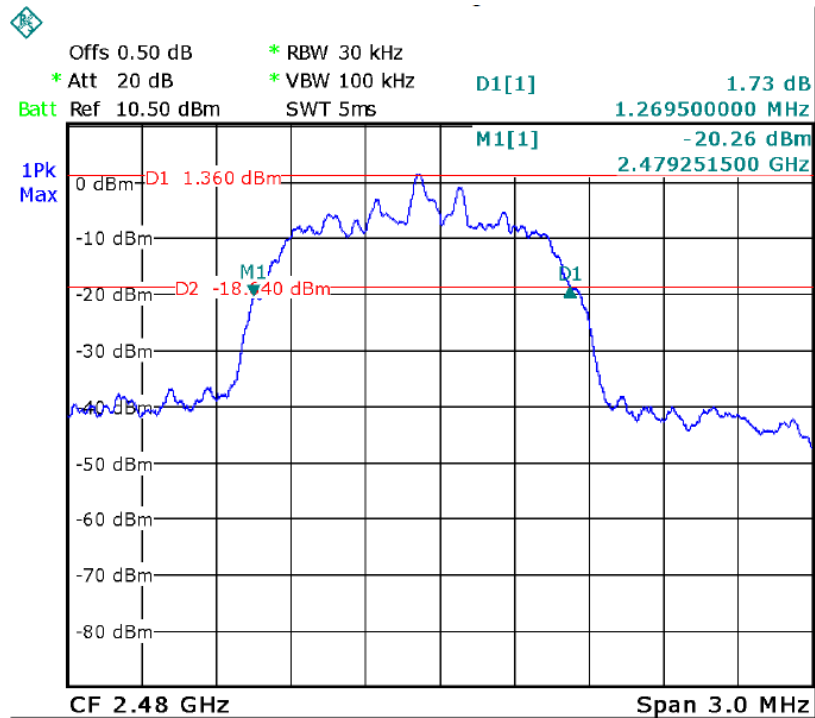

### 8DPSK Low Channel

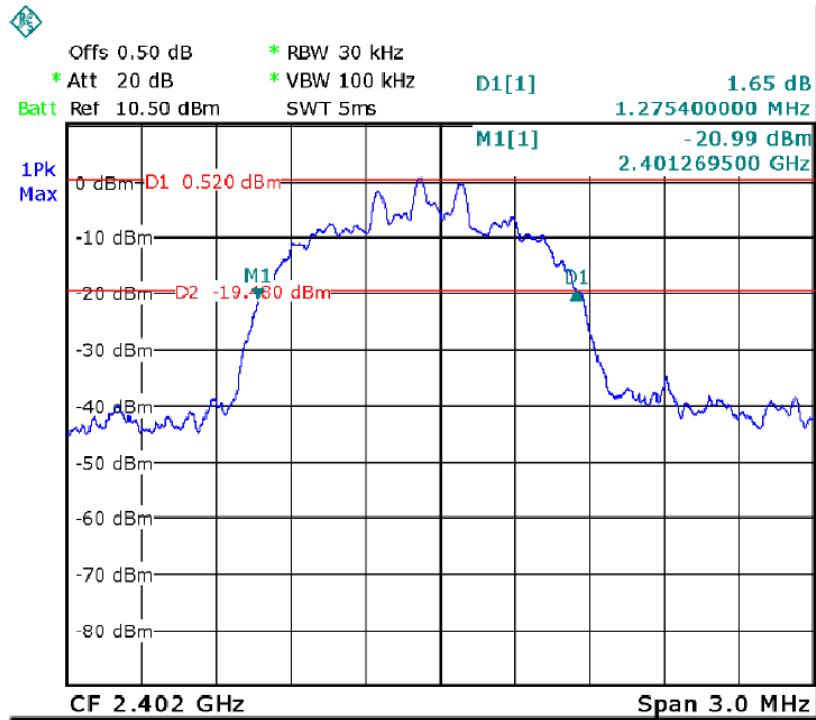

### 8DPSK Middle Channel

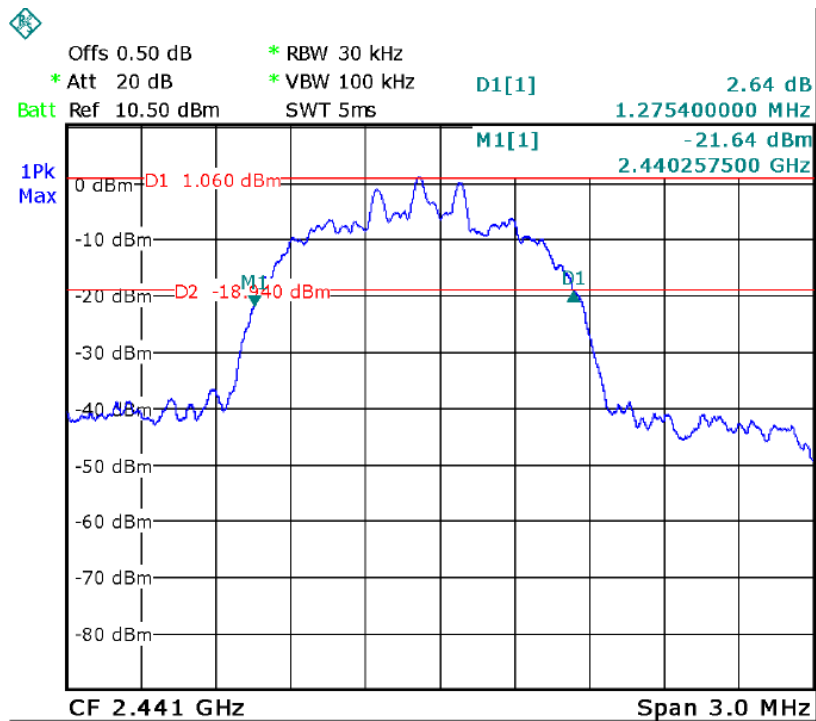

8DPSK High Channel

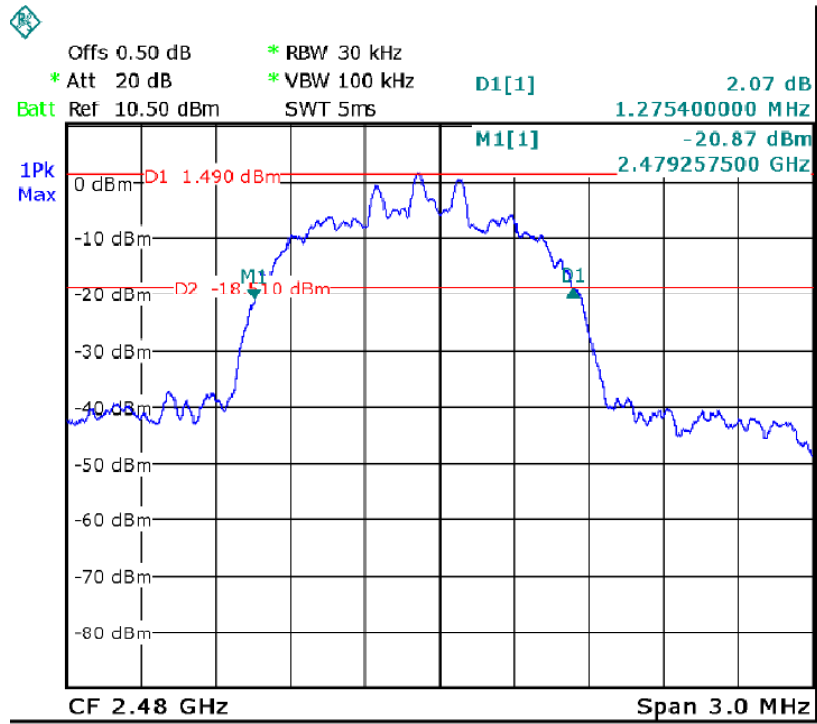



### 9 Maximum Peak Output Power

- Test Requirement : FCC CFR47 Part 15 Section 15.247
- Test Method : ANSI C63.10:2013, DA 00-705
- Test Limit : Regulation 15.247 (b)(1), For frequency hopping systems operating in the 2400-2483.5 MHz band employing at least 75 non-overlapping hopping channels, and all frequency hopping systems in the 5725-5850 MHz band: 1 watt. For all other frequency hopping systems in the 2400-2483.5 MHz band: 0.125 watts.  
Refer to the result "Number of Hopping Frequency" of this document. The 0.125watts (20.97 dBm) limit applies.
- Test Mode : Refer to section 3.3

#### 9.1 Test Procedure

1. Remove the antenna from the EUT and then connect a low RF cable from the antenna port to the spectrum.
2. Set the spectrum analyser: RBW = 3 MHz. VBW =3 MHz. Sweep = auto; Detector Function = Peak.
3. Keep the EUT in transmitting at lowest, medium and highest channel individually. Record the max value.

#### 9.2 Test Result

Modulation	Test Channel	Output Power (dBm)	Limit (dBm)
GFSK	Low	4.72	30
GFSK	Middle	4.81	30
GFSK	High	5.12	30
Pi/4 DQPSK	Low	2.85	20.97
Pi/4 DQPSK	Middle	3.19	20.97
Pi/4 DQPSK	High	3.58	20.97
8DPSK	Low	3.13	20.97
8DPSK	Middle	3.46	20.97
8DPSK	High	3.90	20.97



### GFSK Low Channel

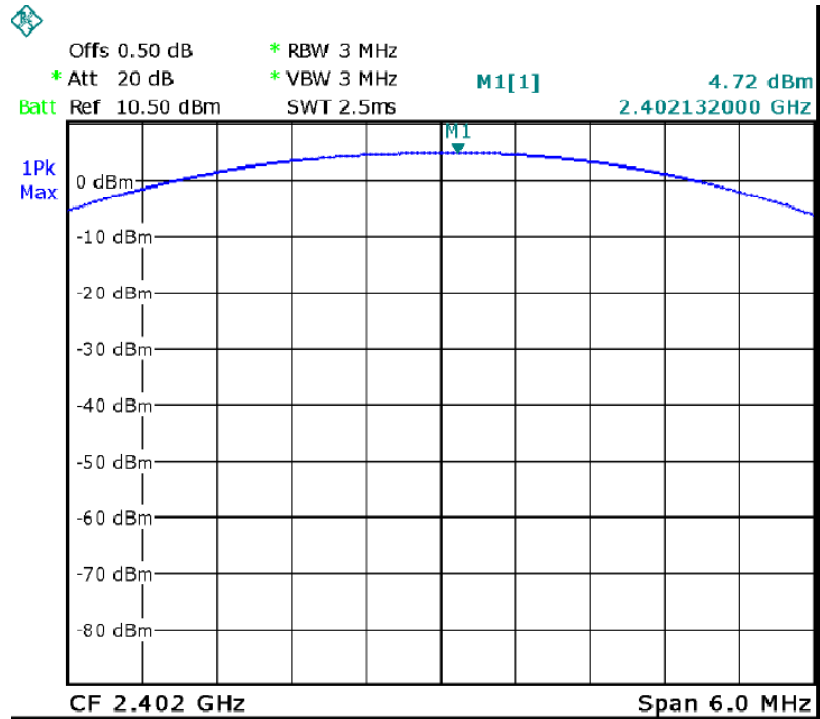

### GFSK Middle Channel

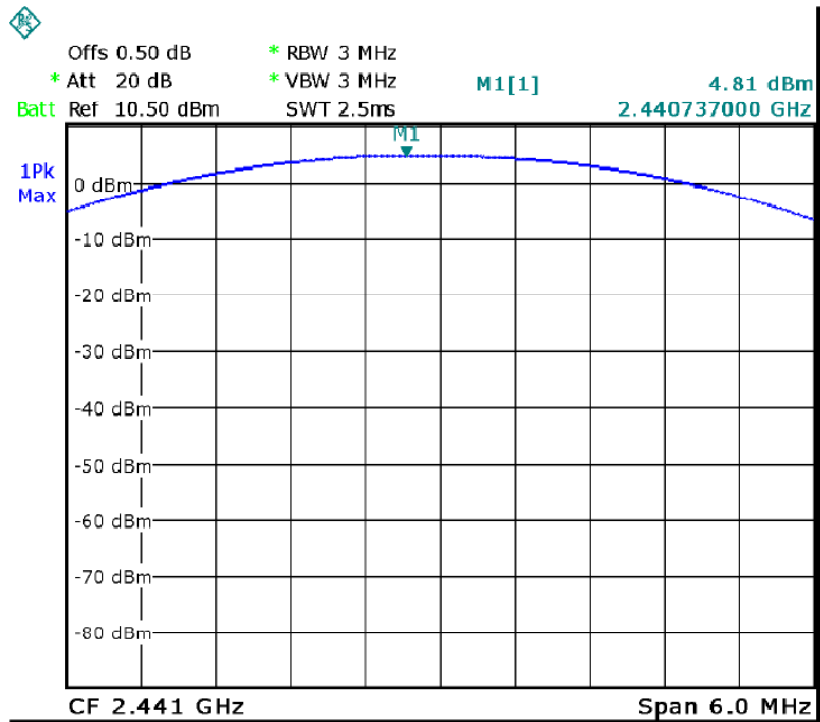

GFSK High Channel

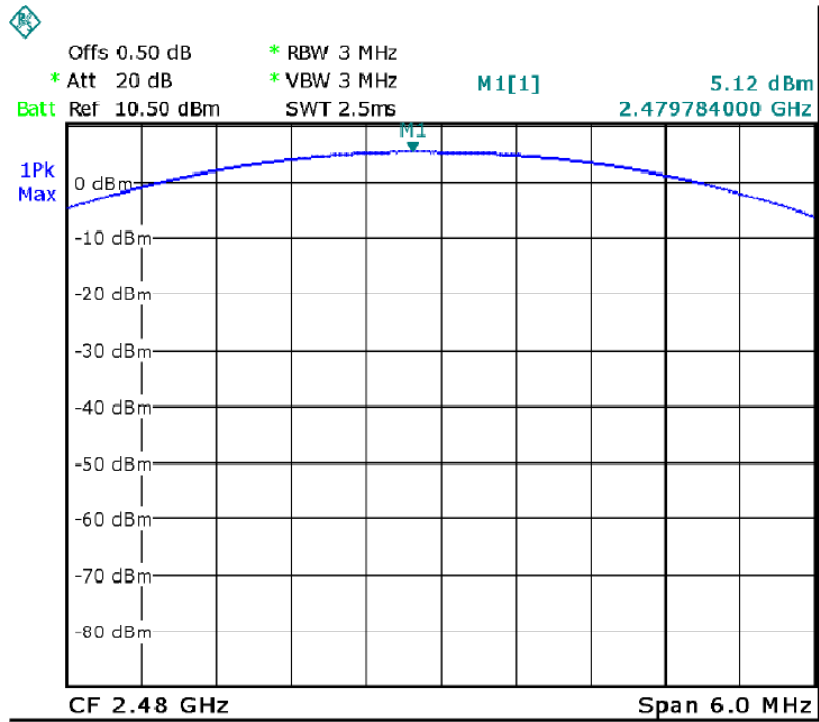

Pi/4DQPSK Low Channel

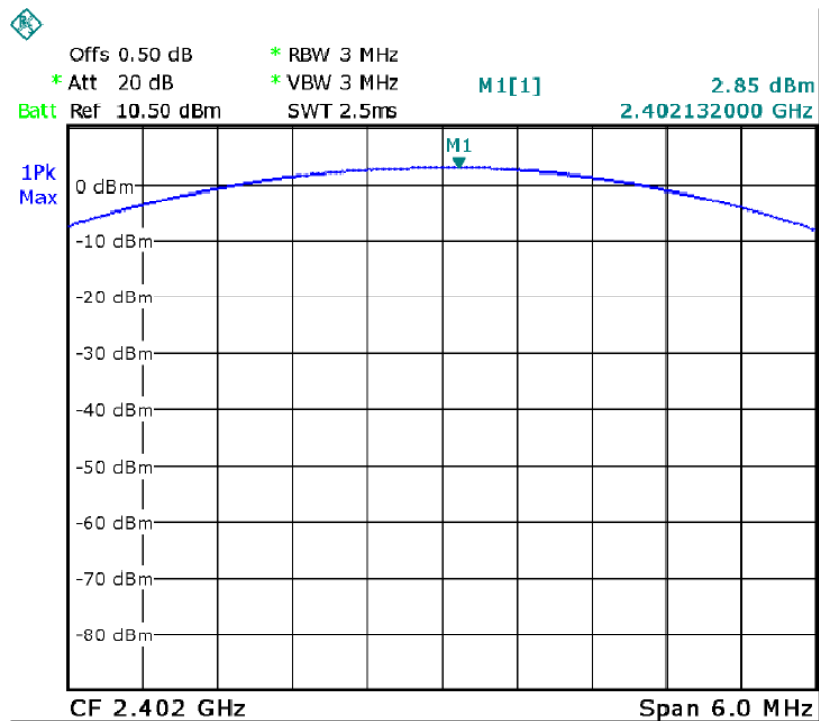

Pi/4DQPSK Middle Channel

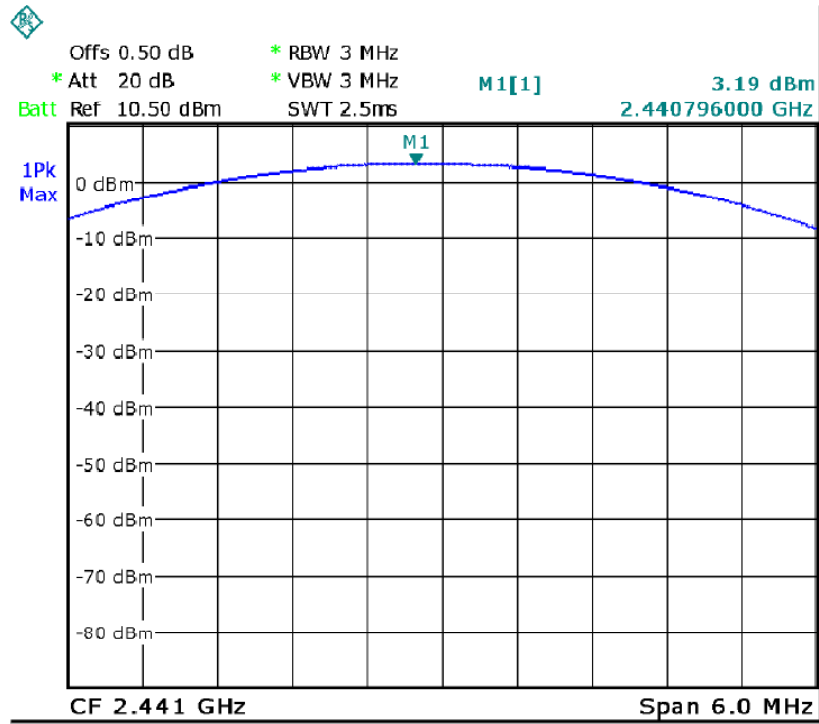

Pi/4DQPSK High Channel

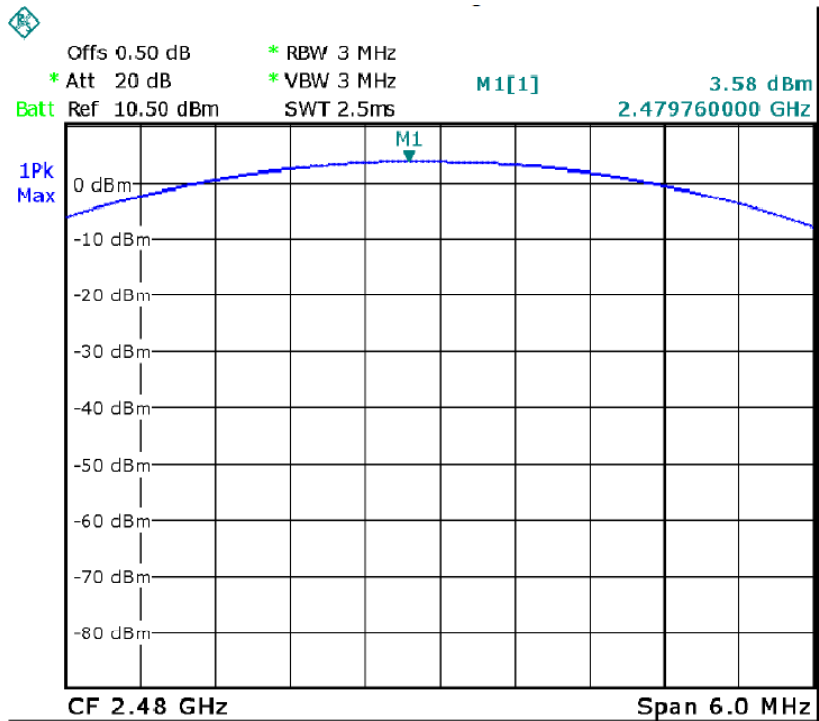

### 8DPSK Low Channel

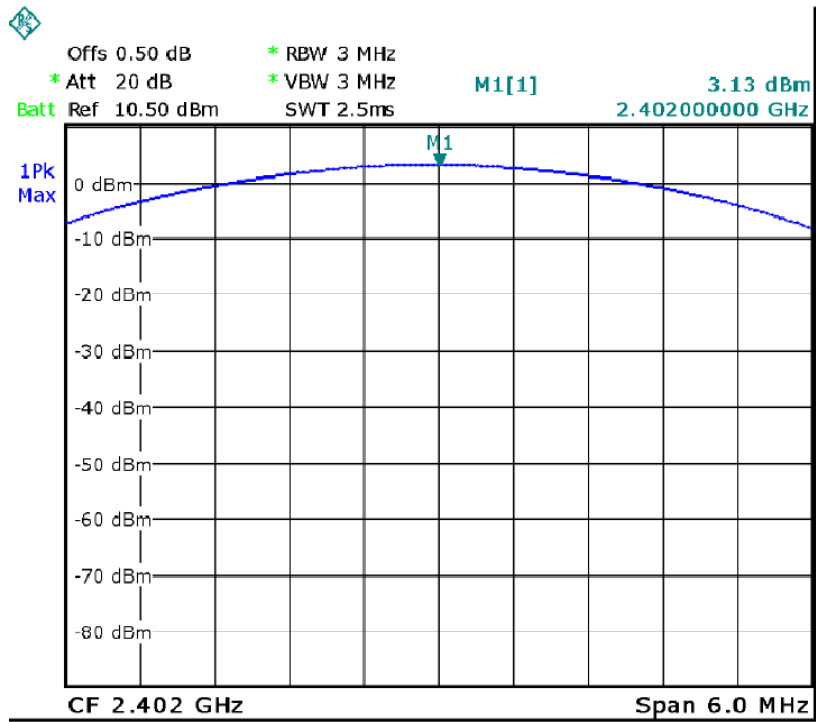

### 8DPSK Middle Channel

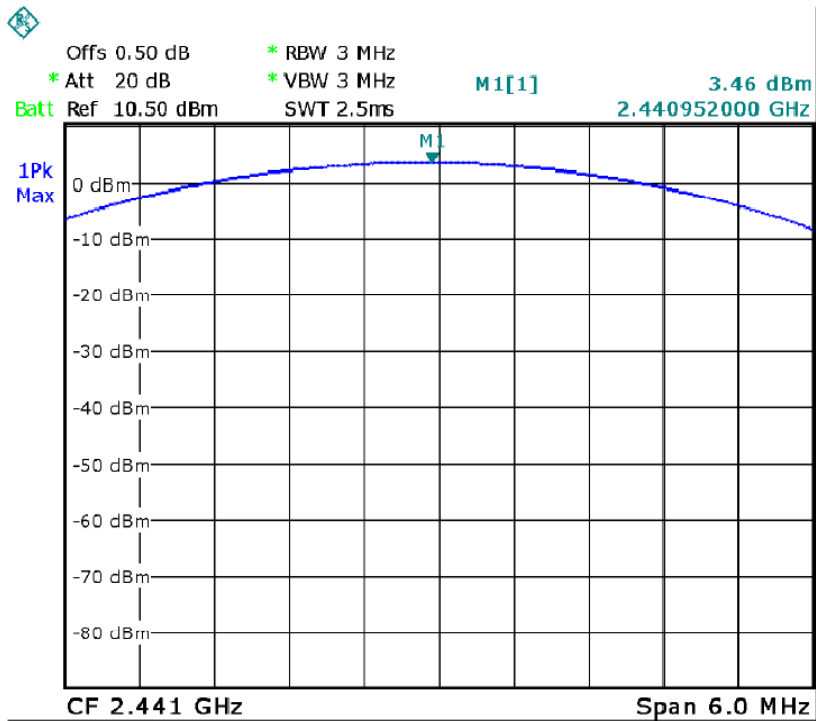

8DPSK High Channel

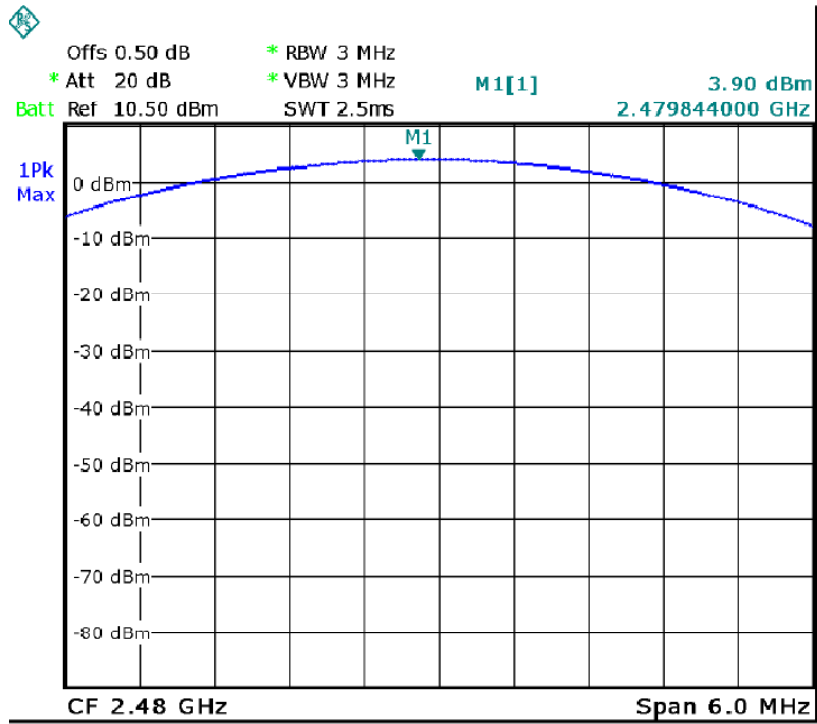



### 10 Hopping Channel Separation

- Test Requirement : FCC CFR47 Part 15 Section 15.247
- Test Method : ANSI C63.10:2013, DA 00-705
- Test Limit : Regulation 15.247(a)(1) Frequency hopping systems shall have hopping channel carrier frequencies separated by a minimum of 25 kHz or the 20 dB bandwidth of the hopping channel, whichever is greater. Alternatively, frequency hopping systems operating in the 2400-2483.5MHz band may have hopping channel carrier frequencies that are separated by 25 kHz or two-thirds of the 20 dB bandwidth of the hopping channel, whichever is greater, provided the systems operate with an output power no greater than 1W.
- Test Mode : Hopping

#### 10.1 Test Procedure

1. Remove the antenna from the EUT and then connect a low RF cable from the antenna port to the spectrum.
2. Set the spectrum analyzer: RBW = 30KHz. VBW = 100KHz , Span = 3MHz. Sweep = auto; Detector Function = Peak. Trace = Max hold.
3. Allow the trace to stabilize. Use the marker-delta function to determine the separation between the peaks of the adjacent channels. The limit is specified in one of the subparagraphs of this Section Submit this plot.

#### 10.2 Test Result

Modulation	Test Channel	Separation (MHz)	Limit (MHz)	Result
GFSK	Low	1.000	0.952	PASS
GFSK	Middle	1.000	0.952	PASS
GFSK	High	1.000	0.952	PASS
Pi/4 DQPSK	Low	1.000	0.847	PASS
Pi/4 DQPSK	Middle	1.000	0.847	PASS
Pi/4 DQPSK	High	1.000	0.847	PASS
8DPSK	Low	1.000	0.850	PASS
8DPSK	Middle	1.000	0.850	PASS
8DPSK	High	1.000	0.850	PASS

### GFSK Low Channel

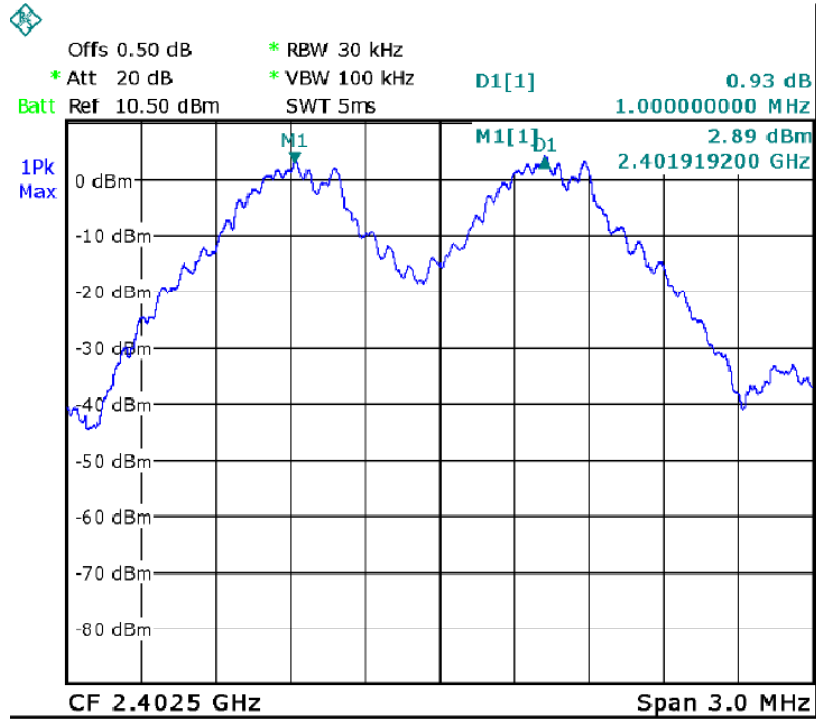

### GFSK Middle Channel

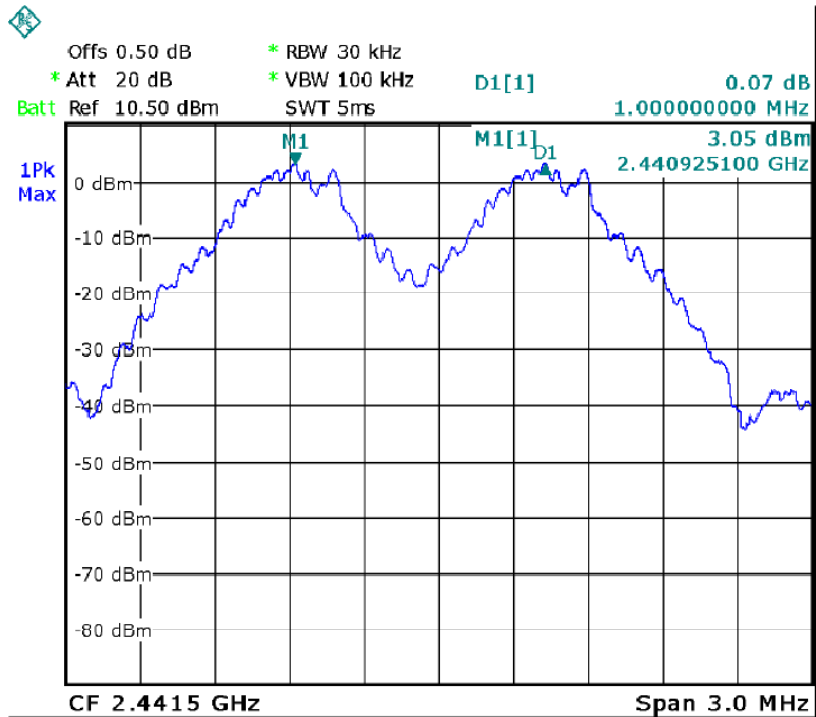

GFSK High Channel

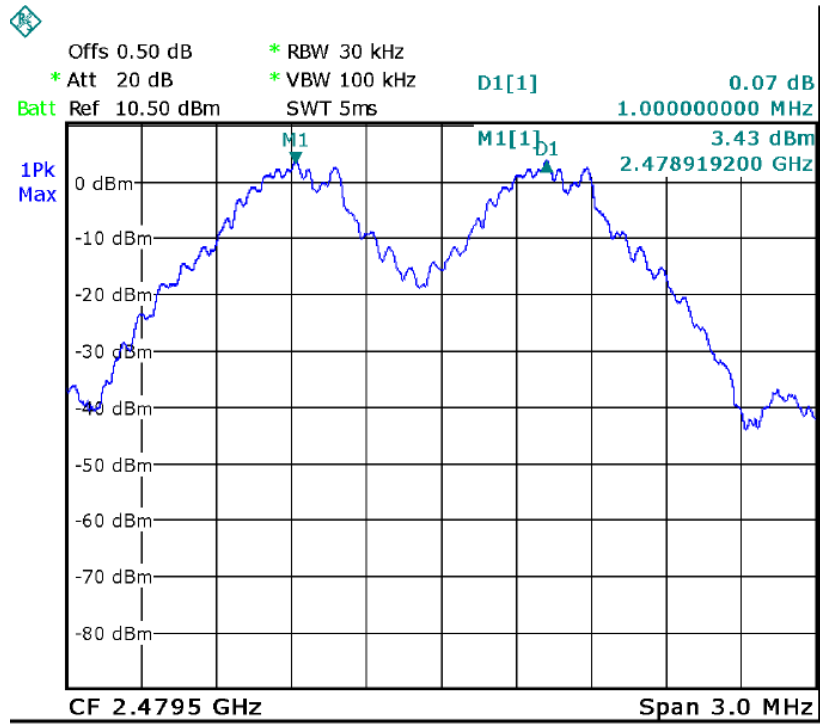

Pi/4DQPSK Low Channel

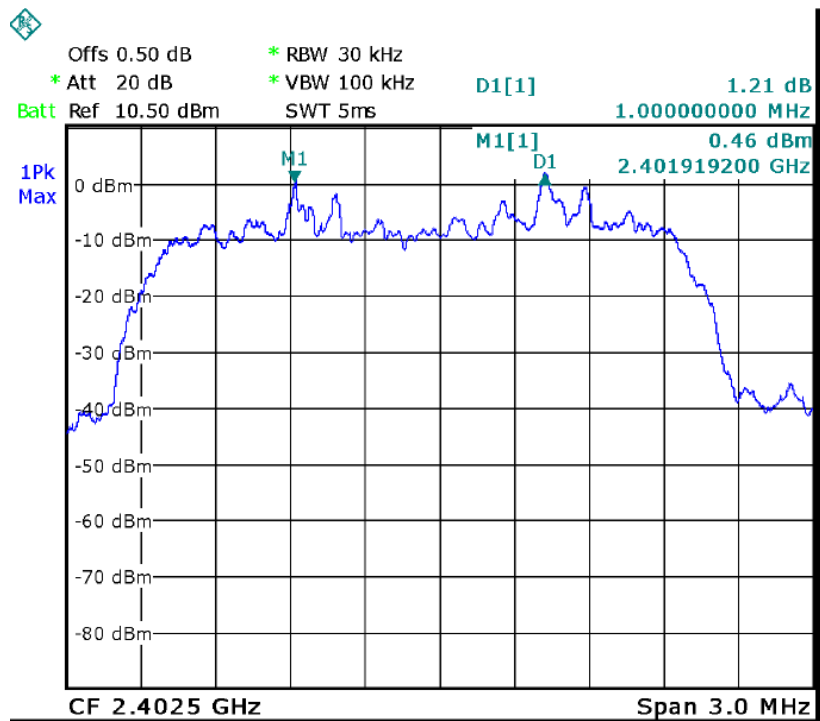



Pi/4DQPSK Middle Channel

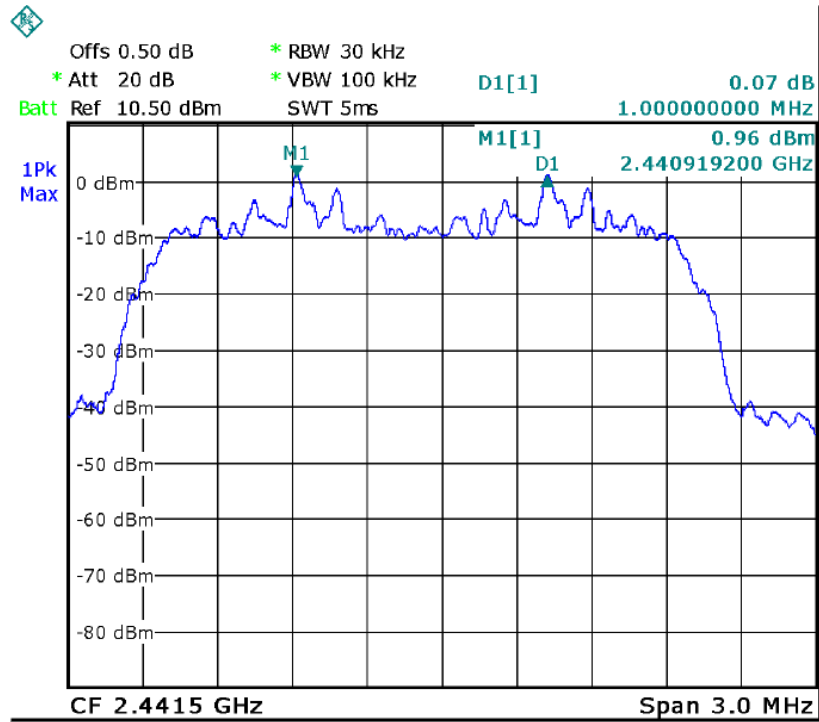

Pi/4DQPSK High Channel

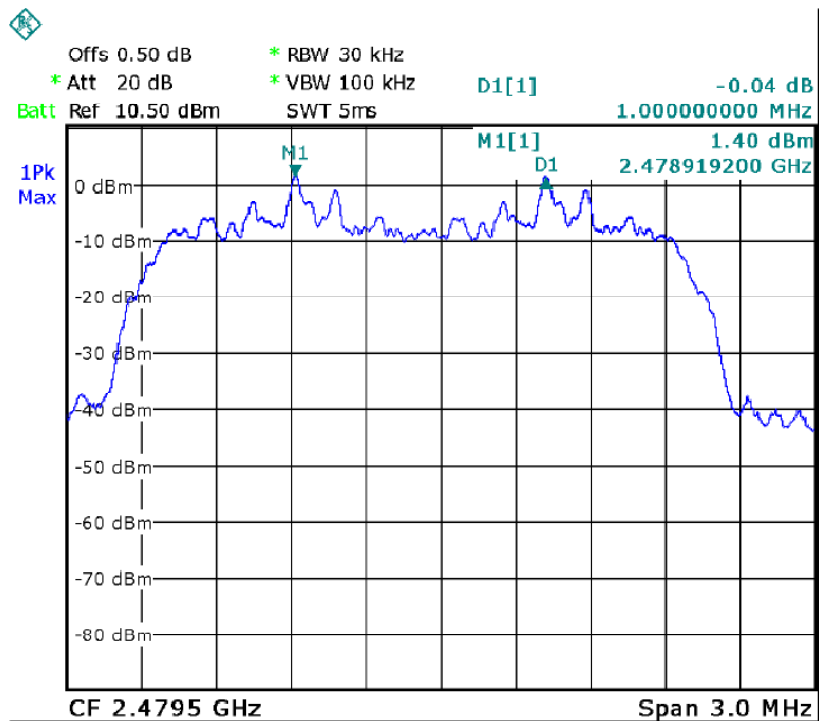

8DPSK Low Channel

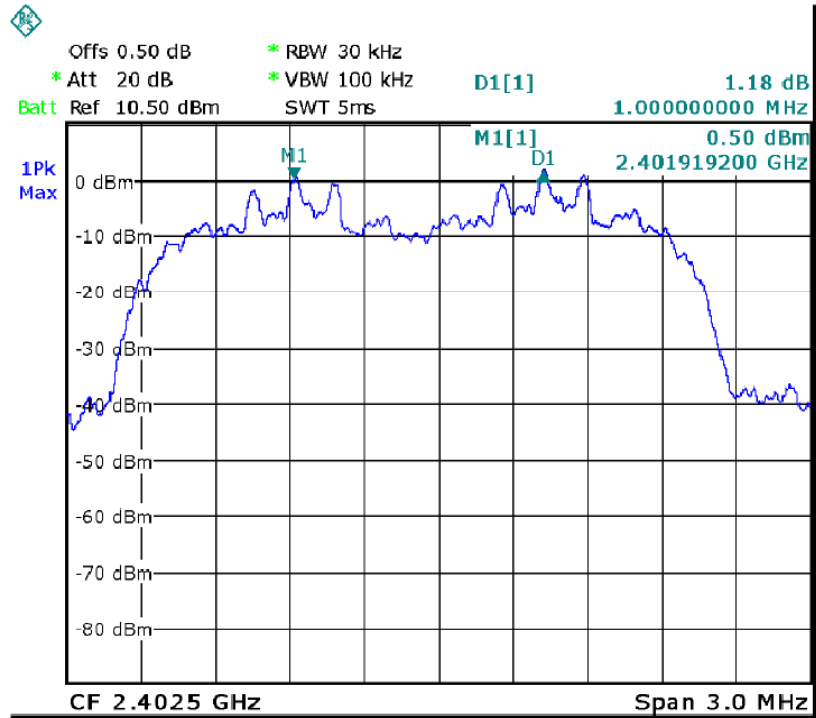

8DPSK Middle Channel

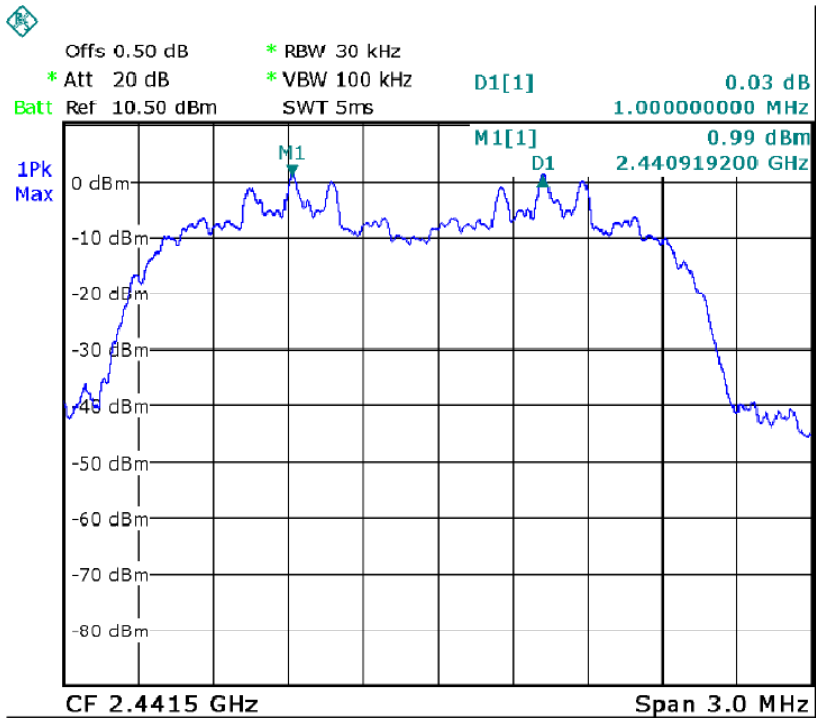

8DPSK High Channel

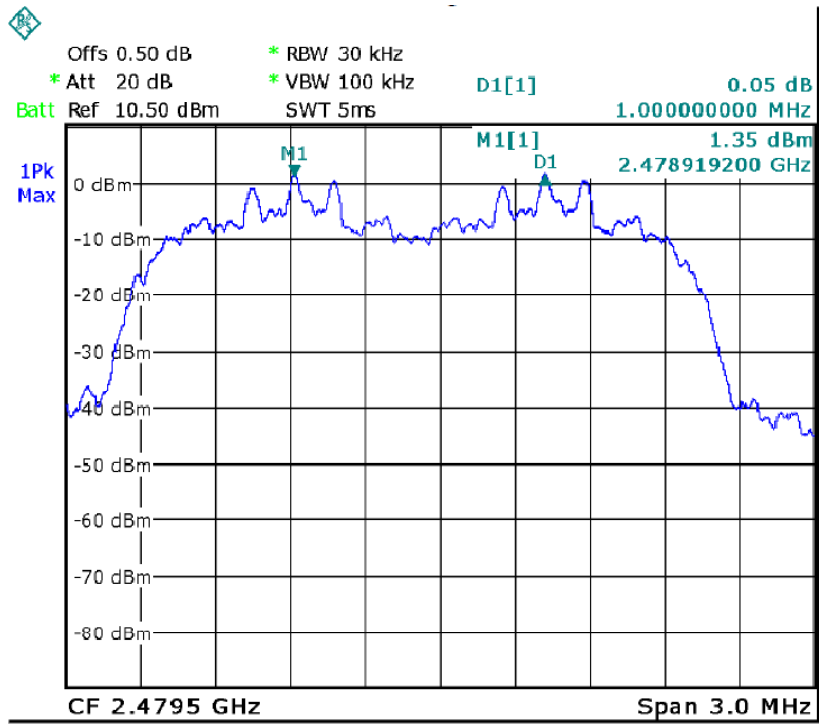



### 11 Number of Hopping Frequency

- Test Requirement : FCC CFR47 Part 15 Section 15.247
- Test Method : ANSI C63.10:2013, DA 00-705
- Test Limit : Regulation 15.247 (a)(1)(iii) Frequency hopping systems in the 2400-2483.5 MHz band shall use at least 15 channels.
- Test Mode : Hopping(GFSK)

#### 11.1 Test Procedure

1. Remove the antenna from the EUT and then connect a low RF cable from the antenna port to the spectrum.
2. Set the spectrum analyzer: RBW = 1MHz. VBW = 1MHz. Sweep = auto; Detector Function = Peak. Trace = Max hold.
3. Allow the trace to stabilize. It may prove necessary to break the span up to sections. in order to clearly show all of the hopping frequencies. The limit is specified in one of the subparagraphs of this Section.
4. Set the spectrum analyzer: Start Frequency = 2.4GHz, Stop Frequency = 2.483GHz. Sweep=auto;

#### 11.2 Test Result

Channel Number	Limit
79	≥ 15

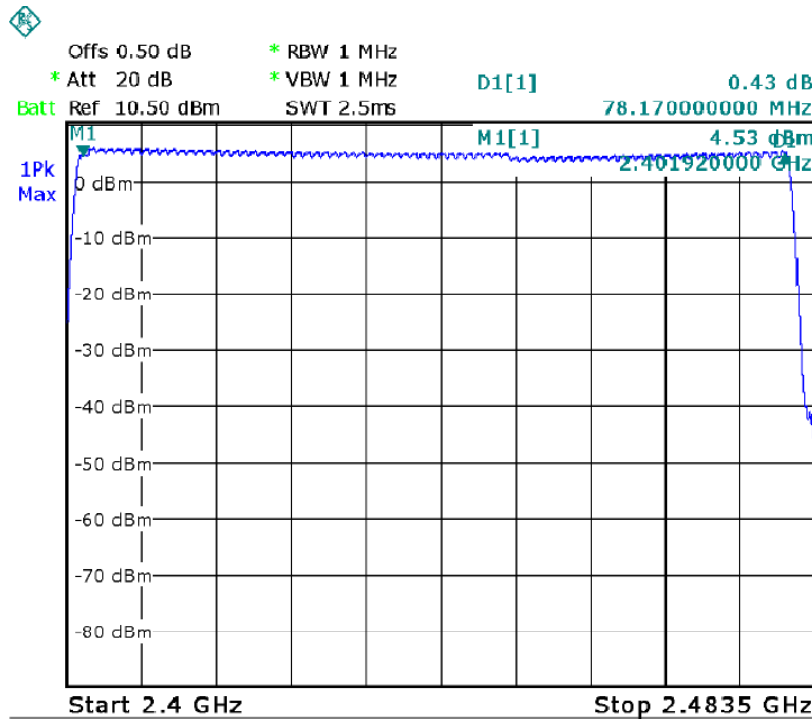



## 12 Dwell Time

Test Requirement	: FCC CFR47 Part 15 Section 15.247
Test Method	: ANSI C63.10:2013, DA 00-705
Test Limit	: Regulation 15.247(a)(1)(iii) Frequency hopping systems in the 2400-2483.5 MHz band shall use at least 15 channels. The average time of occupancy on any channel shall not be greater than 0.4 seconds within a period of 0.4 seconds multiplied by the number of hopping channels employed.
Test Mode	: Hopping
Remark	: The worst case(8DPSK,3DH5) was recorded

### 12.1 Test Procedure

1. Remove the antenna from the EUT and then connect a low RF cable from the antenna port to the spectrum.
2. Set spectrum analyzer span = 0. Centred on a hopping channel;
3. Set RBW = 1MHz and VBW = 3MHz.Sweep = as necessary to capture the entire dwell time per hopping channel. Set the EUT for DH5, DH3 and DH1 packet transmitting.
4. Use the marker-delta function to determine the dwell time. If this value varies with different modes of operation (e.g.. data rate. modulation format. etc.). repeat this test for each variation. The limit is specified in one of the subparagraphs of this Section. Submit this plot(s).

### 12.2 Test Result

DH5 Packet permit maximum  $1600 / 79 / 6$  hops per second in each channel (5 time slots RX, 1 time slot TX).

DH3 Packet permit maximum  $1600 / 79 / 4$  hops per second in each channel (3 time slots RX, 1 time slot TX).

DH1 Packet permit maximum  $1600 / 79 / 2$  hops per second in each channel (1 time slot RX, 1 time slot TX). So, the Dwell Time can be calculated as follows:

Data Packet	Dwell Time(s)
DH5/2DH5/3DH5	$1600/79/6*0.4*79*(MkrDelta)/1000$
DH3/2DH3/3DH3	$1600/79/4*0.4*79*(MkrDelta)/1000$
DH1/2DH1/3DH1	$1600/79/2*0.4*79*(MkrDelta)/1000$
Remark: Mkr Delta is once pulse time. Only the worst data(DH5) were show as follow.	



Modulation	Data Packet	Channel	pulse time(ms)	Dwell Time(s)	Limits(s)
8DPSK	3DH5	Low	2.896	0.309	0.4
		middle	2.896	0.309	0.4
		High	2.896	0.309	0.4

8DPSK Low Channel

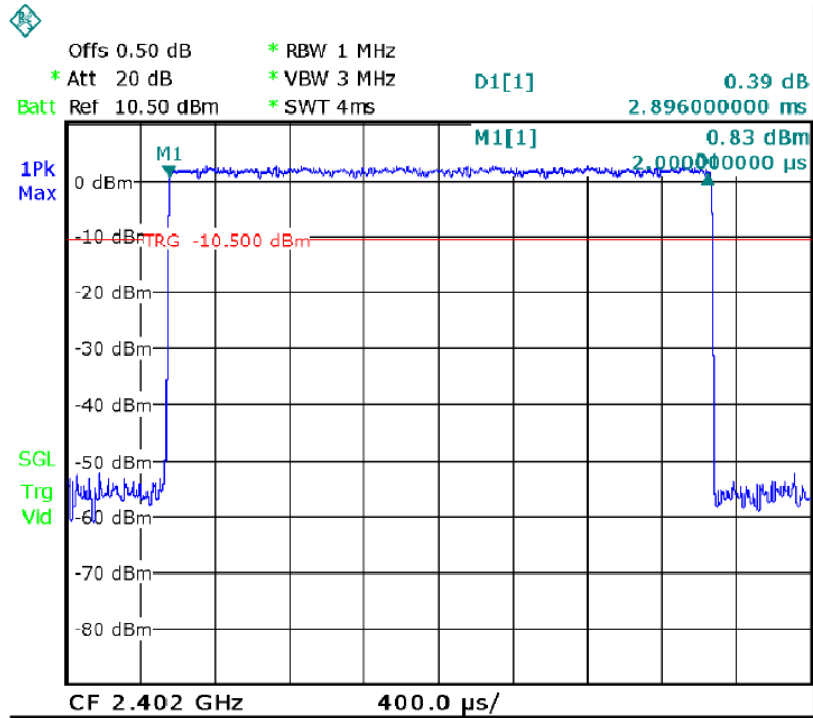

### 8DPSK Middle Channel

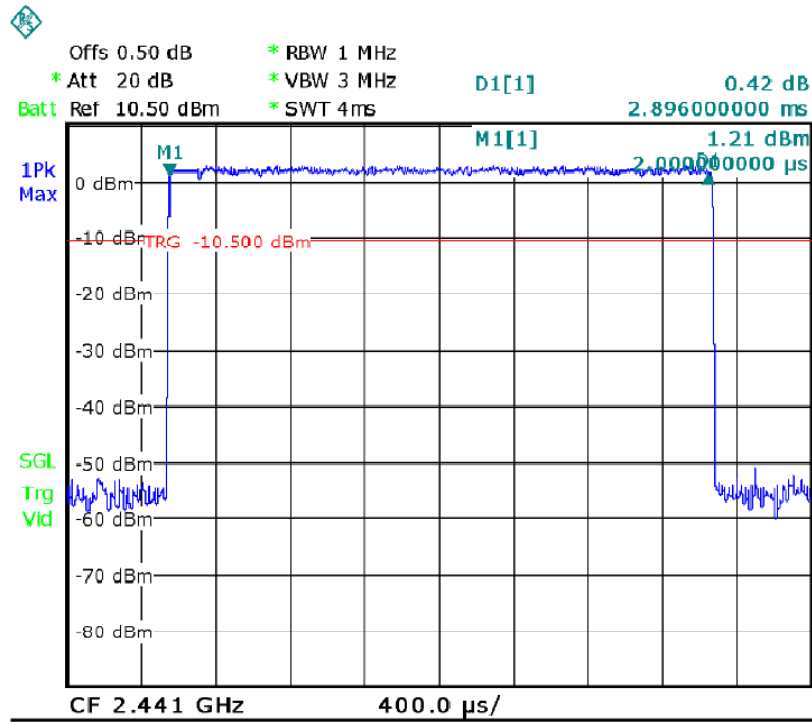

### 8DPSK High Channel

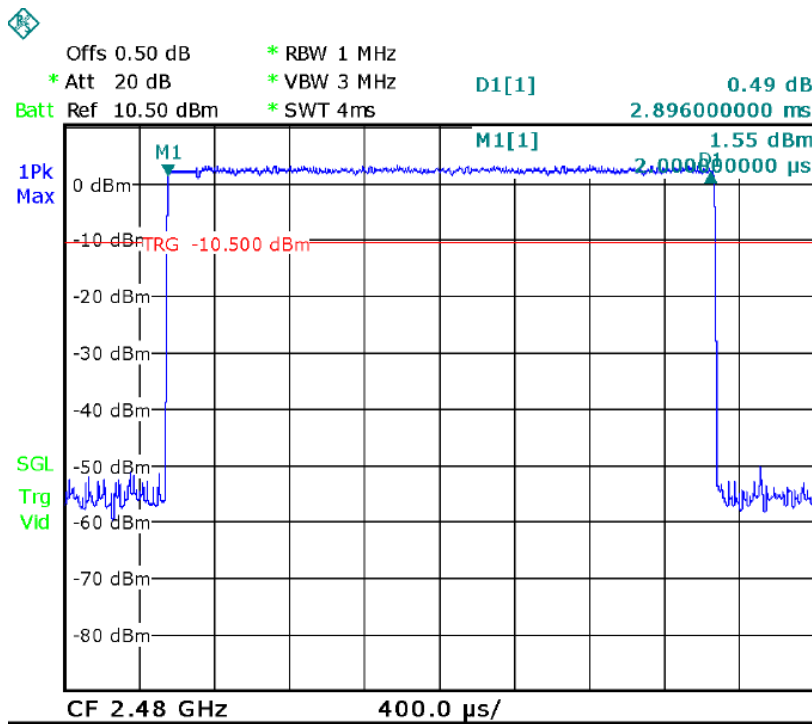



### **13 Antenna Requirement**

According to the FCC part15.203, a transmitter can only be sold or operated with antennas with which it was approved. This product has a Monopole antenna, this antenna is fixed and cannot be removed and changed. It meets the requirement of this section.





# 14 Test Setup

Spurious Emissions  
From 30MHz-1000MHz

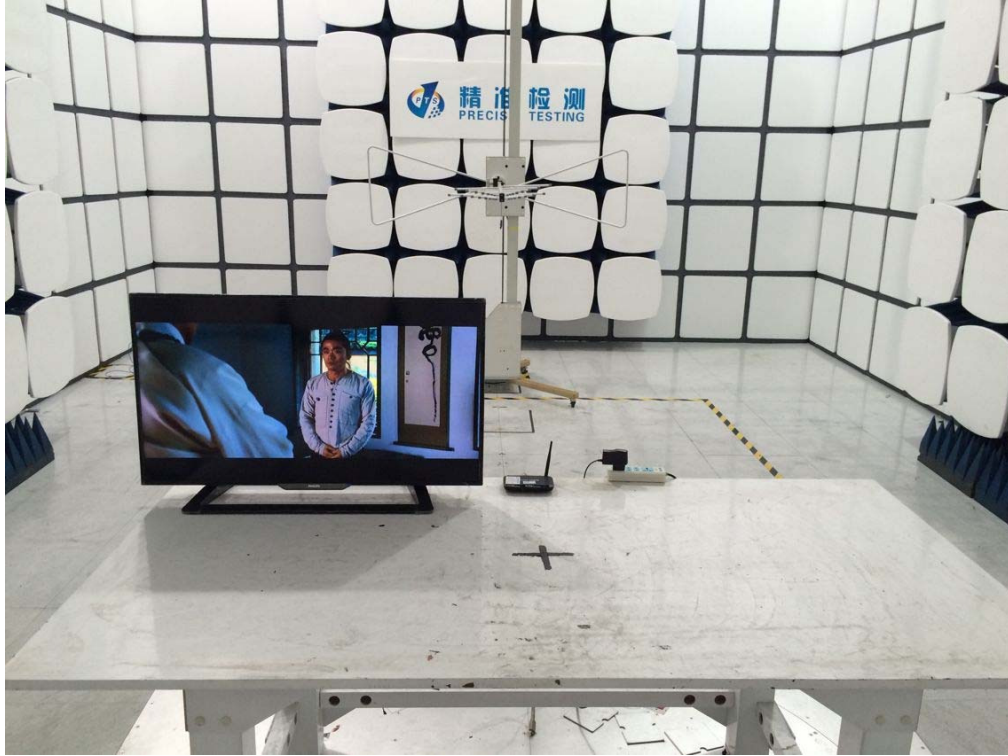

Above 1GHz



Conducted Emissions





### 15 EUT Photos

#### External Photos









Internal Photos

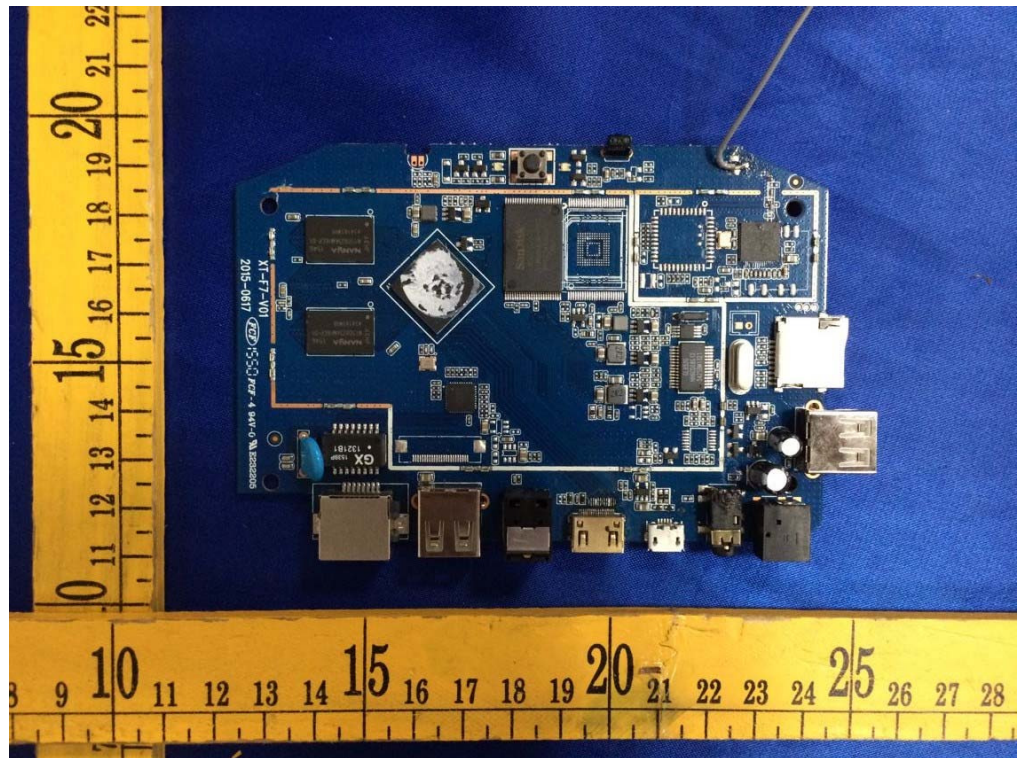

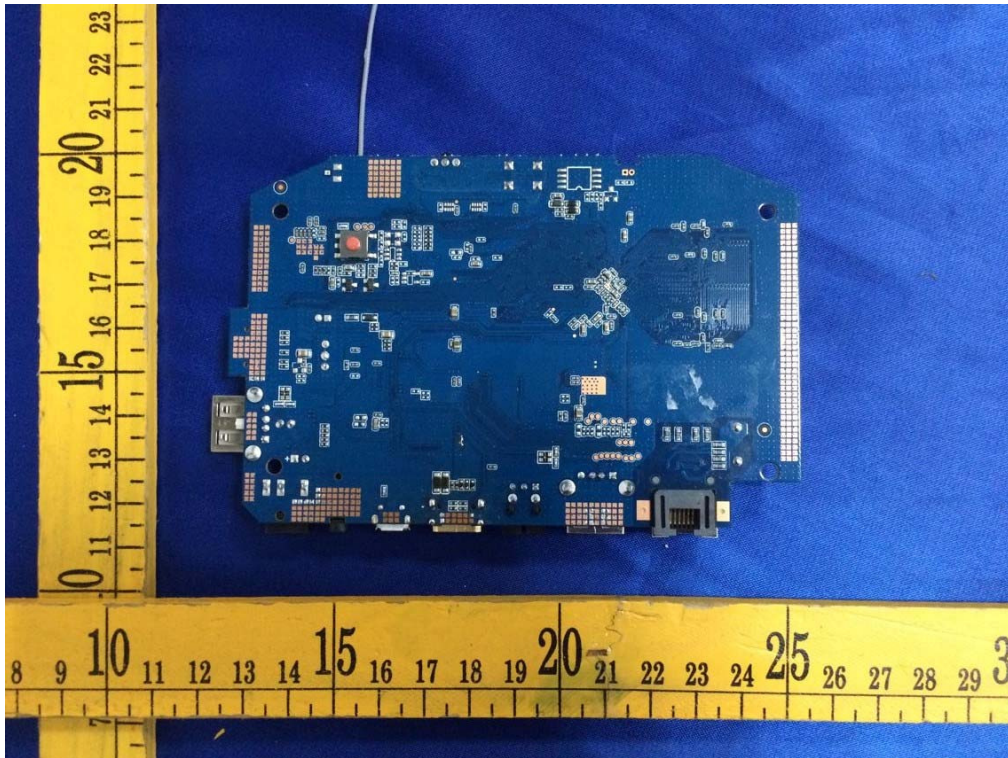

\*\*\*\*\* THE END REPORT\*\*\*\*\*