



RF TEST REPORT

Applicant Quectel Wireless Solutions Co., Ltd

FCC ID XMR202005BG95M5

Product LTE Cat M1 & Cat NB2 & EGPRS
Module

Brand Quectel

Model BG95-M5

Report No. R2005A0283-R1V1

Issue Date July 23, 2020

TA Technology (Shanghai) Co., Ltd. tested the above equipment in accordance with the requirements in **FCC CFR47 Part 2 (2019)/ FCC CFR 47 Part 22H (2019)**. The test results show that the equipment tested is capable of demonstrating compliance with the requirements as documented in this report.

Performed by: Peng Tao

Approved by: Kai Xu

TA Technology (Shanghai) Co., Ltd.

No.145, Jintang Rd, Tangzhen Industry Park, Pudong Shanghai, China

TEL: +86-021-50791141/2/3

FAX: +86-021-50791141/2/3-8000



TABLE OF CONTENT

1. Test Laboratory	4
1.1. Notes of the Test Report	4
1.2. Test facility	4
1.3. Testing Location	4
2. General Description of Equipment under Test.....	5
2.3. Applicant and Manufacturer Information	5
2.4. General Information.....	5
3. Applied Standards	7
4. Test Configuration.....	8
5. Test Case Results.....	10
5.1. RF Power Output and Effective Radiated Power	10
5.2. Occupied Bandwidth	14
5.3. Band Edge Compliance.....	21
5.4. Peak-to-Average Power Ratio (PAPR)	35
5.5. Frequency Stability.....	38
5.6. Spurious Emissions at Antenna Terminals	46
5.7. Radiates Spurious Emission	59
6. Main Test Instruments	67



Summary of measurement results

No.	Test Case	Clause in FCC rules	Verdict
1	RF Power Output and Effective Radiated Power	2.1046 22.913(a)(5)	PASS
2	Occupied Bandwidth	2.1049	PASS
3	Band Edge Compliance	2.1051 / 22.917(a)	PASS
4	Peak-to-Average Power Ratio	22.913(d)/ KDB 971168 D01(5.7)	PASS
5	Frequency Stability	2.1055 / 22.355	PASS
6	Spurious Emissions at Antenna Terminals	2.1051 / 22.917(a)	PASS
7	Radiates Spurious Emission	2.1053 / 22.917 (a)	PASS

Date of Testing: May 23, 2020 ~ June 16, 2020

Note: All indications of Pass/Fail in this report are opinions expressed by TA Technology (Shanghai) Co., Ltd. based on interpretations and/or observations of test results. Measurement Uncertainties were not taken into account and are published for informational purposes only.

Note: This revised report (Report No.: R2005A0283-R1V1) supersedes and replaces the previously issued report (Report No.: R2005A0283-R1). Please discard or destroy the previously issued report and dispose of it accordingly.



1. Test Laboratory

1.1. Notes of the Test Report

This report shall not be reproduced in full or partial, without the written approval of **TA technology (shanghai) co., Ltd.** The results documented in this report apply only to the tested sample, under the conditions and modes of operation as described herein .Measurement Uncertainties were not taken into account and are published for informational purposes only. This report is written to support regulatory compliance of the applicable standards stated above.

1.2. Test facility

FCC (Designation number: CN1179, Test Firm Registration Number: 446626)

TA Technology (Shanghai) Co., Ltd. has been listed on the US Federal Communications Commission list of test facilities recognized to perform electromagnetic emissions measurements.

A2LA (Certificate Number: 3857.01)

TA Technology (Shanghai) Co., Ltd. has been listed by American Association for Laboratory Accreditation to perform electromagnetic emission measurement.

1.3. Testing Location

Company: TA Technology (Shanghai) Co., Ltd.
Address: No.145, Jintang Rd, Tangzhen Industry Park, Pudong
City: Shanghai
Post code: 201201
Country: P. R. China
Contact: Xu Kai
Telephone: +86-021-50791141/2/3
Fax: +86-021-50791141/2/3-8000
Website: <http://www.ta-shanghai.com>
E-mail: xukai@ta-shanghai.com

2. General Description of Equipment under Test

2.3. Applicant and Manufacturer Information

Applicant	Quectel Wireless Solutions Co., Ltd
Applicant address	Building 5, Shanghai Business Park Phase III (Area B), No.1016 Tianlin Road, Minhang District, Shanghai, China 200233
Manufacturer	Quectel Wireless Solutions Co., Ltd
Manufacturer address	Building 5, Shanghai Business Park Phase III (Area B), No.1016 Tianlin Road, Minhang District, Shanghai, China 200233

2.4. General Information

EUT Description			
Model	BG95-M5		
IMEI	866833040004456		
Hardware Version	R1.1		
Software Version	BG95M5LAR02A02		
Power Supply	External power supply		
Antenna Type	The EUT don't have standard Antenna, The Antenna used for testing in this report is the after-market accessory (Dipole Antenna)		
Antenna Gain	Frequency(MHz)	Gain(dBi)	
	820	2.53	
	840	1.89	
	850	2.29	
Test Mode(s)	GSM 850; LTE Band 5/26;		
Test Modulation	(GSM/GPRS)GMSK, (EGPRS) GMSK/ 8PSK; (LTE)QPSK 16QAM;		
GPRS Multislot Class	33		
EGPRS Multislot Class	33		
LTE Category	M1		
Maximum E.R.P.	GSM 850:	32.81dBm	
	LTE Band 5:	24.12dBm	
	LTE Band 26:	24.13dBm	
Rated Power Supply Voltage	3.8V		
Extreme Voltage	Minimum: 3.3V Maximum: 4.3V		
Extreme Temperature	Lowest: -40°C Highest: +85°C		
Frequency Range(s)	Band	Tx (MHz)	Rx (MHz)
	GSM850	824 ~ 849	869 ~ 894
	LTE Band 5	824 ~ 849	869 ~ 894
	LTE Band 26	824 ~ 849	869 ~ 894



Note: 1. The EUT is sent from the applicant to TA and the information of the EUT is declared by the applicant.



3. Applied Standards

According to the specifications of the manufacturer, it must comply with the requirements of the following standards:

Test standards:

FCC CFR 47 Part 22H (2019)

ANSI C63.26 (2015)

Reference standard:

FCC CFR47 Part 2 (2019)

KDB 971168 D01 Power Meas License Digital Systems v03r01

4. Test Configuration

Radiated measurements are performed by rotating the EUT in three different orthogonal test planes. EUT stand-up position (Z axis), lie-down position (X, Y axis). Receiver antenna polarization (horizontal and vertical), the worst emission was found in position (Z axis, horizontal polarization) and the worst case was recorded.

All mode and data rates and positions were investigated. Subsequently, only the worst case emissions are reported.

The following testing in GSM/ LTE is set based on the maximum RF Output Power.

Test modes are chosen to be reported as the worst case configuration below:

Test items	Modes/Modulation
	GSM 850
RF Power Output and Effective Radiated power	GSM GPRS EGPRS
Occupied Bandwidth	GSM GPRS(1Tx slot) EGPRS(1Tx slot)
Band Edge Compliance	GSM GPRS(1Tx slot) EGPRS(1Tx slot)
Peak-to-Average Power Ratio	GSM GPRS(1Tx slot) EGPRS(1Tx slot)
Frequency Stability	GSM GPRS(1Tx slot) EGPRS(1Tx slot)
Spurious Emissions at Antenna Terminals	GSM
Radiates Spurious Emission	GSM



Test modes are chosen as the worst case configuration below for LTE Band 5/26

Test items	Modes	Bandwidth (MHz)					Modulation		RB			Test Channel		
		1.4	3	5	10	15	QPSK	16QAM	1	50%	100%	L	M	H
RF power output and Effective Radiated power	LTE 5	O	O	O	O	-	O	O	O	O	O	O	O	O
	LTE 26	O	O	O	O	O	O	O	O	O	O	O	O	O
Occupied Bandwidth	LTE 5	O	O	O	O	-	O	O	-	-	O	O	O	O
	LTE 26	O	O	O	O	O	O	O	-	-	O	O	O	O
Band Edge Compliance	LTE 5	O	O	O	O	-	O	O	O	-	O	O	-	O
	LTE 26	O	O	O	O	O	O	O	O	-	O	O	-	O
Peak-to-Average Power Ratio	LTE 5	O	O	O	O	-	O	O	-	-	O	O	O	O
	LTE 26	O	O	O	O	O	O	O	-	-	O	O	O	O
Frequency Stability	LTE 5	O	O	O	O	-	O	O	O	O	O	O	O	O
	LTE 26	O	O	O	O	O	O	O	O	O	O	O	O	O
Spurious Emissions at Antenna Terminals	LTE 5	O	O	O	O	-	O	-	O	-	-	O	O	O
	LTE 26	O	O	O	O	O	O	-	O	-	-	O	O	O
Radiates Spurious Emission	LTE 5	O	-	O	O	-	O	-	O	-	-	-	O	-
	LTE 26	O	-	O	-	O	O	-	O	-	-	-	O	-
Note	1. The mark "O" means that this configuration is chosen for testing. 2. The mark "-" means that this configuration is not testing.													

5. Test Case Results

5.1. RF Power Output and Effective Radiated Power

Ambient condition

Temperature	Relative humidity	Pressure
23°C ~25°C	45%~50%	101.5kPa

Methods of Measurement

During the process of the testing, The EUT is controlled by the Base Station Simulator to ensure max power transmission and proper modulation.

The testing follows FCC KDB 971168 v03r01 Section 5.8 and ANSI C63.26 (2015).

a) Connect the equipment as illustrated. Mount the equipment with the manufacturer specified antenna in a vertical orientation on a manufacturer specified mounting surface located on a non-conducting rotating platform of a RF anechoic chamber (preferred) or a standard radiation site.

b) Key the transmitter, then rotate the EUT 360° azimuthally and record spectrum analyzer power level (LVL) measurements at angular increments that are sufficiently small to permit resolution of all peaks. If a standard radiation test site is used, raise and lower the test antenna to obtain a maximum reading at each angular increment. (Note: several batteries may be needed to offset the effect of battery voltage droop, which should not exceed 5% of the manufactured specified battery voltage during transmission).

c) Replace the transmitter under test with a vertically polarized half-wave dipole (or an antenna whose gain is known relative to an ideal half-wave dipole). The center of the antenna should be at the same location as the center of the antenna under test.

d) Connect the antenna to a signal generator with a known output power and record the path loss (in dB) as LOSS. If a standard radiation test site is used, raise and lower the test antenna to obtain a maximum reading. $LOSS = \text{Generator Output Power (dBm)} - \text{Analyzer reading (dBm)}$

e) Determine the effective radiated output power at each angular position from the readings in steps b) and d) using the following equation: $ERP \text{ (dBm)} = \text{LVL (dBm)} + \text{LOSS (dB)}$

f) The maximum ERP is the maximum value determined in the preceding step.

g) When calculating ERP, in addition to knowing the antenna radiation and matching characteristics, it is necessary to know the loss values of all elements (e.g. transmission line attenuation, mismatches, filters, combiners) interposed between the point where transmitter output power is measured, and the point where power is applied to the antenna. ERP can then be calculated as follows:

$$EIRP \text{ (dBm)} = \text{Output Power (dBm)} - \text{Losses (dB)} + \text{Antenna Gain (dBi)}$$

where: dBd refers to gain relative to an ideal dipole.

$$EIRP \text{ (dBm)} = ERP \text{ (dBm)} + 2.15 \text{ (dB.)}$$

The RB allocation refers to section 5.1, using the maximum output power configuration.

Test Setup

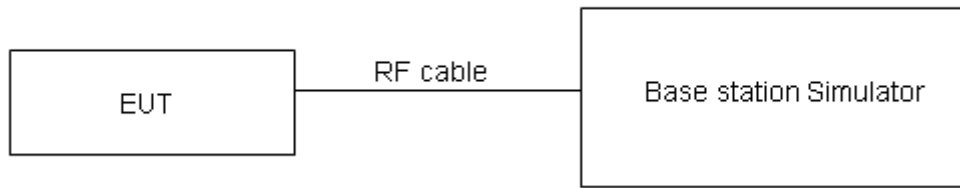

The loss between RF output port of the EUT and the input port of the tester has been taken into consideration.

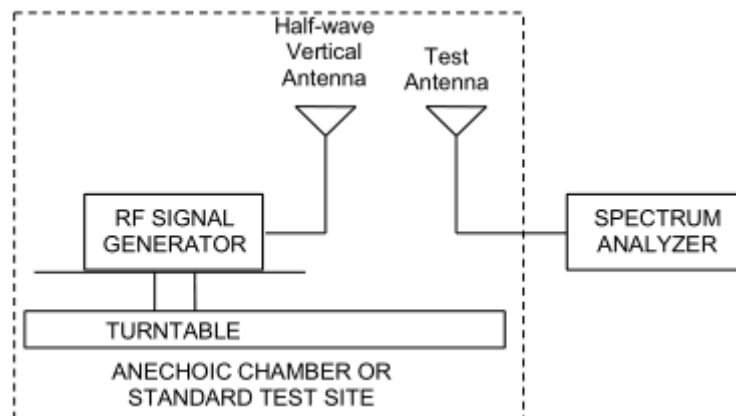
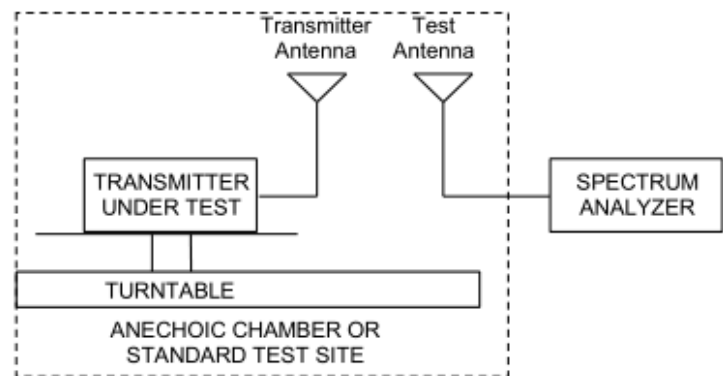

Limits

No specific RF power output requirements in part 2.1046.

Rule Part 22.913(a)(5) specifies that "Mobile/portable stations are limited to 7 watts ERP".

Limit	$\leq 7 \text{ W}$ (38.45 dBm)
-------	--------------------------------

Measurement Uncertainty

The assessed measurement uncertainty to ensure 95% confidence level for the normal distribution is with the coverage factor $k = 2$, $U = 0.4 \text{ dB}$ for RF power output, $k = 2$, $U = 1.19 \text{ dB}$ for ERP .

Test Results

GSM 850		Conducted Power (dBm)			ERP (dBm)		
		Channel 128	Channel 190	Channel 251	Channel 128	Channel 190	Channel 251
		824.2 (MHz)	836.6 (MHz)	848.8 (MHz)	824.2 (MHz)	836.6 (MHz)	848.8 (MHz)
GSM(GMSK)	Results	32.43	32.38	32.37	32.81	32.12	32.51
GPRS (GMSK)	1TXslot	32.40	32.47	32.41	32.78	32.21	32.55
	2TXslots	31.80	31.76	31.81	32.18	31.50	31.95
	3TXslots	29.59	30.10	30.26	29.97	29.84	30.40
	4TXslots	28.84	28.79	28.92	29.22	28.53	29.06
EGPRS (8PSK)	1TXslot	26.41	26.24	26.26	26.79	25.98	26.40
	2TXslots	26.01	25.93	25.91	26.39	25.67	26.05
	3TXslots	24.40	24.22	24.37	24.78	23.96	24.51
	4TXslots	23.02	23.01	23.12	23.40	22.75	23.26

LTE Band 5	Channel/ Frequency(MHz)	Index	RB# RBstart	Conducted Power (dBm)		ERP (dBm)	
				QPSK	16QAM	QPSK	16QAM
1.4MHz	20407/824.7	0	1#0	23.22	23.04	23.60	23.42
		0	6#0	21.57	21.33	21.95	21.71
	20525/836.5	0	1#0	23.04	22.58	22.78	22.32
		0	6#0	21.27	21.13	21.01	20.87
	20643/848.3	0	1#5	23.64	23.13	23.78	23.27
		0	6#0	21.97	21.90	22.11	22.04
3MHz	20415/825.5	0	1#0	23.57	23.00	23.55	22.98
		0	6#0	21.46	21.58	21.44	21.56
	20525/836.5	0	1#0	23.65	22.32	23.39	22.06
		0	6#0	21.24	21.70	20.98	21.44
	20635/847.5	1	1#5	23.75	23.21	23.89	23.35
		1	6#0	22.01	22.02	22.15	22.16
5MHz	20425/826.5	3	1#0	23.42	23.65	23.40	23.63
		0	6#0	22.67	21.66	22.65	21.64
	20525/836.5	0	1#0	23.36	23.04	23.10	22.78
		0	6#0	22.41	21.73	22.15	21.47
	20625/846.5	0	1#5	23.98	23.55	24.12	23.69
		3	6#0	22.99	22.51	23.13	22.65
10MHz	20450/829	3	1#0	23.60	23.16	23.58	23.14
		0	4#0	23.65	23.03	23.63	23.01
	20525/836.5	0	1#0	23.51	23.10	23.25	22.84



20600/844	0	4#0	23.41	22.85	23.15	22.59
	4	1#5	23.81	23.98	23.95	24.12
	7	4#2	23.95	23.24	24.09	23.38

LTE Band 26	Channel/ Frequency(MHz)	Index	RB# RBstart	Conducted Power (dBm)		ERP (dBm)	
				QPSK	16QAM	QPSK	16QAM
1.4MHz	26797/824.7	0	1#0	23.15	22.60	23.53	22.98
		0	6#0	21.32	21.14	21.70	21.52
	26915/836.5	0	1#0	23.54	22.95	23.28	22.69
		0	6#0	21.52	21.51	21.26	21.25
	27033/848.3	0	1#5	23.99	22.61	24.13	22.75
		0	6#0	21.80	22.52	21.94	22.66
3MHz	26805/825.5	0	1#0	23.84	22.45	23.82	22.43
		0	6#0	21.22	21.62	21.20	21.60
	26915/836.5	0	1#0	23.98	22.58	23.72	22.32
		0	6#0	21.54	21.95	21.28	21.69
	27025/847.5	1	1#5	23.99	22.61	24.13	22.75
		1	6#0	21.70	22.24	21.84	22.38
5MHz	26815/826.5	3	1#0	23.50	23.35	23.48	23.33
		0	6#0	22.46	21.82	22.44	21.80
	26915/836.5	0	1#0	23.55	23.74	23.29	23.48
		0	6#0	22.53	21.53	22.27	21.27
	27015/846.5	0	1#5	23.90	23.41	24.04	23.55
		3	6#0	22.87	22.16	23.01	22.30
10MHz	26840/829	3	1#0	23.47	23.25	23.45	23.23
		0	4#0	23.40	22.89	23.38	22.87
	26915/836.5	0	1#0	23.39	23.74	23.13	23.48
		0	4#0	23.57	22.68	23.31	22.42
	26990/844	4	1#5	23.78	23.38	23.92	23.52
		7	4#2	23.91	23.23	24.05	23.37
15MHz	26865/831.5	3	1#0	23.44	23.34	23.42	23.32
		0	6#0	23.30	23.61	23.28	23.59
	26915/836.5	0	1#0	23.49	23.25	23.23	22.99
		0	6#0	23.41	23.75	23.15	23.49
	26965/841.5	8	1#5	23.86	23.39	24.00	23.53
		11	6#0	23.91	23.97	24.05	24.11

5.2. Occupied Bandwidth

Ambient condition

Temperature	Relative humidity	Pressure
23°C ~25°C	45%~50%	101.5kPa

Method of Measurement

The EUT was connected to Spectrum Analyzer and Base Station Simulator via power Splitter. The occupied bandwidth is measured using spectrum analyzer.

RBW is set to 3kHz, VBW is set to 10kHz for GSM 850,

RBW is set to 51kHz, VBW is set to 160kHz for LTE Band 5 /26

99% power and -26dBc occupied bandwidths are recorded. Spectrum analyzer plots are included on the following pages.

Test Setup

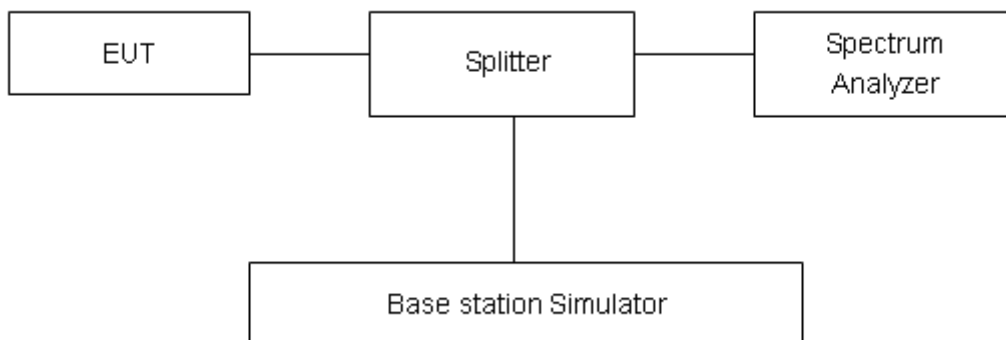

Limits

No specific occupied bandwidth requirements in part 2.1049.

Measurement Uncertainty

The assessed measurement uncertainty to ensure 95% confidence level for the normal distribution is with the coverage factor $k = 2$, $U = 624\text{Hz}$.

Test Result

Mode	Channel	Frequency (MHz)	99% Power Bandwidth (MHz)	-26dBc Bandwidth(MHz)
GSM 850 (GMSK)	128	824.2	0.2448	0.299
	190	836.6	0.2458	0.300
	251	848.8	0.2454	0.298
GPRS 850 (GMSK)	128	824.2	0.2437	0.308
	190	836.6	0.2477	0.323
	251	848.8	0.2434	0.318
EGPRS 850 (8PSK)	128	824.2	0.2468	0.304
	190	836.6	0.2483	0.309
	251	848.8	0.2449	0.308

Mode	Bandwidth	Modulation	Channel/ Frequency(MHz)	RB	Bandwidth(MHz)	
					99% Power	-26dBc
LTE Band 5	1.4MHz	QPSK	20525/836.5	6#0	1.1081	1.320
		16QAM	20525/836.5	6#0	0.9403	1.250
	3MHz	QPSK	20525/836.5	6#0	1.1043	1.330
		16QAM	20525/836.5	6#0	0.9534	1.263
	5MHz	QPSK	20525/836.5	6#0	1.1038	1.365
		16QAM	20525/836.5	6#0	0.9510	1.144
10MHz	QPSK	20525/836.5	6#0	1.1150	1.320	
	16QAM	20525/836.5	6#0	0.9615	1.209	

Mode	Bandwidth	Modulation	Channel/ Frequency(MHz)	RB	Bandwidth(MHz)	
					99% Power	-26dBc
LTE Band 26	1.4MHz	QPSK	26915/836.5	6#0	1.1080	1.350
		16QAM	26915/836.5	6#0	0.9403	1.174
	3MHz	QPSK	26915/836.5	6#0	1.1048	1.337
		16QAM	26915/836.5	6#0	0.9408	1.178
	5MHz	QPSK	26915/836.5	6#0	1.1129	1.372
		16QAM	26915/836.5	6#0	0.9469	1.206
	10MHz	QPSK	26915/836.5	6#0	1.1157	1.341
		16QAM	26915/836.5	6#0	0.9601	1.243
15MHz	QPSK	26915/836.5	6#0	1.1261	1.365	
	16QAM	26915/836.5	6#0	0.9611	1.190	

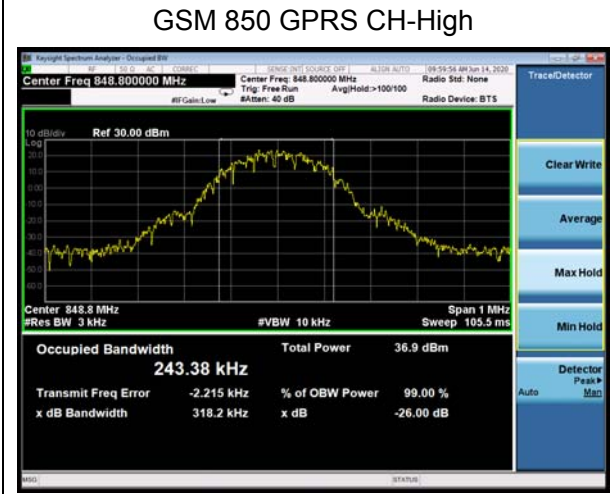
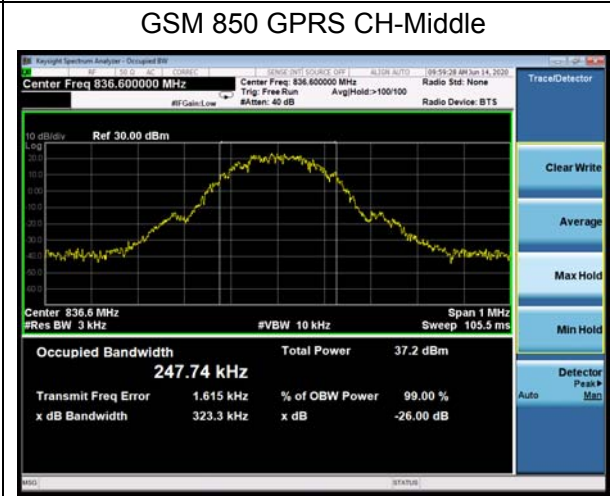
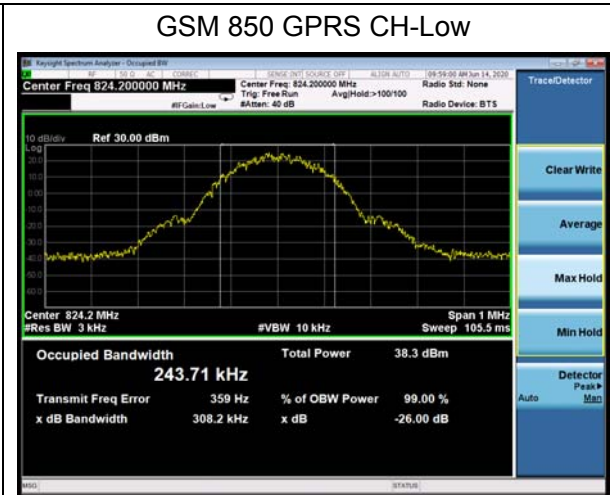

GSM 850 EGPRS CH-Low



GSM 850 EGPRS CH-Middle



GSM 850 EGPRS CH-High

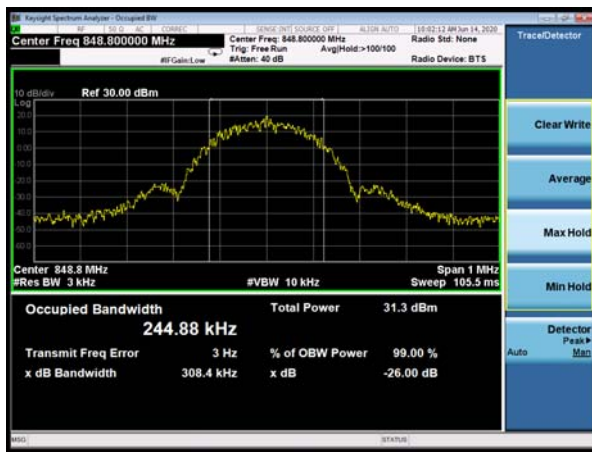

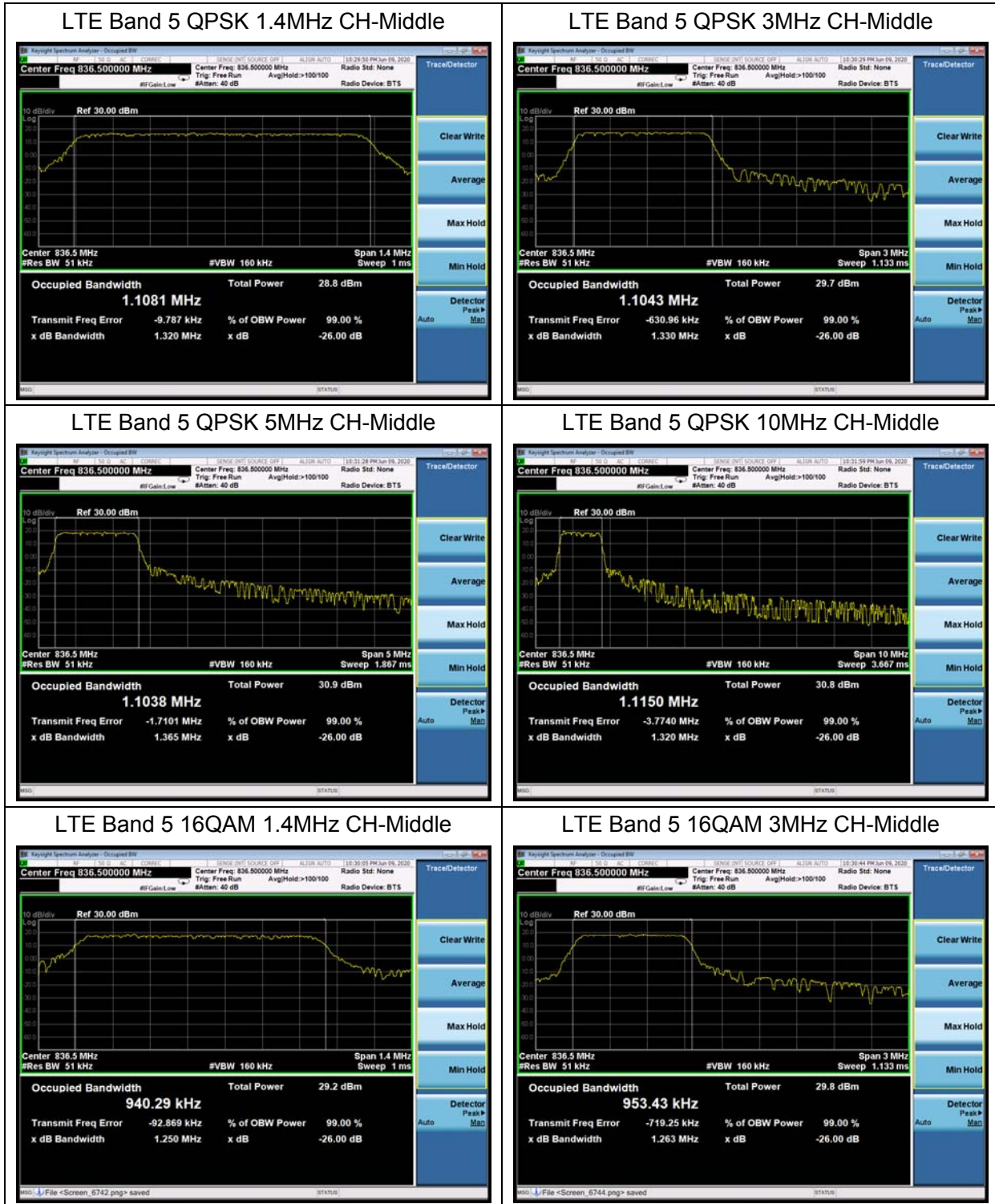

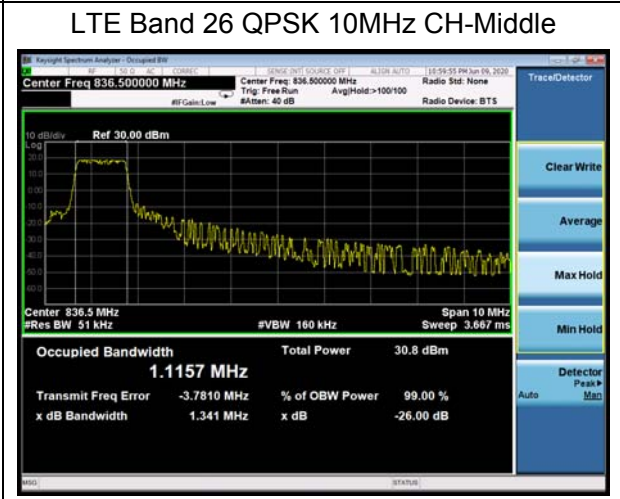
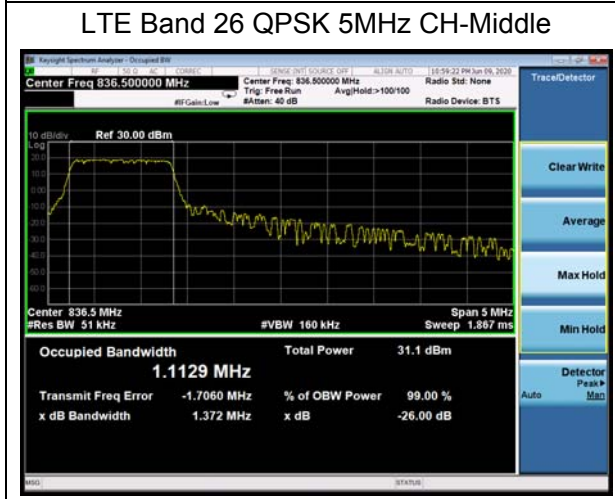
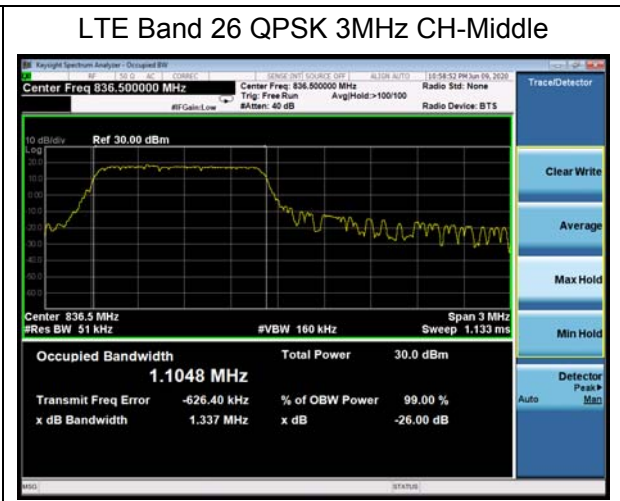
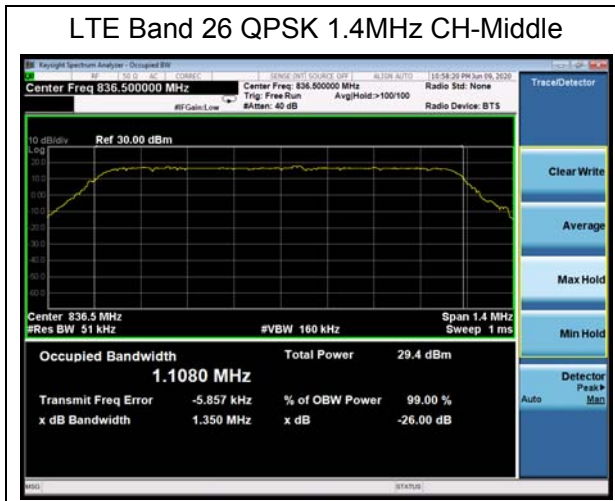
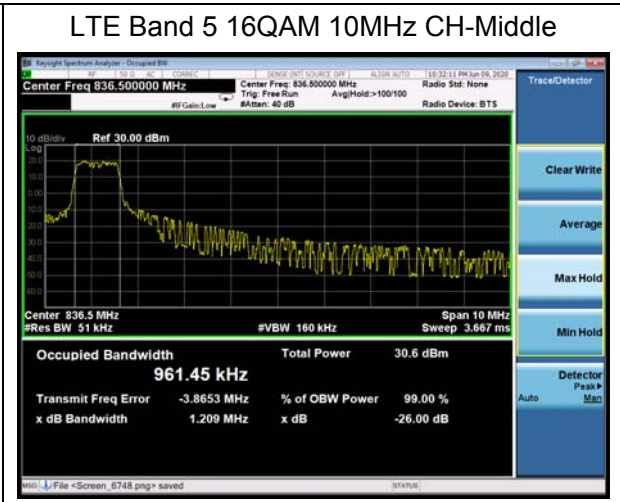
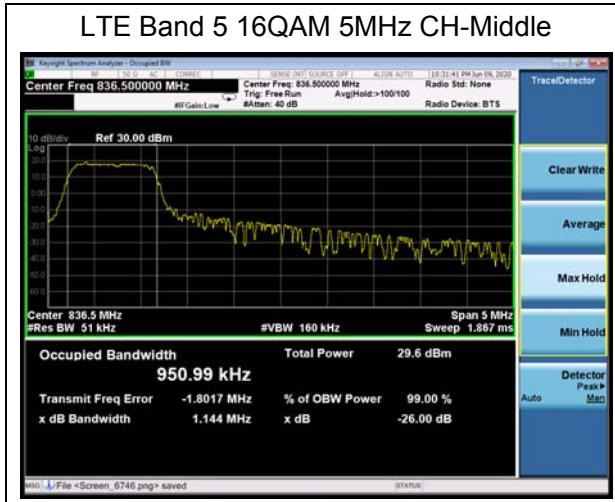

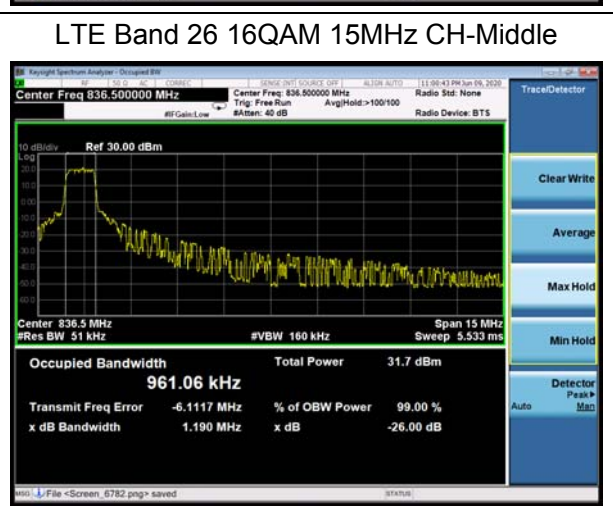
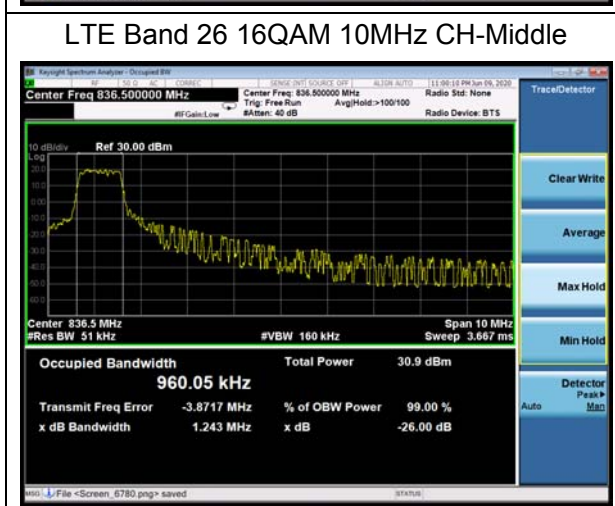
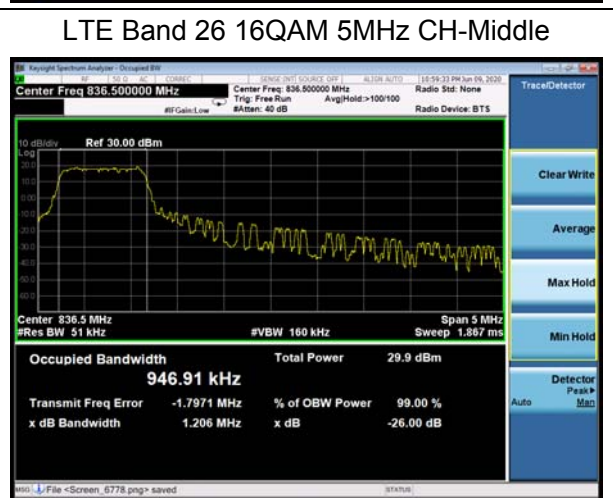
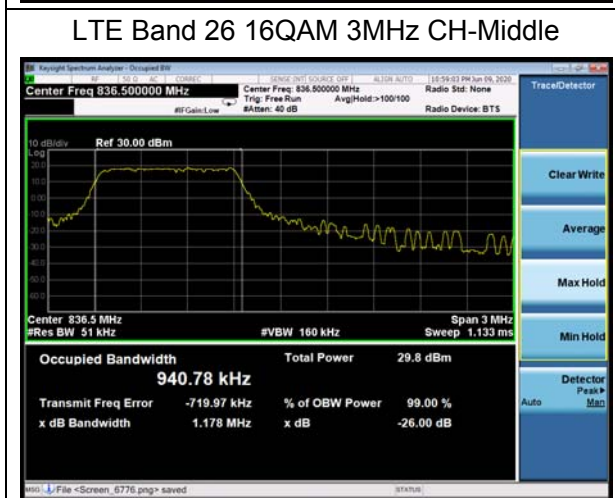
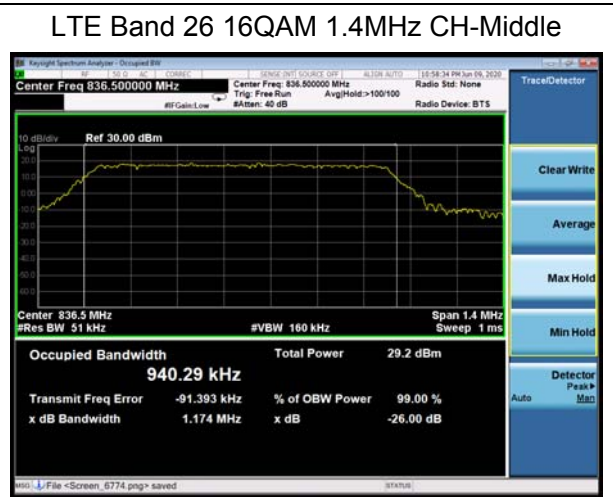
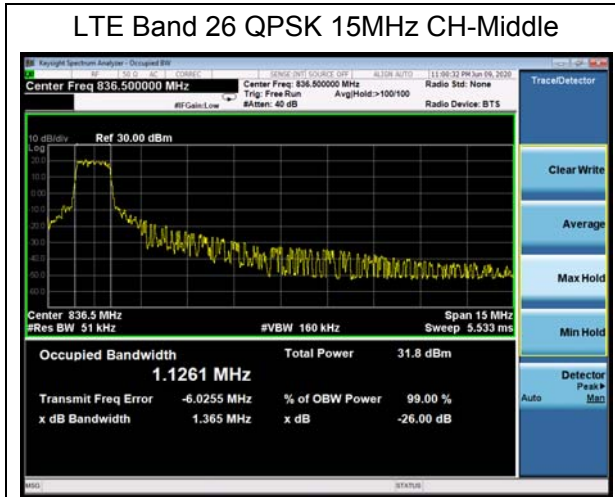

5.3. Band Edge Compliance

Ambient condition

Temperature	Relative humidity	Pressure
23°C ~25°C	45%~50%	101.5kPa

Method of Measurement

The EUT was connected to Spectrum Analyzer and Base Station Simulator via power Splitter. The band edge of the lowest and highest channels were measured. The average detector is used.

RBW is set to 3kHz,VBW is set to 10kHz for GSM 850,

RBW is set to 51kHz, VBW is set to 160kHz for LTE Band 5 /26

Spectrum analyzer plots are included on the following pages.

Test Setup

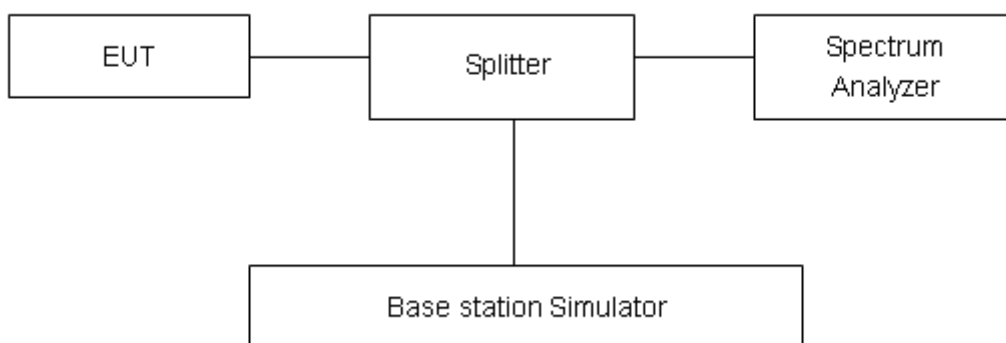

Limits

Rule Part 22.917(a) specifies that “The power of any emission outside of the authorized operating frequency ranges must be attenuated below the transmitting power (P) by a factor of at least 43 + 10 log(P) dB.”

Limit	-13 dBm
-------	---------

Measurement Uncertainty

The assessed measurement uncertainty to ensure 95% confidence level for the normal distribution is with the coverage factor $k = 1.96$, $U=0.684$ dB.

Test Result:

GSM 850 CH-Low

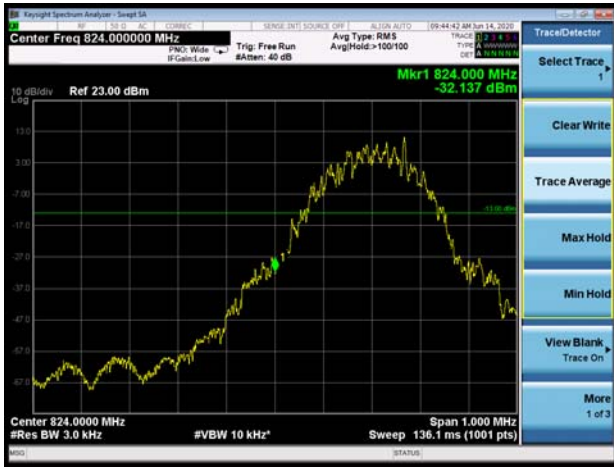

GSM 850 CH-High

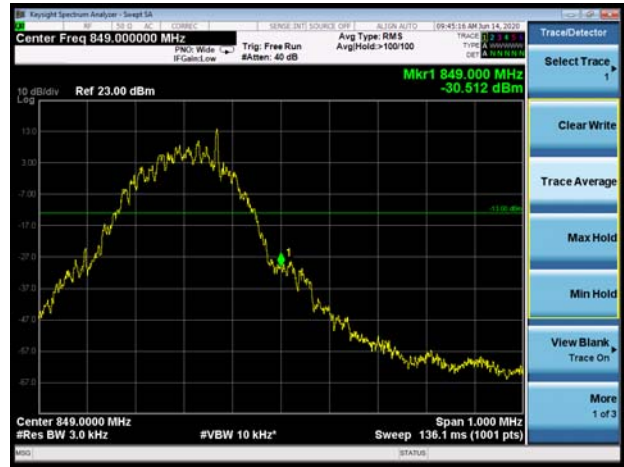

GSM 850 GPRS CH-Low

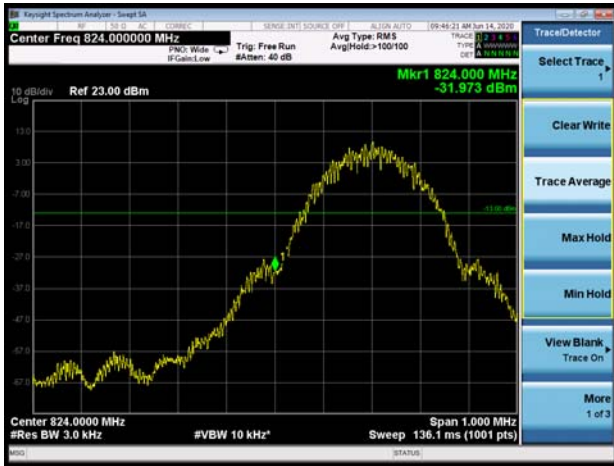

GSM 850 GPRS CH-High



GSM 850 EGPRS CH-Low

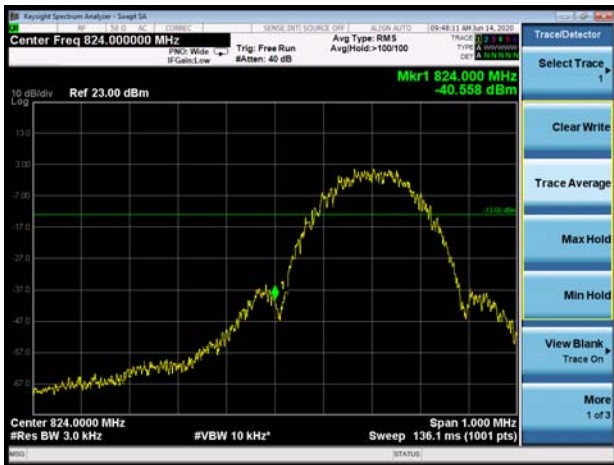

GSM 850 EGPRS CH-High

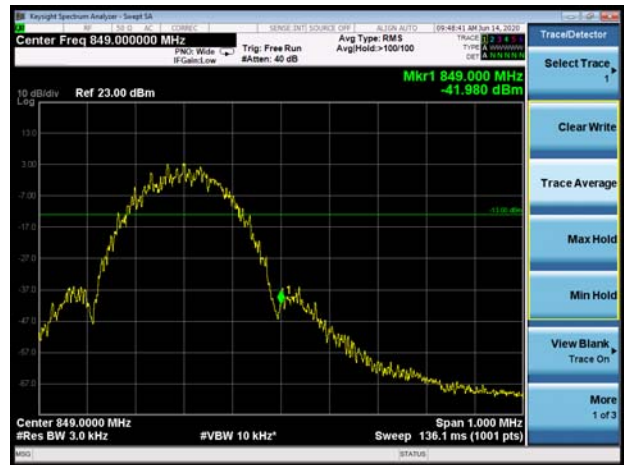

LTE Band 5 QPSK 1.4MHz CH-Low 1RB



LTE Band 5 QPSK 1.4MHz CH-High 1RB



LTE Band 5 QPSK 1.4MHz CH-Low 100%RB

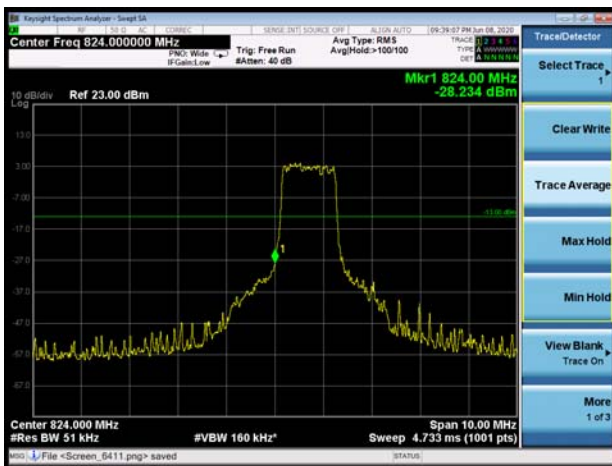

LTE Band 5 QPSK 1.4MHz CH-High 100%RB

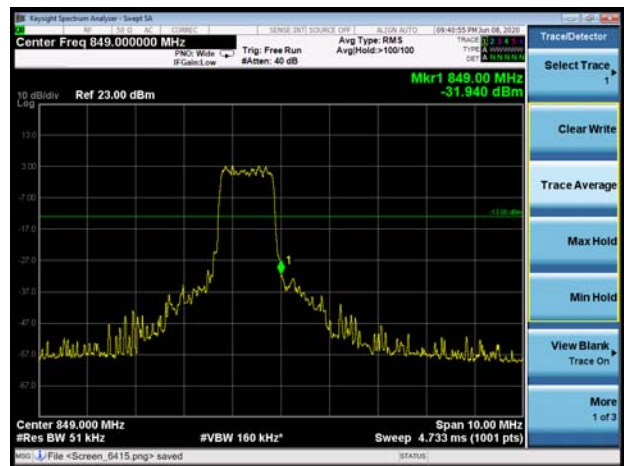

LTE Band 5 QPSK 3MHz CH-Low 1RB

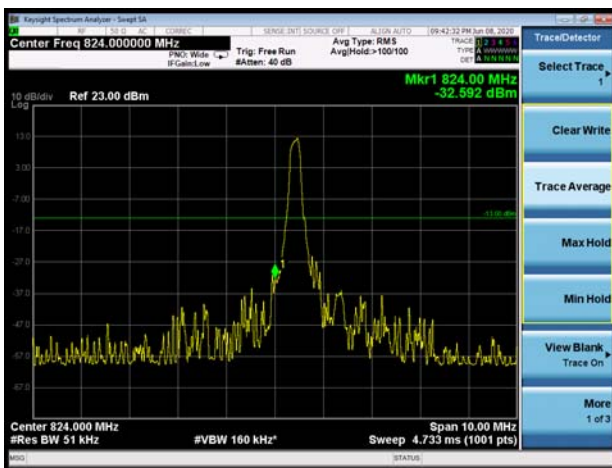

LTE Band 5 QPSK 3MHz CH-High 1RB

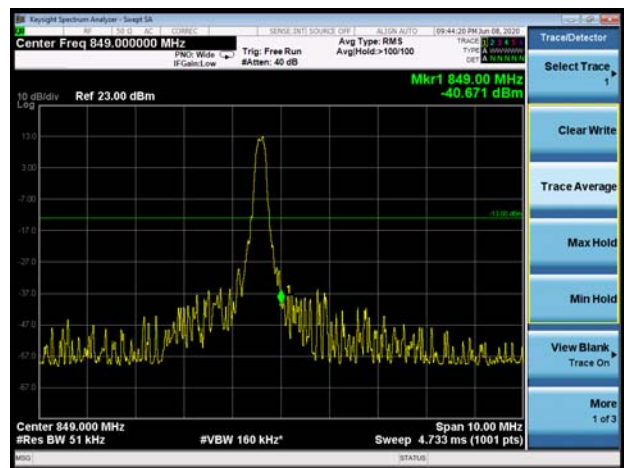

LTE Band 5 QPSK 3MHz CH-Low 100%RB

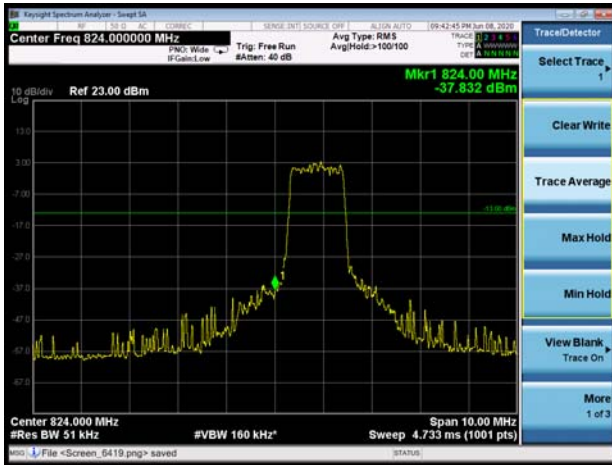

LTE Band 5 QPSK 3MHz CH-High 100%RB

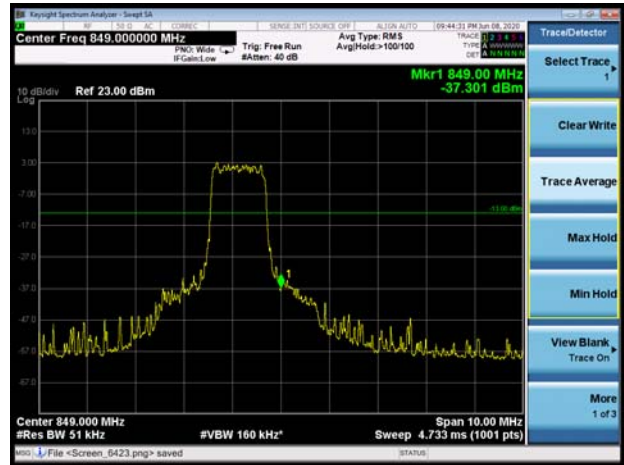

LTE Band 5 QPSK 5MHz CH-Low 1RB

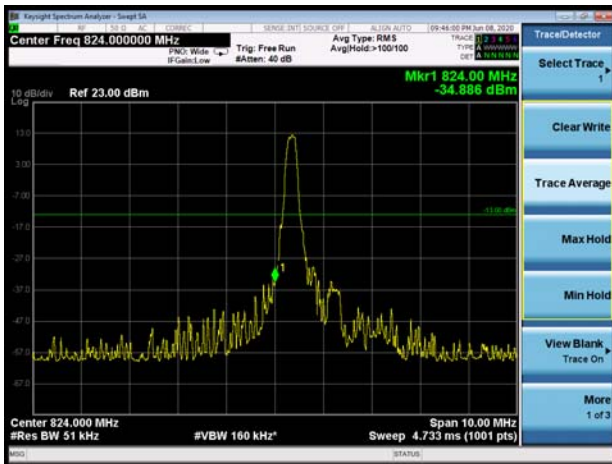

LTE Band 5 QPSK 5MHz CH-High 1RB

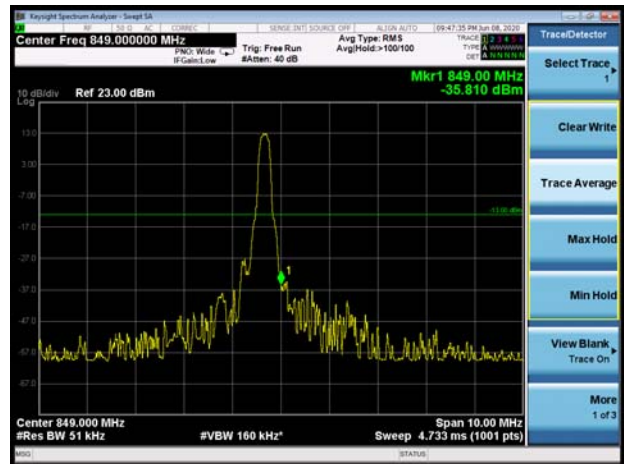

LTE Band 5 QPSK 5MHz CH-Low 100%RB

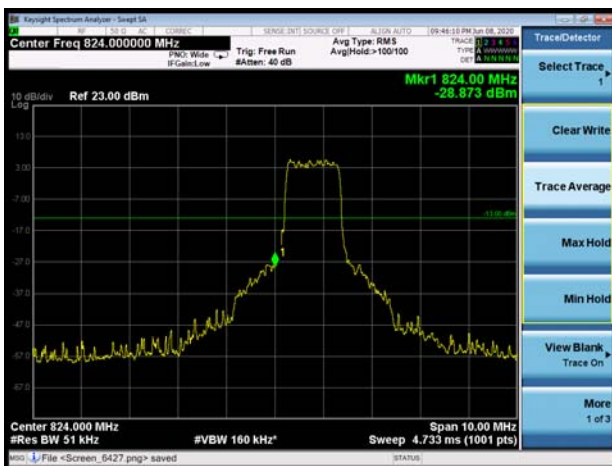

LTE Band 5 QPSK 5MHz CH-High 100%RB

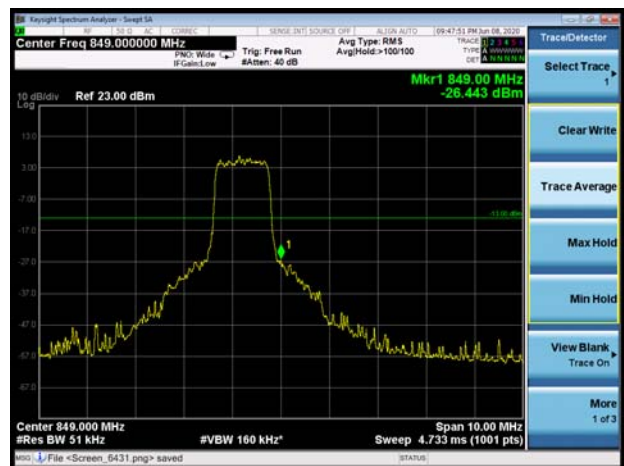

LTE Band 5 QPSK 10MHz CH-Low 1RB

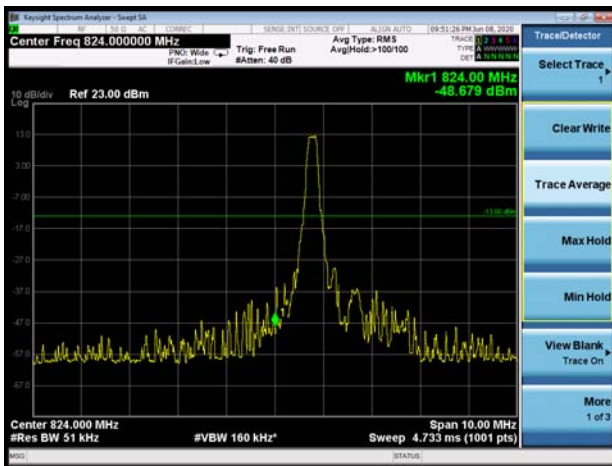

LTE Band 5 QPSK 10MHz CH-High 1RB

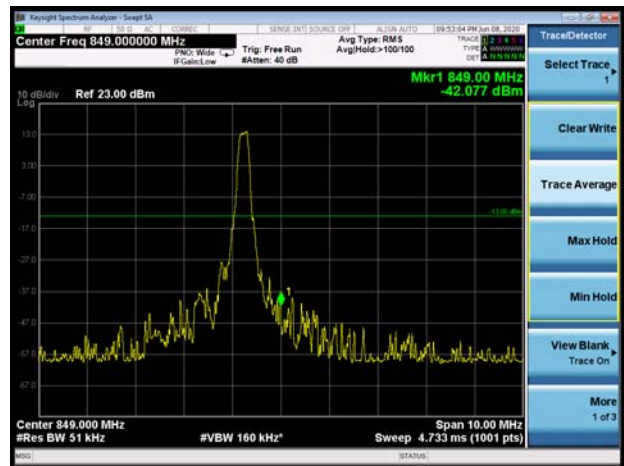

LTE Band 5 QPSK 10MHz CH-Low 100%RB

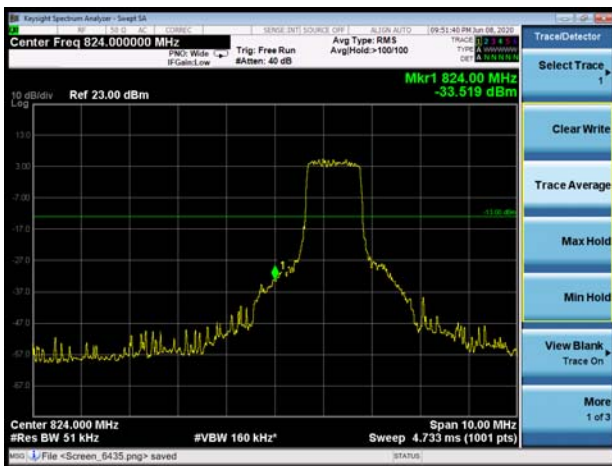

LTE Band 5 QPSK 10MHz CH-High 100%RB

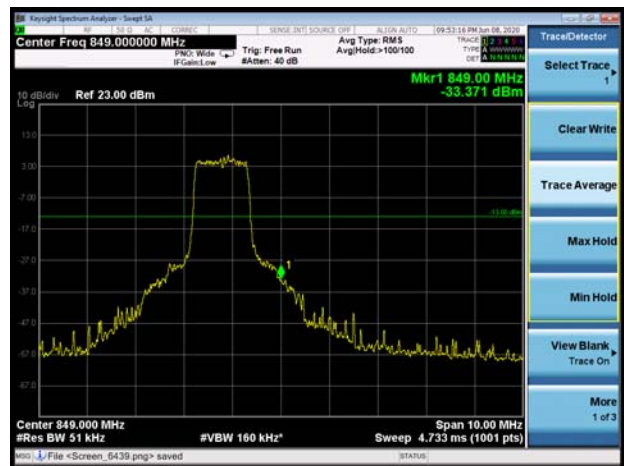

LTE Band 5 16QAM 1.4MHz CH-Low 1RB

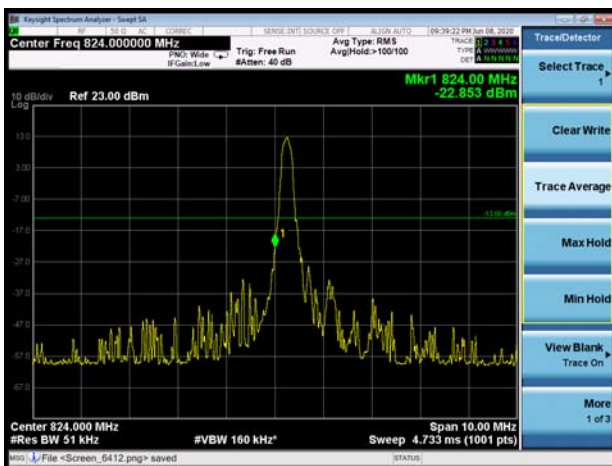

LTE Band 5 16QAM 1.4MHz CH-High 1RB

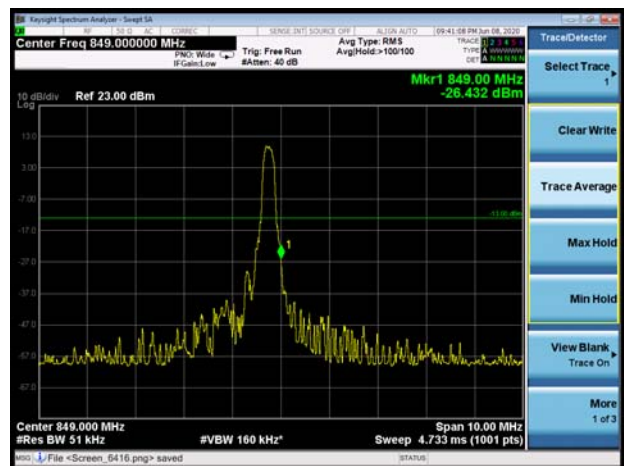

LTE Band 5 16QAM 1.4MHz CH-Low 100%RB

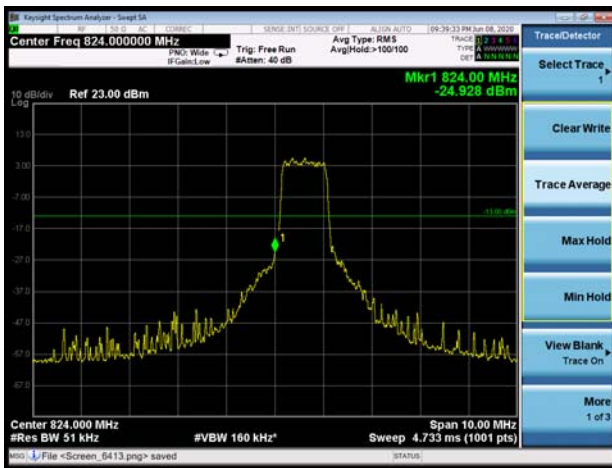

LTE Band 5 16QAM 1.4MHz CH-High 100%RB

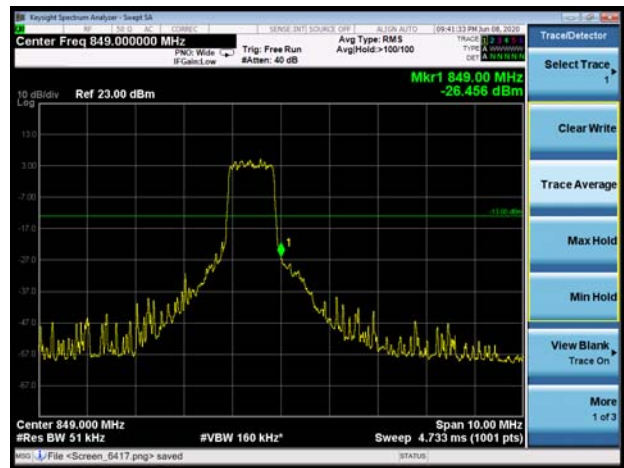

LTE Band 5 16QAM 3MHz CH-Low 1RB

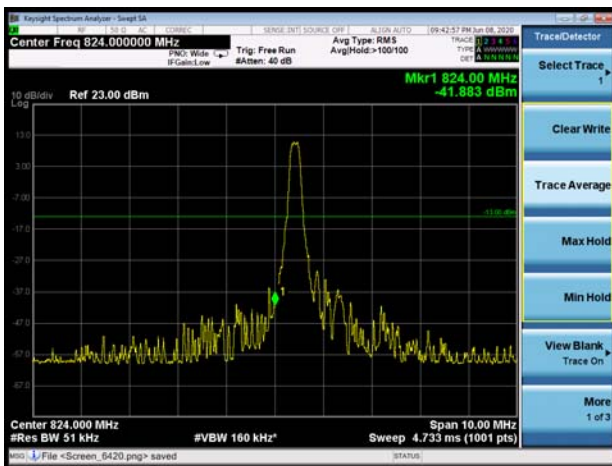

LTE Band 5 16QAM 3MHz CH-High 1RB

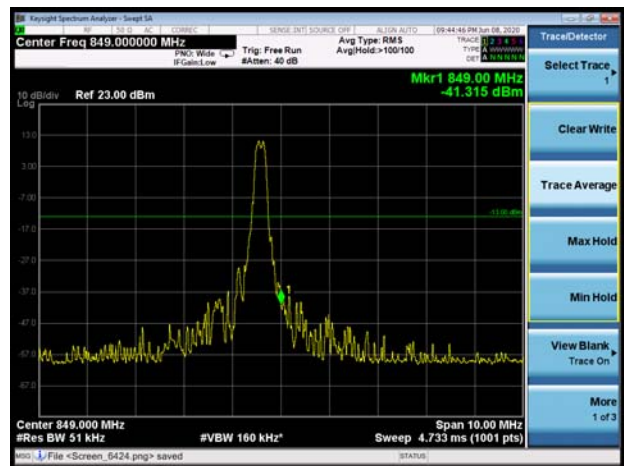

LTE Band 5 16QAM 3MHz CH-Low 100%RB

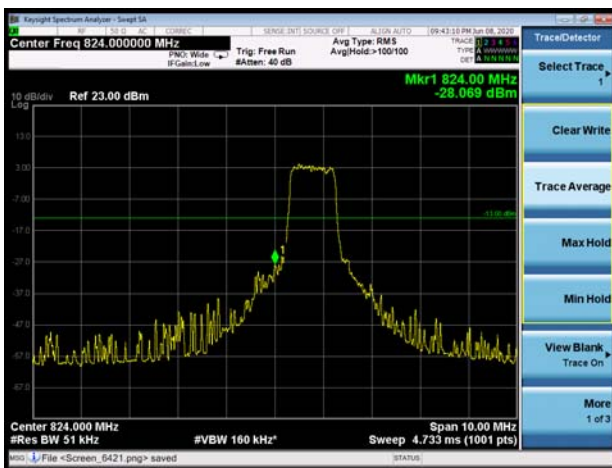

LTE Band 5 16QAM 3MHz CH-High 100%RB

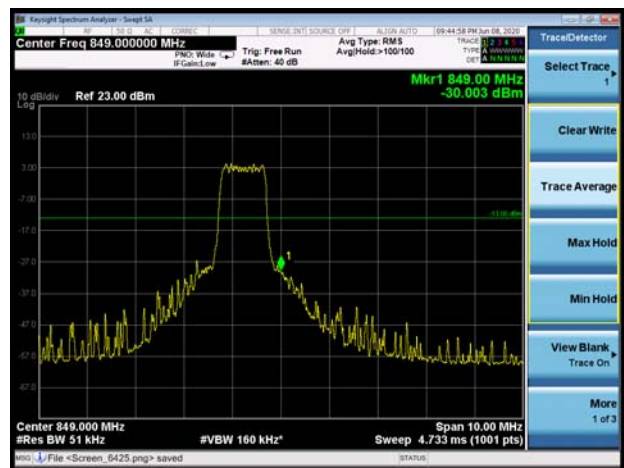

LTE Band 5 16QAM 5MHz CH-Low 1RB

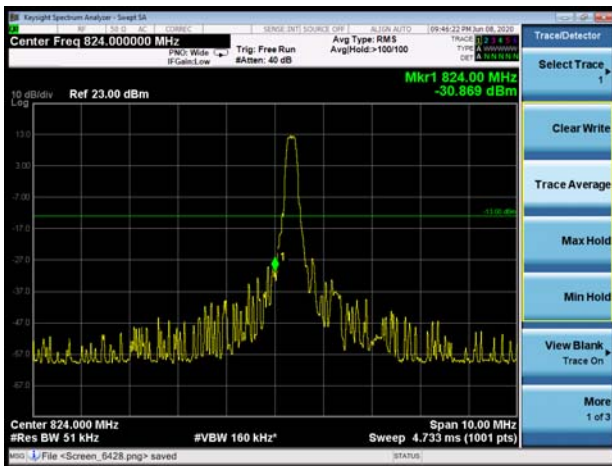

LTE Band 5 16QAM 5MHz CH-High 1RB



LTE Band 5 16QAM 5MHz CH-Low 100%RB

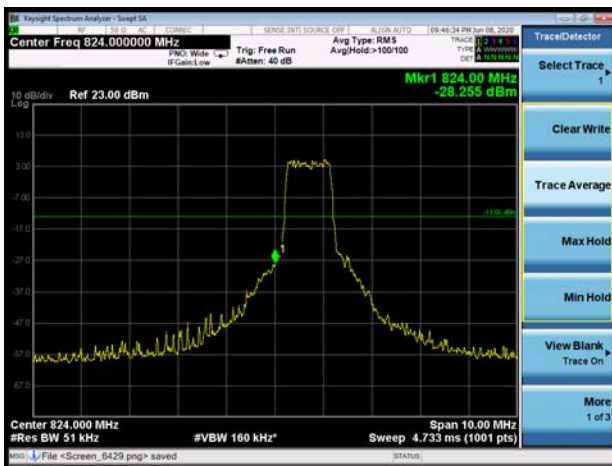

LTE Band 5 16QAM 5MHz CH-High 100%RB

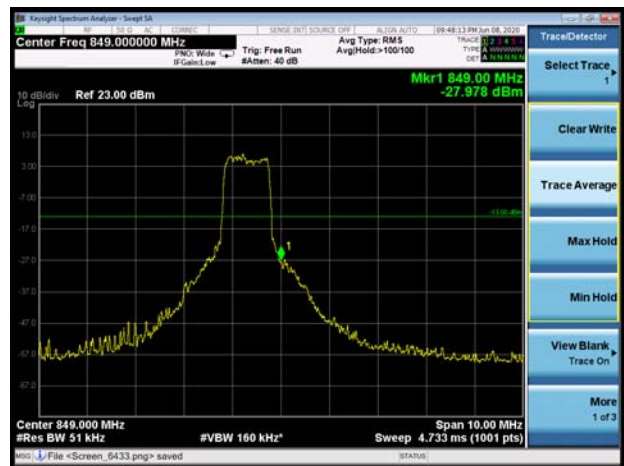

LTE Band 5 16QAM 10MHz CH-Low 1RB

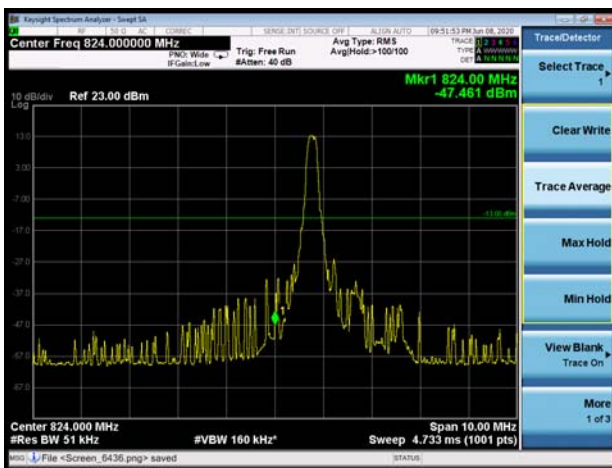

LTE Band 5 16QAM 10MHz CH-High 1RB

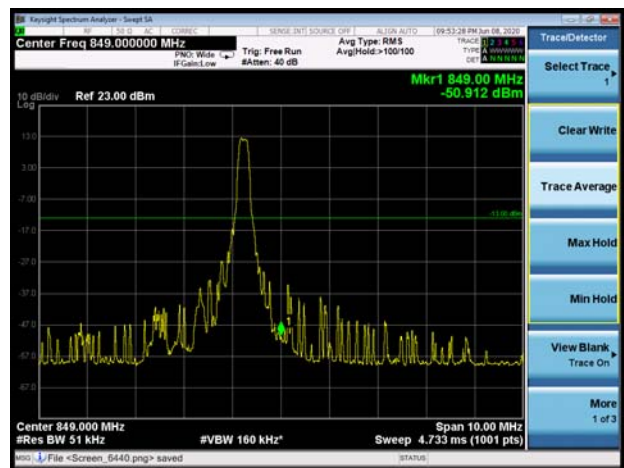

LTE Band 5 16QAM 10MHz CH-Low 100%RB

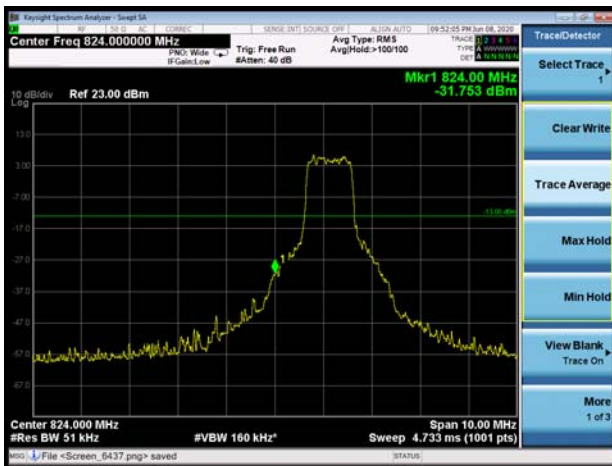

LTE Band 5 16QAM 10MHz CH-High 100%RB

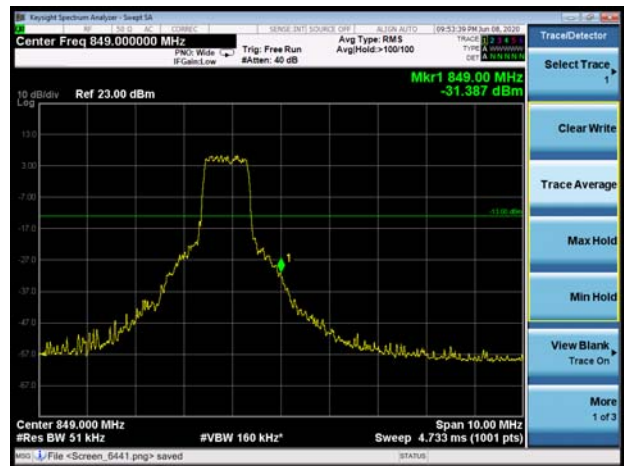

LTE Band 26 QPSK 1.4MHz CH-Low 1RB



LTE Band 26 QPSK 1.4MHz CH-High 1RB

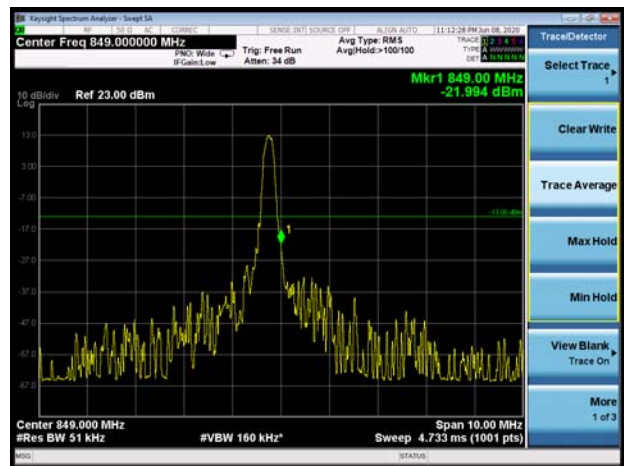

LTE Band 26 QPSK 1.4MHz CH-Low 100%RB

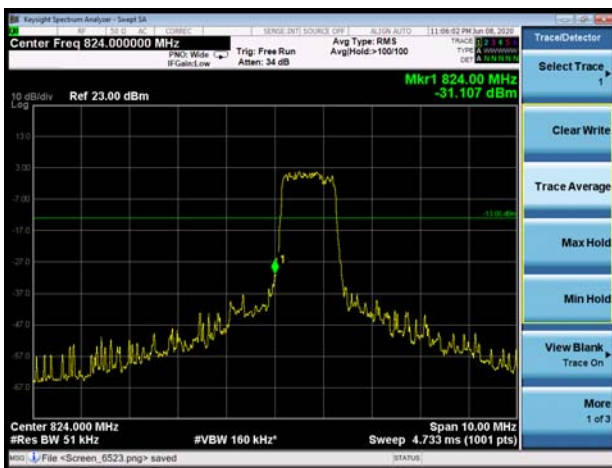

LTE Band 26 QPSK 1.4MHz CH-High 100%RB

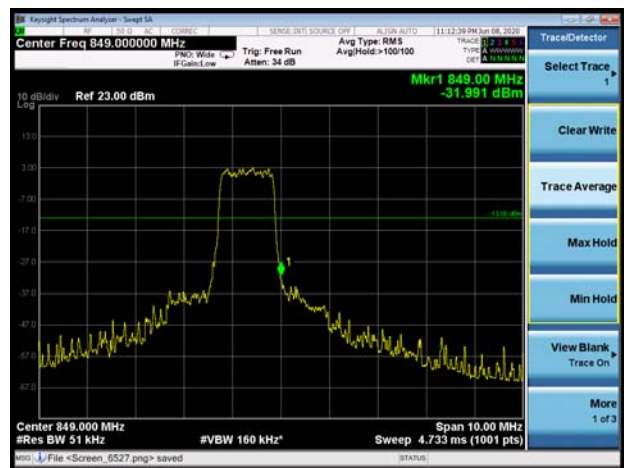

LTE Band 26 QPSK 3MHz CH-Low 1RB

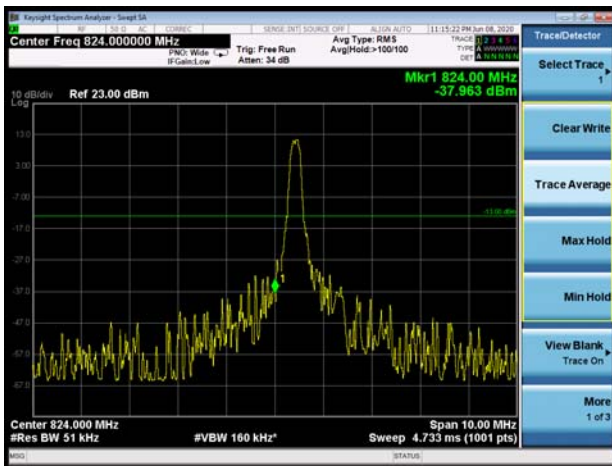

LTE Band 26 QPSK 3MHz CH-High 1RB

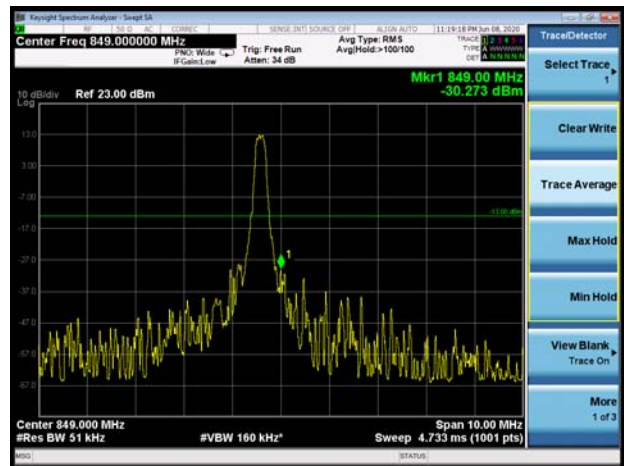

LTE Band 26 QPSK 3MHz CH-Low 100%RB

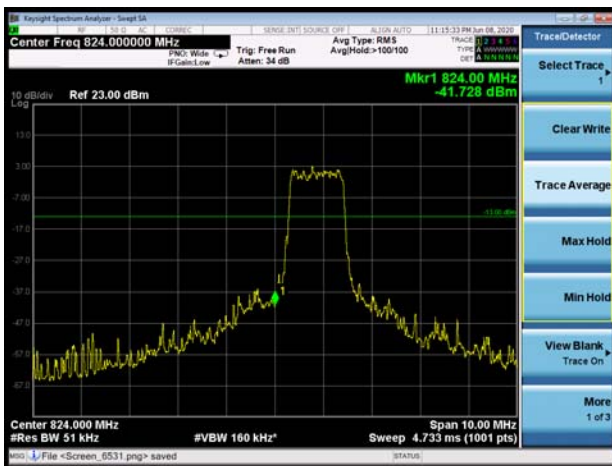

LTE Band 26 QPSK 3MHz CH-High 100%RB

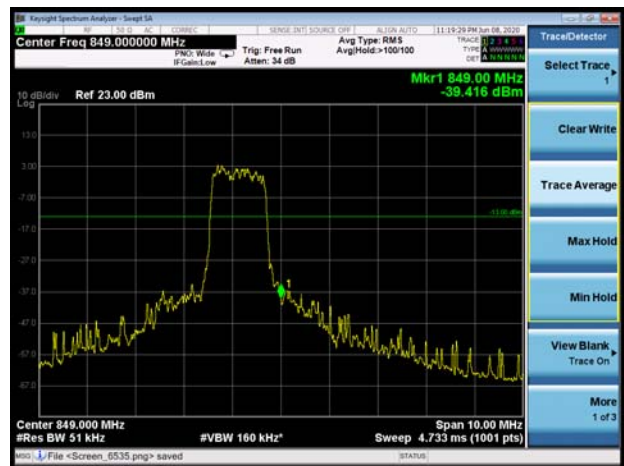

LTE Band 26 QPSK 5MHz CH-Low 1RB

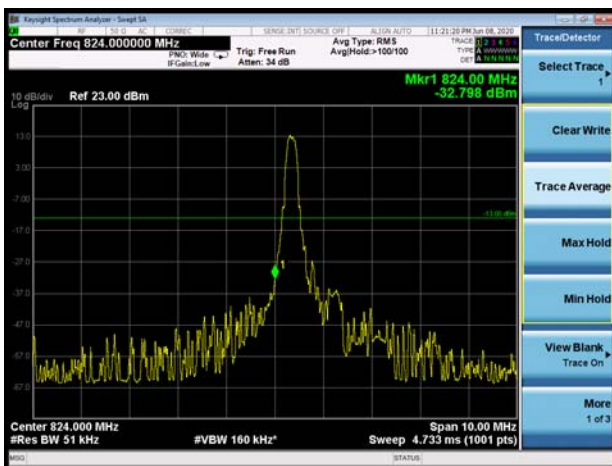

LTE Band 26 QPSK 5MHz CH-High 1RB

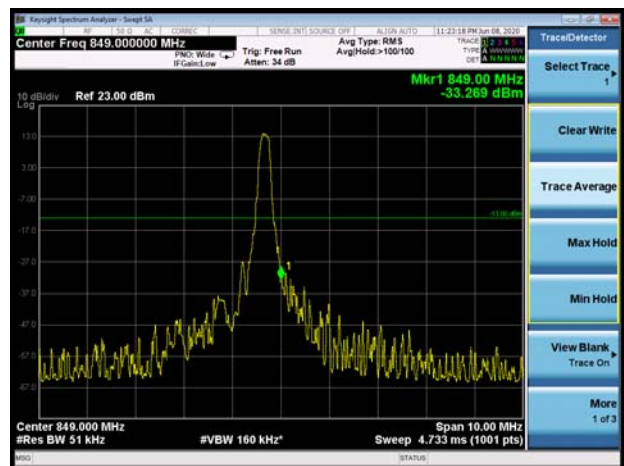

LTE Band 26 QPSK 5MHz CH-Low 100%RB

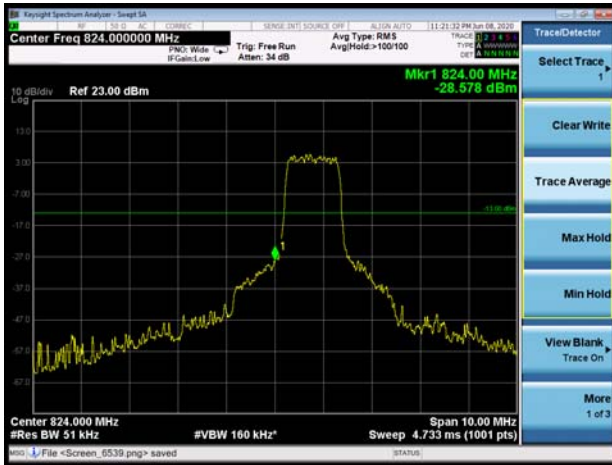

LTE Band 26 QPSK 5MHz CH-High 100%RB

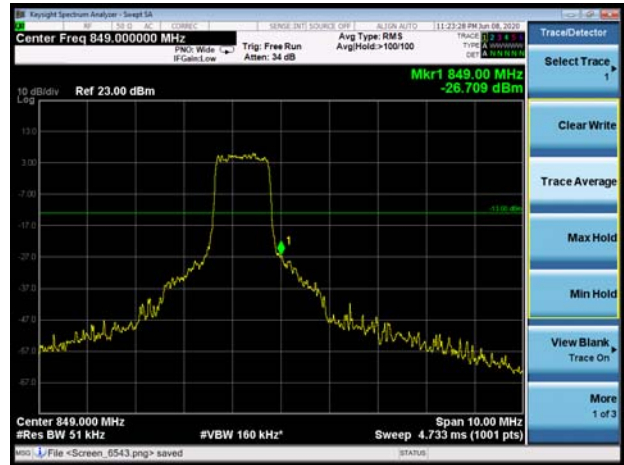

LTE Band 26 QPSK 10MHz CH-Low 1RB

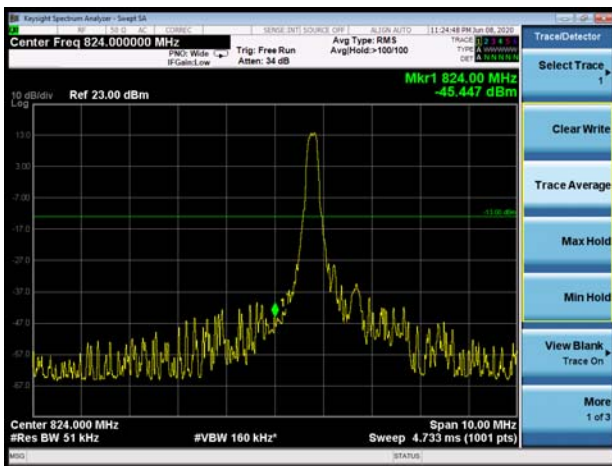

LTE Band 26 QPSK 10MHz CH-High 1RB

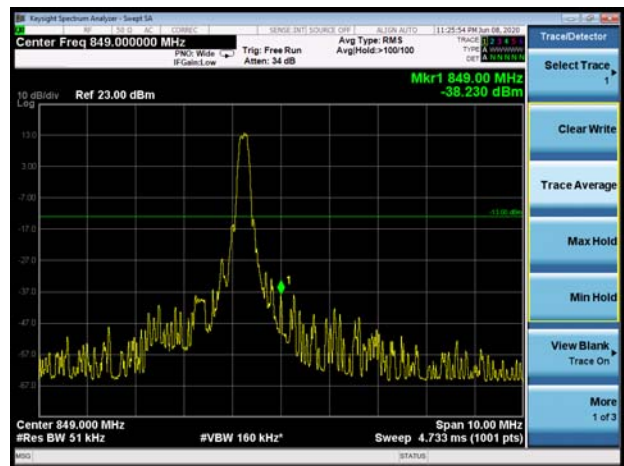

LTE Band 26 QPSK 10MHz CH-Low 100%RB

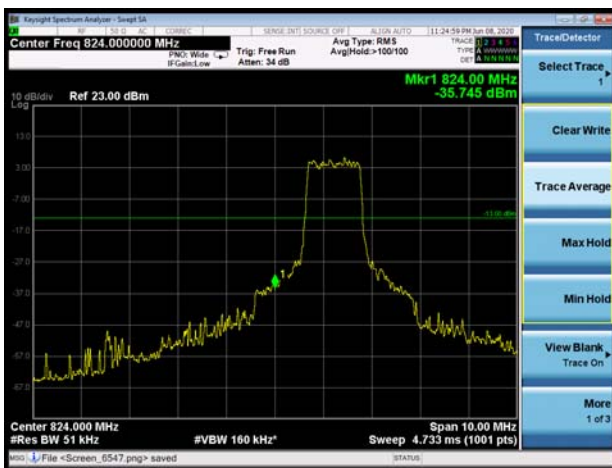

LTE Band 26 QPSK 10MHz CH-High 100%RB

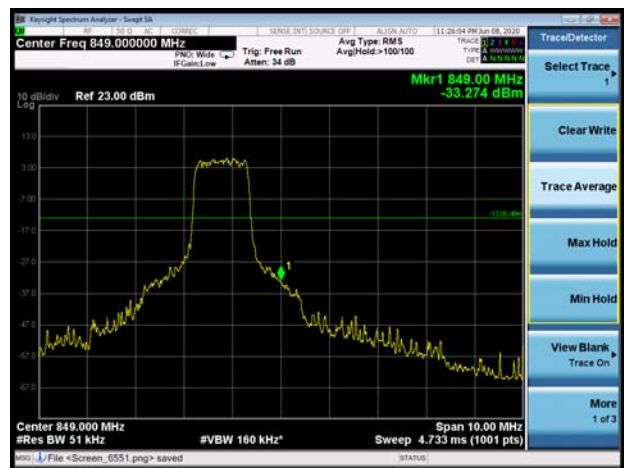

LTE Band 26 QPSK 15MHz CH-Low 1RB

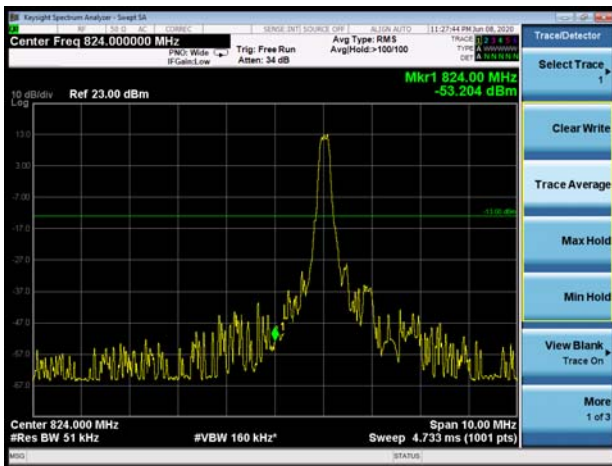

LTE Band 26 QPSK 15MHz CH-High 1RB

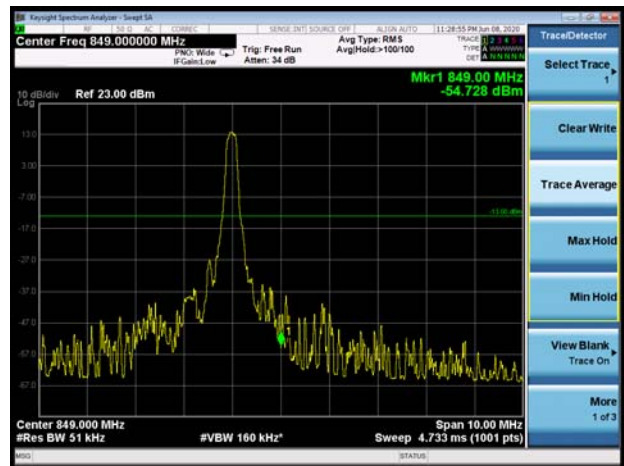

LTE Band 26 QPSK 15MHz CH-Low 100%RB

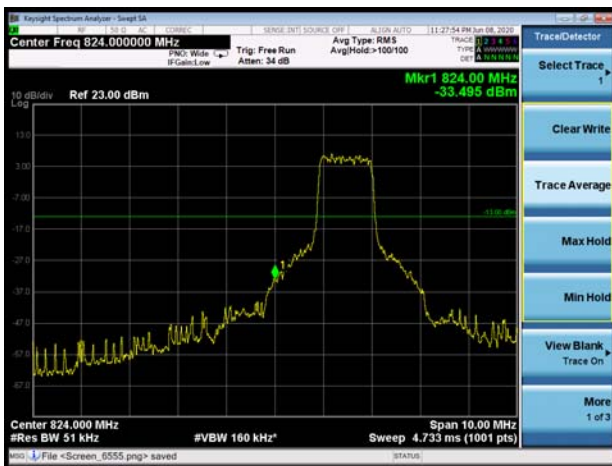

LTE Band 26 QPSK 15MHz CH-High 100%RB

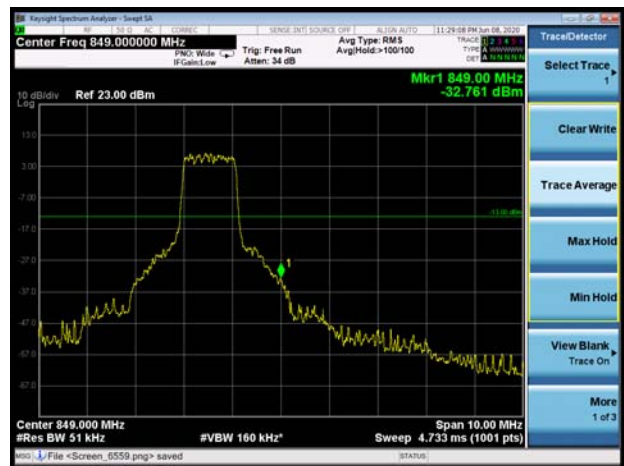

LTE Band 26 16QAM 1.4MHz CH-Low 1RB



LTE Band 26 16QAM 1.4MHz CH-High 1RB

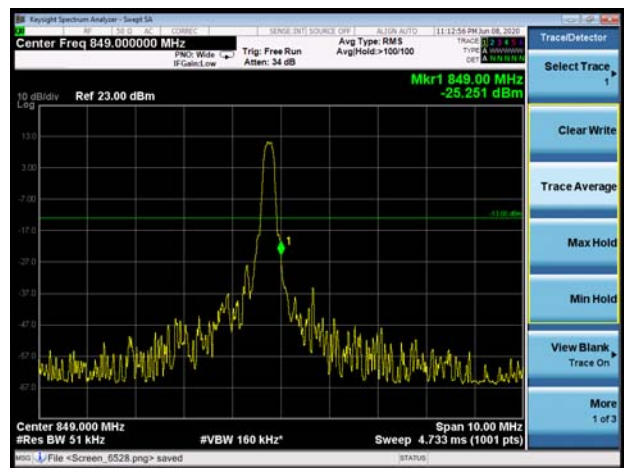

LTE Band 26 16QAM 1.4MHz CH-Low 100%RB

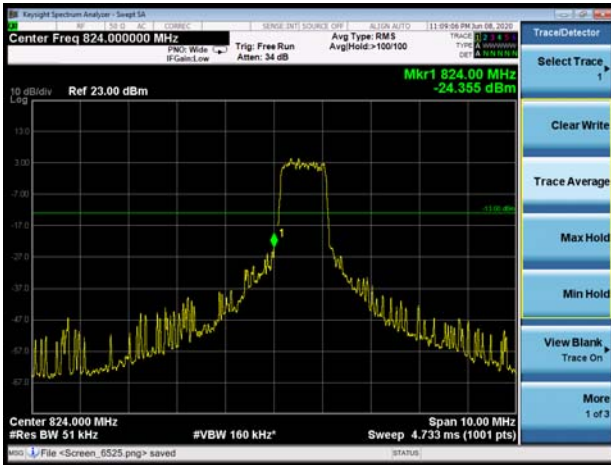

LTE Band 26 16QAM 1.4MHz CH-High 100%RB

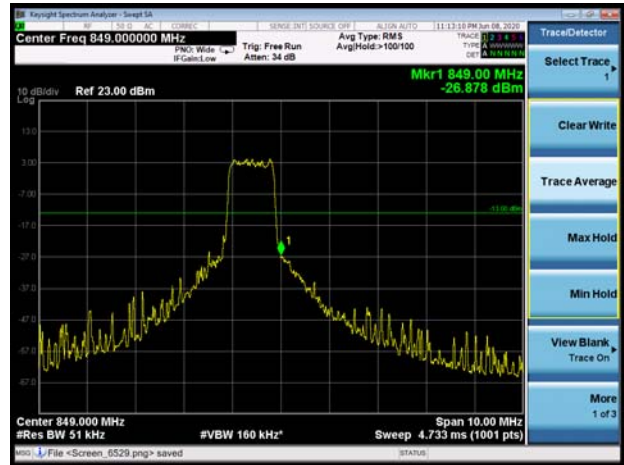

LTE Band 26 16QAM 3MHz CH-Low 1RB

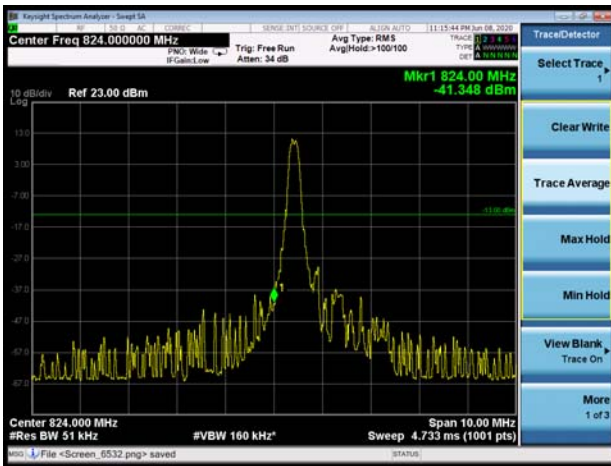

LTE Band 26 16QAM 3MHz CH-High 1RB

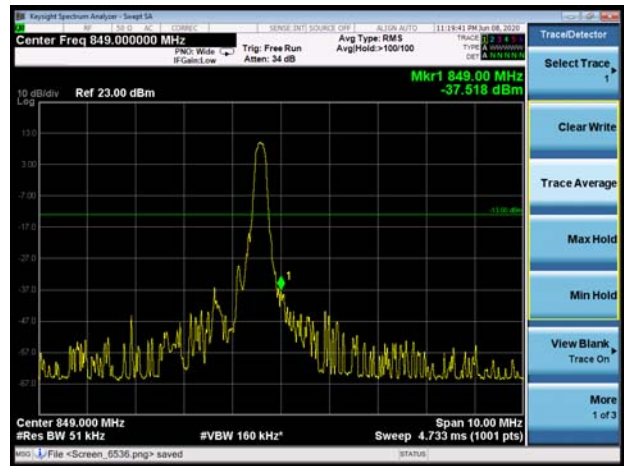

LTE Band 26 16QAM 3MHz CH-Low 100%RB

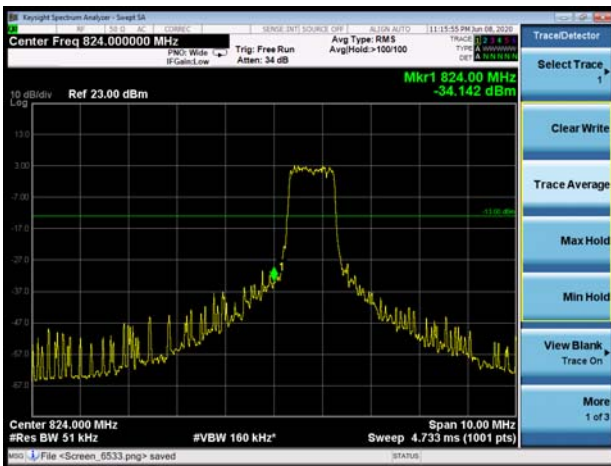

LTE Band 26 16QAM 3MHz CH-High 100%RB

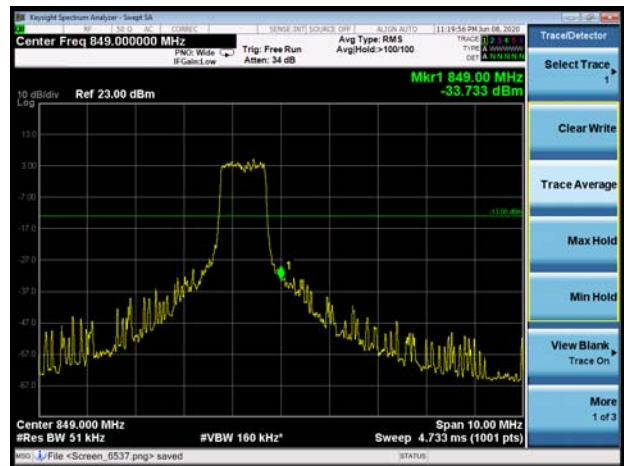

LTE Band 26 16QAM 5MHz CH-Low 1RB



LTE Band 26 16QAM 5MHz CH-High 1RB



LTE Band 26 16QAM 5MHz CH-Low 100%RB

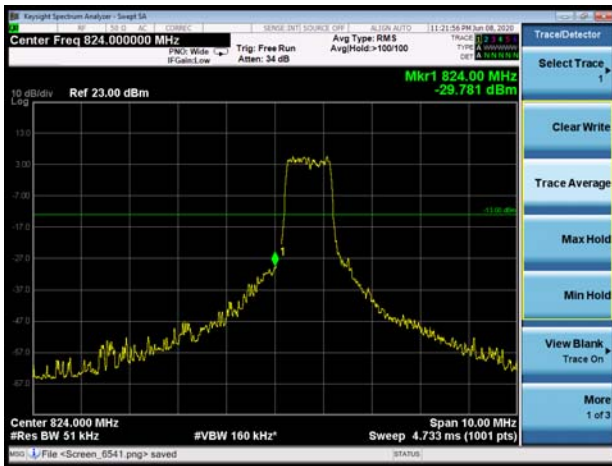

LTE Band 26 16QAM 5MHz CH-High 100%RB

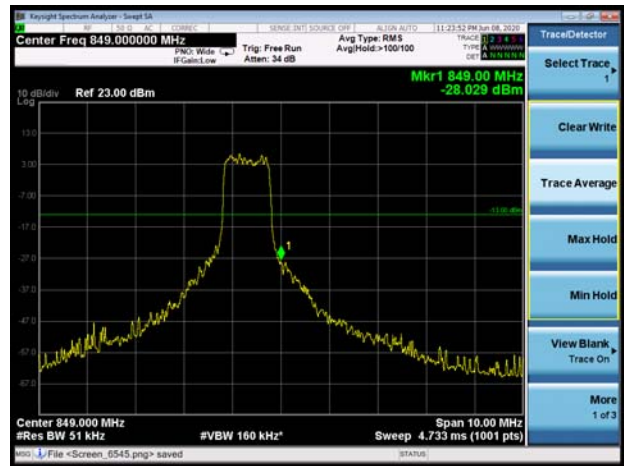

LTE Band 26 16QAM 10MHz CH-Low 1RB

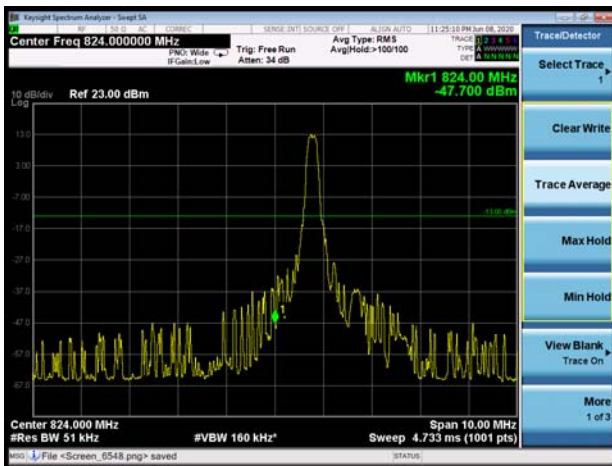

LTE Band 26 16QAM 10MHz CH-High 1RB

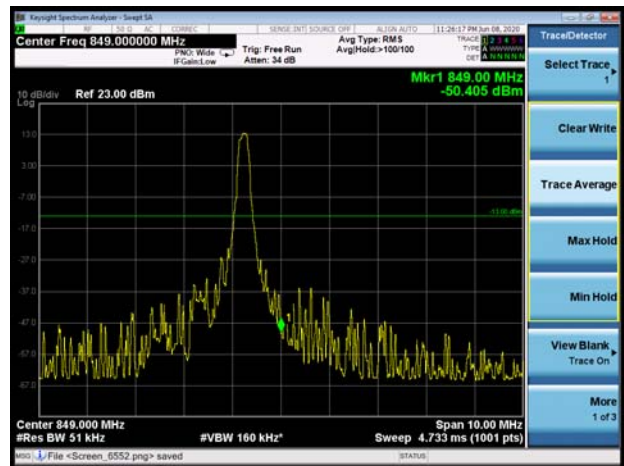

LTE Band 26 16QAM 10MHz CH-Low 100%RB

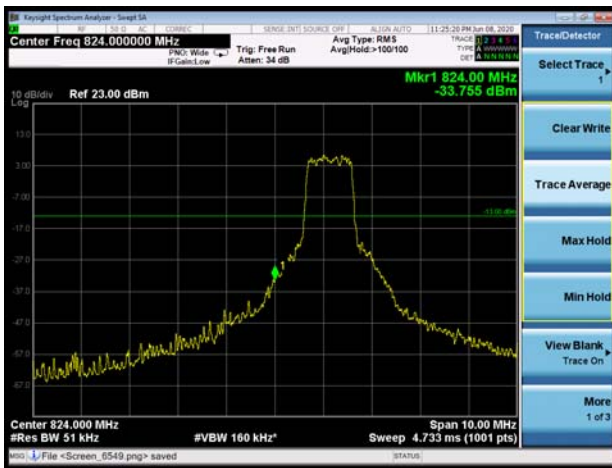

LTE Band 26 16QAM 10MHz CH-High 100%RB

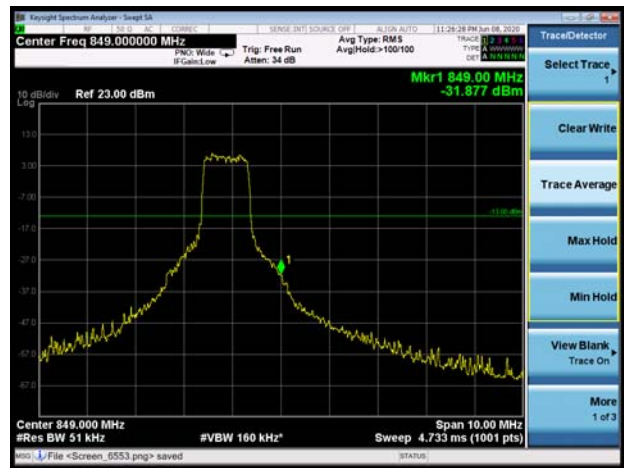

LTE Band 26 16QAM 15MHz CH-Low 1RB



LTE Band 26 16QAM 15MHz CH-High 1RB

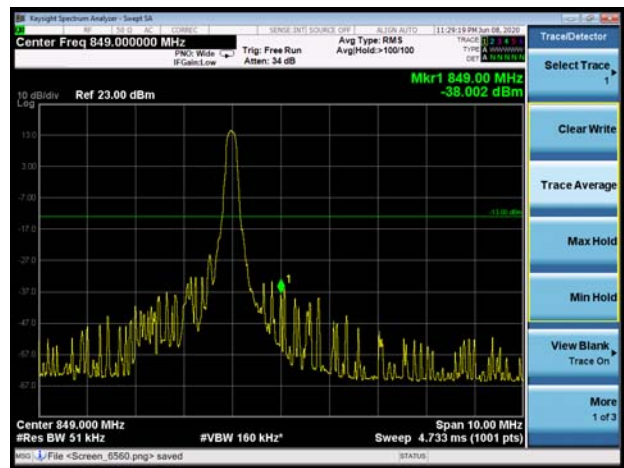

LTE Band 26 16QAM 15MHz CH-Low 100%RB

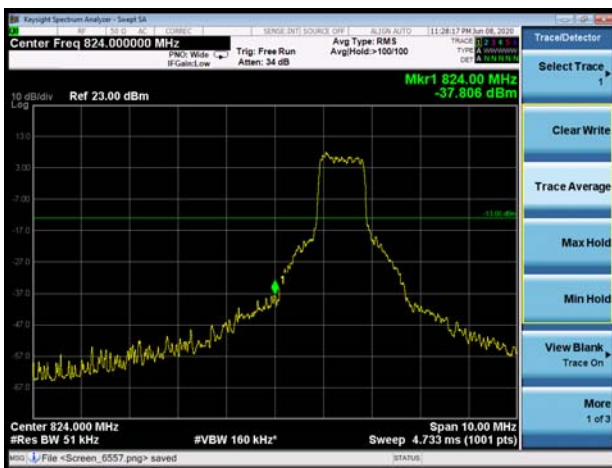

LTE Band 26 16QAM 15MHz CH-High 100%RB

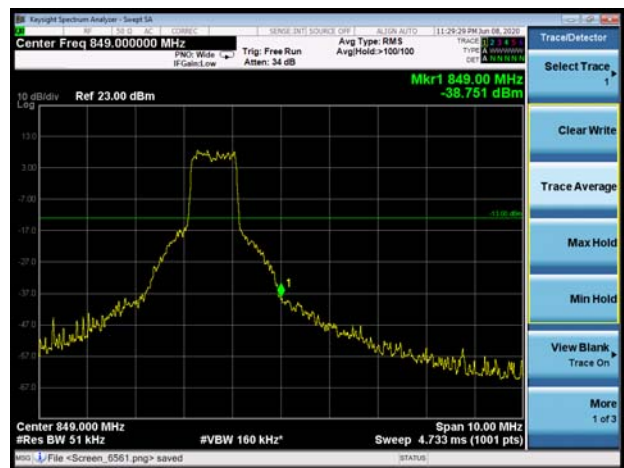

5.4. Peak-to-Average Power Ratio (PAPR)

Ambient condition

Temperature	Relative humidity	Pressure
23°C ~25°C	45%~50%	101.5kPa

Methods of Measurement

Measure the total peak power and record as P_{Pk} . And measure the total average power and record as P_{Avg} . Both the peak and average power levels must be expressed in the same logarithmic units (e.g., dBm). Determine the PAPR from:

$$PAPR (dB) = P_{Pk} (dBm) - P_{Avg} (dBm).$$

Test Setup

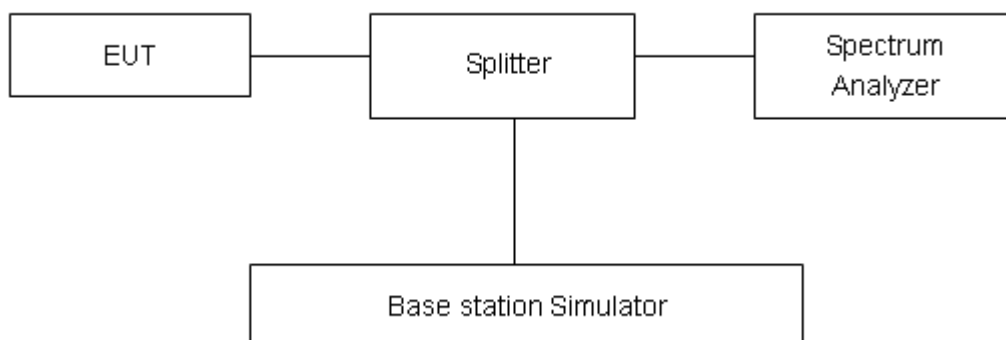

Limits

According to the Sec. 22.913(d), The peak-to-average ratio (PAR) of the transmission must not exceed 13 dB.

Measurement Uncertainty

The assessed measurement uncertainty to ensure 95% confidence level for the normal distribution is with the coverage factor $k = 2$, $U = 0.4$ dB.

Test Results

Mode	Channel	Frequency (MHz)	Peak (dBm)	Avg (dBm)	PAPR (dB)	Limit (dB)	Conclusion
GSM 850 (GMSK)	128	824.2	32.68	32.43	0.25	≤13	PASS
	190	836.6	32.69	32.38	0.31	≤13	PASS
	251	848.8	32.63	32.37	0.26	≤13	PASS
GPRS 850 (GMSK)	128	824.2	32.86	32.40	0.46	≤13	PASS
	190	836.6	32.98	32.47	0.51	≤13	PASS
	251	848.8	32.90	32.41	0.49	≤13	PASS
EGPRS 850 (8PSK)	128	824.2	27.82	26.41	1.41	≤13	PASS
	190	836.6	27.73	26.24	1.49	≤13	PASS
	251	848.8	27.70	26.26	1.44	≤13	PASS

Mode	Bandwidth	Modulation	Channel/ Frequency (MHz)	Peak-to-Average Power Ratio (PAPR)			Limit (dB)	Conclusion
				Peak (dBm)	Avg (dBm)	PAPR (dB)		
LTE Band 5	1.4MHz	QPSK	20525/836.5	25.54	14.08	11.46	≤13	PASS
		16QAM	20525/836.5	26.69	15.12	11.57	≤13	PASS
	3MHz	QPSK	20525/836.5	25.47	15.76	9.71	≤13	PASS
		16QAM	20525/836.5	26.13	15.92	10.21	≤13	PASS
	5MHz	QPSK	20525/836.5	26.36	16.90	9.46	≤13	PASS
		16QAM	20525/836.5	26.22	16.12	10.10	≤13	PASS
	10MHz	QPSK	20525/836.5	26.37	16.88	9.49	≤13	PASS
		16QAM	20525/836.5	26.83	17.11	9.72	≤13	PASS



Mode	Bandwidth	Modulation	Channel/ Frequency (MHz)	Peak-to-Average Power Ratio (PAPR)			Limit (dB)	Conclusion
				Peak (dBm)	Avg (dBm)	PAPR (dB)		
LTE Band 26	1.4MHz	QPSK	26915/836.5	25.55	15.90	9.65	≤13	PASS
		16QAM	26915/836.5	26.04	15.72	10.32	≤13	PASS
	3MHz	QPSK	26915/836.5	25.39	15.68	9.71	≤13	PASS
		16QAM	26915/836.5	25.97	15.72	10.25	≤13	PASS
	5MHz	QPSK	26915/836.5	26.26	16.98	9.28	≤13	PASS
		16QAM	26915/836.5	26.00	15.88	10.12	≤13	PASS
	10MHz	QPSK	26915/836.5	26.14	16.76	9.38	≤13	PASS
		16QAM	26915/836.5	26.79	17.38	9.41	≤13	PASS
	15MHz	QPSK	26915/836.5	26.61	18.07	8.54	≤13	PASS
		16QAM	26915/836.5	27.27	18.39	8.88	≤13	PASS

5.5. Frequency Stability

Ambient condition

Temperature	Relative humidity	Pressure
23°C ~25°C	45%~50%	101.5kPa

Method of Measurement

Frequency Stability (Temperature Variation)

The temperature inside the climate chamber is varied from -40°C to +85°C in 10°C step size,

(1) With all power removed, the temperature was decreased to 0°C and permitted to stabilize for three hours.

(2) Measure the carrier frequency with the test equipment in a “call mode”. These measurements should be made within 1 minute of powering up the mobile station, to prevent significant self warming.

(3) Repeat the above measurements at 10°C increments from -40°C to +85°C. Allow at least 1.5 hours at each temperature, un-powered, before making measurements.

Frequency Stability (Voltage Variation)

The frequency stability shall be measured with variation of primary supply voltage as follows:

(1) Vary primary supply voltage from 85 to 115 percent of the nominal value for other than hand carried battery equipment.

(2) For hand carried, battery powered equipment, reduce primary supply voltage to the battery-operating end point which shall be specified by the manufacturer.

This transceiver is specified to operate with an input voltage of between 3.3 V and 4.3 V, with a nominal voltage of 3.8V.

Test setup

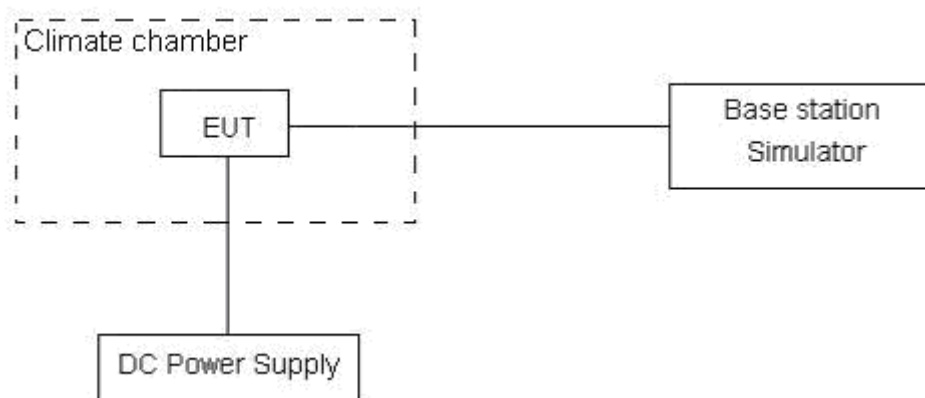

**Limits**

According to the Sec. 22.355, the frequency stability of the carrier shall be accurate to within 2.5 ppm of the received frequency for mobile stations.

Limits	≤ 2.5 ppm
--------	----------------

Measurement Uncertainty

The assessed measurement uncertainty to ensure 99.75% confidence level for the normal distribution is with the coverage factor $k = 3$, $U = 0.01$ ppm.



Test Result

GSM 850						
Condition		Freq.Error (Hz)	Freq.Error (Hz)	Frequency Stability (ppm)	Frequency Stability (ppm)	Verdict
Temperature	Voltage	GMSK	8PSK	GMSK	8PSK	
Normal (25°C)	Normal	11.49	14.65	0.00611	0.00779	PASS
Extreme (85°C)		3.84	8.91	0.00204	0.00474	PASS
Extreme (80°C)		9.93	13.89	0.00528	0.00739	PASS
Extreme (70°C)		15.09	6.61	0.00803	0.00352	PASS
Extreme (60°C)		13.03	1.34	0.00693	0.00071	PASS
Extreme (50°C)		9.73	17.86	0.00518	0.00950	PASS
Extreme (40°C)		7.82	3.06	0.00416	0.00163	PASS
Extreme (30°C)		9.13	14.06	0.00485	0.00748	PASS
Extreme (20°C)		11.42	2.97	0.00607	0.00158	PASS
Extreme (10°C)		2.38	11.45	0.00126	0.00609	PASS
Extreme (0°C)		8.28	14.05	0.00440	0.00747	PASS
Extreme (-10°C)		12.47	4.89	0.00663	0.00260	PASS
Extreme (-20°C)		15.42	15.05	0.00820	0.00800	PASS
Extreme (-30°C)		1.36	4.80	0.00072	0.00255	PASS
Extreme (-40°C)	11.31	11.72	0.00602	0.00623	PASS	
25°C	LV	12.44	11.81	0.00662	0.00628	PASS
	HV	13.16	14.82	0.00700	0.00788	PASS

LTE Band 5						
Condition		Freq.Error (Hz)	Freq.Error (Hz)	Frequency Stability (ppm)	Frequency Stability (ppm)	Verdict
BANDWIDTH	1.4MHz					
Temperature	Voltage	16QAM	QPSK	16QAM	QPSK	
Normal (25°C)	Normal	8.04	1.08	0.00427	0.00057	PASS
Extreme (85°C)		4.42	10.28	0.00235	0.00547	PASS
Extreme (80°C)		14.48	12.02	0.00770	0.00639	PASS
Extreme (70°C)		12.84	9.38	0.00683	0.00499	PASS
Extreme (60°C)		17.94	1.91	0.00954	0.00102	PASS
Extreme (50°C)		2.15	12.96	0.00114	0.00689	PASS
Extreme (40°C)		15.25	14.44	0.00811	0.00768	PASS
Extreme (30°C)		16.34	13.81	0.00869	0.00735	PASS
Extreme (20°C)		15.94	8.20	0.00848	0.00436	PASS
Extreme (10°C)		10.81	17.24	0.00575	0.00917	PASS
Extreme (0°C)		9.90	14.68	0.00526	0.00781	PASS



Extreme (-10°C)		8.01	5.51	0.00426	0.00293	PASS
Extreme (-20°C)		12.21	9.56	0.00650	0.00509	PASS
Extreme (-30°C)		14.38	13.37	0.00765	0.00711	PASS
Extreme (-40°C)		12.52	4.22	0.00666	0.00225	PASS
25°C	LV	14.85	2.38	0.00790	0.00126	PASS
	HV	12.78	3.91	0.00680	0.00208	PASS
Condition		Freq.Error (Hz)	Freq.Error (Hz)	Frequency Stability (ppm)	Frequency Stability (ppm)	Verdict
BANDWIDTH	3MHz					
Temperature	Voltage	16QAM	QPSK	16QAM	QPSK	
Normal (25°C)	Normal	2.45	14.31	0.00130	0.00761	
Extreme (85°C)		1.40	1.59	0.00075	0.00084	PASS
Extreme (80°C)		4.32	10.22	0.00230	0.00544	PASS
Extreme (70°C)		11.80	15.37	0.00627	0.00817	PASS
Extreme (60°C)		8.26	2.84	0.00439	0.00151	PASS
Extreme (50°C)		9.20	7.08	0.00489	0.00377	PASS
Extreme (40°C)		12.42	10.37	0.00661	0.00552	PASS
Extreme (30°C)		17.83	11.50	0.00948	0.00612	PASS
Extreme (20°C)		12.85	3.97	0.00683	0.00211	PASS
Extreme (10°C)		9.60	2.74	0.00510	0.00146	PASS
Extreme (0°C)		9.94	8.27	0.00529	0.00440	PASS
Extreme (-10°C)		1.52	15.39	0.00081	0.00819	PASS
Extreme (-20°C)		11.41	3.47	0.00607	0.00184	PASS
Extreme (-30°C)		11.53	6.09	0.00614	0.00324	PASS
Extreme (-40°C)		2.53	8.00	0.00134	0.00425	PASS
25°C	LV	8.29	15.82	0.00441	0.00842	PASS
	HV	3.11	10.74	0.00166	0.00571	PASS
Condition		Freq.Error (Hz)	Freq.Error (Hz)	Frequency Stability (ppm)	Frequency Stability (ppm)	Verdict
BANDWIDTH	5MHz					
Temperature	Voltage	16QAM	QPSK	16QAM	QPSK	
Normal (25°C)	Normal	2.65	11.09	0.00141	0.00590	
Extreme (85°C)		14.90	9.25	0.00793	0.00492	PASS
Extreme (80°C)		17.19	13.53	0.00914	0.00719	PASS
Extreme (70°C)		8.01	6.47	0.00426	0.00344	PASS
Extreme (60°C)		1.60	6.24	0.00085	0.00332	PASS
Extreme (50°C)		15.36	4.29	0.00817	0.00228	PASS
Extreme (40°C)		3.80	7.77	0.00202	0.00414	PASS
Extreme (30°C)		16.74	16.74	0.00891	0.00891	PASS
Extreme (20°C)		4.66	17.36	0.00248	0.00923	PASS
Extreme (10°C)		15.41	2.26	0.00820	0.00120	PASS



Condition		Freq.Error (Hz)	Freq.Error (Hz)	Frequency Stability (ppm)	Frequency Stability (ppm)	Verdict
BANDWIDTH	10MHz					
Temperature	Voltage	16QAM	QPSK	16QAM	QPSK	
Extreme (0°C)		2.83	3.06	0.00151	0.00163	PASS
Extreme (-10°C)		17.10	17.34	0.00909	0.00922	PASS
Extreme (-20°C)		6.33	15.50	0.00337	0.00825	PASS
Extreme (-30°C)		15.18	11.66	0.00808	0.00620	PASS
Extreme (-40°C)		11.01	14.50	0.00586	0.00771	PASS
25°C	LV	8.78	4.69	0.00467	0.00249	PASS
	HV	6.56	9.62	0.00349	0.00512	PASS
Normal (25°C)	Normal	13.51	16.58	0.00719	0.00882	PASS
Extreme (85°C)		7.29	6.83	0.00388	0.00363	PASS
Extreme (80°C)		14.30	11.83	0.00761	0.00629	PASS
Extreme (70°C)		14.52	2.50	0.00772	0.00133	PASS
Extreme (60°C)		2.86	12.55	0.00152	0.00668	PASS
Extreme (50°C)		14.73	12.40	0.00784	0.00660	PASS
Extreme (40°C)		13.99	1.51	0.00744	0.00080	PASS
Extreme (30°C)		6.38	4.91	0.00339	0.00261	PASS
Extreme (20°C)		4.08	1.01	0.00217	0.00054	PASS
Extreme (10°C)		7.53	15.23	0.00400	0.00810	PASS
Extreme (0°C)		16.11	13.95	0.00857	0.00742	PASS
Extreme (-10°C)		11.62	4.45	0.00618	0.00237	PASS
Extreme (-20°C)		10.67	2.37	0.00568	0.00126	PASS
Extreme (-30°C)		6.42	13.53	0.00341	0.00720	PASS
Extreme (-40°C)		2.44	6.86	0.00130	0.00365	PASS
25°C	LV	9.89	7.55	0.00526	0.00402	PASS
	HV	5.10	10.76	0.00271	0.00573	PASS

LTE Band 26						
Condition		Freq.Error (Hz)	Freq.Error (Hz)	Frequency Stability (ppm)	Frequency Stability (ppm)	Verdict
BANDWIDTH	1.4MHz					
Temperature	Voltage	16QAM	QPSK	16QAM	QPSK	
Normal (25°C)	Normal	9.17	1.43	0.00488	0.00076	PASS
Extreme (85°C)		7.73	17.42	0.00411	0.00927	PASS
Extreme (80°C)		17.54	3.63	0.00933	0.00193	PASS
Extreme (70°C)		5.85	17.24	0.00311	0.00917	PASS
Extreme (60°C)		15.56	2.63	0.00828	0.00140	PASS
Extreme (50°C)		3.94	11.04	0.00210	0.00587	PASS



Extreme (40°C)		4.57	4.30	0.00243	0.00229	PASS
Extreme (30°C)		11.36	3.52	0.00604	0.00187	PASS
Extreme (20°C)		8.43	5.09	0.00448	0.00271	PASS
Extreme (10°C)		2.73	1.40	0.00145	0.00075	PASS
Extreme (0°C)		17.73	14.15	0.00943	0.00752	PASS
Extreme (-10°C)		15.44	10.50	0.00821	0.00558	PASS
Extreme (-20°C)		15.03	14.54	0.00800	0.00774	PASS
Extreme (-30°C)		4.26	8.89	0.00227	0.00473	PASS
Extreme (-40°C)		6.22	16.12	0.00331	0.00857	PASS
25°C	LV	15.62	7.12	0.00831	0.00379	PASS
	HV	15.55	14.02	0.00827	0.00746	PASS
Condition		Freq.Error (Hz)	Freq.Error (Hz)	Frequency Stability (ppm)	Frequency Stability (ppm)	Verdict
BANDWIDTH	3MHz					
Temperature	Voltage	16QAM	QPSK	16QAM	QPSK	
Normal (25°C)	Normal	17.16	16.14	0.00913	0.00858	
Extreme (85°C)		17.53	16.63	0.00932	0.00884	PASS
Extreme (80°C)		13.58	15.49	0.00723	0.00824	PASS
Extreme (70°C)		17.84	7.31	0.00949	0.00389	PASS
Extreme (60°C)		3.86	2.26	0.00205	0.00120	PASS
Extreme (50°C)		6.36	3.85	0.00338	0.00205	PASS
Extreme (40°C)		15.41	7.55	0.00820	0.00402	PASS
Extreme (30°C)		7.58	6.40	0.00403	0.00341	PASS
Extreme (20°C)		4.77	17.14	0.00254	0.00912	PASS
Extreme (10°C)		14.22	3.33	0.00757	0.00177	PASS
Extreme (0°C)		4.08	14.96	0.00217	0.00796	PASS
Extreme (-10°C)		2.66	8.90	0.00141	0.00473	PASS
Extreme (-20°C)		13.23	4.14	0.00704	0.00220	PASS
Extreme (-30°C)		9.20	12.95	0.00489	0.00689	PASS
Extreme (-40°C)	17.60	5.12	0.00936	0.00273	PASS	
25°C	LV	1.87	7.31	0.00099	0.00389	PASS
	HV	6.21	5.77	0.00330	0.00307	PASS
Condition		Freq.Error (Hz)	Freq.Error (Hz)	Frequency Stability (ppm)	Frequency Stability (ppm)	Verdict
BANDWIDTH	5MHz					
Temperature	Voltage	16QAM	QPSK	16QAM	QPSK	
Normal (25°C)	Normal	3.68	6.13	0.00196	0.00326	
Extreme (85°C)		5.64	13.61	0.00300	0.00724	PASS
Extreme (80°C)		3.04	5.73	0.00161	0.00305	PASS
Extreme (70°C)		1.06	17.96	0.00056	0.00955	PASS
Extreme (60°C)		13.02	1.16	0.00693	0.00062	PASS



Extreme (50°C)		17.40	6.50	0.00926	0.00346	PASS
Extreme (40°C)		7.19	4.08	0.00382	0.00217	PASS
Extreme (30°C)		7.76	3.99	0.00413	0.00212	PASS
Extreme (20°C)		15.28	8.35	0.00813	0.00444	PASS
Extreme (10°C)		7.89	14.74	0.00419	0.00784	PASS
Extreme (0°C)		12.34	12.31	0.00656	0.00655	PASS
Extreme (-10°C)		14.63	14.33	0.00778	0.00762	PASS
Extreme (-20°C)		6.02	9.66	0.00320	0.00514	PASS
Extreme (-30°C)		5.72	3.66	0.00304	0.00195	PASS
Extreme (-40°C)		14.02	8.64	0.00745	0.00460	PASS
25°C	LV	10.87	15.46	0.00578	0.00823	PASS
	HV	2.14	2.29	0.00114	0.00122	PASS
Condition		Freq.Error (Hz)	Freq.Error (Hz)	Frequency Stability (ppm)	Frequency Stability (ppm)	Verdict
BANDWIDTH	10MHz					
Temperature	Voltage	16QAM	QPSK	16QAM	QPSK	
Normal (25°C)	Normal	5.98	3.67	0.00318	0.00195	PASS
Extreme (85°C)		10.25	11.66	0.00545	0.00620	PASS
Extreme (80°C)		7.60	7.06	0.00404	0.00375	PASS
Extreme (70°C)		14.34	1.88	0.00763	0.00100	PASS
Extreme (60°C)		3.77	1.97	0.00201	0.00105	PASS
Extreme (50°C)		7.66	1.73	0.00408	0.00092	PASS
Extreme (40°C)		14.36	13.53	0.00764	0.00720	PASS
Extreme (30°C)		9.96	9.32	0.00530	0.00496	PASS
Extreme (20°C)		12.37	2.25	0.00658	0.00120	PASS
Extreme (10°C)		2.98	12.94	0.00159	0.00688	PASS
Extreme (0°C)		9.69	4.68	0.00515	0.00249	PASS
Extreme (-10°C)		8.54	12.55	0.00454	0.00668	PASS
Extreme (-20°C)		10.66	1.80	0.00567	0.00096	PASS
Extreme (-30°C)		2.44	1.27	0.00130	0.00068	PASS
Extreme (-40°C)		10.95	16.05	0.00582	0.00854	PASS
25°C		LV	3.93	1.87	0.00209	0.00099
	HV	17.80	6.21	0.00947	0.00330	PASS
Condition		Freq.Error (Hz)	Freq.Error (Hz)	Frequency Stability (ppm)	Frequency Stability (ppm)	Verdict
BANDWIDTH	15MHz					
Temperature	Voltage	16QAM	QPSK	16QAM	QPSK	
Normal (25°C)	Normal	17.84	15.96	0.00949	0.00849	PASS
Extreme (85°C)		6.89	1.92	0.00366	0.00102	PASS
Extreme (80°C)		1.51	9.64	0.00080	0.00513	PASS
Extreme (70°C)		1.76	14.60	0.00093	0.00776	PASS



Extreme (60°C)		9.50	3.69	0.00505	0.00196	PASS
Extreme (50°C)		7.07	3.08	0.00376	0.00164	PASS
Extreme (40°C)		11.88	7.77	0.00632	0.00413	PASS
Extreme (30°C)		10.01	10.59	0.00532	0.00563	PASS
Extreme (20°C)		14.78	4.41	0.00786	0.00235	PASS
Extreme (10°C)		17.39	17.62	0.00925	0.00937	PASS
Extreme (0°C)		15.39	6.99	0.00819	0.00372	PASS
Extreme (-10°C)		4.09	11.94	0.00218	0.00635	PASS
Extreme (-20°C)		15.88	3.57	0.00845	0.00190	PASS
Extreme (-30°C)		11.22	10.96	0.00597	0.00583	PASS
Extreme (-40°C)		15.50	16.36	0.00824	0.00870	PASS
25°C	LV	6.55	4.39	0.00348	0.00234	PASS
	HV	9.01	16.88	0.00479	0.00898	PASS

5.6. Spurious Emissions at Antenna Terminals

Ambient condition

Temperature	Relative humidity	Pressure
23°C ~25°C	45%~50%	101.5kPa

Method of Measurement

The EUT was connected to Spectrum Analyzer and Base Station Simulator via power Splitter. The measurement is carried out using a spectrum analyzer. The spectrum analyzer scans from 9kHz to the 10th harmonic of the carrier.

The peak detector is used. RBW are set to 100 kHz and VBW are set to 300 kHz for below 1G, RBW are set to 1MHz and VBW are set to 3MHz for above 1G, Sweep is set to ATUO.

The modulation mode and RB allocation refer to section 5.1, using the maximum output power configuration.

Test setup

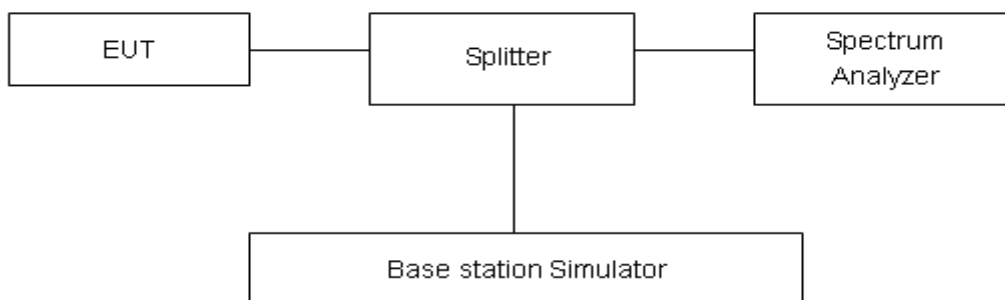

Limits

Rule Part 22.917(a) specifies that “The power of any emission outside of the authorized operating frequency ranges must be attenuated below the transmitting power (P) by a factor of at least 43 + 10 log (P) dB.”

Limit	-13 dBm
-------	---------

Measurement Uncertainty

The assessed measurement uncertainty to ensure 99.75% confidence level for the normal distribution is with the coverage factor $k = 1.96$.

Frequency	Uncertainty
9kHz-1GHz	0.684 dB
1GHz-18GHz	1.407 dB



Test Result

Sweep the whole frequency band through the range from 9kHz to the 10th harmonic of the carrier, the emissions more than 20 dB below the limit are not reported.

The signal beyond the limit is carrier.

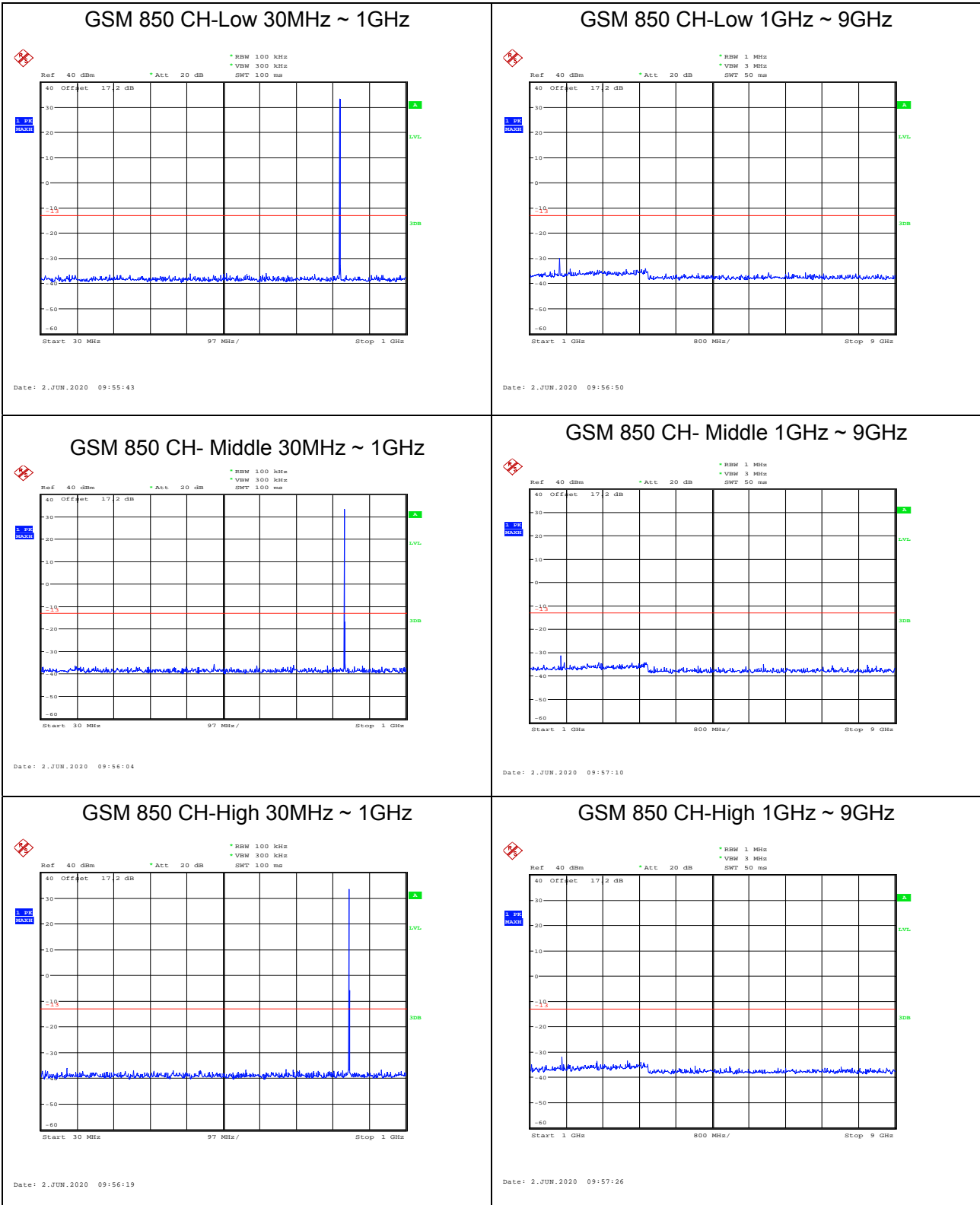



GPRS 850 CH-Low 30MHz ~ 1GHz

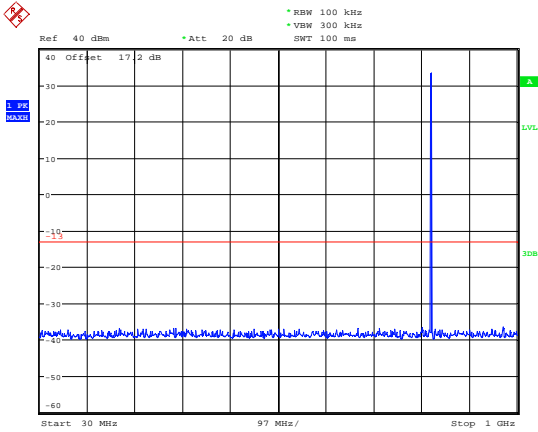

Date: 2.JUN.2020 10:02:19

GPRS 850 CH-Low 1GHz ~ 9GHz

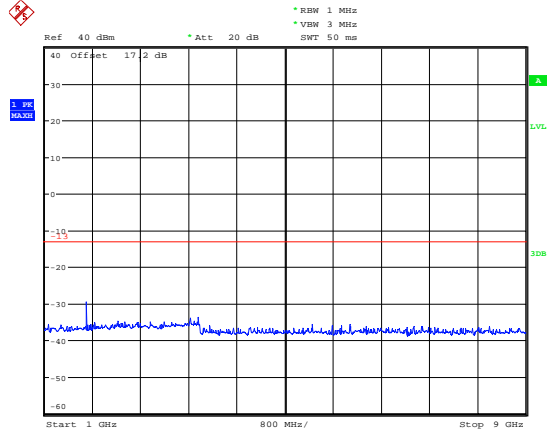

Date: 2.JUN.2020 10:03:18

GPRS 850 CH- Middle 30MHz ~ 1GHz

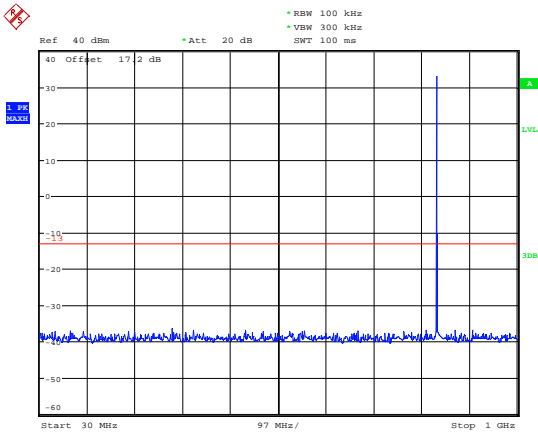

Date: 2.JUN.2020 10:02:36

GPRS 850 CH- Middle 1GHz ~ 9GHz

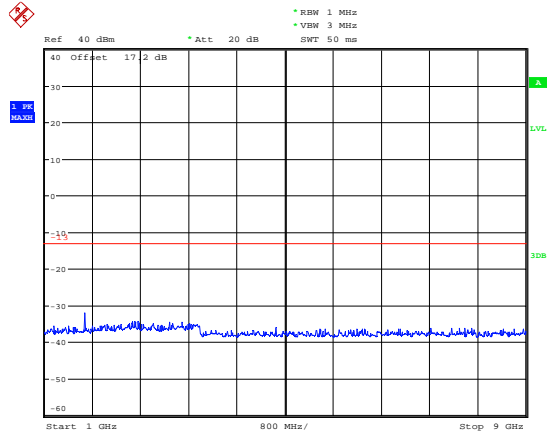

Date: 2.JUN.2020 10:03:35

GPRS 850 CH-High 30MHz ~ 1GHz

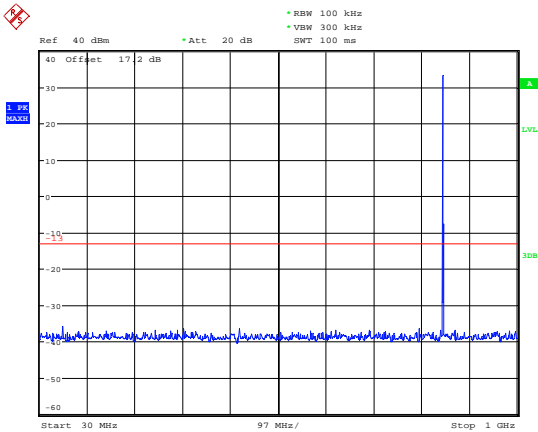

Date: 2.JUN.2020 10:02:53

GPRS 850 CH-High 1GHz ~ 9GHz

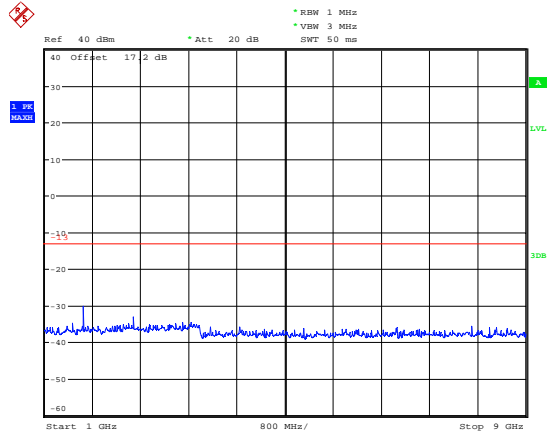

Date: 2.JUN.2020 10:03:49



EGPRS 850 CH-Low 30MHz ~ 1GHz

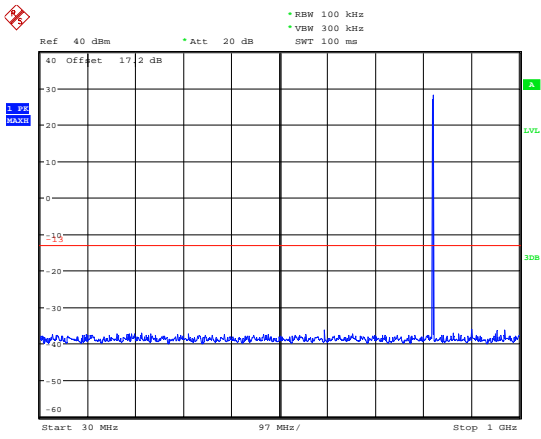

Date: 2.JUN.2020 10:04:42

EGPRS 850 CH-Low 1GHz ~ 9GHz

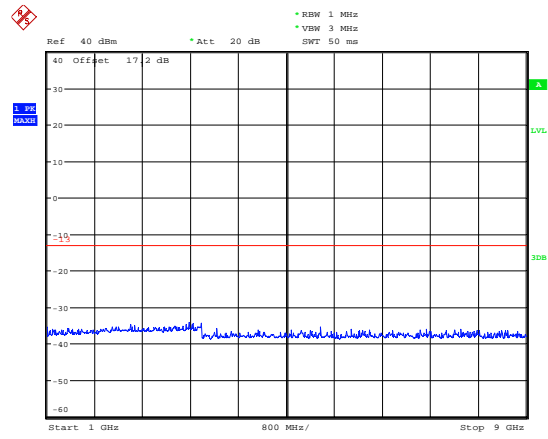

Date: 2.JUN.2020 10:06:19

EGPRS 850 CH- Middle 30MHz ~ 1GHz

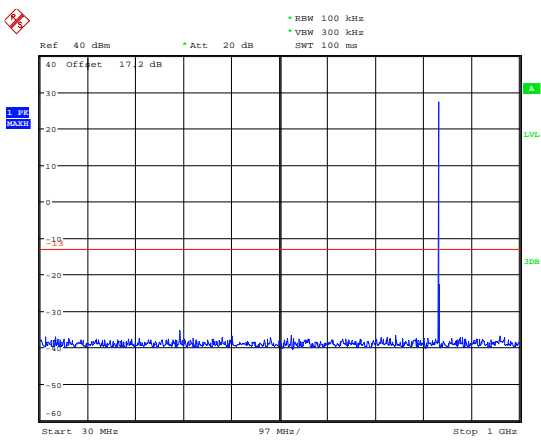

Date: 2.JUN.2020 10:05:30

EGPRS 850 CH- Middle 1GHz ~ 9GHz

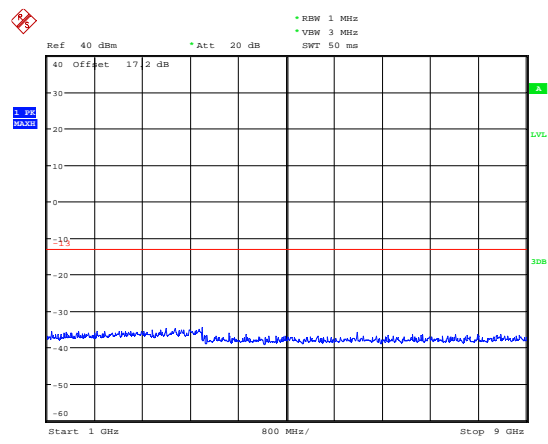

Date: 2.JUN.2020 10:06:35

EGPRS 850 CH-High 30MHz ~ 1GHz

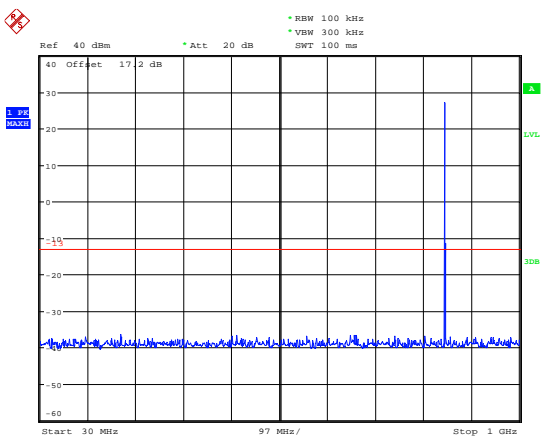

Date: 2.JUN.2020 10:05:49

EGPRS 850 CH-High 1GHz ~ 9GHz

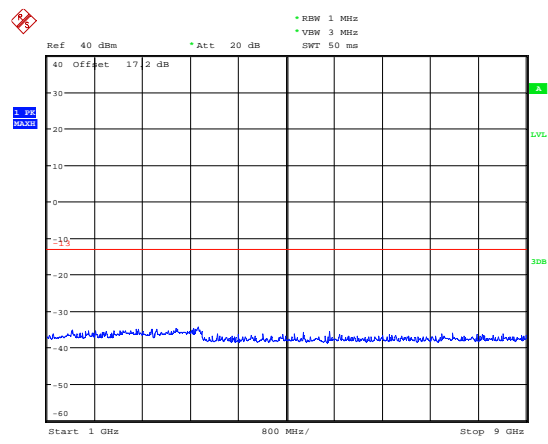

Date: 2.JUN.2020 10:06:50



LTE Band 5 1.4MHz CH-Low 30MHz~1GHz

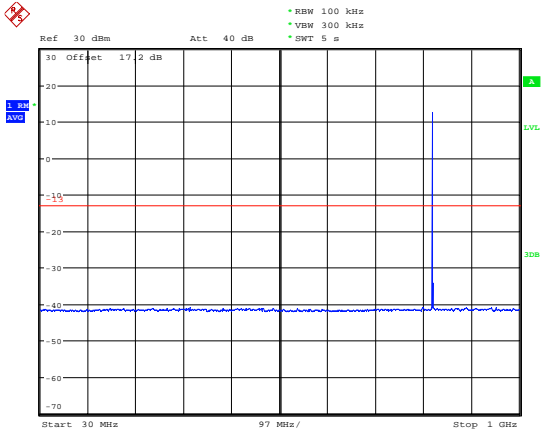

Date: 11.JUN.2020 21:38:31

LTE Band 5 1.4MHz CH-Low 1GHz~9GHz

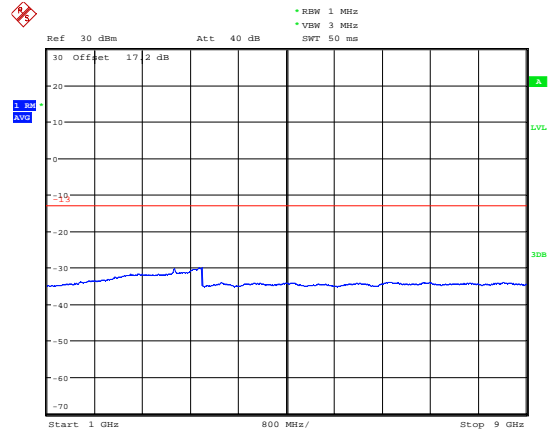

Date: 11.JUN.2020 21:58:24

LTE Band 5 1.4MHz CH-Middle 30MHz~1GHz

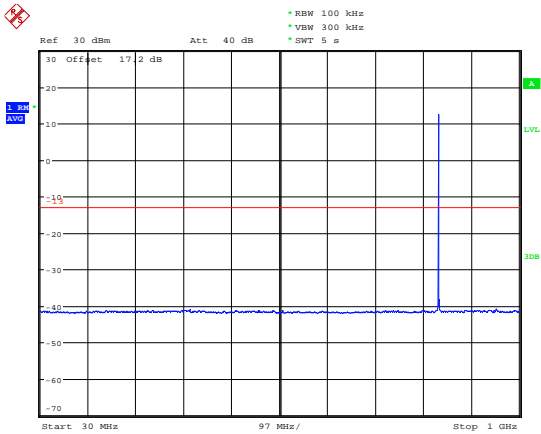

Date: 11.JUN.2020 21:40:13

LTE Band 5 1.4MHz CH-Middle 1GHz~9GHz

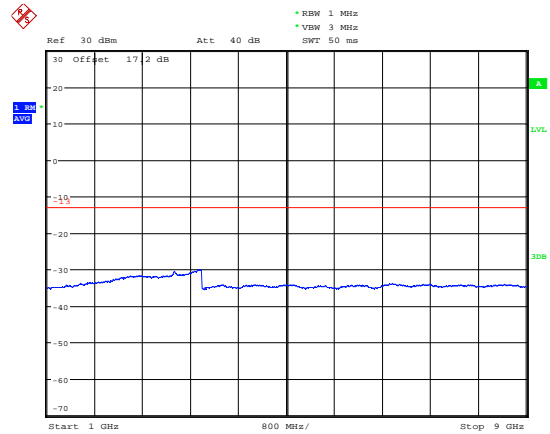

Date: 11.JUN.2020 21:58:33

LTE Band 5 1.4MHz CH-High 30MHz~1GHz

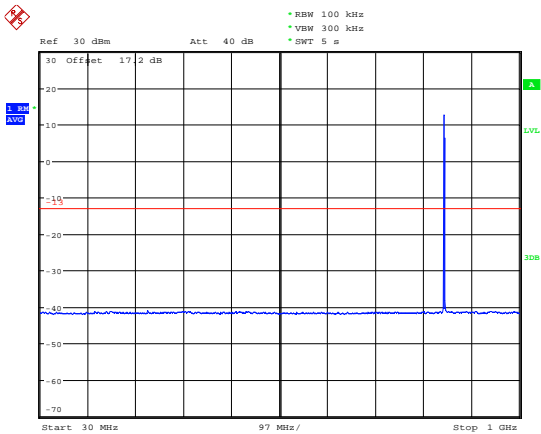

Date: 11.JUN.2020 21:42:49

LTE Band 5 1.4MHz CH-High 1GHz~9GHz

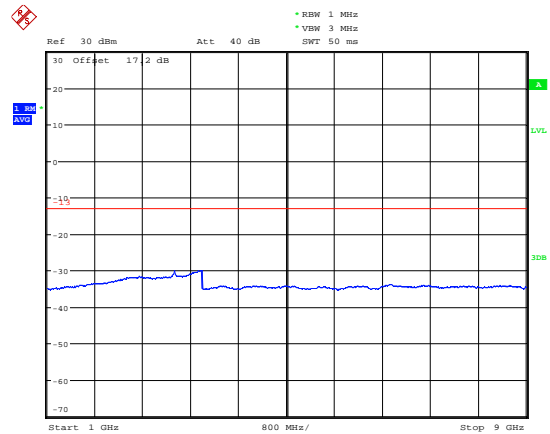

Date: 11.JUN.2020 21:58:41



LTE Band 5 3MHz CH-Low 30MHz~1GHz

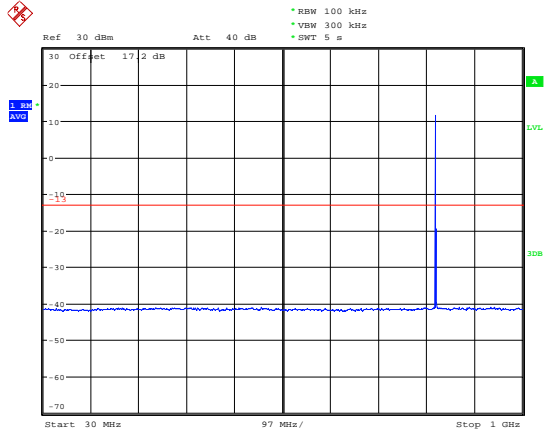

Date: 11.JUN.2020 21:45:10

LTE Band 5 3MHz CH-Low 1GHz~9GHz

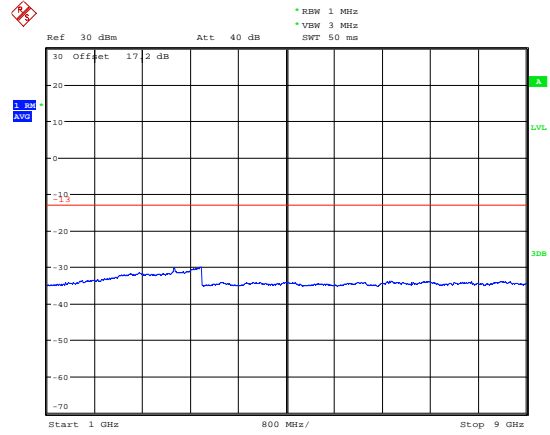

Date: 11.JUN.2020 21:58:49

LTE Band 5 3MHz CH-Middle 30MHz~1GHz

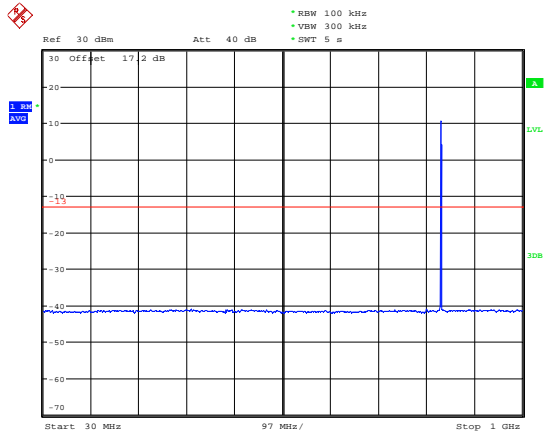

Date: 11.JUN.2020 21:45:57

LTE Band 5 3MHz CH-Middle 1GHz~9GHz

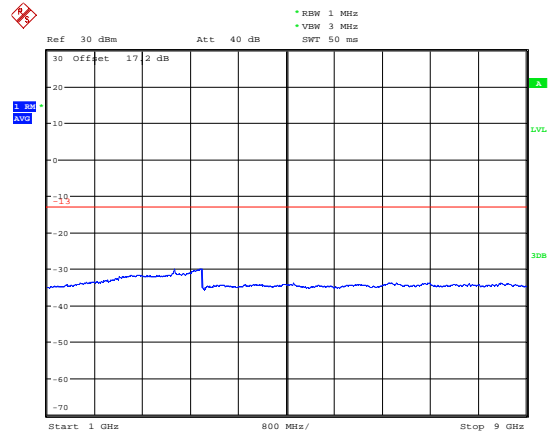

Date: 11.JUN.2020 21:58:56

LTE Band 5 3MHz CH-High 30MHz~1GHz

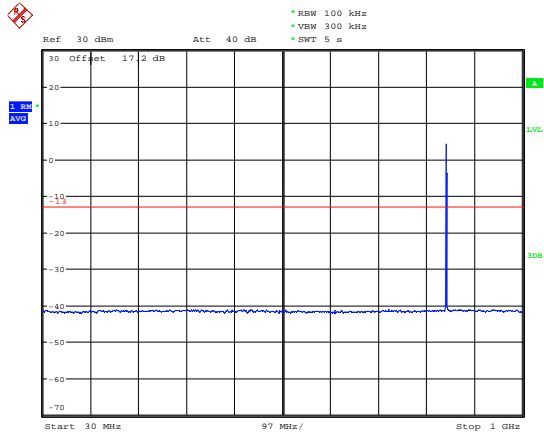

Date: 11.JUN.2020 21:47:53

LTE Band 5 3MHz CH-High 1GHz~9GHz

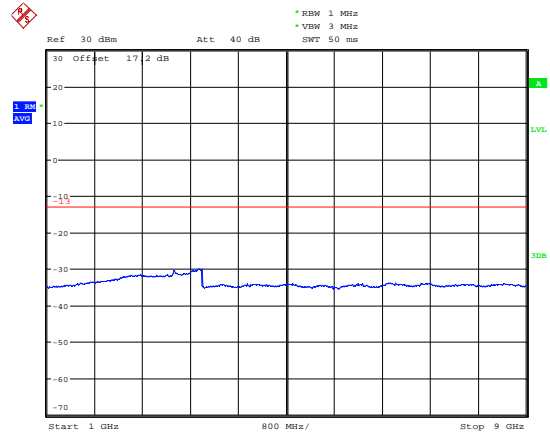

Date: 11.JUN.2020 21:59:03



LTE Band 5 5MHz CH-Low 30MHz~1GHz

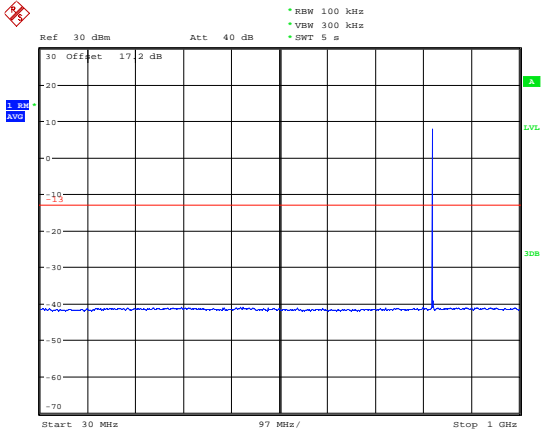

Date: 11.JUN.2020 21:49:17

LTE Band 5 5MHz CH-Low 1GHz~9GHz

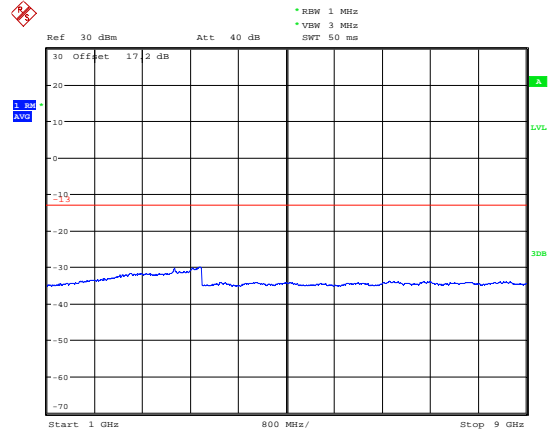

Date: 11.JUN.2020 21:59:10

LTE Band 5 5MHz CH-Middle 30MHz~1GHz

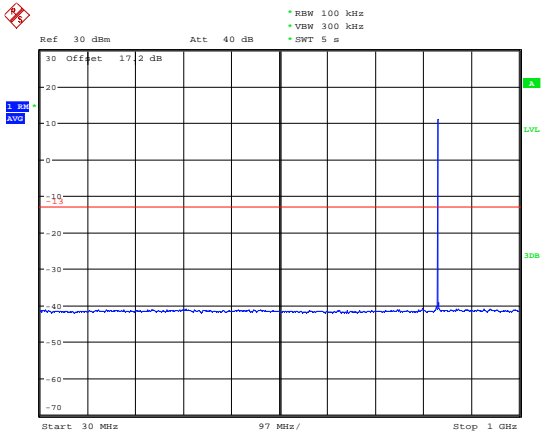

Date: 11.JUN.2020 21:51:07

LTE Band 5 5MHz CH-Middle 1GHz~9GHz

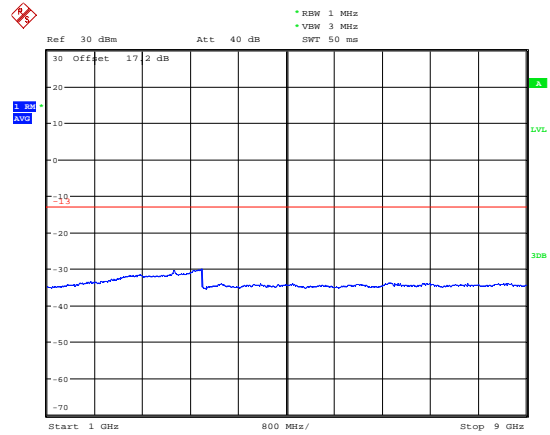

Date: 11.JUN.2020 21:59:18

LTE Band 5 5MHz CH-High 30MHz~1GHz

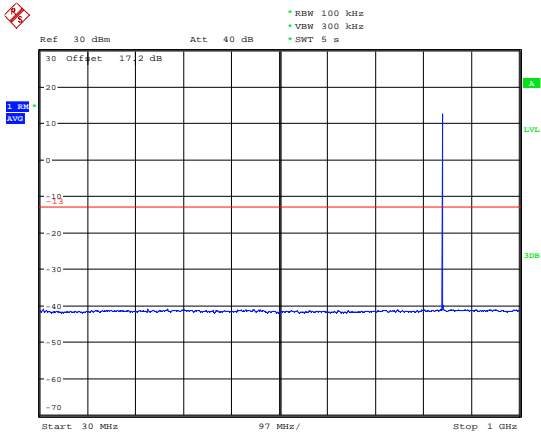

Date: 11.JUN.2020 21:52:28

LTE Band 5 5MHz CH-High 1GHz~9GHz

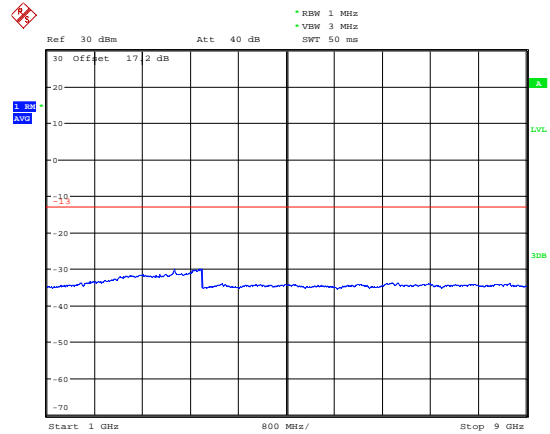

Date: 11.JUN.2020 21:59:25



LTE Band 5 10MHz CH-Low 30MHz~1GHz

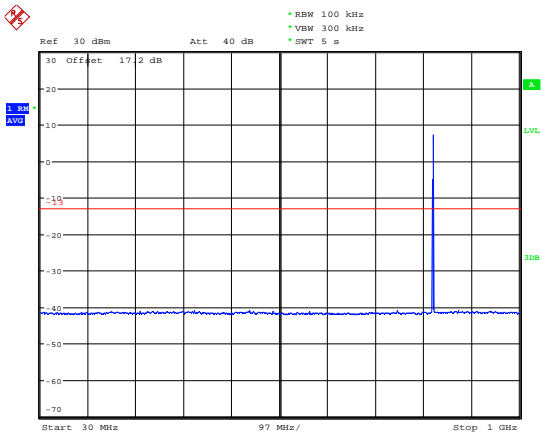

Date: 11.JUN.2020 21:55:19

LTE Band 5 10MHz CH-Low 1GHz~9GHz

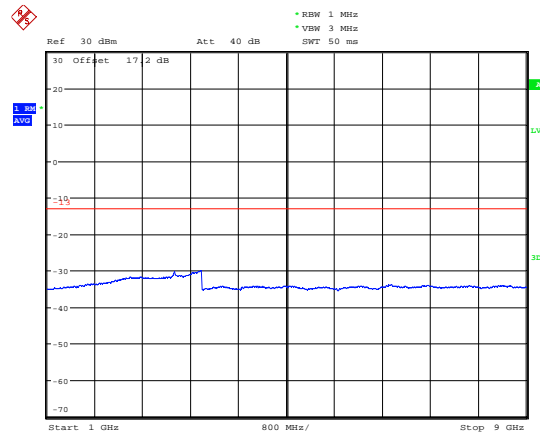

Date: 11.JUN.2020 21:59:36

LTE Band 5 10MHz CH-Middle 30MHz~1GHz

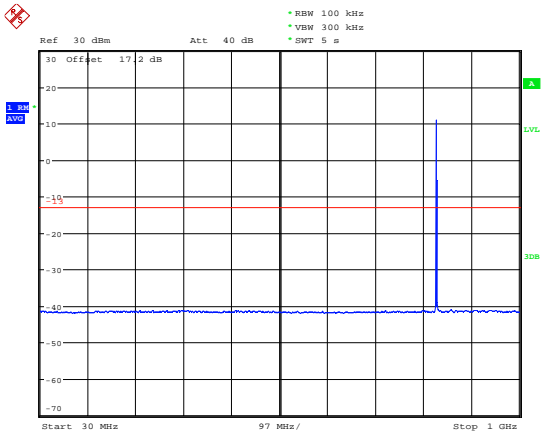

Date: 11.JUN.2020 21:56:10

LTE Band 5 10MHz CH-Middle 1GHz~9GHz

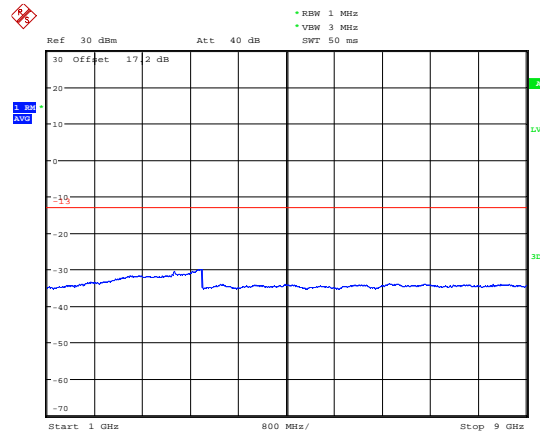

Date: 11.JUN.2020 21:59:44

LTE Band 5 10MHz CH-High 30MHz~1GHz

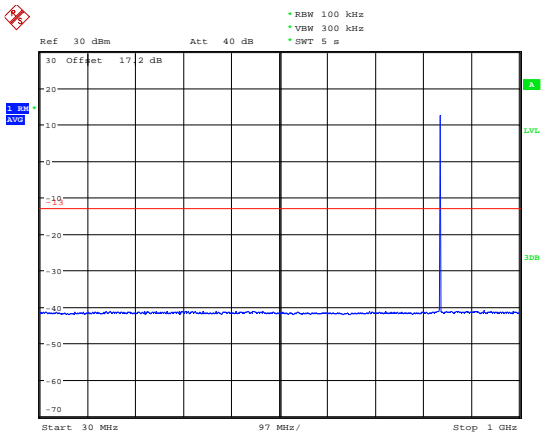

Date: 11.JUN.2020 21:57:46

LTE Band 5 10MHz CH-High 1GHz~9GHz

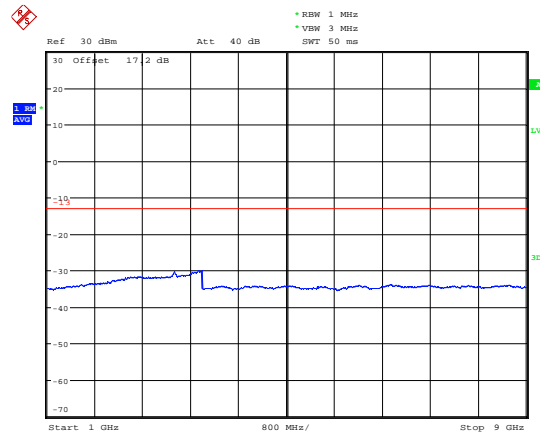

Date: 11.JUN.2020 21:59:53



LTE Band 26 1.4MHz CH-Low 30MHz~1GHz

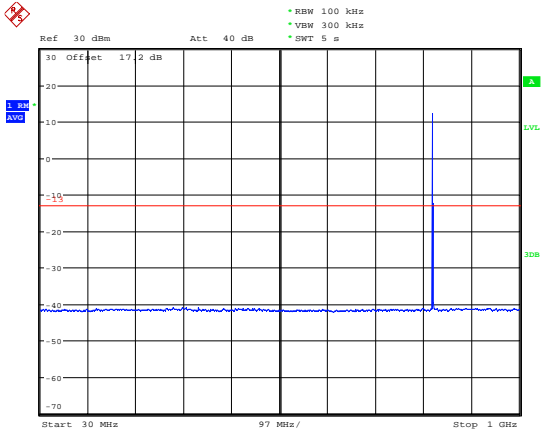

Date: 12.JUN.2020 21:27:16

LTE Band 26 1.4MHz CH-Low 1GHz~9GHz

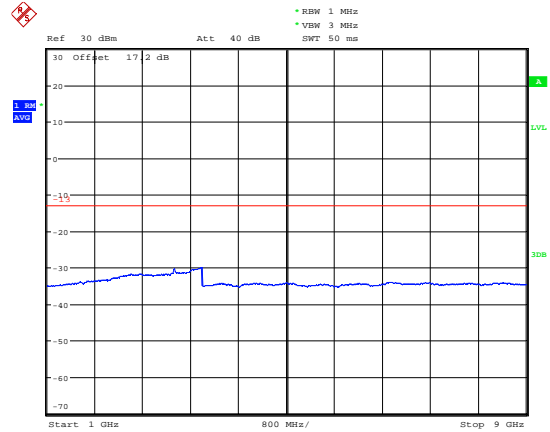

Date: 12.JUN.2020 21:46:52

LTE Band 26 1.4MHz CH-Middle 30MHz~1GHz

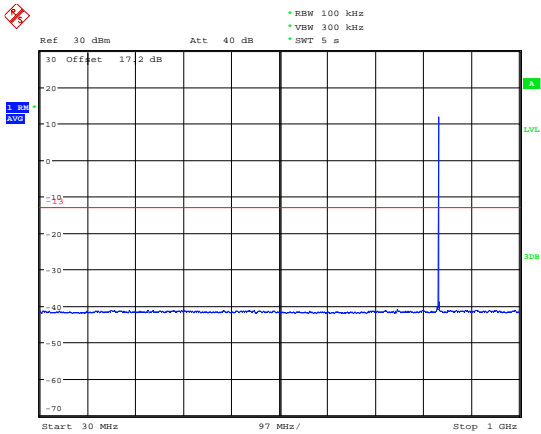

Date: 12.JUN.2020 21:29:32

LTE Band 26 1.4MHz CH-Middle 1GHz~9GHz

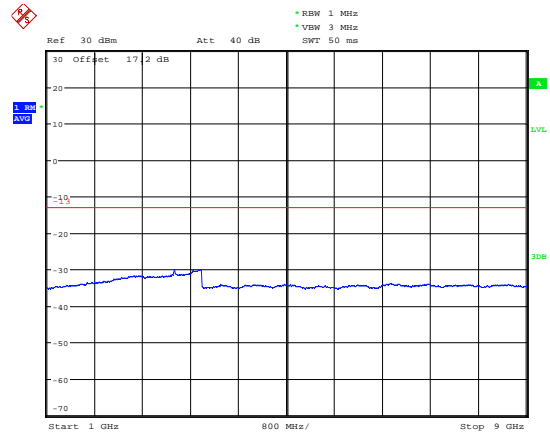

Date: 12.JUN.2020 21:47:00

LTE Band 26 1.4MHz CH-High 30MHz~1GHz

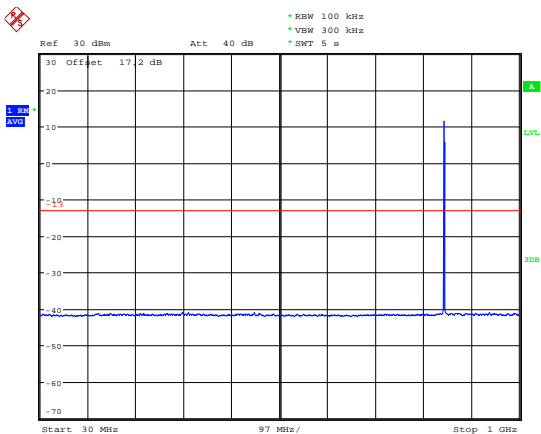

Date: 12.JUN.2020 21:32:30

LTE Band 26 1.4MHz CH-High 1GHz~9GHz

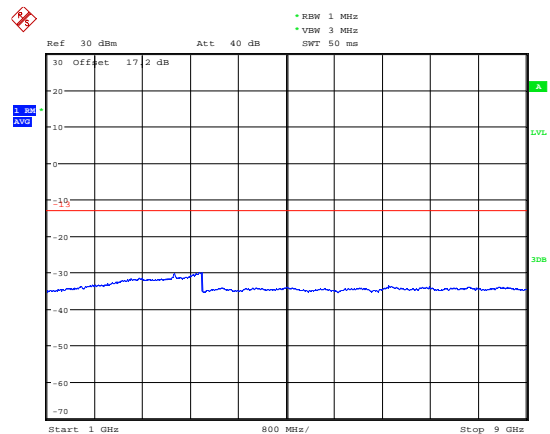

Date: 12.JUN.2020 21:47:08



LTE Band 26 3MHz CH-Low 30MHz~1GHz

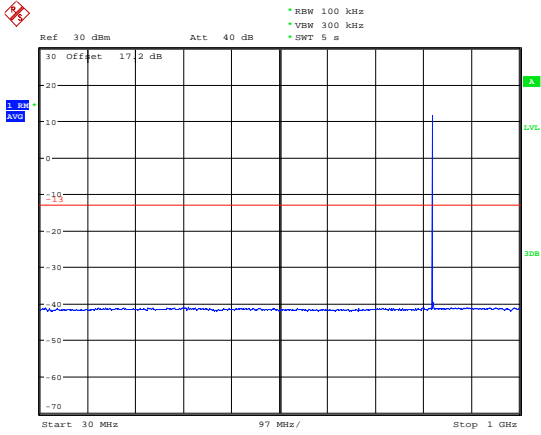

Date: 12.JUN.2020 21:34:15

LTE Band 26 3MHz CH-Low 1GHz~9GHz

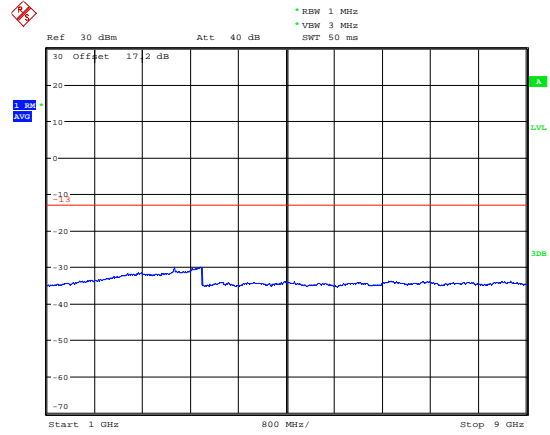

Date: 12.JUN.2020 21:47:16

LTE Band 26 3MHz CH-Middle 30MHz~1GHz

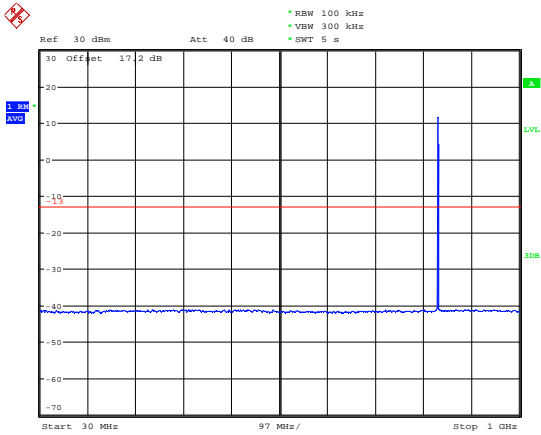

Date: 12.JUN.2020 21:35:36

LTE Band 26 3MHz CH-Middle 1GHz~9GHz

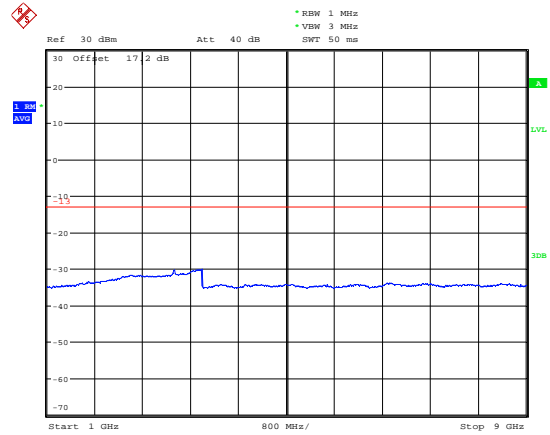

Date: 12.JUN.2020 21:47:24

LTE Band 26 3MHz CH-High 30MHz~1GHz

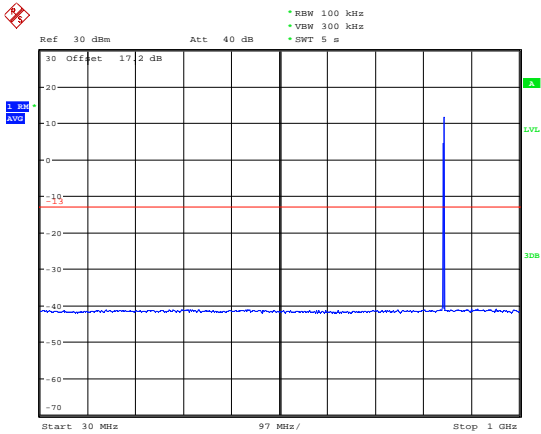

Date: 12.JUN.2020 21:38:22

LTE Band 26 3MHz CH-High 1GHz~9GHz

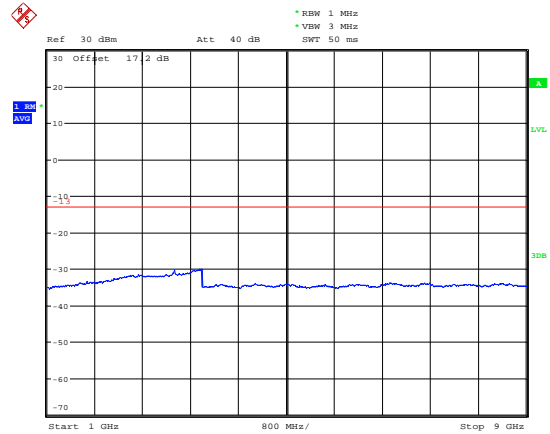

Date: 12.JUN.2020 21:47:32



LTE Band 26 5MHz CH-Low 30MHz~1GHz

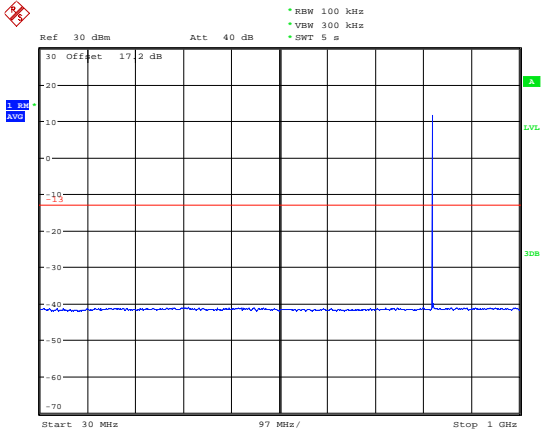

Date: 12.JUN.2020 21:38:59

LTE Band 26 5MHz CH-Low 1GHz~9GHz

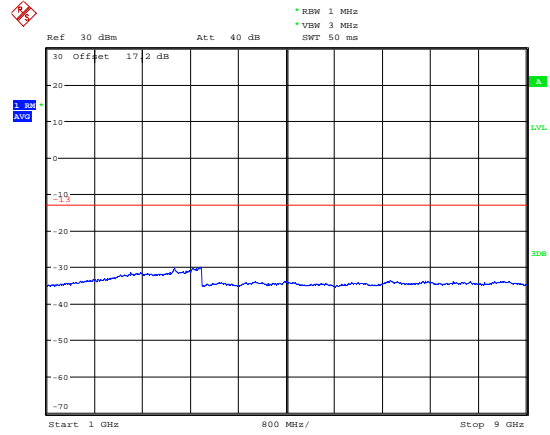

Date: 12.JUN.2020 21:47:39

LTE Band 26 5MHz CH-Middle 30MHz~1GHz

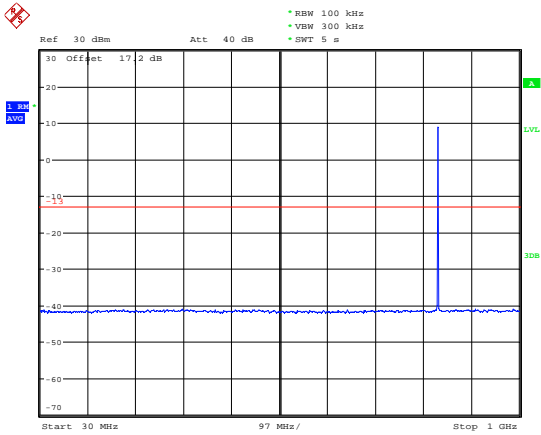

Date: 12.JUN.2020 21:39:33

LTE Band 26 5MHz CH-Middle 1GHz~9GHz

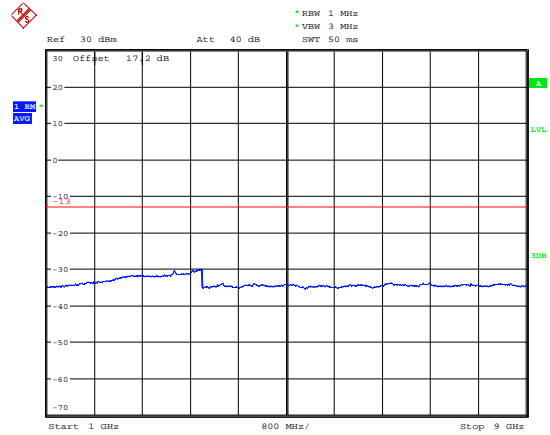

Date: 12.JUN.2020 21:47:47

LTE Band 26 5MHz CH-High 30MHz~1GHz

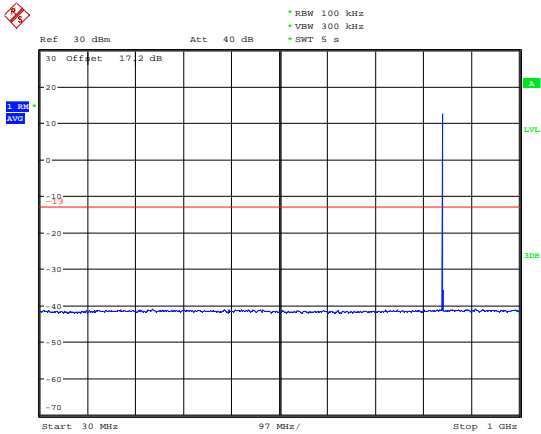

Date: 12.JUN.2020 21:40:48

LTE Band 26 5MHz CH-High 1GHz~9GHz

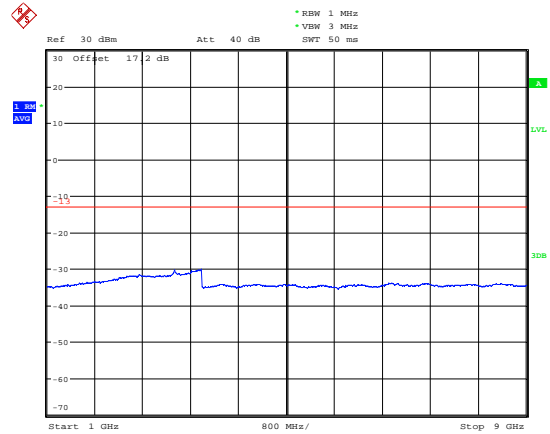

Date: 12.JUN.2020 21:47:55



LTE Band 26 10MHz CH-Low 30MHz~1GHz

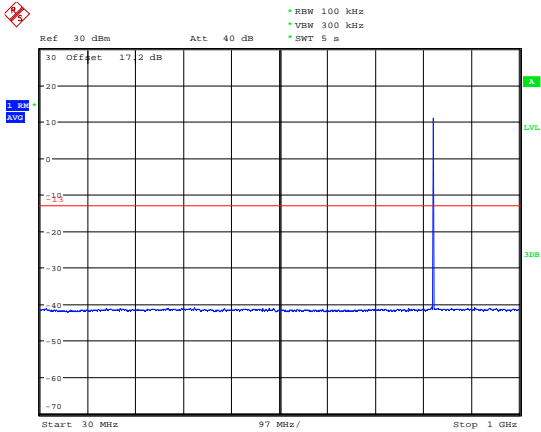

Date: 12.JUN.2020 21:41:21

LTE Band 26 10MHz CH-Low 1GHz~9GHz

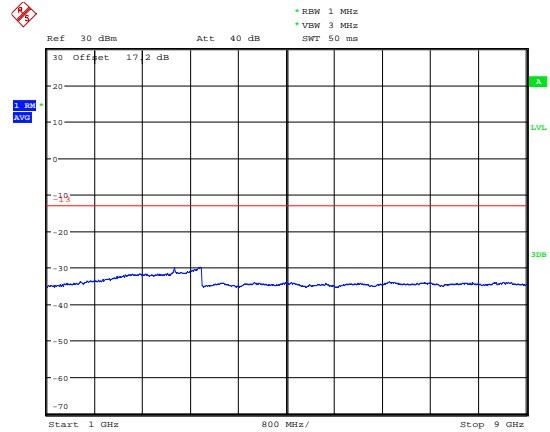

Date: 12.JUN.2020 21:48:03

LTE Band 26 10MHz CH-Middle 30MHz~1GHz

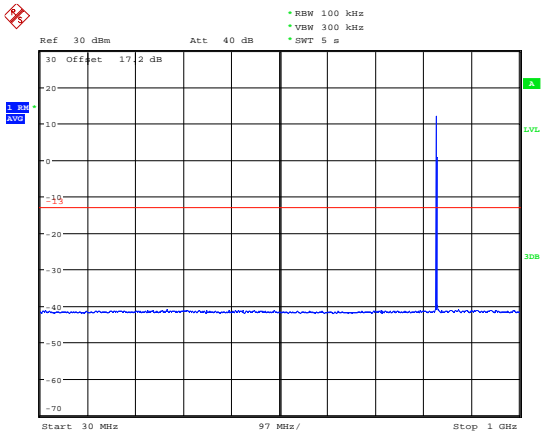

Date: 12.JUN.2020 21:42:54

LTE Band 26 10MHz CH-Middle 1GHz~9GHz

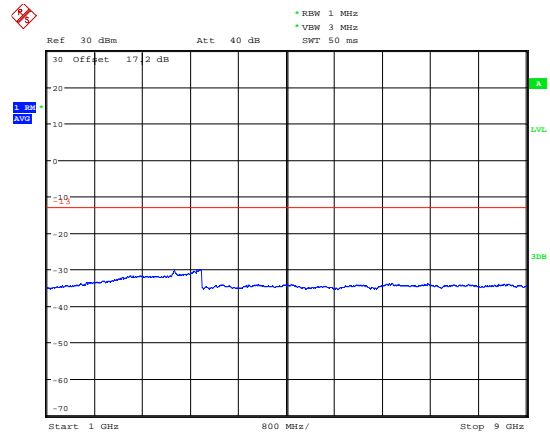

Date: 12.JUN.2020 21:48:12

LTE Band 26 10MHz CH-High 30MHz~1GHz

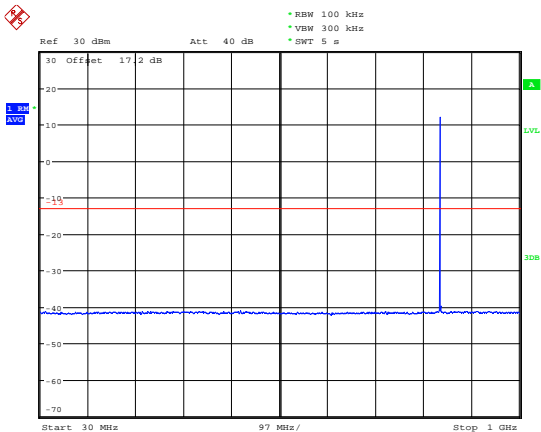

Date: 12.JUN.2020 21:43:39

LTE Band 26 10MHz CH-High 1GHz~9GHz

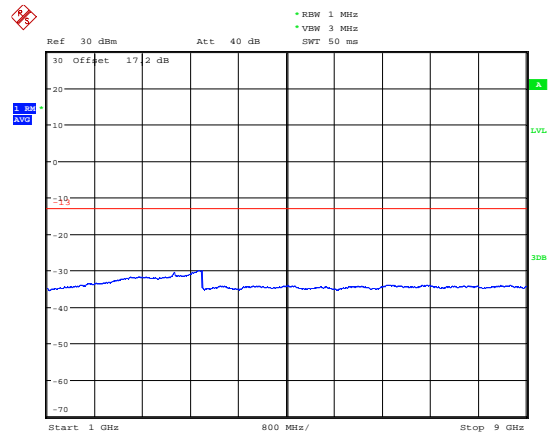

Date: 12.JUN.2020 21:48:21



LTE Band 26 15MHz CH-Low 30MHz~1GHz

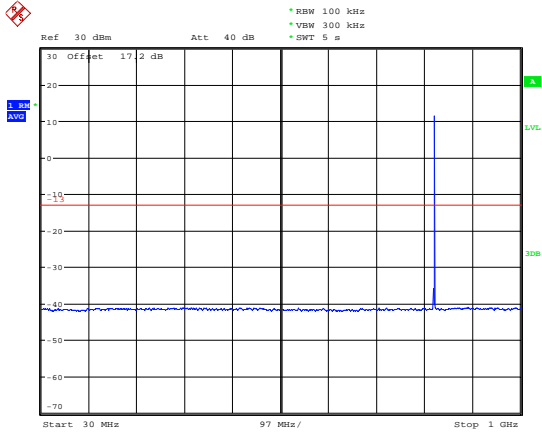

Date: 12.JUN.2020 21:44:43

LTE Band 26 15MHz CH-Low 1GHz~9GHz

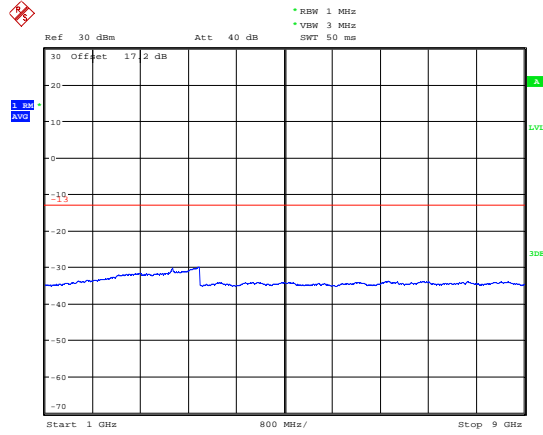

Date: 12.JUN.2020 21:48:29

LTE Band 26 15MHz CH-Middle 30MHz~1GHz

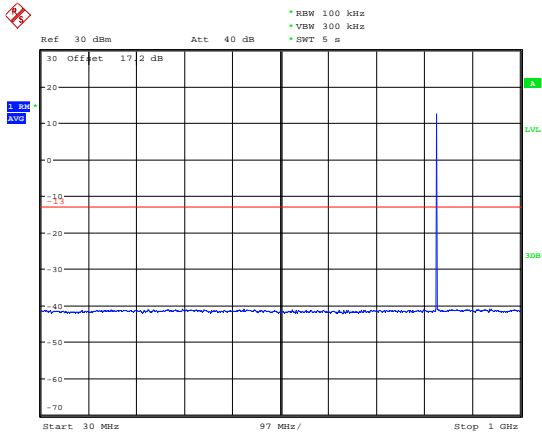

Date: 12.JUN.2020 21:45:40

LTE Band 26 15MHz CH-Middle 1GHz~9GHz

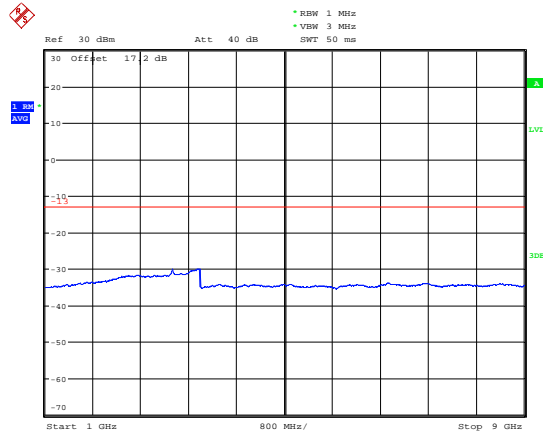

Date: 12.JUN.2020 21:48:39

LTE Band 26 15MHz CH-High 30MHz~1GHz

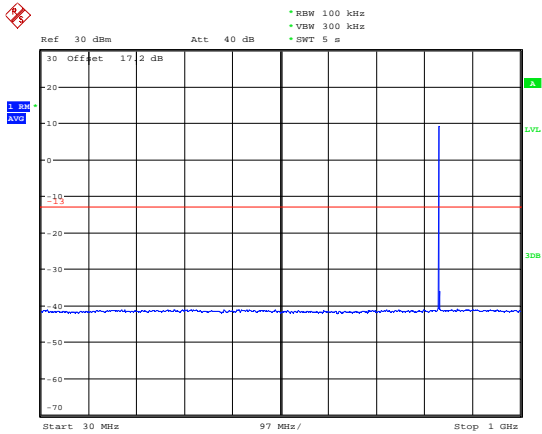

Date: 12.JUN.2020 21:46:27

LTE Band 26 15MHz CH-High 1GHz~9GHz

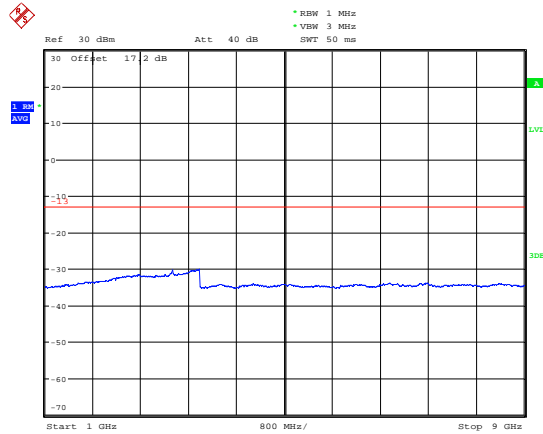

Date: 12.JUN.2020 21:48:47

5.7. Radiates Spurious Emission

Ambient condition

Temperature	Relative humidity	Pressure
23°C ~25°C	45%~50%	101.5kPa

Method of Measurement

1. The testing follows FCC KDB 971168 v03r01 Section 5.8 and ANSI C63.26 (2015).
2. Below 1GHz: The EUT is placed on a turntable 0.8 meters above the ground in the chamber, 3 meter away from the antenna. The maximal emission value is acquired by adjusting the antenna height, polarisation and turntable azimuth. Normally, the height range of antenna is 1 m to 4 m, the azimuth range of turntable is 0° to 360°, and the receive antenna has two polarizations Vertical (V) and Horizontal (H). Above 1GHz: (Note: the FCC's permission to use 1.5m as an alternative per TCBC Conf call of Dec. 2, 2014.) The EUT is placed on a turntable 1.5 meters above the ground in the chamber, 3 meter away from the antenna. The maximal emission value is acquired by adjusting the antenna height, polarisation and turntable azimuth. Normally, the height range of antenna is 1 m to 4 m, the azimuth range of turntable is 0° to 360°, and the receive antenna has two polarizations Vertical (V) and Horizontal (H).
3. A loop antenna, A log-periodic antenna or horn antenna shall be substituted in place of the EUT. The log-periodic antenna will be driven by a signal generator and the level will be adjusted till the same power value on the spectrum analyzer or receiver. The level of the spurious emissions can be calculated through the level of the signal generator, cable loss, the gain of the substitution antenna and the reading of the spectrum analyzer or receiver.
4. The EUT is then put into continuously transmitting mode at its maximum power level during the test. Set Test Receiver or Spectrum RBW=200Hz,VBW=600Hz for 9kHz150kHz , RBW=10kHz, VBW=30kHz 150kHz-30MHz , RBW=100kHz,VBW=300kHz for 30MHz to 1GHz and RBW=1MHz, VBW=3MHz for above 1GHz, And the maximum value of the receiver should be recorded as (Pr).
5. The EUT shall be replaced by a substitution antenna. In the chamber, an substitution antenna for the frequency band of interest is placed at the reference point of the chamber. An RF Signal source for the frequency band of interest is connected to the substitution antenna with a cable that has been constructed to not interfere with the radiation pattern of the antenna. A power (PMea) is applied to the input of the substitution antenna, and adjust the level of the signal generator output until the value of the receiver reach the previously recorded (Pr). The power of signal source (PMea) is recorded. The test should be performed by rotating the test item and adjusting the receiving antenna polarization.
6. A amplifier should be connected to the Signal Source output port. And the cable should be connect between the Amplifier and the Substitution Antenna. The cable loss (Pcl) ,the Substitution Antenna Gain (Ga) and the Amplifier Gain (PAg) should be recorded after test.
7. The measurement results are obtained as described below:
Power(EIRP)=PMea- PAg - Pcl + Ga
The measurement results are amend as described below:
Power(EIRP)=PMea- Pcl + Ga
8. This value is EIRP since the measurement is calibrated using an antenna of known gain (2.15 dBi)

and known input power. ERP can be calculated from EIRP by subtracting the gain of the dipole, $ERP = EIRP - 2.15\text{dBi}$.

The modulation mode and RB allocation refer to section 5.1, using the maximum output power configuration.

Test setup

9KHz ~ 30MHz

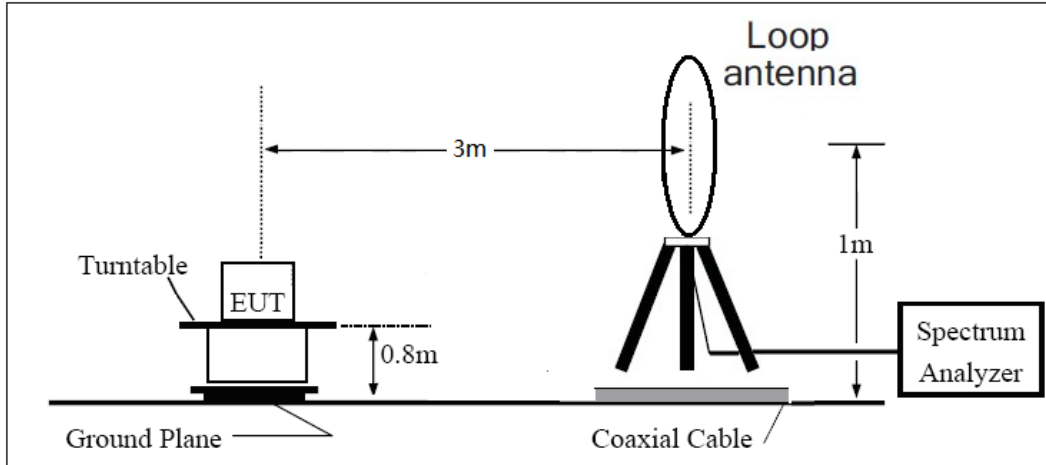

30MHz ~ 1GHz

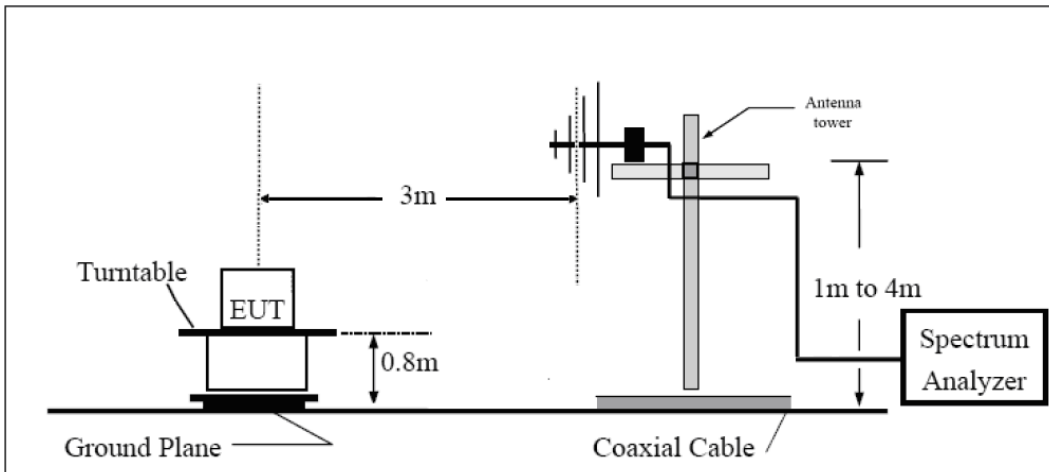

Above 1GHz

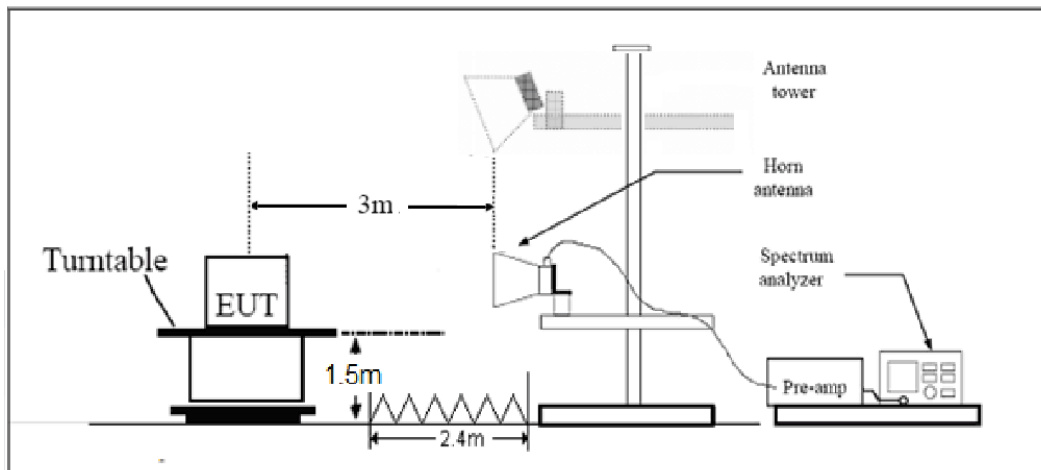



Note: Area side:2.4mX3.6m

Limits

Rule Part 22.917(a) specifies that “The power of any emission outside of the authorized operating frequency ranges must be attenuated below the transmitting power (P) by a factor of at least $43 + 10 \log (P)$ dB.”

Limit	-13 dBm
-------	---------

Measurement Uncertainty

The assessed measurement uncertainty to ensure 95% confidence level for the normal distribution is with the coverage factor $k = 1.96$, $U = 3.55$ dB.

Test Result

For radiated spurious emissions test, the worst mode (Middle Channel) should be reflected in the report.

Sweep the whole frequency band through the range from 9kHz to the 10th harmonic of the carrier, the emissions below the noise floor will not be recorded in the report.

GSM 850 CH-Middle

Harmonic	Frequency (MHz)	SG (dBm)	Cable Loss (dB)	Gain (dBi)	Antenna Polarization	ERP Level (dBm)	Limit (dBm)	Margin (dB)	Azimuth (deg)
2	1673.2	-56.96	2.00	10.75	Horizontal	-50.36	-13.00	37.36	315
3	2509.8	-47.59	2.51	11.05	Horizontal	-41.20	-13.00	28.20	90
4	3346.4	-56.10	4.20	11.15	Horizontal	-51.30	-13.00	38.30	315
5	4183.0	-55.50	5.20	11.15	Horizontal	-51.70	-13.00	38.70	90
6	5019.6	-54.50	5.50	11.95	Horizontal	-50.20	-13.00	37.20	0
7	5856.2	-56.40	5.70	13.55	Horizontal	-50.70	-13.00	37.70	45
8	6692.8	-57.00	6.30	13.75	Horizontal	-51.70	-13.00	38.70	225
9	7529.4	-53.30	6.80	13.85	Horizontal	-48.40	-13.00	35.40	135
10	8366.0	-53.90	6.90	14.25	Horizontal	-48.70	-13.00	35.70	270

Note: 1.The other Spurious RF Radiated emissions level is no more than noise floor.
 2.The worst emission was found in the antenna is Horizontal position.

LTE Band 5 1.4MHz CH-Middle

Harmonic	Frequency (MHz)	SG (dBm)	Cable Loss (dB)	Gain (dBi)	Antenna Polarization	ERP Level (dBm)	Limit (dBm)	Margin (dB)	Azimuth (deg)
2	1673.0	-62.20	2.00	10.75	Horizontal	-55.60	-13.00	42.60	0
3	2509.5	-60.69	2.51	11.05	Horizontal	-54.30	-13.00	41.30	315
4	3346.0	-53.70	4.20	11.15	Horizontal	-48.90	-13.00	35.90	45
5	4182.5	-53.60	5.20	11.15	Horizontal	-49.80	-13.00	36.80	315
6	5019.0	-52.70	5.50	11.95	Horizontal	-48.40	-13.00	35.40	45
7	5855.5	-55.50	5.70	13.55	Horizontal	-49.80	-13.00	36.80	225
8	6692.0	-57.40	6.30	13.75	Horizontal	-52.10	-13.00	39.10	315
9	7528.5	-53.00	6.80	13.85	Horizontal	-48.10	-13.00	35.10	90
10	8365.0	-53.90	6.90	14.25	Horizontal	-48.70	-13.00	35.70	45

Note: 1.The other Spurious RF Radiated emissions level is no more than noise floor.
 2.The worst emission was found in the antenna is Horizontal position.



LTE Band 5 5MHz CH-Middle

Harmonic	Frequency (MHz)	SG (dBm)	Cable Loss (dB)	Gain (dBi)	Antenna Polarization	ERP Level (dBm)	Limit (dBm)	Margin (dB)	Azimuth (deg)
2	1668.6	-62.40	2.00	10.75	Horizontal	-55.80	-13.00	42.80	270
3	2503.3	-60.39	2.51	11.05	Horizontal	-54.00	-13.00	41.00	45
4	3337.5	-54.50	4.20	11.15	Horizontal	-49.70	-13.00	36.70	315
5	4171.9	-55.10	5.20	11.15	Horizontal	-51.30	-13.00	38.30	45
6	5006.3	-52.60	5.50	11.95	Horizontal	-48.30	-13.00	35.30	90
7	5840.6	-56.30	5.70	13.55	Horizontal	-50.60	-13.00	37.60	0
8	6675.0	-57.26	6.30	13.75	Horizontal	-51.96	-13.00	38.96	0
9	7509.4	-52.80	6.80	13.85	Horizontal	-47.90	-13.00	34.90	45
10	8343.8	-54.00	6.90	14.25	Horizontal	-48.80	-13.00	35.80	225

Note: 1.The other Spurious RF Radiated emissions level is no more than noise floor.
 2.The worst emission was found in the antenna is Horizontal position.

LTE Band 5 10MHz CH-Middle

Harmonic	Frequency (MHz)	SG (dBm)	Cable Loss (dB)	Gain (dBi)	Antenna Polarization	ERP Level (dBm)	Limit (dBm)	Margin (dB)	Azimuth (deg)
2	1664.4	-61.30	2.00	10.75	Horizontal	-54.70	-13.00	41.70	0
3	2496.6	-59.79	2.51	11.05	Horizontal	-53.40	-13.00	40.40	45
4	3346.0	-55.46	4.20	11.15	Horizontal	-50.66	-13.00	37.66	90
5	4182.5	-53.70	5.20	11.15	Horizontal	-49.90	-13.00	36.90	180
6	5019.0	-53.10	5.50	11.95	Horizontal	-48.80	-13.00	35.80	135
7	5855.5	-56.70	5.70	13.55	Horizontal	-51.00	-13.00	38.00	0
8	6692.0	-56.50	6.30	13.75	Horizontal	-51.20	-13.00	38.20	45
9	7528.5	-52.60	6.80	13.85	Horizontal	-47.70	-13.00	34.70	225
10	8365.0	-53.50	6.90	14.25	Horizontal	-48.30	-13.00	35.30	90

Note: 1.The other Spurious RF Radiated emissions level is no more than noise floor.
 2.The worst emission was found in the antenna is Horizontal position.

LTE Band 26 1.4MHz CH-Middle

Harmonic	Frequency (MHz)	SG (dBm)	Cable Loss (dB)	Gain (dBi)	Antenna Polarization	ERP Level (dBm)	Limit (dBm)	Margin (dB)	Azimuth (deg)
2	1673.0	-64.10	2.00	10.75	Horizontal	-57.50	-13.00	44.50	135
3	2509.5	-60.59	2.51	11.05	Horizontal	-54.20	-13.00	41.20	270
4	3346.0	-54.90	4.20	11.15	Horizontal	-50.10	-13.00	37.10	315
5	4182.5	-55.00	5.20	11.15	Horizontal	-51.20	-13.00	38.20	270
6	5019.0	-54.00	5.50	11.95	Horizontal	-49.70	-13.00	36.70	0
7	5855.5	-56.40	5.70	13.55	Horizontal	-50.70	-13.00	37.70	90
8	6692.0	-56.90	6.30	13.75	Horizontal	-51.60	-13.00	38.60	45
9	7528.5	-52.10	6.80	13.85	Horizontal	-47.20	-13.00	34.20	135
10	8365.0	-54.50	6.90	14.25	Horizontal	-49.30	-13.00	36.30	180

Note: 1.The other Spurious RF Radiated emissions level is no more than noise floor.
2.The worst emission was found in the antenna is Horizontal position.

LTE Band 26 5MHz CH-Middle

Harmonic	Frequency (MHz)	SG (dBm)	Cable Loss (dB)	Gain (dBi)	Antenna Polarization	ERP Level (dBm)	Limit (dBm)	Margin (dB)	Azimuth (deg)
2	1673.0	-64.30	2.00	10.75	Horizontal	-57.70	-13.00	44.70	135
3	2509.5	-60.59	2.51	11.05	Horizontal	-54.20	-13.00	41.20	225
4	3306.0	-54.40	4.20	11.15	Horizontal	-49.60	-13.00	36.60	225
5	4130.5	-53.90	5.20	11.15	Horizontal	-50.10	-13.00	37.10	90
6	4959.0	-52.80	5.50	11.95	Horizontal	-48.50	-13.00	35.50	45
7	5785.5	-54.90	5.70	13.55	Horizontal	-49.20	-13.00	36.20	135
8	6612.0	-56.70	6.30	13.75	Horizontal	-51.40	-13.00	38.40	45
9	7438.0	-53.50	6.80	13.85	Horizontal	-48.60	-13.00	35.60	90
10	8265.0	-52.80	6.90	14.25	Horizontal	-47.60	-13.00	34.60	225

Note: 1.The other Spurious RF Radiated emissions level is no more than noise floor.
2.The worst emission was found in the antenna is Horizontal position.



LTE Band 26 15MHz CH-Middle

Harmonic	Frequency (MHz)	SG (dBm)	Cable Loss (dB)	Gain (dBi)	Antenna Polarization	ERP Level (dBm)	Limit (dBm)	Margin (dB)	Azimuth (deg)
2	1673.0	-63.90	2.00	10.75	Horizontal	-57.30	-13.00	44.30	45
3	2509.5	-58.09	2.51	11.05	Horizontal	-51.70	-13.00	38.70	315
4	3320.0	-55.60	4.20	11.15	Horizontal	-50.80	-13.00	37.80	180
5	4150.0	-53.20	5.20	11.15	Horizontal	-49.40	-13.00	36.40	315
6	4980.0	-52.29	5.50	11.95	Horizontal	-47.99	-13.00	34.99	90
7	5810.0	-56.67	5.70	13.55	Horizontal	-50.97	-13.00	37.97	45
8	6640.0	-56.00	6.30	13.75	Horizontal	-50.70	-13.00	37.70	135
9	7470.0	-52.50	6.80	13.85	Horizontal	-47.60	-13.00	34.60	270
10	8300.0	-53.80	6.90	14.25	Horizontal	-48.60	-13.00	35.60	225

Note: 1.The other Spurious RF Radiated emissions level is no more than noise floor.

2.The worst emission was found in the antenna is Horizontal position.



6. Main Test Instruments

Name	Manufacturer	Type	Serial Number	Calibration Date	Expiration Date
Power Splitter	Hua Xiang	SHX-GF2-2-13	10120101	/	/
Spectrum Analyzer	Key sight	N9010A	MY50210259	2020-05-18	2021-05-17
Universal Radio Communication Tester	Key sight	E5515C	MY48367192	2020-05-27	2021-05-26
Signal Analyzer	R&S	FSV30	100815	2019-12-15	2020-12-14
Loop Antenna	SCHWARZBECK	FMZB1519	1519-047	2017-09-26	2020-09-25
Trilog Antenna	SCHWARZBECK	VUBL 9163	9163-201	2017-11-18	2020-11-17
Horn Antenna	R&S	HF907	102723	2018-08-11	2021-08-10
Horn Antenna	ETS-Lindgren	3160-09	00102643	2018-06-20	2021-06-19
Signal generator	R&S	SMB 100A	102594	2020-05-18	2021-05-17
Climatic Chamber	ESPEC	SU-242	93000506	2017-12-17	2020-12-16
Preamplifier	R&S	SCU18	102327	2020-05-18	2021-05-17
MOB COMMS DC SUPPLY	Keysight	66319D	MY43004105	2020-05-18	2021-05-17
RF Cable	Agilent	SMA 15cm	0001	2019-12-13	2020-06-12
RF Cable	Agilent	SMA 15cm	0001	2020-06-12	2020-12-11
Software	R&S	EMC32	9.26.0	/	/

*****END OF REPORT *****