

EMC TEST REPORT

Applicant	Positioning Universal Inc
FCC ID	2AHRH-FJ970ME
Product	GPS Tracker
Brand	PUI
Model	FJ970ME
Report No.	R2402A0117-E1
Issue Date	March 18, 2024

TA Technology (Shanghai) Co., Ltd. tested the above equipment in accordance with the requirements in **FCC Code CFR47 Part15B (2023)/ ANSI C63.4-2014**. The test results show that the equipment tested is capable of demonstrating compliance with the requirements as documented in this report.

Prepared by: Liu Wei

Approved by: Fan Guangchang

TA Technology (Shanghai) Co., Ltd.

Building 3, No.145, Jintang Rd, Pudong Shanghai, P.R.China

TEL: +86-021-50791141/2/3

FAX: +86-021-50791141/2/3-8000

Table of Contents

1	Test Laboratory	4
1.1	Notes of the Test Report.....	4
1.2	Test Facility.....	4
1.3	Testing Location.....	4
2	General Description of Equipment Under Test	5
2.1	Applicant and Manufacturer Information	5
2.2	General Information	5
2.3	Applied Standards	6
2.4	Test Mode	7
3	Test Case Results	8
3.1	Radiated Emission.....	8
3.2	Conducted Emission.....	13
4	Uncertainty Measurement.....	16
5	Main Test Instruments.....	17
	ANNEX A: The EUT Appearance	18
	ANNEX B: Test Setup Photos	19

Summary of measurement results

Number	Test Case	Clause in FCC Rules	Conclusion
1	Radiated Emission	FCC Part15.109, ANSI C63.4-2014	PASS
2	Conducted Emission	FCC Part15.107, ANSI C63.4-2014	PASS
Date of Testing: February 5, 2024 ~ March 6, 2024			
Date of Sample Received: February 1, 2024			
Note: All indications of Pass/Fail in this report are opinions expressed by TA Technology (Shanghai) Co., Ltd. based on interpretations and/or observations of test results. Measurement Uncertainties were not taken into account and are published for informational purposes only.			

1 Test Laboratory

1.1 Notes of the Test Report

This report shall not be reproduced in full or partial, without the written approval of **TA Technology (Shanghai) Co., Ltd.** The results documented in this report apply only to the tested sample, under the conditions and modes of operation as described herein. Measurement Uncertainties were not taken into account and are published for informational purposes only. This report is written to support regulatory compliance of the applicable standards stated above.

1.2 Test Facility

FCC (Designation number: CN1179, Test Firm Registration Number: 446626)

TA Technology (Shanghai) Co., Ltd. has been listed on the US Federal Communications Commission list of test facilities recognized to perform measurements.

A2LA (Certificate Number: 3857.01)

TA Technology (Shanghai) Co., Ltd. has been listed by American Association for Laboratory Accreditation to perform measurement.

1.3 Testing Location

Company: TA Technology (Shanghai) Co., Ltd.
Address: Building 3, No.145, Jintang Rd, Pudong Shanghai, P.R.China
City: Shanghai
Post code: 201201
Country: P. R. China
Contact: Fan Guangchang
Telephone: +86-021-50791141/2/3
Fax: +86-021-50791141/2/3-8000
Website: <https://www.eurofins.com/electrical-and-electronics>
E-mail: Jack.Fan@cpt.eurofinscn.com

2 General Description of Equipment Under Test

2.1 Applicant and Manufacturer Information

Applicant	Positioning Universal Inc
Applicant address	4660 La Jolla Village Drive, Suite 1100, San Diego, CA92122, US
Manufacturer	Positioning Universal Inc
Manufacturer address	4660 La Jolla Village Drive, Suite 1100, San Diego, CA92122, US

2.2 General Information

EUT Description			
Device Type	Fixed Device		
Model	FJ970ME		
Lab internal SN	R2402A0117/S01		
HW Version	P6		
SW Version	1.2.0		
Power Rating	12V		
Connecting I/O Port(s)	Please refer to the User's Manual.		
Antenna Type	WWAN	PIFA Antenna	
	Bluetooth LE	Chip Antenna	
Frequency	Band	Tx (MHz)	Rx (MHz)
	GSM 850	824 ~ 849	869 ~ 894
	GSM 1900	1850 ~ 1910	1930 ~ 1990
	LTE-M Band 2	1850 ~ 1910	1930 ~ 1990
	LTE-M Band 4	1710 ~ 1755	2110 ~ 2155
	LTE-M Band 5	824 ~ 849	869 ~ 894
	LTE-M Band 12	699 ~ 716	729 ~ 746
	LTE-M Band 13	777 ~ 787	746 ~ 756
	LTE-M Band 25	1850 ~ 1915	1930 ~ 1995
	LTE-M Band 26	814 ~ 849	859 ~ 894
	LTE-M Band 66	1710 ~ 1780	2110 ~ 2180
	LTE-M Band 85	698 ~ 716	728 ~ 746
	Bluetooth LE	2400 ~ 2483.5	2400 ~ 2483.5
<p>Note:</p> <p>1. The EUT is sent from the applicant to TA and the information of the EUT is declared by the applicant.</p>			

2.3 Applied Standards

According to the specifications of the manufacturer, it must comply with the requirements of the following standards:

Test standards

FCC Code CFR47 Part15B (2023)

ANSI C63.4-2014

2.4 Test Mode

Test Mode	
Mode 1	Adapter + EUT + GSM/LTE-M /BLE Receiver
Mode 2	Adapter + EUT + GSM/LTE-M /BLE Standby

Test Type	Test Mode	Worst Mode
Radiated Emission	Mode 1, 2	Mode 1
Conducted Emission	Mode 1, 2	Mode 1
During the test, the preliminary test was performed in all modes, the test data of the worst-case condition was recorded in this report.		

3 Test Case Results

3.1 Radiated Emission

Ambient Condition

Temperature	Relative humidity
15°C ~ 35°C	30% ~ 60%

Methods of Measurement

The EUT is placed on a non-metallic table 0.8m above the horizontal metal reference ground plane. The distance between EUT and receive antenna should be 3 meters. During the test, the EUT was operating in its typical mode. The test method is according to ANSI C63.4-2014. Sweep the whole frequency band through the range from 30MHz to the 5th harmonic of the carrier. During the test, the height of receive antenna shall be moved from 1 to 4 meters, and the antenna shall be performed under horizontal and vertical polarization. The turn table shall be rotated from 0 to 360 degrees for detecting the maximum of radiated signal level.

The data of cable loss and antenna factor has been calibrated in full testing frequency range before the testing. During the test, the EUT is worked at maximum output power.

Set the spectrum analyzer in the following:

Below 1GHz:

RBW=100 kHz / VBW=300 kHz / Sweep=AUTO

Above 1GHz:

(a) PEAK Detector: RBW=1MHz / VBW=3MHz/ Sweep=AUTO

(b) AVERAGE Detector: RBW=1MHz / VBW=3MHz / Sweep=AUTO

The radiated emission was measured in the following position: EUT stand-up position (Z axis), lie-down position (X, Y axis). The worst emission was found in lie-down position (X axis) and the worst case was recorded.

Test Setup

Below 1GHz

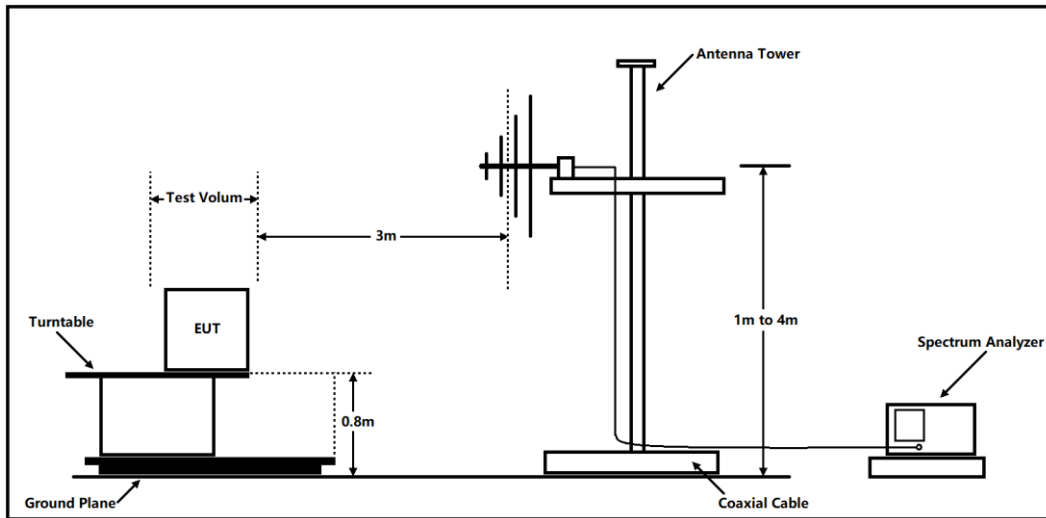

Above 1GHz

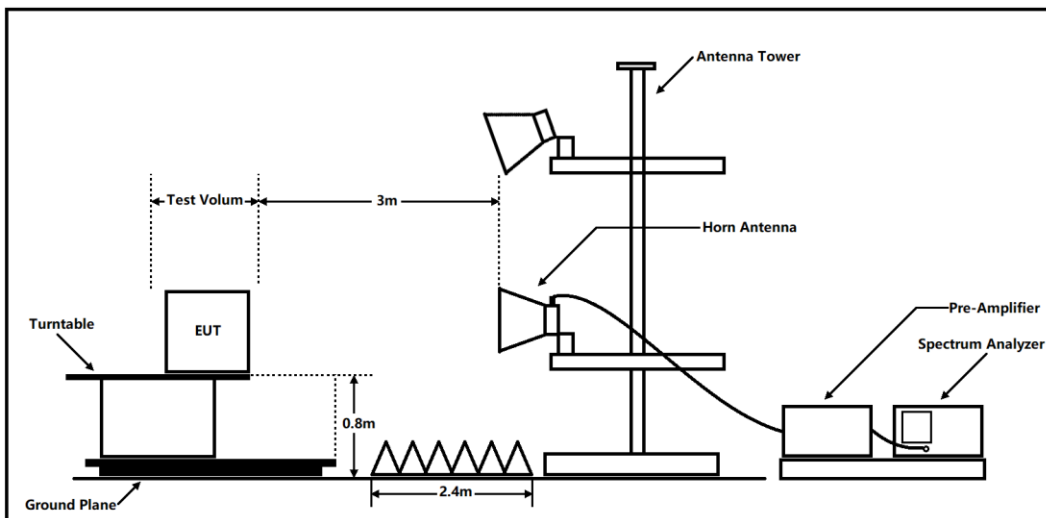

Antenna Tower meets ANSI C63.4 requirements for measurements above 1 GHz by keeping the antenna aimed at the EUT during the antenna's ascent/ descent along the antenna mast.

Limits
Class B

Frequency (MHz)	Field Strength (dB μ V/m)	Detector
30 -88	40.0	Quasi-peak
88-216	43.5	Quasi-peak
216 – 960	46.0	Quasi-peak
960-1000	54.0	Quasi-peak
1000-5 th harmonic of the highest frequency or 40GHz, which is lower	54 74	Average Peak

Frequency range of radiated measurements

Highest frequency generated or used in the device or on which the device operates or tunes (MHz)	Upper frequency of measurement range (MHz)
Below 1.705	30
1.705-108	1000
108-500	2000
500-1000	5000
Above 1000	5th harmonic of the highest frequency or 40 GHz, whichever is lower.

Test Results

Sweep the whole frequency band through the range from 30MHz to the 5th harmonic of the carrier.

The following graphs display the maximum values of horizontal and vertical by software.

For above 1GHz, Blue trace uses the peak detection, Green trace uses the average detection.

A symbol ($\text{dB } \mu\text{V/m}$) in the test plot below means (dB $\mu\text{V/m}$)

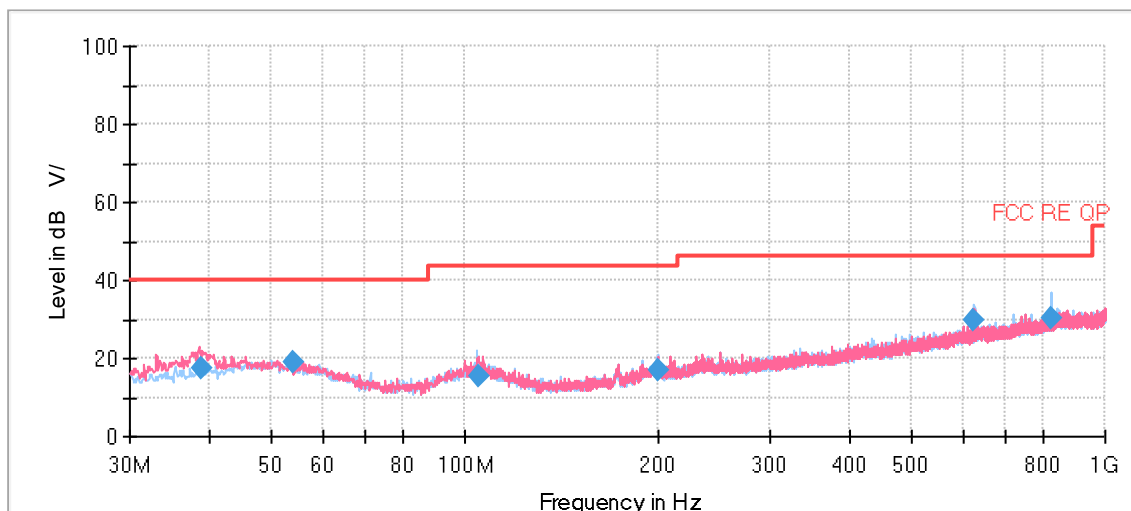

Radiated Emission from 30MHz to 1GHz

Frequency (MHz)	Quasi-Peak (dB $\mu\text{V/m}$)	Limit (dB $\mu\text{V/m}$)	Margin (dB)	Height (cm)	Polarization	Azimuth (deg)	Correct Factor (dB)
38.967500	17.43	40.00	22.57	100.0	V	354.0	19.5
54.013750	19.09	40.00	20.91	109.0	V	136.0	20.7
105.01000	15.47	43.50	28.03	125.0	H	153.0	19.0
199.99250	17.06	43.50	26.44	185.0	H	175.0	18.8
625.09500	29.81	46.00	16.19	110.0	H	1.0	27.6
823.58625	30.07	46.00	15.93	225.0	H	225.0	29.8

Remark: 1. Correction Factor = Antenna factor + Insertion loss(cable loss+amplifier gain)

2. Margin = Limit – Quasi-Peak

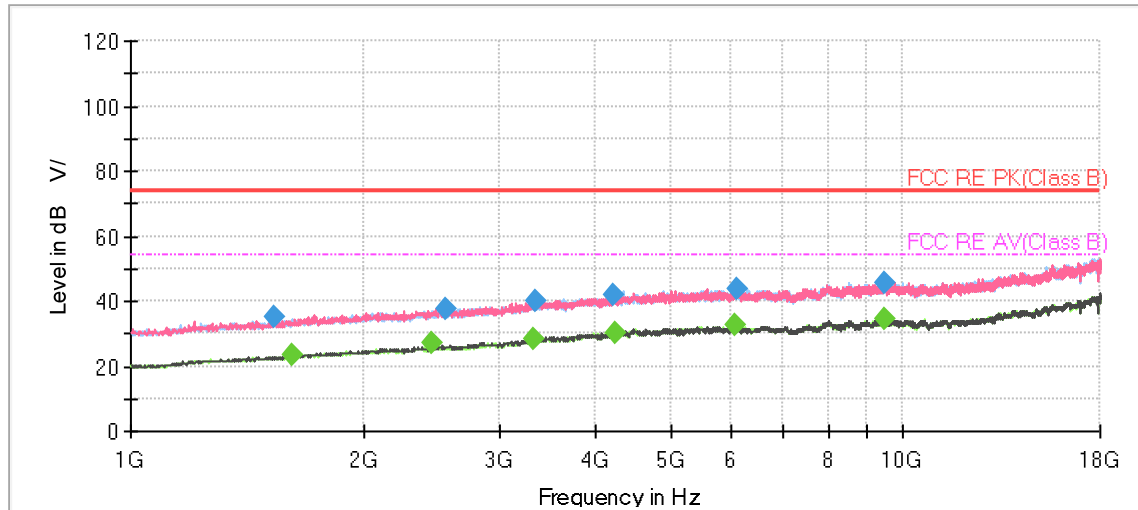

Radiated Emission from 1GHz to 18GHz

Frequency (MHz)	MaxPeak (dBμV/m)	Average (dBμV/m)	Limit (dB μ V/m)	Margin (dB)	Meas. Time (ms)	Height (cm)	Pol	Azimuth (deg)	Corr. (dB/m)
1537.625000	35.27	---	74.00	38.73	500.0	200.0	V	111.0	-16.6
1614.125000	---	23.44	54.00	30.56	500.0	100.0	V	191.0	-16.3
2449.250000	---	26.93	54.00	27.07	500.0	200.0	V	190.0	-12.6
2555.500000	37.63	---	74.00	36.37	500.0	200.0	V	145.0	-12.2
3324.750000	---	28.53	54.00	25.47	500.0	100.0	V	84.0	-9.3
3343.875000	39.94	---	74.00	34.06	500.0	200.0	V	72.0	-9.3
4219.375000	41.91	---	74.00	32.09	500.0	100.0	V	157.0	-6.8
4234.250000	---	30.35	54.00	23.65	500.0	100.0	H	56.0	-6.9
6057.500000	---	32.46	54.00	21.54	500.0	200.0	H	82.0	-3.6
6102.125000	43.78	---	74.00	30.22	500.0	200.0	H	302.0	-3.9
9478.750000	---	34.27	54.00	19.73	500.0	200.0	V	330.0	-0.2
9487.250000	45.82	---	74.00	28.18	500.0	200.0	V	145.0	-0.3

Remark: 1. Correction Factor = Antenna factor + Insertion loss (cable loss + amplifier gain)

2. Peak Margin = Limit - MAX Peak/ Average

3.2 Conducted Emission

Ambient Condition

Temperature	Relative humidity
15°C ~ 35°C	30% ~ 60%

Methods of Measurement

The EUT is placed on a non-metallic table of 80cm height above the horizontal metal reference ground plane. During the test, the EUT was operating in its typical mode. The test method is according to ANSI C63.4-2014. Connect the AC power line of the EUT to the L.I.S.N. Use EMI receiver to detect the average and Quasi-peak value. RBW is set to 9 kHz, VBW is set to 30kHz. The measurement result should include both L line and N line.

Test Setup

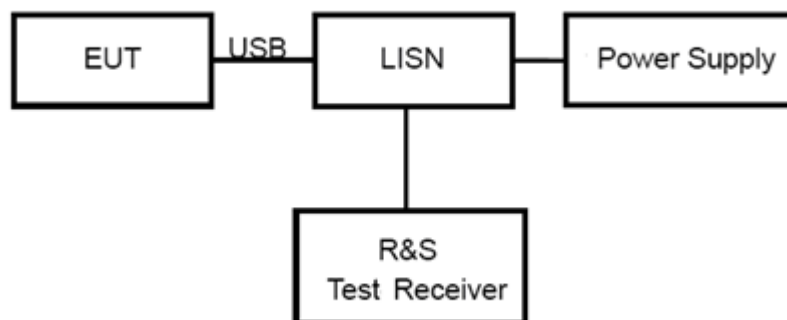

Note: Power Supply is AC Power source and it is used to change the voltage 120V/60Hz.

Limits

Frequency (MHz)	Class A (dBµV)		Class B (dBµV)	
	Quasi-peak	Average	Quasi-peak	Average
0.15 - 0.5	79	66	66 to 56 *	56 to 46*
0.5 - 5	73	60	56	46
5 - 30	73	60	60	50

*: Decreases with the logarithm of the frequency.

Note: The EUT should meet CLASS B limit.

Test Results

Following plots, Blue trace uses the peak detection; Green trace uses the average detection.

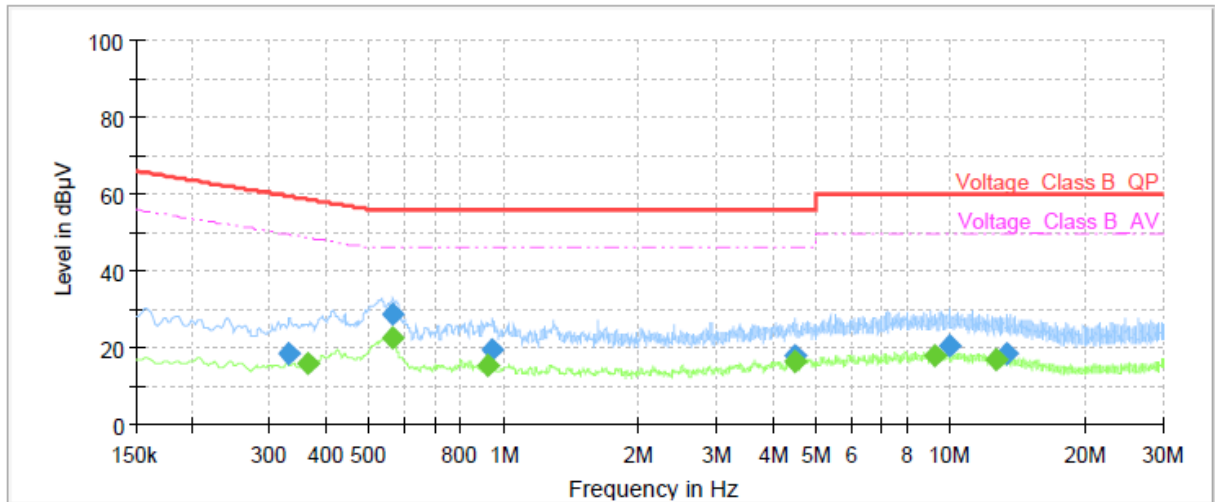

Frequency (MHz)	QuasiPeak (dBµV)	Average (dBµV)	Limit (dBµV)	Margin (dB)	Meas. Time (ms)	Bandwidth (kHz)	Line	Filter	Corr. (dB)
0.33	18.65	---	59.45	40.80	1000.0	9.000	L1	ON	21.0
0.36	---	15.82	48.69	32.87	1000.0	9.000	L1	ON	21.0
0.56	---	22.76	46.00	23.24	1000.0	9.000	L1	ON	20.8
0.56	28.51	---	56.00	27.49	1000.0	9.000	L1	ON	20.8
0.92	---	15.22	46.00	30.78	1000.0	9.000	L1	ON	20.3
0.94	19.24	---	56.00	36.76	1000.0	9.000	L1	ON	20.3
4.47	18.16	---	56.00	37.84	1000.0	9.000	L1	ON	19.5
4.48	---	16.40	46.00	29.60	1000.0	9.000	L1	ON	19.5
9.19	---	18.04	50.00	31.96	1000.0	9.000	L1	ON	19.5
9.91	20.64	---	60.00	39.36	1000.0	9.000	L1	ON	19.6
12.68	---	16.88	50.00	33.12	1000.0	9.000	L1	ON	19.6
13.30	18.50	---	60.00	41.50	1000.0	9.000	L1	ON	19.6

Remark: Correct factor=cable loss + LISN factor

L line

Conducted Emission from 150 KHz to 30 MHz

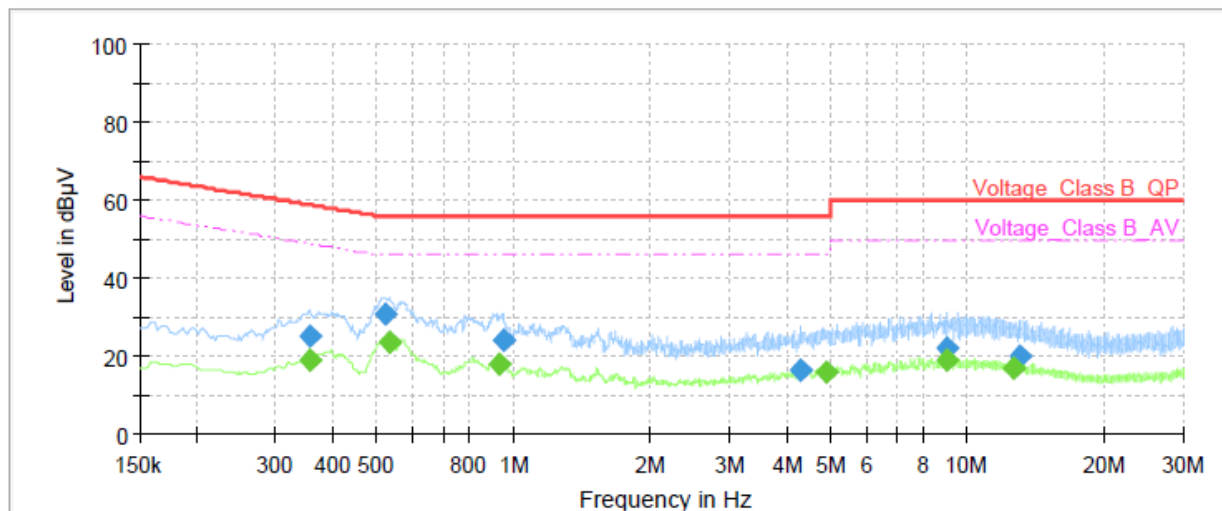

Frequency (MHz)	QuasiPeak (dBµV)	Average (dBµV)	Limit (dBµV)	Margin (dB)	Meas. Time (ms)	Bandwidth (kHz)	Line	Filter	Corr. (dB)
0.35	24.89	---	58.85	33.96	1000.0	9.000	N	ON	21.0
0.36	---	18.82	48.80	29.98	1000.0	9.000	N	ON	21.0
0.52	30.85	---	56.00	25.15	1000.0	9.000	N	ON	20.8
0.53	---	23.46	46.00	22.54	1000.0	9.000	N	ON	20.8
0.93	---	18.18	46.00	27.82	1000.0	9.000	N	ON	20.3
0.95	23.96	---	56.00	32.04	1000.0	9.000	N	ON	20.3
4.31	16.66	---	56.00	39.34	1000.0	9.000	N	ON	19.5
4.88	---	15.84	46.00	30.16	1000.0	9.000	N	ON	19.5
9.03	22.24	---	60.00	37.76	1000.0	9.000	N	ON	19.6
9.06	---	18.76	50.00	31.24	1000.0	9.000	N	ON	19.6
12.62	---	17.03	50.00	32.97	1000.0	9.000	N	ON	19.6
13.01	20.15	---	60.00	39.85	1000.0	9.000	N	ON	19.6

Remark: Correct factor=cable loss + LISN factor

N line

Conducted Emission from 150 KHz to 30 MHz

4 Uncertainty Measurement

Case	Uncertainty	Factor k
Radiated Emission 30MHz – 200MHz	4.17 dB	1.96
Radiated Emission 200MHz – 1GHz	4.84 dB	1.96
Radiated Emission 1GHz – 18GHz	4.35 dB	1.96
Conducted Emission	2.57 dB	2

5 Main Test Instruments

Name of Equipment	Manufacturer	Type/Model	Serial Number	Calibration Date	Expiration Time
Radiated Emission					
EMI Test Receiver	R&S	ESCI3	100948	2023-05-12	2024-05-11
Signal Analyzer	R&S	FSV40	101298	2023-05-12	2024-05-11
TRILOG Broadband Antenna	SCHWARZBECK	VULB 9163	1023	2023-07-14	2026-07-13
Horn Antenna	R&S	HF907	102723	2021-07-24	2024-07-23
Amplifier	R&S	SCU18	10034	2023-05-12	2024-05-11
Software	R&S	EMC32	9.26.01	/	/
Conducted Emission					
Artificial main network	R&S	ENV216	102191	2022-12-10	2024-12-09
EMI Test Receiver	R&S	ESR	101667	2023-05-12	2024-05-11
Software	R&S	EMC32	10.35.10	/	/

ANNEX A: The EUT Appearance

The EUT Appearance are submitted separately.

ANNEX B: Test Setup Photos

The Test Setup Photos are submitted separately.

***** END OF REPORT *****