



# Part 15B

# TEST REPORT

<b>Product Name</b>	GPS Tracker
<b>Model Name</b>	FJ110C
<b>Brand Name</b>	FJ110C
<b>FCC ID</b>	2AHRH-FJ110C
<b>Applicant</b>	Positioning Universal Inc
<b>Manufacturer</b>	Fujiao Communications
<b>Date of issue</b>	April 7, 2016

**TA Technology (Shanghai) Co., Ltd.**

**TA Technology (Shanghai) Co., Ltd.**  
**Test Report**

Report No.: RXA1603-0044EMC01

Page 2 of 21

**GENERAL SUMMARY**

<b>Reference Standard(s)</b>	<b>FCC Code CFR47 Part15B (2015)</b> Radio frequency device. <b>ANSI C63.4 (2014)</b> Methods of Measurement of Radio-Noise Emission from Low-Voltage Electrical and Electronic Equipment in the Range of 9 KHz to 40GHz.
<b>Conclusion</b>	This fixed equipment has been measured in all cases requested by the relevant standards. Test results in Chapter 2 of this test report are below limits specified in the relevant standards.  General Judgment : <b>Pass</b>
<b>Comment</b>	The test result only responds to the measured sample.

Approved by Guangchang Fan

Guangchang Fan  
Director

Revised by Wei Liu

Wei Liu  
EMC Manager

Performed by Xianqing Li

Xianqing Li  
EMC Engineer

**TA Technology (Shanghai) Co., Ltd.**  
**Test Report**

Report No.: RXA1603-0044EMC01

Page 3 of 21

---

**TABLE OF CONTENT**

1. General Information .....	4
1.1. Notes of the test report.....	4
1.2. Testing laboratory.....	5
1.3. Applicant Information.....	5
1.4. Manufacturer Information .....	5
1.5. Information of EUT .....	6
1.6. Test Date .....	6
2. Test Information .....	7
2.1. Summary of test results.....	7
2.2. Radiated Emission.....	8
2.3. Conducted Emission .....	14
3. Main Test Instruments.....	18
ANNEX A: The EUT Appearance and Test Setup.....	19
A.1 EUT Appearance.....	19
A.2 Test Setup.....	20

# TA Technology (Shanghai) Co., Ltd. Test Report

Report No.: RXA1603-0044EMC01

Page 4 of 21

---

## 1. General Information

### 1.1. Notes of the test report

**TA Technology (Shanghai) Co., Ltd.** has obtained the accreditation of China National Accreditation Service for Conformity Assessment (CNAS), and accreditation number: L2264.

**TA Technology (Shanghai) Co., Ltd.** has been listed on the US Federal Communications Commission list of test facilities recognized to perform electromagnetic emissions measurements. The site recognition number is 428261.

**TA Technology (Shanghai) Co., Ltd.** has been listed by industry Canada to perform electromagnetic emission measurement. The site recognition number is 8510A.

**TA Technology (Shanghai) Co., Ltd.** guarantees the reliability of the data presented in this test report, which is the results of measurements and tests performed for the items under test on the date and under the conditions stated in this test report and is based on the knowledge and technical facilities available at TA Technology (Shanghai) Co., Ltd. at the time of execution of the test.

**TA Technology (Shanghai) Co., Ltd.** is liable to the client for the maintenance by its personnel of the confidentiality of all information related to the items under test and the results of the test. The sample under test was selected by the Client. This report only refers to the item that has undergone the test.

This report alone does not constitute or imply by its own an approval of the product by the certification Bodies or competent Authorities. This report can not be used partially or in full for publicity and/or promotional purposes without previous written approval of **TA Technology (Shanghai) Co., Ltd.** and the Accreditation Bodies, if it applies.

If the electronic report is inconsistent with the printed one, it should be subject to the latter.

# TA Technology (Shanghai) Co., Ltd. Test Report

Report No.: RXA1603-0044EMC01

Page 5 of 21

---

## 1.2. Testing laboratory

Company: TA Technology (Shanghai) Co., Ltd.  
Address: No.145, Jintang Rd, Tangzhen Industry Park, Pudong  
City: Shanghai  
Post code: 201201  
Country: P. R. China  
Contact: Xu Kai  
Telephone: +86-021-50791141/2/3  
Fax: +86-021-50791141/2/3-8000  
Website: <http://www.ta-shanghai.com>  
E-mail: [xukai@ta-shanghai.com](mailto:xukai@ta-shanghai.com)

## 1.3. Applicant Information

Company: Positioning Universal Inc  
Address: 4660 La Jolla Village Drive Suite 1100 San Diego CA US

## 1.4. Manufacturer Information

Company: Fujiao Communications  
Address: Shanghai city xuhui district zhongshanwest road 2368, 1802 room.  
PR.CHINA

# TA Technology (Shanghai) Co., Ltd.

## Test Report

Report No.: RXA1603-0044EMC01

Page 6 of 21

### 1.5. Information of EUT

#### General information

Product MEID:	A100003230B9D6
Hardware Version:	HW_V02
Software Version:	SW_V04
Antenna Type:	Internal Antenna
Ancillary equipment:	Lenovo X61
	USB cable

#### Ancillary equipment information

Equipment	Lenovo X61	USB cable
SN:	L3-D1224	/
Manufacturer:	Lenovo	/

Note: During the test the EUT is in USB mode.

### 1.6. Test Date

The test is performed from March 21, 2016 to March 29, 2016.

**TA Technology (Shanghai) Co., Ltd.**  
**Test Report**

Report No.: RXA1603-0044EMC01

Page 7 of 21

---

## **2. Test Information**

### **2.1. Summary of test results**

<b>Number</b>	<b>Test Case</b>	<b>Clause in FCC Rules</b>	<b>conclusion</b>
1	Radiated Emission	15.109, ANSI C63.4-2014	PASS
2	Conducted Emission	15.107, ANSI C63.4-2014	PASS

# TA Technology (Shanghai) Co., Ltd.

## Test Report

Report No.: RXA1603-0044EMC01

Page 8 of 21

### 2.2. Radiated Emission

#### Ambient condition

Temperature	Relative humidity	Pressure
24°C~26°C	45%~50%	102.5kPa

#### Methods of Measurement

The EUT is placed on a non-metallic table 0.8m above the horizontal metal reference ground plane. The distance between EUT and receive antenna should be 3 meters. During the test, the EUT was operating in its typical mode. The test method is according to ANSI C63.4-2014. Sweep the whole frequency band through the range from 30MHz to the 5th harmonic of the carrier. During the test, the height of receive antenna shall be moved from 1 to 4 meters, and the antenna shall be performed under horizontal and vertical polarization. The turn table shall be rotated from 0 to 360 degrees for detecting the maximum of radiated signal level.

During the test, EUT is connected to a laptop via a USB cable in the case of USB mode. The EUT is used as the peripheral equipment of the PC. The model of laptop is Lenovo X61 and the serial number of laptop is L3-D1224.

The data is transferred from EUT to PC; PC is connected to server via a long LAN cable.

The data of cable loss and antenna factor has been calibrated in full testing frequency range before the testing.

Set the spectrum analyzer in the following:

Below 1GHz:

RBW=100kHz / VBW=300kHz / Sweep=AUTO

Above 1GHz:

(a) PEAK: RBW=1MHz VBW=3MHz/ Sweep=AUTO

(b) AVERAGE: RBW=1MHz / VBW=3MHz / Sweep=AUTO



# TA Technology (Shanghai) Co., Ltd. Test Report

Report No.: RXA1603-0044EMC01

Page 9 of 21

## Test Setup

### Below 1GHz

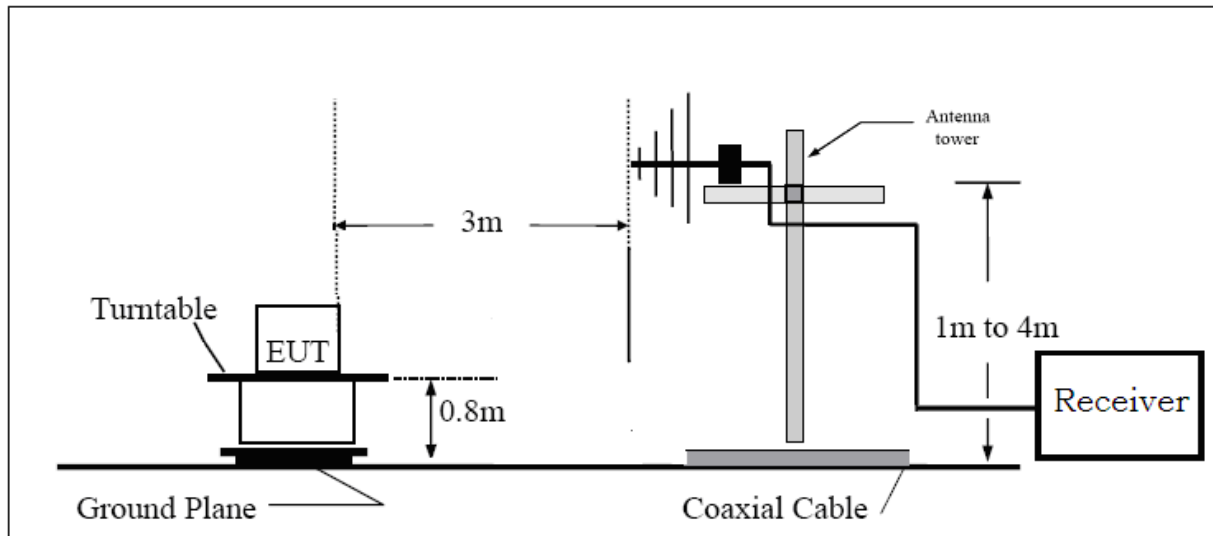

### Above 1GHz

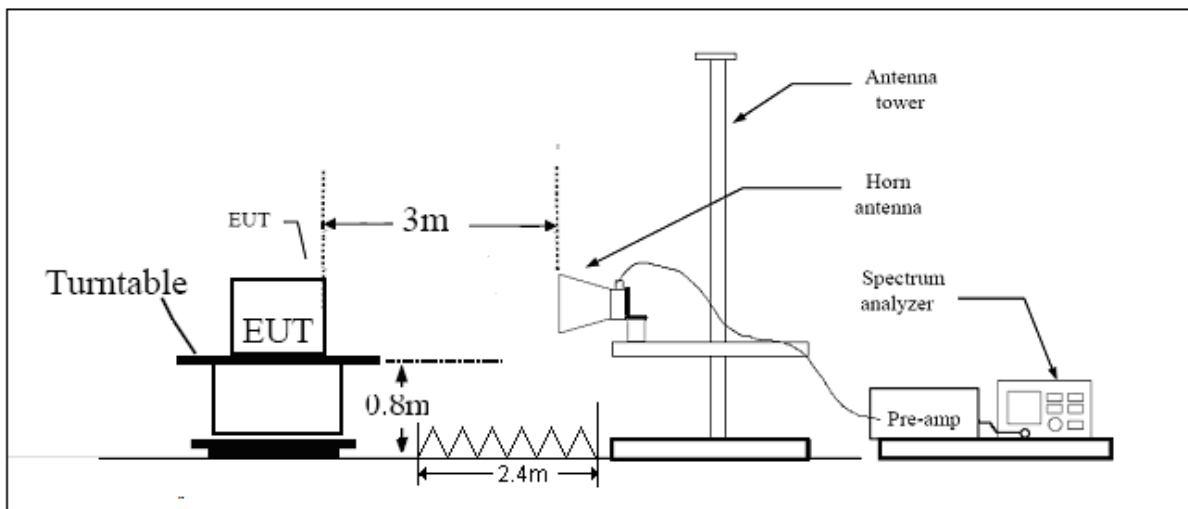

Note: Area side:2.4mX3.6m

# TA Technology (Shanghai) Co., Ltd.

## Test Report

Report No.: RXA1603-0044EMC01

Page 10 of 21

### Limits

Frequency (MHz)	Field Strength (dB $\mu$ V/m)	Detector
30 -88	40.0	Quasi-peak
88-216	43.5	Quasi-peak
216 – 960	46.0	Quasi-peak
960-1000	54.0	Quasi-peak
1000-5 <sup>th</sup> harmonic of the highest frequency or 40GHz, which is lower	54 74	Average Peak

### Measurement Uncertainty

The assessed measurement uncertainty to ensure 95% confidence level for the normal distribution is with the coverage factor  $k = 1.96$ .  $U = 3.92$  dB.

# TA Technology (Shanghai) Co., Ltd. Test Report

Report No.: RXA1603-0044EMC01

Page 11 of 21

## Test Results

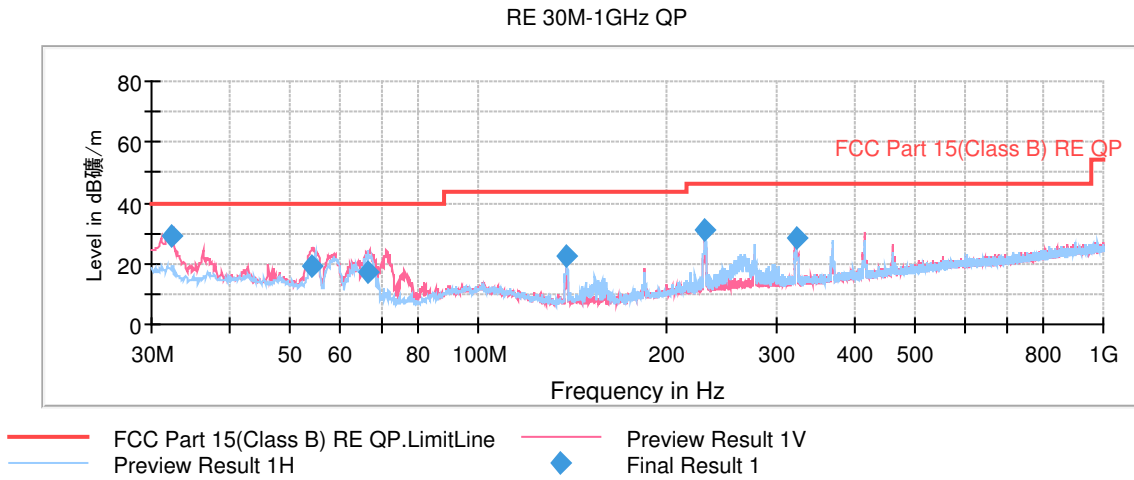

Radiated Emission from 30MHz to 1GHz

Frequency (MHz)	Quasi-Peak (dBuV/m)	Reading value (dBuV/m)	Height (cm)	Polarization	Azimuth (deg)	Correct Factor (dB)	Margin (dB)	Limit (dBuV/m)
32.383938	29.0	47.3	99.0	V	320.0	-18.3	11.0	40.0
54.194375	19.0	41.3	119.0	V	303.0	-22.3	21.0	40.0
66.784044	17.2	43.7	127.0	V	307.0	-26.5	22.8	40.0
138.331506	22.6	51.9	174.0	H	250.0	-29.3	20.9	43.5
230.612250	30.8	56.2	126.0	H	44.0	-25.4	15.2	46.0
322.889750	28.7	51.5	176.0	V	269.0	-22.8	17.3	46.0

- Remark:**
1. Quasi-Peak = Reading value + Correction factor
  2. Correction Factor = Antenna factor+ Insertion loss(cable loss+amplifier gain)
  3. Margin = Limit – Quasi-Peak

# TA Technology (Shanghai) Co., Ltd. Test Report

Report No.: RXA1603-0044EMC01

Page 12 of 21

RE 1G-3GHz PK+AV

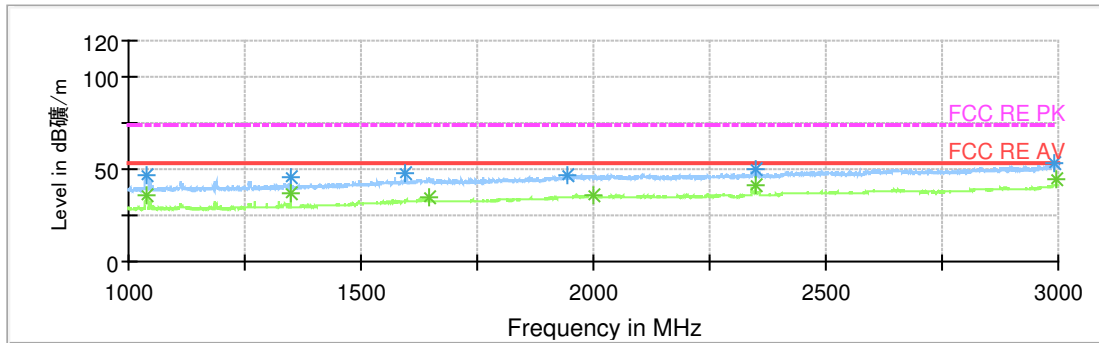

- FCC RE AV.LimitLine  
— Preview Result 1  
\* Data Reduction Result 1 [2]
- - - FCC RE PK.LimitLine  
— Preview Result 2  
\* Data Reduction Result 2 [2]

### Radiated Emission from 1GHz to 3GHz

Frequency (MHz)	Peak (dBuV/m)	Reading value (dBuV/m)	Height (cm)	Polarization	Azimuth (deg)	Correct Factor (dB)	Margin (dB)	Limit (dBuV/m)
1038.250000	45.9	55.8	201.0	V	249.0	-9.9	28.1	74
1347.500000	44.1	53.0	101.0	V	348.0	-8.9	29.9	74
1646.500000	45.3	50.7	101.0	V	185.0	-5.4	28.7	74
1999.000000	44.9	47.9	201.0	V	207.0	-3.0	29.1	74
2350.000000	49.4	51.6	101.0	V	192.0	-2.2	24.6	74
2994.750000	51.2	52.6	101.0	V	245.0	1.4	22.8	74

Frequency (MHz)	Average (dBuV/m)	Reading value (dBuV/m)	Height (cm)	Polarization	Azimuth (deg)	Correct Factor (dB)	Margin (dB)	Limit (dBuV/m)
1038.250000	36.4	46.3	201.0	V	249.0	-9.9	17.6	54
1347.500000	37.3	46.2	101.0	V	348.0	-8.9	16.7	54
1646.500000	35.3	40.7	101.0	V	185.0	-5.4	18.7	54
1999.000000	36.0	39.0	201.0	V	207.0	-3.0	18.0	54
2350.000000	41.6	43.8	101.0	V	192.0	-2.2	12.4	54
2994.750000	44.7	46.1	101.0	V	245.0	1.4	9.3	54

# TA Technology (Shanghai) Co., Ltd. Test Report

Report No.: RXA1603-0044EMC01

Page 13 of 21

RE 3-18GHz PK+AV

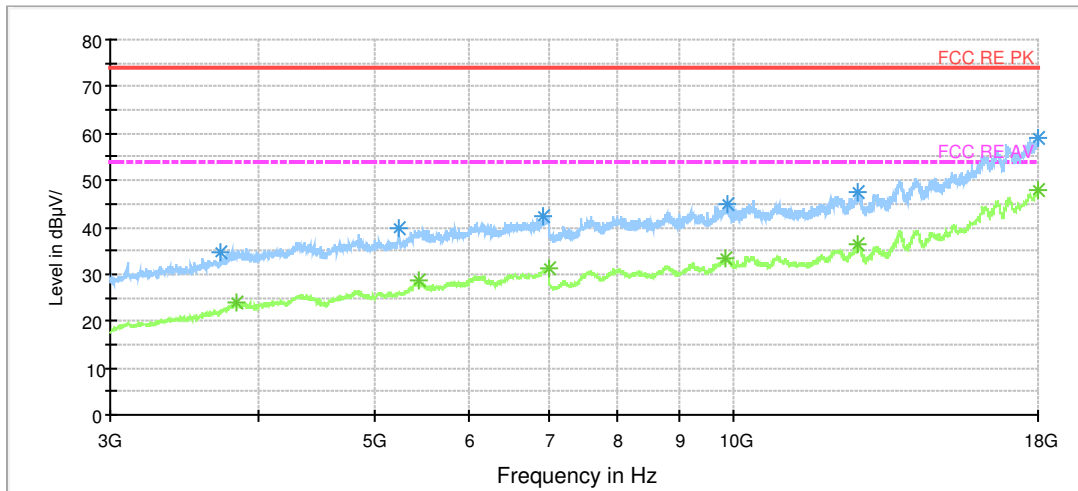

— FCC RE PK.LimitLine     
 - - - FCC RE AV.LimitLine     
 — Preview Result 1  
— Preview Result 2     
 \* Data Reduction Result 1 [1]     
 \* Data Reduction Result 2 [1]

Radiated Emission from 3GHz to 18GHz

Frequency (MHz)	Peak (dBuV/m)	Reading value (dBuV/m)	Height (cm)	Polarization	Azimuth (deg)	Correct Factor (dB)	Margin (dB)	Limit (dBuV/m)
3823.125000	33.0	33.1	99.0	H	173.0	-0.1	41.0	74
5450.625000	37.7	40.5	199.0	H	208.0	2.8	36.3	74
6991.875000	41.0	46.0	99.0	H	236.0	5.0	33.0	74
9849.375000	43.6	53.4	99.0	H	0.0	9.8	30.4	74
12723.750000	45.7	58.3	401.0	H	245.0	12.6	28.3	74
17988.750000	57.5	81.0	299.0	H	23.0	23.5	16.5	74

Frequency (MHz)	Average (dBuV/m)	Reading value (dBuV/m)	Height (cm)	Polarization	Azimuth (deg)	Correct Factor (dB)	Margin (dB)	Limit (dBuV/m)
3823.125000	23.9	24.0	99.0	H	173.0	-0.1	30.1	54
5450.625000	28.6	31.4	199.0	H	208.0	2.8	25.4	54
6991.875000	31.4	36.4	99.0	H	236.0	5.0	22.6	54
9849.375000	33.4	43.2	99.0	H	0.0	9.8	20.6	54
12723.750000	36.2	48.8	401.0	H	245.0	12.6	17.8	54
17988.750000	47.7	71.2	299.0	H	23.0	23.5	6.3	54

# TA Technology (Shanghai) Co., Ltd.

## Test Report

Report No.: RXA1603-0044EMC01

Page 14 of 21

### 2.3. Conducted Emission

#### Ambient condition

Temperature	Relative humidity	Pressure
24°C ~26°C	50%~55%	102.5kPa

#### Methods of Measurement

The EUT is placed on a non-metallic table of 80cm height above the horizontal metal reference ground plane. During the test, the EUT was operating in its typical mode. The test method is according to ANSI C63.4-2014. Connect the AC power line of the EUT to the L.I.S.N. Use EMI receiver to detect the average and Quasi-peak value. RBW is set to 9 kHz, VBW is set to 30kHz. The measurement result should include both L line and N line.

During the test, EUT is connected to a laptop via a USB cable in the case of USB mode. The EUT is used as the peripheral equipment of the PC. The model of laptop is Lenovo X61 and the serial number of laptop is L3-D1224.

The data is transferred from EUT to PC; PC is connected to server via a long LAN cable.

#### Test Setup

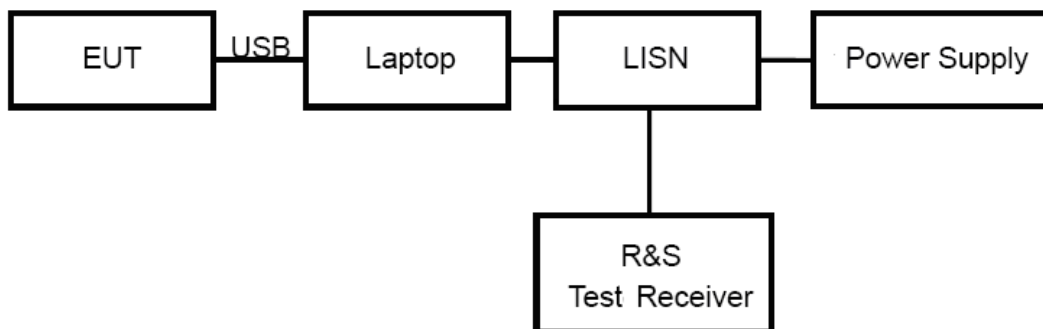

Note: Power Supply is AC Power source and it is used to change the voltage to 120V/60Hz. The EUT power is supplied by PC via the usb cable.

#### Limits

Frequency (MHz)	Conducted Limits(dB $\mu$ V)	
	Quasi-peak	Average
0.15 - 0.5	66 to 56 *	56 to 46 *
0.5 - 5	56	46
5 - 30	60	50

\*: Decreases with the logarithm of the frequency.

# TA Technology (Shanghai) Co., Ltd.

## Test Report

Report No.: RXA1603-0044EMC01

Page 15 of 21

---

### **Measurement Uncertainty**

The assessed measurement uncertainty to ensure 95% confidence level for the normal distribution is with the coverage factor  $k = 1.96$ .  $U = 2.69$  dB.

# TA Technology (Shanghai) Co., Ltd. Test Report

Report No.: RXA1603-0044EMC01

Page 16 of 21

## Test Results

USB Mode

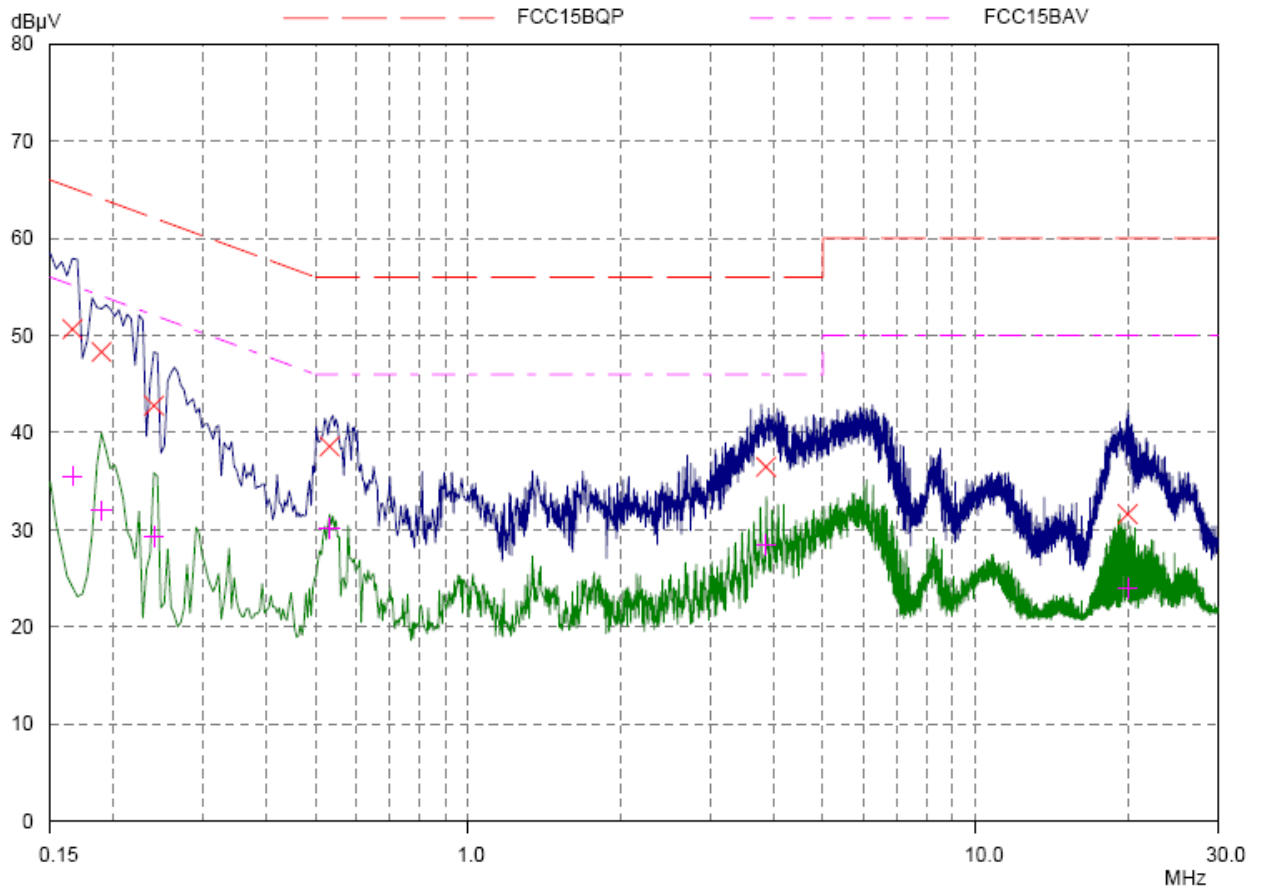

### Final Measurement Results

Frequency MHz	QP Level dBµV	QP Limit dBµV	QP Delta dB	Phase -	PE -
0.16562	50.66	65.18	14.52	L1	gnd
0.18906	48.30	64.08	15.78	L1	gnd
0.23984	42.78	62.10	19.32	L1	gnd
0.53281	38.59	56.00	17.41	L1	gnd
3.86093	36.48	56.00	19.52	L1	gnd
19.94296	31.62	60.00	28.38	L1	gnd

Frequency MHz	AV Level dBµV	AV Limit dBµV	AV Delta dB	Phase -	PE -
0.16562	35.50	55.18	19.68	L1	gnd
0.18906	31.98	54.08	22.10	L1	gnd
0.23984	29.28	52.10	22.82	L1	gnd
0.53281	30.19	46.00	15.81	L1	gnd
3.86093	28.43	46.00	17.57	L1	gnd
19.94296	24.01	50.00	25.99	L1	gnd

Conducted Emission ES710\_L\_USB\_0.15-30MHz



# TA Technology (Shanghai) Co., Ltd. Test Report

Report No.: RXA1603-0044EMC01

Page 17 of 21

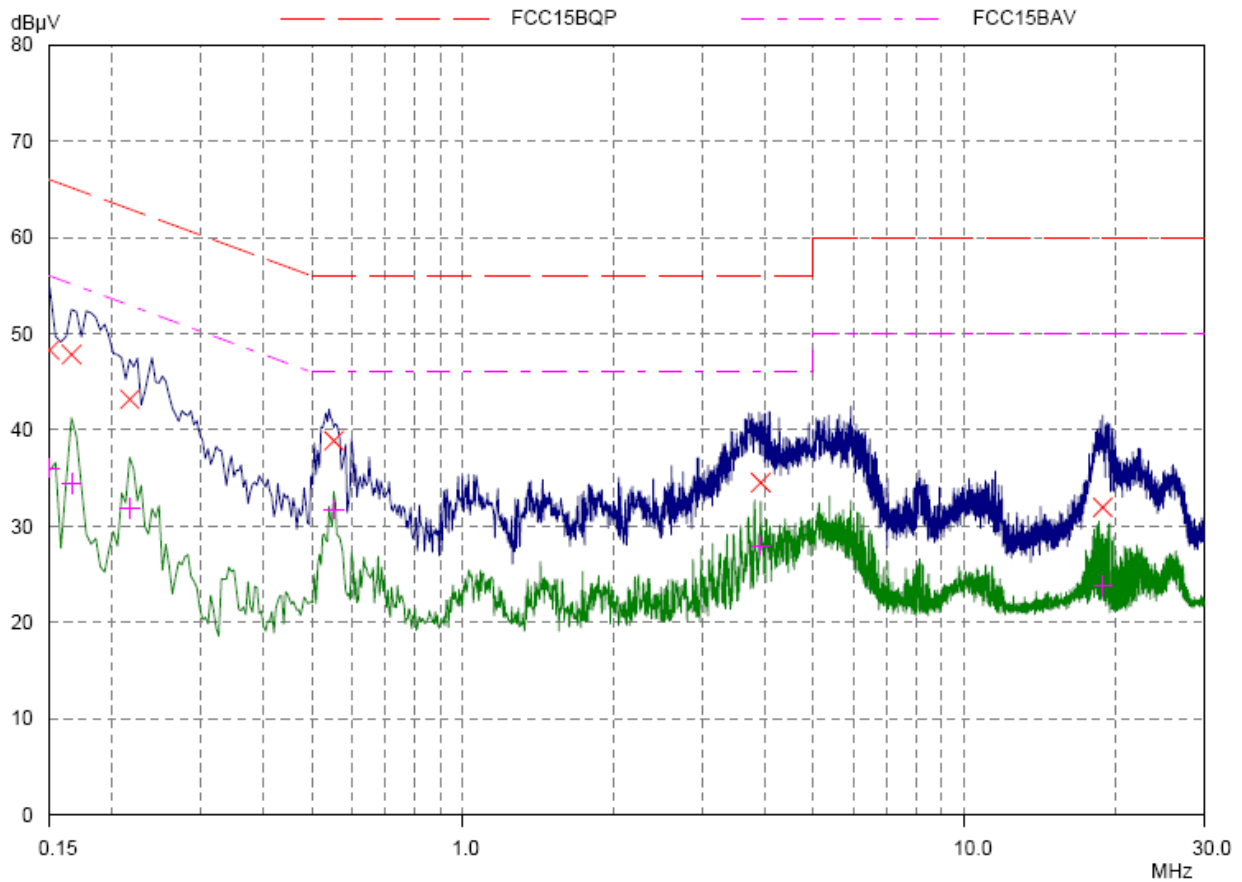

### Final Measurement Results

Frequency MHz	QP Level dBµV	QP Limit dBµV	QP Delta dB	Phase -	PE -
0.15	48.30	66.00	17.70	N	gnd
0.16562	47.84	65.18	17.34	N	gnd
0.2164	43.17	62.96	19.79	N	gnd
0.55234	38.87	56.00	17.13	N	gnd
3.92343	34.53	56.00	21.47	N	gnd
18.86093	31.96	60.00	28.04	N	gnd

Frequency MHz	AV Level dBµV	AV Limit dBµV	AV Delta dB	Phase -	PE -
0.15	36.05	56.00	19.95	N	gnd
0.16562	34.44	55.18	20.74	N	gnd
0.2164	31.85	52.96	21.11	N	gnd
0.55234	31.75	46.00	14.25	N	gnd
3.92343	28.00	46.00	18.00	N	gnd
18.86093	23.80	50.00	26.20	N	gnd

Conducted Emission ES710\_N\_USB\_0.15-30MHz

**TA Technology (Shanghai) Co., Ltd.**  
**Test Report**

Report No.: RXA1603-0044EMC01

Page 18 of 21

### 3. Main Test Instruments

Name	Type	Manufacturer	Serial Number	Calibration Date	Expiration Time	Valid Period
EMI Test Receiver	ESCI	R&S	100948	2015-05-22	2016-5-21	1 year
Trilog Antenna	VUBL 9163	SCHWARZBECK	9163-201	2014-12-06	2017-12-05	3 years
Signal Analyzer	FSV30	R&S	100815	2015-12-17	2016-12-16	1 year
Horn Antenna	HF907	R&S	100126	2014-12-06	2017-12-05	3 years
Horn Antenna	3160-09	ETS-Lindgren	00102643	2015-1-30	2018-01-29	3 years
EMI Test Receiver	ESCS30	R&S	100138	2015-12-17	2016-12-16	1 year
LISN	ENV216	R&S	101171	2013-12-18	2016-12-17	3 years
RF cable	SF104-11N-11 N-1200mm	HUBER+SUHNER	CE-01	2015-11-19	2016-11-18	1 year
RF cable	SF106A-11N-1 1N-8000mm	HUBER+SUHNER	RE-01	2015-12-14	2016-12-13	1 year

\*\*\*\*\*END OF REPORT \*\*\*\*\*

## ANNEX A: The EUT Appearance and Test Setup

### A.1 EUT Appearance



a: EUT

Picture 1 EUT

**TA Technology (Shanghai) Co., Ltd.**  
**Test Report**

Report No.: RXA1603-0044EMC01

Page 20 of 21

**A.2 Test Setup**



a: Below 1GHz



b: Above 1GHz

**Picture 2 Radiated Emission Test Setup**

**TA Technology (Shanghai) Co., Ltd.**  
**Test Report**



**Picture 3 Conducted Emission Test Setup**