

### FCC Report (LTE)

**Applicant:** Positioning Universal Inc  
**Address of Applicant:** 4660 La Jolla Village Drive Suite 1100, San Diego, CA 92122, United States  
**Manufacturer:** Fujiao Communications  
**Address of Manufacturer:** 1802 room, zhongshanwest road 2368, xuhui district , Shanghai,China  
**Equipment Under Test (EUT)**  
Product Name: GPS Tracker  
Model No.: FJ1000LT  
**FCC ID:** 2AHRH-FJ1000LT  
**Applicable standards:** FCC CFR Title 47 Part 2: 2016  
FCC CFR Title 47 Part 24: 2016  
FCC CFR Title 47 Part 27: 2016  
**Date of sample receipt:** May 17, 2017  
**Date of Test:** May 18-31, 2017  
**Date of report issued:** June 01, 2017  
**Test Result :** PASS \*

\* In the configuration tested, the EUT complied with the standards specified above.

Authorized Signature:



**Robinson Lo**  
**Laboratory Manager**

This results shown in this test report refer only to the sample(s) tested, this test report cannot be reproduced, except in full, without prior written permission of the company. The report would be invalid without specific stamp of test institute and the signatures of compiler and approver.

## 1 Version

Version No.	Date	Description
00	June 01, 2017	Original

Prepared By:

*Tiger Chen*

Date:

June 01, 2017

Project Engineer

Check By:

*Andy Wu*

Date:

June 01, 2017

Reviewer

## 2 Contents

Page

<b>COVER PAGE</b> .....	<b>1</b>
<b>1 VERSION</b> .....	<b>2</b>
<b>2 CONTENTS</b> .....	<b>3</b>
<b>3 TEST SUMMARY</b> .....	<b>4</b>
<b>4 GENERAL INFORMATION</b> .....	<b>5</b>
4.1 GENERAL DESCRIPTION OF EUT .....	5
4.2 RELATED SUBMITTAL(S) / GRANT (S) .....	6
4.3 TEST METHODOLOGY.....	6
4.4 TEST FACILITY .....	6
4.5 TEST LOCATION.....	6
<b>5 TEST INSTRUMENTS LIST</b> .....	<b>7</b>
<b>6 SYSTEM TEST CONFIGURATION</b> .....	<b>8</b>
6.1 TEST MODE .....	8
6.2 CONFIGURATION OF TESTED SYSTEM .....	9
6.3 CONDUCTED PEAK OUTPUT POWER .....	10
6.4 OCCUPY BANDWIDTH.....	15
6.5 MODULATION CHARACTERISTIC.....	31
6.6 OUT OF BAND EMISSION AT ANTENNA TERMINALS.....	31
6.7 ERP, EIRP MEASUREMENT .....	55
6.8 FIELD STRENGTH OF SPURIOUS RADIATION MEASUREMENT.....	70
6.9 FREQUENCY STABILITY V.S. TEMPERATURE MEASUREMENT.....	85
6.10 FREQUENCY STABILITY V.S. VOLTAGE MEASUREMENT .....	88
<b>7 TEST SETUP PHOTO</b> .....	<b>91</b>
<b>8 EUT CONSTRUCTIONAL DETAILS</b> .....	<b>92</b>

### 3 Test Summary

Test Item	Section in CFR 47	Result
RF Exposure (SAR)	Part 1.1307 Part 2.1093	Pass*
RF Output Power	Part 2.1046 Part 24.232 (c) Part 27.50(c)(10)/(d)(4)	Pass
Modulation Characteristics	Part 2.1047	N/A
99% & -26 dB Occupied Bandwidth	Part 2.1049 Part 24.238 Part 27.53(h)/(g)	Pass
Spurious Emissions at Antenna Terminal	Part 2.1051 Part 24.238 (a) Part 27.53(h)/(g)	Pass
Field Strength of Spurious Radiation	Part 2.1053 Part 24.238 (a) Part 27.53(h)/(g)	Pass
Out of band emission, Band Edge	Part 24.238 (a) Part 27.53(h)/(g)	Pass
Frequency stability vs. temperature	Part 2.1055(a)(1)(b)	Pass
Frequency stability vs. voltage	Part 2.1055(d)(1)(2)	Pass

*Pass: The EUT complies with the essential requirements in the standard.*

*N/A: Not applicable.*

## 4 General Information

### 4.1 General Description of EUT

Product Name:	GPS Tracker
Model No.:	FJ1000LT
Hardware Version:	P1.0
Software Version:	LR4.3.4.1-29555
Support Networks:	LTE
Support Bands:	LTE Band 2, LTE Band 4, LTE Band 12
Channel Bandwidth:	LTE Band 2: 5MHz; 10MHz; 15MHz; 20MHz LTE Band 4: 5MHz; 10MHz; 15MHz; 20MHz LTE Band 12: 5MHz; 10MHz
TX Frequency:	LTE Band 2: 1850.70MHz-1909.30MHz LTE Band 4: 1710.70MHz-1754.30MHz LTE Band 12: 698.70MHz-715.30MHz
Modulation type:	LTE Band 2/4/12: QPSK, 16QAM
Antenna type:	Integral antenna
Antenna gain:	1.51dBi(Band 2), 1.42dBi(Band 4), 1.23dBi(Band 12)
Power supply:	DC 12V

## 4.2 Related Submittal(s) / Grant (s)

This submittal(s) (test report) is filing to comply with Section Part 27 of the FCC CFR 47 Rules.

## 4.3 Test Methodology

Both conducted and radiated testing were performed according to the procedures document on TIA/EIA 603 and FCC CFR 47.1046, 2.1047, 2.1049, 2.1051, 2.1053, 2.1055 and 2.1057

## 4.4 Test Facility

The test facility is recognized, certified, or accredited by the following organizations:

- **FCC —Registration No.: 600491**

Global United Technology Services Co., Ltd., Shenzhen EMC Laboratory has been registered and fully described in a report filed with the (FCC) Federal Communications Commission. The acceptance letter from the FCC is maintained in files. Registration 600491, June 22, 2016.

- **Industry Canada (IC) —Registration No.: 9079A-2**

The 3m Semi-anechoic chamber of Global United Technology Services Co., Ltd. has been registered by Certification and Engineering Bureau of Industry Canada for radio equipment testing with Registration No.: 9079A-2, August 15, 2016.

## 4.5 Test Location

All tests were performed at:

Global United Technology Services Co., Ltd.

Address: No. 301-309, 3/F., Jinyuan Business Building, No.2, Laodong Industrial Zone, Xixiang Road, Baoan District, Shenzhen, Guangdong, China 518102

Tel: 0755-27798480

Fax: 0755-27798960

## 5 Test Instruments list

Radiated Emission:						
Item	Test Equipment	Manufacturer	Model No.	Inventory No.	Cal.Date (mm-dd-yy)	Cal.Due date (mm-dd-yy)
1	3m Semi- Anechoic Chamber	ZhongYu Electron	9.0(L)*6.0(W)* 6.0(H)	GTS250	July. 03 2015	July. 02 2020
2	Control Room	ZhongYu Electron	6.2(L)*2.5(W)* 2.4(H)	GTS251	N/A	N/A
3	Spectrum Analyzer	Agilent	E4440A	GTS533	Jun. 29 2016	Jun. 28 2017
4	EMI Test Receiver	Rohde & Schwarz	ESU26	GTS203	Jun. 29 2016	Jun. 28 2017
5	BiConiLog Antenna	SCHWARZBECK MESS-ELEKTRONIK	VULB9163	GTS214	Jun. 29 2016	Jun. 28 2017
6	Double -ridged waveguide horn	SCHWARZBECK MESS-ELEKTRONIK	9120D-829	GTS208	Jun. 25 2016	Jun. 24 2017
7	Horn Antenna	ETS-LINDGREN	3160	GTS217	Mar. 25 2017	Mar. 24 2018
8	EMI Test Software	AUDIX	E3	N/A	N/A	N/A
9	Coaxial Cable	GTS	N/A	GTS213	Mar. 25 2017	Mar. 24 2018
10	Coaxial Cable	GTS	N/A	GTS211	Mar. 25 2017	Mar. 24 2018
11	Coaxial cable	GTS	N/A	GTS210	Mar. 25 2017	Mar. 24 2018
12	Coaxial Cable	GTS	N/A	GTS212	Mar. 25 2017	Mar. 24 2018
13	Amplifier(100kHz-3GHz)	HP	8347A	GTS204	Jun. 29 2016	Jun. 28 2017
14	Amplifier(2GHz-20GHz)	HP	8349B	GTS206	Jun. 29 2016	Jun. 28 2017
15	Amplifier (18-26GHz)	Rohde & Schwarz	AFS33-18002 650-30-8P-44	GTS218	Jun. 25 2016	Jun. 24 2017
16	Band filter	Amindeon	82346	GTS219	Mar. 25 2017	Mar. 24 2018
17	Universal Radio Communication tester	ROHDE&SCHWARZ	CMU 200	GTS538	June. 29 2016	June. 28 2017
18	Wideband Radio Communication Tester	ROHDE&SCHWARZ	CMW 500	GTS539	June. 29 2016	June. 28 2017

General used equipment:						
Item	Test Equipment	Manufacturer	Model No.	Inventory No.	Cal.Date (mm-dd-yy)	Cal.Due date (mm-dd-yy)
1	Barometer	ChangChun	DYM3	GTS257	July 06 2016	July 05 2017

## 6 System test configuration

### 6.1 Test mode

During all testing, EUT is in link mode with base station emulator at maximum power level. The spurious emission measurements were carried out in semi-anechoic chamber with 3-meter test range, and EUT is rotated on three test planes to find out the worst emission.

Test modes		
Band	Radiated	Conducted
LTE Band 2	■ QPSK and 16QAM link	■ QPSK and 16QAM link
LTE Band 4	■ QPSK and 16QAM link	■ QPSK and 16QAM link
LTE Band 12	■ QPSK and 16QAM link	■ QPSK and 16QAM link



## 6.2 Configuration of Tested System

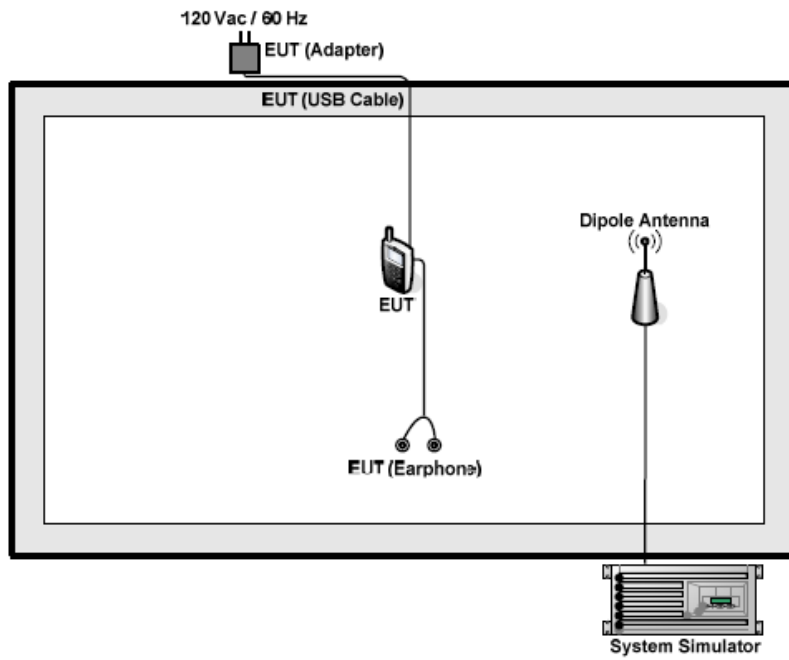

## 6.3 Conducted Peak Output Power

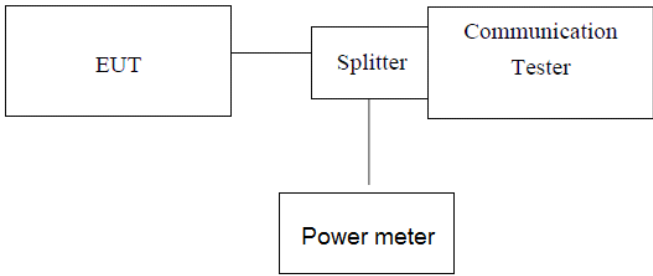
Test Requirement:	Part 24.232 (c); Part 27.50(c)(10)/(d)(4)
Test Method:	FCC part2.1046
Limit:	LTE Band 2: 2W LTE Band 4: 1W LTE Band 12: 3W
Test setup:	 <pre> graph LR     EUT[EUT] --- Splitter[Splitter]     Splitter --- CT[Communication Tester]     Splitter --- PM[Power meter]     </pre> <p><i>Note: Measurement setup for testing on Antenna connector</i></p>
Test Procedure:	<ol style="list-style-type: none"> <li>1. The transmitter output port was connected to base station.</li> <li>2. The RF output of EUT was connected to the power meter by RF cable and attenuator, the path loss was compensated to the results for each measurement.</li> <li>3. Set EUT at maximum power through base station.</li> <li>4. Select lowest, middle, and highest channels for each band and different modulation.</li> <li>5. Measure the maximum burst average power.</li> </ol>
Test Instruments:	Refer to section 6.0 for details
Test mode:	Refer to section 6.1 for details
Test results:	Pass

Measurement Data

Band 2						
Bandwidth	Mode	RB Size	RB Offset	Actual output power(dBm)		
				Channel 18625 1852.5MHz	Channel 18900 1880.0MHz	Channel 19175 1907.5MHz
5MHz	QPSK	1	0	21.53	21.51	21.30
		1	13	21.86	22.89	20.03
		1	24	21.91	21.33	20.86
		12	0	20.00	22.83	21.17
		12	6	20.08	21.19	20.33
		12	13	22.59	21.28	20.68
		25	0	20.82	20.35	22.91
	16QAM	1	0	21.79	21.52	21.32
		1	13	20.26	22.95	21.95
		1	24	20.55	22.97	22.96
		12	0	20.33	21.24	21.91
		12	6	22.58	22.68	22.88
		12	13	21.05	21.58	22.87
		25	0	21.67	21.74	20.37
Bandwidth	Mode	RB Size	RB Offset	Actual output power(dBm)		
				Channel 18650 1855.0MHz	Channel 18900 1880.0MHz	Channel 19150 1905.0MHz
10MHz	QPSK	1	0	20.93	21.98	22.32
		1	25	20.09	21.80	22.46
		1	49	21.29	22.45	21.33
		25	0	21.10	22.80	21.50
		25	13	22.24	21.49	21.76
		25	25	21.33	22.99	21.59
		50	0	22.73	20.13	20.40
Bandwidth	Mode	RB Size	RB Offset	Actual output power(dBm)		
				Channel 18675 1857.5MHz	Channel 18900 1880.0MHz	Channel 19125 1902.5MHz
15MHz	QPSK	1	0	21.16	21.60	20.24
		1	38	21.94	21.40	22.00
		1	74	22.50	22.98	21.42
		36	0	21.42	20.27	21.83
		36	18	22.31	20.32	21.38
		36	39	22.77	22.95	21.96
		75	0	20.71	22.36	20.43

Bandwidth	Mode	RB Size	RB Offset	Actual output power(dBm)		
				Channel 18700 1860.0MHz	Channel 18900 1880.0MHz	Channel 19100 1900.0MHz
20MHz	QPSK	1	0	22.83	20.60	21.90
		1	50	20.97	21.79	21.34
		1	99	22.00	22.66	21.46
		50	0	20.49	21.48	21.76
		50	25	20.15	22.04	20.25
		50	50	22.45	20.98	22.78
		100	0	20.74	22.66	20.79
<b>Band 4</b>						
Bandwidth	Mode	RB Size	RB Offset	Actual output power(dBm)		
				Channel 19975 1712.5MHz	Channel 20175 1732.5MHz	Channel 20375 1752.5MHz
5MHz	QPSK	1	0	20.13	22.43	20.90
		1	13	21.02	22.45	22.08
		1	24	20.72	22.22	20.24
		12	0	22.95	22.77	22.48
		12	6	20.82	20.29	22.68
		12	13	21.11	22.76	21.39
		25	0	20.68	20.16	22.83
	16QAM	1	0	22.44	21.21	20.10
		1	13	21.18	20.46	20.83
		1	24	21.38	22.92	20.43
		12	0	22.65	22.39	22.66
		12	6	21.01	20.69	20.76
		12	13	22.87	22.60	20.62
		25	0	21.60	20.91	21.86
Bandwidth	Mode	RB Size	RB Offset	Actual output power(dBm)		
				Channel 20000 1715.0MHz	Channel 20175 1732.5MHz	Channel 20350 1750.0MHz
10MHz	QPSK	1	0	22.31	22.07	21.84
		1	25	22.12	22.02	21.02
		1	49	20.37	20.61	20.19
		25	0	20.18	21.17	20.30
		25	13	21.61	22.86	20.29
		25	25	22.00	20.49	21.59
		50	0	20.72	22.00	22.84

Bandwidth	Mode	RB Size	RB Offset	Actual output power(dBm)		
				Channel 20025 1717.5MHz	Channel 20175 1732.5MHz	Channel 20325 1747.5MHz
15MHz	QPSK	1	0	22.35	22.14	22.88
		1	38	21.65	22.84	21.95
		1	74	20.85	21.82	21.90
		36	0	22.11	21.93	20.98
		36	18	21.61	20.72	20.20
		36	39	21.59	21.32	22.84
		75	0	21.33	21.49	22.51
Bandwidth	Mode	RB Size	RB Offset	Actual output power(dBm)		
				Channel 20050 1720.0MHz	Channel 20175 1732.5MHz	Channel 20300 1745.0MHz
20MHz	QPSK	1	0	22.89	20.94	22.10
		1	50	20.27	21.82	22.27
		1	99	22.90	21.34	20.38
		50	0	21.48	20.76	22.72
		50	25	22.80	21.47	22.25
		50	50	21.73	21.08	21.12
		100	0	20.43	22.42	21.22
Band 12						
Bandwidth	Mode	RB Size	RB Offset	Actual output power(dBm)		
				Channel 23025 700.5MHz	Channel 23095 707MHz	Channel 23155 713.5MHz
5MHz	QPSK	1	0	22.65	22.49	21.74
		1	13	20.80	20.92	20.30
		1	24	20.82	20.98	22.09
		12	0	21.17	22.99	21.44
		12	6	22.30	20.34	22.93
		12	13	20.67	21.09	21.57
		25	0	20.10	22.09	20.73
	16QAM	1	0	20.99	20.77	21.99
		1	13	21.50	22.68	22.32
		1	24	22.31	22.54	20.54
		12	0	20.87	20.25	20.95
		12	6	22.08	20.18	21.43
		12	13	22.85	22.81	22.32
		25	0	21.05	21.90	21.65

Bandwidth	Mode	RB Size	RB Offset	Actual output power(dBm)		
				Channel 23050 703.0MHz	Channel 23095 707MHz	Channel 23130 711.0MHz
10MHz	QPSK	1	0	22.62	22.90	20.92
		1	25	20.95	21.18	21.40
		1	49	20.84	22.12	20.38
		25	0	22.54	20.33	20.35
		25	13	21.01	20.11	22.60
		25	25	21.75	20.32	20.95
		50	0	21.67	22.72	21.60

## 6.4 Occupancy Bandwidth

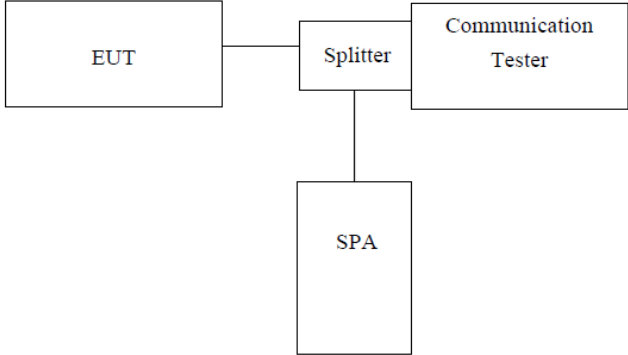
Test Requirement:	Part 24.238; FCC Part 27.53(h)/(g)
Test Method:	FCC part2.1049
Test setup:	 <p><i>Note: Measurement setup for testing on Antenna connector</i></p>
Test Procedure:	<ol style="list-style-type: none"> <li>1. The EUT's output RF connector was connected with a short cable to the spectrum analyzer</li> <li>2. RBW was set to about 1% of emission BW, VBW= 3 times RBW.</li> <li>3. -26dBc display line was placed on the screen (or 99% bandwidth), the occupied bandwidth is the delta frequency between the two points where the display line intersects the signal trace.</li> </ol>
Test Instruments:	Refer to section 6.0 for details
Test mode:	Refer to section 6.1 for details
Test results:	Pass

Measurement Data

QPSK mode:

EUT Mode	Channel Bandwidth	Channel	RB Configure		99% Occupy bandwidth (KHz)	-26dB bandwidth (KHz)
			RB Size	RB Offset		
LTE Band 2	5MHz	Low range	25	0	4537.70	5720.00
		Mid range	25	0	4548.30	5945.00
		High range	25	0	4549.90	5727.00
	10MHz	Low range	50	0	8977.70	10783.00
		Mid range	50	0	8951.10	10378.00
		High range	50	0	8942.00	10359.00
	15MHz	Low range	75	0	13513.70	16080.00
		Mid range	75	0	13487.40	16415.00
		High range	75	0	13441.10	16001.00
	20MHz	Low range	100	0	18001.30	20530.00
		Mid range	100	0	17951.40	20250.00
		High range	100	0	17943.40	20439.00
EUT Mode	Channel Bandwidth	Channel	RB Configure		99% Occupy bandwidth (KHz)	-26dB bandwidth (KHz)
LTE Band 4	5MHz	Low range	25	0	4539.30	5787.00
		Mid range	25	0	4536.20	5702.00
		High range	25	0	4555.50	5809.00
	10MHz	Low range	50	0	8971.20	10628.00
		Mid range	50	0	8969.20	10368.00
		High range	50	0	8938.10	10787.00
	15MHz	Low range	75	0	13549.10	16225.00
		Mid range	75	0	13482.90	16251.00
		High range	75	0	13495.40	16299.00
	20MHz	Low range	100	0	17979.30	20624.00
		Mid range	100	0	17987.10	20582.00
		High range	100	0	17977.80	20635.00
EUT Mode	Channel Bandwidth	Channel	RB Configure		99% Occupy bandwidth (KHz)	-26dB bandwidth (KHz)
LTE Band 12	5MHz	Low range	25	0	4537.90	5829.00
		Mid range	25	0	4529.80	5747.00
		High range	25	0	4517.10	5632.00
	10MHz	Low range	50	0	8979.90	10437.00
		Mid range	50	0	8975.20	10724.00
		High range	50	0	8924.70	10437.00



16QAM mode:

EUT Mode	Channel Bandwidth	Channel	RB Configure		99% Occupy bandwidth (KHz)	-26dB bandwidth (KHz)
			RB Size	RB Offset		
LTE Band 2	5MHz	Low range	25	0	4550.40	5990.00
		Mid range	25	0	4554.50	5894.00
		High range	25	0	4556.60	5957.00
EUT Mode	Channel Bandwidth	Channel	RB Configure		99% Occupy bandwidth (KHz)	-26dB bandwidth (KHz)
LTE Band 4	5MHz	Low range	25	0	4549.30	5937.00
		Mid range	25	0	4535.10	5831.00
		High range	25	0	4542.30	5633.00
EUT Mode	Channel Bandwidth	Channel	RB Configure		99% Occupy bandwidth (KHz)	-26dB bandwidth (KHz)
LTE Band 12	5MHz	Low range	25	0	4512.20	5845.00
		Mid range	25	0	4548.70	5908.00
		High range	25	0	4491.50	5869.00

Test plot as follows:

QPSK mode:

Test band: LTE Band 2	Channel Bandwidth: 5MHz
-----------------------	-------------------------

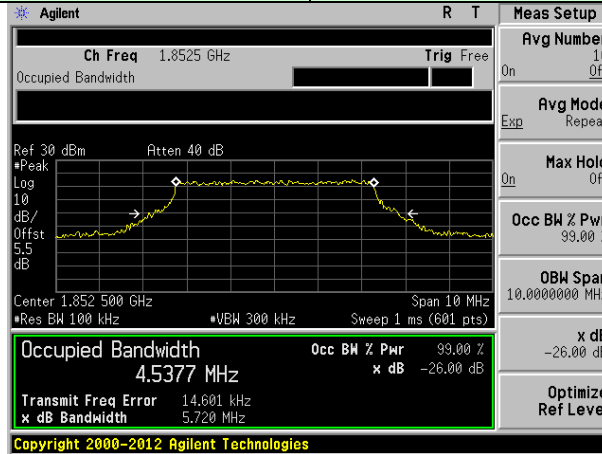

Lowest channel

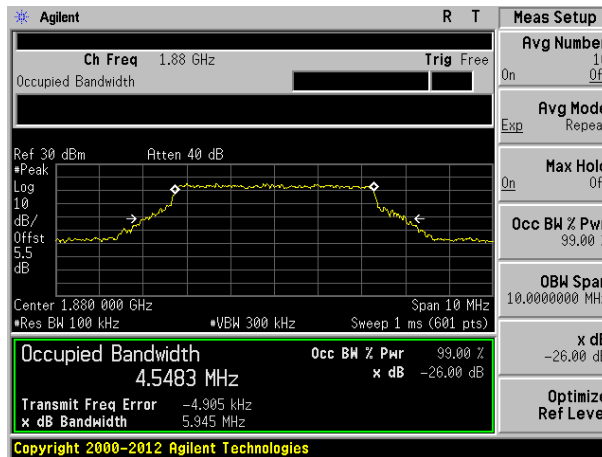

Middle channel

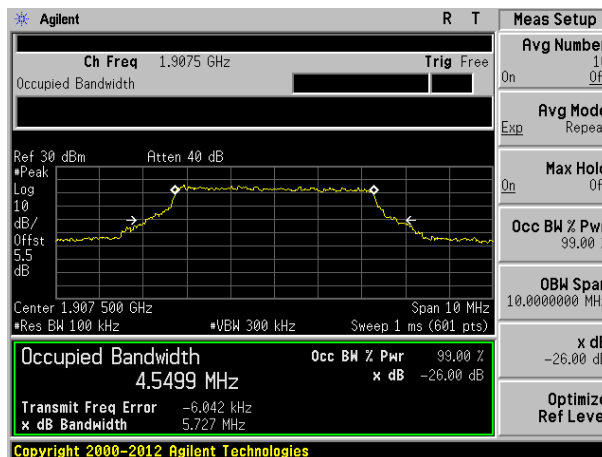

Highest channel

Test band: LTE Band 2      Channel Bandwidth: 10MHz

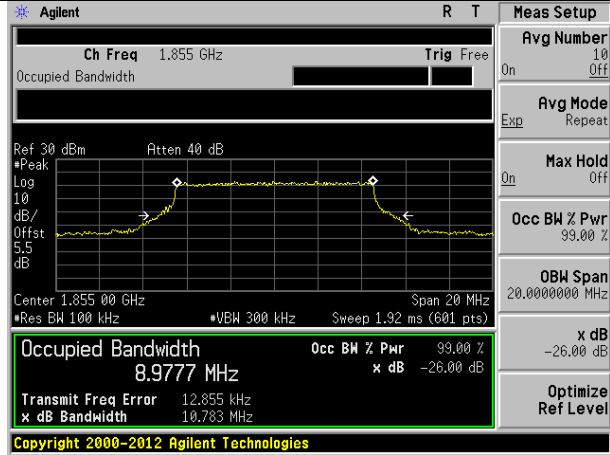

Lowest channel

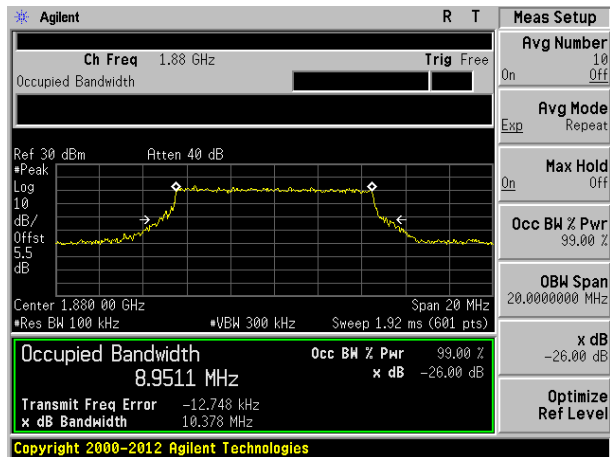

Middle channel

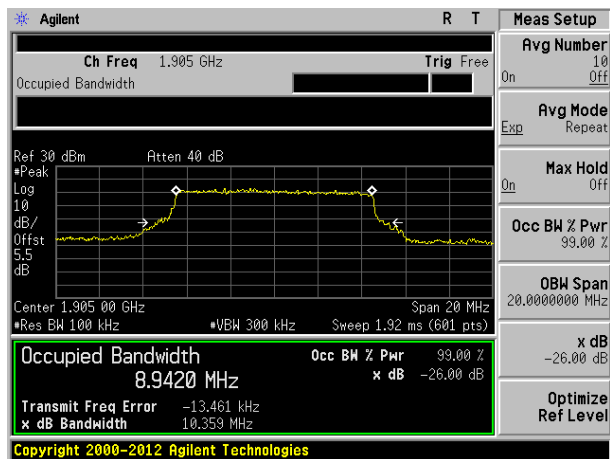

Highest channel

Test band: LTE Band 2      Channel Bandwidth: 15MHz

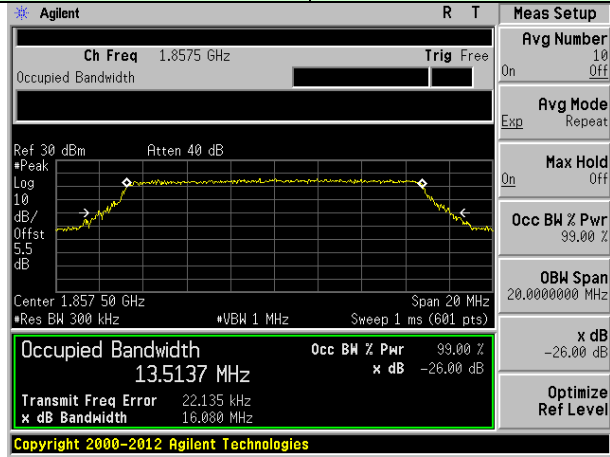

Lowest channel

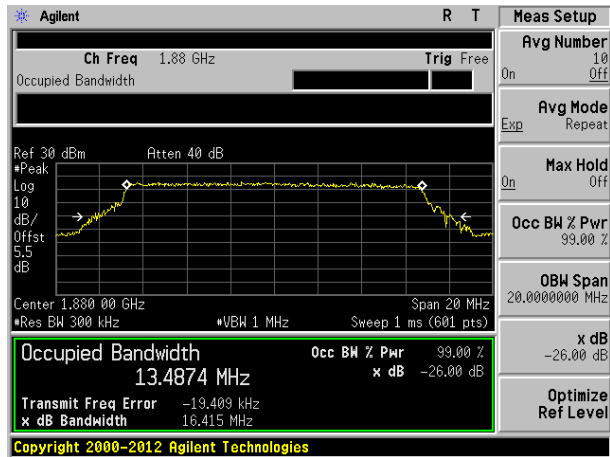

Middle channel

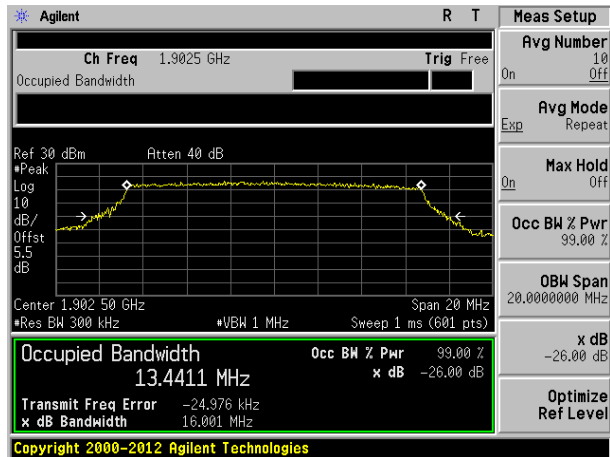

Highest channel

Test band: LTE Band 2 Channel Bandwidth: 20MHz

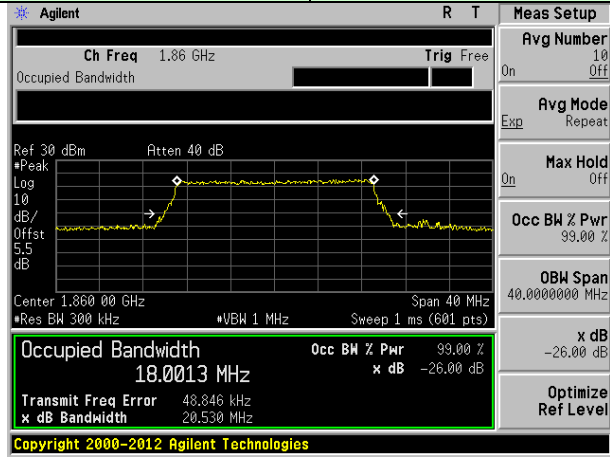

Lowest channel

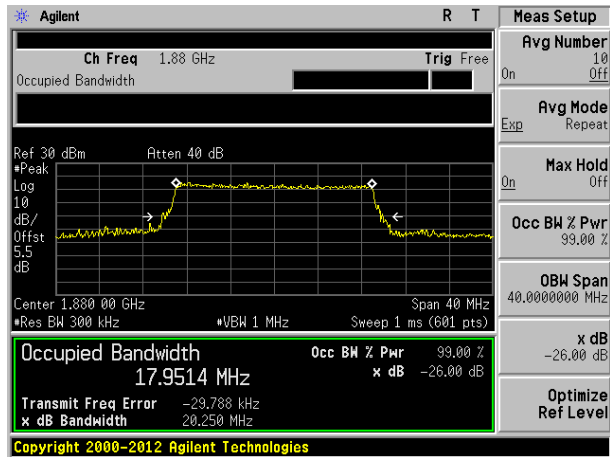

Middle channel

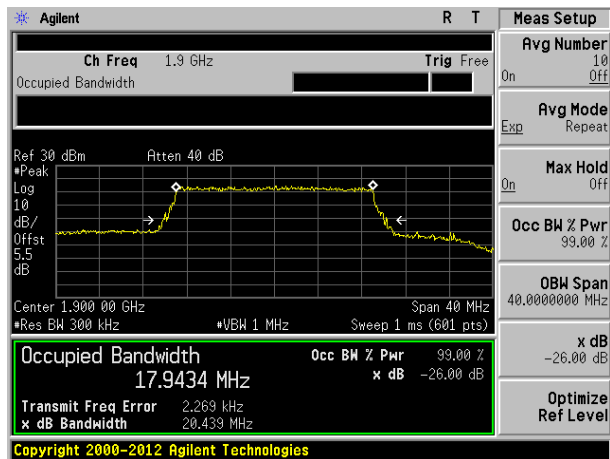

Highest channel

Test band: LTE Band 4 Channel Bandwidth: 5MHz

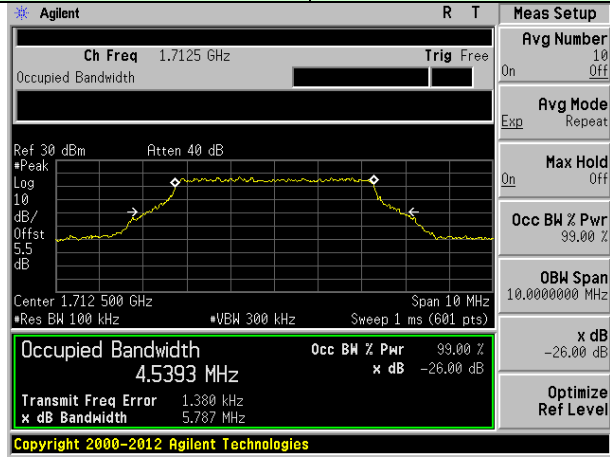

Lowest channel

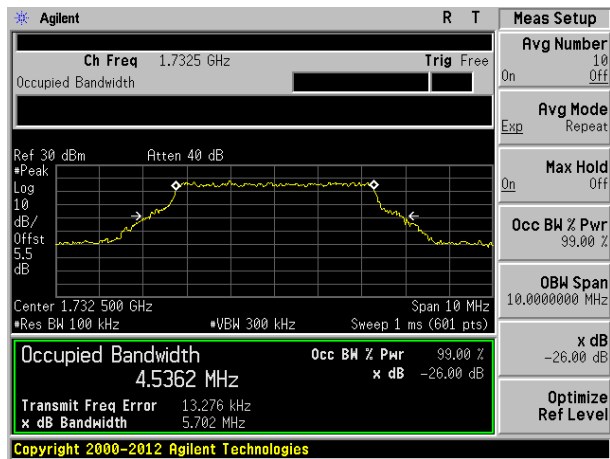

Middle channel

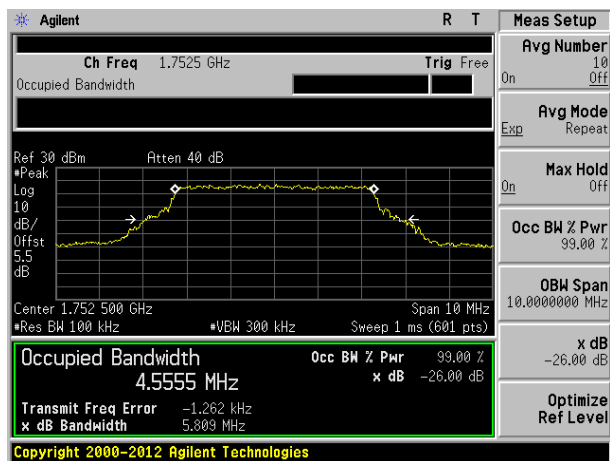

Highest channel

Test band: LTE Band 4      Channel Bandwidth: 10MHz

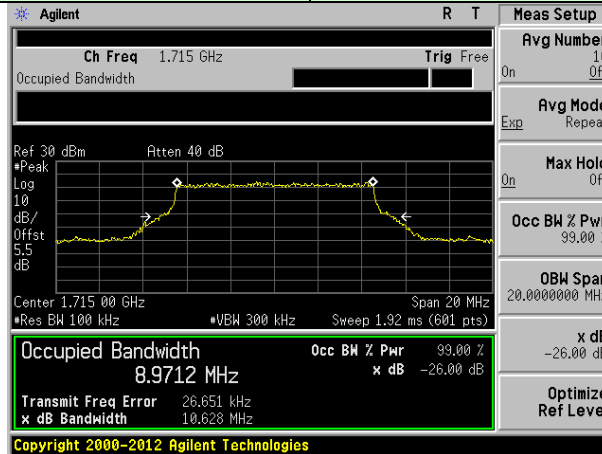

Lowest channel

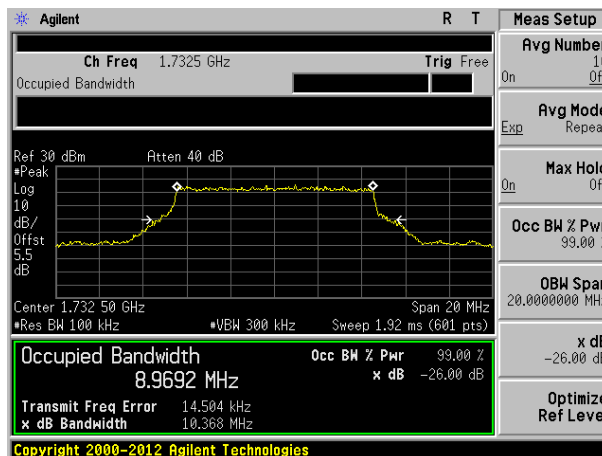

Middle channel

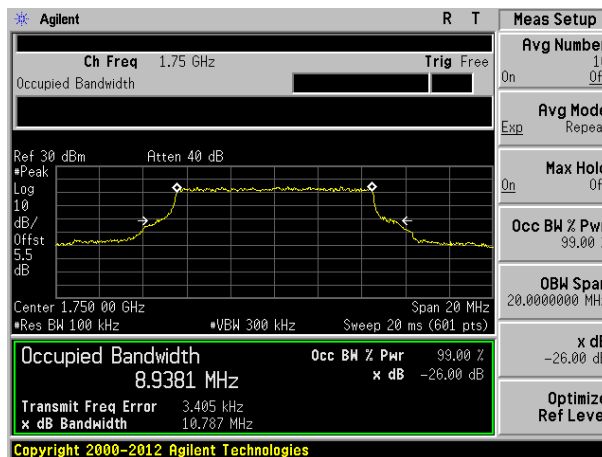

Highest channel

Test band: LTE Band 4      Channel Bandwidth: 15MHz

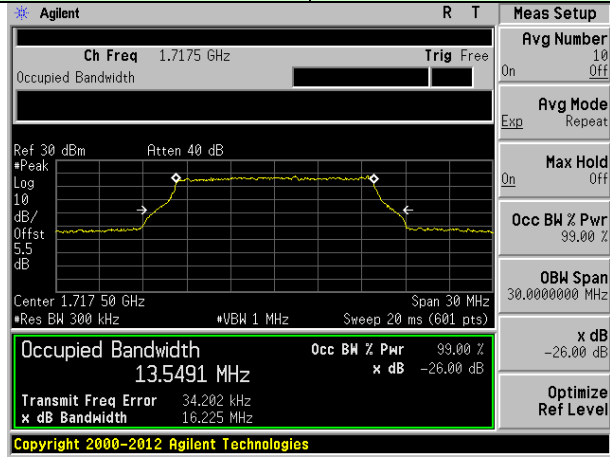

Lowest channel

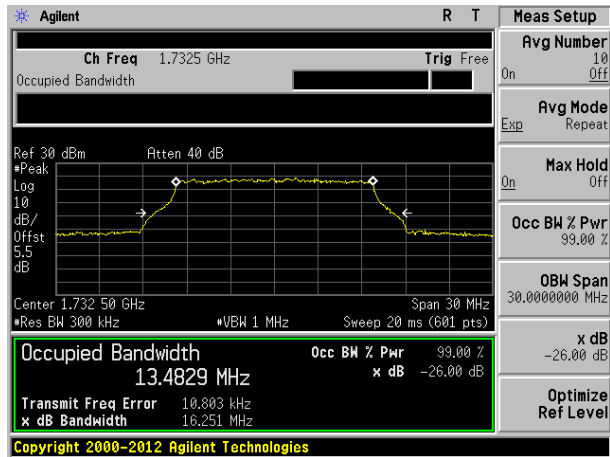

Middle channel

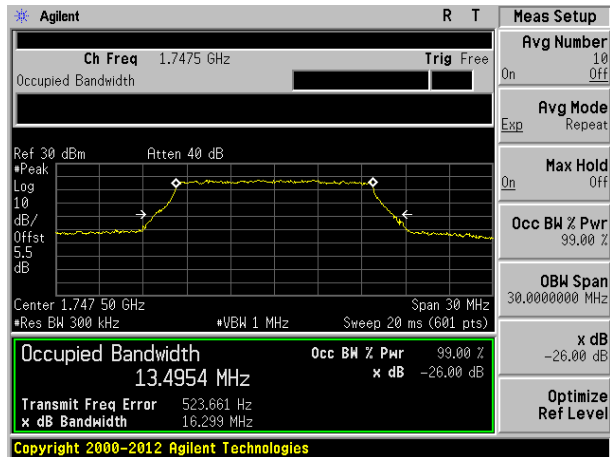

Highest channel



Test band: LTE Band 4      Channel Bandwidth: 20MHz

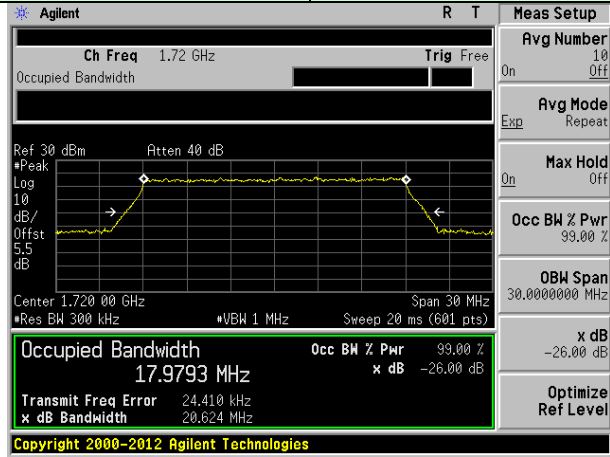

Lowest channel

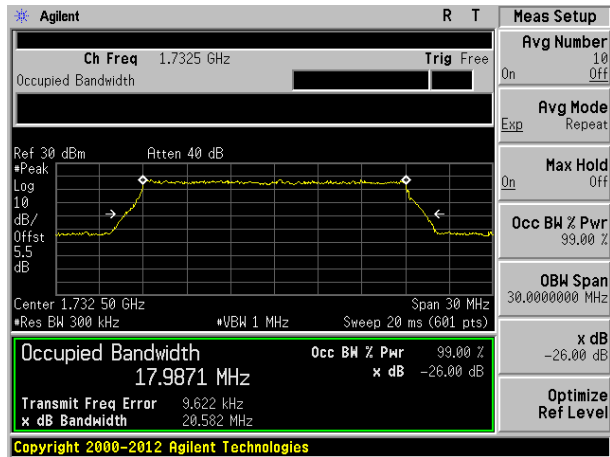

Middle channel

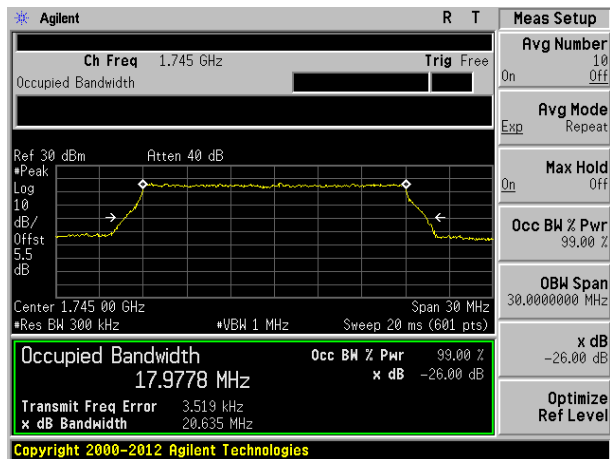

Highest channel

Test band: LTE Band 12 Channel Bandwidth: 5MHz

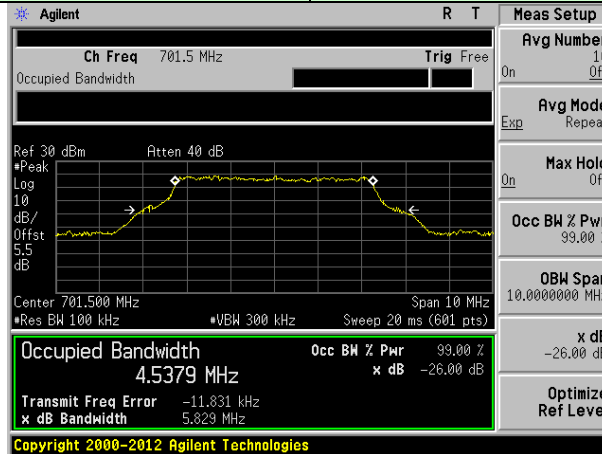

Lowest channel

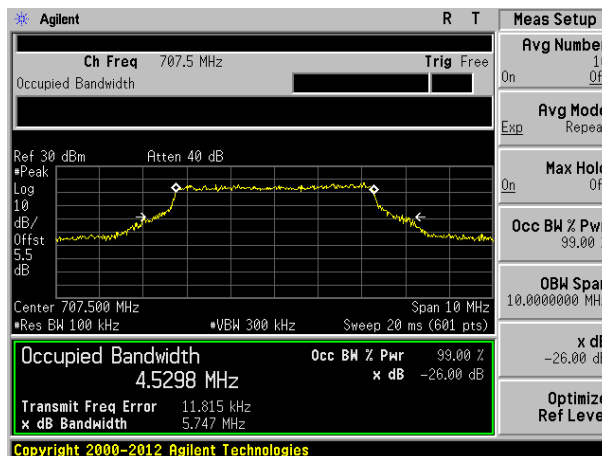

Middle channel

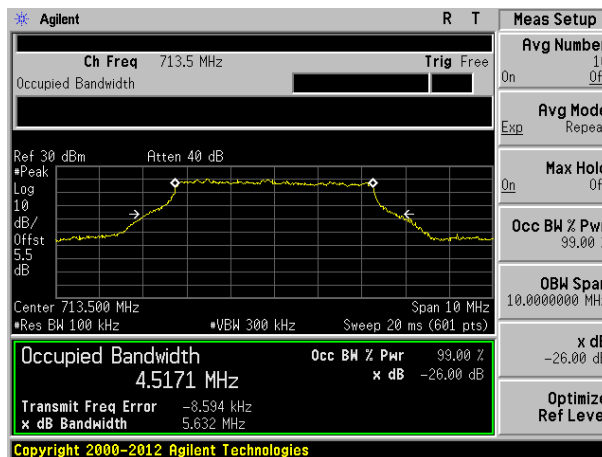

Highest channel

Test band: LTE Band 12 Channel Bandwidth: 10MHz

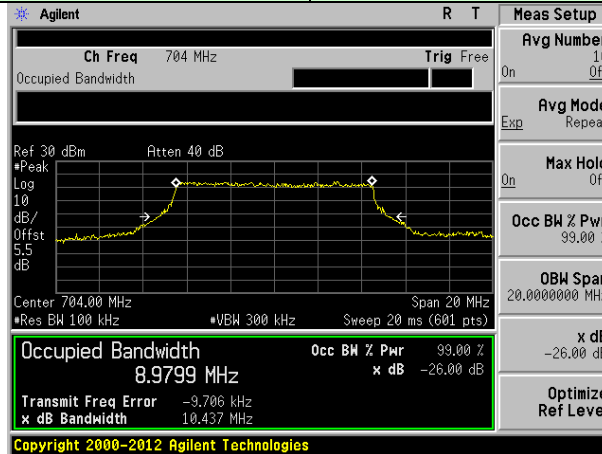

Lowest channel

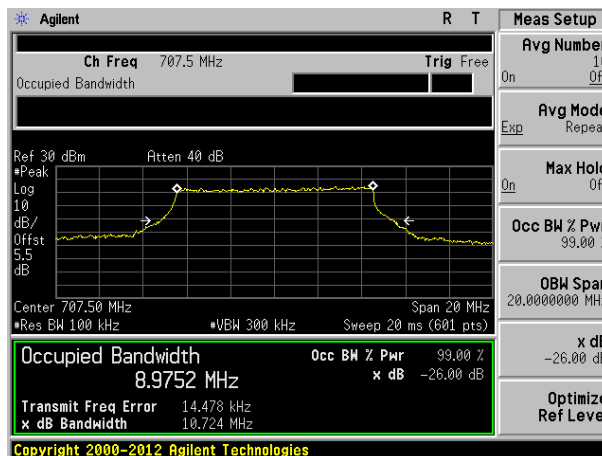

Middle channel

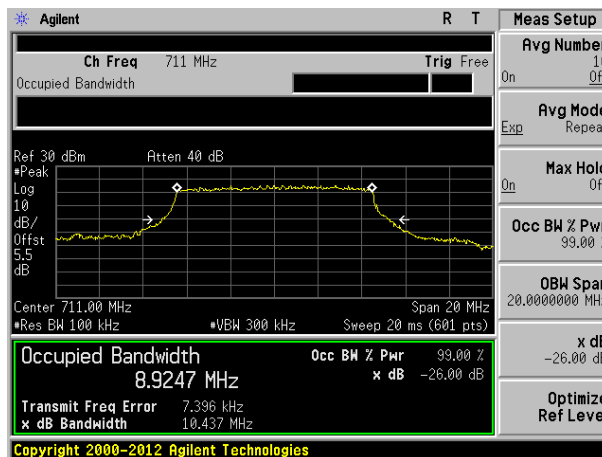

Highest channel

16QAM mode:

Test band: LTE Band 2 Channel Bandwidth: 5MHz

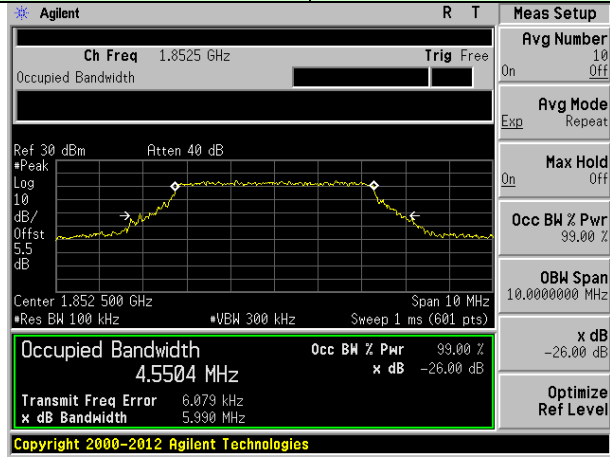

Lowest channel

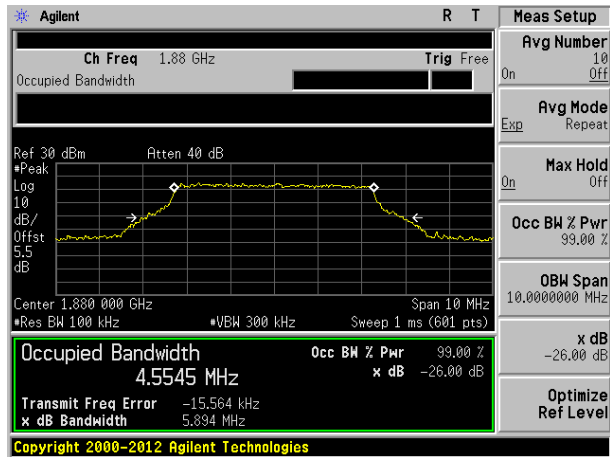

Middle channel

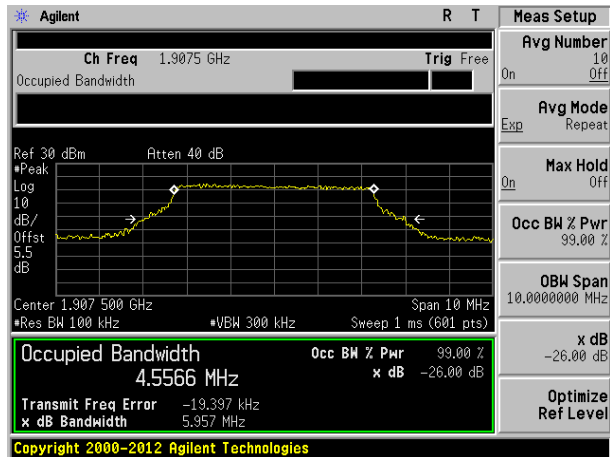

Highest channel

Test band: LTE Band 4 Channel Bandwidth: 5MHz

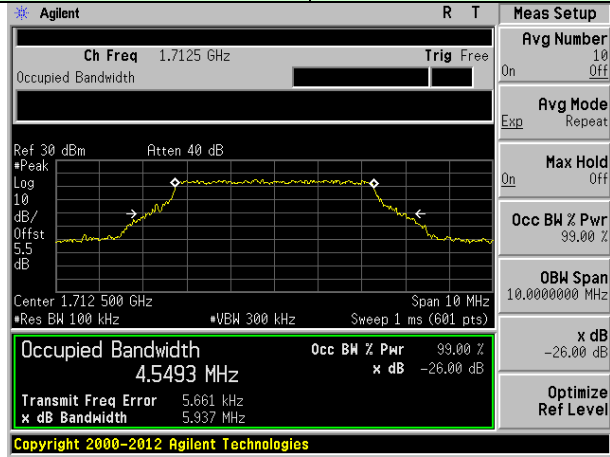

Lowest channel

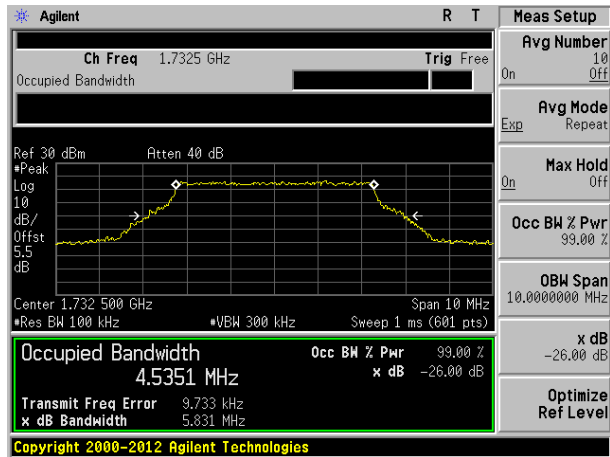

Middle channel

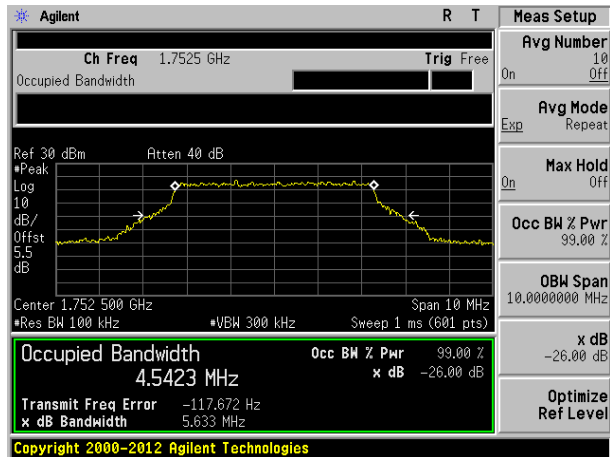

Highest channel

Test band: LTE Band 12      Channel Bandwidth: 5MHz

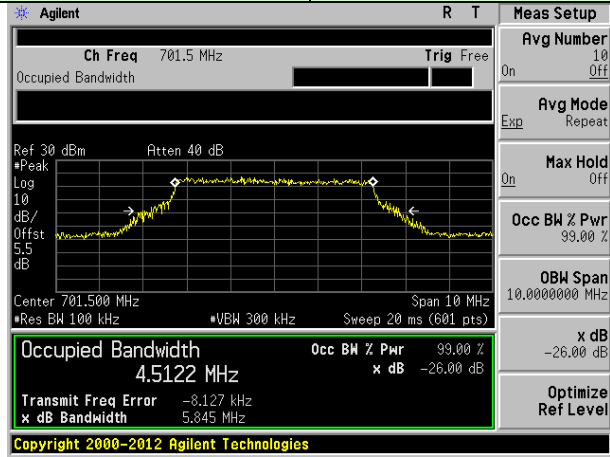

Lowest channel

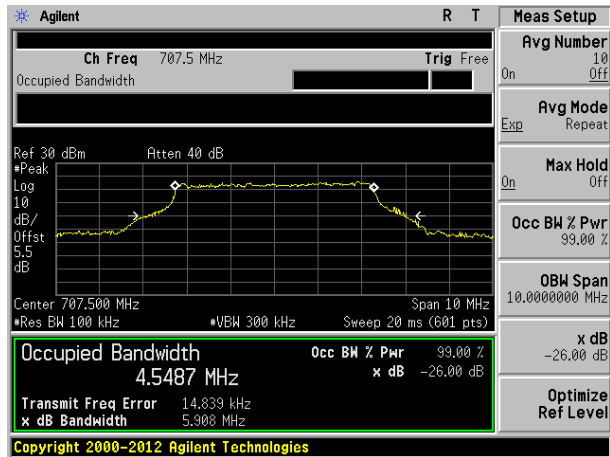

Middle channel

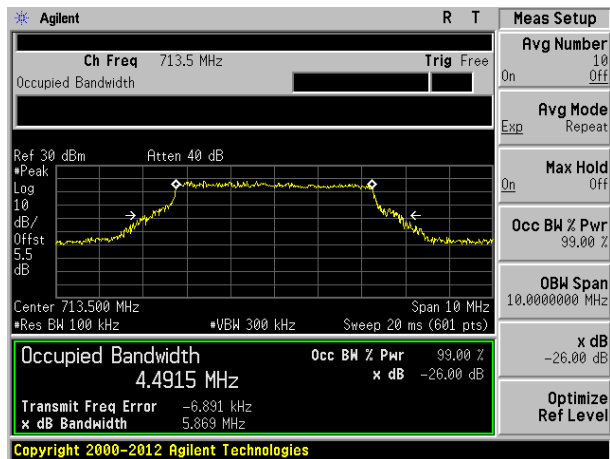

Highest channel

## 6.5 MODULATION CHARACTERISTIC

According to FCC § 2.1047(d), Part 27 there is no specific requirement for digital modulation, therefore modulation characteristic is not presented.

## 6.6 Out of band emission at antenna terminals

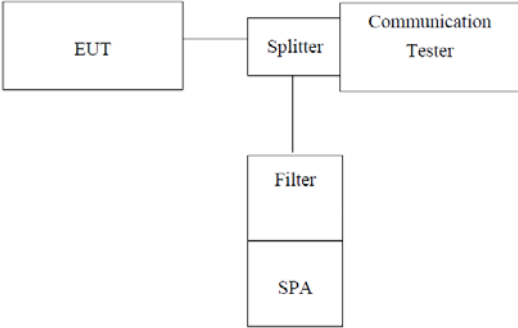
Test Requirement:	Part 24.238 (a); FCC Part 27.53(h)/(g)
Test Method:	FCC part2.1051
Limit:	-13dBm
Test setup:	 <p><i>Note: Measurement setup for testing on Antenna connector</i></p>
Test Procedure:	<ol style="list-style-type: none"> <li>1 The RF output of the transceiver was connected to a spectrum analyzer through appropriate attenuation.</li> <li>2 The resolution bandwidth of the spectrum analyzer was set at 1MHz, sufficient scans were taken to show the out of band Emissions if any up to 10th harmonic.</li> <li>3 For the out of band: Set the RBW, VBW = 1MHz, Start=30MHz, Stop= 10th harmonic.</li> <li>4 Band Edge Requirements: In the 1 MHz bands immediately outside and adjacent to the frequency block, a resolution bandwidth of at least 1 percent of the emission bandwidth of the fundamental emission of the transmitter may be employed to measure the out of band Emissions.</li> </ol>
Test Instruments:	Refer to section 6.0 for details
Test mode:	Refer to section 6.1 for details
Test results:	Pass

Test plot as follows:

QPSK mode:

Test Mode: LTE Band 2 Channel Bandwidth: 5MHz

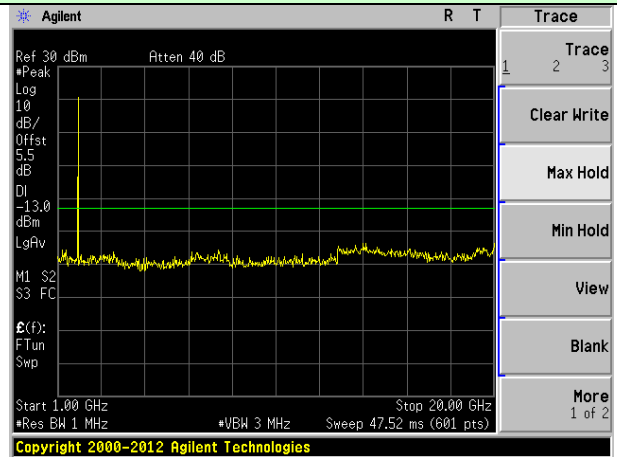
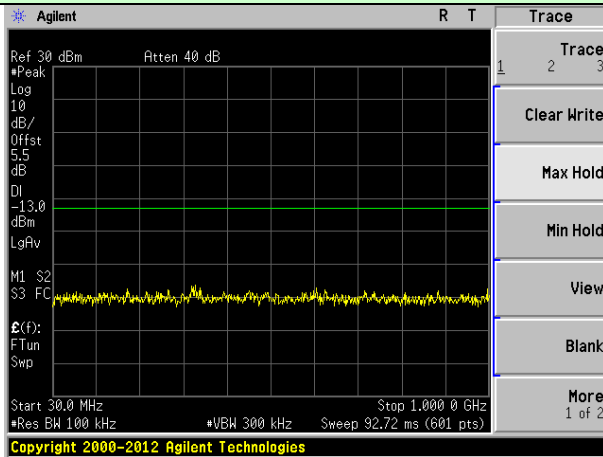

Lowest channel

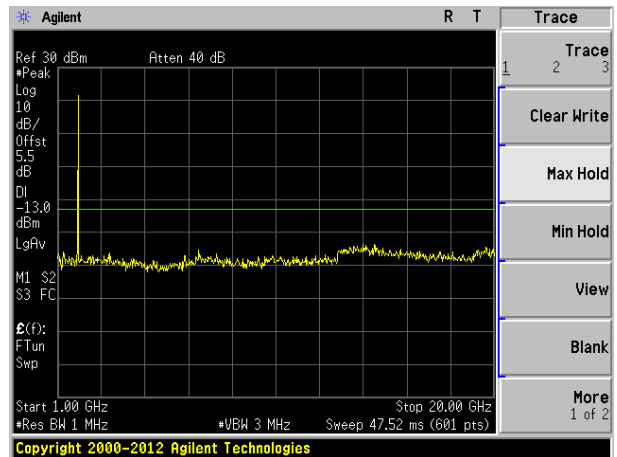
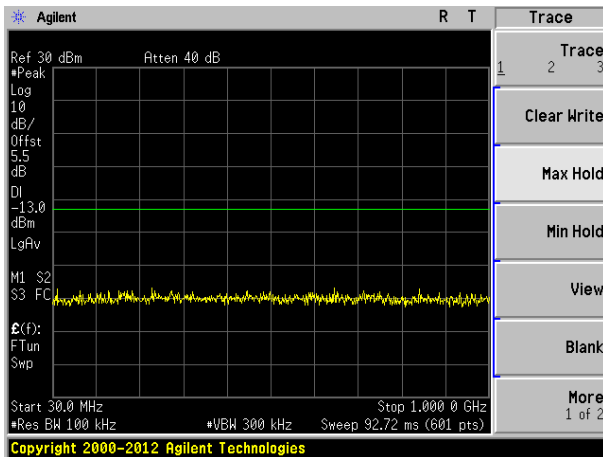

Middle channel

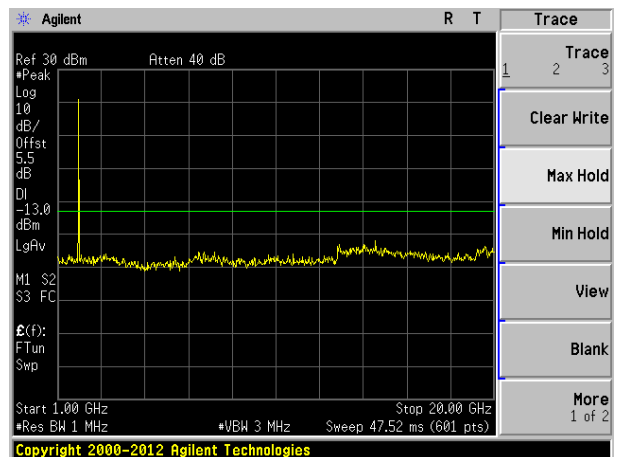
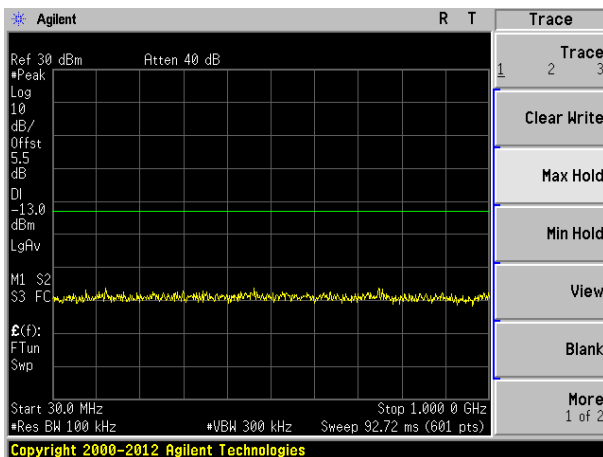

Highest channel



Test Mode: LTE Band 2 Channel Bandwidth: 10MHz

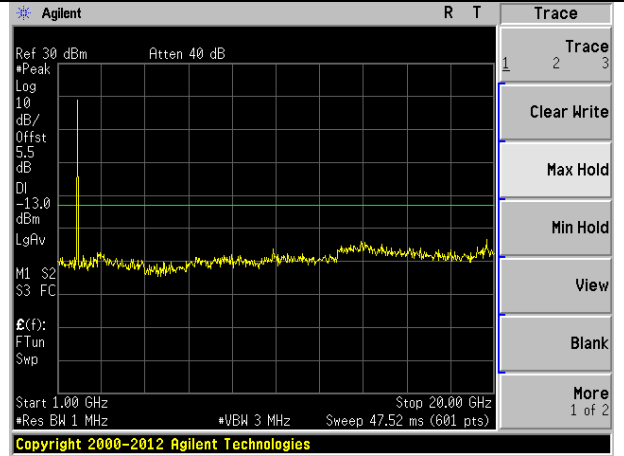
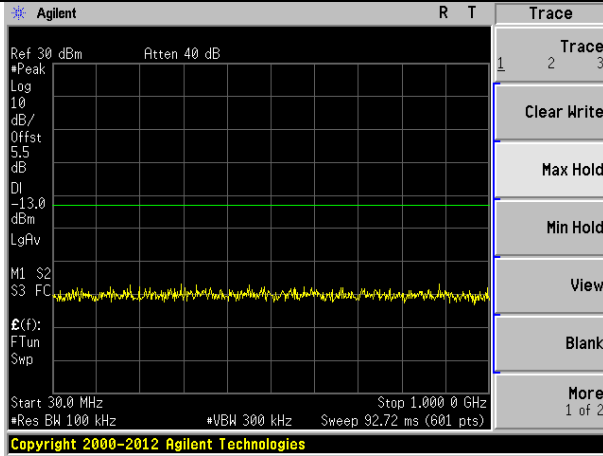

Lowest channel

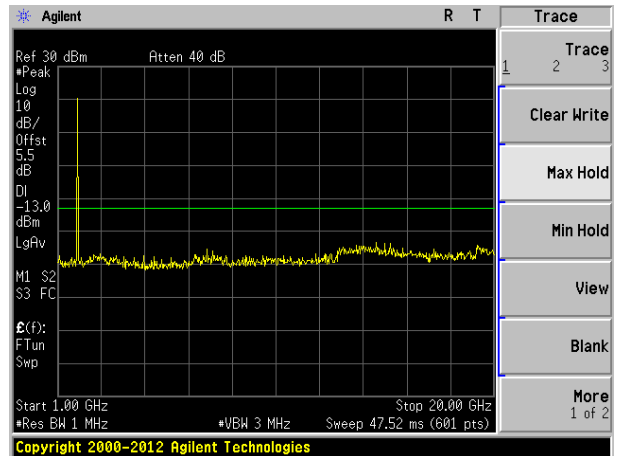
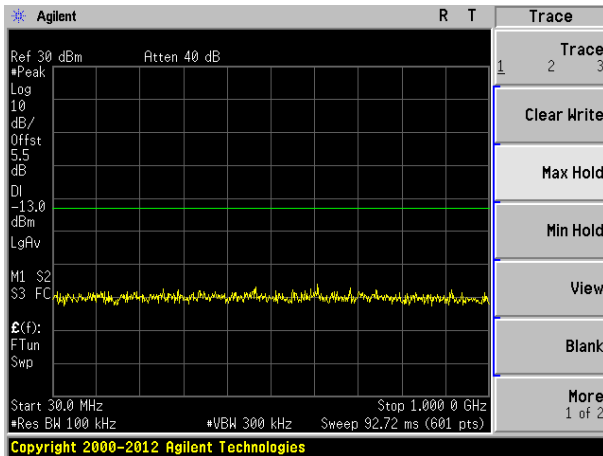

Middle channel

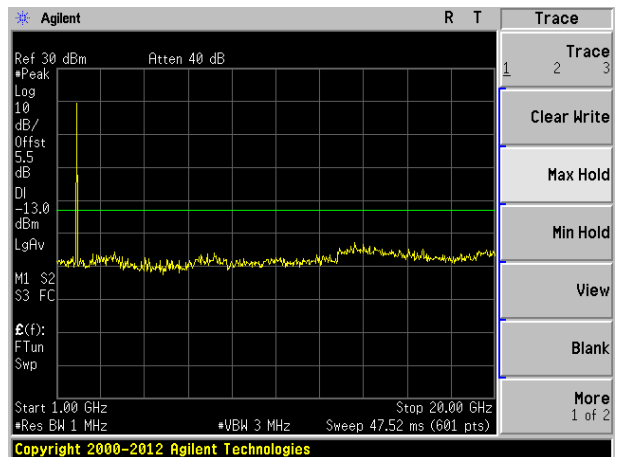
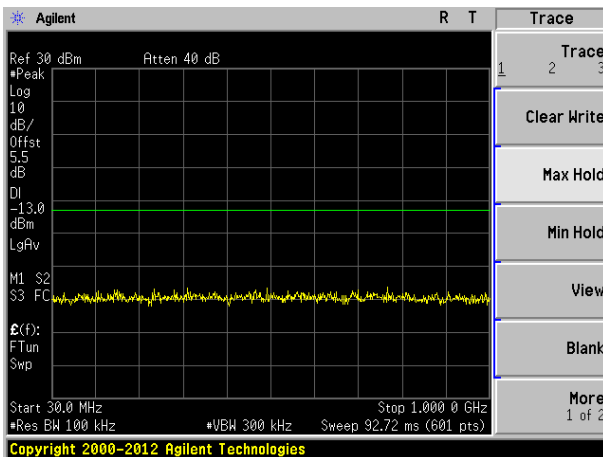

Highest channel

Test Mode: LTE Band 2 Channel Bandwidth: 15MHz

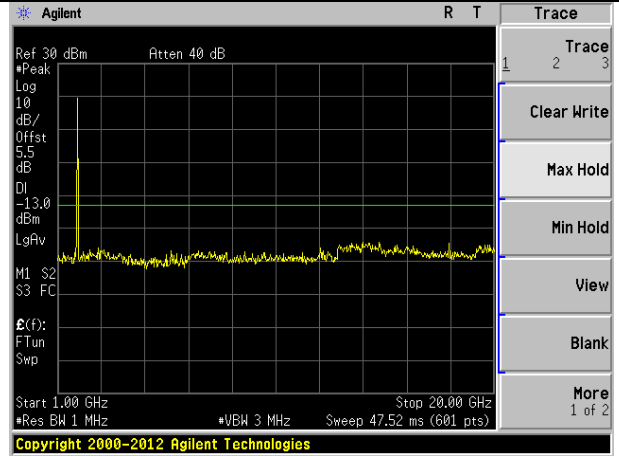
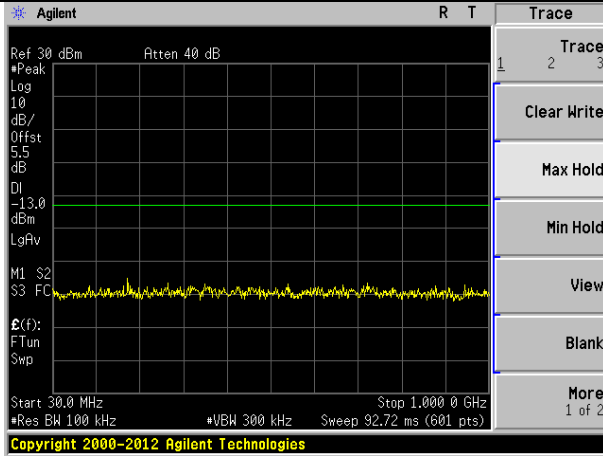

Lowest channel

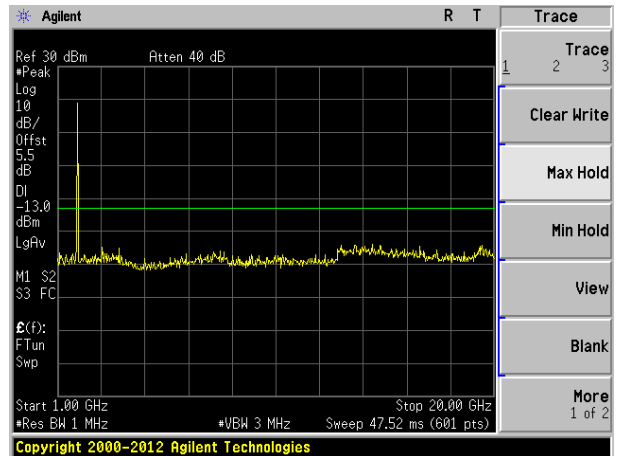
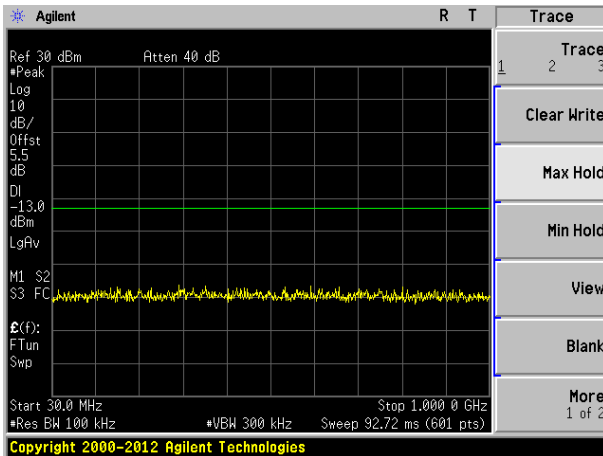

Middle channel

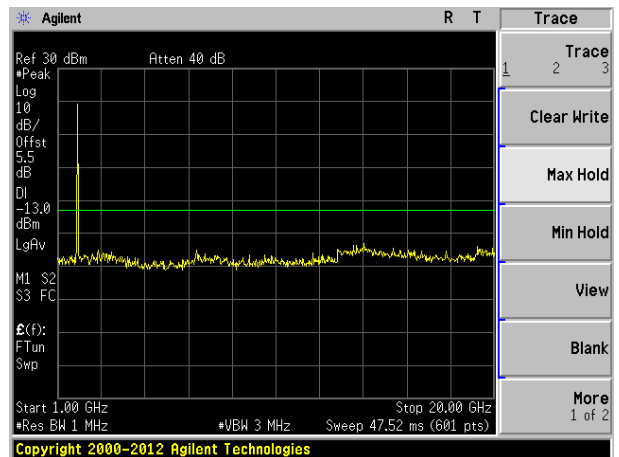
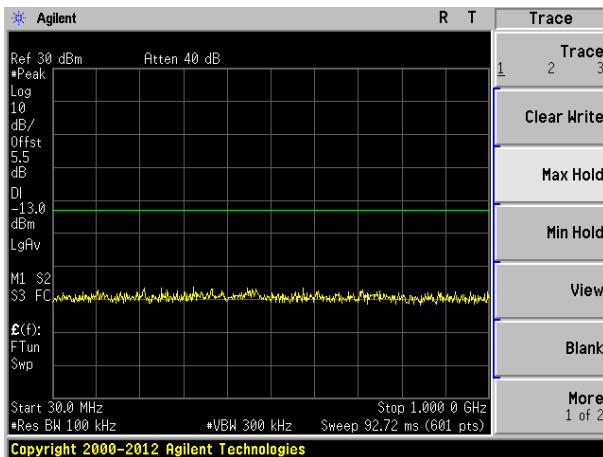

Highest channel

Test Mode: LTE Band 2 Channel Bandwidth: 20MHz

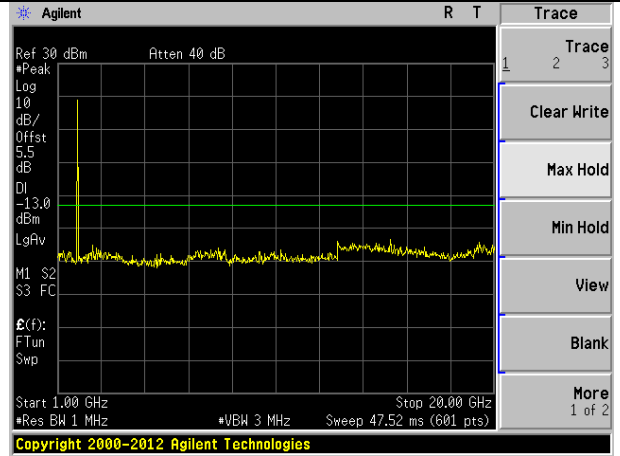
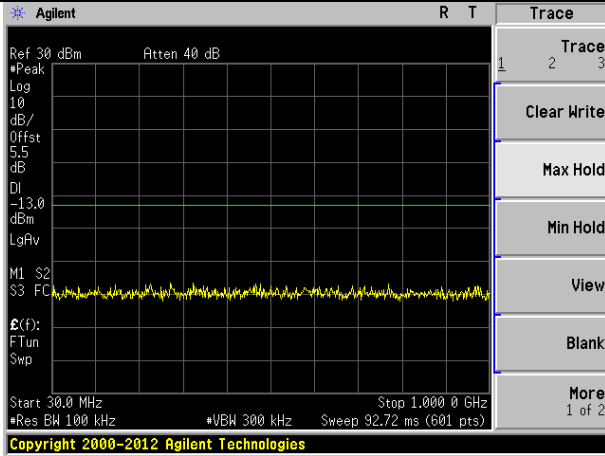

Lowest channel

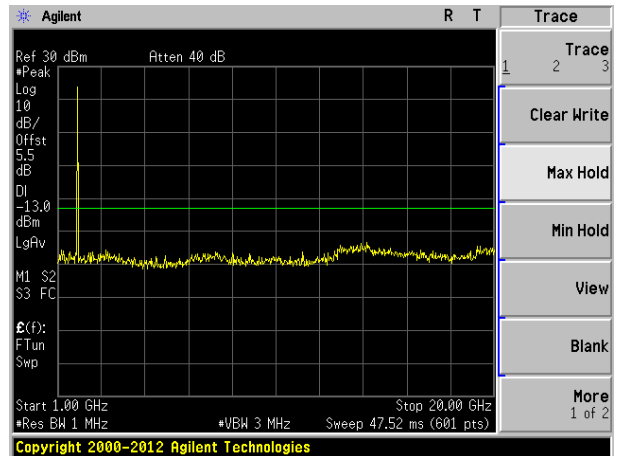
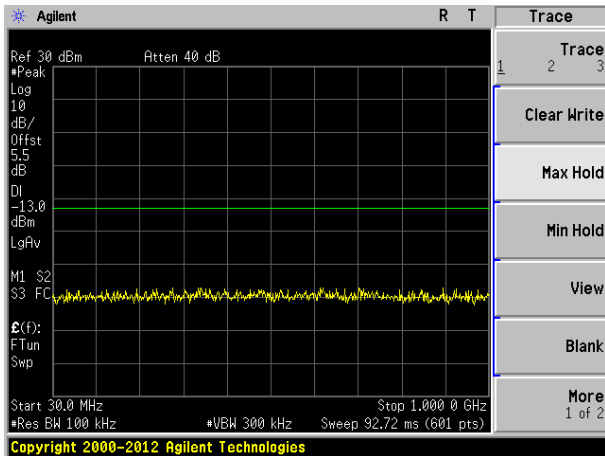

Middle channel

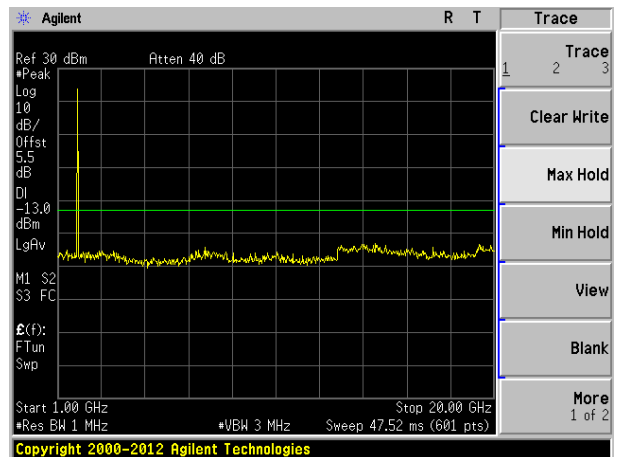
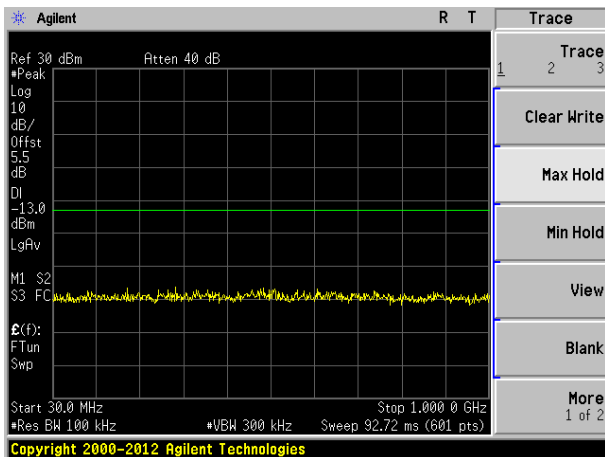

Highest channel

Test Mode: LTE Band 4 Channel Bandwidth: 5MHz

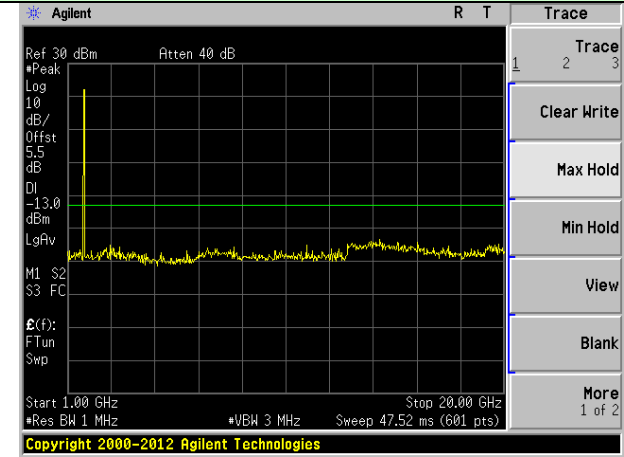
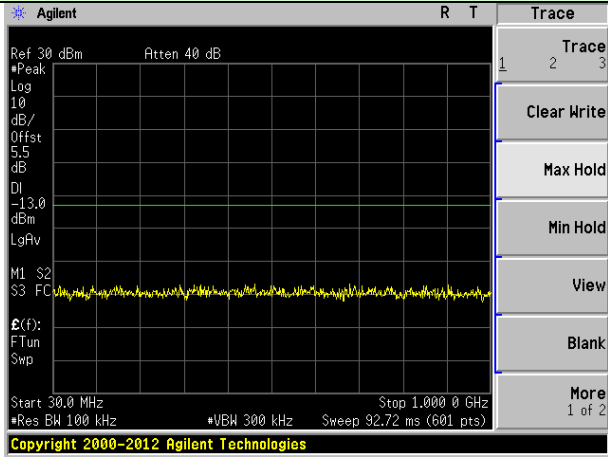

Lowest channel

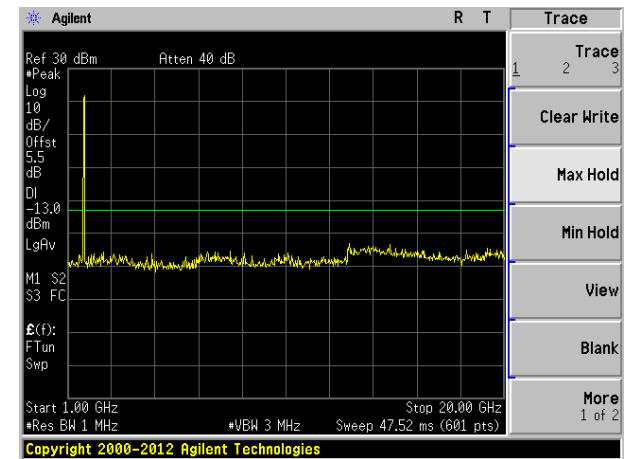
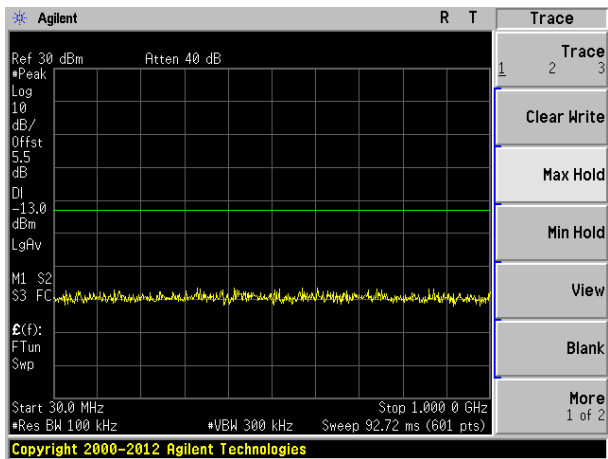

Middle channel

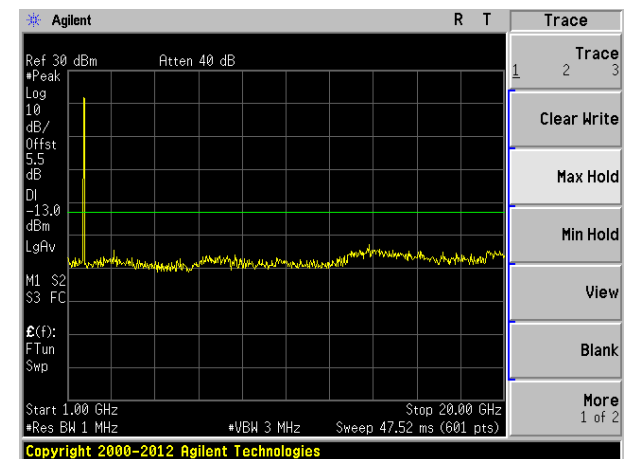
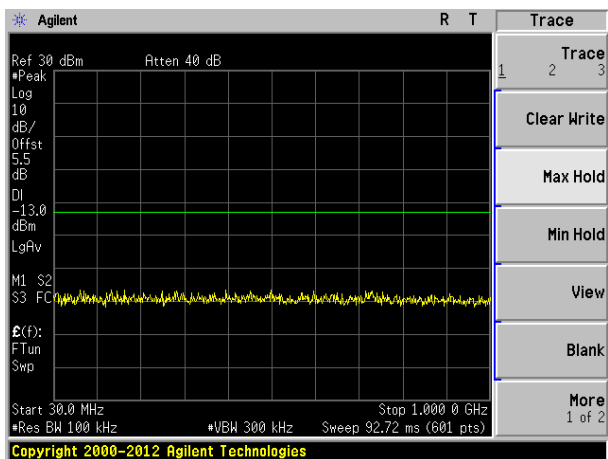

Highest channel

Test Mode: LTE Band 4 Channel Bandwidth: 10MHz

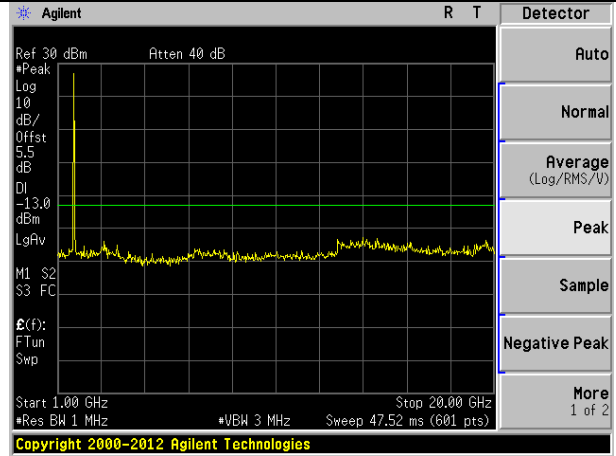
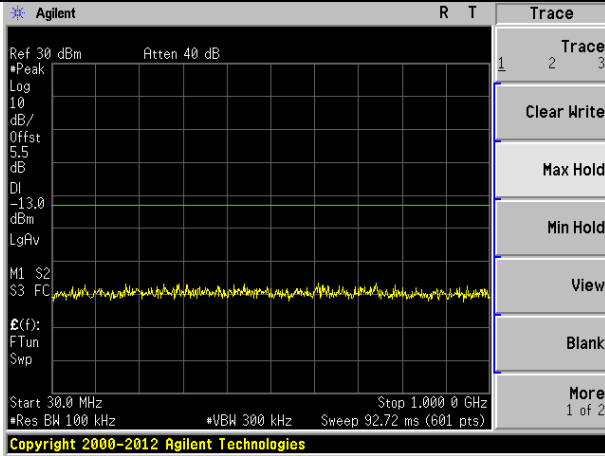

Lowest channel

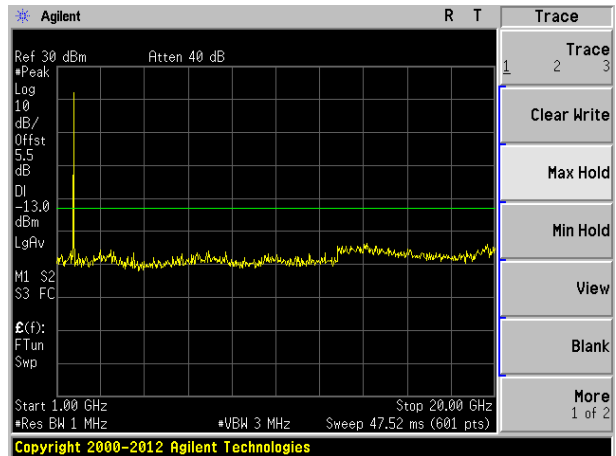
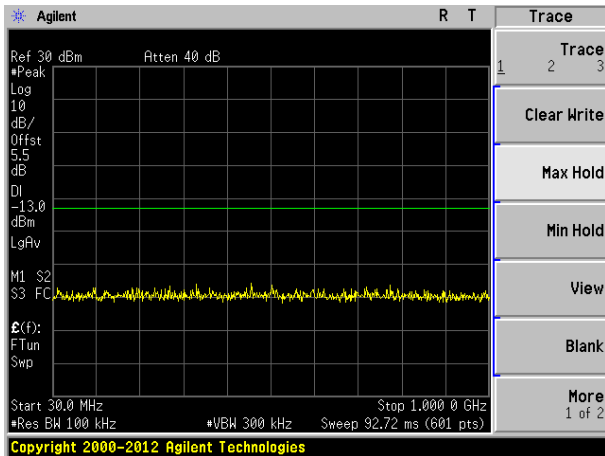

Middle channel

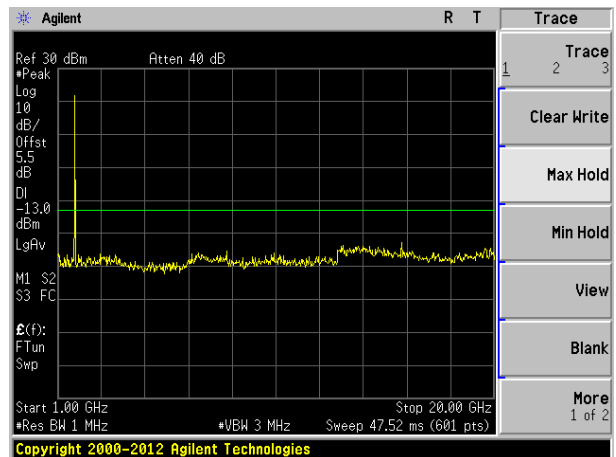
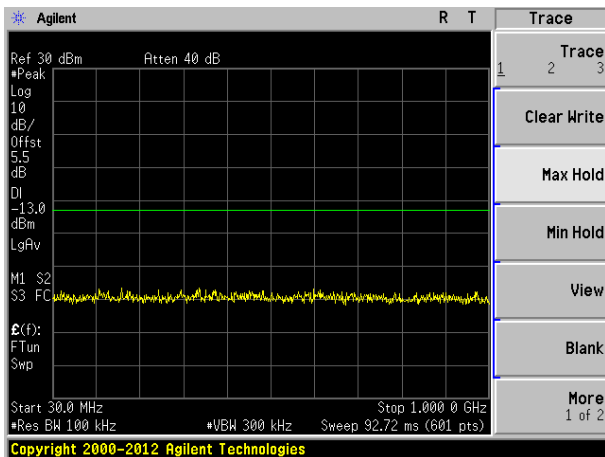

Highest channel

Test Mode: LTE Band 4

Channel Bandwidth: 15MHz

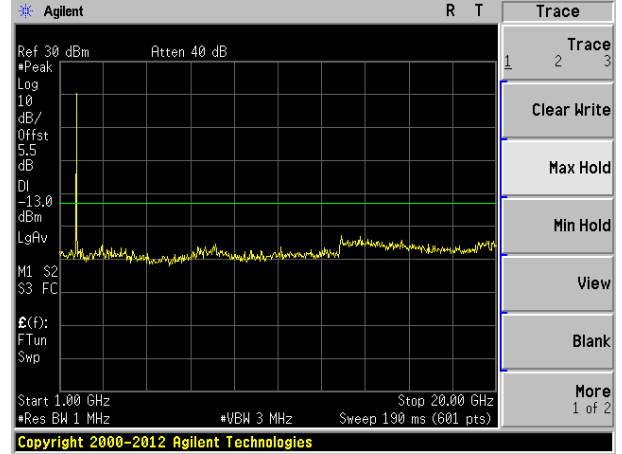
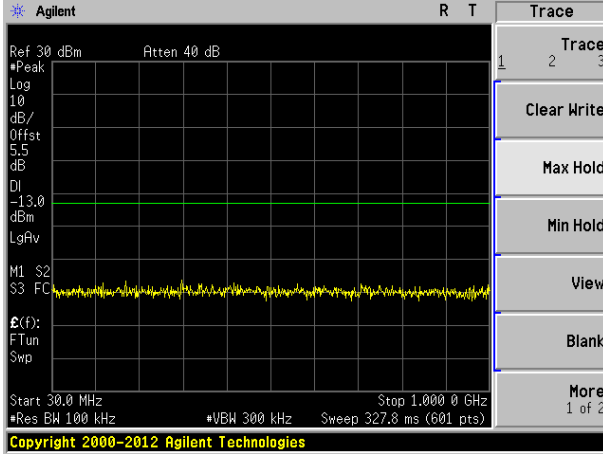

Lowest channel

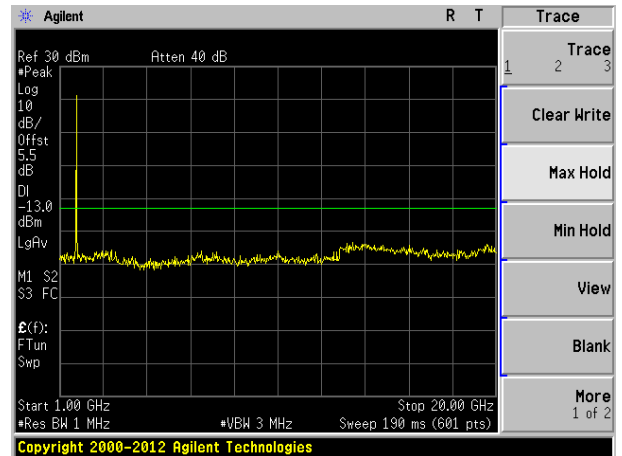
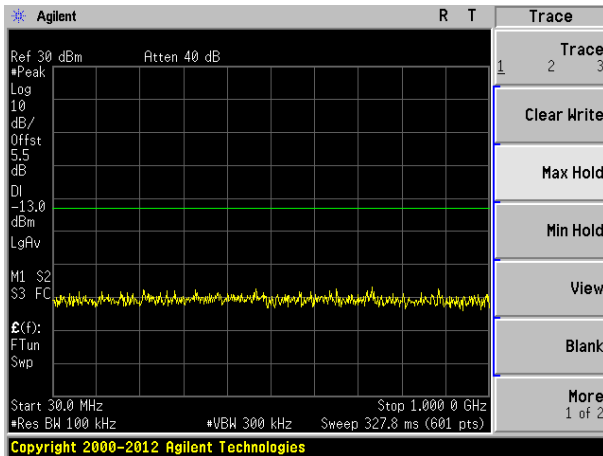

Middle channel

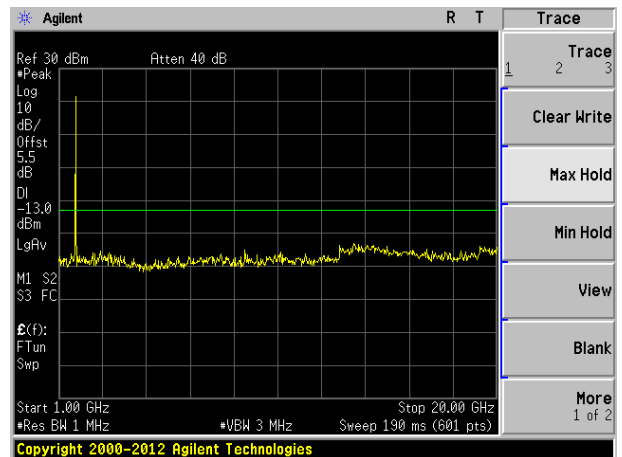
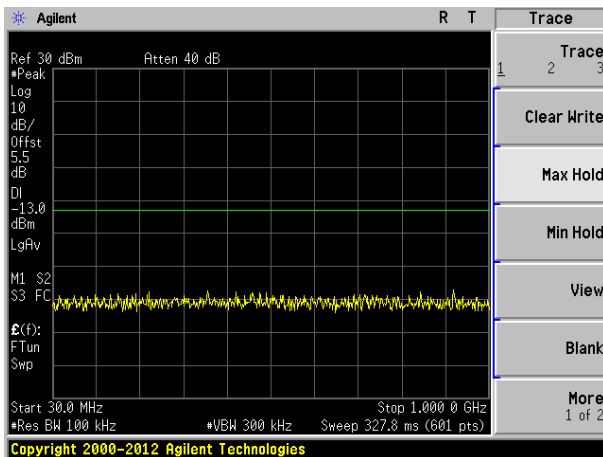

Highest channel

Test Mode: LTE Band 4 Channel Bandwidth: 20MHz

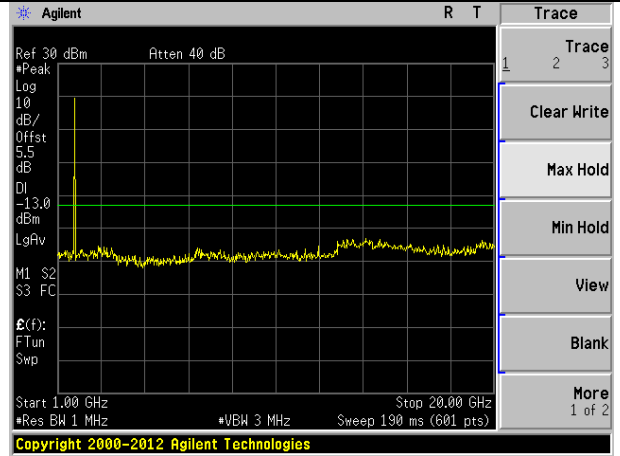
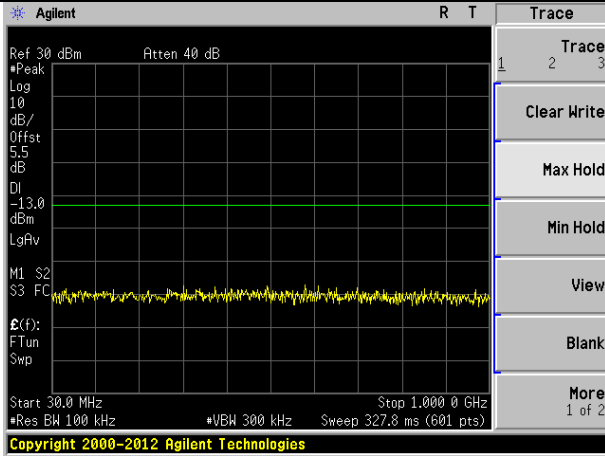

Lowest channel

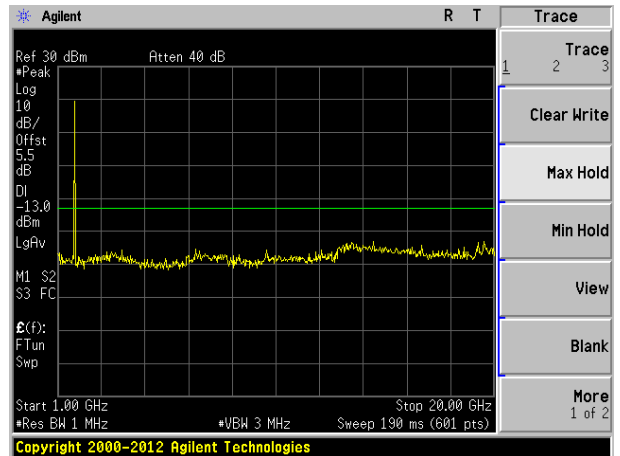
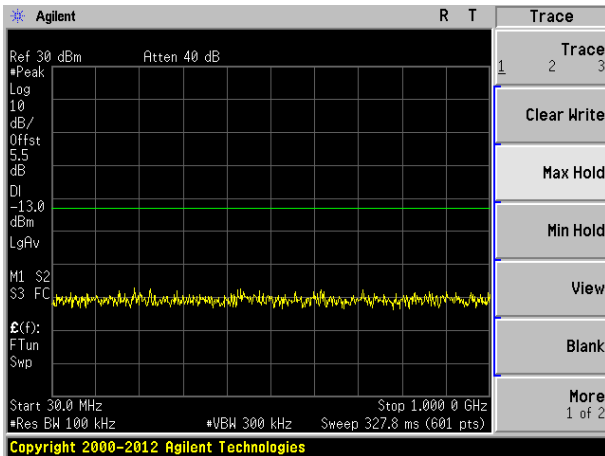

Middle channel

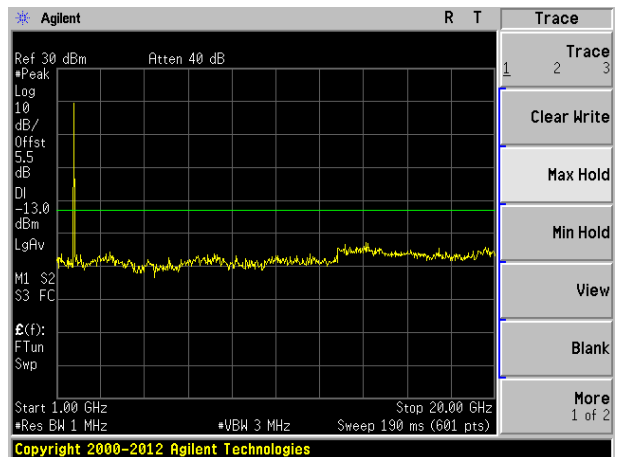
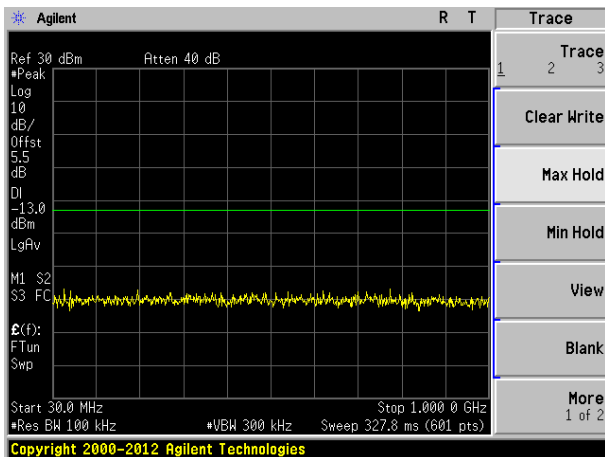

Highest channel

Test Mode: LTE Band 12

Channel Bandwidth: 5MHz

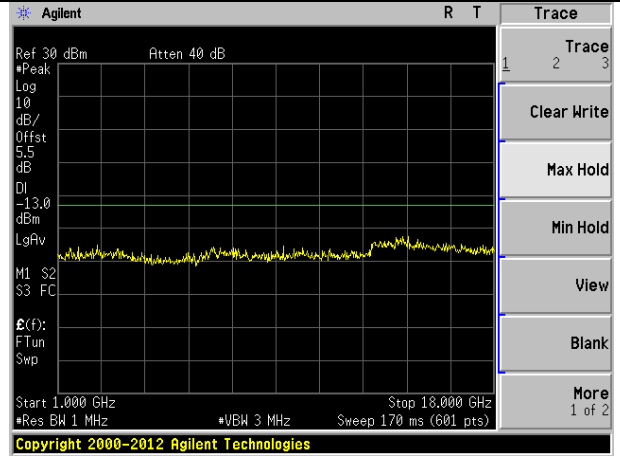
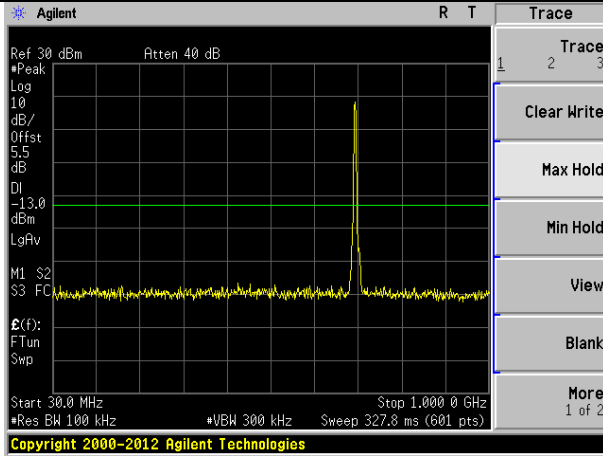

Lowest channel

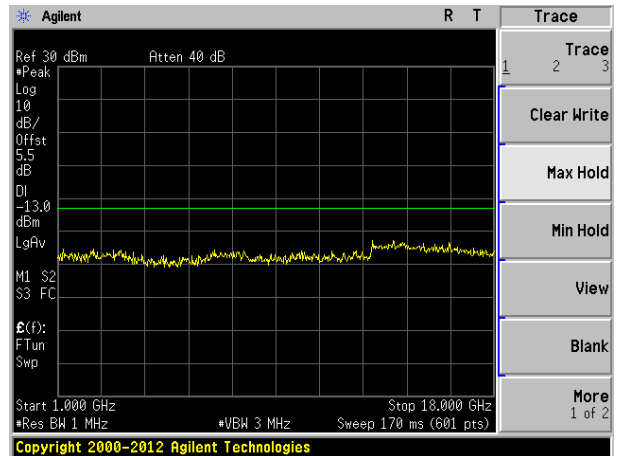
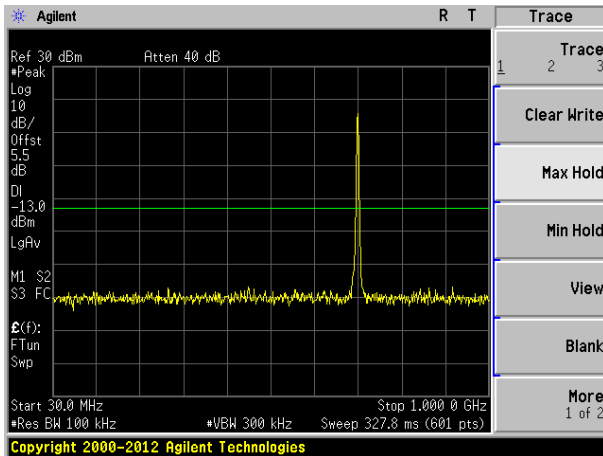

Middle channel

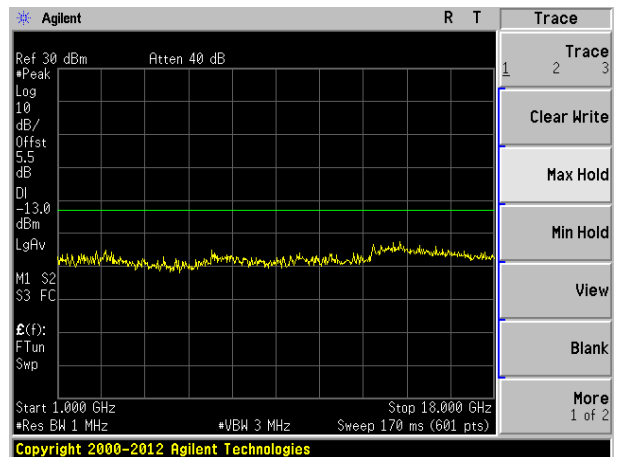
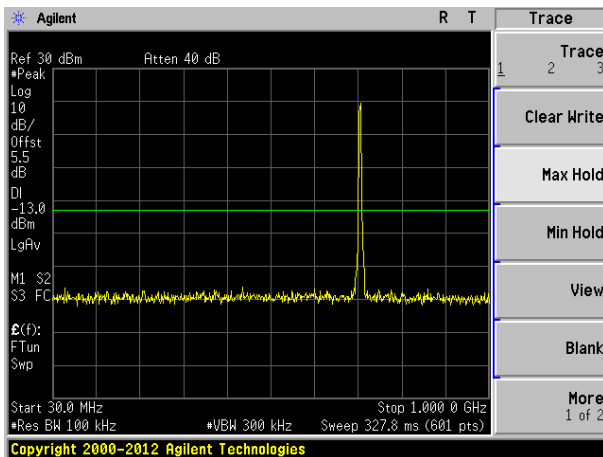

Highest channel



Test Mode: LTE Band 12 Channel Bandwidth: 10MHz

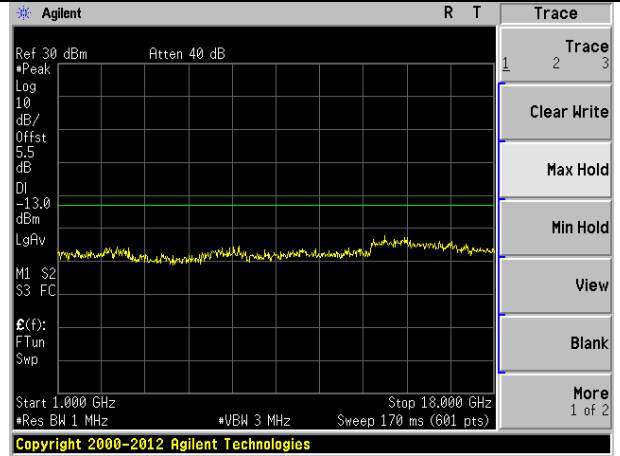
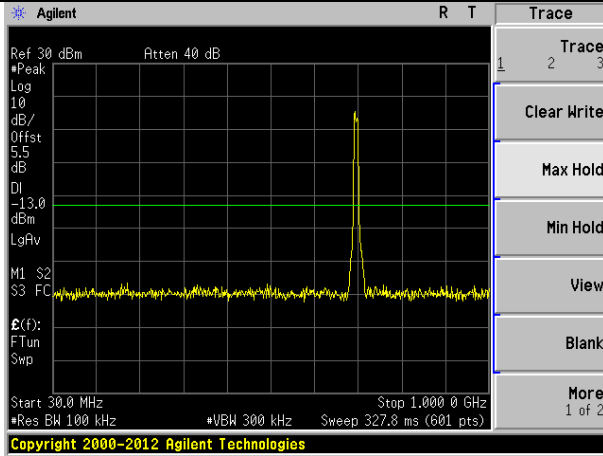

Lowest channel

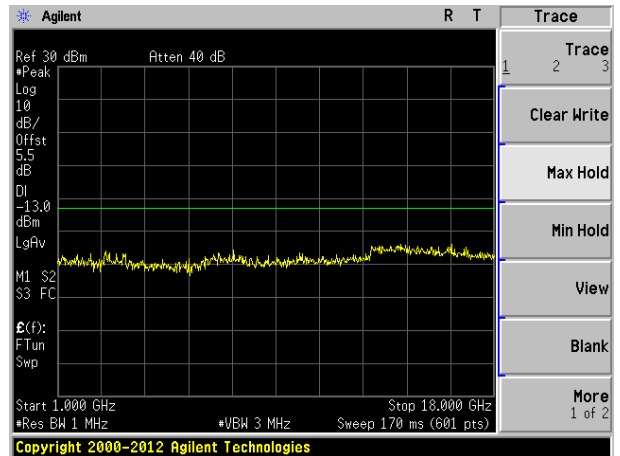
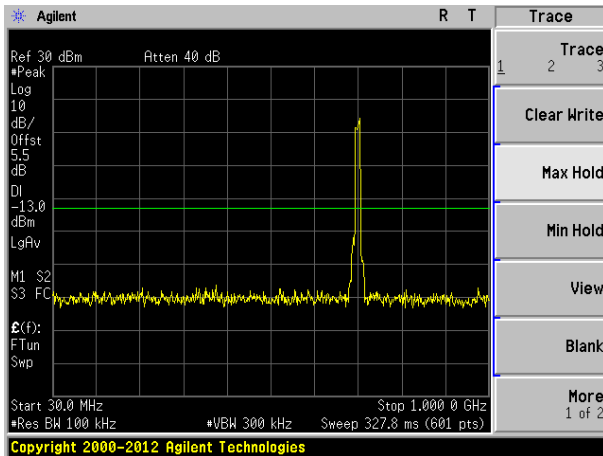

Middle channel

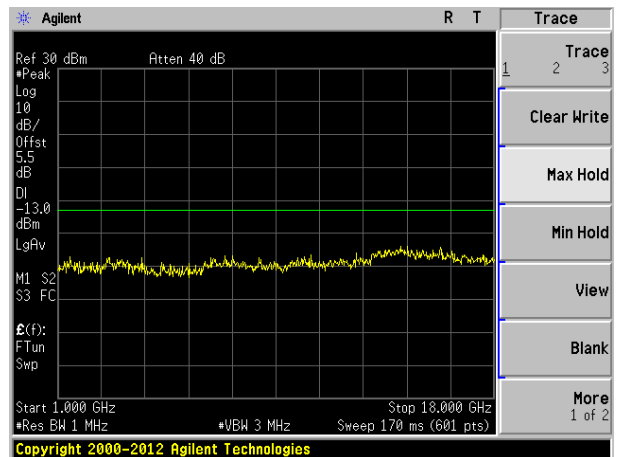
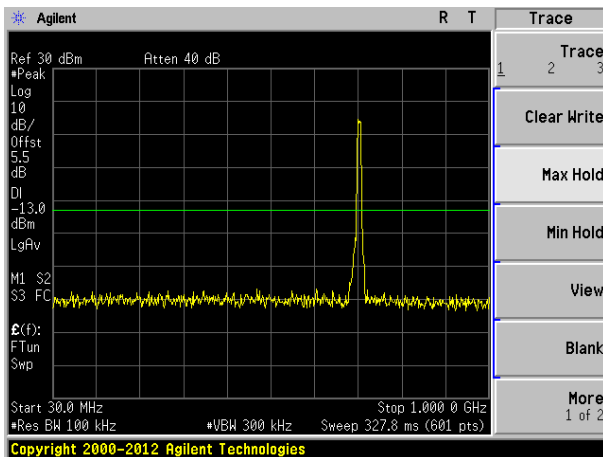

Highest channel

16QAM mode:

Test Mode: LTE Band 2 Channel Bandwidth: 5MHz

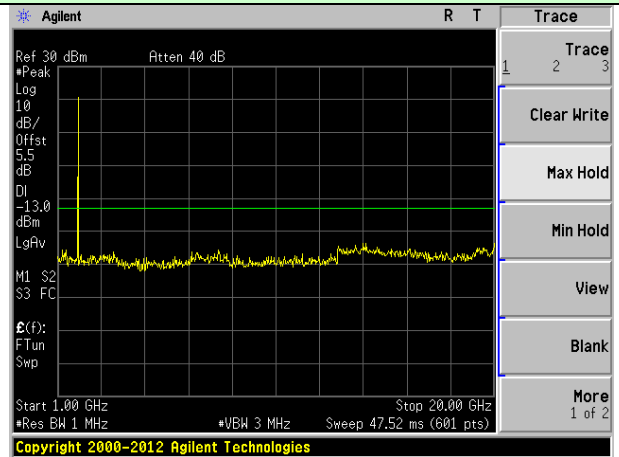
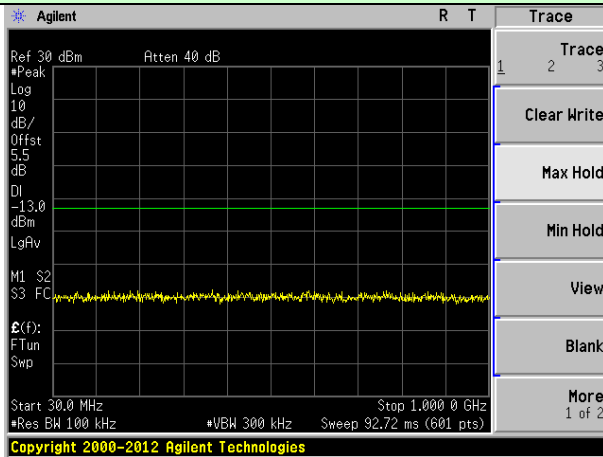

Lowest channel

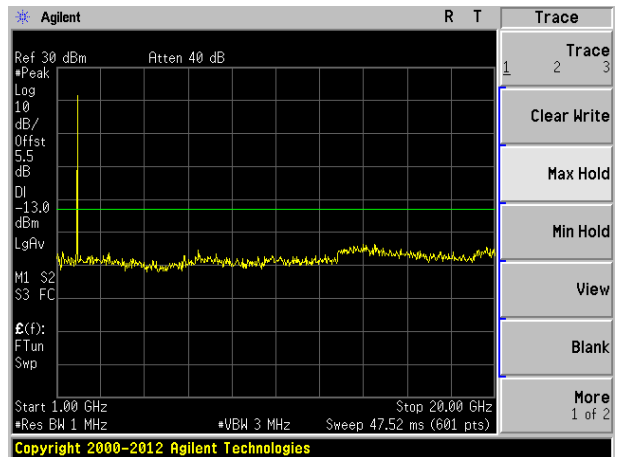
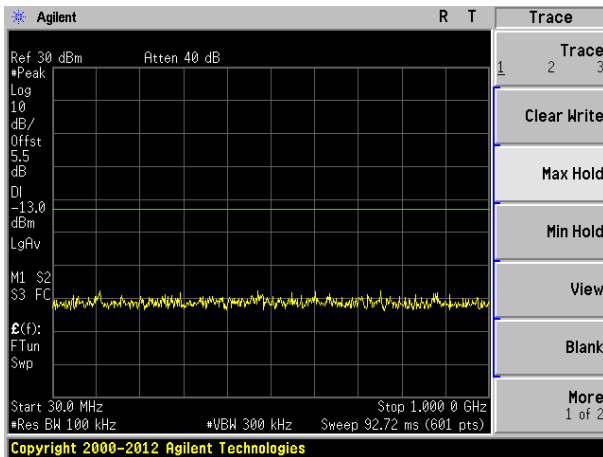

Middle channel

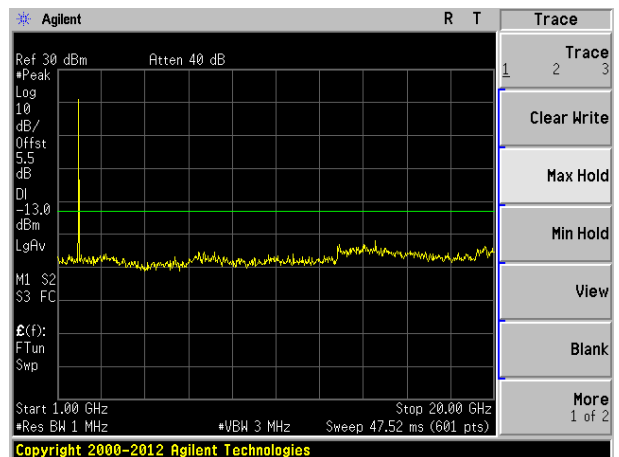
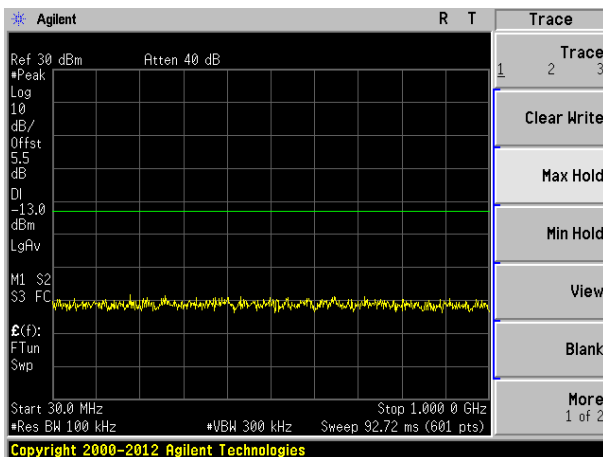

Highest channel

Test Mode: LTE Band 4 Channel Bandwidth: 5MHz

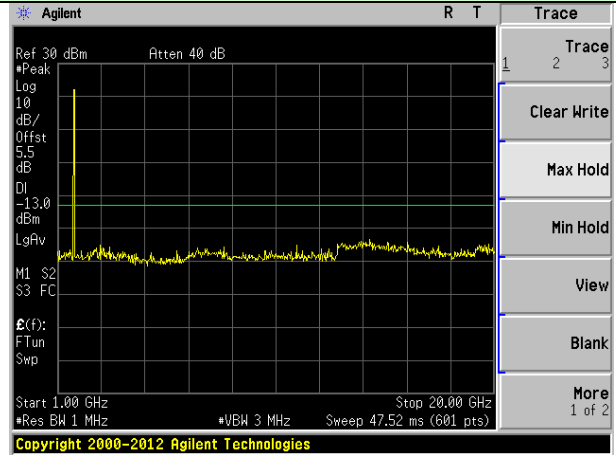
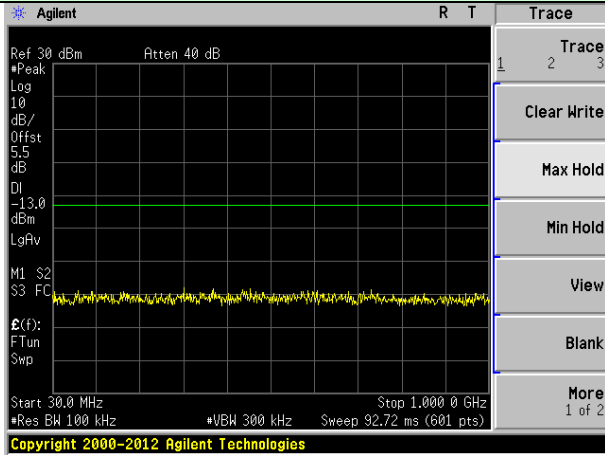

Lowest channel

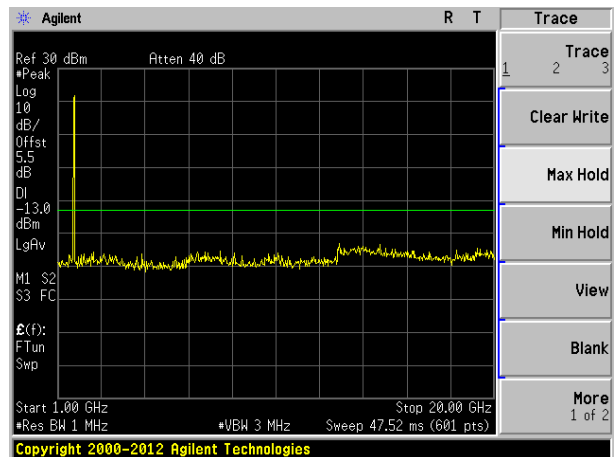
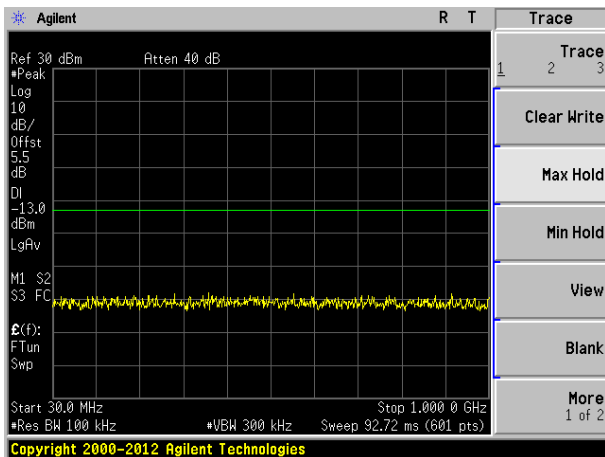

Middle channel

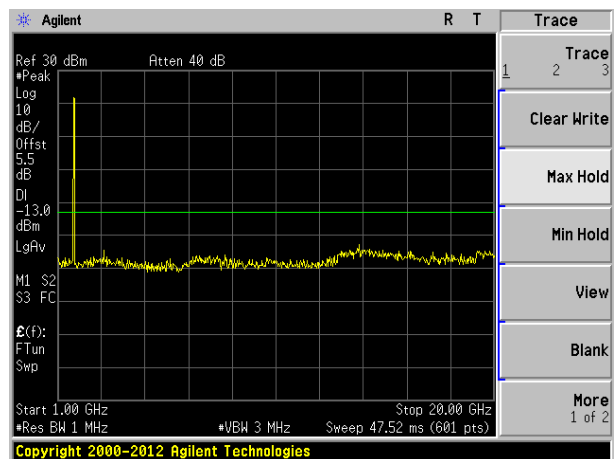
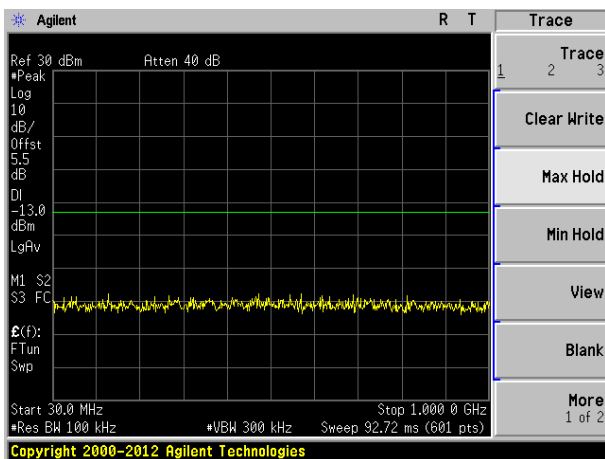

Highest channel

Test Mode: LTE Band 12 Channel Bandwidth: 5MHz

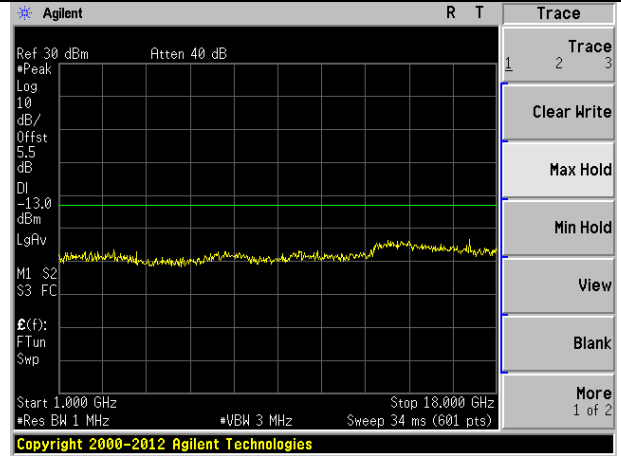
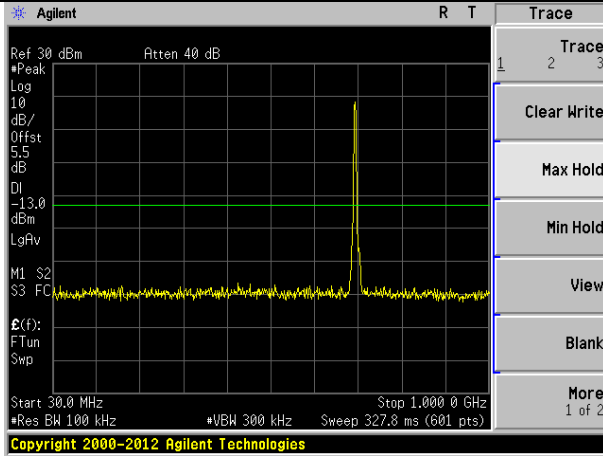

Lowest channel

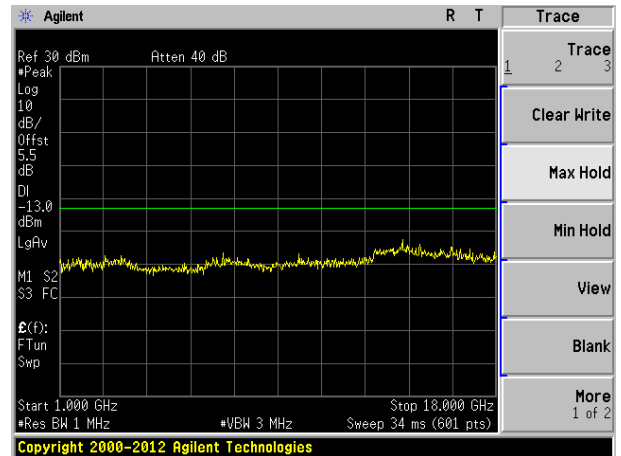
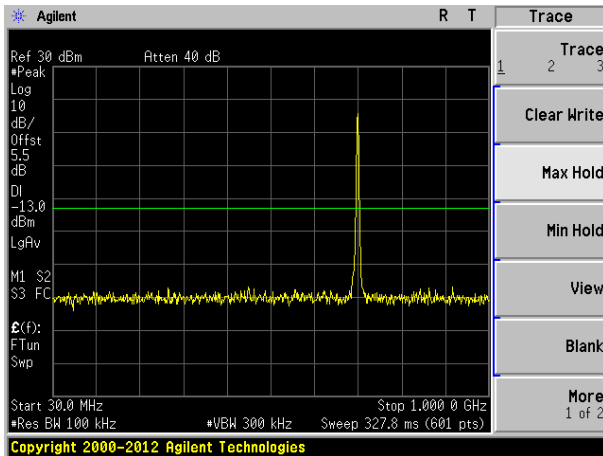

Middle channel

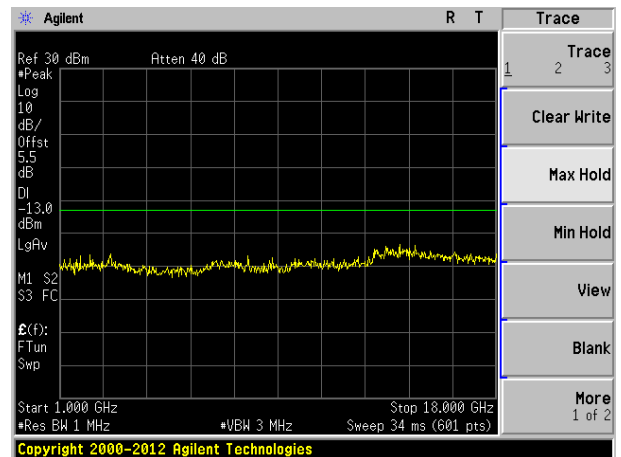
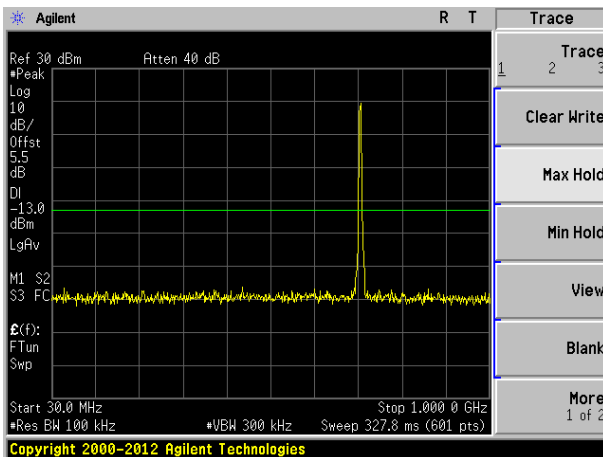

Highest channel

**Band Edge:**  
QPSK mode:

Test Mode: LTE Band 2      Channel Bandwidth: 5MHz

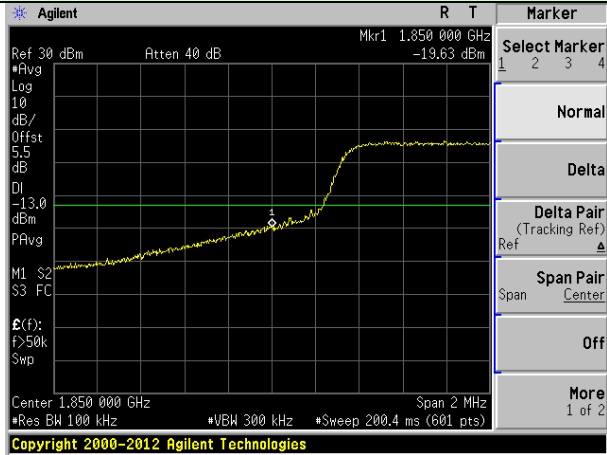

Lowest channel

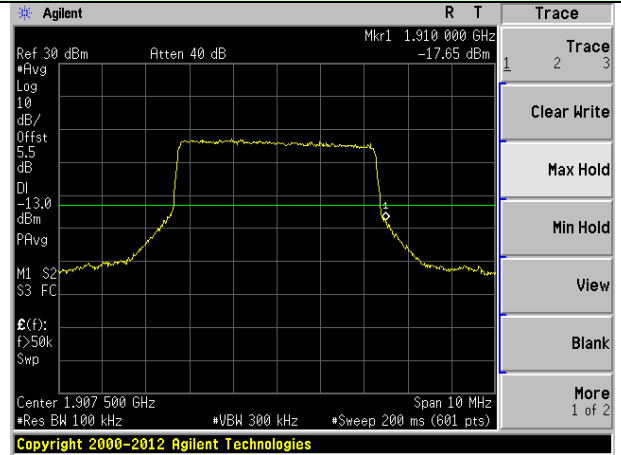

Highest channel

Test Mode: LTE Band 2      Channel Bandwidth: 10MHz

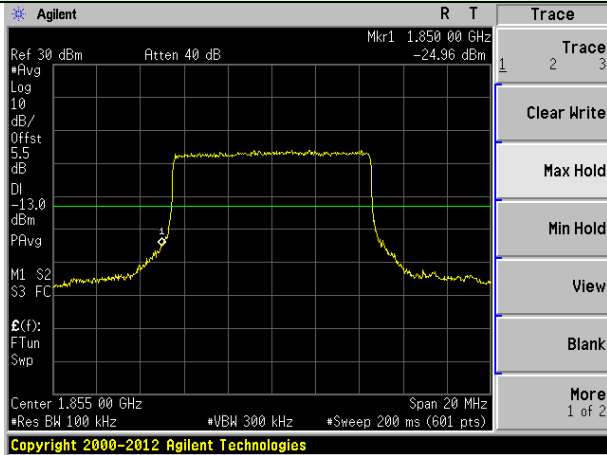

Lowest channel

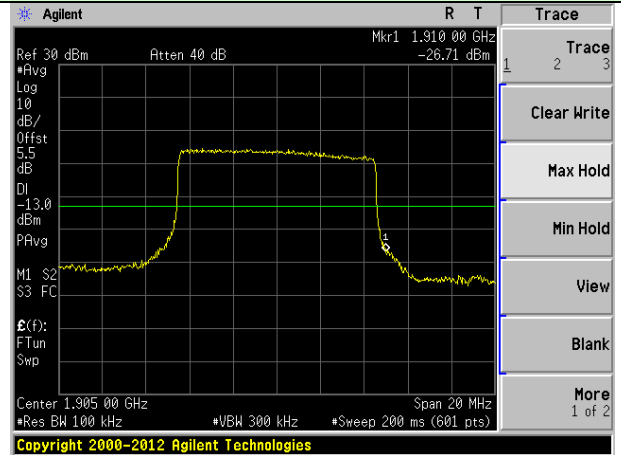

Highest channel

Test Mode: LTE Band 2 Channel Bandwidth: 15MHz

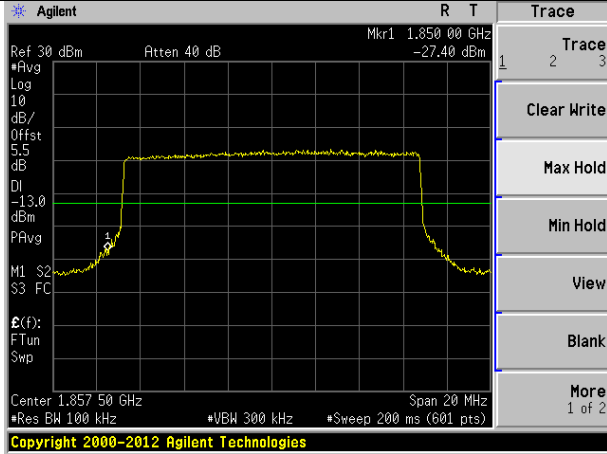

Lowest channel

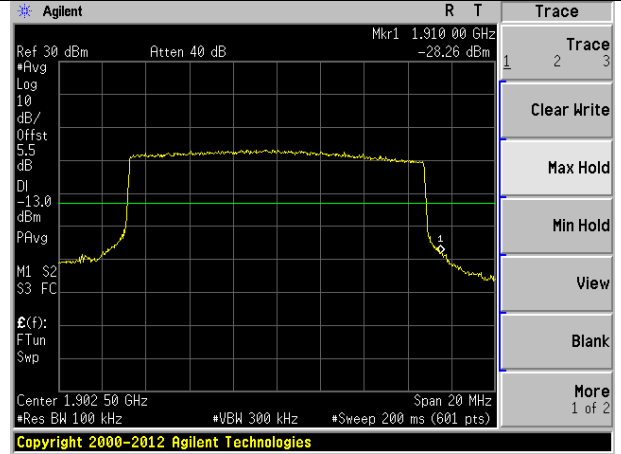

Highest channel

Test Mode: LTE Band 2 Channel Bandwidth: 20MHz

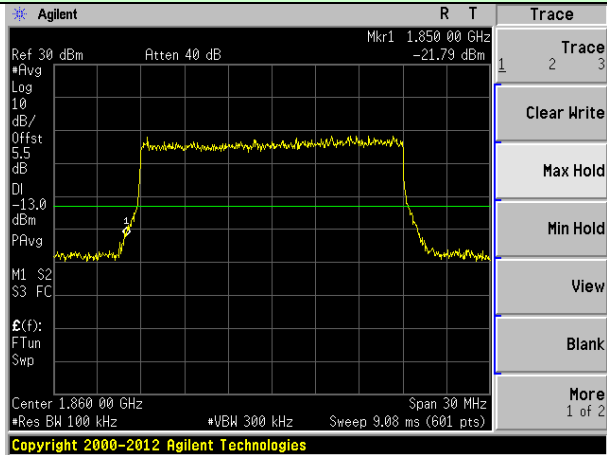

Lowest channel

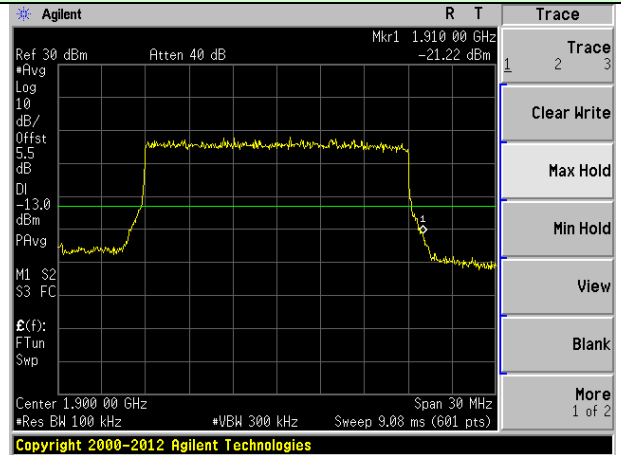

Highest channel

LTE Band 4

5MHz Bandwidth (RB size:1# RB offset:0#)

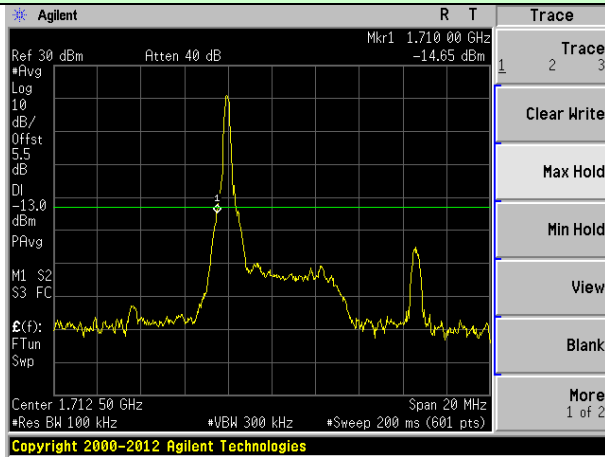

Lowest channel

5MHz Bandwidth (RB size:1# RB offset:24#)

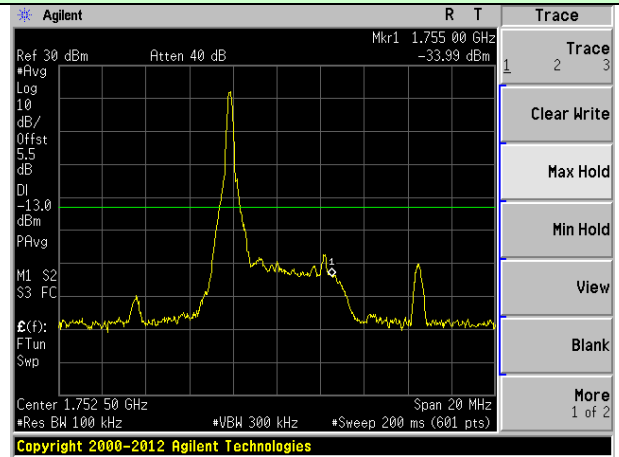

Highest channel

5MHz Bandwidth (RB size:12# RB offset:0#)

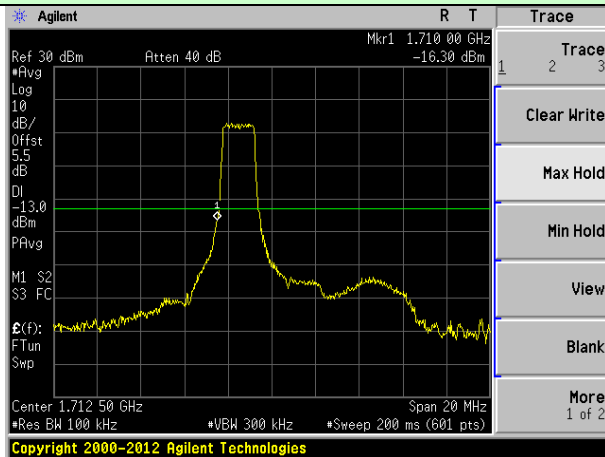

Lowest channel

5MHz Bandwidth (RB size:12# RB offset:13#)

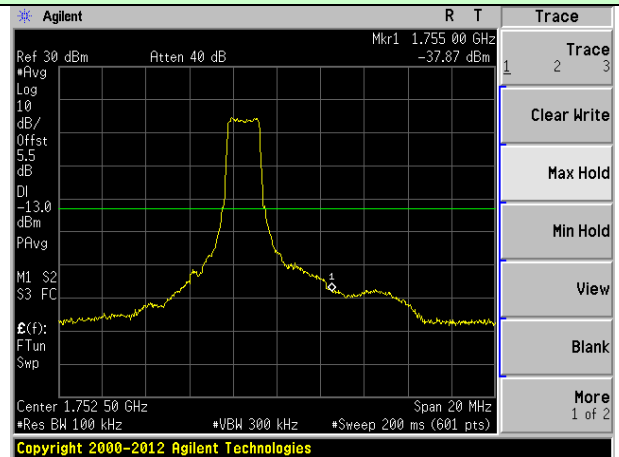

Highest channel

5MHz Bandwidth (RB size:25# RB offset:0#)

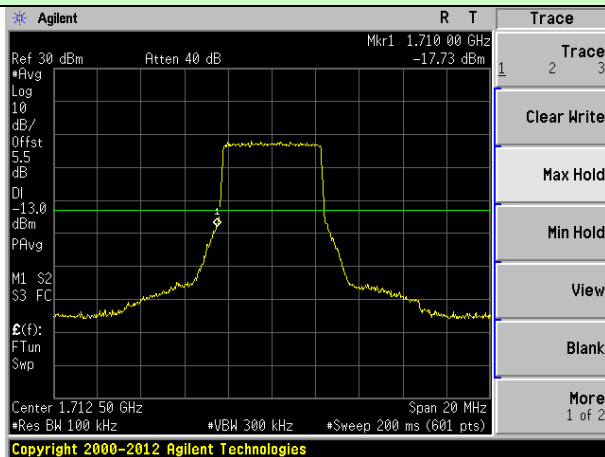

Lowest channel

5MHz Bandwidth (RB size:25# RB offset:0#)

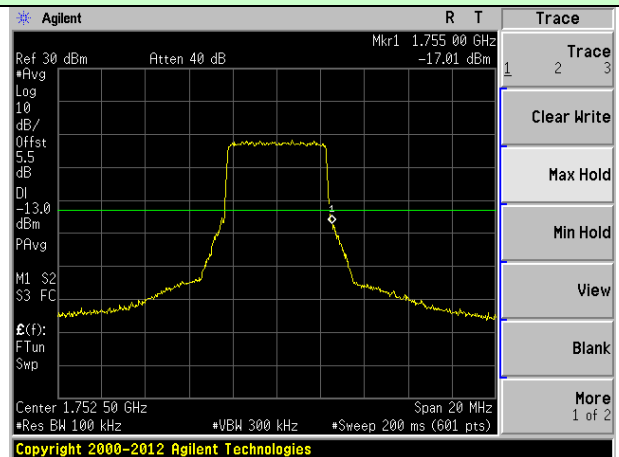

Highest channel

10MHz Bandwidth (RB size:1# RB offset:0#)      10MHz Bandwidth (RB size:1# RB offset:49#)

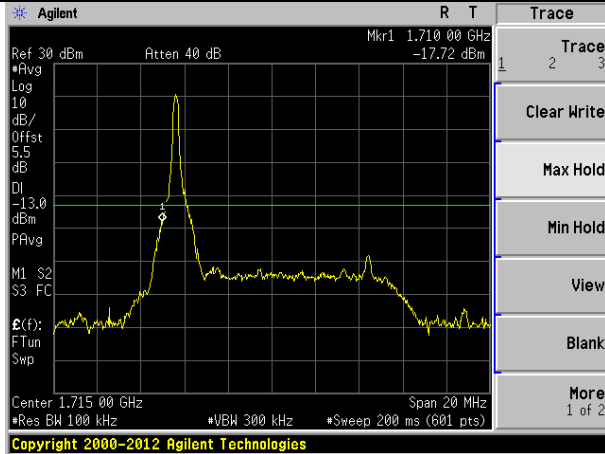

Lowest channel

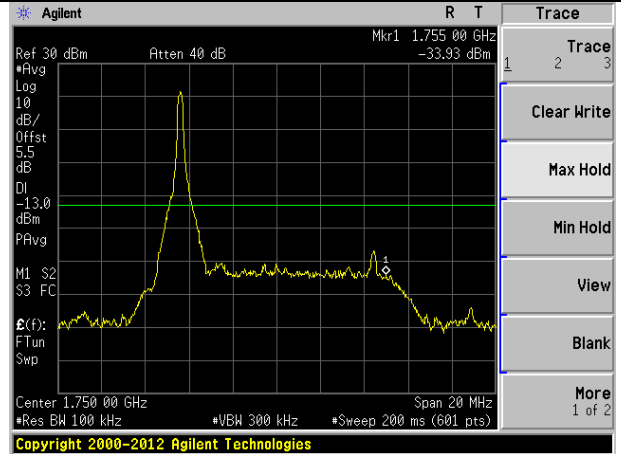

Highest channel

10MHz Bandwidth (RB size:25# RB offset:0#)      10MHz Bandwidth (RB size:25# RB offset:25#)

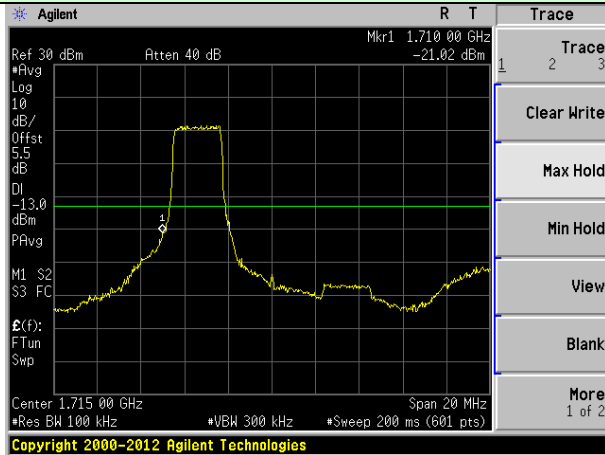

Lowest channel

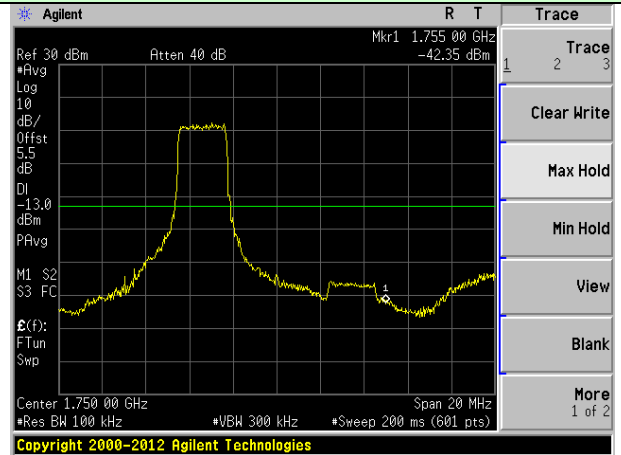

Highest channel

10MHz Bandwidth (RB size:50# RB offset:0#)      10MHz Bandwidth (RB size:50# RB offset:0#)

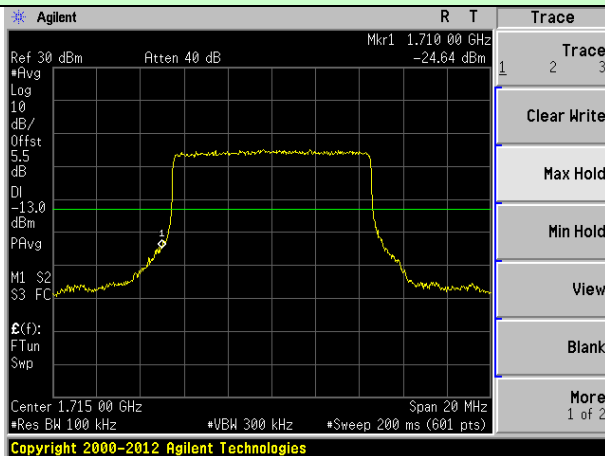

Lowest channel

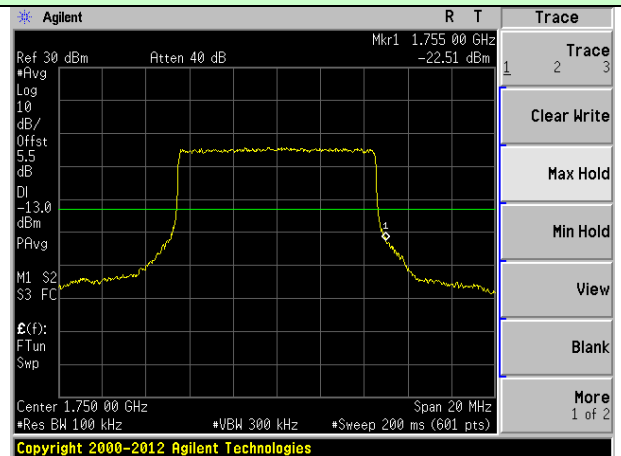

Highest channel



15MHz Bandwidth (RB size:1# RB offset:0#)

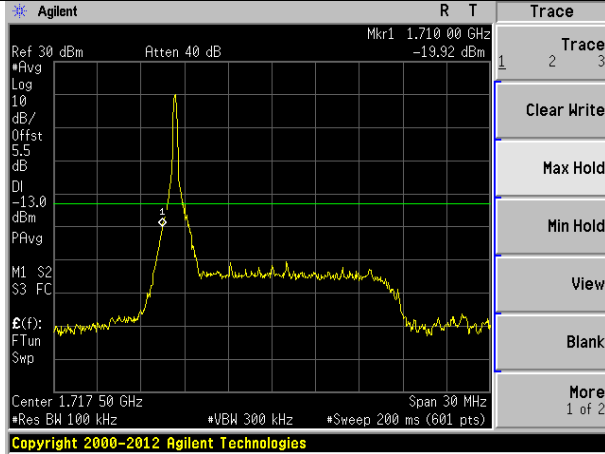

Lowest channel

15MHz Bandwidth (RB size:1# RB offset:74#)

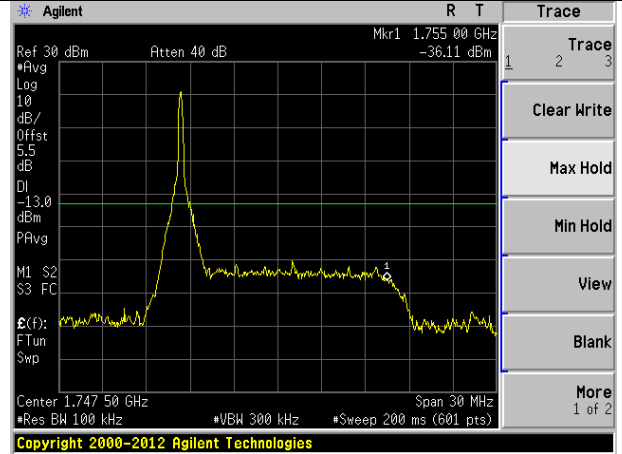

Highest channel

15MHz Bandwidth (RB size:36# RB offset:0#)

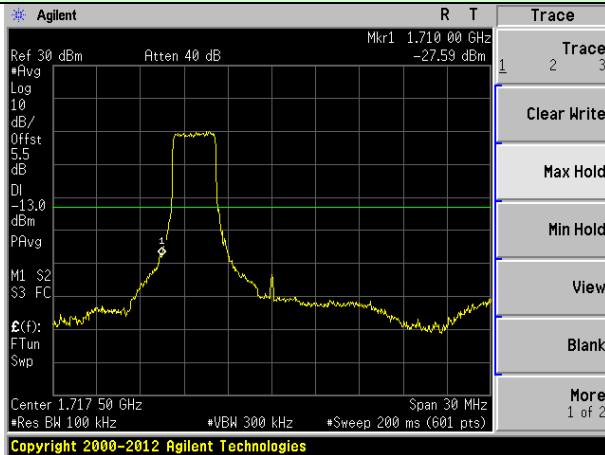

Lowest channel

15MHz Bandwidth (RB size:36# RB offset:39#)

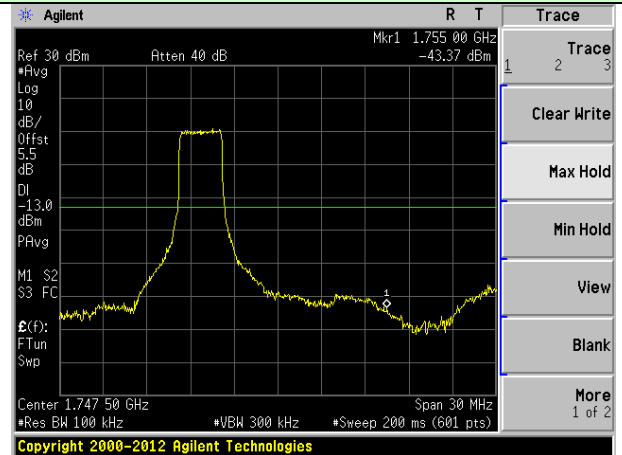

Highest channel

15MHz Bandwidth (RB size:75# RB offset:0#)

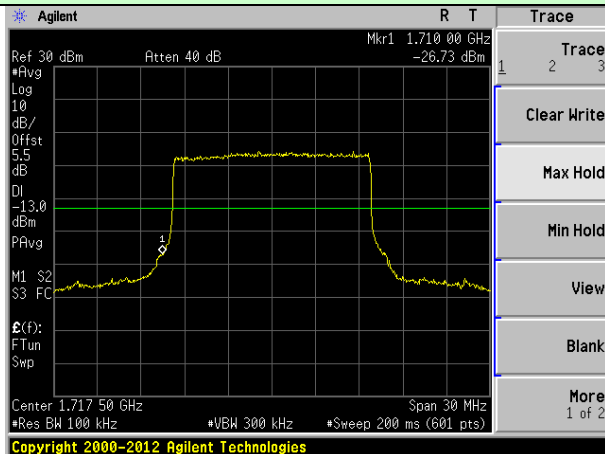

Lowest channel

15MHz Bandwidth (RB size:75# RB offset:0#)

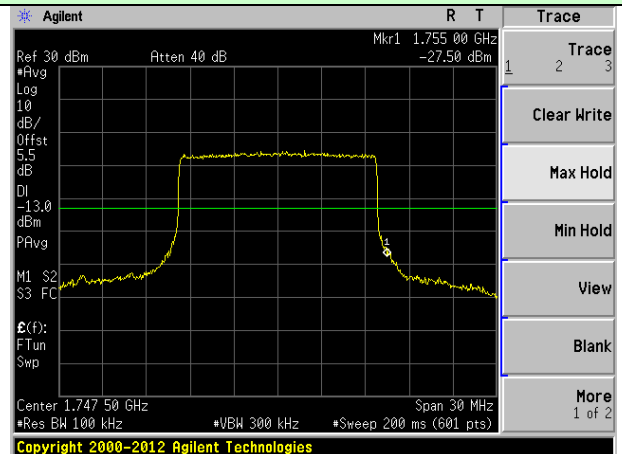

Highest channel

20MHz Bandwidth (RB size:1# RB offset:0#)      20MHz Bandwidth (RB size:1# RB offset:99#)

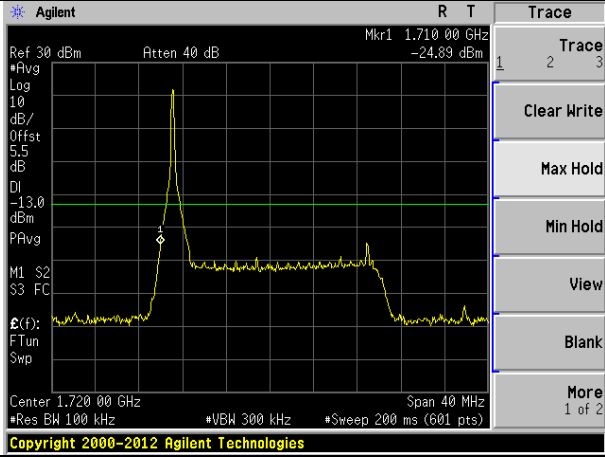

Lowest channel

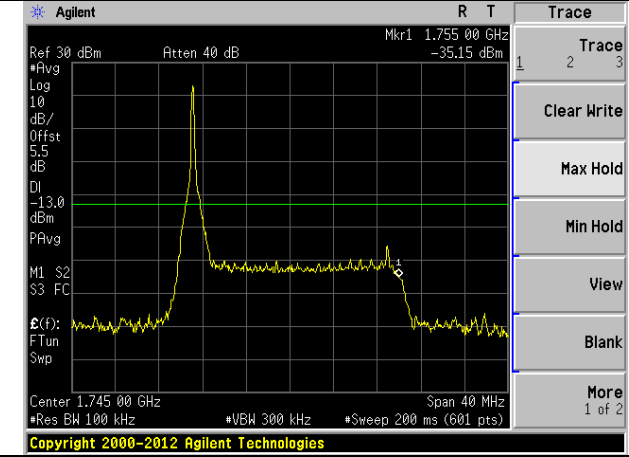

Highest channel

20MHz Bandwidth (RB size:50# RB offset:0#)      20MHz Bandwidth (RB size:50# RB offset:50#)

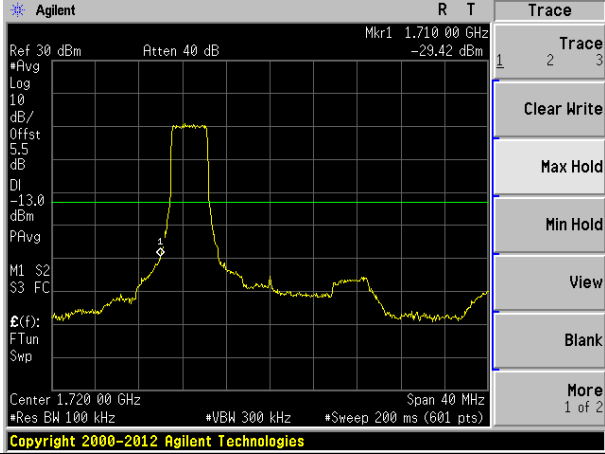

Lowest channel

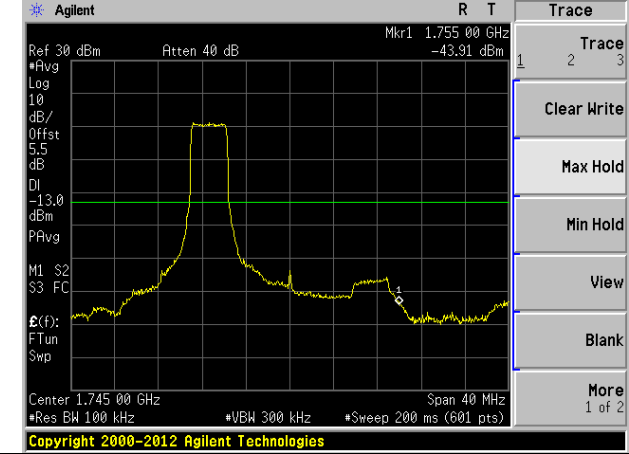

Highest channel

20MHz Bandwidth (RB size:100# RB offset:0#)      20MHz Bandwidth (RB size:100# RB offset:0#)

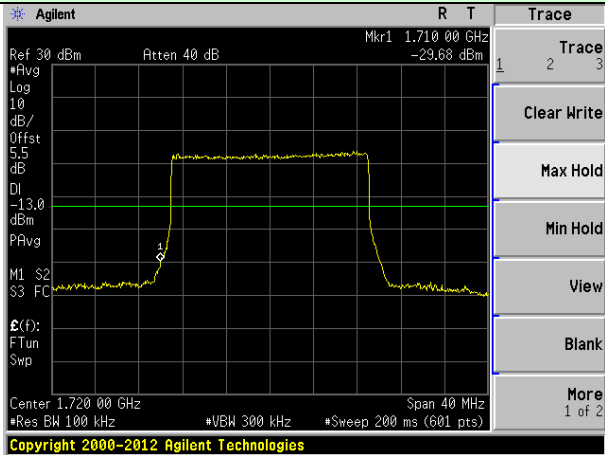

Lowest channel

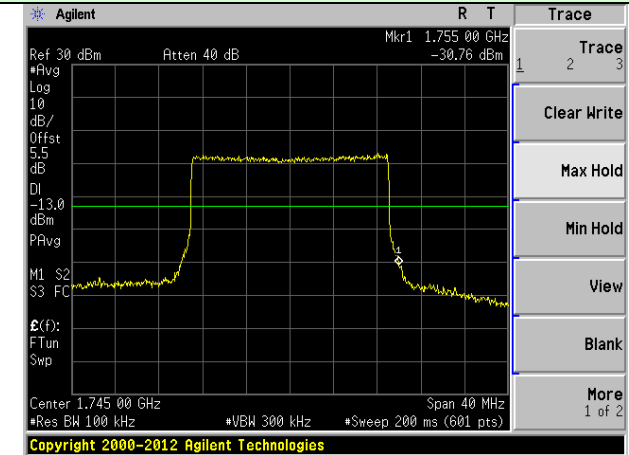

Highest channel

LTE Band 12(QPSK mode):

5MHz Bandwidth (RB size:1# RB offset:0#)      5MHz Bandwidth (RB size:1# RB offset:24#)

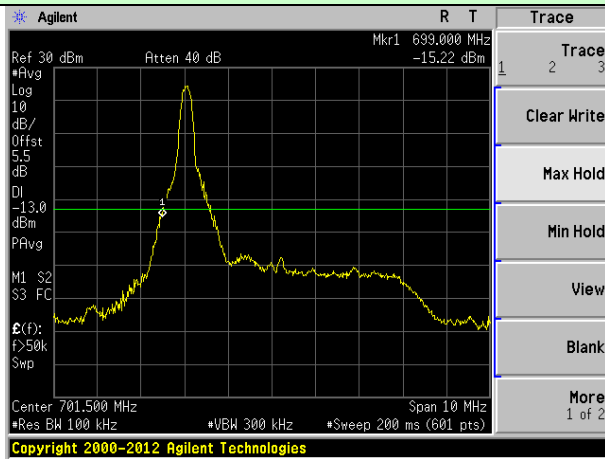

Lowest channel

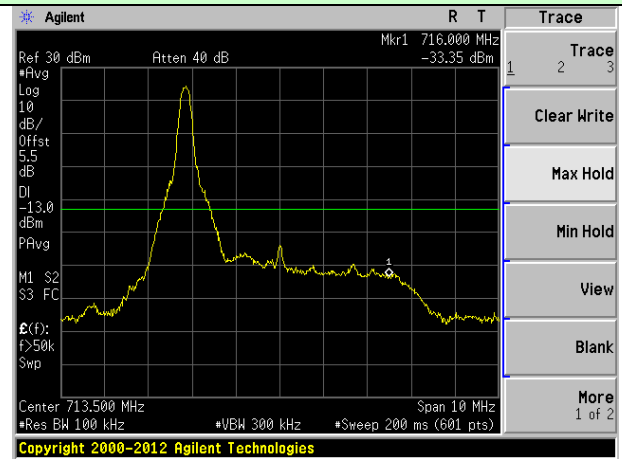

Highest channel

5MHz Bandwidth (RB size:12# RB offset:0#)      5MHz Bandwidth (RB size:12# RB offset:13#)

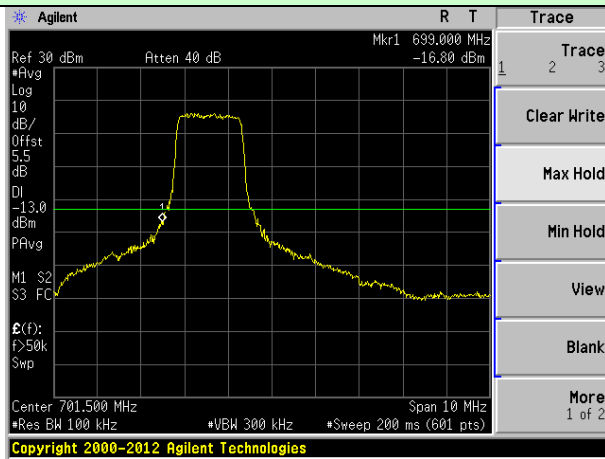

Lowest channel

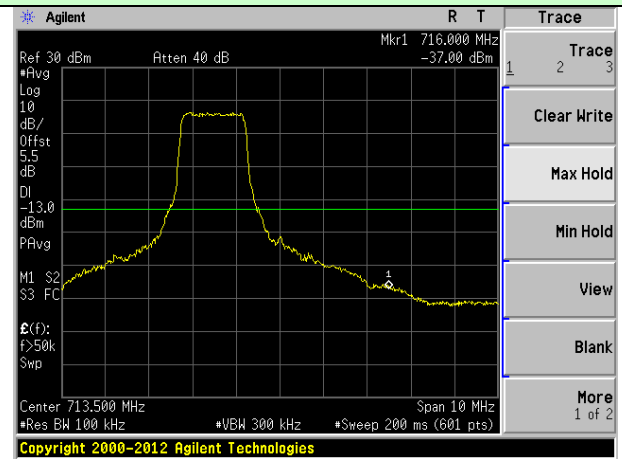

Highest channel

5MHz Bandwidth (RB size:25# RB offset:0#)      5MHz Bandwidth (RB size:25# RB offset:0#)

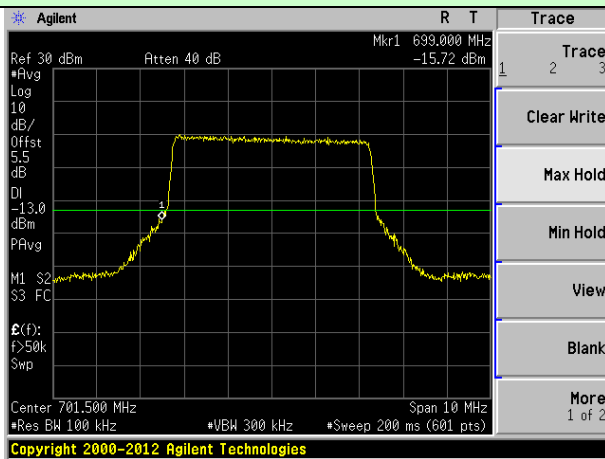

Lowest channel

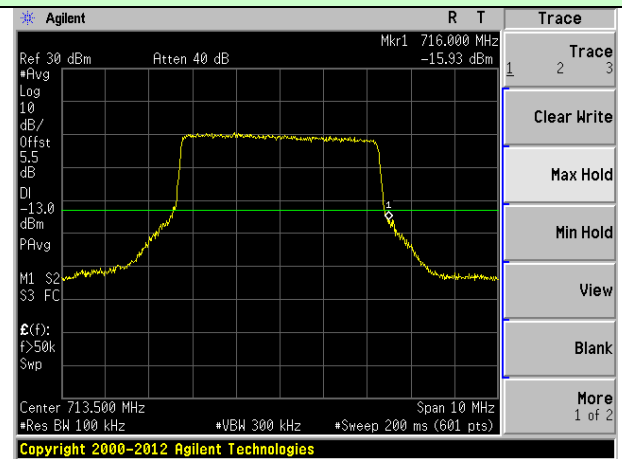

Highest channel

10MHz Bandwidth (RB size:1# RB offset:0#)

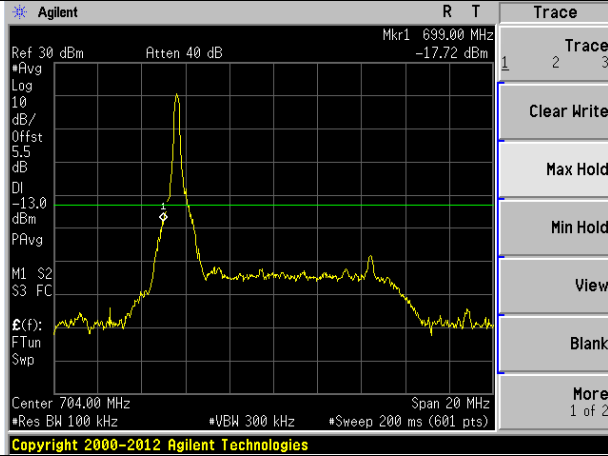

Lowest channel

10MHz Bandwidth (RB size:1# RB offset:49#)

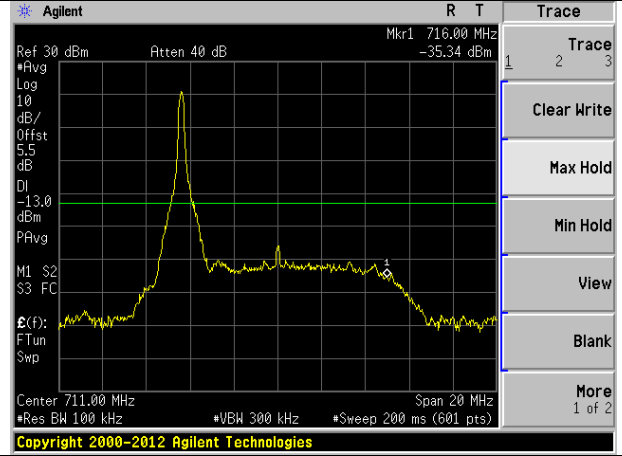

Highest channel

10MHz Bandwidth (RB size:25# RB offset:0#)

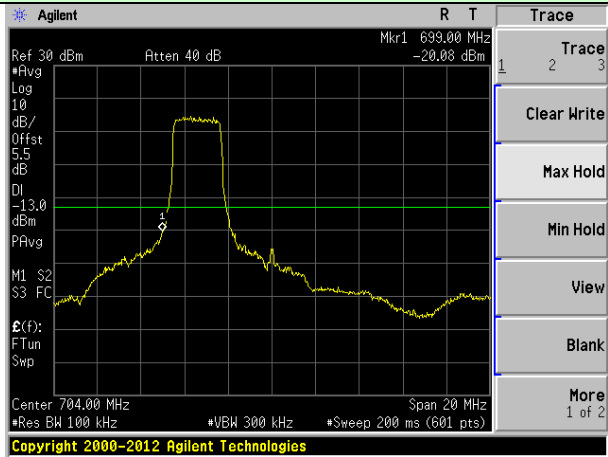

Lowest channel

10MHz Bandwidth (RB size:25# RB offset:25#)

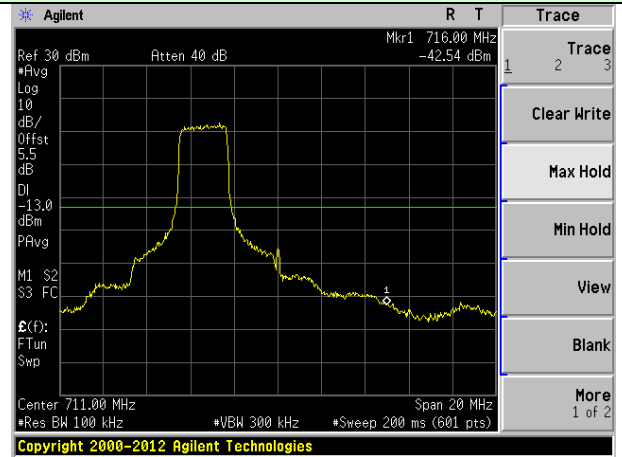

Highest channel

10MHz Bandwidth (RB size:50# RB offset:0#)

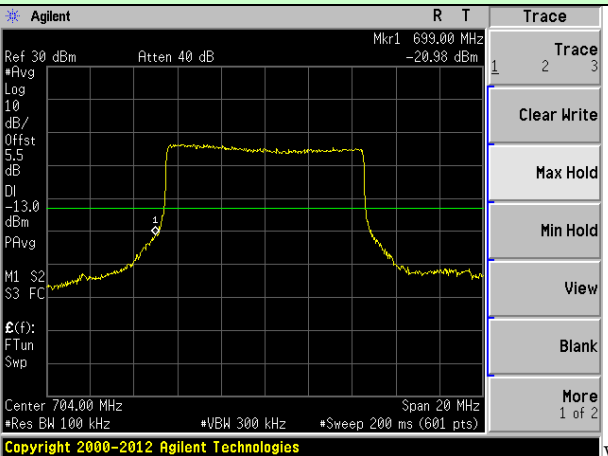

Lowest channel

10MHz Bandwidth (RB size:50# RB offset:0#)

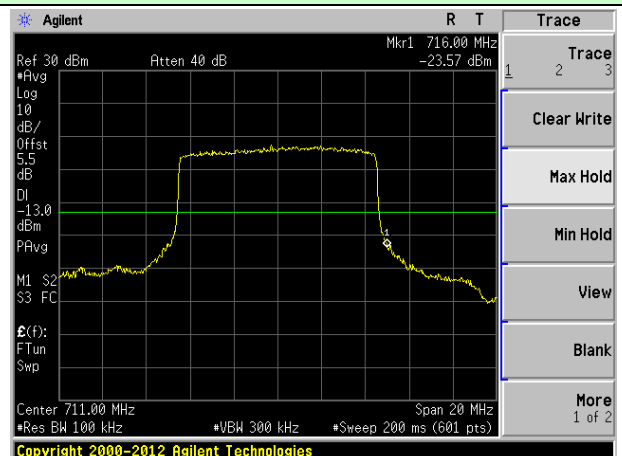

Highest channel

LTE Band 4(16QAM mode):

5MHz Bandwidth (RB size:1# RB offset:0#)      5MHz Bandwidth (RB size:1# RB offset:24#)

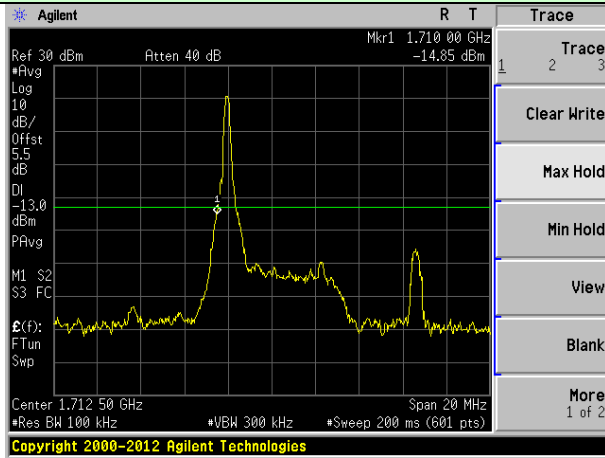

Lowest channel

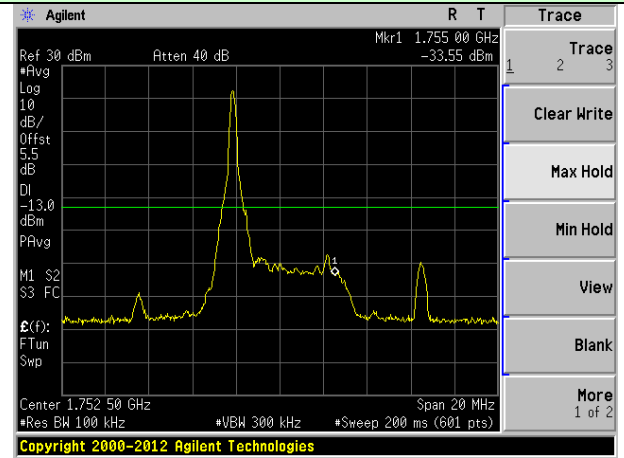

Highest channel

5MHz Bandwidth (RB size:12# RB offset:0#)      5MHz Bandwidth (RB size:12# RB offset:13#)

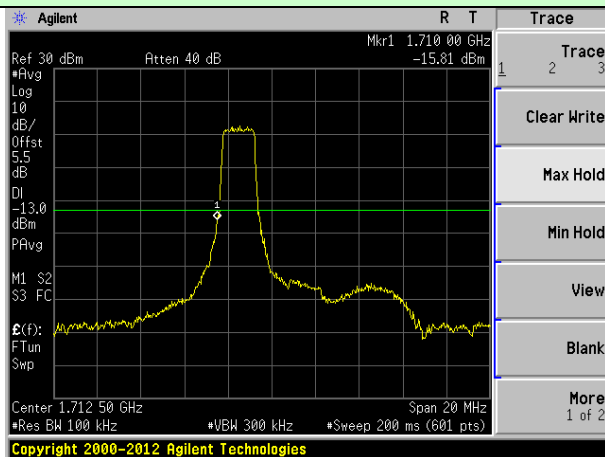

Lowest channel

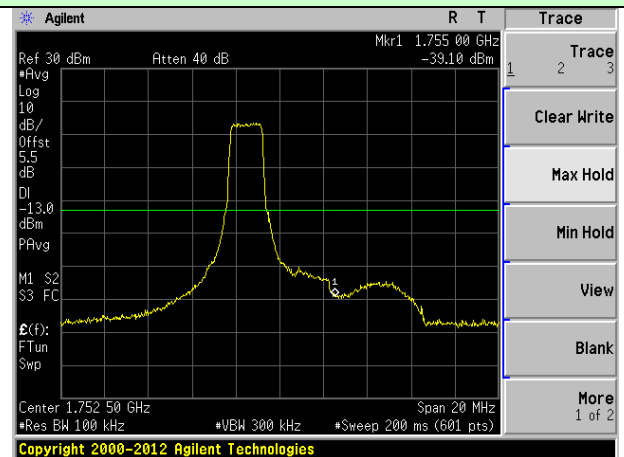

Highest channel

5MHz Bandwidth (RB size:25# RB offset:0#)      5MHz Bandwidth (RB size:25# RB offset:0#)

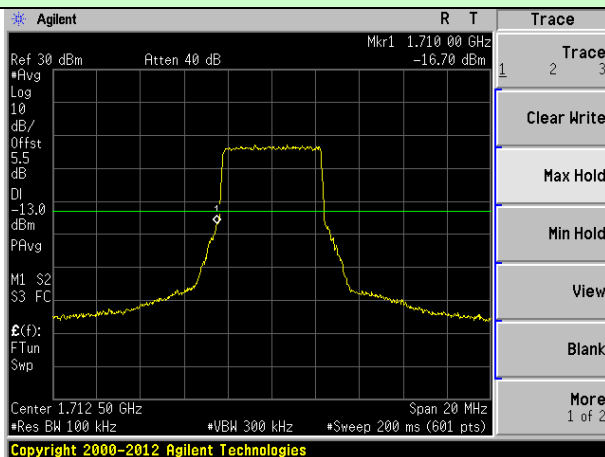

Lowest channel

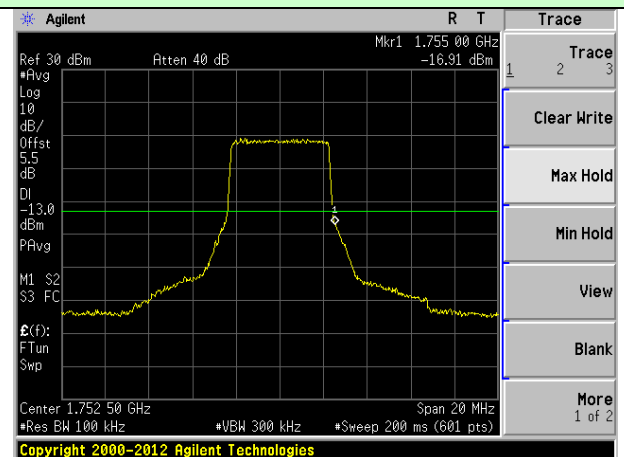

Highest channel

LTE Band 12(16QAM mode):

5MHz Bandwidth (RB size:1# RB offset:0#)

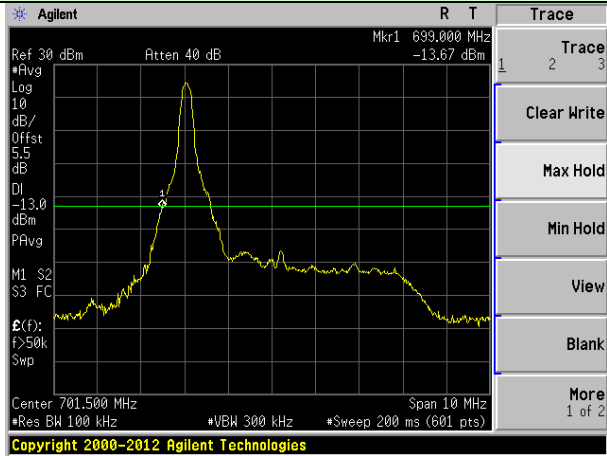

Lowest channel

5MHz Bandwidth (RB size:1# RB offset:24#)

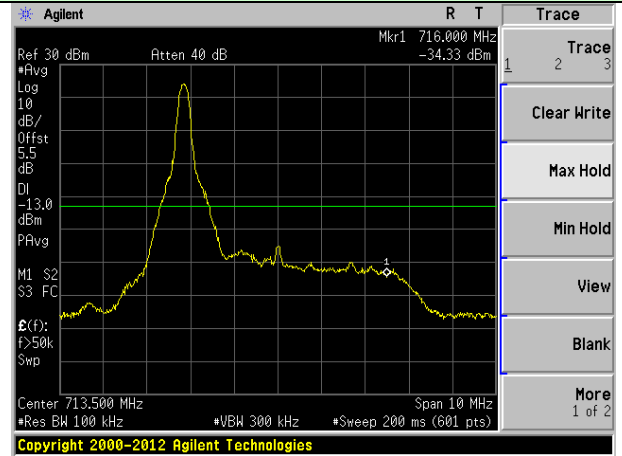

Highest channel

5MHz Bandwidth (RB size:12# RB offset:0#)

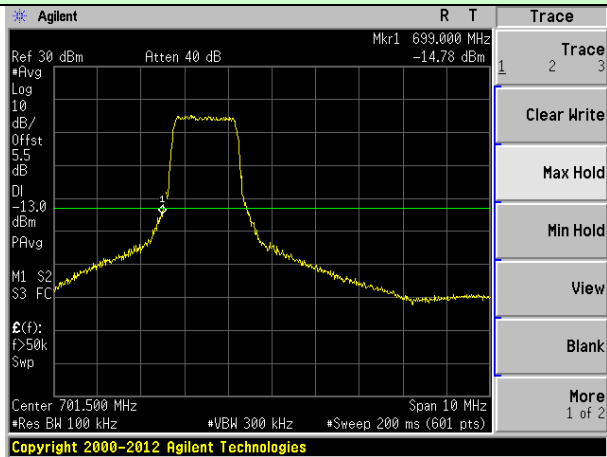

Lowest channel

5MHz Bandwidth (RB size:12# RB offset:13#)

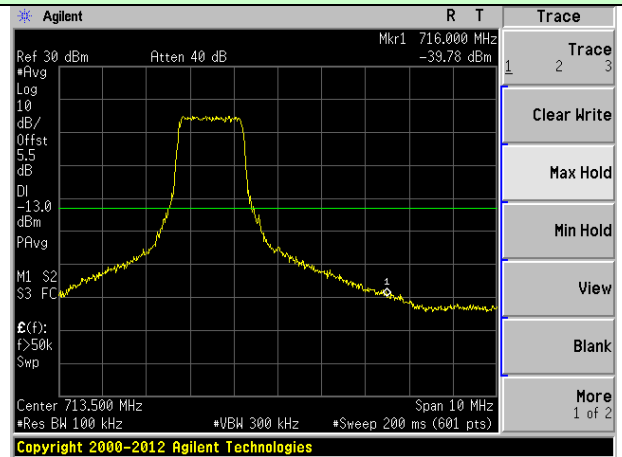

Highest channel

5MHz Bandwidth (RB size:25# RB offset:0#)

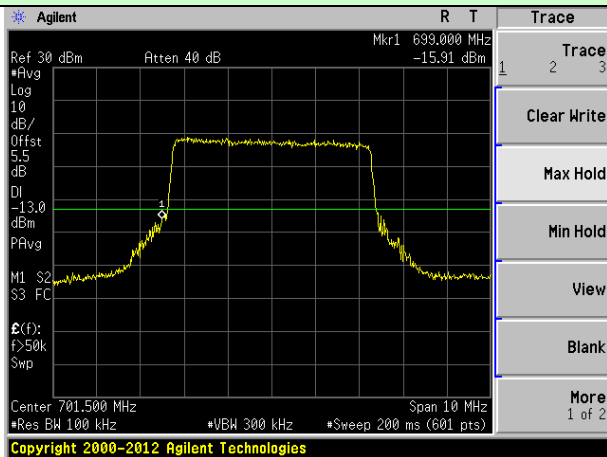

Lowest channel

5MHz Bandwidth (RB size:25# RB offset:0#)

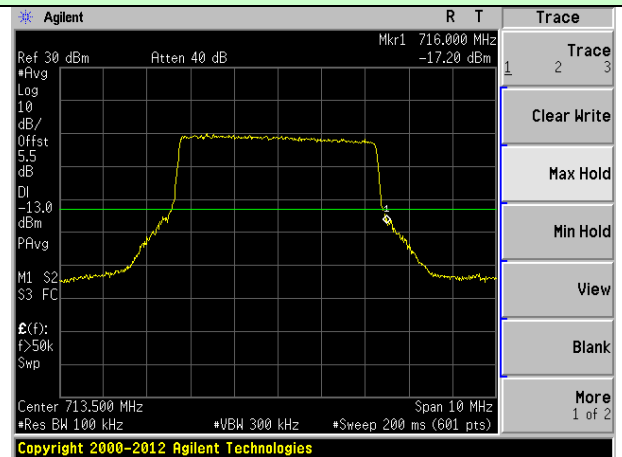

Highest channel

## 6.7 ERP, EIRP Measurement

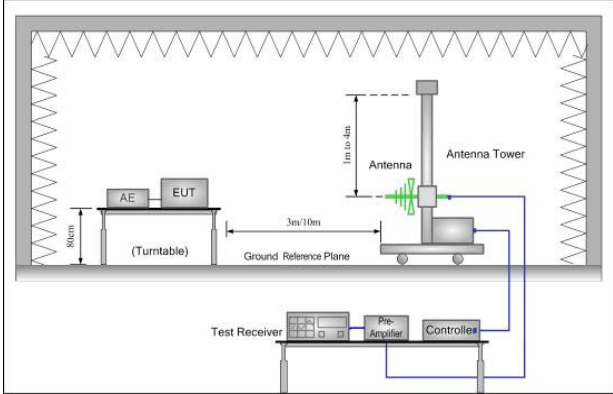
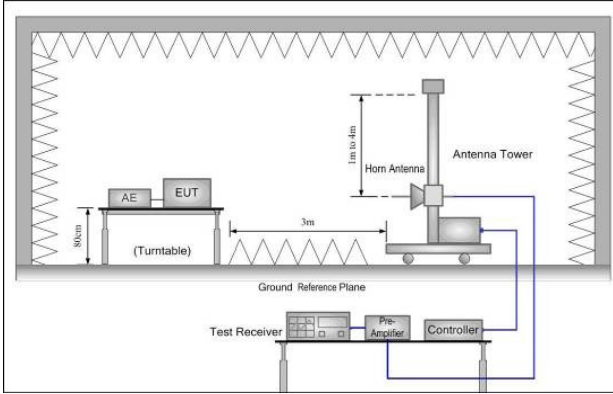
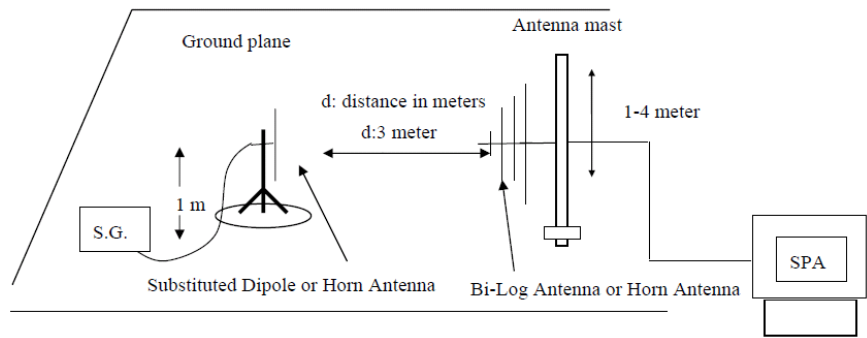
Test Requirement:	Part 24.238 (a); Part 27.50(c)(10)/(d)(4)
Test Method:	FCC part2.1046
Limit:	LTE Band 2: 2W (EIRP) LTE Band 4: 1W (EIRP) LTE Band 12: 3W (ERP)
Test setup:	<p>Below 1GHz</p>  <p>Above 1GHz</p>  <p>Substituted method:</p> 

<p>Test Procedure:</p>	<ol style="list-style-type: none"> <li>1. The EUT was placed on an non-conductive turntable using a non-conductive support. The radiated emission at the fundamental frequency was measured at 3 m with a test antenna and EMI spectrum analyzer.</li> <li>2. During the measurement, the EUT was communication with the station. The highest emission was recorded with the rotation of the turntable and the lowering of the test antenna from 4m to 1m. The reading was recorded and the field strength (E in dBuV/m) was calculated.</li> <li>3. ERP in frequency band 777–787MHz were measured using a substitution method. The EUT was replaced by dipole antenna connected, the S.G. output was recorded and ERP was calculated asfollows:  <math display="block">\text{ERP} = \text{S.G. output (dBm)} + \text{Antenna Gain (dBd)} - \text{Cable Loss (dB)}</math> </li> <li>4. EIRP in frequency band 1710–1755MHz were measured using a substitution method. The EUT was replaced by or horn antenna connected, the S.G. output was recorded and EIRP was calculated as follows:  <math display="block">\text{EIRP} = \text{S.G. output (dBm)} + \text{Antenna Gain (dBi)} - \text{Cable Loss (dB)}</math> </li> </ol>
<p>Test Instruments:</p>	<p>Refer to section 6.0 for details</p>
<p>Test mode:</p>	<p>Refer to section 6.1 for details</p>
<p>Test results:</p>	<p>Pass</p>

Measurement Data



QPSK mode:

EUT mode	Channel	EUT Pol.	Antenna Pol.	EIRP(dBm)	Limit (dBm)	Result
LTE Band 2 (5MHz)	Lowest	H	V	22.52	33.00	Pass
			H	20.47		
		E1	V	22.18		
			H	19.79		
		E2	V	21.39		
			H	18.55		
	Middle	H	V	22.50	33.00	Pass
			H	19.80		
		E1	V	22.04		
			H	19.57		
		E2	V	21.89		
			H	18.77		
	Highest	H	V	22.24	33.00	Pass
			H	19.95		
		E1	V	22.01		
			H	19.68		
		E2	V	21.75		
			H	19.16		

EUT mode	Channel	EUT Pol.	Antenna Pol.	EIRP (dBm)	Limit (dBm)	Result
LTE Band 2 (10MHz)	Lowest	H	V	22.62	33.00	Pass
			H	20.59		
		E1	V	22.32		
			H	19.93		
		E2	V	21.55		
			H	18.73		
	Middle	H	V	22.65	33.00	Pass
			H	19.98		
		E1	V	22.24		
			H	19.79		
		E2	V	22.08		
			H	18.96		
	Highest	H	V	22.39	33.00	Pass
			H	20.11		
		E1	V	22.19		
			H	19.87		
		E2	V	21.88		
			H	19.30		

EUT mode	Channel	EUT Pol.	Antenna Pol.	EIRP (dBm)	Limit (dBm)	Result
LTE Band 2 (15MHz)	Lowest	H	V	22.70	33.00	Pass
			H	20.68		
		E1	V	22.42		
			H	20.05		
		E2	V	21.67		
			H	18.86		
	Middle	H	V	22.77	33.00	Pass
			H	20.13		
		E1	V	22.39		
			H	19.95		
		E2	V	22.21		
			H	19.11		
	Highest	H	V	22.51	33.00	Pass
			H	20.23		
		E1	V	22.32		
			H	20.02		
		E2	V	21.98		
			H	19.41		

EUT mode	Channel	EUT Pol.	Antenna Pol.	EIRP (dBm)	Limit (dBm)	Result
LTE Band 2 (20MHz)	Lowest	H	V	22.77	33.00	Pass
			H	20.75		
		E1	V	22.50		
			H	20.13		
		E2	V	21.77		
			H	18.96		
	Middle	H	V	22.86	33.00	Pass
			H	20.23		
		E1	V	22.51		
			H	20.08		
		E2	V	22.32		
			H	19.22		
	Highest	H	V	22.59	33.00	Pass
			H	20.33		
		E1	V	22.42		
			H	20.13		
		E2	V	22.05		
			H	19.50		

EUT mode	Channel	EUT Pol.	Antenna Pol.	EIRP(dBm)	Limit (dBm)	Result
LTE Band 4 (5MHz)	Lowest	H	V	22.71	30.00	Pass
			H	20.69		
		E1	V	22.42		
			H	20.05		
		E2	V	21.68		
			H	18.87		
	Middle	H	V	22.77	30.00	Pass
			H	20.13		
		E1	V	22.40		
			H	19.96		
		E2	V	22.22		
			H	19.12		
	Highest	H	V	22.51	30.00	Pass
			H	20.24		
		E1	V	22.33		
			H	20.03		
		E2	V	21.98		
			H	19.42		

EUT mode	Channel	EUT Pol.	Antenna Pol.	EIRP(dBm)	Limit (dBm)	Result
LTE Band 4 (10MHz)	Lowest	H	V	22.59	30.00	Pass
			H	20.55		
		E1	V	22.28		
			H	19.89		
		E2	V	21.50		
			H	18.67		
	Middle	H	V	22.61	30.00	Pass
			H	19.93		
		E1	V	22.18		
			H	19.72		
		E2	V	22.02		
			H	18.90		
	Highest	H	V	22.35	30.00	Pass
			H	20.06		
		E1	V	22.13		
			H	19.82		
		E2	V	21.84		
			H	19.26		

EUT mode	Channel	EUT Pol.	Antenna Pol.	EIRP(dBm)	Limit (dBm)	Result
LTE Band 4 (15MHz)	Lowest	H	V	22.55	30.00	Pass
			H	20.51		
		E1	V	22.23		
			H	19.84		
		E2	V	21.44		
			H	18.61		
	Middle	H	V	22.55	30.00	Pass
			H	19.86		
		E1	V	22.11		
			H	19.64		
		E2	V	21.95		
			H	18.83		
	Highest	H	V	22.29	30.00	Pass
			H	20.00		
		E1	V	22.07		
			H	19.75		
		E2	V	21.79		
			H	19.21		

EUT mode	Channel	EUT Pol.	Antenna Pol.	EIRP(dBm)	Limit (dBm)	Result
LTE Band 4 (20MHz)	Lowest	H	V	21.17	30.00	Pass
			H	18.69		
		E1	V	21.52		
			H	18.44		
		E2	V	20.92		
			H	17.97		
	Middle	H	V	22.08	30.00	Pass
			H	19.67		
		E1	V	21.90		
			H	19.41		
		E2	V	21.43		
			H	18.19		
	Highest	H	V	21.89	30.00	Pass
			H	19.81		
		E1	V	21.85		
			H	19.34		
		E2	V	21.31		
			H	18.70		



EUT mode	Channel	EUT Pol.	Antenna Pol.	ERP(dBm)	Limit (dBm)	Result
LTE Band 12 (5MHz)	Lowest	H	V	22.75	34.77	Pass
			H	20.73		
		E1	V	22.47		
			H	20.10		
		E2	V	21.74		
			H	18.93		
	Middle	H	V	22.83	34.77	Pass
			H	20.20		
		E1	V	22.47		
			H	20.03		
		E2	V	22.28		
			H	19.19		
	Highest	H	V	22.57	34.77	Pass
			H	20.30		
		E1	V	22.39		
			H	20.09		
		E2	V	22.03		
			H	19.47		

EUT mode	Channel	EUT Pol.	Antenna Pol.	ERP(dBm)	Limit (dBm)	Result
LTE Band 12 (10MHz)	Lowest	H	V	22.69	34.77	Pass
			H	20.66		
		E1	V	22.40		
			H	20.02		
		E2	V	21.65		
			H	18.83		
	Middle	H	V	22.75	34.77	Pass
			H	20.10		
		E1	V	22.36		
			H	19.92		
		E2	V	22.18		
			H	19.08		
	Highest	H	V	22.48	34.77	Pass
			H	20.21		
		E1	V	22.29		
			H	19.99		
		E2	V	21.96		
			H	19.39		

16QAM mode:

EUT mode	Channel	EUT Pol.	Antenna Pol.	EIRP(dBm)	Limit (dBm)	Result
LTE Band 2 (5MHz)	Lowest	H	V	22.55	30.00	Pass
			H	20.51		
		E1	V	22.23		
			H	19.84		
		E2	V	21.45		
			H	18.61		
	Middle	H	V	22.55	30.00	Pass
			H	19.86		
		E1	V	22.11		
			H	19.65		
		E2	V	21.96		
			H	18.83		
	Highest	H	V	22.29	30.00	Pass
			H	20.00		
		E1	V	22.07		
			H	19.75		
		E2	V	21.79		
			H	19.21		

EUT mode	Channel	EUT Pol.	Antenna Pol.	EIRP(dBm)	Limit (dBm)	Result
LTE Band 4 (5MHz)	Lowest	H	V	22.69	30.00	Pass
			H	20.66		
		E1	V	22.40		
			H	20.02		
		E2	V	21.64		
			H	18.83		
	Middle	H	V	22.74	30.00	Pass
			H	20.09		
		E1	V	22.36		
			H	19.91		
		E2	V	22.18		
			H	19.08		
	Highest	H	V	22.48	30.00	Pass
			H	20.21		
		E1	V	22.29		
			H	19.98		
		E2	V	21.95		
			H	19.39		

EUT mode	Channel	EUT Pol.	Antenna Pol.	ERP(dBm)	Limit (dBm)	Result
LTE Band 12 (5MHz)	Lowest	H	V	22.73	34.77	Pass
			H	20.71		
		E1	V	22.45		
			H	20.08		
		E2	V	21.71		
			H	18.90		
	Middle	H	V	22.80	34.77	Pass
			H	20.16		
		E1	V	22.44		
			H	20.00		
		E2	V	22.25		
			H	19.15		
	Highest	H	V	22.54	34.77	Pass
			H	20.27		
		E1	V	22.36		
			H	20.06		
		E2	V	22.00		
			H	19.44		

## 6.8 Field strength of spurious radiation measurement

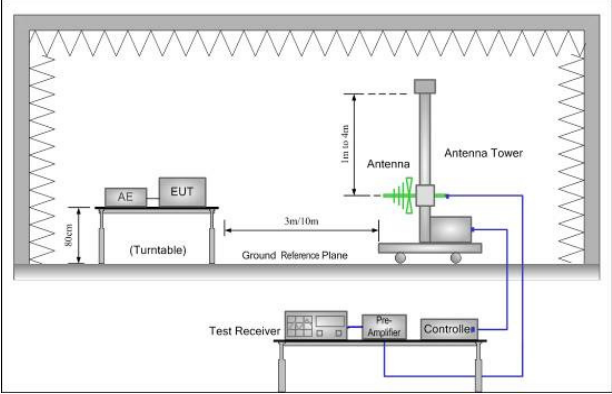
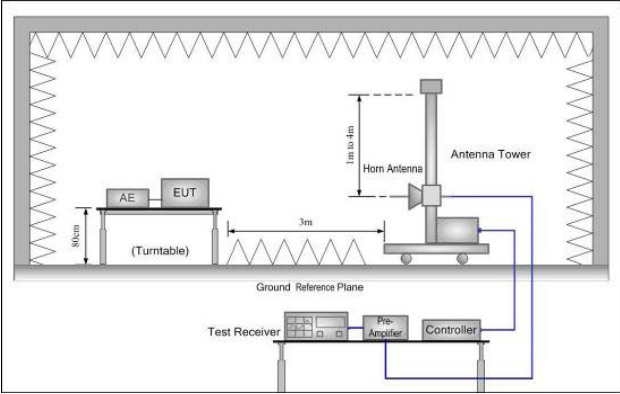
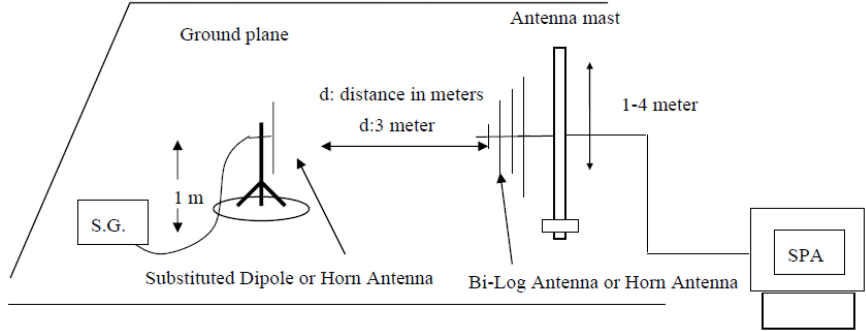
Test Requirement:	Part 24.238 (a); FCC Part 27.53(h)/(g)
Test Method:	FCC part2.1053
Limit:	Band 2/4/12:-13dBm
Test setup:	<p>Below 1GHz</p>  <p>Above 1GHz</p>  <p>Substituted method:</p> 

Test Procedure:	<ol style="list-style-type: none"><li>1. The EUT was placed on a non-conductive turntable using a non-conductive support. The radiated emission at the fundamental frequency was measured at 3 m with a test antenna and EMI spectrum analyzer.</li><li>2. During the tests, the antenna height and the EUT azimuth were varied in order to identify the maximum level of emissions from the EUT. This maximization process was repeated with the EUT positioned in each of its three orthogonal orientations.</li><li>3. The frequency range up to tenth harmonic was investigated for each of three fundamental frequency (low, middle and high channels). Once spurious emission was identified, the power of the emission was determined using the substitution method.</li><li>4. The spurious emissions attenuation was calculated as the difference between radiated power at the fundamental frequency and the spurious emissions frequency. <math display="block">\text{ERP / EIRP} = \text{S.G. output (dBm)} + \text{Antenna Gain(dB/dBi)} - \text{Cable Loss (dB)}</math></li></ol>
Test Instruments:	Refer to section 6.0 for details
Test mode:	Refer to section 6.1 for details
Test results:	Pass

Measurement Data

QPSK mode:

Test mode:		LTE Band 2(5MHz)		Test channel:	Lowest
Frequency (MHz)	Spurious Emission		Limit (dBm)	Result	
	Polarization	Level (dBm)			
3705.00	Vertical	-35.28	-13.00	Pass	
5557.50	V	-37.83			
7410.00	V	-40.59			
9262.50	V	-43.52			
11115.00	V	---			
3705.00	Horizontal	-38.83	-13.00	Pass	
5557.50	H	-41.41			
7410.00	H	-42.91			
9262.50	H	-49.25			
11115.00	H	---			
Test mode:		LTE Band 2(5MHz)		Test channel:	Middle
Frequency (MHz)	Spurious Emission		Limit (dBm)	Result	
	Polarization	Level (dBm)			
3760.00	Vertical	-37.16	-13.00	Pass	
5640.00	V	-38.57			
7520.00	V	-42.30			
9400.00	V	-44.80			
11280.00	V	---			
3760.00	Horizontal	-39.78	-13.00	Pass	
5640.00	H	-41.82			
7520.00	H	-46.62			
9400.00	H	-49.15			
11280.00	H	---			
Test mode:		LTE Band 2(5MHz)		Test channel:	Highest
Frequency (MHz)	Spurious Emission		Limit (dBm)	Result	
	Polarization	Level (dBm)			
3815.00	Vertical	-35.08	-13.00	Pass	
5722.50	V	-38.92			
7630.00	V	-41.77			
9537.50	V	-39.33			
11445.00	V	---			
3815.00	Horizontal	-38.06	-13.00	Pass	
5722.50	H	-40.89			
7630.00	H	-46.41			
9537.50	H	-50.18			
11445.00	H	---			



Test mode:		LTE Band 2(10MHz)		Test channel:	Lowest
Frequency (MHz)	Spurious Emission		Limit (dBm)	Result	
	Polarization	Level (dBm)			
3810.00	Vertical	-37.47	-13.00	Pass	
5715.00	V	-40.26			
7620.00	V	-42.56			
9525.00	V	-44.76			
11430.00	V	---			
3810.00	Horizontal	-42.80	-13.00	Pass	
5715.00	H	-46.73			
7620.00	H	-48.34			
9525.00	H	-51.14			
11430.00	H	---			
Test mode:		LTE Band 2(10MHz)		Test channel:	Middle
Frequency (MHz)	Spurious Emission		Limit (dBm)	Result	
	Polarization	Level (dBm)			
3760.00	Vertical	-37.88	-13.00	Pass	
5640.00	V	-40.88			
7520.00	V	-43.37			
9400.00	V	-45.72			
11280.00	V	---			
3760.00	Horizontal	-43.62	-13.00	Pass	
5640.00	H	-47.85			
7520.00	H	-49.59			
9400.00	H	-52.61			
11280.00	H	---			
Test mode:		LTE Band 2(10MHz)		Test channel:	Highest
Frequency (MHz)	Spurious Emission		Limit (dBm)	Result	
	Polarization	Level (dBm)			
3710.00	Vertical	-37.74	-13.00	Pass	
5565.00	V	-40.87			
7420.00	V	-43.46			
9275.00	V	-45.93			
11130.00	V	---			
3710.00	Horizontal	-43.73	-13.00	Pass	
5565.00	H	-48.15			
7420.00	H	-49.96			
9275.00	H	-53.10			
11130.00	H	---			

Test mode:		LTE Band 2(15MHz)		Test channel:	Lowest
Frequency (MHz)	Spurious Emission		Limit (dBm)	Result	
	Polarization	Level (dBm)			
3805.00	Vertical	-34.86	-13.00	Pass	
5707.50	V	-37.29			
7610.00	V	-39.32			
9512.50	V	-41.23			
11415.00	V	---			
3805.00	Horizontal	-39.52	-13.00	Pass	
5707.50	H	-42.97			
7610.00	H	-44.37			
9512.50	H	-46.82			
11415.00	H	---			
Test mode:		LTE Band 2(15MHz)		Test channel:	Middle
Frequency (MHz)	Spurious Emission		Limit (dBm)	Result	
	Polarization	Level (dBm)			
3760.00	Vertical	-33.94	-13.00	Pass	
5640.00	V	-36.43			
7520.00	V	-38.51			
9400.00	V	-40.49			
11280.00	V	---			
3760.00	Horizontal	-38.73	-13.00	Pass	
5640.00	H	-42.26			
7520.00	H	-43.71			
9400.00	H	-46.21			
11280.00	H	---			
Test mode:		LTE Band 2(15MHz)		Test channel:	Highest
Frequency (MHz)	Spurious Emission		Limit (dBm)	Result	
	Polarization	Level (dBm)			
3715.00	Vertical	-35.48	-13.00	Pass	
5572.50	V	-37.93			
7430.00	V	-39.98			
9287.50	V	-41.90			
11145.00	V	---			
3715.00	Horizontal	-40.18	-13.00	Pass	
5572.50	H	-43.65			
7430.00	H	-45.07			
9287.50	H	-47.53			
11145.00	H	---			

Test mode:		LTE Band 2(20MHz)		Test channel:	Lowest
Frequency (MHz)	Spurious Emission		Limit (dBm)	Result	
	Polarization	Level (dBm)			
3800.00	Vertical	-35.85	-13.00	Pass	
5700.00	V	-37.96			
7600.00	V	-39.71			
9500.00	V	-41.35			
11400.00	V	---			
3800.00	Horizontal	-39.87	-13.00	Pass	
5700.00	H	-42.84			
7600.00	H	-44.08			
9500.00	H	-46.21			
11400.00	H	---			
Test mode:		LTE Band 2(20MHz)		Test channel:	Middle
Frequency (MHz)	Spurious Emission		Limit (dBm)	Result	
	Polarization	Level (dBm)			
3760.00	Vertical	-37.09	-13.00	Pass	
5640.00	V	-39.37			
7520.00	V	-41.28			
9400.00	V	-43.09			
11280.00	V	---			
3760.00	Horizontal	-41.48	-13.00	Pass	
5640.00	H	-44.71			
7520.00	H	-46.03			
9400.00	H	-48.33			
11280.00	H	---			
Test mode:		LTE Band 2(20MHz)		Test channel:	Highest
Frequency (MHz)	Spurious Emission		Limit (dBm)	Result	
	Polarization	Level (dBm)			
3720.00	Vertical	-34.43	-13.00	Pass	
5580.00	V	-37.23			
7440.00	V	-39.57			
9300.00	V	-41.75			
11160.00	V	---			
3720.00	Horizontal	-39.78	-13.00	Pass	
5580.00	H	-43.74			
7440.00	H	-45.38			
9300.00	H	-48.21			
11160.00	H	---			

Test mode:		LTE Band 4(5MHz)		Test channel:	Lowest
Frequency (MHz)	Spurious Emission		Limit (dBm)	Result	
	Polarization	Level (dBm)			
3425.00	Vertical	-35.49	-13.00	Pass	
5137.50	V	-38.25			
6850.00	V	-40.54			
8562.50	V	-42.70			
10275.00	V	---			
3425.00	Horizontal	-40.77	-13.00	Pass	
5137.50	H	-44.66			
6850.00	H	-46.26			
8562.50	H	-49.02			
10275.00	H	---			
Test mode:		LTE Band 4(5MHz)		Test channel:	Middle
Frequency (MHz)	Spurious Emission		Limit (dBm)	Result	
	Polarization	Level (dBm)			
3465.00	Vertical	-37.58	-13.00	Pass	
5197.50	V	-39.84			
6930.00	V	-41.72			
8662.50	V	-43.52			
10395.00	V	---			
3465.00	Horizontal	-41.93	-13.00	Pass	
5197.50	H	-45.14			
6930.00	H	-46.43			
8662.50	H	-48.69			
10395.00	H	---			
Test mode:		LTE Band 4(5MHz)		Test channel:	Highest
Frequency (MHz)	Spurious Emission		Limit (dBm)	Result	
	Polarization	Level (dBm)			
3505.00	Vertical	-36.82	-13.00	Pass	
5257.50	V	-38.88			
7010.00	V	-40.59			
8762.50	V	-42.21			
10515.00	V	---			
3505.00	Horizontal	-40.76	-13.00	Pass	
5257.50	H	-43.68			
7010.00	H	-44.87			
8762.50	H	-46.94			
10515.00	H	---			

Test mode:		LTE Band 4(10MHz)		Test channel:	Lowest
Frequency (MHz)	Spurious Emission		Limit (dBm)	Result	
	Polarization	Level (dBm)			
3430.00	Vertical	-35.34	-13.00	Pass	
5145.00	V	-37.80			
6860.00	V	-39.85			
8575.00	V	-41.77			
10290.00	V	---			
3430.00	Horizontal	-40.05	-13.00	Pass	
5145.00	H	-43.52			
6860.00	H	-44.95			
8575.00	H	-47.42			
10290.00	H	---			
Test mode:		LTE Band 4(10MHz)		Test channel:	Middle
Frequency (MHz)	Spurious Emission		Limit (dBm)	Result	
	Polarization	Level (dBm)			
3465.00	Vertical	-33.83	-13.00	Pass	
5197.50	V	-36.33			
6930.00	V	-38.41			
8662.50	V	-40.39			
10395.00	V	---			
3465.00	Horizontal	-38.63	-13.00	Pass	
5197.50	H	-42.17			
6930.00	H	-43.62			
8662.50	H	-46.13			
10395.00	H	---			
Test mode:		LTE Band 4(10MHz)		Test channel:	Highest
Frequency (MHz)	Spurious Emission		Limit (dBm)	Result	
	Polarization	Level (dBm)			
3500.00	Vertical	-34.74	-13.00	Pass	
5250.00	V	-37.18			
7000.00	V	-39.21			
8750.00	V	-41.13			
10500.00	V	---			
3500.00	Horizontal	-39.41	-13.00	Pass	
5250.00	H	-42.87			
7000.00	H	-44.28			
8750.00	H	-46.73			
10500.00	H	---			

Test mode:		LTE Band 4(15MHz)		Test channel:	Lowest
Frequency (MHz)	Spurious Emission		Limit (dBm)	Result	
	Polarization	Level (dBm)			
3435.00	Vertical	-38.43	-13.00	Pass	
5152.50	V	-41.53			
6870.00	V	-44.09			
8587.50	V	-46.55			
10305.00	V	---			
3435.00	Horizontal	-44.37	-13.00	Pass	
5152.50	H	-48.75			
6870.00	H	-50.53			
8587.50	H	-53.62			
10305.00	H	---			
Test mode:		LTE Band 4(15MHz)		Test channel:	Middle
Frequency (MHz)	Spurious Emission		Limit (dBm)	Result	
	Polarization	Level (dBm)			
3465.00	Vertical	-38.73	-13.00	Pass	
5197.50	V	-41.69			
6930.00	V	-44.13			
8662.50	V	-46.48			
10395.00	V	---			
3465.00	Horizontal	-44.40	-13.00	Pass	
5197.50	H	-48.58			
6930.00	H	-50.29			
8662.50	H	-53.25			
10395.00	H	---			
Test mode:		LTE Band 4(15MHz)		Test channel:	Highest
Frequency (MHz)	Spurious Emission		Limit (dBm)	Result	
	Polarization	Level (dBm)			
3495.00	Vertical	-38.15	-13.00	Pass	
5242.50	V	-40.91			
6990.00	V	-43.18			
8737.50	V	-45.37			
10485.00	V	---			
3495.00	Horizontal	-43.43	-13.00	Pass	
5242.50	H	-47.32			
6990.00	H	-48.90			
8737.50	H	-51.65			
10485.00	H	---			

Test mode:		LTE Band 4(20MHz)		Test channel:	Lowest
Frequency (MHz)	Spurious Emission		Limit (dBm)	Result	
	Polarization	Level (dBm)			
3440.00	Vertical	-34.72	-13.00	Pass	
5160.00	V	-38.58			
6880.00	V	-41.45			
8600.00	V	-39.02			
10320.00	V	---			
3440.00	Horizontal	-37.73	-13.00	Pass	
5160.00	H	-40.58			
6880.00	H	-46.12			
8600.00	H	-49.91			
10320.00	H	---			
Test mode:		LTE Band 4(20MHz)		Test channel:	Middle
Frequency (MHz)	Spurious Emission		Limit (dBm)	Result	
	Polarization	Level (dBm)			
3465.00	Vertical	-36.82	-13.00	Pass	
5197.50	V	-38.24			
6930.00	V	-41.99			
8662.50	V	-44.50			
10395.00	V	---			
3465.00	Horizontal	-39.47	-13.00	Pass	
5197.50	H	-41.53			
6930.00	H	-46.34			
8662.50	H	-48.89			
10395.00	H	---			
Test mode:		LTE Band 4(20MHz)		Test channel:	Highest
Frequency (MHz)	Spurious Emission		Limit (dBm)	Result	
	Polarization	Level (dBm)			
3490.00	Vertical	-34.91	-13.00	Pass	
5235.00	V	-37.47			
6980.00	V	-40.25			
8725.00	V	-43.19			
10470.00	V	---			
3490.00	Horizontal	-38.48	-13.00	Pass	
5235.00	H	-41.08			
6980.00	H	-42.60			
8725.00	H	-48.97			
10470.00	H	---			

Remark:

1. The emission behaviour belongs to narrowband spurious emission.
2. Remark"---" means that the emission level is too low to be measured
3. The emission levels of below 1 GHz are very lower than the limit and not show in test report.

Test mode:	LTE Band 12(5MHz)		Test channel:	Lowest
Frequency (MHz)	Spurious Emission		Limit (dBm)	Result
	Polarization	Level (dBm)		
1559.00	Vertical	-38.17	-13.00	Pass
2338.50	V	-38.95		
3118.00	V	-40.46		
3897.50	V	-42.73		
4677.00	V	---		
1559.00	Horizontal	-41.51	-13.00	Pass
2338.50	H	-43.27		
3118.00	H	-44.29		
3897.50	H	-47.32		
4677.00	H	---		
Test mode:	LTE Band 12(5MHz)		Test channel:	Middle
Frequency (MHz)	Spurious Emission		Limit (dBm)	Result
	Polarization	Level (dBm)		
1764.00	Vertical	-38.73	-13.00	Pass
2646.00	V	-40.94		
3528.00	V	-42.61		
4410.00	V	-46.74		
5292.00	V	---		
1764.00	Horizontal	-42.08	-13.00	Pass
2646.00	H	-43.06		
3528.00	H	-45.38		
4410.00	H	-48.57		
5292.00	H	---		
Test mode:	LTE Band 12(5MHz)		Test channel:	Highest
Frequency (MHz)	Spurious Emission		Limit (dBm)	Result
	Polarization	Level (dBm)		
1569.00	Vertical	-36.05	-13.00	Pass
2353.50	V	-37.59		
3138.00	V	-39.77		
3922.50	V	-40.88		
4707.00	V	---		
1569.00	Horizontal	-42.05	-13.00	Pass
2353.50	H	-46.03		
3138.00	H	-48.24		
3922.50	H	-51.38		
4707.00	H	---		

Remark:

1. The emission behaviour belongs to narrowband spurious emission.
2. Remark"---" means that the emission level is too low to be measured
3. The emission levels of below 1 GHz are very lower than the limit and not show in test report.



Test mode:		LTE Band 12(10MHz)		Test channel:	Lowest
Frequency (MHz)	Spurious Emission		Limit (dBm)	Result	
	Polarization	Level (dBm)			
1408.00	Vertical	-35.05	-13.00	Pass	
2112.00	V	-37.52			
2816.00	V	-39.58			
3520.00	V	-41.51			
4224.00	V	---			
1408.00	Horizontal	-39.78	-13.00	Pass	
2112.00	H	-43.27			
2816.00	H	-44.71			
3520.00	H	-47.20			
4224.00	H	---			
Test mode:		LTE Band 12(10MHz)		Test channel:	Middle
Frequency (MHz)	Spurious Emission		Limit (dBm)	Result	
	Polarization	Level (dBm)			
1415.00	Vertical	-33.61	-13.00	Pass	
2122.50	V	-36.12			
2830.00	V	-38.21			
3537.50	V	-40.20			
4245.00	V	---			
1415.00	Horizontal	-38.43	-13.00	Pass	
2122.50	H	-41.98			
2830.00	H	-43.44			
3537.50	H	-45.97			
4245.00	H	---			
Test mode:		LTE Band 12(10MHz)		Test channel:	Highest
Frequency (MHz)	Spurious Emission		Limit (dBm)	Result	
	Polarization	Level (dBm)			
1422.00	Vertical	-34.50	-13.00	Pass	
2133.00	V	-36.95			
2844.00	V	-38.99			
3555.00	V	-40.91			
4266.00	V	---			
1422.00	Horizontal	-39.19	-13.00	Pass	
2133.00	H	-42.66			
2844.00	H	-44.08			
3555.00	H	-46.55			
4266.00	H	---			

Remark:

1. The emission behaviour belongs to narrowband spurious emission.
2. Remark"---" means that the emission level is too low to be measured
3. The emission levels of below 1 GHz are very lower than the limit and not show in test report.

16QAM mode:

Test mode:		LTE Band 2(5MHz)		Test channel:	Lowest
Frequency (MHz)	Spurious Emission		Limit (dBm)	Result	
	Polarization	Level (dBm)			
3705.00	Vertical	-33.27	-13.00	Pass	
5557.50	V	-36.13			
7410.00	V	-38.52			
9262.50	V	-40.72			
11115.00	V	---			
3705.00	Horizontal	-38.72	-13.00	Pass	
5557.50	H	-42.74			
7410.00	H	-44.44			
9262.50	H	-47.34			
11115.00	H	---			
Test mode:		LTE Band 2(5MHz)		Test channel:	Middle
Frequency (MHz)	Spurious Emission		Limit (dBm)	Result	
	Polarization	Level (dBm)			
3760.00	Vertical	-36.56	-13.00	Pass	
5640.00	V	-38.87			
7520.00	V	-40.80			
9400.00	V	-42.61			
11280.00	V	---			
3760.00	Horizontal	-40.99	-13.00	Pass	
5640.00	H	-44.26			
7520.00	H	-45.60			
9400.00	H	-47.93			
11280.00	H	---			
Test mode:		LTE Band 2(5MHz)		Test channel:	Highest
Frequency (MHz)	Spurious Emission		Limit (dBm)	Result	
	Polarization	Level (dBm)			
3815.00	Vertical	-34.81	-13.00	Pass	
5722.50	V	-36.96			
7630.00	V	-38.76			
9537.50	V	-40.41			
11445.00	V	---			
3815.00	Horizontal	-38.90	-13.00	Pass	
5722.50	H	-41.94			
7630.00	H	-43.22			
9537.50	H	-45.42			
11445.00	H	---			

Remark:

4. The emission behaviour belongs to narrowband spurious emission.
5. Remark"---" means that the emission level is too low to be measured
6. The emission levels of below 1 GHz are very lower than the limit and not show in test report.

Test mode:	LTE Band 4(5MHz)		Test channel:	Lowest
Frequency (MHz)	Spurious Emission		Limit (dBm)	Result
	Polarization	Level (dBm)		
3425.00	Vertical	-34.60	-13.00	Pass
5137.50	V	-37.40		
6850.00	V	-39.73		
8562.50	V	-41.91		
10275.00	V	---		
3425.00	Horizontal	-39.95	-13.00	Pass
5137.50	H	-43.90		
6850.00	H	-45.53		
8562.50	H	-48.35		
10275.00	H	---		
Test mode:	LTE Band 4(5MHz)		Test channel:	Middle
Frequency (MHz)	Spurious Emission		Limit (dBm)	Result
	Polarization	Level (dBm)		
3465.00	Vertical	-37.17	-13.00	Pass
5197.50	V	-39.45		
6930.00	V	-41.35		
8662.50	V	-43.16		
10395.00	V	---		
3465.00	Horizontal	-41.55	-13.00	Pass
5197.50	H	-44.78		
6930.00	H	-46.10		
8662.50	H	-48.39		
10395.00	H	---		
Test mode:	LTE Band 4(5MHz)		Test channel:	Highest
Frequency (MHz)	Spurious Emission		Limit (dBm)	Result
	Polarization	Level (dBm)		
3505.00	Vertical	-36.01	-13.00	Pass
5257.50	V	-38.11		
7010.00	V	-39.86		
8762.50	V	-41.49		
10515.00	V	---		
3505.00	Horizontal	-40.02	-13.00	Pass
5257.50	H	-42.98		
7010.00	H	-44.21		
8762.50	H	-46.33		
10515.00	H	---		

Remark:

7. The emission behaviour belongs to narrowband spurious emission.
8. Remark"---" means that the emission level is too low to be measured
9. The emission levels of below 1 GHz are very lower than the limit and not show in test report.

Test mode:	LTE Band 12(5MHz)		Test channel:	Lowest
Frequency (MHz)	Spurious Emission		Limit (dBm)	Result
	Polarization	Level (dBm)		
1559.00	Vertical	-36.00	-13.00	Pass
2338.50	V	-36.88		
3118.00	V	-38.49		
3897.50	V	-40.79		
4677.00	V	---		
1559.00	Horizontal	-39.50	-13.00	Pass
2338.50	H	-41.40		
3118.00	H	-42.51		
3897.50	H	-45.68		
4677.00	H	---		
Test mode:	LTE Band 12(5MHz)		Test channel:	Middle
Frequency (MHz)	Spurious Emission		Limit (dBm)	Result
	Polarization	Level (dBm)		
1764.00	Vertical	-36.50	-13.00	Pass
2646.00	V	-38.80		
3528.00	V	-40.58		
4410.00	V	-44.74		
5292.00	V	---		
1764.00	Horizontal	-40.01	-13.00	Pass
2646.00	H	-41.12		
3528.00	H	-43.55		
4410.00	H	-46.88		
5292.00	H	---		
Test mode:	LTE Band 12(5MHz)		Test channel:	Highest
Frequency (MHz)	Spurious Emission		Limit (dBm)	Result
	Polarization	Level (dBm)		
1569.00	Vertical	-33.44	-13.00	Pass
2353.50	V	-35.09		
3138.00	V	-37.40		
3922.50	V	-38.55		
4707.00	V	---		
1569.00	Horizontal	-39.63	-13.00	Pass
2353.50	H	-43.77		
3138.00	H	-46.10		
3922.50	H	-49.41		
4707.00	H	---		

Remark:

1. The emission behaviour belongs to narrowband spurious emission.
2. Remark"---" means that the emission level is too low to be measured
3. The emission levels of below 1 GHz are very lower than the limit and not show in test report.

## 6.9 Frequency stability V.S. Temperature measurement

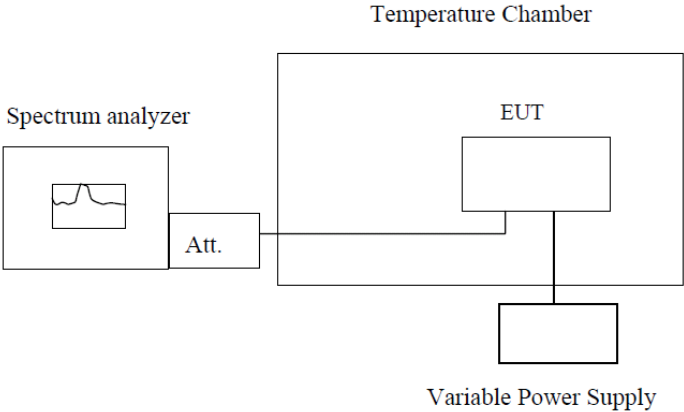
Test Requirement:	FCC Part2.1055(a)(1)(b)
Test Method:	FCC Part2.1055(a)(1)(b)
Limit:	2.5ppm
Test setup:	 <p style="text-align: center;"><b>Note :</b> Measurement setup for testing on Antenna connector</p>
Test procedure:	<ol style="list-style-type: none"> <li>1. The equipment under test was connected to an external DC power supply and input rated voltage.</li> <li>2. RF output was connected to a frequency counter or spectrum analyzer via feed through attenuators.</li> <li>3. The EUT was placed inside the temperature chamber.</li> <li>4. Set the spectrum analyzer RBW low enough to obtain the desired frequency resolution and measure EUT 25°C operating frequency as reference frequency.</li> <li>5. Turn EUT off and set the chamber temperature to -20°C. After the temperature stabilized for approximately 30 minutes recorded the frequency.</li> <li>6. Repeat step measure with 10°C increased per stage until the highest temperature of +50°C reached.</li> </ol>
Test Instruments:	Refer to section 6.0 for details
Test mode:	Refer to section 6.1 for details
Test results:	Pass

Measurement Data

QPSK mode:

Reference Frequency: LTE Band 2 Middle channel=18900 channel=1880MHz					
Power supplied (Vdc)	Temperature (°C)	Frequency error		Limit (ppm)	Result
		Hz	ppm		
12.0	-30	33	0.0178	2.5	Pass
	-20	37	0.0197		
	-10	32	0.0172		
	0	28	0.0146		
	10	31	0.0165		
	20	28	0.0146		
	30	42	0.0222		
	40	38	0.0203		
	50	37	0.0197		
Reference Frequency: LTE Band 4 Middle channel=20175 channel=1732.5MHz					
Power supplied (Vdc)	Temperature (°C)	Frequency error		Limit (ppm)	Result
		Hz	ppm		
12.0	-30	31	0.0171	2.5	Pass
	-20	33	0.0185		
	-10	30	0.0164		
	0	27	0.0150		
	10	28	0.0157		
	20	26	0.0143		
	30	40	0.0219		
	40	35	0.0192		
	50	33	0.0185		
Reference Frequency: LTE Band 12 Middle channel=23095 channel=707.5MHz					
Power supplied (Vdc)	Temperature (°C)	Frequency error		Limit (ppm)	Result
		Hz	ppm		
12.0	-30	54	0.0498	2.5	Pass
	-20	63	0.0620		
	-10	52	0.0498		
	0	45	0.0395		
	10	50	0.0498		
	20	43	0.0416		
	30	76	0.0764		
	40	66	0.0641		
	50	62	0.0600		

16QAM mode:

Reference Frequency: LTE Band 2 Middle channel=18900 channel=1880MHz					
Power supplied (Vdc)	Temperature (°C)	Frequency error		Limit (ppm)	Result
		Hz	ppm		
12.0	-30	31	0.0166	2.5	Pass
	-20	35	0.0184		
	-10	30	0.0161		
	0	26	0.0137		
	10	29	0.0155		
	20	26	0.0137		
	30	39	0.0207		
	40	36	0.0190		
	50	35	0.0184		
Reference Frequency: LTE Band 4 Middle channel=20175 channel=1732.5MHz					
Power supplied (Vdc)	Temperature (°C)	Frequency error		Limit (ppm)	Result
		Hz	ppm		
12.0	-30	24	0.0174	2.5	Pass
	-20	26	0.0193		
	-10	23	0.0167		
	0	21	0.0141		
	10	22	0.0161		
	20	20	0.0141		
	30	30	0.0220		
	40	26	0.0200		
	50	26	0.0193		
Reference Frequency: LTE Band 13 Middle channel=23095 channel=707.5MHz					
Power supplied (Vdc)	Temperature (°C)	Frequency error			Result
		Hz	ppm		
12.0	-30	52	0.0498	2.5	Pass
	-20	60	0.0620		
	-10	50	0.0498		
	0	43	0.0395		
	10	48	0.0498		
	20	42	0.0416		
	30	73	0.0764		
	40	63	0.0641		
	50	60	0.0600		

## 6.10 Frequency stability V.S. Voltage measurement

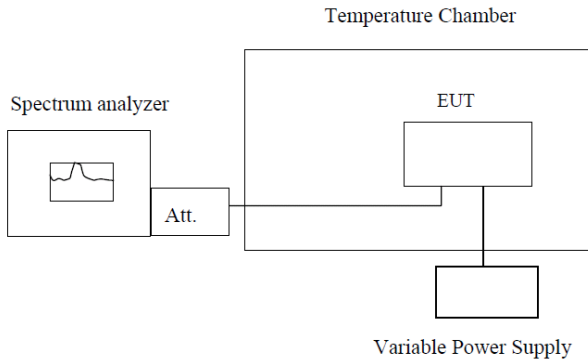
Test Requirement:	FCC Part2.1055(d)(1)(2)
Test Method:	FCC Part2.1055(d)(1)(2)
Limit:	2.5ppm
Test setup:	 <p style="text-align: center;">Temperature Chamber</p> <p style="text-align: center;">Spectrum analyzer</p> <p style="text-align: center;">Att.</p> <p style="text-align: center;">EUT</p> <p style="text-align: center;">Variable Power Supply</p> <p><b>Note :</b> Measurement setup for testing on Antenna connector</p>
Test procedure:	<ol style="list-style-type: none"> <li>1. Set chamber temperature to 25°C. Use a variable DC power source to power the EUT and set the voltage to rated voltage.</li> <li>2. Set the spectrum analyzer RBW low enough to obtain the desired frequency resolution and recorded the frequency.</li> <li>3. Reduce the input voltage to specified extreme voltage variation (+/- 15%) and endpoint, record the maximum frequency change.</li> </ol>
Test Instruments:	Refer to section 6.0 for details
Test mode:	Refer to section 6.1 for details
Test results:	Pass



Measurement Data

QPSK mode:

Reference Frequency: LTE Band 2 Middle channel=18900 channel=1880MHz					
Temperature (°C)	Power supplied (Vdc)	Frequency error		Limit (ppm)	Result
		Hz	ppm		
25	13.20	18	0.0094	2.5	Pass
	12.00	20	0.0105		
	10.80	22	0.0116		
Reference Frequency: LTE Band 4 Middle channel=20175 channel=1732.5MHz					
Temperature (°C)	Power supplied (Vdc)	Frequency error		Limit (ppm)	Result
		Hz	ppm		
25	13.20	24	0.0137	2.5	Pass
	12.00	15	0.0088		
	10.80	18	0.0104		
Reference Frequency: LTE Band 12 Middle channel=23095 channel=707.5MHz					
Temperature (°C)	Power supplied (Vdc)	Frequency error		Limit (ppm)	Result
		Hz	ppm		
25	13.20	20	0.0282	2.5	Pass
	12.00	28	0.0392		
	10.80	28	0.0392		

16QAM mode:

Reference Frequency: LTE Band 2 Middle channel=18900 channel=1880MHz					
Temperature (°C)	Power supplied (Vdc)	Frequency error		Limit (ppm)	Result
		Hz	ppm		
25	13.20	19	0.0100	2.5	Pass
	12.00	21	0.0112		
	10.80	23	0.0124		
Reference Frequency: LTE Band 4 Middle channel=20175 channel=1732.5MHz					
Temperature (°C)	Power supplied (Vdc)	Frequency error		Limit (ppm)	Result
		Hz	ppm		
25	13.20	23	0.0130	2.5	Pass
	12.00	15	0.0084		
	10.80	17	0.0099		
Reference Frequency: LTE Band 13 Middle channel=23095 channel=707.5MHz					
Temperature (°C)	Power supplied (Vdc)	Frequency error		Limit (ppm)	Result
		Hz	ppm		
25	13.20	19	0.0264	2.5	Pass
	12.00	26	0.0366		
	10.80	26	0.0366		

## 7 Test Setup Photo

Radiated Emission



## 8 EUT Constructional Details



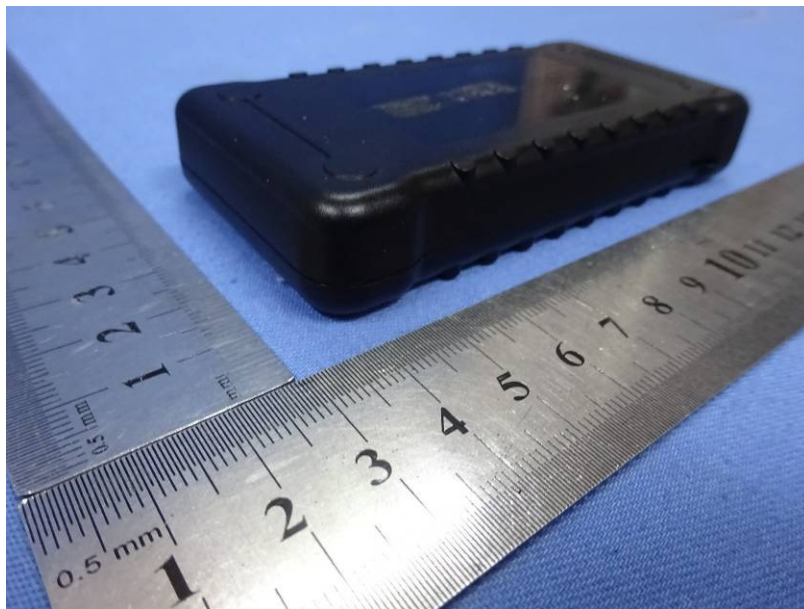



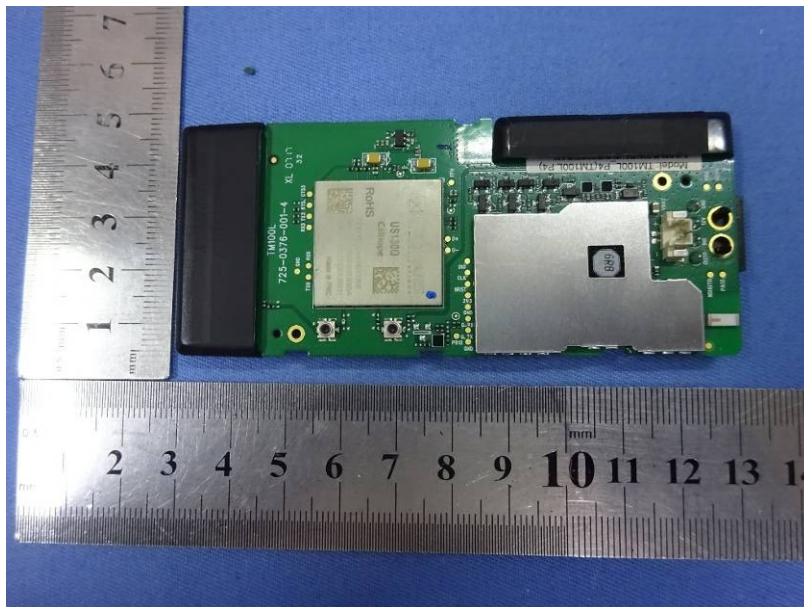
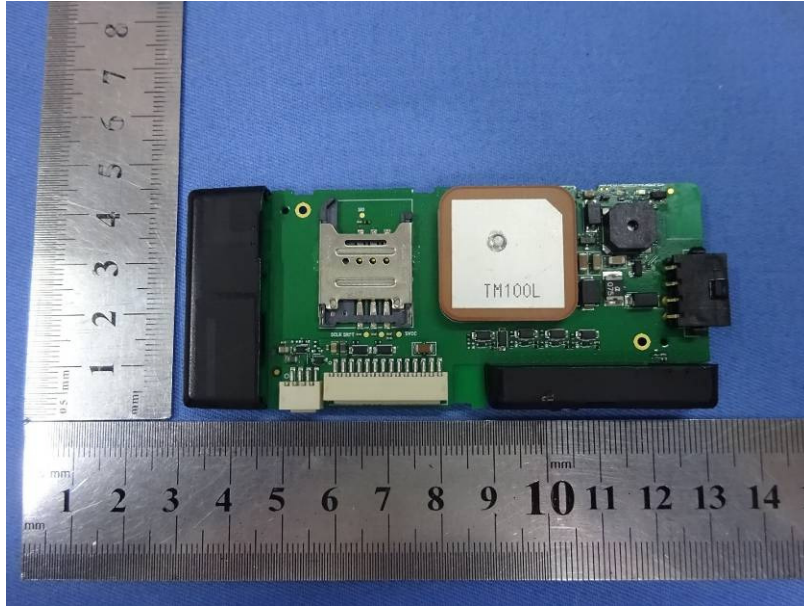

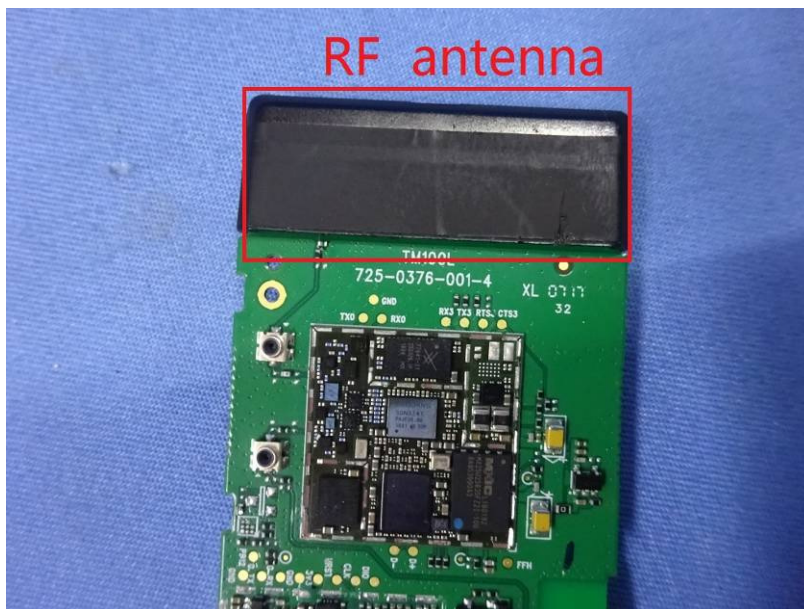
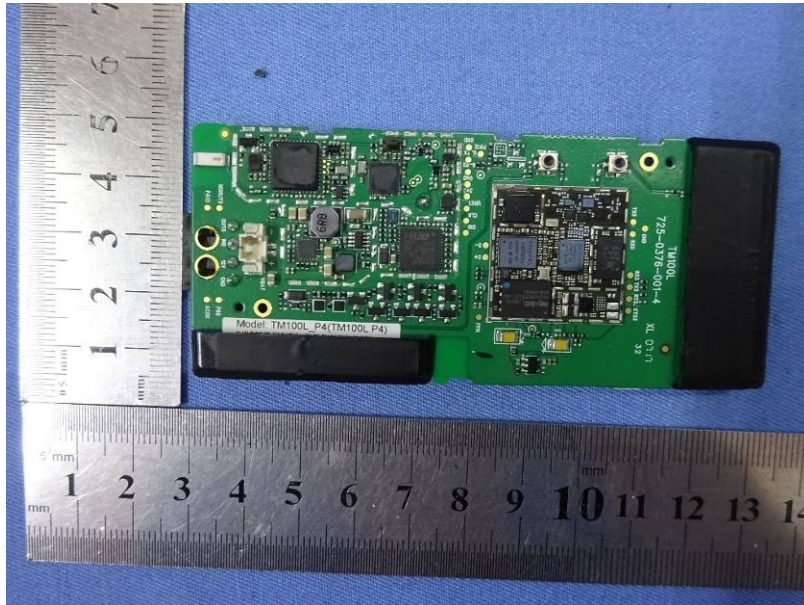

-----End-----