



# RADIO TEST REPORT

Report No: STS1606154F01

Issued for

Shenzhen EDUP Electronics Technology Co.,Ltd.

6 Floor, #6 Building, No.48, Kangzheng Road, Liantang  
Industrial Area, Buji Town, ShenZheng China

<b>Product Name:</b>	Wireless Adapter
<b>Brand Name:</b>	EDUP
<b>Model Name:</b>	EP-DB1607
<b>Series Model:</b>	EP-DB1608
<b>FCC ID:</b>	2AHRDEP-DB1607
<b>Test Standard:</b>	FCC Part 15.247

Any reproduction of this document must be done in full. No single part of this document may be reproduced without permission from STS, All Test Data Presented in this report is only applicable to presented Test sample.





### TEST RESULT CERTIFICATION

**Applicant's name** ..... : Shenzhen EDUP Electronics Technology Co.,Ltd.  
**Address** ..... : 6 Floor, #6 Building, No.48, Kangzheng Road, Liantang Industrial Area, Buji Town, ShenZheng China  
**Manufacture's Name** ..... : Shenzhen EDUP Electronics Technology Co.,Ltd.  
**Address** ..... : 6 Floor, #6 Building, No.48, Kangzheng Road, Liantang Industrial Area, Buji Town, ShenZheng China

#### Product description

**Product name**..... : Wireless Adapter  
**Model and/or type reference** : EP-DB1607  
**Series Model**..... : EP-DB1608

**Standards** ..... : FCC Part15.247

**Test procedure** ..... ANSI C63.10-2013

This device described above has been tested by STS, and the test results show that the equipment under test (EUT) is in compliance with the FCC requirements. And it is applicable only to the tested sample identified in the report.


This report shall not be reproduced except in full, without the written approval of STS, this document may be altered or revised by STS, personal only, and shall be noted in the revision of the document.

**Date of Test**..... :

**Date (s) of performance of tests**..... : 21 June. 2016 ~29 June. 2016

**Date of Issue** ..... : 30 June. 2016

**Test Result** ..... : **Pass**

Testing Engineer :   
 \_\_\_\_\_  
 (Tony Liu)

Technical Manager :   
 \_\_\_\_\_  
 (Vita Li)

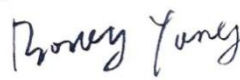
Authorized Signatory :   
 \_\_\_\_\_  
 (Bovey Yang)

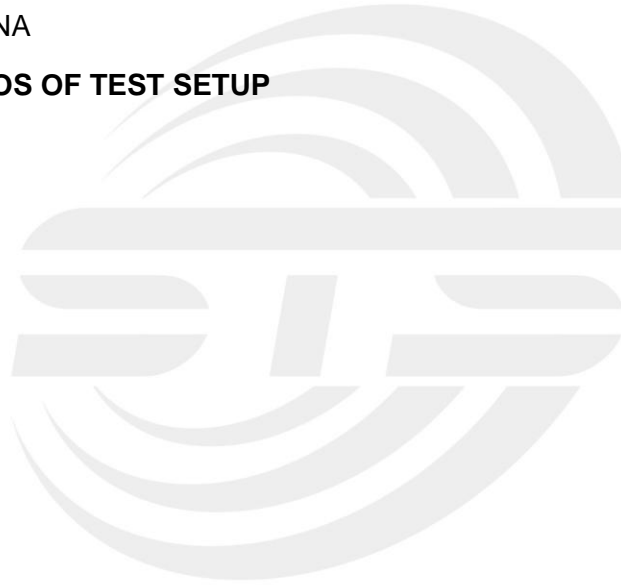




Table of Contents	Page
<b>1. SUMMARY OF TEST RESULTS</b>	<b>6</b>
1.1 TEST FACTORY	7
1.2 MEASUREMENT UNCERTAINTY	7
<b>2. GENERAL INFORMATION</b>	<b>8</b>
2.1 GENERAL DESCRIPTION OF EUT	8
2.2 DESCRIPTION OF TEST MODES	10
2.3 BLOCK DIGRAM SHOWING THE CONFIGURATION OF SYSTEM TESTED	11
2.4 DESCRIPTION OF SUPPORT UNITS	12
2.5 EQUIPMENTS LIST FOR ALL TEST ITEMS	13
<b>3. EMC EMISSION TEST</b>	<b>14</b>
3.1 CONDUCTED EMISSION MEASUREMENT	14
3.2 RADIATED EMISSION MEASUREMENT	18
<b>4. CONDUCTED SPURIOUS &amp; BAND EDGE EMISSION</b>	<b>30</b>
4.1 APPLIED PROCEDURES / LIMIT	30
4.2 TEST PROCEDURE	30
4.3 DEVIATION FROM STANDARD	30
4.4 TEST SETUP	30
4.5 EUT OPERATION CONDITIONS	30
4.6 TEST RESULTS	31
<b>5. POWER SPECTRAL DENSITY TEST</b>	<b>43</b>
5.1 APPLIED PROCEDURES / LIMIT	43
5.2 TEST PROCEDURE	43
5.3 DEVIATION FROM STANDARD	43
5.4 TEST SETUP	43
5.5 EUT OPERATION CONDITIONS	43
5.6 TEST RESULTS	44
<b>6. BANDWIDTH TEST</b>	<b>52</b>
6.1 APPLIED PROCEDURES / LIMIT	52
6.2 TEST PROCEDURE	52
6.3 DEVIATION FROM STANDARD	52
6.4 TEST SETUP	52
6.5 EUT OPERATION CONDITIONS	52
6.6 TEST RESULTS	53



Table of Contents	Page
<b>7. PEAK OUTPUT POWER TEST</b>	<b>61</b>
7.1 APPLIED PROCEDURES / LIMIT	61
7.2 TEST PROCEDURE	61
7.3 DEVIATION FROM STANDARD	61
7.4 TEST SETUP	61
7.5 EUT OPERATION CONDITIONS	61
7.6 TEST RESULTS	62
<b>8. ANTENNA REQUIREMENT</b>	<b>63</b>
8.1 STANDARD REQUIREMENT	63
8.2 EUT ANTENNA	63
<b>APPENDIX - PHOTOS OF TEST SETUP</b>	<b>64</b>





**Revision History**

Rev.	Issue Date	Report NO.	Effect Page	Contents
00	30 June. 2016	STS1606154F01	ALL	Initial Issue





## 1. SUMMARY OF TEST RESULTS

Test procedures according to the technical standards:  
KDB 558074 D01 DTS Meas Guidance v03r04

FCC Part15 (15.247) , Subpart C			
Standard Section	Test Item	Judgment	Remark
15.207	Conducted Emission	PASS	
15.247 (a)(2)	6dB Bandwidth	PASS	
15.247 (b)(3)	Output Power	PASS	
15.247 (c)	Radiated Spurious Emission	PASS	
15.247 (d)	Conducted Spurious & Band Edge Emission	PASS	
15.247 (e)	Power Spectral Density	PASS	
15.205	Radiated Band Edge Emission	PASS	
15.203	Antenna Requirement	PASS	

### NOTE:

(1) "N/A" denotes test is not applicable in this Test Report

(2) all tests are according to ANSI C63.10-2013 .



## 1.1 TEST FACTORY

Shenzhen STS Test Services Co., Ltd.

Add. : 1/F., Building B, Zhuoke Science Park, No.190,Chongqing Road,  
Fuyong Street, Bao'an District, Shenzhen, Guangdong,China

CNAS Registration No.: L7649;

FCC Registration No.: 842334; IC Registration No.: 12108A-1

## 1.2 MEASUREMENT UNCERTAINTY

The reported uncertainty of measurement  $y \pm U$ , where expanded uncertainty  $U$  is based on a standard uncertainty multiplied by a coverage factor of  $k=2$ , providing a level of confidence of approximately 95 %.

No.	Item	Uncertainty
1	Conducted Emission (9KHz-150KHz)	$\pm 2.88\text{dB}$
2	Conducted Emission (150KHz-30MHz)	$\pm 2.67\text{dB}$
3	RF power,conducted	$\pm 0.70\text{dB}$
4	Spurious emissions,conducted	$\pm 1.19\text{dB}$
5	All emissions,radiated(<30M) (9KHz-30MHz)	$\pm 2.45\text{dB}$
6	All emissions,radiated(<1G) 30MHz-200MHz	$\pm 2.83\text{dB}$
7	All emissions,radiated(<1G) 200MHz-1000MHz	$\pm 2.94\text{dB}$
8	All emissions,radiated(>1G)	$\pm 3.03\text{dB}$
9	Temperature	$\pm 0.5^{\circ}\text{C}$
10	Humidity	$\pm 2\%$



## 2. GENERAL INFORMATION

### 2.1 GENERAL DESCRIPTION OF EUT

Equipment	Wireless Adapter														
Trade Name	EDUP														
Model Name	EP-DB1607														
Series Model	EP-DB1608														
Model Difference	Only different in model name														
Product Description	<p>The EUT is a Wireless Adapter</p> <table border="1"><tr><td>Operation Frequency:</td><td>802.11b/g/n 20: 2412~2462 MHz 802.11n(40MHz):2422~2452MHz</td></tr><tr><td>Modulation Type:</td><td>CCK/BPSK/QPSK/16QAM</td></tr><tr><td>Bit Rate of Transmitter</td><td>802.11b:11/5.5/2/1 Mbps 802.11g:54/48/36/24/18/12/9/6 Mbps 802.11n(20MHz):65/58.5/52/39/26/19.5/13/6.5 Mbps 802.11n(40MHz):135/121.5/108/81/54/40.5/37/13.5 Mbps</td></tr><tr><td>Number Of Channel</td><td>802.11b/g/n20: 11CH 802.11n 40: 7CH</td></tr><tr><td>Antenna Designation:</td><td>Please see Note 3.</td></tr><tr><td>Antenna Gain (dBi)</td><td>2 dBi</td></tr><tr><td>Duty Cycle</td><td>&gt;98%</td></tr></table>	Operation Frequency:	802.11b/g/n 20: 2412~2462 MHz 802.11n(40MHz):2422~2452MHz	Modulation Type:	CCK/BPSK/QPSK/16QAM	Bit Rate of Transmitter	802.11b:11/5.5/2/1 Mbps 802.11g:54/48/36/24/18/12/9/6 Mbps 802.11n(20MHz):65/58.5/52/39/26/19.5/13/6.5 Mbps 802.11n(40MHz):135/121.5/108/81/54/40.5/37/13.5 Mbps	Number Of Channel	802.11b/g/n20: 11CH 802.11n 40: 7CH	Antenna Designation:	Please see Note 3.	Antenna Gain (dBi)	2 dBi	Duty Cycle	>98%
Operation Frequency:	802.11b/g/n 20: 2412~2462 MHz 802.11n(40MHz):2422~2452MHz														
Modulation Type:	CCK/BPSK/QPSK/16QAM														
Bit Rate of Transmitter	802.11b:11/5.5/2/1 Mbps 802.11g:54/48/36/24/18/12/9/6 Mbps 802.11n(20MHz):65/58.5/52/39/26/19.5/13/6.5 Mbps 802.11n(40MHz):135/121.5/108/81/54/40.5/37/13.5 Mbps														
Number Of Channel	802.11b/g/n20: 11CH 802.11n 40: 7CH														
Antenna Designation:	Please see Note 3.														
Antenna Gain (dBi)	2 dBi														
Duty Cycle	>98%														
Channel List	Please refer to the Note 2.														
Power rating	DC 5V, 500mA														
Hardware version number	V1.0														
Software version number	1027.6.417.2015														
Connecting I/O Port(s)	Please refer to the User's Manual														

Note:

- 1 For a more detailed features description, please refer to the manufacturer's specifications or the User's Manual.





2

Channel List for 802.11b/g/n(20MHz)							
Channel	Frequency (MHz)	Channel	Frequency (MHz)	Channel	Frequency (MHz)	Channel	Frequency (MHz)
01	2412	04	2427	07	2442	10	2457
02	2417	05	2432	08	2447	11	2462
03	2422	06	2437	09	2452		

Channel List for 802.11n(40MHz)							
Channel	Frequency (MHz)	Channel	Frequency (MHz)	Channel	Frequency (MHz)	Channel	Frequency (MHz)
03	2422	06	2437	09	2452		
04	2427	07	2442				
05	2432	08	2447				

3

Ant	Brand	Model Name	Antenna Type	Connector	Gain (dBi)	NOTE
A	EDUP	EP-DB1607	Dipole Antenna	non-standard	2	WIFI Antenna



## 2.2 DESCRIPTION OF TEST MODES

Each of these EUT operation mode(s) or test configuration mode(s) mentioned above was evaluated respectively.

Pretest Mode	Description	Data Rate
Mode 1	TX IEEE 802.11b CH1	1 Mbps
Mode 2	TX IEEE 802.11b CH6	1 Mbps
Mode 3	TX IEEE 802.11 b CH11	1 Mbps
Mode 4	TX IEEE 802.11g CH1	6 Mbps
Mode 5	TX IEEE 802.11g CH6	6 Mbps
Mode 6	TX IEEE 802.11g CH11	6 Mbps
Mode 7	TX IEEE 802.11n HT20 CH1	MCS 0
Mode 8	TX IEEE 802.11n HT20 CH6	MCS 0
Mode 9	TX IEEE 802.11n HT20 CH11	MCS 0
Mode 10	TX IEEE 802.11n HT40 CH3	MCS 0
Mode 11	TX IEEE 802.11n HT40 CH6	MCS 0
Mode 12	TX IEEE 802.11n HT40 CH9	MCS 0

Note:

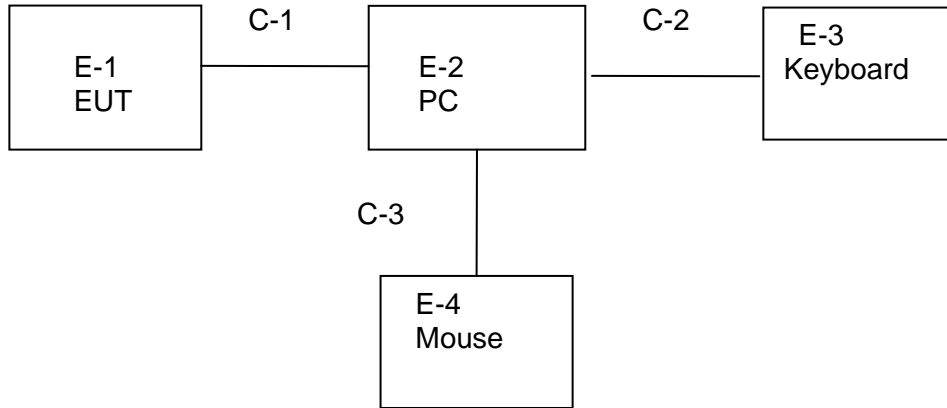
- (1) Final test mode of conducted test items and radiated spurious emissions are considering the modulation and worse data rates from the power table.
- (2) We have be tested for all avaiable U.S. voltage and frequencies(For 120V,50/60Hz and 240V, 50/60Hz) for which the device is capable of operation.
- (3) The EUT was programmed to be in continuously transmitting mode and the transmit duty cycle is not less than 98%.

### AC Conducted Emission

Test Case	
AC Conducted Emission	Mode13: Keeping TX + WLAN Link



2.3 BLOCK DIGRAM SHOWING THE CONFIGURATION OF SYSTEM TESTED





## 2.4 DESCRIPTION OF SUPPORT UNITS

The EUT has been tested as an independent unit together with other necessary accessories or support units. The following support units or accessories were used to form a representative test configuration during the tests.

Item	Equipment	Mfr/Brand	Model/Type No.	Serial No.	Note
E-1	Wireless Adapter	EDUP	EP-DB1607	N/A	EUT
E-2	PC	4CV428DQXR	500-320cx	N/A	N/A
E-3	Keyboard	HP	PR1101U	N/A	N/A
E-4	Mouse	MOTOSPEED	F66	N/A	N/A

Item	Shielded Type	Ferrite Core	Length	Note
C-1	USB Cable (FTP)	NO	100cm	N/A
C-2	USB Cable (FTP)	NO	100cm	N/A
C-3	USB Cable (FTP)	NO	110cm	N/A

Note:

- (1) The support equipment was authorized by Declaration of Confirmation.
- (2) For detachable type I/O cable should be specified the length in cm in 『Length』 column.
- (3) “YES” is means “shielded” “with core”; “NO” is means “unshielded” “without core”.



## 2.5 EQUIPMENTS LIST FOR ALL TEST ITEMS

## Radiation Test equipment

Kind of Equipment	Manufacturer	Type No.	Serial No.	Last calibration	Calibrated until
Spectrum Analyzer	Agilent	E4407B	MY50140340	2015.10.25	2016.10.24
Test Receiver	R&S	ESCI	101427	2015.10.25	2016.10.24
Bilog Antenna	TESEQ	CBL6111D	34678	2015.11.25	2016.11.24
Horn Antenna	Schwarzbeck	BBHA 9120D	9120D-1343	2016.03.06	2017.03.05
Horn Antenna	Schwarzbeck	BBHA 9170	9170-0741	2016.03.06	2017.03.05
50Ω Coaxial Switch	Anritsu	MP59B	6200264416	2016.06.06	2016.06.05
PreAmplifier	Agilent	8449B	60538	2015.10.25	2016.10.24
Loop Antenna	ARA	PLA-1030/B	1029	2016.06.08	2017.06.07
Preamplifier	Agilent	8449B	60538	2015.11.05	2016.11.05
Low frequency cable	EM	R01	N/A	N/A	N/A
High frequency cable	SCHWARZBECK	AK9515H	SN-96286/96287	N/A	N/A

## Conduction Test equipment

Kind of Equipment	Manufacturer	Type No.	Serial No.	Last calibration	Calibrated until
EMI Test Receiver	R&S	ESPI	102086	2015.11.20	2016.11.19
LISN	R&S	ENV216	101242	2015.10.25	2016.10.24
LISN	EMCO	3810/2NM	000-23625	2015.10.25	2016.10.24
Conduction Cable	EM	C01	N/A	N/A	N/A

## RF Connected Test

Kind of Equipment	Manufacturer	Type No.	Serial No.	Last calibration	Calibrated until
USB RF power sensor	DARE	RPR3006W	15I00041SNO03	2015.10.25	2016.10.24
Spectrum Analyzer	Agilent	E4407B	MY50140340	2015.10.25	2016.10.24
Signal Analyzer	Agilent	N9020A	MY49100060	2015.11.18	2016.11.17



### 3. EMC EMISSION TEST

#### 3.1 CONDUCTED EMISSION MEASUREMENT

##### 3.1.1 POWER LINE CONDUCTED EMISSION LIMITS

operating frequency band. In case the emission fall within the restricted band specified on Part 15.207(a) limit in the table below has to be followed.

FREQUENCY (MHz)	Conducted Emission limit (dBuV)	
	Quasi-peak	Average
0.15 -0.5	66 - 56 *	56 - 46 *
0.50 -5.0	56.00	46.00
5.0 -30.0	60.00	50.00

Note:

- (1) The tighter limit applies at the band edges.
- (2) The limit of " \* " marked band means the limitation decreases linearly with the logarithm of the frequency in the range.

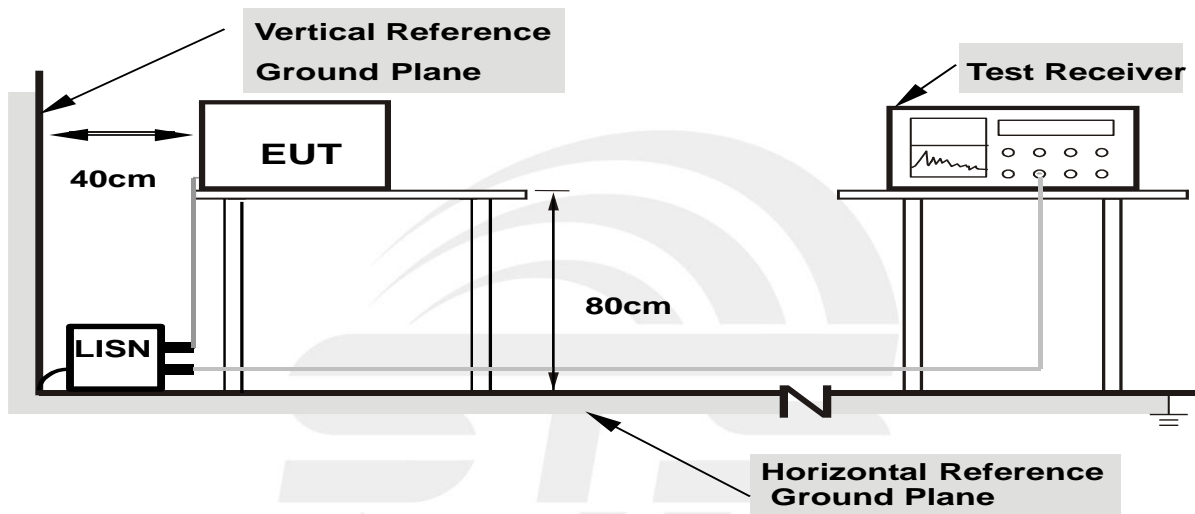
The following table is the setting of the receiver

Receiver Parameters	Setting
Attenuation	10 dB
Start Frequency	0.15 MHz
Stop Frequency	30 MHz
IF Bandwidth	9 kHz

### 3.1.2 TEST PROCEDURE

- a. The EUT was placed 0.4 meters from the horizontal ground plane with EUT being connected to the power mains through a line impedance stabilization network (LISN). All other support equipments powered from additional LISN(s). The LISN provide 50 Ohm/ 50uH of coupling impedance for the measuring instrument.
- b. Interconnecting cables that hang closer than 40 cm to the ground plane shall be folded back and forth in the center forming a bundle 30 to 40 cm long.
- c. I/O cables that are not connected to a peripheral shall be bundled in the center. The end of the cable may be terminated, if required, using the correct terminating impedance. The overall length shall not exceed 1 m.
- d. LISN at least 80 cm from nearest part of EUT chassis.
- e. For the actual test configuration, please refer to the related Item –EUT Test Photos.

### 3.1.3 TEST SETUP



- Note: 1.Support units were connected to second LISN.**  
**2.Both of LISNs (AMN) are 80 cm from EUT and at least 80 from other units and other metal planes**

### 3.1.4 EUT OPERATING CONDITIONS

The EUT was configured for testing in a typical fashion (as a customer would normally use it). The EUT has been programmed to continuously transmit during test. This operating condition was tested and used to collect the included data.



3.1.5 TEST RESULT

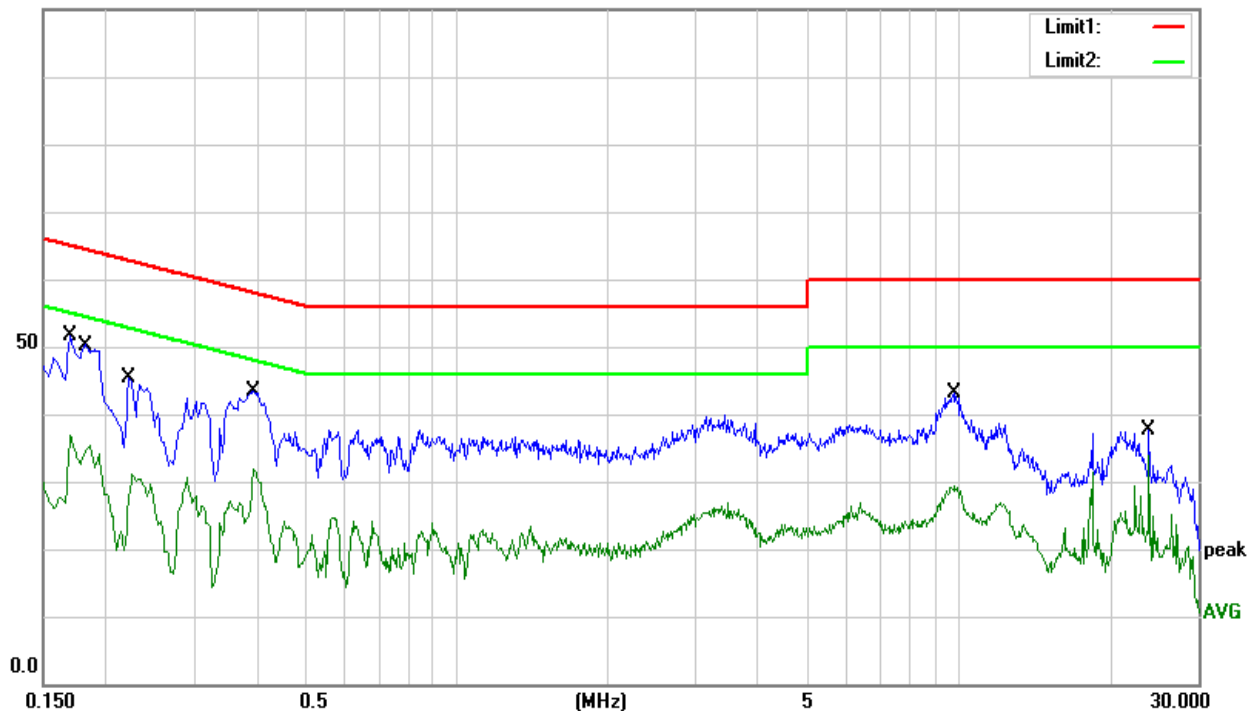
Temperature:	26 °C	Relative Humidity:	54%
Pressure:	1010hPa	Phase:	L
Mode :	Mode 13		

Frequency (MHz)	Reading (dBUV)	Correct Factor(dB)	Result (dBUV)	Limit (dBUV)	Margin (dB)	Remark
0.1716	39.45	9.23	48.68	64.88	-16.20	QP
0.1716	25.41	9.23	34.64	54.88	-20.24	AVG
0.1856	37.20	9.23	46.43	64.23	-17.80	QP
0.1856	23.61	9.23	32.84	54.23	-21.39	AVG
0.2218	30.49	9.21	39.70	62.75	-23.05	QP
0.2218	16.79	9.21	26.00	52.75	-26.75	AVG
0.3967	32.00	9.43	41.43	57.92	-16.49	QP
0.3967	20.67	9.43	30.10	47.92	-17.82	AVG
9.8358	26.70	9.49	36.19	60.00	-23.81	QP
9.8358	18.18	9.49	27.67	50.00	-22.33	AVG
24.0011	25.05	9.75	34.80	60.00	-25.20	QP
24.0011	24.24	9.75	33.99	50.00	-16.01	AVG

Remark:

1. Margin = Result (Result =Reading + Factor )–Limit

100.0 dBUV







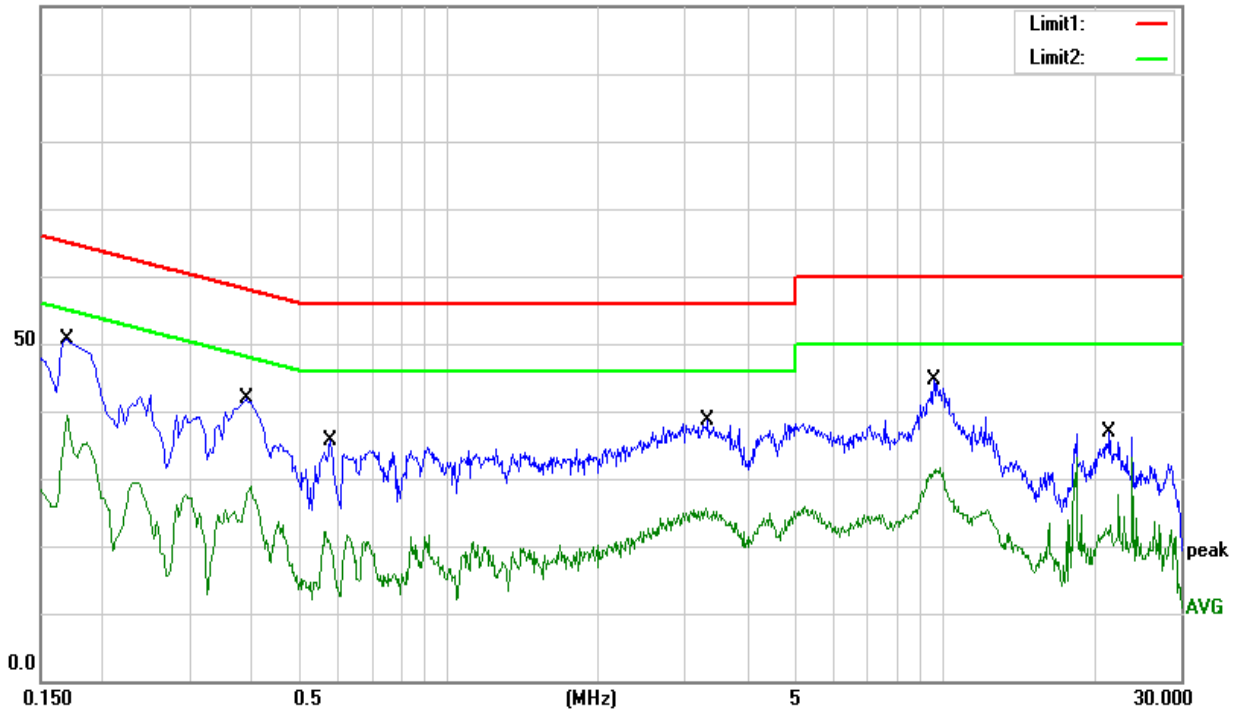
Temperature:	26 °C	Relative Humidity:	54%
Pressure:	1010hPa	Phase:	N
Mode :	Mode 13		

Frequency (MHz)	Reading (dBuV)	Correct Factor(dB)	Result (dBuV)	Limit (dBuV)	Margin (dB)	Remark
0.1684	38.66	9.23	47.89	65.04	-17.15	QP
0.1684	23.19	9.23	32.42	55.04	-22.62	AVG
0.3885	30.46	9.23	39.69	58.10	-18.41	QP
0.3885	16.25	9.23	25.48	48.10	-22.62	AVG
0.5746	22.19	9.18	31.37	56.00	-24.63	QP
0.5746	11.49	9.18	20.67	46.00	-25.33	AVG
3.3190	23.83	9.26	33.09	56.00	-22.91	QP
3.3190	14.72	9.26	23.98	46.00	-22.02	AVG
9.4630	28.19	9.38	37.57	60.00	-22.43	QP
9.4630	20.06	9.38	29.44	50.00	-20.56	AVG
21.5350	17.09	9.81	26.90	60.00	-33.10	QP
21.5350	10.20	9.81	20.01	50.00	-29.99	AVG

Remark:

1. Margin = Result (Result =Reading + Factor )–Limit

100.0 dBuV





### 3.2 RADIATED EMISSION MEASUREMENT

#### 3.2.1 RADIATED EMISSION LIMITS

in any 100 kHz bandwidth outside the operating frequency band. In case the emission fall within the restricted band specified on Part 15. 205(a)&209(a) limit in the table below has to be followed.

LIMITS OF RADIATED EMISSION MEASUREMENT (0.009MHz - 1000MHz)

Frequencies (MHz)	Field Strength (micovolts/meter)	Measurement Distance (meters)
0.009~0.490	2400/F(KHz)	300
0.490~1.705	24000/F(KHz)	30
1.705~30.0	30	30
30~88	100	3
88~216	150	3
216~960	200	3
Above 960	500	3

LIMITS OF RADIATED EMISSION MEASUREMENT (1000MHz-25GHz)

FREQUENCY (MHz)	Class B (dBuV/m) (at 3M)	
	PEAK	AVERAGE
Above 1000	74	54

Notes:

- (1) The limit for radiated test was performed according to FCC PART 15C.
- (2) The tighter limit applies at the band edges.
- (3) Emission level (dBuV/m)=20log Emission level (uV/m).

For Radiated Emission

Spectrum Parameter	Setting
Attenuation	Auto
Detector	Peak
Start Frequency	1000 MHz(Peak/AV)
Stop Frequency	10 <sup>th</sup> carrier hamonic(Peak/AV)
RB / VB (emission in restricted band)	1 MHz /3MHz

For Band edge

Spectrum Parameter	Setting
Detector	Peak
Start/Stop Frequency	Lower Band Edge: 2300 to 2430 MHz Upper Band Edge: 2450 to 2500 MHz
RB / VB (emission in restricted band)	1 MHz /3MHz



Receiver Parameter	Setting
Attenuation	Auto
Start ~ Stop Frequency	9kHz~90kHz / RB 200Hz for PK & AV
Start ~ Stop Frequency	90kHz~110kHz / RB 200Hz for QP
Start ~ Stop Frequency	110kHz~490kHz / RB 200Hz for PK & AV
Start ~ Stop Frequency	490kHz~30MHz / RB 9kHz for QP
Start ~ Stop Frequency	30MHz~1000MHz / RB 120kHz for QP

### 3.2.2 TEST PROCEDURE

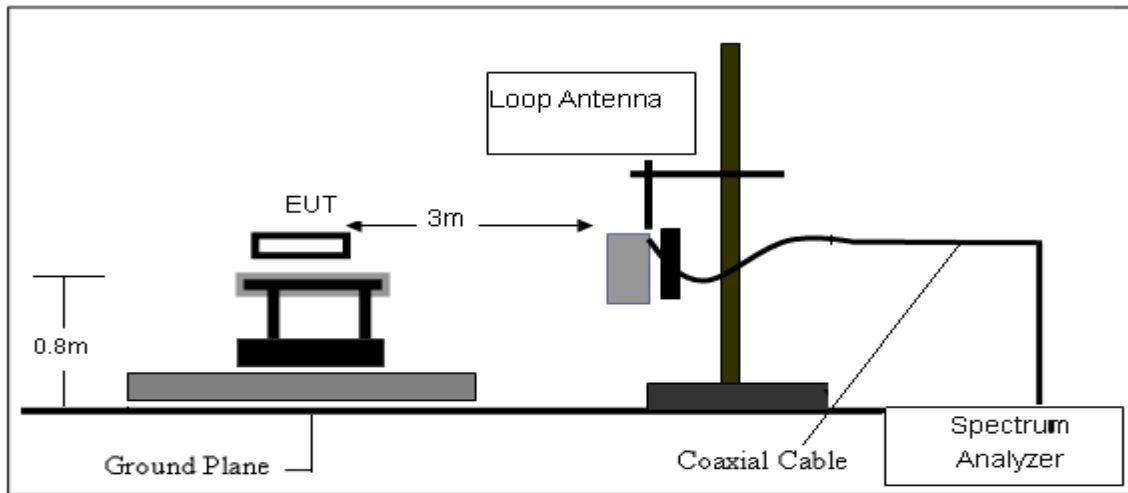
- a. The measuring distance of at 3 m shall be used for measurements at frequency 0.009MHz up to 1GHz, above 1GHz.
- b. The EUT was placed on the top of a rotating table 0.8 meters(above 1GHz is 1.5 m) above the ground at a 3 meter anechoic chamber. The table was rotated 360 degrees to determine the position of the highest radiation.
- c. The height of the equipment shall be 0.8 m(above 1GHz is 1.5 m); the height of the test antenna shall vary between 1 m to 4 m. Horizontal and vertical polarizations of the antenna are set to make the measurement
- d. The initial step in collecting conducted emission data is a spectrum analyzer peak detector mode pre-scanning the measurement frequency range. Significant peaks are then marked and then Quasi Peak detector mode re-measured.
- e. If the Peak Mode measured value compliance with and lower than Quasi Peak Mode Limit, the EUT shall be deemed to meet QP Limits and then no additional QP Mode measurement performed.
- f. For the actual test configuration, please refer to the related Item –EUT Test Photos.

**Note:**

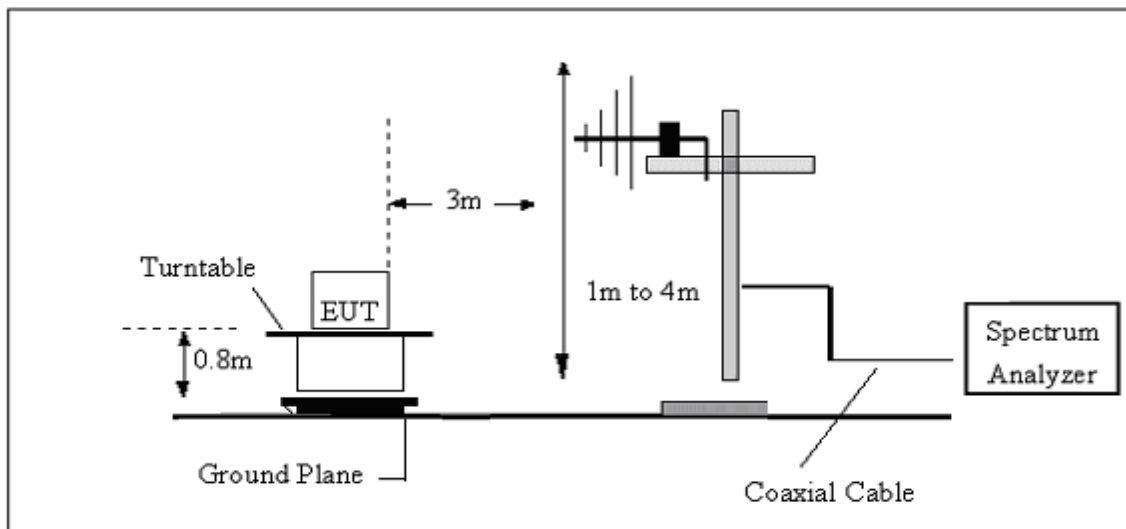
Both horizontal and vertical antenna polarities were tested and performed test to three orthogonal axis. The worst case emissions were reported

### 3.2.3 TEST SETUP

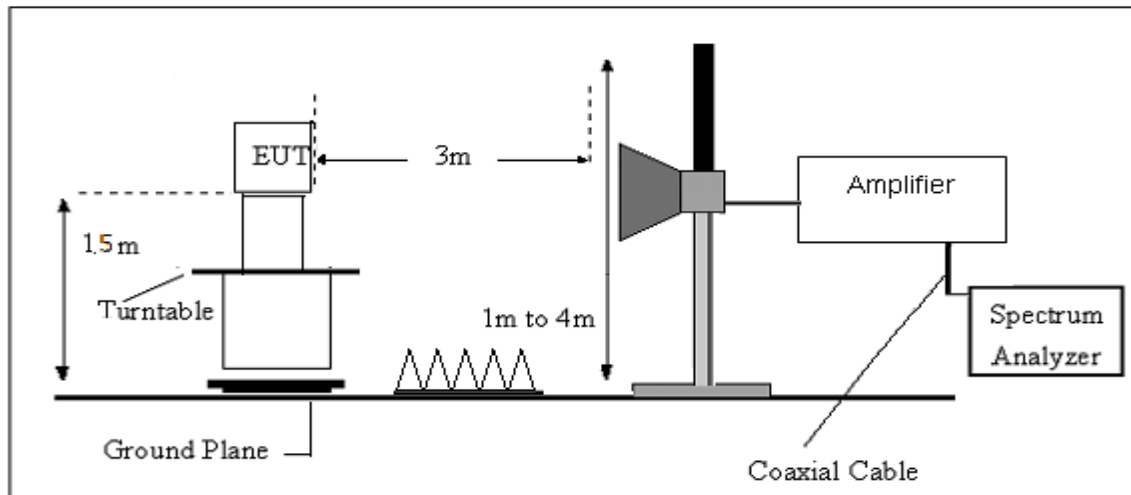
#### (A) Radiated Emission Test-Up Frequency Below 30MHz



#### (B) Radiated Emission Test-Up Frequency 30MHz~1GHz



#### (C) Radiated Emission Test-Up Frequency Above 1GHz





### 3.2.4 EUT OPERATING CONDITIONS

The EUT tested system was configured as the statements of 2.3 Unless otherwise a special operating condition is specified in the follows during the testing.





## 3.2.5 TEST RESULT

9KHz-30MHz

Temperature:	20 °C	Relative Humidity:	48%
Pressure:	1010 hPa	Test Voltage :	AC 120V/60Hz
Test Mode :	TX Mode	Polarization :	--

Freq. (MHz)	Reading (dBuV/m)	Limit (dBuV/m)	Margin (dB)	State P/F	Test Result
--	--	--	--	--	PASS
--	--	--	--	--	PASS

## Note:

The amplitude of spurious emissions which are attenuated by more than 20dB below the permissible value has no need to be reported.

Distance extrapolation factor =  $40 \log(\text{specific distance}/\text{test distance})$ (dB);

Limit line = specific limits(dBuV) + distance extrapolation factor.



(30MHz - 1000MHz)

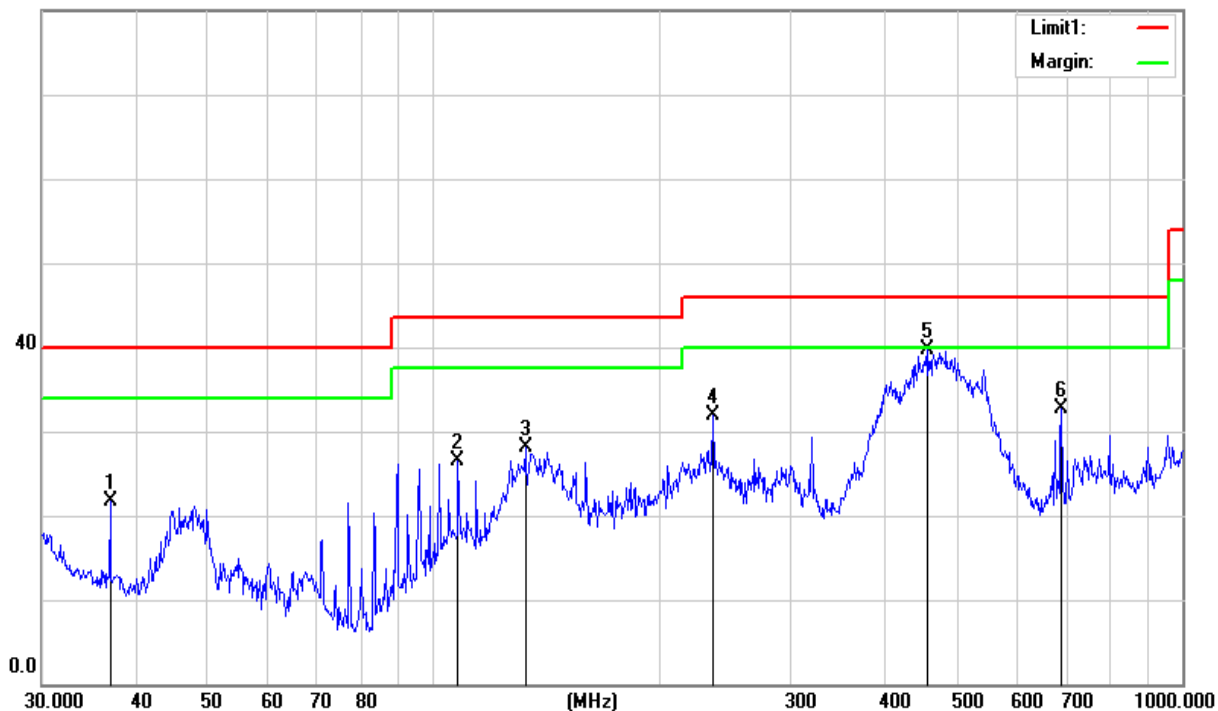
Temperature:	20 °C	Relative Humidity:	48%
Pressure:	1010 hPa	Test Voltage :	AC 120V/60Hz
Test Mode :	Mode 1/2/3/4/5/6/7/8/9/10/11/12 (Mode 1-1M worst mode)	Polarization :	Horizontal

Frequency (MHz)	Reading (dBuV)	Correct Factor(dB/m)	Result (dBuV/m)	Limit (dBuV/m)	Margin (dB)	Remark
37.0250	36.42	-14.79	21.63	40.00	-18.37	QP
107.8876	45.05	-18.52	26.53	43.50	-16.97	QP
132.6850	45.66	-17.54	28.12	43.50	-15.38	QP
236.6447	49.89	-17.99	31.90	46.00	-14.10	QP
457.5073	49.96	-10.22	39.74	46.00	-6.26	QP
689.5643	38.22	-5.57	32.65	46.00	-13.35	QP

Remark:

1. All readings are Quasi-Peak and Average values.
2. Margin = Result (Result = Reading + Factor) – Limit

80.0 dBuV/m





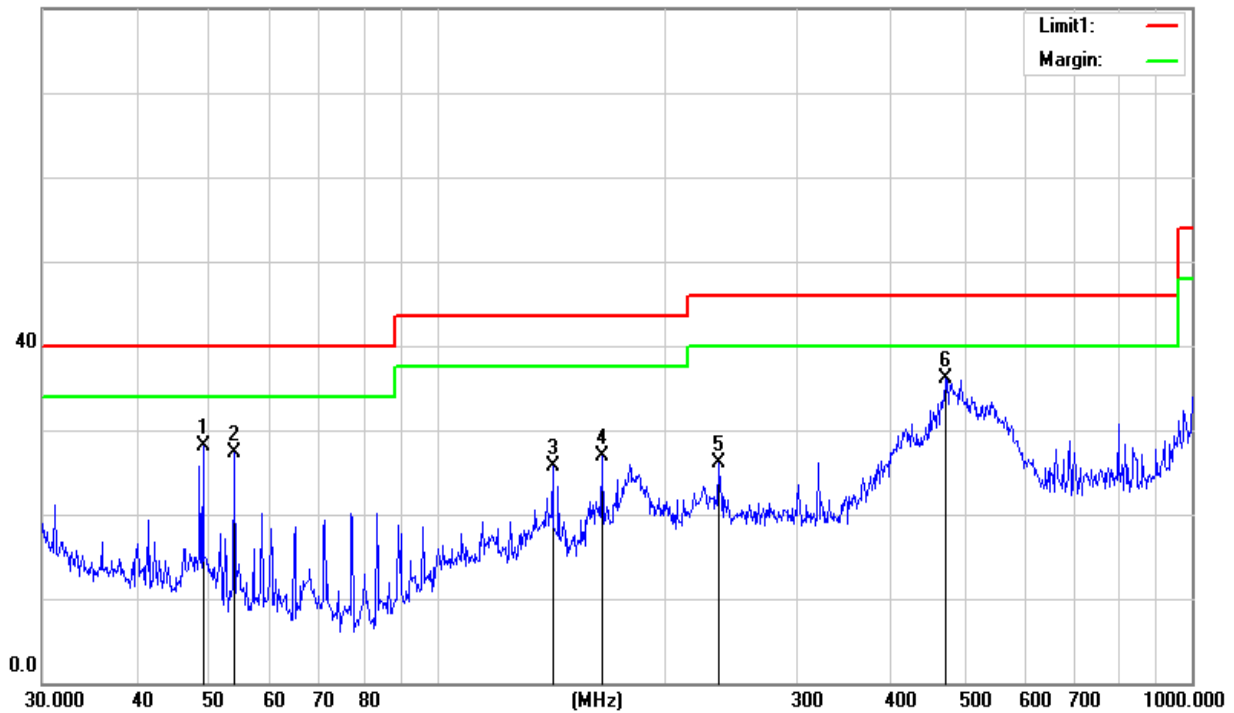
Temperature:	20 °C	Relative Humidity:	48%
Pressure:	1010 hPa	Test Voltage :	AC 120V/60Hz
Test Mode :	Mode 1/2/3/4/5/6/7/8/9/10/11/12 (Mode 1-1M worst mode)	Polarization :	Vertical

Frequency (MHz)	Reading (dBuV)	Correct Factor(dB/m)	Result (dBuV/m)	Limit (dBuV/m)	Margin (dB)	Remark
49.0145	49.12	-20.97	28.15	40.00	-11.85	QP
53.8817	49.99	-22.59	27.40	40.00	-12.60	QP
142.3243	43.31	-17.62	25.69	43.50	-17.81	QP
165.4866	45.87	-18.95	26.92	43.50	-16.58	QP
235.8163	44.24	-18.06	26.18	46.00	-19.82	QP
472.1760	45.87	-9.69	36.18	46.00	-9.82	QP

Remark:

1. All readings are Quasi-Peak and Average values.
2. Margin = Result (Result = Reading + Factor) – Limit

80.0 dBuV/m







(1000MHz-25GHz)

### 802.11b Low Channel

Meter		Antenna		Orrected	Emission		Limits		Margin	Detector	
Frequency	Reading	Amplifier	Loss	Factor	Factor	Level	Limits	Margin		Type	Comment
(MHz)	(dBμV)	(dB)	(dB)	(dB/m)	(dB)	(dBμV/m)	(dBμV/m)	(dB)			
Low Channel (2412 MHz)											
3265.10	49.99	44.70	6.70	28.20	-9.80	40.19	74.00	-33.81		PK	Vertical
3265.10	39.93	44.70	6.70	28.20	-9.80	30.13	54.00	-23.87		AV	Vertical
3265.06	49.94	44.70	6.70	28.20	-9.80	40.14	74.00	-33.86		PK	Horizontal
3265.06	39.96	44.70	6.70	28.20	-9.80	30.16	54.00	-23.84		AV	Horizontal
4824.78	60.22	44.20	9.04	31.60	-3.56	56.66	74.00	-17.34		PK	Vertical
4824.78	50.30	44.20	9.04	31.60	-3.56	46.74	54.00	-7.26		AV	Vertical
4824.81	60.24	44.20	9.04	31.60	-3.56	56.68	74.00	-17.32		PK	Horizontal
4824.81	50.22	44.20	9.04	31.60	-3.56	46.66	54.00	-7.34		AV	Horizontal
5360.09	47.17	44.20	9.86	32.00	-2.34	44.83	74.00	-29.17		PK	Vertical
5360.09	39.13	44.20	9.86	32.00	-2.34	36.79	54.00	-17.21		AV	Vertical
5360.07	47.20	44.20	9.86	32.00	-2.34	44.86	74.00	-29.14		PK	Horizontal
5360.07	39.13	44.20	9.86	32.00	-2.34	36.79	54.00	-17.21		AV	Horizontal
7236.18	52.66	43.50	11.40	35.50	3.40	56.06	74.00	-17.94		PK	Vertical
7236.18	44.64	43.50	11.40	35.50	3.40	48.04	54.00	-5.96		AV	Vertical
7236.16	52.65	43.50	11.40	35.50	3.40	56.05	74.00	-17.95		PK	Horizontal
7236.16	44.61	43.50	11.40	35.50	3.40	48.01	54.00	-5.99		AV	Horizontal
11036.22	41.93	43.60	14.30	39.50	10.20	52.13	74.00	-21.87		PK	Vertical
11036.22	31.84	43.60	14.30	39.50	10.20	42.04	54.00	-11.96		AV	Vertical
11036.47	41.89	43.60	14.30	39.50	10.20	52.09	74.00	-21.91		PK	Horizontal
11036.47	31.89	43.60	14.30	39.50	10.20	42.09	54.00	-11.91		AV	Horizontal
13299.62	41.71	42.60	15.90	38.90	12.20	53.91	74.00	-20.09		PK	Vertical
13299.62	31.77	42.60	15.90	38.90	12.20	43.97	54.00	-10.03		AV	Vertical
13299.74	41.78	42.60	15.90	38.90	12.20	53.98	74.00	-20.02		PK	Horizontal
13299.74	30.72	42.60	15.90	38.90	12.20	42.92	54.00	-11.08		AV	Horizontal
16000.15	41.77	42.70	18.00	37.10	12.40	54.17	74.00	-19.83		PK	Vertical
16000.15	31.76	42.70	18.00	37.10	12.40	44.16	54.00	-9.84		AV	Vertical
16000.04	41.77	42.70	18.00	37.10	12.40	54.17	74.00	-19.83		PK	Horizontal
16000.04	31.05	42.70	18.00	37.10	12.40	43.45	54.00	-10.55		AV	Horizontal
17998.14	31.87	42.70	19.40	46.50	23.20	55.07	74.00	-18.93		PK	Vertical
17998.14	21.90	42.70	19.40	46.50	23.20	45.10	54.00	-8.90		AV	Vertical
17998.01	31.91	42.70	19.40	46.50	23.20	55.11	74.00	-18.89		PK	Horizontal
17998.01	21.95	42.70	19.40	46.50	23.20	45.15	54.00	-8.85		AV	Horizontal



### 802.11b Mid Channel

Frequency (MHz)	Meter		Loss (dB)	Antenna		Emission		Margin (dB)	Detector Type	Comment
	Reading (dBμV)	Amplifier (dB)		Factor (dB/m)	Corrected Factor (dB)	Level (dBμV/m)	Limits (dBμV/m)			
Low Channel (2437 MHz)										
3265.00	49.88	44.70	6.70	28.20	-9.80	40.08	74.00	-33.92	PK	Vertical
3265.00	39.86	44.70	6.70	28.20	-9.80	30.06	54.00	-23.94	AV	Vertical
3264.95	49.85	44.70	6.70	28.20	-9.80	40.05	74.00	-33.95	PK	Horizontal
3264.95	39.86	44.70	6.70	28.20	-9.80	30.06	54.00	-23.94	AV	Horizontal
4874.76	60.15	44.20	9.04	31.60	-3.56	56.59	74.00	-17.41	PK	Vertical
4874.76	50.17	44.20	9.04	31.60	-3.56	46.61	54.00	-7.39	AV	Vertical
4874.70	60.17	44.20	9.04	31.60	-3.56	56.61	74.00	-17.39	PK	Horizontal
4874.70	50.16	44.20	9.04	31.60	-3.56	46.60	54.00	-7.40	AV	Horizontal
5359.97	47.07	44.20	9.86	32.00	-2.34	44.73	74.00	-29.27	PK	Vertical
5359.97	39.09	44.20	9.86	32.00	-2.34	36.75	54.00	-17.25	AV	Vertical
5360.00	47.14	44.20	9.86	32.00	-2.34	44.80	74.00	-29.20	PK	Horizontal
5360.00	39.08	44.20	9.86	32.00	-2.34	36.74	54.00	-17.26	AV	Horizontal
7336.05	52.57	43.50	11.40	35.50	3.40	55.97	74.00	-18.03	PK	Vertical
7336.05	44.56	43.50	11.40	35.50	3.40	47.96	54.00	-6.04	AV	Vertical
7336.04	52.57	43.50	11.40	35.50	3.40	55.97	74.00	-18.03	PK	Horizontal
7336.04	44.54	43.50	11.40	35.50	3.40	47.94	54.00	-6.06	AV	Horizontal
11036.11	41.84	43.60	14.30	39.50	10.20	52.04	74.00	-21.96	PK	Vertical
11036.11	31.78	43.60	14.30	39.50	10.20	41.98	54.00	-12.02	AV	Vertical
11036.11	41.83	43.60	14.30	39.50	10.20	52.03	74.00	-21.97	PK	Horizontal
11036.11	31.83	43.60	14.30	39.50	10.20	42.03	54.00	-11.97	AV	Horizontal
13299.71	41.62	42.60	15.90	38.90	12.20	53.82	74.00	-20.18	PK	Vertical
13299.71	31.63	42.60	15.90	38.90	12.20	43.83	54.00	-10.17	AV	Vertical
13299.62	41.72	42.60	15.90	38.90	12.20	53.92	74.00	-20.08	PK	Horizontal
13299.62	30.66	42.60	15.90	38.90	12.20	42.86	54.00	-11.14	AV	Horizontal
15999.98	41.72	42.70	18.00	37.10	12.40	54.12	74.00	-19.88	PK	Vertical
15999.98	31.67	42.70	18.00	37.10	12.40	44.07	54.00	-9.93	AV	Vertical
15999.99	41.70	42.70	18.00	37.10	12.40	54.10	74.00	-19.90	PK	Horizontal
15999.99	30.96	42.70	18.00	37.10	12.40	43.36	54.00	-10.64	AV	Horizontal
17998.13	31.83	42.70	19.40	46.50	23.20	55.03	74.00	-18.97	PK	Vertical
17998.13	21.86	42.70	19.40	46.50	23.20	45.06	54.00	-8.94	AV	Vertical
17998.00	31.88	42.70	19.40	46.50	23.20	55.08	74.00	-18.92	PK	Horizontal
17998.00	21.85	42.70	19.40	46.50	23.20	45.05	54.00	-8.95	AV	Horizontal



### 802.11b High Channel

Frequency (MHz)	Meter		Antenna		Orrected	Emission		Margin (dB)	Detector Type	Comment
	Reading (dBμV)	Amplifier (dB)	Loss (dB)	Factor (dB/m)	Factor (dB)	Level (dBμV/m)	Limits (dBμV/m)			
Low Channel (2462 MHz)										
3265.07	49.79	44.70	6.70	28.20	-9.80	39.99	74.00	-34.01	PK	Vertical
3265.07	39.73	44.70	6.70	28.20	-9.80	29.93	54.00	-24.07	AV	Vertical
3265.04	49.73	44.70	6.70	28.20	-9.80	39.93	74.00	-34.07	PK	Horizontal
3265.04	39.79	44.70	6.70	28.20	-9.80	29.99	54.00	-24.01	AV	Horizontal
4924.82	60.06	44.20	9.04	31.60	-3.56	56.50	74.00	-17.50	PK	Vertical
4924.82	50.14	44.20	9.04	31.60	-3.56	46.58	54.00	-7.42	AV	Vertical
4924.78	60.11	44.20	9.04	31.60	-3.56	56.55	74.00	-17.45	PK	Horizontal
4924.78	50.03	44.20	9.04	31.60	-3.56	46.47	54.00	-7.53	AV	Horizontal
5360.04	46.99	44.20	9.86	32.00	-2.34	44.65	74.00	-29.35	PK	Vertical
5360.04	38.97	44.20	9.86	32.00	-2.34	36.63	54.00	-17.37	AV	Vertical
5360.03	47.07	44.20	9.86	32.00	-2.34	44.73	74.00	-29.27	PK	Horizontal
5360.03	39.01	44.20	9.86	32.00	-2.34	36.67	54.00	-17.33	AV	Horizontal
7386.16	52.48	43.50	11.40	35.50	3.40	55.88	74.00	-18.12	PK	Vertical
7386.16	44.49	43.50	11.40	35.50	3.40	47.89	54.00	-6.11	AV	Vertical
7386.20	52.54	43.50	11.40	35.50	3.40	55.94	74.00	-18.06	PK	Horizontal
7386.20	44.47	43.50	11.40	35.50	3.40	47.87	54.00	-6.13	AV	Horizontal
11036.21	41.74	43.60	14.30	39.50	10.20	51.94	74.00	-22.06	PK	Vertical
11036.21	31.71	43.60	14.30	39.50	10.20	41.91	54.00	-12.09	AV	Vertical
11036.19	41.76	43.60	14.30	39.50	10.20	51.96	74.00	-22.04	PK	Horizontal
11036.19	31.77	43.60	14.30	39.50	10.20	41.97	54.00	-12.03	AV	Horizontal
16000.09	41.59	42.70	18.00	37.10	12.40	53.99	74.00	-20.01	PK	Vertical
16000.09	31.60	42.70	18.00	37.10	12.40	44.00	54.00	-10.00	AV	Vertical
16000.05	41.61	42.70	18.00	37.10	12.40	54.01	74.00	-19.99	PK	Horizontal
16000.05	30.88	42.70	18.00	37.10	12.40	43.28	54.00	-10.72	AV	Horizontal
17998.22	31.72	42.70	19.40	46.50	23.20	54.92	74.00	-19.08	PK	Vertical
17998.22	21.76	42.70	19.40	46.50	23.20	44.96	54.00	-9.04	AV	Vertical
17998.09	31.76	42.70	19.40	46.50	23.20	54.96	74.00	-19.04	PK	Horizontal
17998.09	21.80	42.70	19.40	46.50	23.20	45.00	54.00	-9.00	AV	Horizontal

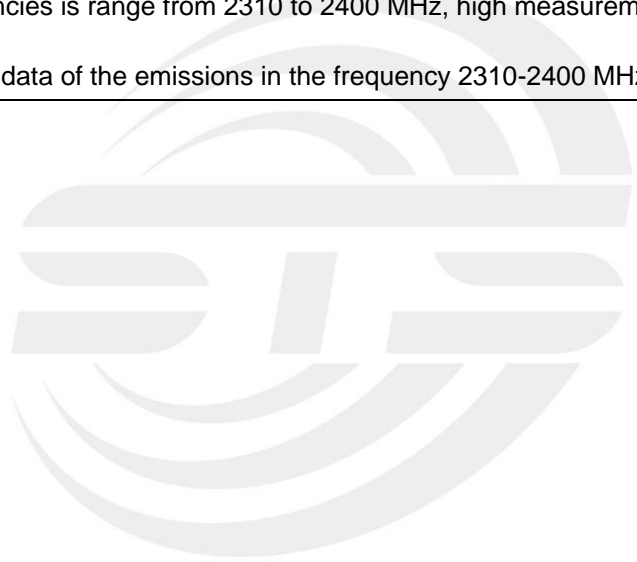


3.2.6 TEST RESULTS (Band edge)

Frequency (MHz)	Meter		Antenna		Orrected Factor (dB)	Emission		Margin (dB)	Detector	
	Reading (dBμV)	Amplifier (dB)	Loss (dB)	Factor (dB/m)		Level (dBμV/m)	Limits (dBμV/m)		Type	Comment
802.11b										
2400.00	69.16	43.80	4.91	25.90	-12.99	56.17	74	-17.83	PK	Vertical
2400.00	54.99	43.80	4.91	25.90	-12.99	42.00	54	-12.00	AV	Vertical
2400.00	70.19	43.80	4.91	25.90	-12.99	57.20	74	-16.80	PK	Horizontal
2400.00	54.17	43.80	4.91	25.90	-12.99	41.18	54	-12.82	AV	Horizontal
2483.50	71.00	43.80	5.12	25.90	-12.78	58.22	74	-15.78	PK	Vertical
2483.50	54.02	43.80	5.12	25.90	-12.78	41.24	54	-12.76	AV	Vertical
2483.50	71.08	43.80	5.12	25.90	-12.78	58.30	74	-15.70	PK	Horizontal
2483.50	54.06	43.80	5.12	25.90	-12.78	41.28	54	-12.72	AV	Horizontal
802.11g										
2400.00	67.95	43.80	4.91	25.90	-12.99	54.96	74	-19.04	PK	Vertical
2400.00	54.12	43.80	4.91	25.90	-12.99	41.13	54	-12.87	AV	Vertical
2400.00	67.13	43.80	4.91	25.90	-12.99	54.14	74	-19.86	PK	Horizontal
2400.00	54.98	43.80	4.91	25.90	-12.99	41.99	54	-12.01	AV	Horizontal
2483.50	67.09	43.80	5.12	25.90	-12.78	54.31	74	-19.69	PK	Vertical
2483.50	54.27	43.80	5.12	25.90	-12.78	41.49	54	-12.51	AV	Vertical
2483.50	67.04	43.80	5.12	25.90	-12.78	54.26	74	-19.74	PK	Horizontal
2483.50	54.15	43.80	5.12	25.90	-12.78	41.37	54	-12.63	AV	Horizontal
802.11n20										
2400.00	67.10	43.80	4.91	25.90	-12.99	54.11	74	-19.89	PK	Vertical
2400.00	54.05	43.80	4.91	25.90	-12.99	41.06	54	-12.94	AV	Vertical
2400.00	67.04	43.80	4.91	25.90	-12.99	54.05	74	-19.95	PK	Horizontal
2400.00	54.09	43.80	4.91	25.90	-12.99	41.10	54	-12.90	AV	Horizontal
2483.50	67.18	43.80	5.12	25.90	-12.78	54.40	74	-19.60	PK	Vertical
2483.50	54.08	43.80	5.12	25.90	-12.78	41.30	54	-12.70	AV	Vertical
2483.50	67.03	43.80	5.12	25.90	-12.78	54.25	74	-19.75	PK	Horizontal
2483.50	54.04	43.80	5.12	25.90	-12.78	41.26	54	-12.74	AV	Horizontal



Meter		Antenna			Orrected	Emission				
Frequency	Reading	Amplifier	Loss	Factor	Factor	Level	Limits	Margin	Detector	
(MHz)	(dBµV)	(dB)	(dB)	(dB/m)	(dB)	(dBµV/m)	(dBµV/m)	(dB)	Type	Comment
802.11n40										
2400.00	65.00	43.80	4.91	25.90	-12.99	52.01	74	-21.99	PK	Vertical
2400.00	52.96	43.80	4.91	25.90	-12.99	39.97	54	-14.03	AV	Vertical
2400.00	64.95	43.80	4.91	25.90	-12.99	51.96	74	-22.04	PK	Horizontal
2400.00	52.01	43.80	4.91	25.90	-12.99	39.02	54	-14.98	AV	Horizontal
2483.50	64.12	43.80	5.12	25.90	-12.78	51.34	74	-22.66	PK	Vertical
2483.50	52.00	43.80	5.12	25.90	-12.78	39.22	54	-14.78	AV	Vertical
2483.50	64.98	43.80	5.12	25.90	-12.78	52.20	74	-21.80	PK	Horizontal
2483.50	52.92	43.80	5.12	25.90	-12.78	40.14	54	-13.86	AV	Horizontal
<p>Remark: Factor = Antenna Factor + Cable Loss – Pre-amplifier.            Low measurement frequencies is range from 2310 to 2400 MHz, high measurement frequencies is range from 2483.5 to 2500 MHz.            Only show the worst point data of the emissions in the frequency 2310-2400 MHz and 2483.5-2500 MHz.</p>										



#### 4. CONDUCTED SPURIOUS & BAND EDGE EMISSION

##### 4.1 APPLIED PROCEDURES / LIMIT

According to FCC section 15.247(d), in any 100kHz bandwidth outside the frequency band in which the spread spectrum or digitally modulated intentional radiator is operating, the radio frequency power that is produced by the intentional radiator shall be at least 20dB below that in the 100kHz bandwidth within the band that contains the highest level of the desired power, based on either an RF conducted or a radiated measurement.

##### 4.2 TEST PROCEDURE

Spectrum Parameter	Setting
Detector	Peak
Start/Stop Frequency	30 MHz to 10th carrier harmonic
RB / VB (emission in restricted band)	100 KHz/300 KHz
Trace-Mode:	Max hold

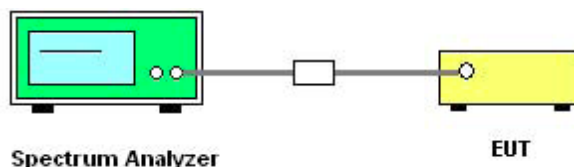
For Band edge

Spectrum Parameter	Setting
Detector	Peak
Start/Stop Frequency	Lower Band Edge: 2300 to 2430 MHz Upper Band Edge: 2450 to 2500 MHz
RB / VB (emission in restricted band)	100 KHz/300 KHz
Trace-Mode:	Max hold

##### 4.3 DEVIATION FROM STANDARD

No deviation.

##### 4.4 TEST SETUP



The EUT which is powered by the Battery, is coupled to the Spectrum Analyzer; the RF load attached to the EUT antenna terminal is 50Ohm; the path loss as the factor is calibrated to correct the reading.

Make the measurement with the spectrum analyzer's resolution bandwidth (RBW) = 100 kHz. In order to make an accurate measurement, set the span greater than RBW.

##### 4.5 EUT OPERATION CONDITIONS

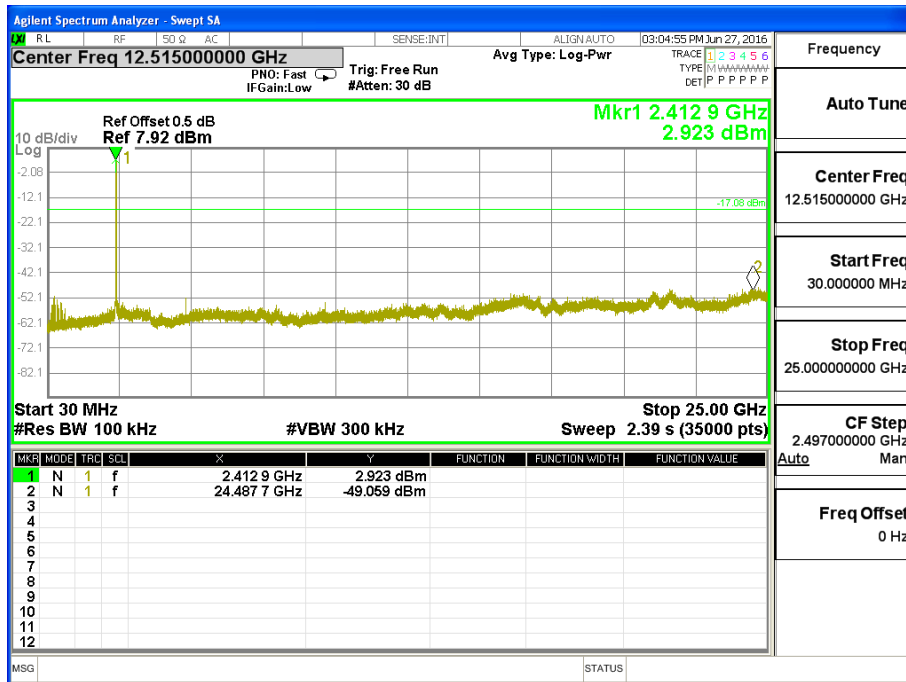
The EUT tested system was configured as the statements of 2.3 Unless otherwise a special operating condition is specified in the follows during the testing.



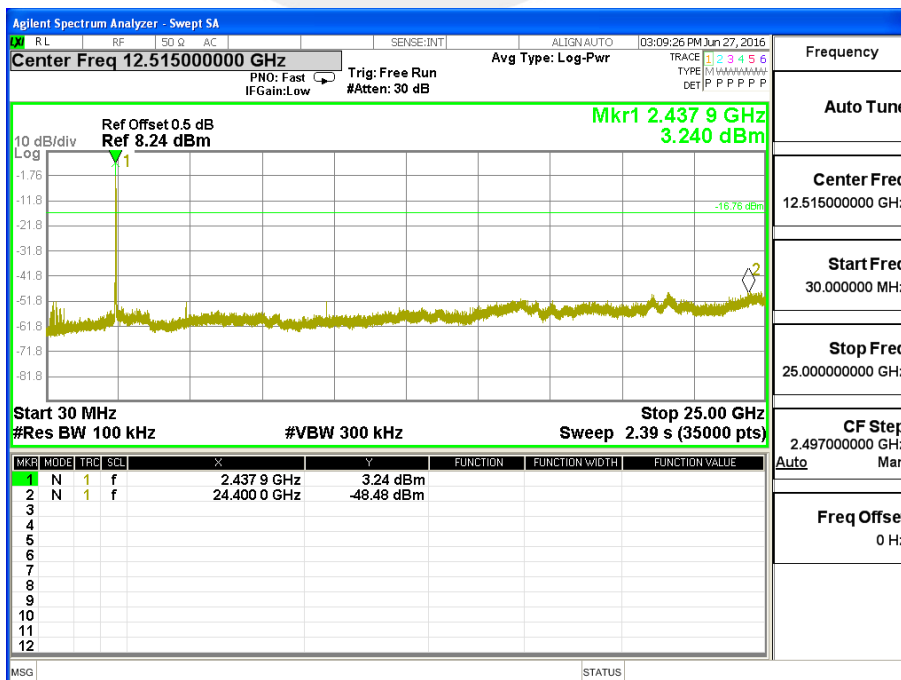
4.6 TEST RESULTS

Temperature :	25 °C	Relative Humidity :	60%
Pressure :	1015 hPa	Test Voltage :	DC 5V
Test Mode :	TX b Mode /CH01, CH06, CH11		

CH 01

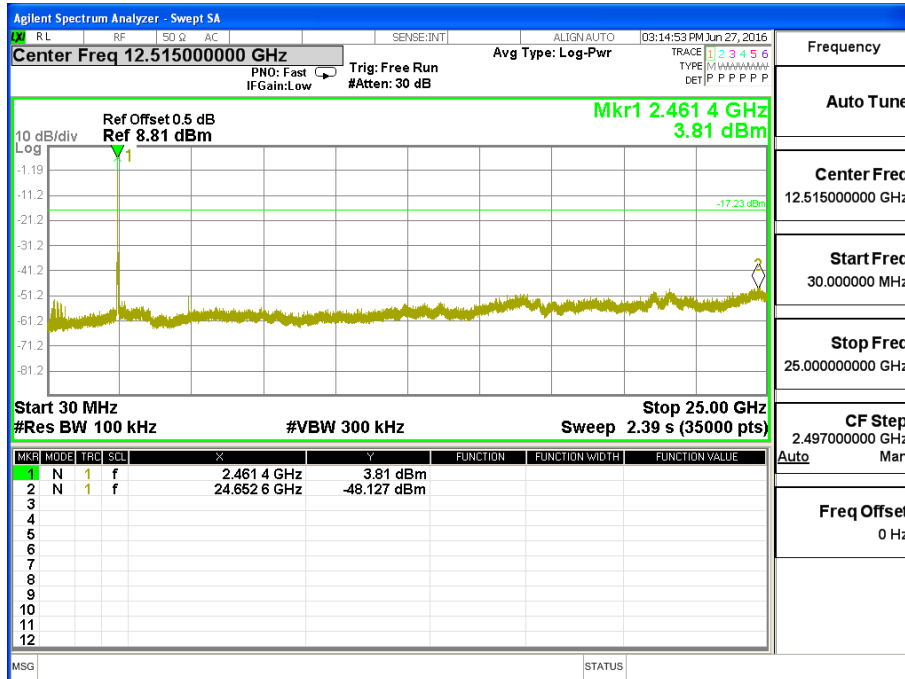


CH 06





CH 11

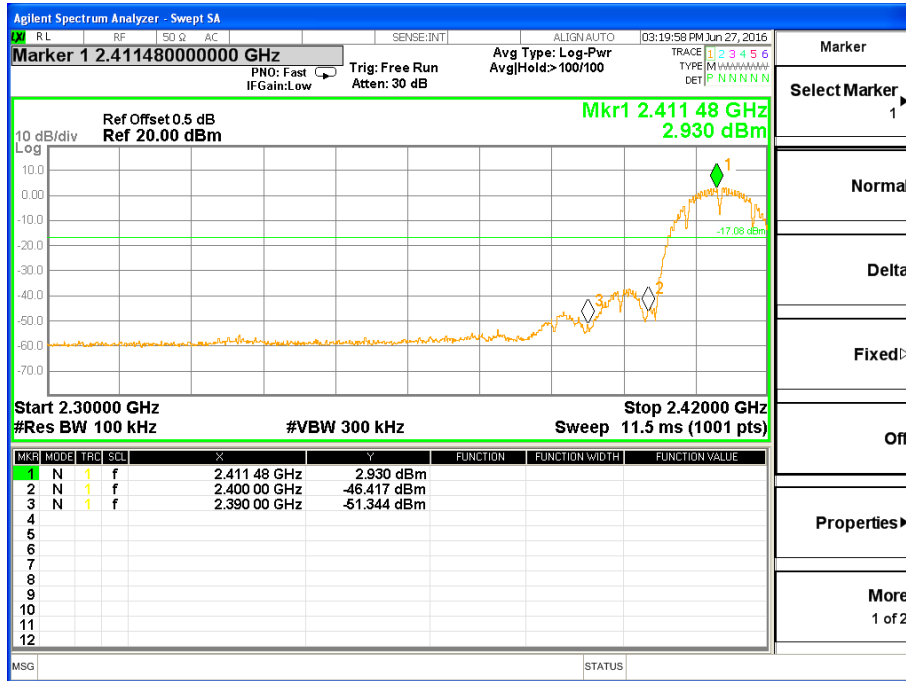




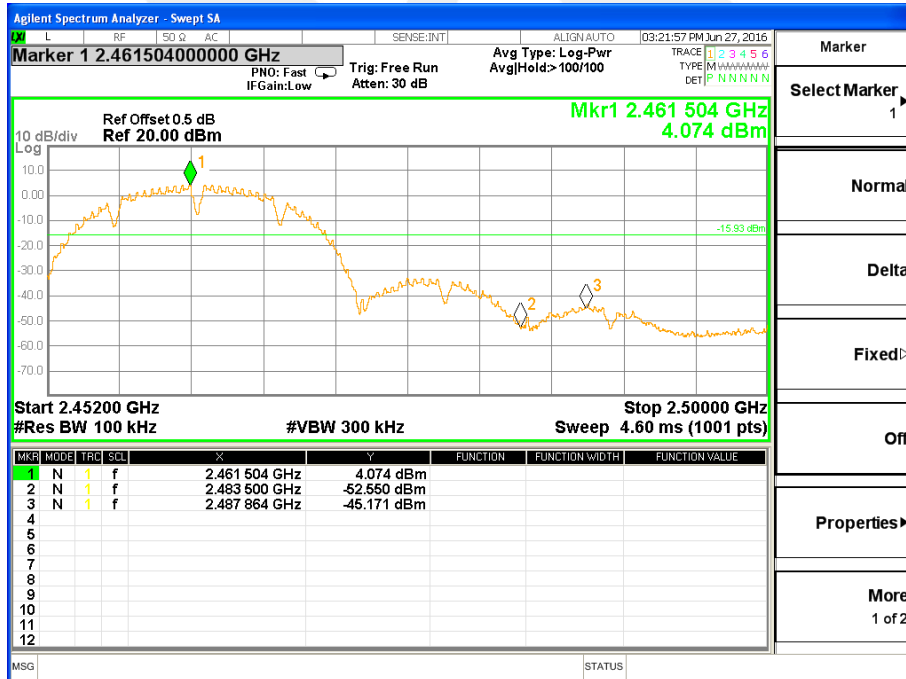


Band edge

CH 01



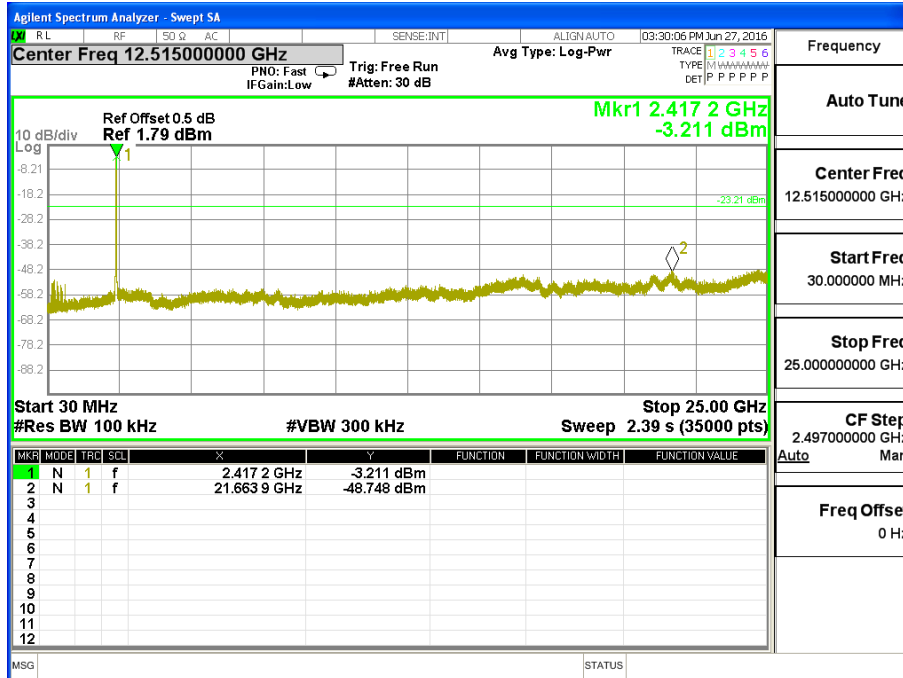
CH 11



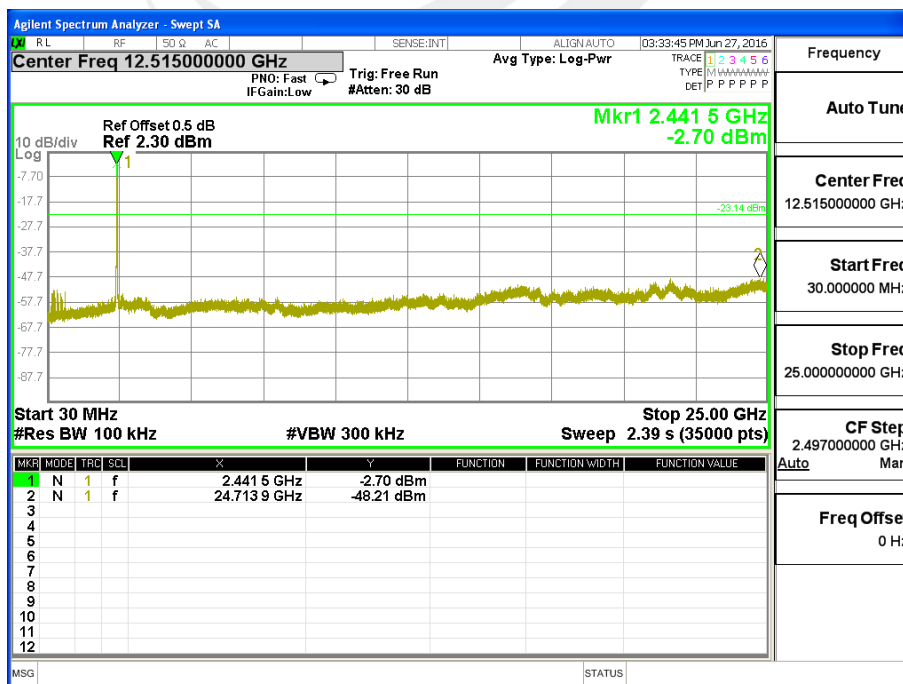


Temperature :	25 °C	Relative Humidity :	60%
Pressure :	1015 hPa	Test Voltage :	DC 5V
Test Mode :	TX g Mode /CH01, CH06, CH11		

CH 01

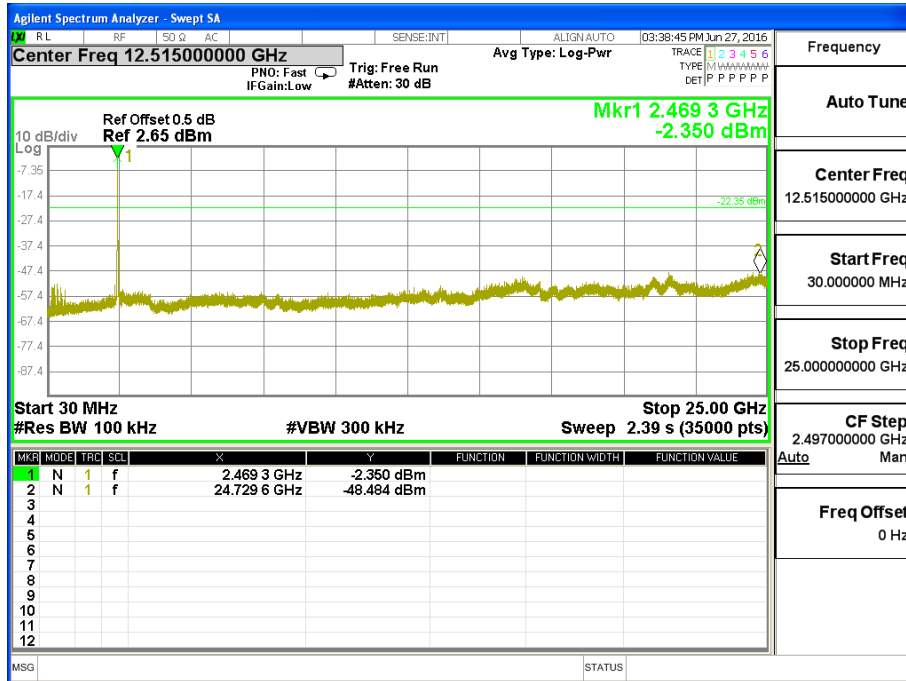


CH06





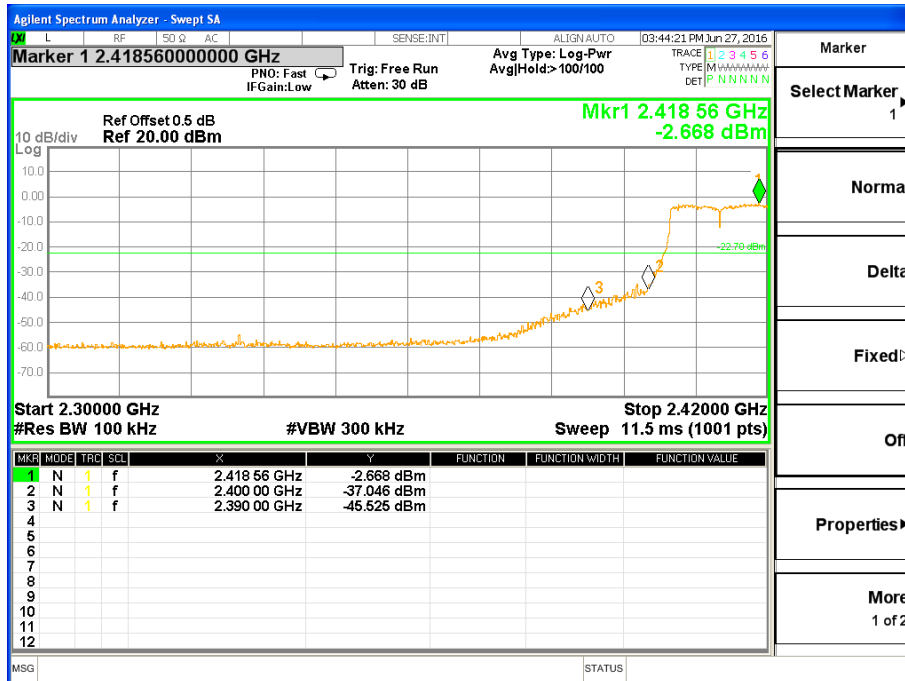
CH 11



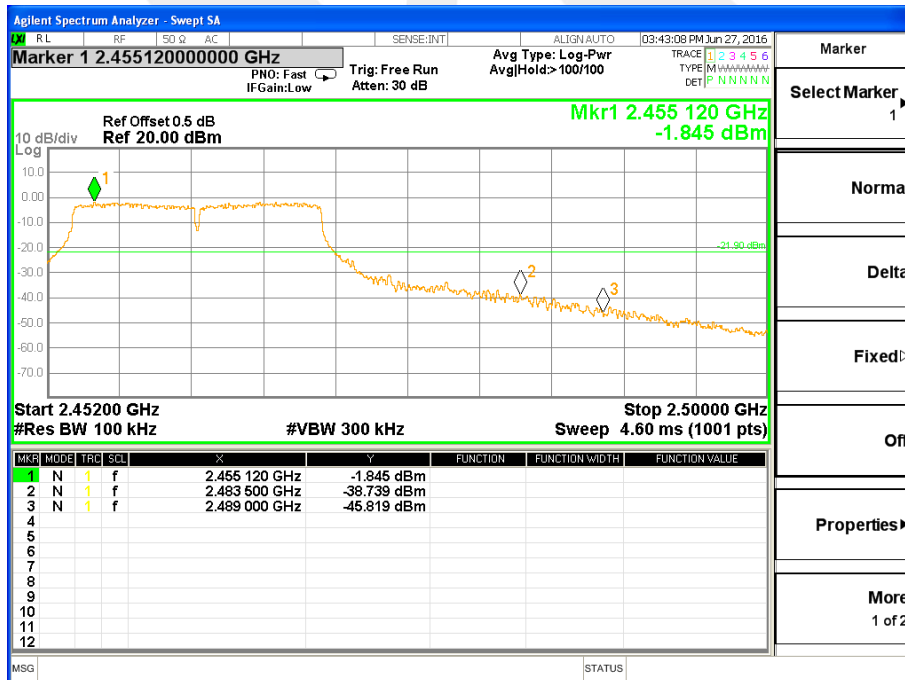


Band edge

CH 01



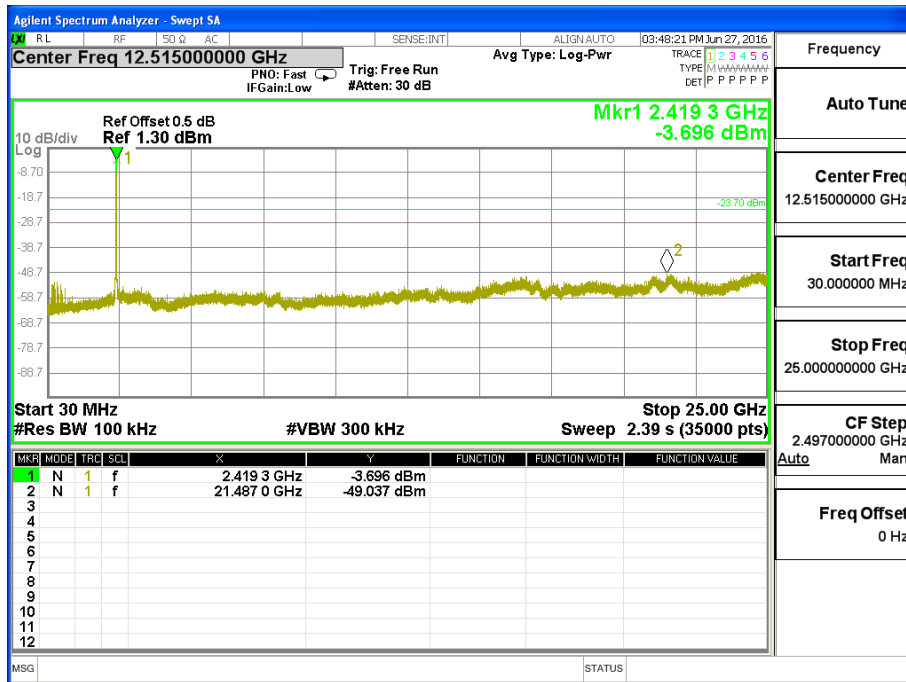
CH11



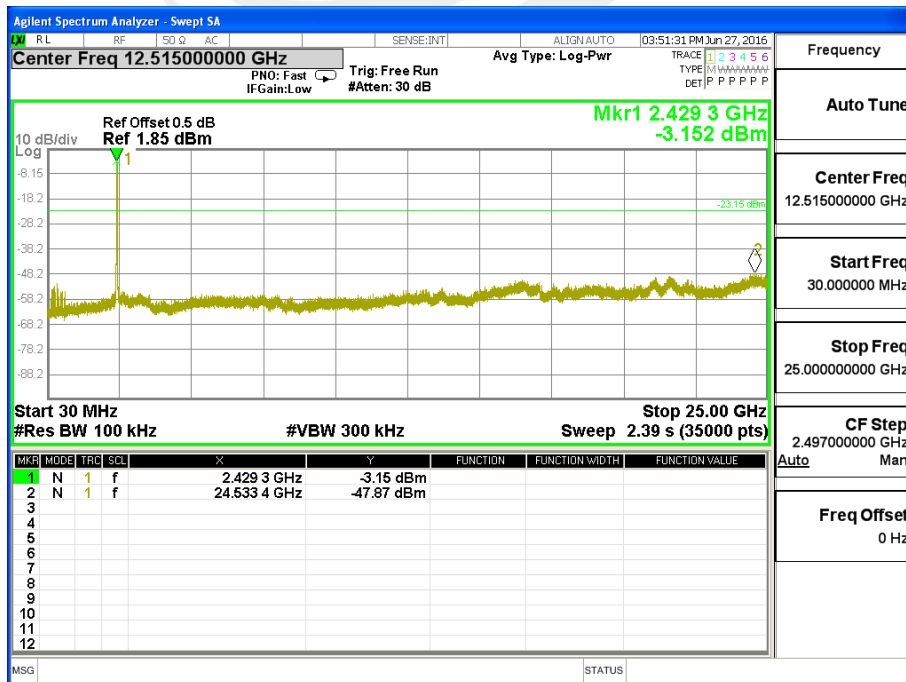


Temperature :	25 °C	Relative Humidity :	60%
Pressure :	1015 hPa	Test Voltage :	DC 5V
Test Mode :	TX n Mode(20M) /CH01, CH06, CH11		

CH 01

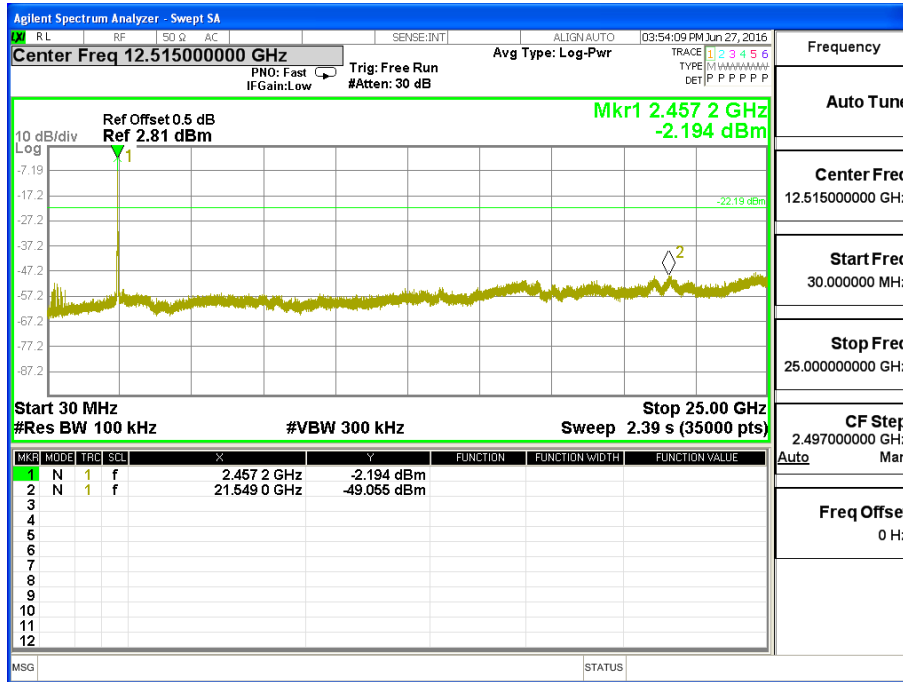


CH 06





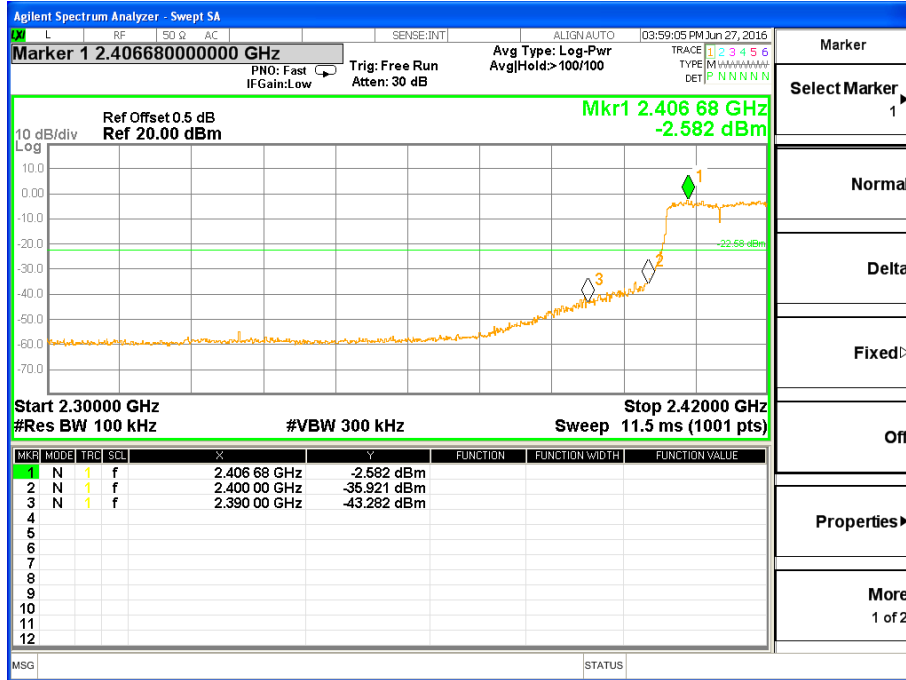
CH 11



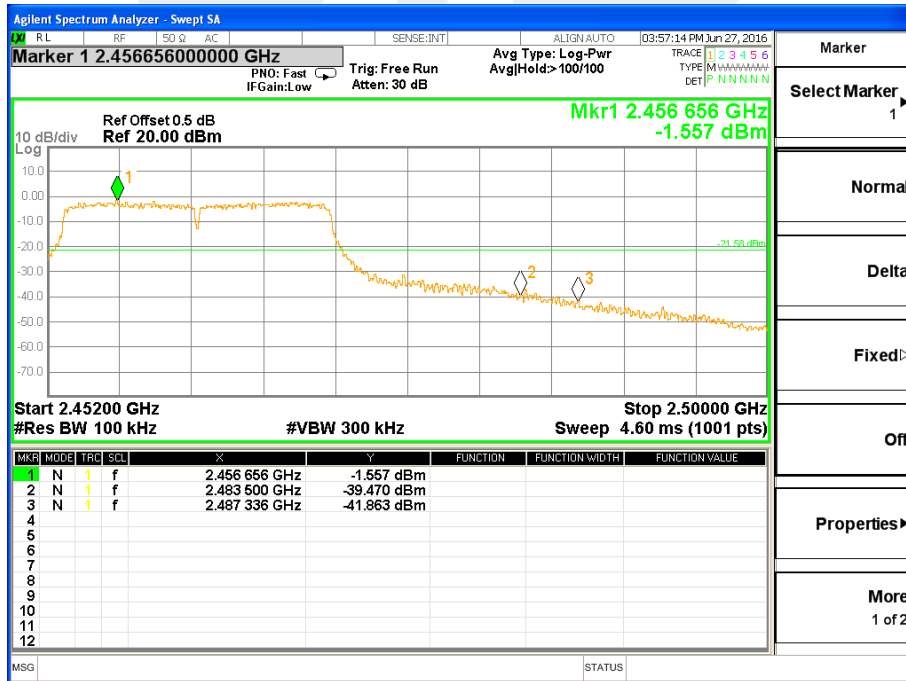


Band edge

CH 01



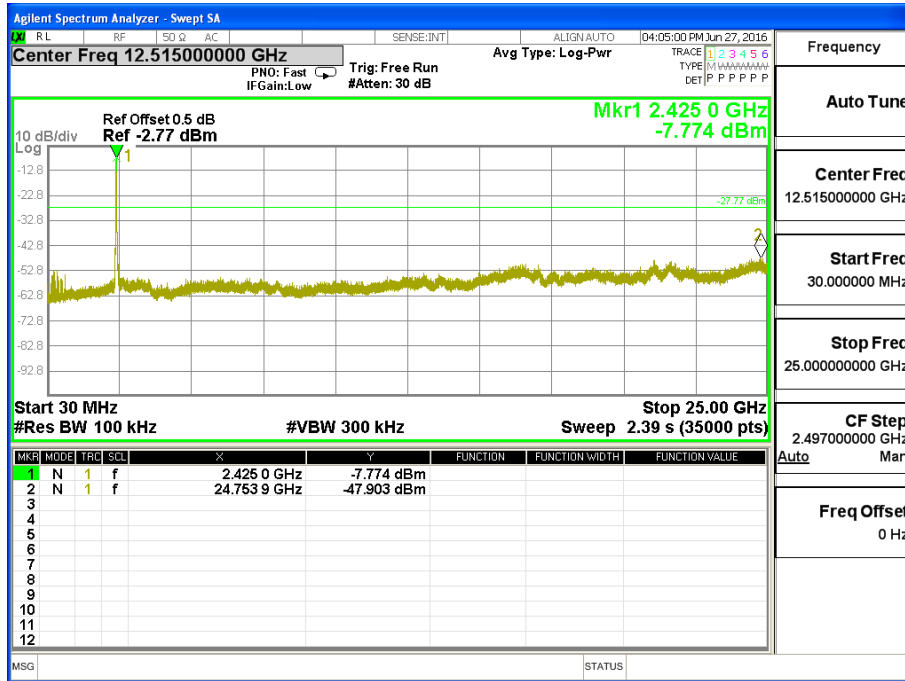
CH 11





Temperature :	25 °C	Relative Humidity :	60%
Pressure :	1015 hPa	Test Voltage :	DC 5V
Test Mode :	TX n Mode(40M) /CH03, CH06, CH09		

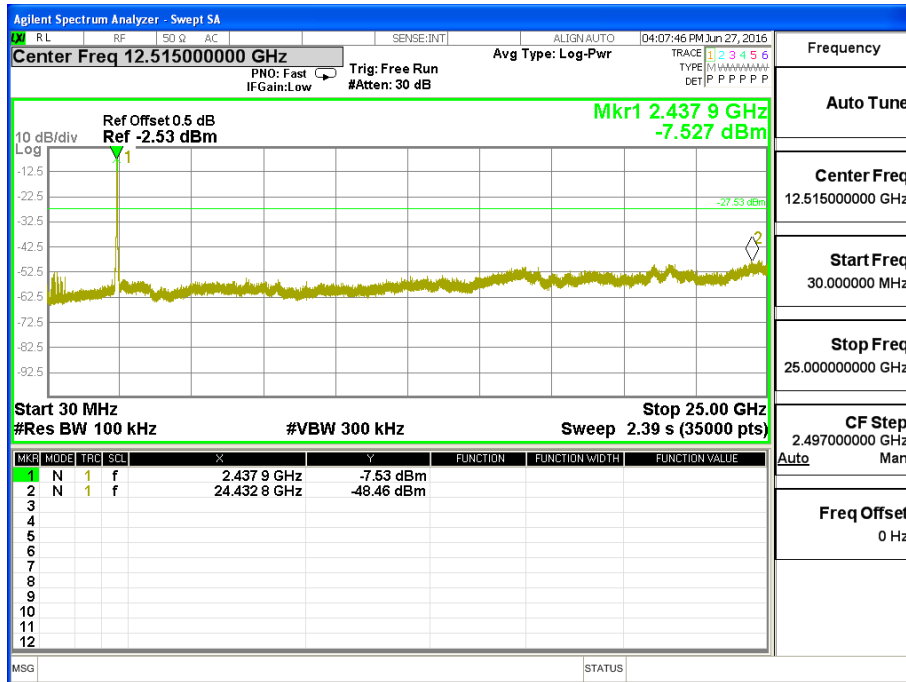
CH 03



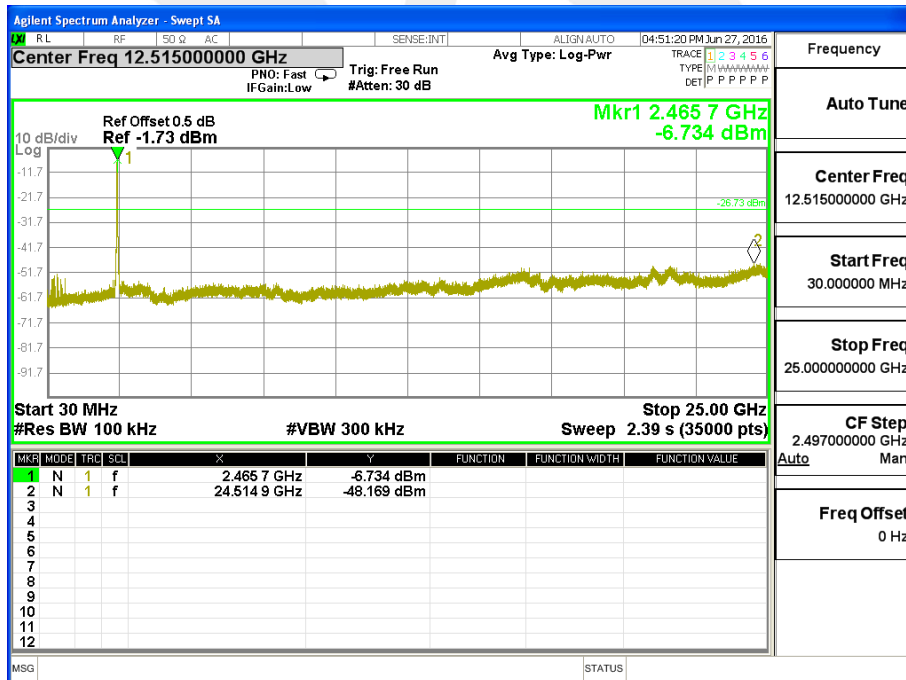




CH06



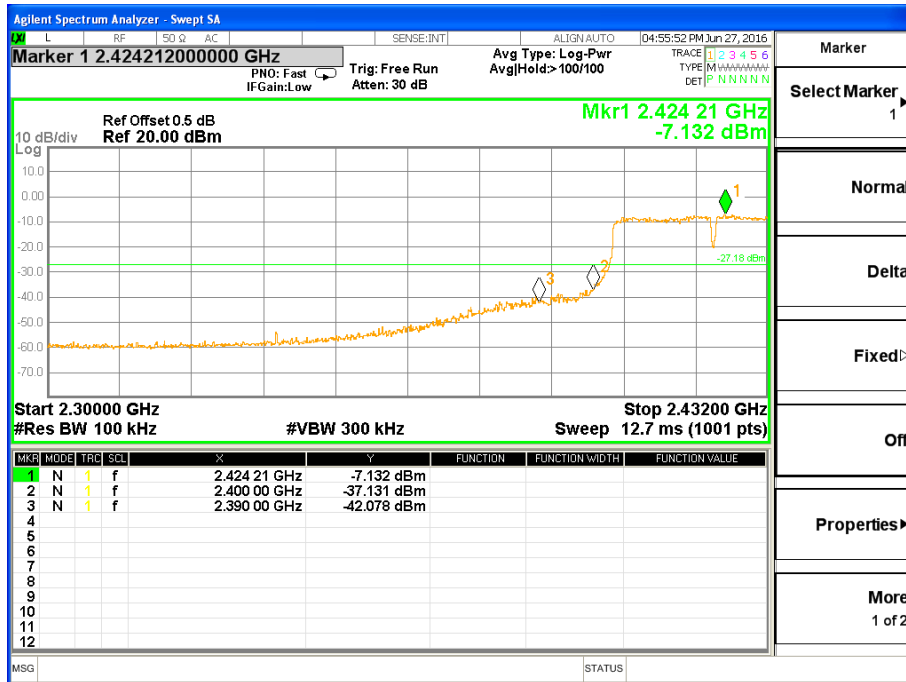
CH09



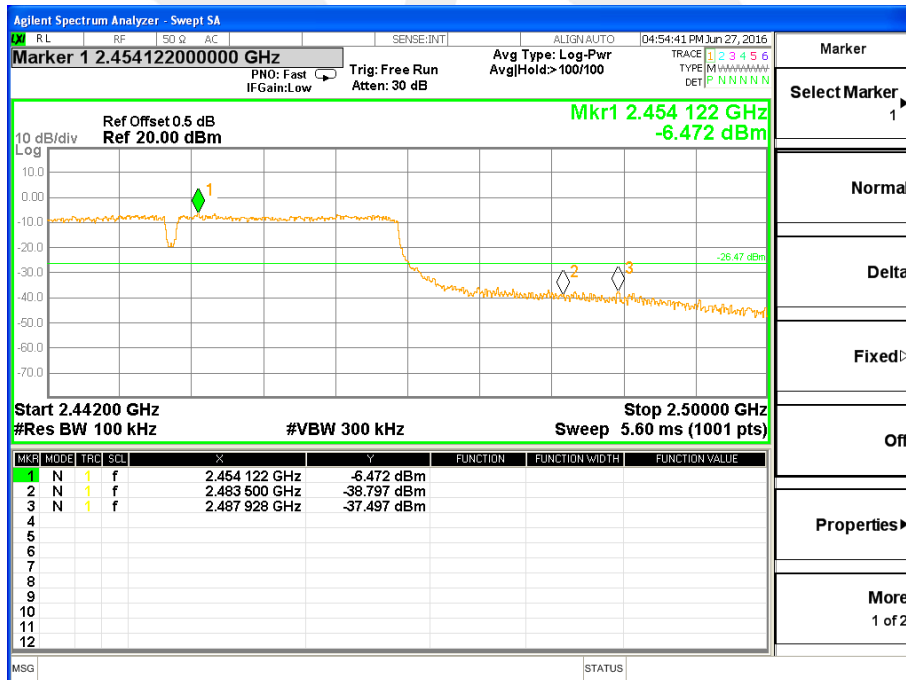


Band edge

CH03



CH 09





## 5. POWER SPECTRAL DENSITY TEST

### 5.1 APPLIED PROCEDURES / LIMIT

FCC Part15 (15.247) , Subpart C				
Section	Test Item	Limit	Frequency Range (MHz)	Result
15.247(e)	Power Spectral Density	$\leq 8$ dBm (RBW $\geq 3$ KHz)	2400-2483.5	PASS

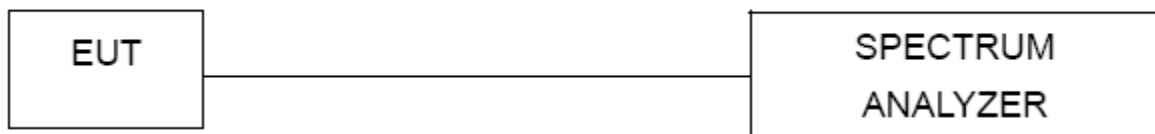
### 5.2 TEST PROCEDURE

1. Set analyzer center frequency to DTS channel center frequency.
2. Set the span to 1.5 times the DTS channel bandwidth.
3. Set the  $100 \text{ kHz} \geq \text{RBW} \geq 3 \text{ kHz}$ .
4. Set the  $\text{VBW} \geq 3 \times \text{RBW}$ .
5. Detector = peak.
6. Sweep time = auto couple.
7. Trace mode = max hold.
8. Allow trace to fully stabilize.
9. Use the peak marker function to determine the maximum amplitude level.
10. If measured value exceeds limit, reduce RBW (no less than 3 kHz) and repeat.

### 5.3 DEVIATION FROM STANDARD

No deviation.

### 5.4 TEST SETUP



### 5.5 EUT OPERATION CONDITIONS

The EUT tested system was configured as the statements of 2.3 Unless otherwise a special operating condition is specified in the follows during the testing.

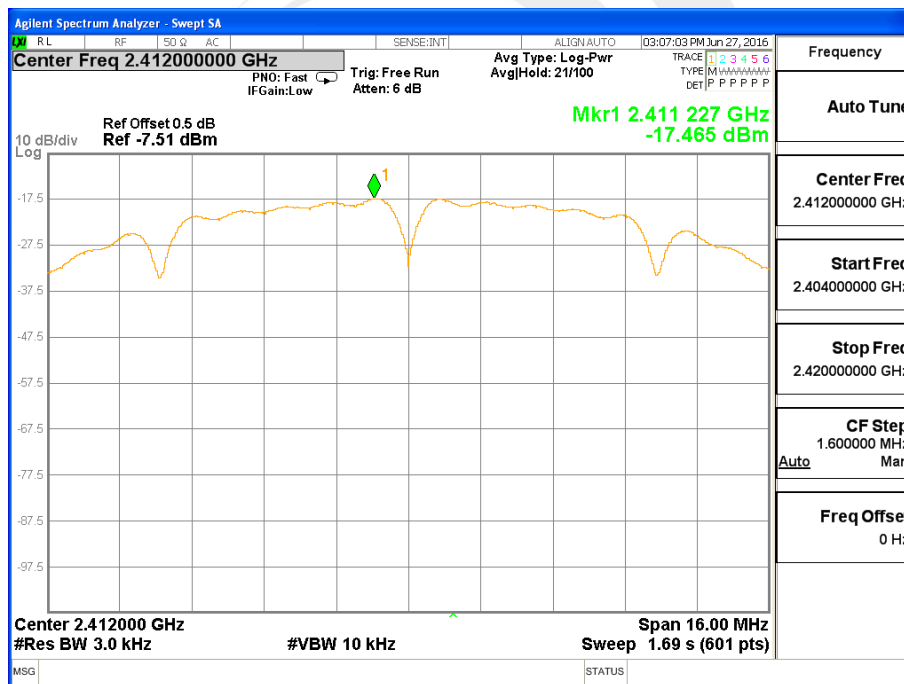


5.6 TEST RESULTS

Temperature :	25 °C	Relative Humidity :	60%
Pressure :	1015 hPa	Test Voltage :	DC 5V
Test Mode :	TX b Mode /CH01, CH06, CH11		

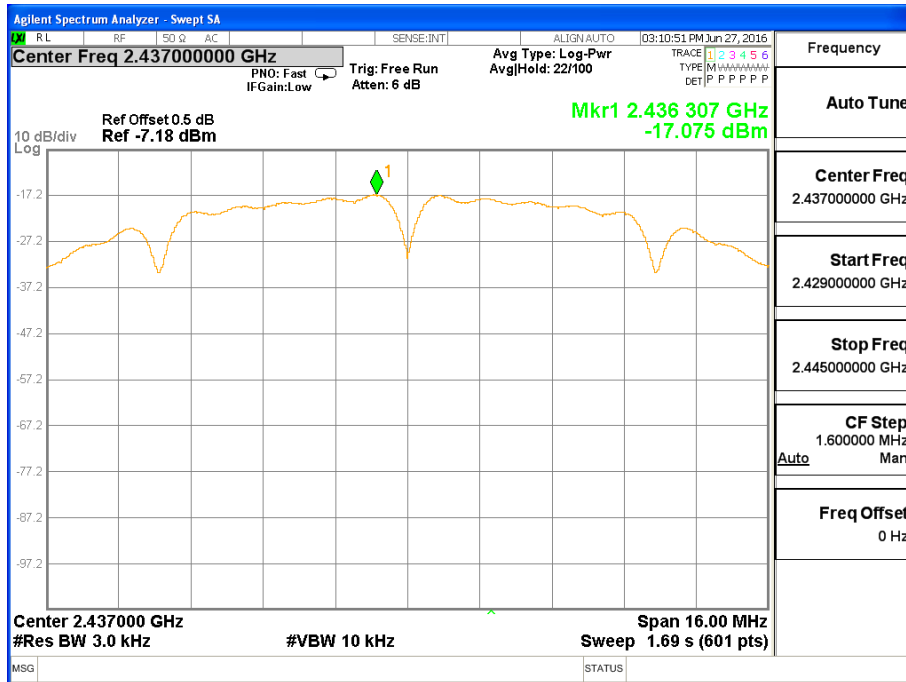
Frequency	Power Density (dBm/3kHz)	Limit (dBm)	Result
2412 MHz	-17.465	≤8	PASS
2437 MHz	-17.075	≤8	PASS
2462 MHz	-16.835	≤8	PASS

TX CH01

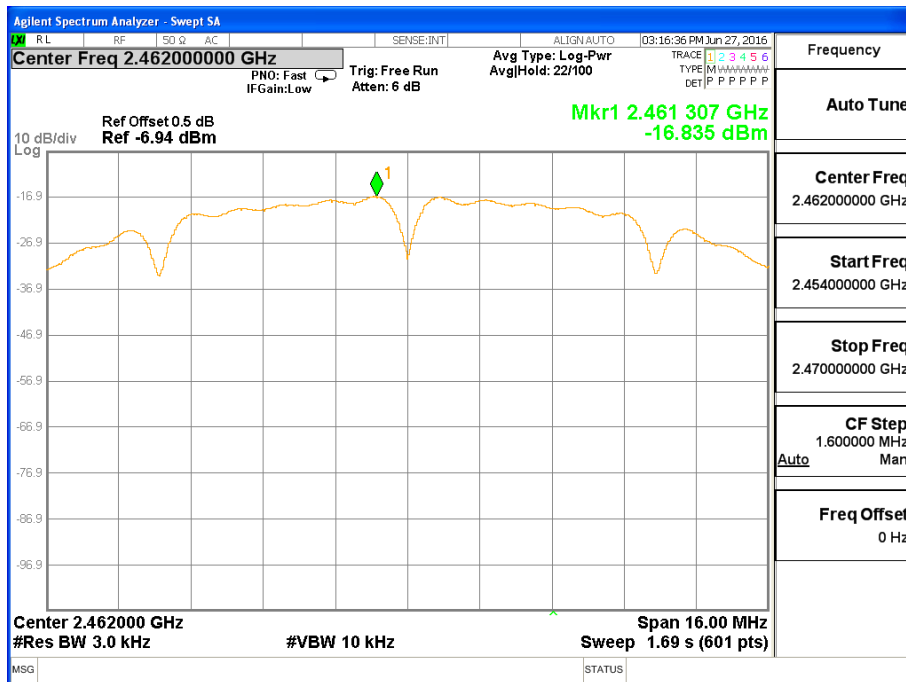




### TX CH06



### TX CH11

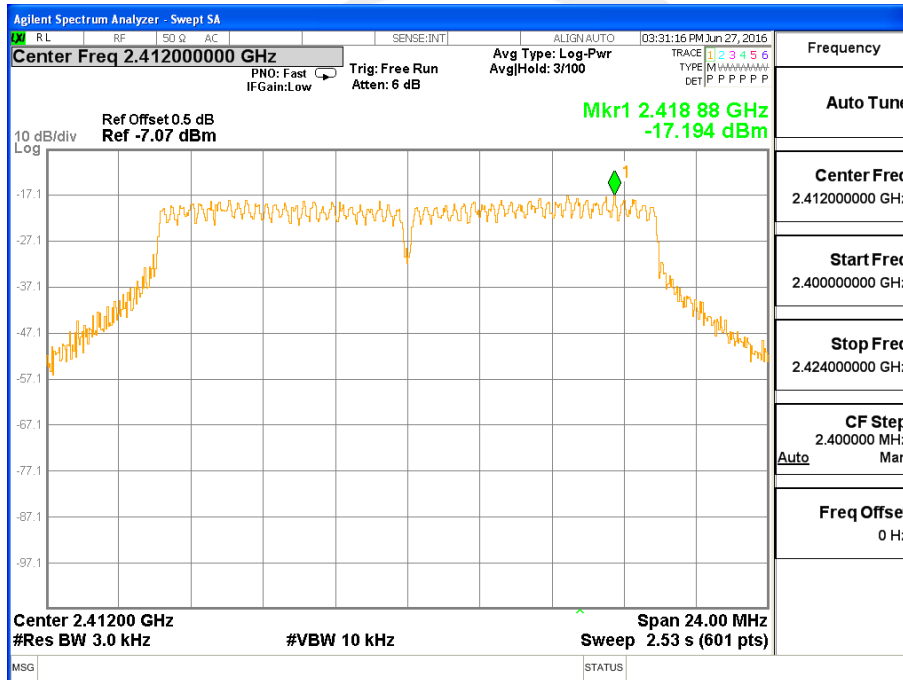




Temperature :	25 °C	Relative Humidity :	60%
Pressure :	1015 hPa	Test Voltage :	DC 5V
Test Mode :	TX g Mode /CH01, CH06, CH11		

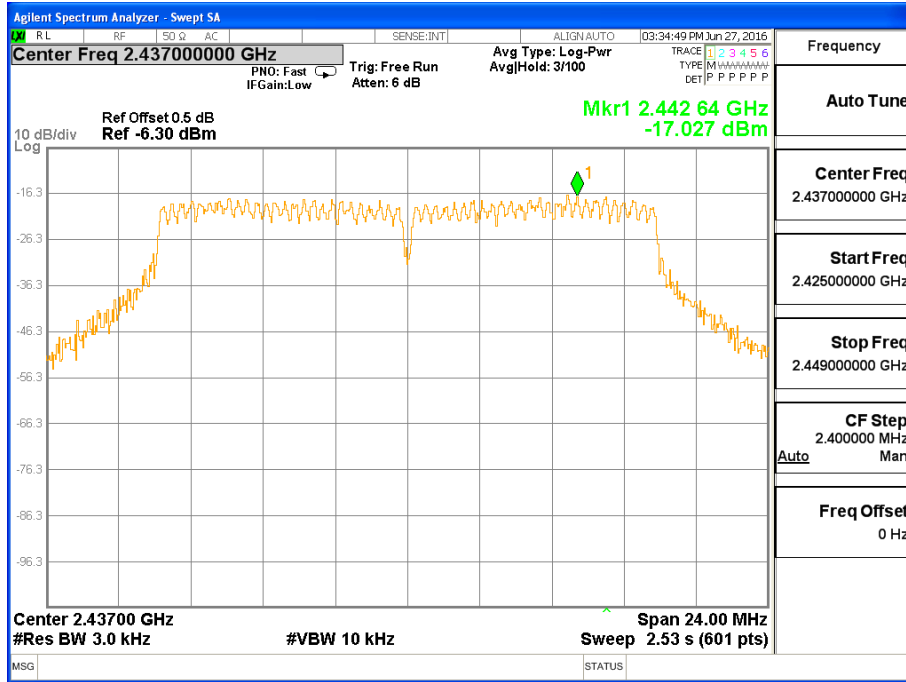
Frequency	Power Density (dBm/3kHz)	Limit (dBm)	Result
2412 MHz	-17.194	≤8	PASS
2437 MHz	-17.027	≤8	PASS
2462 MHz	-16.384	≤8	PASS

**TX CH01**

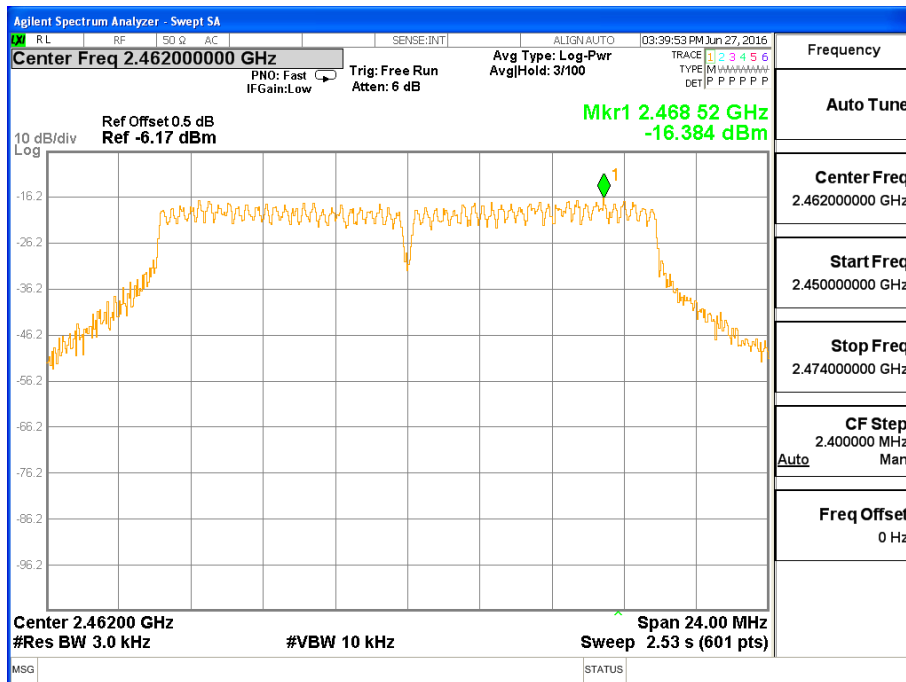




TX CH06



TX CH11

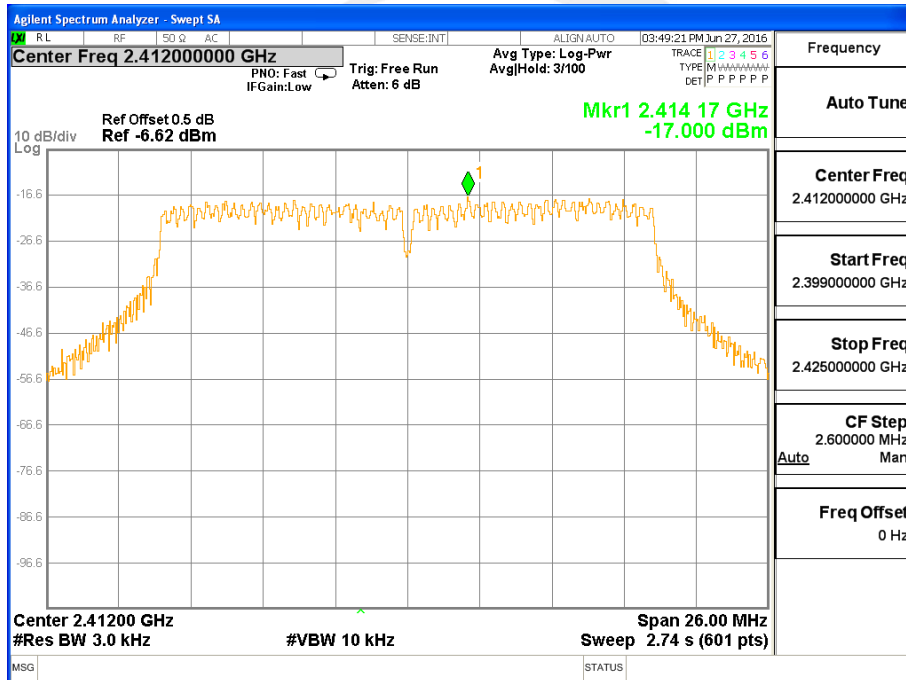




Temperature :	25 °C	Relative Humidity :	60%
Pressure :	1015 hPa	Test Voltage :	DC 5V
Test Mode :	TX n Mode(20M) /CH01, CH06, CH11		

Frequency	Power Density (dBm/3kHz)	Limit (dBm)	Result
2412 MHz	-17.000	≤8	PASS
2437 MHz	-17.927	≤8	PASS
2462 MHz	-16.368	≤8	PASS

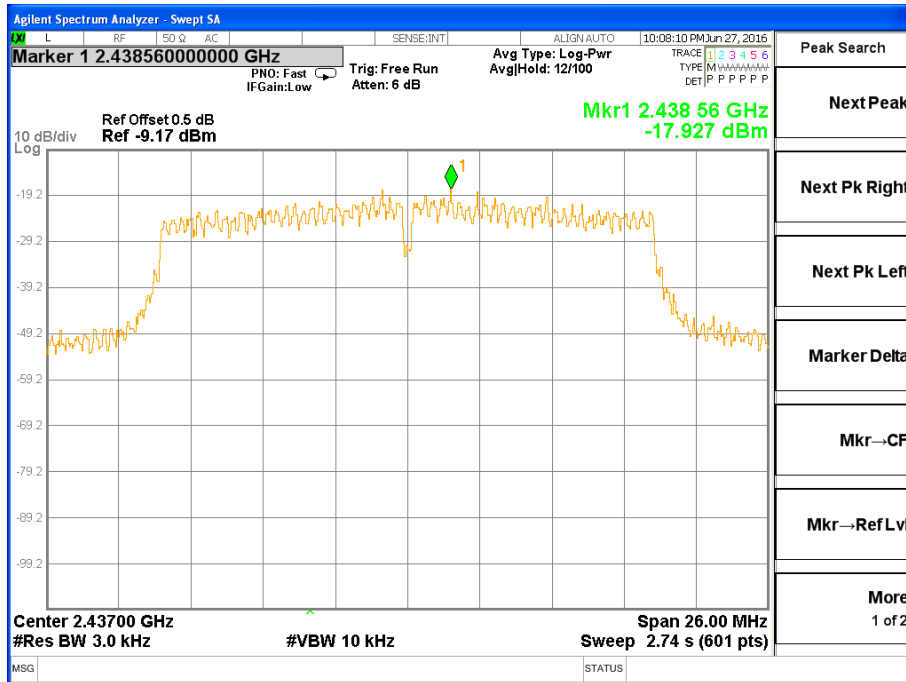
**TX CH01**



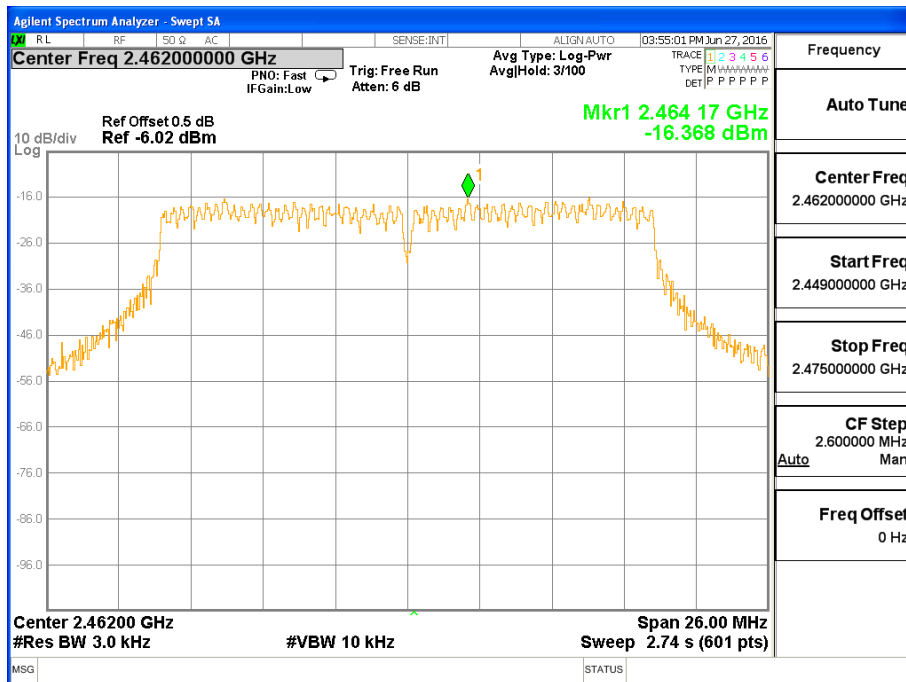




TX CH06



TX CH11

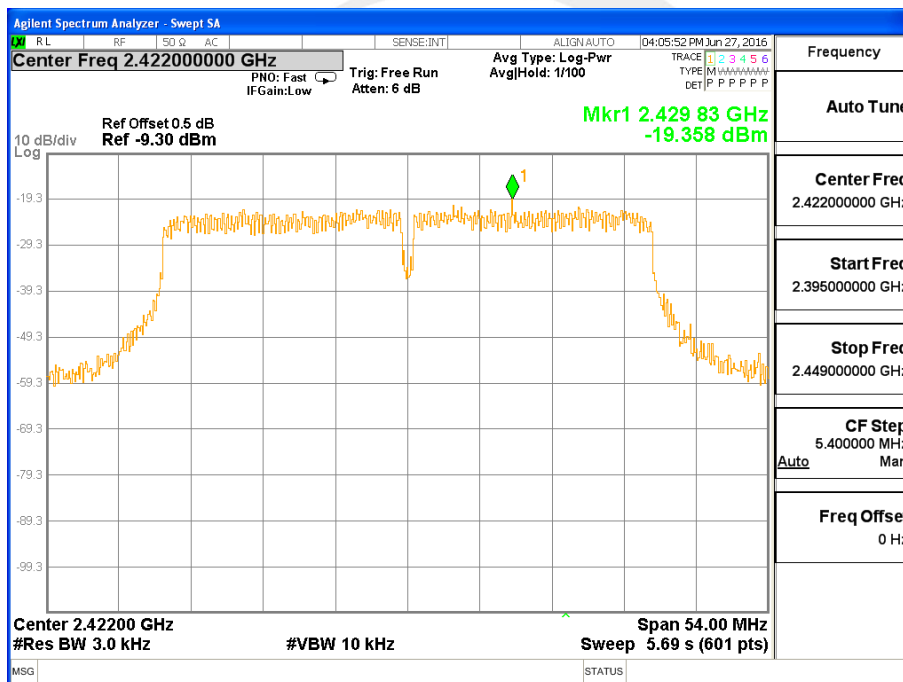




Temperature :	25 °C	Relative Humidity :	60%
Pressure :	1015 hPa	Test Voltage :	DC 5V
Test Mode :	TX n Mode(40M) /CH03, CH06, CH09		

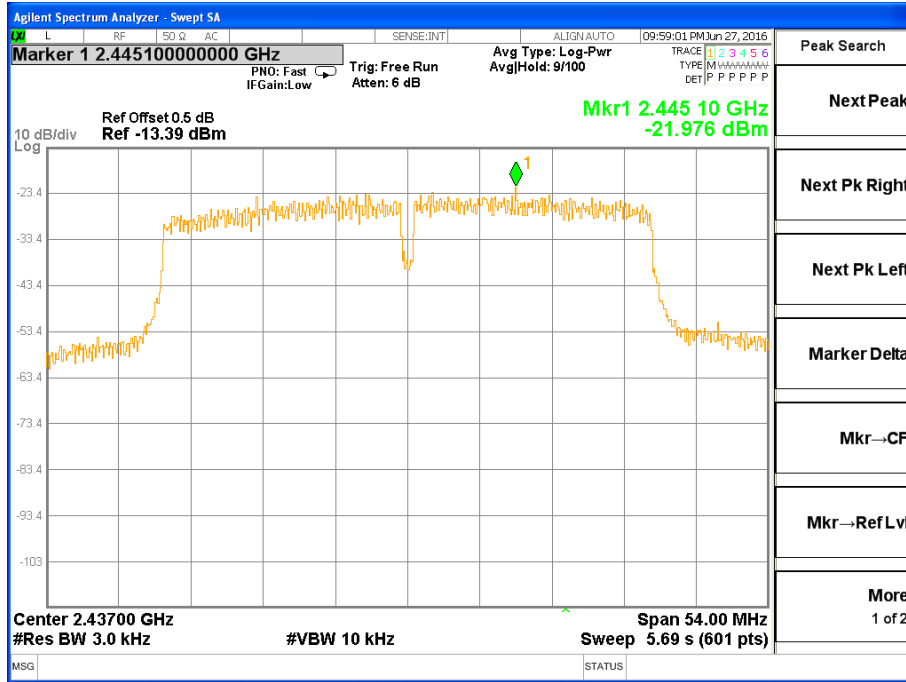
Frequency	Power Density (dBm/3kHz)	Limit(dBm)	Result
2422 MHz	-19.358	≤8	PASS
2437 MHz	-21.976	≤8	PASS
2452 MHz	-19.861	≤8	PASS

**TX CH03**

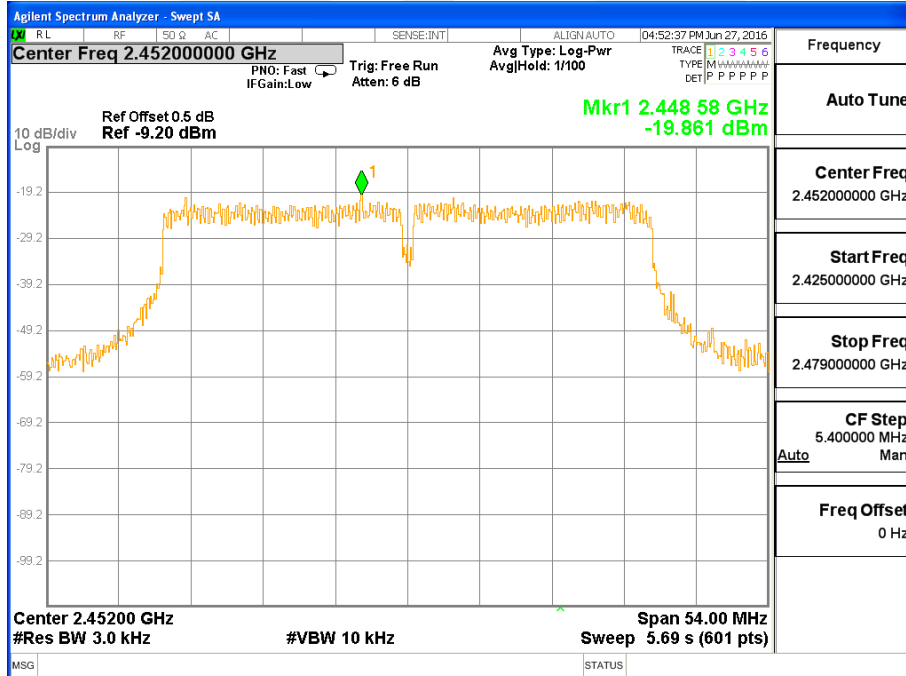




TX CH06



TX CH09



## 6. BANDWIDTH TEST

### 6.1 APPLIED PROCEDURES / LIMIT

FCC Part15 (15.247) , Subpart C				
Section	Test Item	Limit	Frequency Range (MHz)	Result
15.247(a)(2)	Bandwidth	$\geq 500\text{KHz}$ (6dB bandwidth)	2400-2483.5	PASS

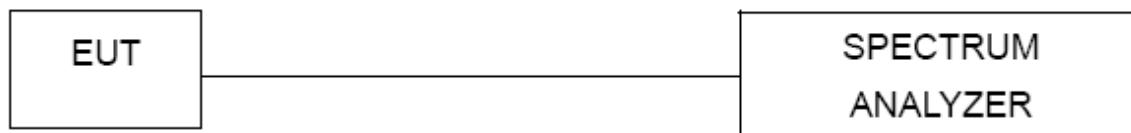
### 6.2 TEST PROCEDURE

The automatic bandwidth measurement capability of an instrument may be employed using the X dB bandwidth mode with X set to 6 dB, if the functionality described above (i.e., RBW = 100 kHz, VBW $\geq$ 3RBW, peak detector with maximum hold) is implemented by the instrumentation function. When using this capability, care shall be taken so that the bandwidth measurement is not influenced by any intermediate power nulls in the fundamental emission that might be  $\geq 6$  dB.

### 6.3 DEVIATION FROM STANDARD

No deviation.

### 6.4 TEST SETUP



### 6.5 EUT OPERATION CONDITIONS

The EUT tested system was configured as the statements of 2.3 Unless otherwise a special operating condition is specified in the follows during the testing.



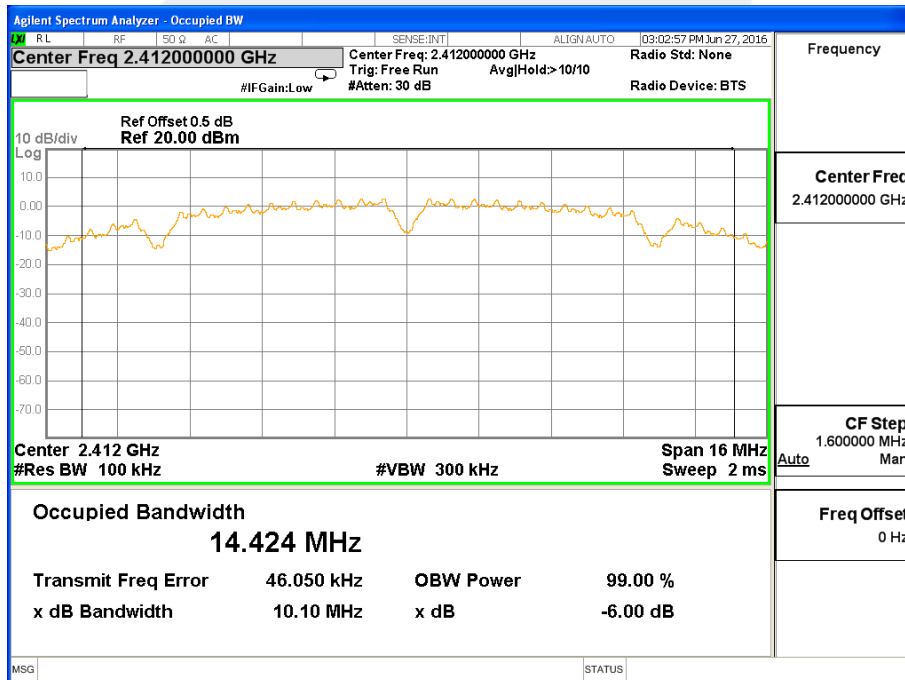
6.6 TEST RESULTS

Temperature :	25 °C	Relative Humidity :	60%
Pressure :	1012 hPa	Test Voltage :	DC 5V
Test Mode :	TX b Mode /CH01, CH06, CH11		

Remark: PEAK DETECTOR IS USED

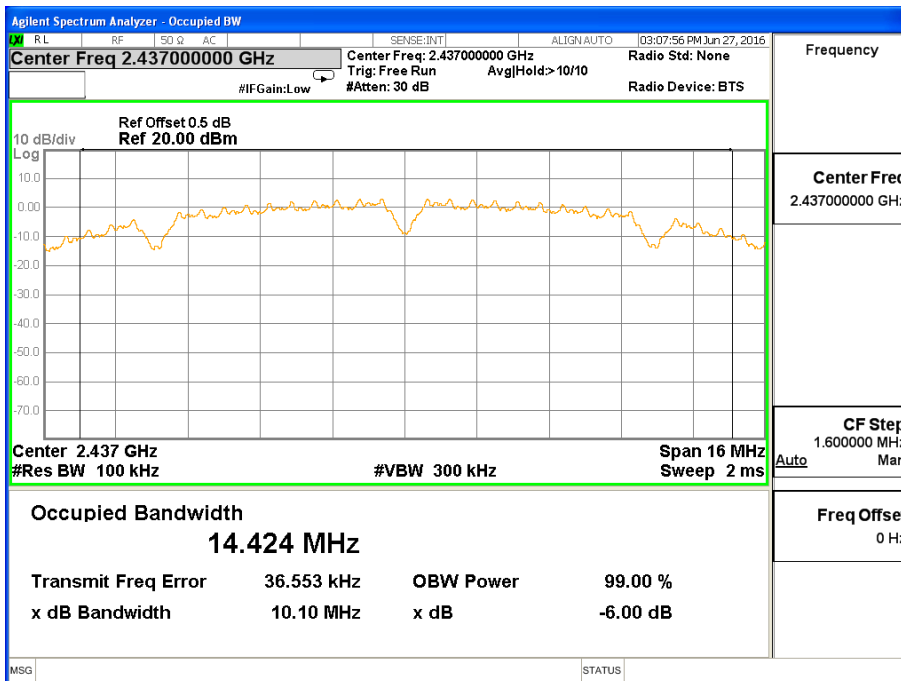
Frequency	6dB Bandwidth (MHz)	Channel Separation (KHz)	Result
2412 MHz	10.10	≥500KHz	PASS
2437 MHz	10.10	≥500KHz	PASS
2462 MHz	10.10	≥500KHz	PASS

TX CH 01

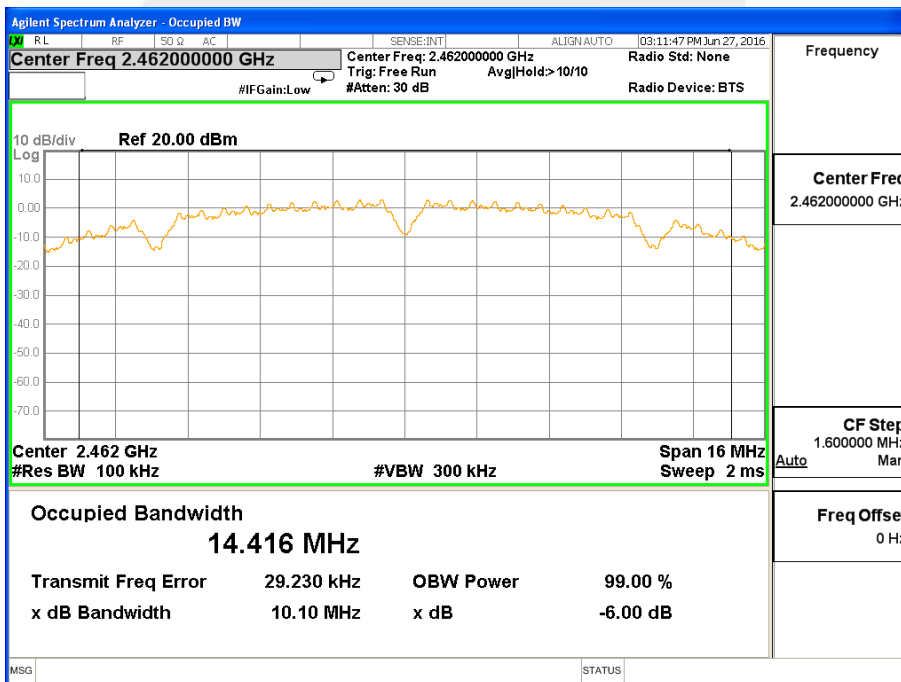




### TX CH 06



### TX CH 11

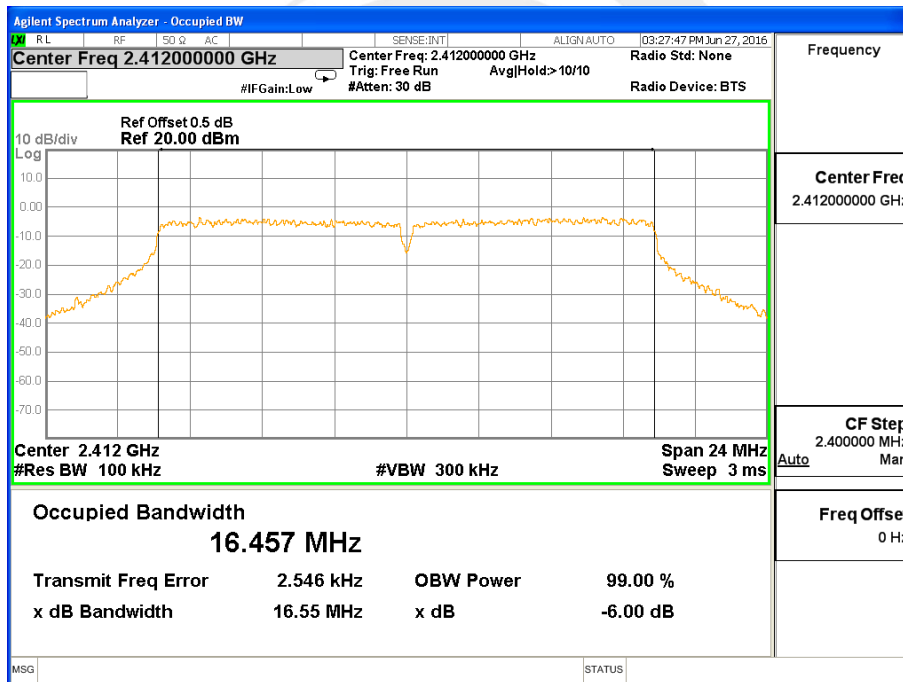




Temperature :	25 °C	Relative Humidity :	60%
Pressure :	1012 hPa	Test Voltage :	DC 5V
Test Mode :	TX g Mode /CH01, CH06, CH11		

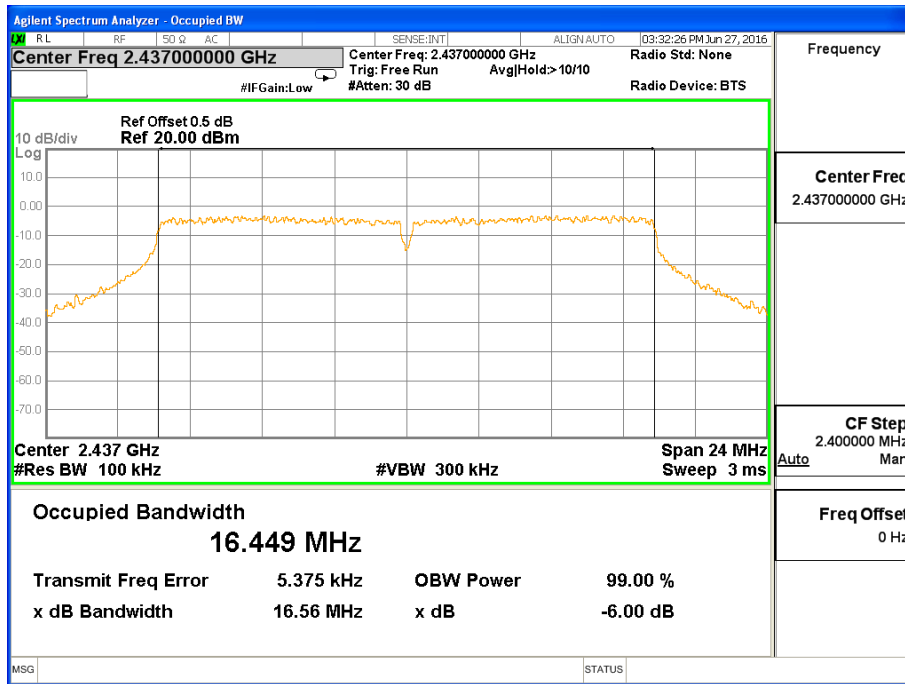
Frequency	6dB Bandwidth (MHz)	Channel Separation (KHz)	Result
2412 MHz	16.55	≥500KHz	PASS
2437 MHz	16.56	≥500KHz	PASS
2462 MHz	16.56	≥500KHz	PASS

**TX CH 01**

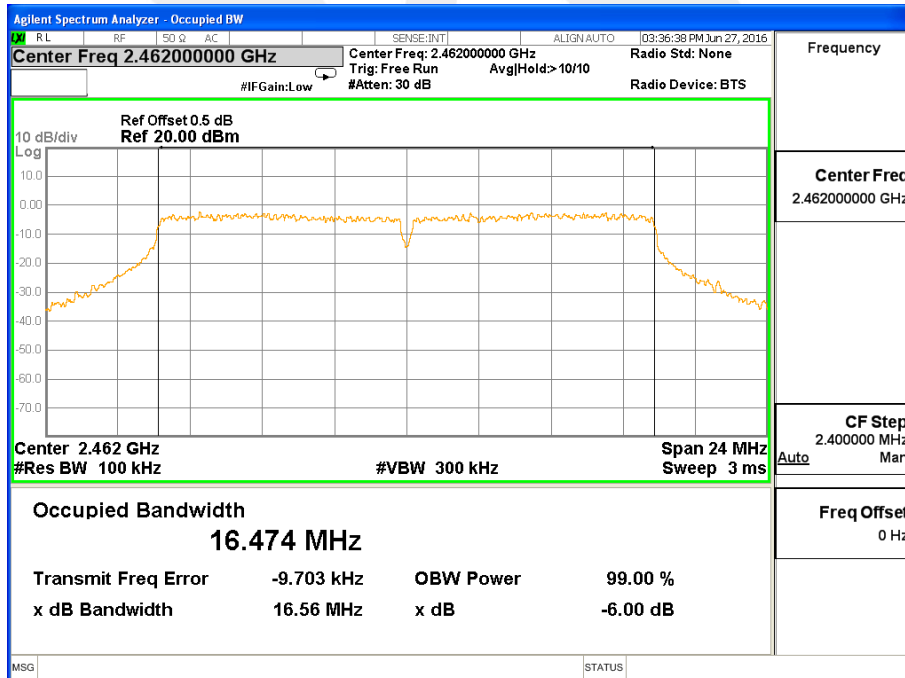




TX CH 06



TX CH 11



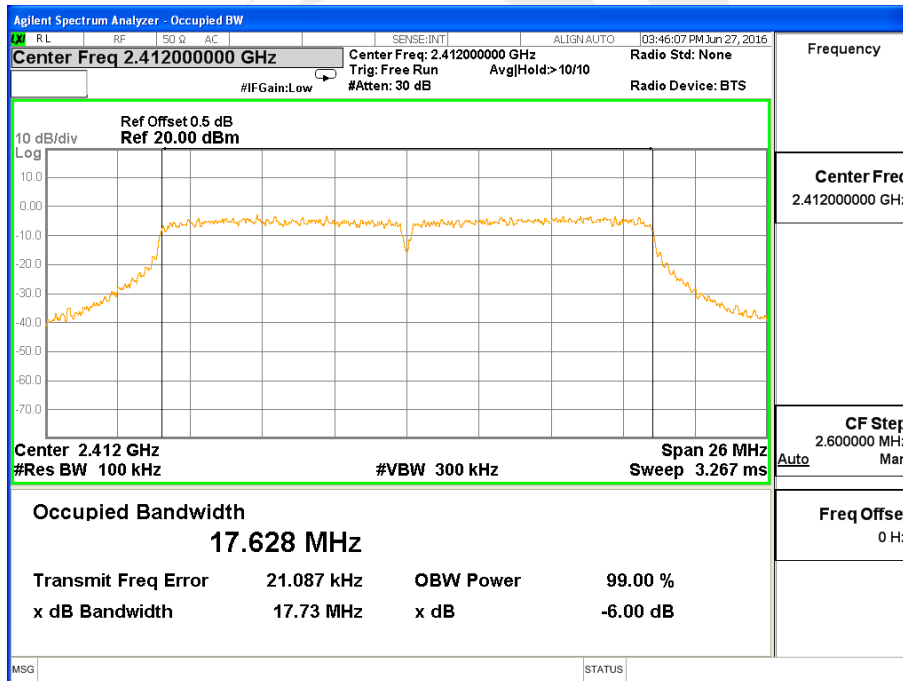




Temperature :	25 °C	Relative Humidity :	60%
Pressure :	1012 hPa	Test Voltage :	DC 5V
Test Mode :	TX n Mode(20M) /CH01, CH06, CH11		

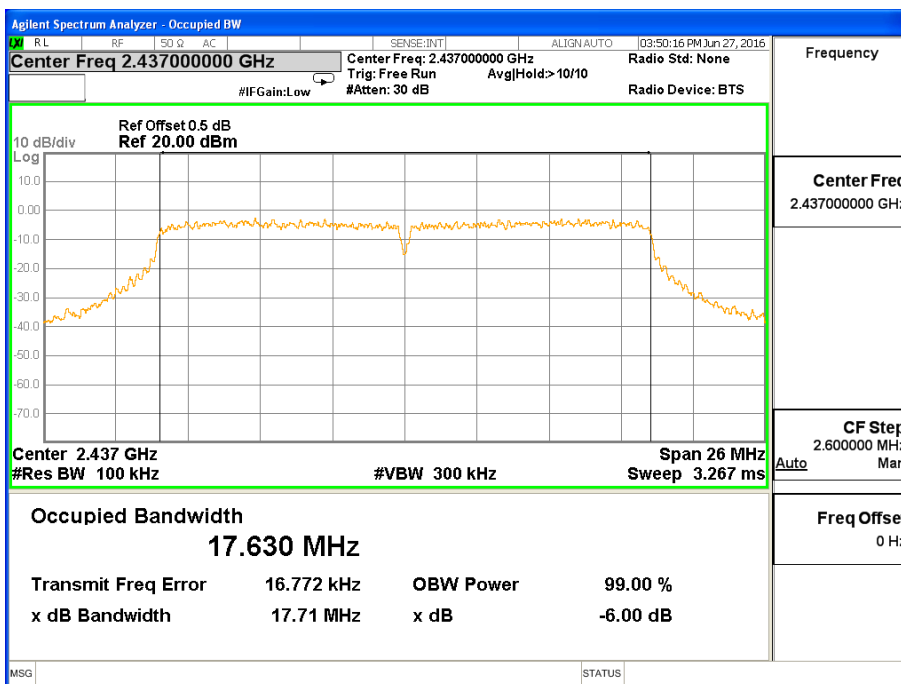
Frequency	6dB Bandwidth (MHz)	Channel Separation (KHz)	Result
2412 MHz	17.13	≥500KHz	PASS
2437 MHz	17.71	≥500KHz	PASS
2462 MHz	17.71	≥500KHz	PASS

TX CH 01

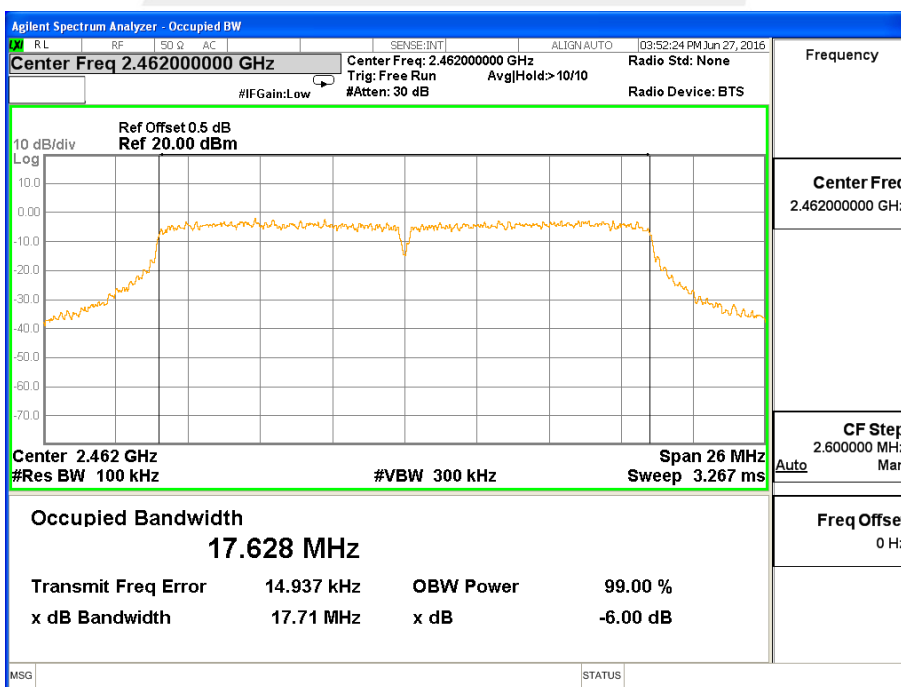




### TX CH 06



### TX CH 11

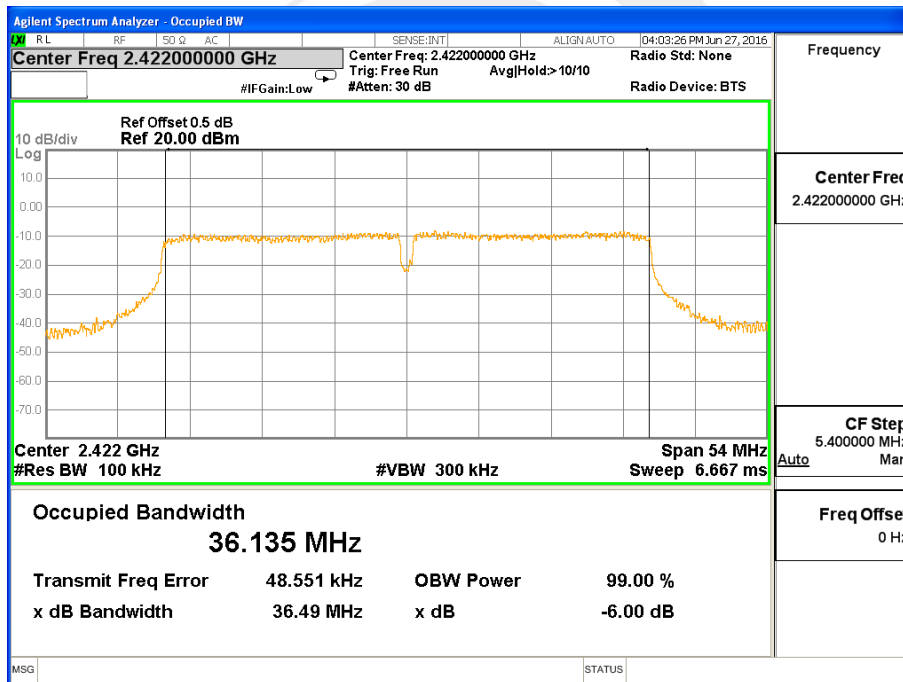




Temperature :	25 °C	Relative Humidity :	60%
Pressure :	1012 hPa	Test Voltage :	DC 5V
Test Mode :	TX n Mode(40M) /CH03, CH06, CH09		

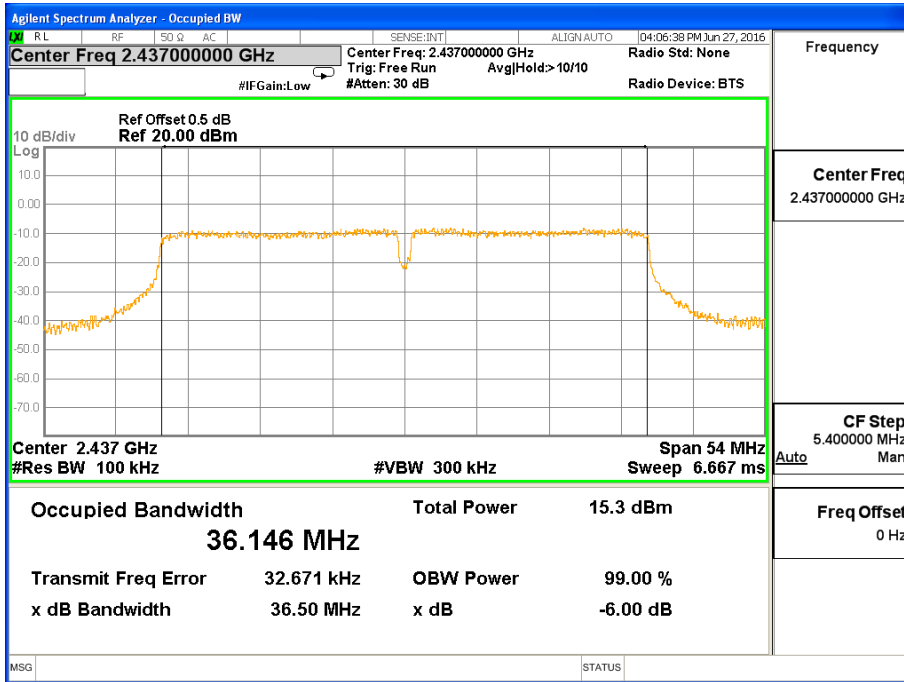
Frequency	6dB Bandwidth (MHz)	Channel Separation (KHz)	Result
2422 MHz	36.49	≥500KHz	PASS
2437 MHz	36.50	≥500KHz	PASS
2452 MHz	36.49	≥500KHz	PASS

TX CH 03

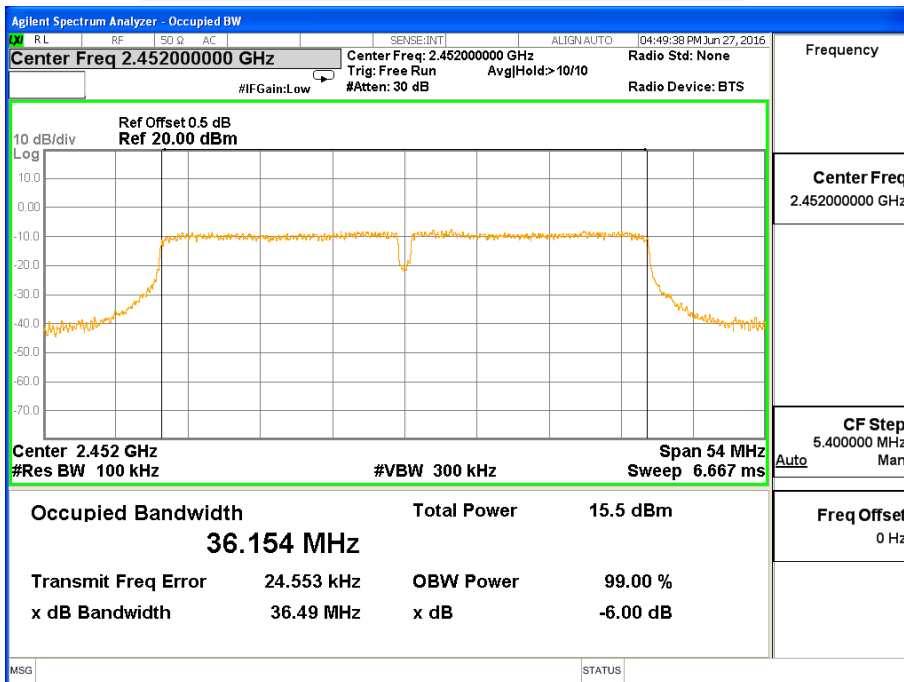




TX CH 06



TX CH 09





## 7. PEAK OUTPUT POWER TEST

### 7.1 APPLIED PROCEDURES / LIMIT

FCC Part15 (15.247) , Subpart C				
Section	Test Item	Limit	Frequency Range (MHz)	Result
15.247(b)(3)	Output Power	1 watt or 30dBm	2400-2483.5	PASS

### 7.2 TEST PROCEDURE

- a. The EUT was directly connected to the Power Sensor&PC

### 7.3 DEVIATION FROM STANDARD

No deviation.

### 7.4 TEST SETUP



### 7.5 EUT OPERATION CONDITIONS

The EUT tested system was configured as the statements of 2.3 Unless otherwise a special operating condition is specified in the follows during the testing.



## 7.6 TEST RESULTS

Temperature :	25 °C	Relative Humidity :	60%
Pressure :	1012 hPa	Test Voltage :	DC 5V

TX 802.11b Mode				
Test Channe	Frequency	Conducted Output Power		LIMIT
	(MHz)	Peak(dBm)	AVG(dBm)	dBm
CH01	2412	14.58	12.53	30
CH06	2437	14.63	12.35	30
CH11	2462	14.74	12.47	30

TX 802.11g Mode				
Test Channe	Frequency	Conducted Output Power		LIMIT
	(MHz)	Peak(dBm)	AVG(dBm)	dBm
CH01	2412	12.35	11.14	30
CH06	2437	13.01	11.35	30
CH11	2462	13.11	11.38	30

TX 802.11n20 Mode				
Test Channe	Frequency	Conducted Output Power		LIMIT
	(MHz)	Peak(dBm)	AVG(dBm)	dBm
CH01	2412	12.54	11.10	30
CH06	2437	13.00	11.24	30
CH11	2462	12.98	11.30	30

TX 802.11n40 Mode				
Test Channe	Frequency	Conducted Output Power		LIMIT
	(MHz)	Peak(dBm)	AVG(dBm)	dBm
CH03	2422	10.25	8.69	30
CH06	2437	10.36	8.52	30
CH09	2452	10.29	8.63	30



## 8. ANTENNA REQUIREMENT

### 8.1 STANDARD REQUIREMENT

15.203 requirement: For intentional device, according to 15.203: an intentional radiator shall be designed to ensure that no antenna other than that furnished by the responsible party shall be used with the device.

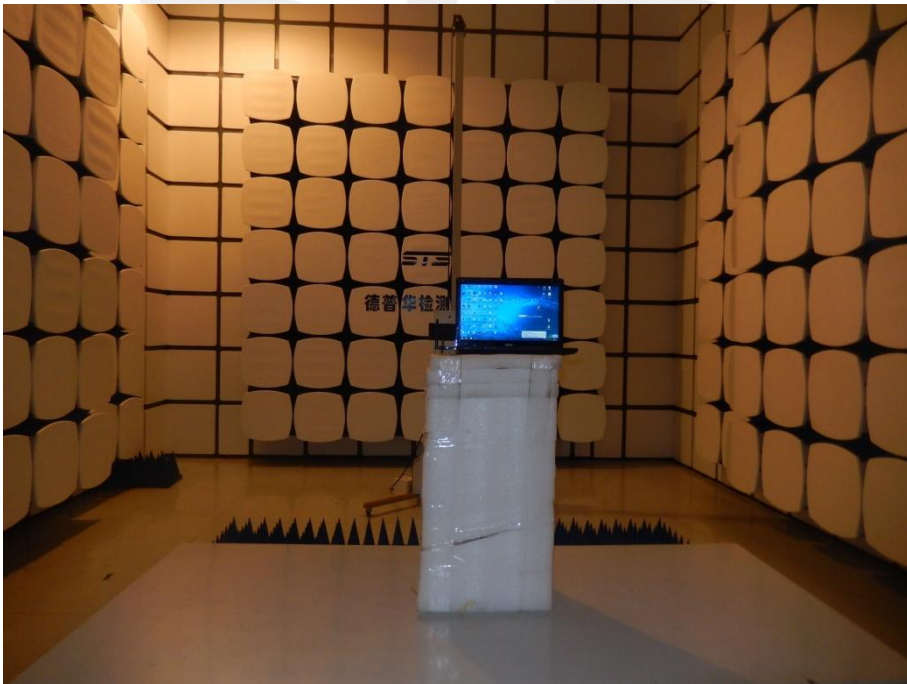
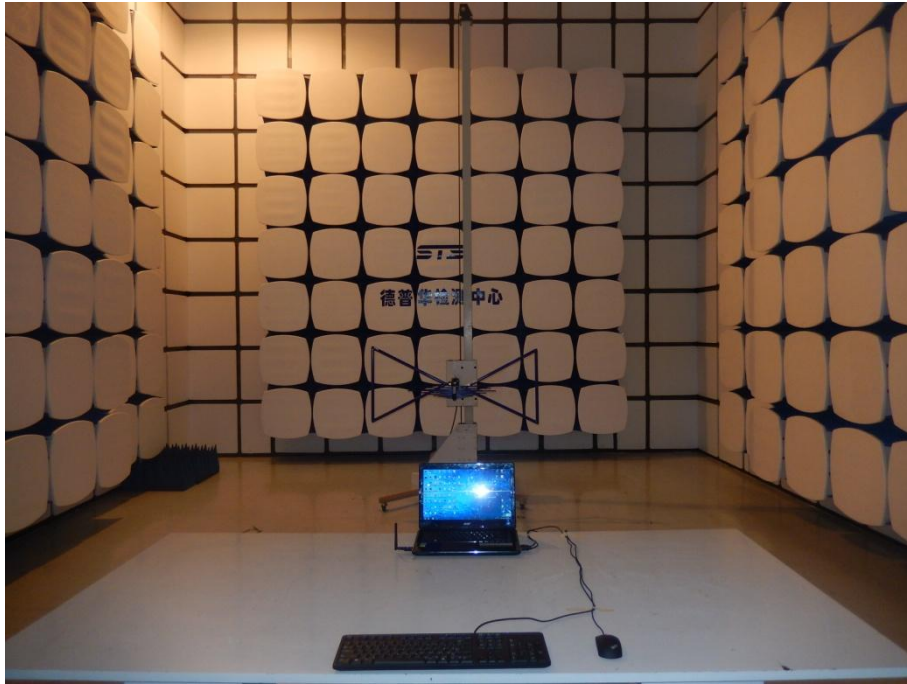
### 8.2 EUT ANTENNA

The EUT antenna is Dipole Antenna. It comply with the standard requirement.



APPENDIX - PHOTOS OF TEST SETUP

Radiated Measurement Photos







### Conducted Measurement Photos



※※※※END OF THE REPORT※※※※