



FCC TEST REPORT

Report No: STS1603186F02

Issued for

Shenzhen EDUP Electronics Technology Co.,Ltd.

6 Floor, #6 Building, No.48, Kangzheng Road, Liantang
Industrial Area, Buji Town, ShenZhen, China

Product Name:	EDUP USB Wireless Adapter
Brand Name:	EDUP
Model Name:	EP-DB1305
Series Model:	EP-DB1306
FCC ID:	2AHRDEP-DB1305
Test Standard:	FCC Part 15.407

Any reproduction of this document must be done in full. No single part of this document may be reproduced without permission from STS, All Test Data Presented in this report is only applicable to presented Test sample.

Shenzhen STS Test Services Co., Ltd.
1/F., Building B, Zhuoke Science Park, No.190,Chongqing Road,
Fuyong Street, Bao'an District, Shenzhen, Guangdong,China
TEL: +86-755 3688 6288 FAX: +86-755 3688 6277 E-mail:sts@stsapp.com





TEST RESULT CERTIFICATION

Applicant's name : Shenzhen EDUP Electronics Technology Co.,Ltd.
Address : 6 Floor, #6 Building, No.48, Kangzheng Road, Liantang Industrial Area, Buji Town,ShenZhen, China
Manufacture's Name..... : Shenzhen EDUP Electronics Technology Co.,Ltd.
Address : 6 Floor, #6 Building, No.48, Kangzheng Road, Liantang Industrial Area, Buji Town,ShenZhen, China

Product description

Product name..... : EDUP USB Wireless Adapter
Model and/or type reference : EP-DB1305
Series Model..... : EP-DB1306

Standards..... : FCC Part15.407

Test procedure..... ANSI C63.10-2013

This device described above has been tested by STS, and the test results show that the equipment under test (EUT) is in compliance with the FCC&IC requirements. And it is applicable only to the tested sample identified in the report.

This report shall not be reproduced except in full, without the written approval of STS, this document may be altered or revised by STS, personal only, and shall be noted in the revision of the document.

Date of Test..... :
Date (s) of performance of tests..... : 01 Apr. 2016 ~25 Apr. 2016
Date of Issue..... : 26 Apr. 2016
Test Result..... : **Pass**

Testing Engineer : 

 (Tony Liu)

Technical Manager : 

 (Vita Li)

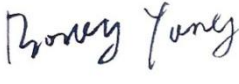
Authorized Signatory : 

 (Bovey Yang)





Table of Contents	Page
1 . SUMMARY OF TEST RESULTS	5
1.1 TEST FACTORY	6
1.2 MEASUREMENT UNCERTAINTY	6
2 . GENERAL INFORMATION	7
2.1 GENERAL DESCRIPTION OF EUT	7
2.2 DESCRIPTION OF TEST MODES	10
2.3 BLOCK DIGRAM SHOWING THE CONFIGURATION OF SYSTEM TESTED	11
2.4 DESCRIPTION OF SUPPORT UNITS(CONDUCTED MODE)	12
2.5 EQUIPMENTS LIST FOR ALL TEST ITEMS	13
3 . EMC EMISSION TEST	14
3.1 CONDUCTED EMISSION MEASUREMENT	14
3.2 RADIATED EMISSION AND (UNWANTED EMISSIONS) MEASUREMENT	18
4. CONDUCTED SPURIOUS EMISSIONS	38
4.1 APPLIED PROCEDURES / LIMIT	38
5.1 APPLIED PROCEDURES / LIMIT	61
6. BANDWIDTH MEASUREMENT	73
6.1 EMISSION BANDWIDTH (EBW) 26 BANDWID PROCEDURES / LIMIT	73
6.2 OCCUPIED BANDWIDTH (99%) TEST APPLIED PROCEDURES / LIMIT	75
6.3 MINIMUM EMISSION BANDWIDTH(6 DB) PROCEDURES / LIMIT	77
6.4 BANDWIDTH TEST POLT	79
7. MAXIMUM CONDUCTED OUTPUT POWER	94
7.1 APPLIED PROCEDURES / LIMIT	94
8. FREQUENCY STABILITY MEASUREMENT	96
8.1 LIMIT OF FREQUENCY STABILITY	96
9. AUTOMATICALLY DISCONTINUE TRANSMISSION	99
9.1 LIMIT OF AUTOMATICALLY DISCONTINUE TRANSMISSION	99
9.2 TEST RESULT OF AUTOMATICALLY DISCONTINUE TRANSMISSION	99
10. ANTENNA REQUIREMENT	100
10.1 STANDARD REQUIREMENT	100
10.2 EUT ANTENNA	100
APPENDIX - PHOTOS OF TEST SETUP	101



Revision History

Rev.	Issue Date	Report NO.	Effect Page	Contents
00	26 Apr. 2016	STS1603186F02	ALL	Initial Issue





1. SUMMARY OF TEST RESULTS

Test procedures according to the technical standards:

§ 15.407, KDB 789033 D02 General UNII Test Procedures New Rules v01r01

FCC Part15 (15.407)		
FCC standard	Test Item	Results
15.207	AC Conducted Emission	PASS
§ 15.407 (2) (26 dB) / § 15.407 (e) (6 dB) / § 15.407 (a) (99%)	26dB/6dB & 99% Bandwidth	PASS
15.407(a) (1).(2).(3).(4).(5)	Maximum Conducted Output Power	PASS
15.407(b)	Peak Excursion Ratio	N/A
15.407(b) & 15.209	Radiated Emission And (Unwanted Emissions) Measurement	PASS
15.407(b)7	Conducted Emission And (Unwanted Emissions) Measurement	PASS
15.407(a) (1).(2).(3).(4).(5)	Power Spectral Density	PASS
15.407(g)	Frequency Stability	PASS
15.407(c)	Automatically Discontinue Transmission	PASS
15.203/15.204	Antenna Requirement	PASS

NOTE:

(1) "N/A" denotes test is not applicable in this Test Report

(2) all tests are according to ANSI C63.10-2013



1.1 TEST FACTORY

Shenzhen STS Test Services Co., Ltd.

Add. : 1/F., Building B, Zhuoke Science Park, No.190,Chongqing Road,
Fuyong Street, Bao'an District, Shenzhen, Guangdong,China

CNAS Registration No.: L7649;

FCC Registration No.: 842334; IC Registration No.: 12108A-1

1.2 MEASUREMENT UNCERTAINTY

The reported uncertainty of measurement $y \pm U$, where expanded uncertainty U is based on a standard uncertainty multiplied by a coverage factor of $k=2$, providing a level of confidence of approximately **95 %**.

No.	Item	Uncertainty
1	Conducted Emission (9KHz-150KHz)	$\pm 2.88\text{dB}$
2	Conducted Emission (150KHz-30MHz)	$\pm 2.67\text{dB}$
3	RF power,conducted	$\pm 0.70\text{dB}$
4	Spurious emissions,conducted	$\pm 1.19\text{dB}$
5	All emissions,radiated(<1G) 30MHz-200MHz	$\pm 2.83\text{dB}$
6	All emissions,radiated(<1G) 200MHz-1000MHz	$\pm 2.94\text{dB}$
7	All emissions,radiated(>1G)	$\pm 3.03\text{dB}$
8	Temperature	$\pm 0.5^{\circ}\text{C}$
9	Humidity	$\pm 2\%$



2. GENERAL INFORMATION

2.1 GENERAL DESCRIPTION OF EUT

Equipment	EDUP USB Wireless Adapter	
Trade Name	EDUP	
Model Name	EP-DB1305	
Series Model	EP-DB1306	
Model Difference	Only different in model name	
Product Description	The EUT is a EDUP USB Wireless Adapter	
	Operation Frequency:	IEEE 802.11a/ n(HT20/40) 5.180GHz-5.240GHz
		IEEE 802.11a/ n(HT20/40)5.745GHz-5.825GHz
	Modulation Type:	IEEE for 802.11a: OFDM(BPSK/QPSK/16QAM) IEEE for 802.11n : OFDM(BPSK/QPSK/16QAM)
	Bit Rate of Transmitter	802.11a:54/48/36/24/18/12/9/6Mbps 802.11n(20/40MHz):150/144.44/130/117/115.56/104/86.67/78/52/6.5 Mbps
	Antenna Designation:	See Note 3
	Max.Output Power(Conducted):	7.65dBm
	The duty cycle of WLAN 802.11a/n were 98 %	
More details of EUT technical specification, please refer to the User's Manual.		
Test Channel	Please refer to the Note 2.	
Adapter	DC 5V, 500mA	
Hardware version number	V3.0	
Software version number	V3.1	
Connecting I/O Port(s)	Please refer to the User's Manual	

Note:For a more detailed features description, please refer to the manufacturer’s specifications or the User's Manual.



2. Operation Frequency of channel

5.180GHz-5.240GHz		5.745GHz-5.825GHz	
Channel	Frequency	Channel	Frequency
36	5180	149	5745
38	5190	151	5755
40	5200	153	5765
42	5210	157	5785
44	5220	159	5795
46	5230	161	5805
48	5240	165	5825

Note:

In section 15.31(m), regards to the operating frequency range over 10 MHz, the Lowest frequency, the middle frequency, and the highest frequency of channel were selected to perform the test, and the selected channel see below:

Carrier Frequency Channel

5GHz:

For 802.11a (HT20)

Channel	Freq.(MHz)	Channel	Freq.(MHz)
36	5180	149	5745
40	5200	157	5785
48	5240	165	5825

For 802.11n (HT20)

Channel	Freq.(MHz)	Channel	Freq.(MHz)
36	5180	149	5745
40	5200	157	5785
48	5240	165	5825

For 802.11n (HT40)

Channel	Freq.(MHz)	Channel	Freq.(MHz)
38	5190	151	5755
46	5230	159	5795



3. Emissions Testing of Transmitters with Multiple Outputs in the Same Band.

For devices having two outputs driving a cross-polarized pair of antennas, see Attachment 662911 D02 of this publication for additional guidance.

d) *Unequal antenna gains, with equal transmit powers.* For antenna gains given by G1, G2, ..., GN dBi

(i) If transmit signals are *correlated*, then Directional gain = 10 log[(10^{G1/20} + 10^{G2/20} + ... + 10^{GN/20})² /NANT] dBi [Note the "20"s in the denominator of each exponent and the square of the sum of terms; the object is to combine the signal levels coherently.]

(ii) If all transmit signals are *completely uncorrelated*, then Directional gain = 10 log[(10^{G1/10} + 10^{G2/10} + ... + 10^{GN/10})/NANT] dBi

Not: If transmit signals are *correlated*, then Directional gain.

ANT-A=2.5 dBi

ANT-B=2.5 dBi

Total gain=10 log[(10^{G1/20} + 10^{G2/20} + ... + 10^{GN/20})² /NANT] dBi

10*LOG10((10^(2.5/20)+10^(2.5/20))^2/2)=5.51

Ant	Brand	Model Name	Antenna Type	Connector	Gain (dBi)	Total (dBi)
A	EDUP	EP-DB1305	PCB Antenna	N/A	ANT.A=2.5	5.51
B	EDUP	EP-DB1305	PCB Antenna	N/A	ANT.B=2.5	



2.2 DESCRIPTION OF TEST MODES

To investigate the maximum EMI emission characteristics generates from EUT, the test system was pre-scanning tested base on the consideration of following EUT operation mode or test configuration mode which possible have effect on EMI emission level. Each of these EUT operation mode(s) or test configuration mode(s) mentioned above was evaluated respectively.

Worst Mode	Description	Data Rate
Mode 1	TX IEEE 802.11a CH36&CH149	6 Mbps
Mode 2	TX IEEE 802.11a CH40&CH157	6 Mbps
Mode 3	TX IEEE 802.11 a CH48&CH165	6 Mbps
Mode 4	TX IEEE 802.11n HT20 CH36&CH149	MCS 0
Mode 5	TX IEEE 802.11n HT20 CH40&CH157	MCS 0
Mode 6	TX IEEE 802.11n HT20 CH48&CH165	MCS 0
Mode 7	TX IEEE 802.11n HT40 CH38&CH151	MCS 0
Mode 8	TX IEEE 802.11n HT40 CH46&CH159	MCS 0

Note:

- (1) The measurements are performed at the highest, middle, lowest available channels.
- (2) The measurements are performed at all Bit Rate of Transmitter, the worst data was reported
- (3) The EUT 's duty cycle is set to 100%

AC Conducted Emission

Test Case	
AC Conducted Emission	Mode 9: Keeping TX + WLAN Link

2.3 BLOCK DIGRAM SHOWING THE CONFIGURATION OF SYSTEM TESTED

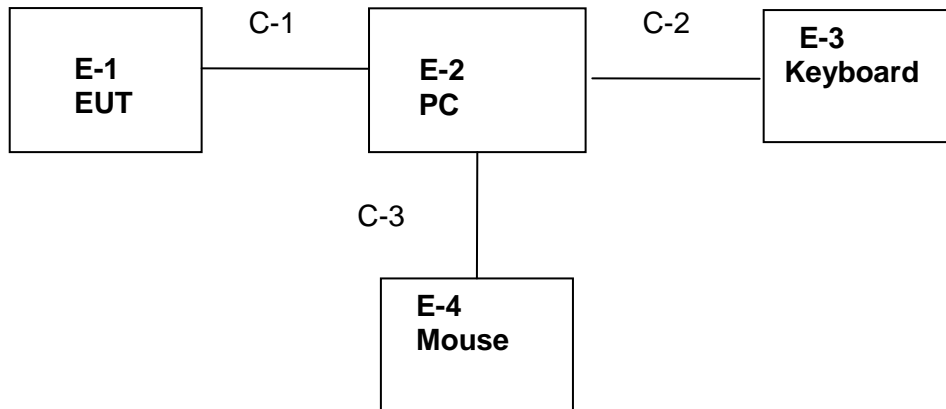



2.4 DESCRIPTION OF SUPPORT UNITS(CONDUCTED MODE)

The EUT has been tested as an independent unit together with other necessary accessories or support units. The following support units or accessories were used to form a representative test configuration during the tests.

Item	Equipment	Mfr/Brand	Model/Type No.	Series No.	Note
E-1	EDUP USB Wireless Adapter	EDUP	EP-DB1305	N/A	EUT
E-2	PC	4CV428DQXR	500-320cx	N/A	N/A
E-3	Keyboard	HP	PR1101U	N/A	N/A
E-4	Mouse	MOTOSPEED	F66	N/A	N/A

Item	Shielded Type	Ferrite Core	Length	Note
C-1	USB Cable (FTP)	NO	100cm	N/A
C-2	USB Cable (FTP)	NO	100cm	N/A
C-3	USB Cable (FTP)	NO	110cm	N/A

Note:

- (1) The support equipment was authorized by Declaration of Confirmation.
- (2) For detachable type I/O cable should be specified the length in cm in 『Length』 column.
- (3) “YES” is means “shielded” “with core”; “NO” is means “unshielded” “without core”.



2.5 EQUIPMENTS LIST FOR ALL TEST ITEMS

Radiation Test equipment

Kind of Equipment	Manufacturer	Type No.	Serial No.	Last calibration	Calibrated until
Spectrum Analyzer	Agilent	E4407B	MY50140340	2015.10.25	2016.10.24
Test Receiver	R&S	ESCI	101427	2015.10.25	2016.10.24
Bilog Antenna	TESEQ	CBL6111D	34678	2015.11.25	2016.11.24
Horn Antenna	Schwarzbeck	BBHA 9120D	9120D-1343	2016.03.06	2017.03.05
Horn Antenna	Schwarzbeck	BBHA 9170	9170-0741	2016.03.06	2017.03.05
50Ω Coaxial Switch	Anritsu	MP59B	6200264416	2015.06.06	2016.06.05
PreAmplifier	Agilent	8449B	60538	2015.10.25	2016.10.24
Loop Antenna	ARA	PLA-1030/B	1029	2015.06.08	2016.06.07
Low frequency cable	EM	R01	N/A	N/A	N/A
High frequency cable	SCHWARZBECK	AK9515H	SN-96286/96287	N/A	N/A

Conduction Test equipment

Kind of Equipment	Manufacturer	Type No.	Serial No.	Last calibration	Calibrated until
EMI Test Receiver	R&S	ESPI	102086	2015.11.20	2016.11.19
LISN	R&S	ENV216	101242	2015.10.25	2016.10.24
LISN	EMCO	3810/2NM	000-23625	2015.10.25	2016.10.24
Conduction Cable	EM	C01	N/A	N/A	N/A

RF Connected Test

Kind of Equipment	Manufacturer	Type No.	Serial No.	Last calibration	Calibrated until
USB RF power sensor	DARE	RPR3006W	15I00041SNO03	2015.10.25	2016.10.24
Spectrum Analyzer	Agilent	E4407B	MY50140340	2015.10.25	2016.10.24
Signal Analyzer	Agilent	N9020A	MY49100060	2015.11.18	2016.11.17



3. EMC EMISSION TEST

3.1 CONDUCTED EMISSION MEASUREMENT

3.1.1 POWER LINE CONDUCTED EMISSION Limits (Frequency Range 150KHz-30MHz)

FREQUENCY (MHz)	Class B (dBuV)		Standard
	Quasi-peak	Average	
0.15 -0.5	66 - 56 *	56 - 46 *	CISPR
0.50 -5.0	56.00	46.00	CISPR
5.0 -30.0	60.00	50.00	CISPR

0.15 -0.5	66 - 56 *	56 - 46 *	FCC
0.50 -5.0	56.00	46.00	FCC
5.0 -30.0	60.00	50.00	FCC

Note:

- (1) The tighter limit applies at the band edges.
- (2) The limit of " * " marked band means the limitation decreases linearly with the logarithm of the frequency in the range.

The following table is the setting of the receiver

Receiver Parameters	Setting
Attenuation	10 dB
Start Frequency	0.15 MHz
Stop Frequency	30 MHz
IF Bandwidth	9 kHz

3.1.2 TEST PROCEDURE

- a. The EUT was placed 0.4 meters from the horizontal ground plane with EUT being connected to the power mains through a line impedance stabilization network (LISN). All other support equipments powered from additional LISN(s). The LISN provide 50 Ohm/ 50uH of coupling impedance for the measuring instrument.
- b. Interconnecting cables that hang closer than 40 cm to the ground plane shall be folded back and forth in the center forming a bundle 30 to 40 cm long.
- c. I/O cables that are not connected to a peripheral shall be bundled in the center. The end of the cable may be terminated, if required, using the correct terminating impedance. The overall length shall not exceed 1 m.
- d. LISN at least 80 cm from nearest part of EUT chassis.
- e. For the actual test configuration, please refer to the related Item –EUT Test Photos.

3.1.3 DEVIATION FROM TEST STANDARD

No deviation

3.1.4 TEST SETUP

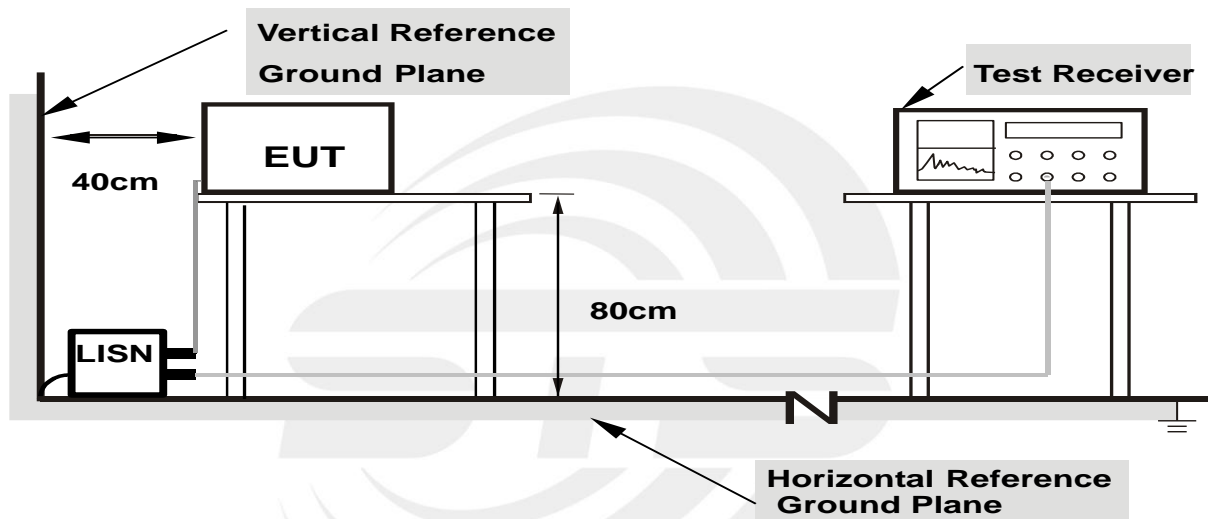

- Note:**
- 1.Support units were connected to second LISN.
 - 2.Both of LISNs (AMN) are 80 cm from EUT and at least 80 from other units and other metal planes

3.1.5 EUT OPERATING CONDITIONS

The EUT was configured for testing in a typical fashion (as a customer would normally use it). The EUT has been programmed to continuously transmit during test. This operating condition was tested and used to collect the included data.



3.1.6 TEST RESULTS

Temperature:	26 °C	Relative Humidity:	54%
Pressure:	1010hPa	Phase:	L
Test Voltage :	AC 120V/60Hz	Test Mode :	Mode 9

Frequency (MHz)	Reading (dBuV)	Correct Factor(dB)	Result (dBuV)	Limit (dBuV)	Margin (dB)	Remark
0.1500	49.00	11.20	60.20	66.00	-5.80	QP
0.1500	29.46	11.20	40.66	56.00	-15.34	AVG
0.1980	44.17	10.00	54.17	63.69	-9.52	QP
0.1980	26.83	10.00	36.83	53.69	-16.86	AVG
0.3540	36.31	10.06	46.37	58.87	-12.50	QP
0.3540	17.41	10.06	27.47	48.87	-21.40	AVG
1.7660	22.74	9.98	32.72	56.00	-23.28	QP
1.7660	9.62	9.98	19.60	46.00	-26.40	AVG
4.4300	32.22	10.20	42.42	56.00	-13.58	QP
4.4300	16.64	10.20	26.84	46.00	-19.16	AVG
14.2300	34.19	10.32	44.51	60.00	-15.49	QP
14.2300	17.73	10.32	28.05	50.00	-21.95	AVG

Remark:

1. Margin = Result (Result =Reading + Factor)–Limit

100.0 dBuV

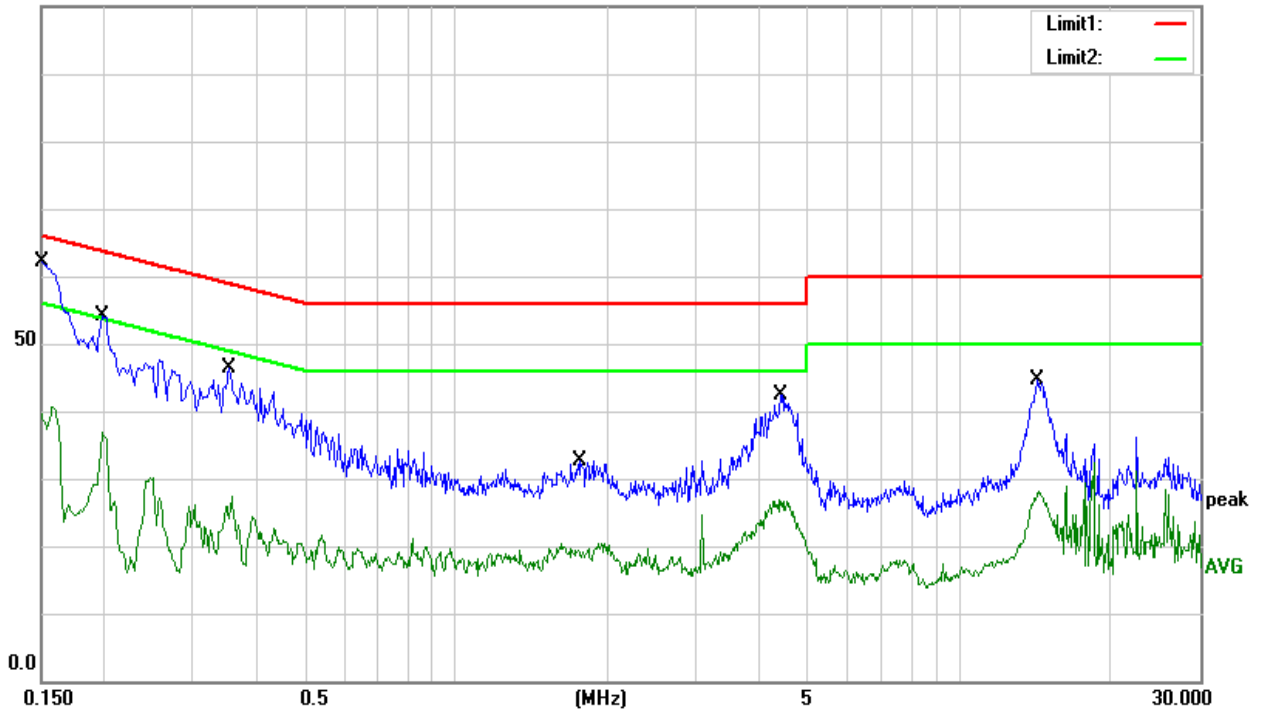



Temperature:	26 °C	Relative Humidity:	54%
Pressure:	1010hPa	Phase:	N
Test Voltage	AC 120V/60Hz	Test Mode	Mode 9

Frequency (MHz)	Reading (dBuV)	Correct Factor(dB)	Result (dBuV)	Limit (dBuV)	Margin (dB)	Remark
0.1500	49.20	11.20	60.40	66.00	-5.60	QP
0.1500	31.74	11.20	42.94	56.00	-13.06	AVG
0.1660	48.88	10.00	58.88	65.16	-6.28	QP
0.1660	17.18	10.00	27.18	55.16	-27.98	AVG
0.2100	46.40	9.99	56.39	63.21	-6.82	QP
0.2100	26.86	9.99	36.85	53.21	-16.36	AVG
0.2987	40.37	9.90	50.27	60.28	-10.01	QP
0.2987	18.54	9.90	28.44	50.28	-21.84	AVG
3.4140	27.67	10.17	37.84	56.00	-18.16	QP
3.4140	15.27	10.17	25.44	46.00	-20.56	AVG
14.4020	34.51	10.30	44.81	60.00	-15.19	QP
14.4020	18.29	10.30	28.59	50.00	-21.41	AVG

Remark:

1. Margin = Result (Result =Reading + Factor)–Limit

100.0 dBuV

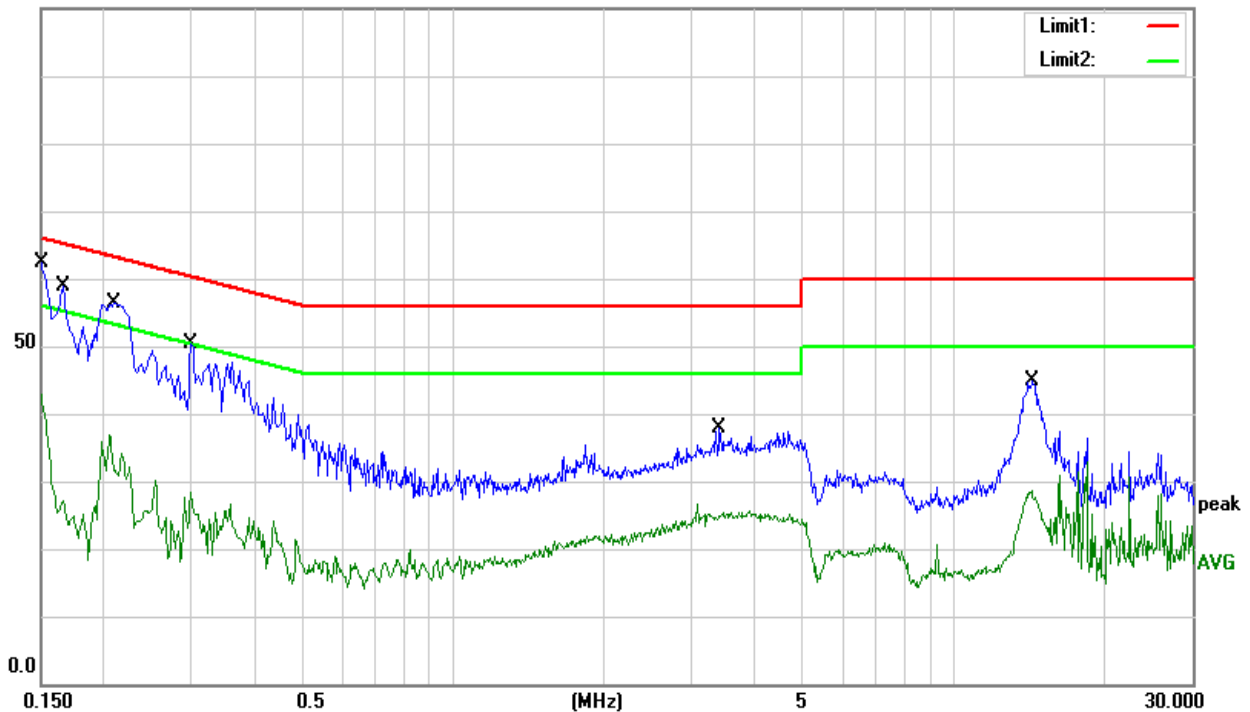



3.2 RADIATED EMISSION AND (UNWANTED EMISSIONS) MEASUREMENT

3.2.1 RADIATED EMISSION LIMITS (Frequency Range 9kHz-1000MHz)

In case the emission fall within the restricted band specified on 15.407(b)7& 15.205/209(a), then the (a); limit in the table below has to be followed.

Frequencies (MHz)	Field Strength (micorvolts/meter)	Measurement Distance (meters)
0.009~0.490	2400/F(KHz)	300
0.490~1.705	24000/F(KHz)	30
1.705~30.0	30	30
30~88	100	3
88~216	150	3
216~960	200	3
Above 960	500	3

LIMITS OF RADIATED EMISSION MEASUREMENT (Above 1000MHz)

FREQUENCY (MHz)	Class B (dBuV/m) (at 3M)	
	PEAK	AVERAGE
Above 1000	74	54

Notes:

- (1) The limit for radiated test was performed according to FCC PART 15E.
- (2) The tighter limit applies at the band edges.
- (3) Emission level (dBuV/m)=20log Emission level (uV/m).

Spectrum Parameter	Setting
Attenuation	Auto
Detector	Peak
Start Frequency	1000 MHz(Peak/AV)
Stop Frequency	10th carrier harmonic(Peak/AV)
RB / VB (emission in restricted band)	1 MHz / 1 MHz, AV=1 MHz /3 MHz

For Band edge

Spectrum Parameter	Setting
Detector	Peak
Start/Stop Frequency	Lower Band Edge: 5130 to 5370 MHz Upper Band Edge: 5705 to 5880 MHz
RB / VB (emission in restricted band)	1 MHz / 1 MHz, AV=1 MHz /3 MHz



Receiver Parameter	Setting
Attenuation	Auto
Start ~ Stop Frequency	9kHz~90kHz / RB 200Hz for PK & AV
Start ~ Stop Frequency	90kHz~110kHz / RB 200Hz for QP
Start ~ Stop Frequency	110kHz~490kHz / RB 200Hz for PK & AV
Start ~ Stop Frequency	490kHz~30MHz / RB 9kHz for QP
Start ~ Stop Frequency	30MHz~1000MHz / RB 120kHz for QP

3.2.2 TEST PROCEDURE

- The measuring distance of at 3 m shall be used for measurements at frequency up to 1GHz. For frequencies above 1GHz, any suitable measuring distance may be used.
- The EUT was placed on the top of a rotating table 0.8 meters above the ground at a 3 meter anechoic chamber test site. The table was rotated 360 degrees to determine the position of the highest radiation.
- The height of the equipment or of the substitution antenna shall be 0.8 m; the height of the test antenna shall vary between 1 m to 4 m. Both horizontal and vertical polarizations of the antenna are set to make the measurement.
- The initial step in collecting conducted emission data is a spectrum analyzer peak detector mode pre-scanning the measurement frequency range. Significant peaks are then marked and then Quasi Peak detector mode re-measured.
- If the Peak Mode measured value compliance with and lower than Quasi Peak Mode Limit, the EUT shall be deemed to meet QP Limits and then no additional QP Mode measurement performed.
- For the actual test configuration, please refer to the related Item –EUT Test Photos.

Note:

Both horizontal and vertical antenna polarities were tested and performed pretest to three orthogonal axis. The worst case emissions were reported

3.2.3 DEVIATION FROM TEST STANDARD

No deviation

3.2.4 TEST SETUP

(A) Radiated Emission Test-Up Frequency Below 30MHz

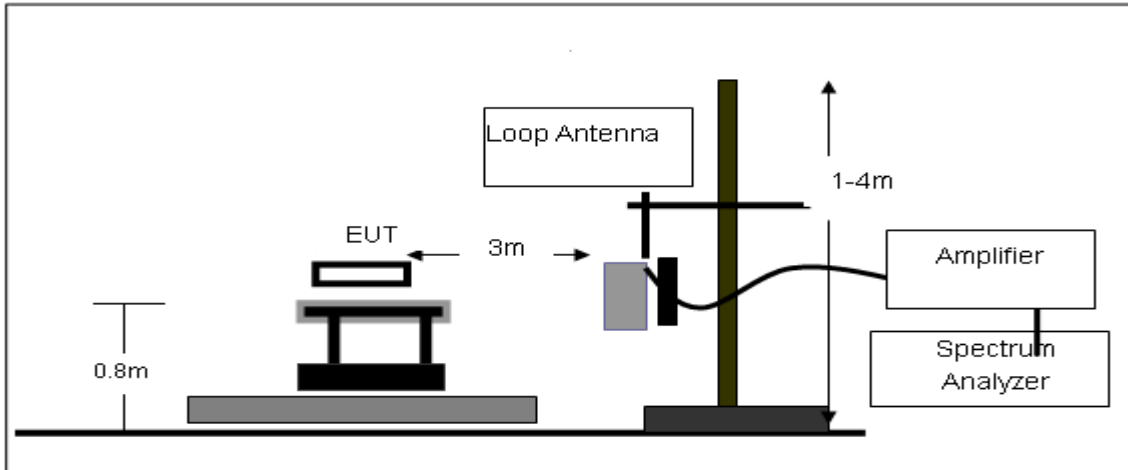

(B) Radiated Emission Test-Up Frequency 30MHz~1GHz

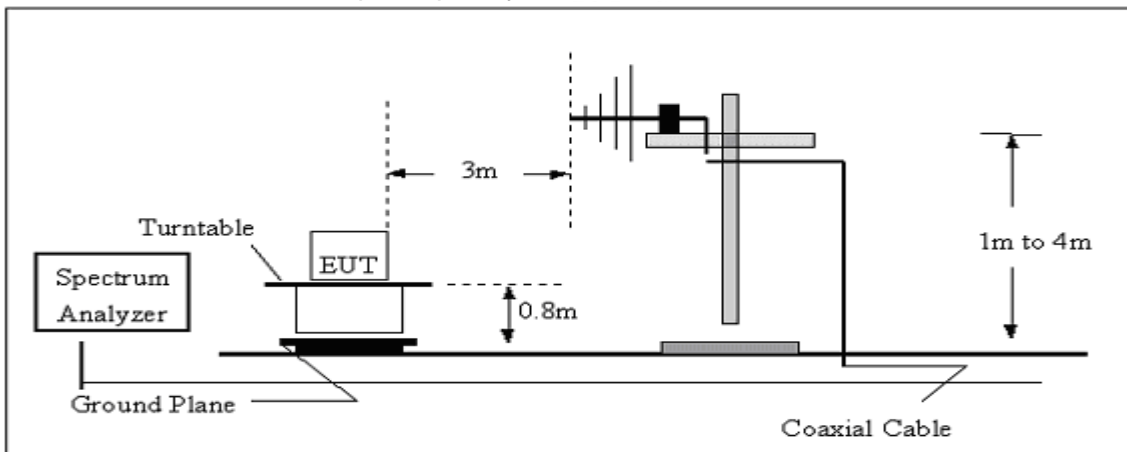

(C) Radiated Emission Test-Up Frequency Above 1GHz

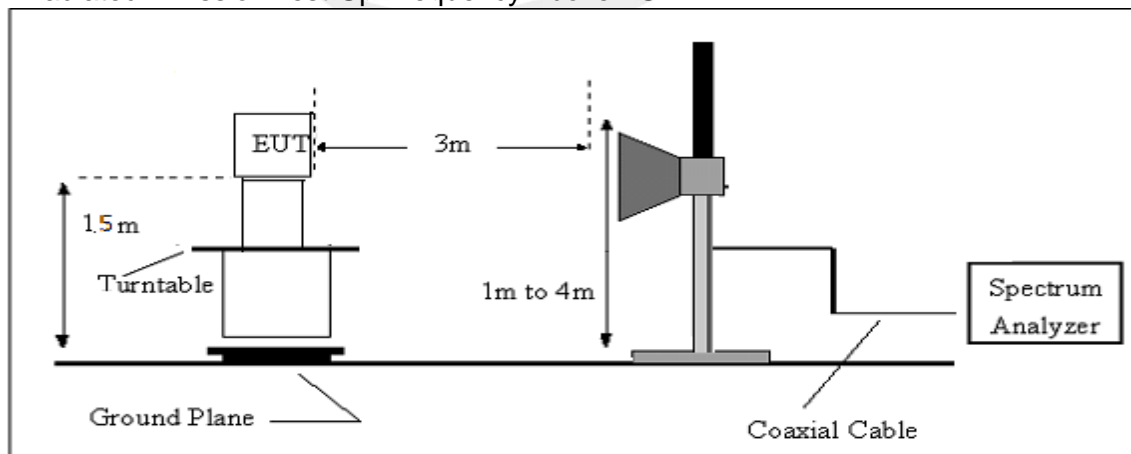

3.2.5 EUT OPERATING CONDITIONS

The EUT tested system was configured as the statements of 2.4 Unless otherwise a special operating condition is specified in the follows during the testing.

**3.2.6 TEST RESULTS (BETWEEN 9KHZ – 30 MHZ)**

Temperature:	20 °C	Relative Humidity:	48%
Pressure:	1010 hPa	Test Voltage :	AC 120V/60Hz
Test Mode :	TX Mode	Polarization :	--

Freq.	Reading	Limit	Margin	State
(MHz)	(dBuV/m)	(dBuV/m)	(dB)	P/F
--	--	--	--	PASS
--	--	--	--	PASS

Note:

The amplitude of spurious emissions which are attenuated by more than 20dB below the permissible value has no need to be reported.

Distance extrapolation factor = $40 \log(\text{specific distance}/\text{test distance})$ (dB);

Limit line = specific limits(dBuv) + distance extrapolation factor.

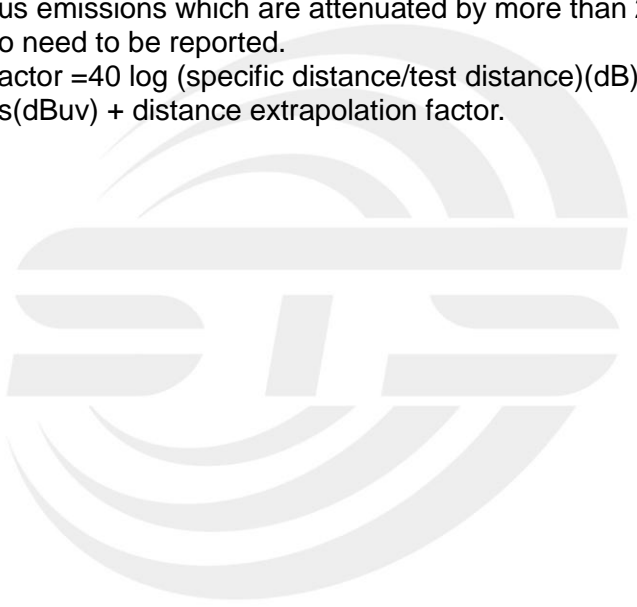



3.2.7 TEST RESULTS (BETWEEN 30MHZ – 1GHZ)

Temperature	26 °C	Relative Humidity	48%
Pressure	1010 hPa	Test Voltage	AC 120V/60Hz
Test Mode	(Mode 1-6M worst mode)	Polarization	Horizontal

Frequency (MHz)	Reading (dBUV)	Correct Factor(dB/m)	Result (dBUV/m)	Limit (dBUV/m)	Margin (dB)	Remark
64.8865	56.03	-24.22	31.81	40.00	-8.19	QP
71.0803	56.41	-23.94	32.47	40.00	-7.53	QP
153.7385	46.19	-18.17	28.02	43.50	-15.48	QP
236.6447	49.64	-17.99	31.65	46.00	-14.35	QP
472.1760	40.48	-9.69	30.79	46.00	-15.21	QP
689.5644	36.26	-5.57	30.69	46.00	-15.31	QP

Remark:

1. All readings are Quasi-Peak and Average values.
2. Margin = Result (Result = Reading + Factor) – Limit

80.0 dBUV/m

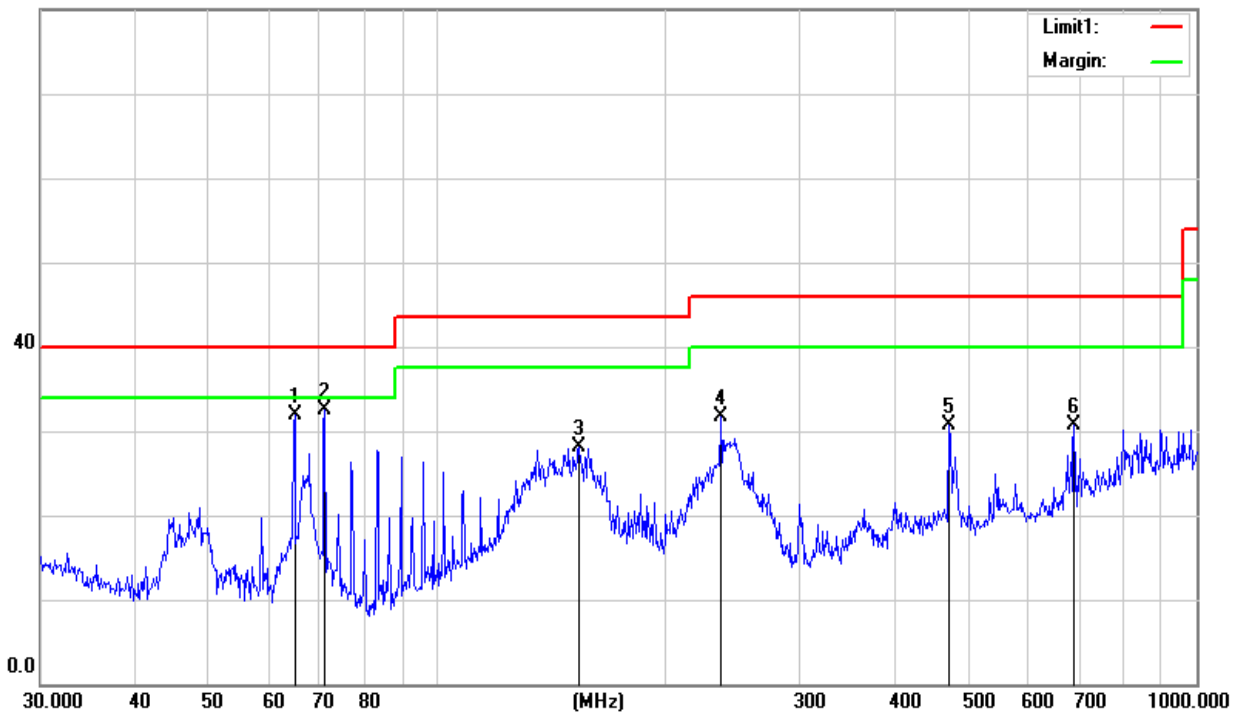



Temperature	26 °C	Relative Humidity	48%
Pressure	1010 hPa	Test Voltage	AC 120V/60Hz
Test Mode	(Mode 1-6M worst mode)	Polarization	Vertical

Frequency (MHz)	Reading (dBuV)	Correct Factor(dB/m)	Result (dBuV/m)	Limit (dBuV/m)	Margin (dB)	Remark
64.8864	54.23	-24.22	30.01	40.00	-9.99	QP
67.9128	47.70	-24.15	23.55	40.00	-16.45	QP
186.4408	44.45	-19.97	24.48	43.50	-19.02	QP
236.6447	47.47	-17.99	29.48	46.00	-16.52	QP
473.8346	41.58	-9.62	31.96	46.00	-14.04	QP
896.9964	37.29	-2.30	34.99	46.00	-11.01	QP

Remark:

1. All readings are Quasi-Peak and Average values.
2. Margin = Result (Result = Reading + Factor) – Limit
80.0 dBuV/m

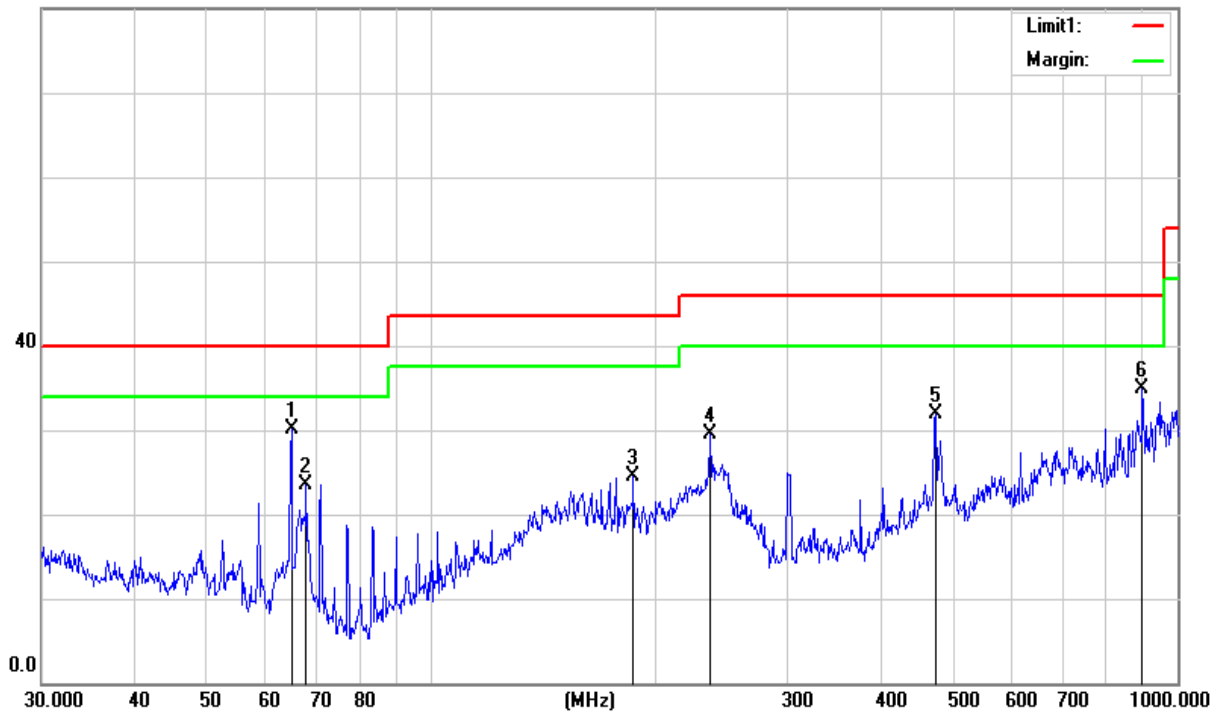

**3.2.8 TEST RESULTS (ABOVE 1000 MHZ)**

(worst mode)

Band I(5.15-5.25) GHz**Low Channel (802.11/ 5180 MHz)**

Frequency	Meter Reading	Factor	Emission Level	Limits	Margin	Detector	Comment
(MHz)	(dBμV)	(dB)	(dBμV/m)	(dBμV/m)	(dB)	Type	
3265.32	45.19	-9.80	35.39	74.00	-38.61	PK	Vertical
3265.30	42.17	-9.80	32.37	54.00	-21.63	AV	Vertical
3265.29	45.15	-9.80	35.35	74.00	-38.65	PK	Horizontal
3265.32	42.18	-9.80	32.38	54.00	-21.62	AV	Horizontal
3334.92	42.93	-9.75	33.18	74.00	-40.82	PK	Vertical
3335.10	39.94	-9.75	30.19	54.00	-23.81	AV	Vertical
3334.90	42.94	-9.75	33.19	74.00	-40.81	PK	Horizontal
3335.12	39.96	-9.75	30.21	54.00	-23.79	AV	Horizontal
3349.94	42.70	-9.75	32.95	74.00	-41.05	PK	Vertical
3350.05	39.72	-9.75	29.97	54.00	-24.03	AV	Vertical
3349.95	42.74	-9.75	32.99	74.00	-41.01	PK	Horizontal
3350.01	39.71	-9.75	29.96	54.00	-24.04	AV	Horizontal
4000.28	40.07	-6.60	33.47	74.00	-40.53	PK	Vertical
4000.17	37.06	-6.60	30.46	54.00	-23.54	AV	Vertical
4000.27	40.06	-6.60	33.46	74.00	-40.54	PK	Horizontal
4000.16	37.03	-6.60	30.43	54.00	-23.57	AV	Horizontal
7236.36	37.83	3.40	41.23	74.00	-32.77	PK	Vertical
7236.41	34.85	3.40	38.25	54.00	-15.75	AV	Vertical
7236.40	37.88	3.40	41.28	74.00	-32.72	PK	Horizontal
7236.42	34.87	3.40	38.27	54.00	-15.73	AV	Horizontal
8124.49	36.34	4.80	41.14	74.00	-32.86	PK	Vertical
8124.50	33.30	4.80	38.10	54.00	-15.90	AV	Vertical
8124.48	36.35	4.80	41.15	74.00	-32.85	PK	Horizontal
8124.51	33.32	4.80	38.12	54.00	-15.88	AV	Horizontal
9105.18	35.17	5.00	40.17	74.00	-33.83	PK	Vertical
9105.31	32.10	5.00	37.10	54.00	-16.90	AV	Vertical
9105.20	35.12	5.00	40.12	74.00	-33.88	PK	Horizontal
9105.27	32.12	5.00	37.12	54.00	-16.88	AV	Horizontal
10360.43	40.11	10.20	50.31	74.00	-23.69	PK	Vertical
10360.60	37.09	10.20	47.29	54.00	-6.71	AV	Vertical
10360.44	40.13	10.20	50.33	74.00	-23.67	PK	Horizontal
10360.62	37.09	10.20	47.29	54.00	-6.71	AV	Horizontal



11036.43	34.13	10.20	44.33	74.00	-29.67	PK	Vertical
11036.60	31.12	10.20	41.32	54.00	-12.68	AV	Vertical
11036.44	34.13	10.20	44.33	74.00	-29.67	PK	Horizontal
11036.62	31.08	10.20	41.28	54.00	-12.72	AV	Horizontal
13299.95	32.93	12.20	45.13	74.00	-28.87	PK	Vertical
13299.92	29.95	12.20	42.15	54.00	-11.85	AV	Vertical
13299.94	32.97	12.20	45.17	74.00	-28.83	PK	Horizontal
13299.96	29.93	12.20	42.13	54.00	-11.87	AV	Horizontal
14480.29	31.87	13.40	45.27	74.00	-28.73	PK	Vertical
14480.44	28.89	13.40	42.29	54.00	-11.71	AV	Vertical
14480.28	31.82	13.40	45.22	74.00	-28.78	PK	Horizontal
14480.44	28.90	13.40	42.30	54.00	-11.70	AV	Horizontal
15540.29	35.87	13.40	49.27	74.00	-24.73	PK	Vertical
15540.44	32.88	13.40	46.28	54.00	-7.72	AV	Vertical
15540.28	35.86	13.40	49.26	74.00	-24.74	PK	Horizontal
15540.44	32.86	13.40	46.26	54.00	-7.74	AV	Horizontal
16000.30	31.02	12.40	43.42	74.00	-30.58	PK	Vertical
16000.38	27.96	12.40	40.36	54.00	-13.64	AV	Vertical
16000.28	30.98	12.40	43.38	74.00	-30.62	PK	Horizontal
16000.38	27.96	12.40	40.36	54.00	-13.64	AV	Horizontal
17998.36	28.16	23.10	51.26	74.00	-22.74	PK	Vertical
17998.25	26.17	23.10	49.27	54.00	-4.73	AV	Vertical
17998.24	28.15	23.10	51.25	74.00	-22.75	PK	Horizontal
17998.14	26.16	23.10	49.26	54.00	-4.74	AV	Horizontal



Mid Channel (802.11/ 5200 MHz)

Frequency	Meter Reading	Factor	Emission Level	Limits	Margin	Detector	Comment
(MHz)	(dB μ V)	(dB)	(dB μ V/m)	(dB μ V/m)	(dB)	Type	
3265.32	45.20	-9.80	35.40	74.00	-38.60	PK	Vertical
3265.30	42.17	-9.80	32.37	54.00	-21.63	AV	Vertical
3265.29	45.19	-9.80	35.39	74.00	-38.61	PK	Horizontal
3265.32	42.15	-9.80	32.35	54.00	-21.65	AV	Horizontal
3334.92	42.93	-9.75	33.18	74.00	-40.82	PK	Vertical
3335.10	39.96	-9.75	30.21	54.00	-23.79	AV	Vertical
3334.90	42.94	-9.75	33.19	74.00	-40.81	PK	Horizontal
3335.12	39.95	-9.75	30.20	54.00	-23.80	AV	Horizontal
3349.94	42.69	-9.75	32.94	74.00	-41.06	PK	Vertical
3350.05	39.69	-9.75	29.94	54.00	-24.06	AV	Vertical
3349.95	42.70	-9.75	32.95	74.00	-41.05	PK	Horizontal
3350.01	39.73	-9.75	29.98	54.00	-24.02	AV	Horizontal
4000.28	40.07	-6.60	33.47	74.00	-40.53	PK	Vertical
4000.17	37.07	-6.60	30.47	54.00	-23.53	AV	Vertical
4000.27	40.05	-6.60	33.45	74.00	-40.55	PK	Horizontal
4000.16	37.06	-6.60	30.46	54.00	-23.54	AV	Horizontal
7236.36	37.84	3.40	41.24	74.00	-32.76	PK	Vertical
7236.41	34.85	3.40	38.25	54.00	-15.75	AV	Vertical
7236.40	37.88	3.40	41.28	74.00	-32.72	PK	Horizontal
7236.42	34.87	3.40	38.27	54.00	-15.73	AV	Horizontal
8124.49	36.34	4.80	41.14	74.00	-32.86	PK	Vertical
8124.50	33.33	4.80	38.13	54.00	-15.87	AV	Vertical
8124.48	36.31	4.80	41.11	74.00	-32.89	PK	Horizontal
8124.51	33.36	4.80	38.16	54.00	-15.84	AV	Horizontal
9105.18	35.14	5.00	40.14	74.00	-33.86	PK	Vertical
9105.31	32.13	5.00	37.13	54.00	-16.87	AV	Vertical
9105.20	35.12	5.00	40.12	74.00	-33.88	PK	Horizontal
9105.27	32.11	5.00	37.11	54.00	-16.89	AV	Horizontal
10400.43	40.13	10.20	50.33	74.00	-23.67	PK	Vertical
10400.60	37.10	10.20	47.30	54.00	-6.70	AV	Vertical
10400.44	40.12	10.20	50.32	74.00	-23.68	PK	Horizontal
10400.62	37.12	10.20	47.32	54.00	-6.68	AV	Horizontal
11036.43	34.12	10.20	44.32	74.00	-29.68	PK	Vertical
11036.60	31.12	10.20	41.32	54.00	-12.68	AV	Vertical



11036.44	34.09	10.20	44.29	74.00	-29.71	PK	Horizontal
11036.62	31.09	10.20	41.29	54.00	-12.71	AV	Horizontal
13299.95	32.95	12.20	45.15	74.00	-28.85	PK	Vertical
13299.92	29.97	12.20	42.17	54.00	-11.83	AV	Vertical
13299.94	32.97	12.20	45.17	74.00	-28.83	PK	Horizontal
13299.96	29.98	12.20	42.18	54.00	-11.82	AV	Horizontal
14480.29	31.86	13.40	45.26	74.00	-28.74	PK	Vertical
14480.44	28.87	13.40	42.27	54.00	-11.73	AV	Vertical
14480.28	31.85	13.40	45.25	74.00	-28.75	PK	Horizontal
14480.44	28.88	13.40	42.28	54.00	-11.72	AV	Horizontal
15600.29	35.88	13.40	49.28	74.00	-24.72	PK	Vertical
15600.35	32.88	13.40	46.28	54.00	-7.72	AV	Vertical
15600.28	35.82	13.40	49.22	74.00	-24.78	PK	Horizontal
15600.44	32.89	13.40	46.29	54.00	-7.71	AV	Horizontal
16000.30	31.01	12.40	43.41	74.00	-30.59	PK	Vertical
16000.38	27.98	12.40	40.38	54.00	-13.62	AV	Vertical
16000.28	30.98	12.40	43.38	74.00	-30.62	PK	Horizontal
16000.38	28.00	12.40	40.40	54.00	-13.60	AV	Horizontal
17998.36	28.19	23.10	51.29	74.00	-22.71	PK	Vertical
17998.25	25.16	23.10	48.26	54.00	-5.74	AV	Vertical
17998.24	28.15	23.10	51.25	74.00	-22.75	PK	Horizontal
17998.14	25.15	23.10	48.25	54.00	-5.75	AV	Horizontal



High Channel (802.11/ 5240 MHz)

Frequency	Meter Reading	Factor	Emission Level	Limits	Margin	Detector	Comment
(MHz)	(dBμV)	(dB)	(dBμV/m)	(dBμV/m)	(dB)	Type	
3265.32	31.87	-9.80	22.07	74.00	-51.93	PK	Vertical
3265.30	29.87	-9.80	20.07	54.00	-33.93	AV	Vertical
3265.29	31.87	-9.80	22.07	74.00	-51.93	PK	Horizontal
3265.32	29.88	-9.80	20.08	54.00	-33.92	AV	Horizontal
3334.92	31.03	-9.75	21.28	74.00	-52.72	PK	Vertical
3335.10	28.96	-9.75	19.21	54.00	-34.79	AV	Vertical
3334.90	31.00	-9.75	21.25	74.00	-52.75	PK	Horizontal
3335.12	28.96	-9.75	19.21	54.00	-34.79	AV	Horizontal
3349.94	31.02	-9.75	21.27	74.00	-52.73	PK	Vertical
3350.05	28.97	-9.75	19.22	54.00	-34.78	AV	Vertical
3349.95	31.00	-9.75	21.25	74.00	-52.75	PK	Horizontal
3350.01	28.97	-9.75	19.22	54.00	-34.78	AV	Horizontal
4000.28	28.16	-6.60	21.56	74.00	-52.44	PK	Vertical
4000.17	26.16	-6.60	19.56	54.00	-34.44	AV	Vertical
4000.27	28.17	-6.60	21.57	74.00	-52.43	PK	Horizontal
4000.16	26.18	-6.60	19.58	54.00	-34.42	AV	Horizontal
7236.36	37.84	3.40	41.24	74.00	-32.76	PK	Vertical
7236.41	34.84	3.40	38.24	54.00	-15.76	AV	Vertical
7236.40	37.87	3.40	41.27	74.00	-32.73	PK	Horizontal
7236.42	34.86	3.40	38.26	54.00	-15.74	AV	Horizontal
8124.49	36.35	4.80	41.15	74.00	-32.85	PK	Vertical
8124.50	33.31	4.80	38.11	54.00	-15.89	AV	Vertical
8124.48	36.33	4.80	41.13	74.00	-32.87	PK	Horizontal
8124.51	33.32	4.80	38.12	54.00	-15.88	AV	Horizontal
9105.18	35.16	5.00	40.16	74.00	-33.84	PK	Vertical
9105.31	32.12	5.00	37.12	54.00	-16.88	AV	Vertical
9105.20	35.11	5.00	40.11	74.00	-33.89	PK	Horizontal
9105.27	32.13	5.00	37.13	54.00	-16.87	AV	Horizontal
10800.43	40.13	10.20	50.33	74.00	-23.67	PK	Vertical
10800.60	37.10	10.20	47.30	54.00	-6.70	AV	Vertical
10800.44	40.10	10.20	50.30	74.00	-23.70	PK	Horizontal
10800.62	37.11	10.20	47.31	54.00	-6.69	AV	Horizontal
11036.43	34.13	10.20	44.33	74.00	-29.67	PK	Vertical
11036.60	31.11	10.20	41.31	54.00	-12.69	AV	Vertical
11036.44	34.11	10.20	44.31	74.00	-29.69	PK	Horizontal



11036.62	31.07	10.20	41.27	54.00	-12.73	AV	Horizontal
13299.95	32.93	12.20	45.13	74.00	-28.87	PK	Vertical
13299.92	29.95	12.20	42.15	54.00	-11.85	AV	Vertical
13299.94	32.96	12.20	45.16	74.00	-28.84	PK	Horizontal
13299.96	29.94	12.20	42.14	54.00	-11.86	AV	Horizontal
14480.29	31.85	13.40	45.25	74.00	-28.75	PK	Vertical
14480.44	28.89	13.40	42.29	54.00	-11.71	AV	Vertical
14480.28	31.86	13.40	45.26	74.00	-28.74	PK	Horizontal
14480.44	28.90	13.40	42.30	54.00	-11.70	AV	Horizontal
16000.30	31.03	12.40	43.43	74.00	-30.57	PK	Vertical
16000.38	27.96	12.40	40.36	54.00	-13.64	AV	Vertical
16000.28	31.00	12.40	43.40	74.00	-30.60	PK	Horizontal
16000.38	27.95	12.40	40.35	54.00	-13.65	AV	Horizontal
16200.30	31.03	12.40	43.43	74.00	-30.57	PK	Vertical
16200.38	27.94	12.40	40.34	54.00	-13.66	AV	Vertical
16200.28	30.98	12.40	43.38	74.00	-30.62	PK	Horizontal
16200.38	27.98	12.40	40.38	54.00	-13.62	AV	Horizontal
17998.36	28.20	23.10	51.30	74.00	-22.70	PK	Vertical
17998.25	25.13	23.10	48.23	54.00	-5.77	AV	Vertical
17998.24	28.16	23.10	51.26	74.00	-22.74	PK	Horizontal
17998.14	25.18	23.10	48.28	54.00	-5.72	AV	Horizontal

Remark:

1. Factor = Antenna Factor + Cable Loss – Pre-amplifier.
2. Scan with 802.11a,802.11n (HT-20) , 1n (HT-40) the worst case is 802.11a.
3. The frequency emission of peak points that did not show above the forms are at least 20dB below the limit, the frequency emission is mainly from the environment noise.



Band IV(5.725-5.850) GHz

Low Channel (802.11/ 5745 MHz)

Frequency	Meter Reading	Factor	Emission Level	Limits	Margin	Detector	Comment
(MHz)	(dBμV)	(dB)	(dBμV/m)	(dBμV/m)	(dB)	Type	
3265.32	45.19	-9.80	35.39	74.00	-38.61	PK	Vertical
3265.30	43.16	-9.80	33.36	54.00	-20.64	AV	Vertical
3265.29	45.16	-9.80	35.36	74.00	-38.64	PK	Horizontal
3265.32	43.15	-9.80	33.35	54.00	-20.65	AV	Horizontal
3334.92	42.90	-9.75	33.15	74.00	-40.85	PK	Vertical
3335.10	40.91	-9.75	31.16	54.00	-22.84	AV	Vertical
3334.90	42.95	-9.75	33.20	74.00	-40.80	PK	Horizontal
3335.12	40.95	-9.75	31.20	54.00	-22.80	AV	Horizontal
3349.94	42.67	-9.75	32.92	74.00	-41.08	PK	Vertical
3350.05	40.68	-9.75	30.93	54.00	-23.07	AV	Vertical
3349.95	42.72	-9.75	32.97	74.00	-41.03	PK	Horizontal
3350.01	40.69	-9.75	30.94	54.00	-23.06	AV	Horizontal
4000.28	40.05	-6.60	33.45	74.00	-40.55	PK	Vertical
4000.17	38.07	-6.60	31.47	54.00	-22.53	AV	Vertical
4000.27	40.09	-6.60	33.49	74.00	-40.51	PK	Horizontal
4000.16	38.07	-6.60	31.47	54.00	-22.53	AV	Horizontal
7236.36	37.87	3.40	41.27	74.00	-32.73	PK	Vertical
7236.41	35.87	3.40	39.27	54.00	-14.73	AV	Vertical
7236.40	37.84	3.40	41.24	74.00	-32.76	PK	Horizontal
7236.42	35.90	3.40	39.30	54.00	-14.70	AV	Horizontal
8124.49	36.33	4.80	41.13	74.00	-32.87	PK	Vertical
8124.50	34.30	4.80	39.10	54.00	-14.90	AV	Vertical
8124.48	36.31	4.80	41.11	74.00	-32.89	PK	Horizontal
8124.51	34.33	4.80	39.13	54.00	-14.87	AV	Horizontal
9105.18	35.16	5.00	40.16	74.00	-33.84	PK	Vertical
9105.31	33.14	5.00	38.14	54.00	-15.86	AV	Vertical
9105.20	35.16	5.00	40.16	74.00	-33.84	PK	Horizontal
9105.27	33.13	5.00	38.13	54.00	-15.87	AV	Horizontal
11036.43	34.12	10.20	44.32	74.00	-29.68	PK	Vertical
11036.60	32.11	10.20	42.31	54.00	-11.69	AV	Vertical
11036.44	34.08	10.20	44.28	74.00	-29.72	PK	Horizontal
11036.62	32.07	10.20	42.27	54.00	-11.73	AV	Horizontal
11490.43	34.13	10.20	44.33	74.00	-29.67	PK	Vertical
11490.60	32.09	10.20	42.29	54.00	-11.71	AV	Vertical



11490.44	34.11	10.20	44.31	74.00	-29.69	PK	Horizontal
11490.62	32.11	10.20	42.31	54.00	-11.69	AV	Horizontal
13299.95	32.96	12.20	45.16	74.00	-28.84	PK	Vertical
13299.92	30.93	12.20	43.13	54.00	-10.87	AV	Vertical
13299.94	32.95	12.20	45.15	74.00	-28.85	PK	Horizontal
13299.96	30.97	12.20	43.17	54.00	-10.83	AV	Horizontal
14480.29	31.84	13.40	45.24	74.00	-28.76	PK	Vertical
14480.44	29.89	13.40	43.29	54.00	-10.71	AV	Vertical
14480.28	31.84	13.40	45.24	74.00	-28.76	PK	Horizontal
14480.44	29.90	13.40	43.30	54.00	-10.70	AV	Horizontal
16000.30	31.02	12.40	43.42	74.00	-30.58	PK	Vertical
16000.38	28.94	12.40	41.34	54.00	-12.66	AV	Vertical
16000.28	30.98	12.40	43.38	74.00	-30.62	PK	Horizontal
16000.38	28.99	12.40	41.39	54.00	-12.61	AV	Horizontal
17235.36	28.17	23.10	51.27	74.00	-22.73	PK	Vertical
17235.25	26.15	23.10	49.25	54.00	-4.75	AV	Vertical
17235.24	28.15	23.10	51.25	74.00	-22.75	PK	Horizontal
17235.14	26.14	23.10	49.24	54.00	-4.76	AV	Horizontal
17998.36	28.19	23.10	51.29	74.00	-22.71	PK	Vertical
17998.25	26.17	23.10	49.27	54.00	-4.73	AV	Vertical
17998.24	28.18	23.10	51.28	74.00	-22.72	PK	Horizontal
17998.14	26.16	23.10	49.26	54.00	-4.74	AV	Horizontal



Mid Channel (802.11/ 5785 MHz)

Frequency	Meter Reading	Factor	Emission Level	Limits	Margin	Detector	Comment
(MHz)	(dBμV)	(dB)	(dBμV/m)	(dBμV/m)	(dB)	Type	
3265.32	45.17	-9.80	35.37	74.00	-38.63	PK	Vertical
3265.30	43.16	-9.80	33.36	54.00	-20.64	AV	Vertical
3265.29	45.19	-9.80	35.39	74.00	-38.61	PK	Horizontal
3265.32	43.16	-9.80	33.36	54.00	-20.64	AV	Horizontal
3334.92	42.90	-9.75	33.15	74.00	-40.85	PK	Vertical
3335.10	40.93	-9.75	31.18	54.00	-22.82	AV	Vertical
3334.90	42.91	-9.75	33.16	74.00	-40.84	PK	Horizontal
3335.12	40.95	-9.75	31.20	54.00	-22.80	AV	Horizontal
3349.94	42.69	-9.75	32.94	74.00	-41.06	PK	Vertical
3350.05	40.68	-9.75	30.93	54.00	-23.07	AV	Vertical
3349.95	42.75	-9.75	33.00	74.00	-41.00	PK	Horizontal
3350.01	40.71	-9.75	30.96	54.00	-23.04	AV	Horizontal
4000.28	40.05	-6.60	33.45	74.00	-40.55	PK	Vertical
4000.17	38.09	-6.60	31.49	54.00	-22.51	AV	Vertical
4000.27	40.06	-6.60	33.46	74.00	-40.54	PK	Horizontal
4000.16	38.08	-6.60	31.48	54.00	-22.52	AV	Horizontal
7236.36	37.85	3.40	41.25	74.00	-32.75	PK	Vertical
7236.41	35.84	3.40	39.24	54.00	-14.76	AV	Vertical
7236.40	37.88	3.40	41.28	74.00	-32.72	PK	Horizontal
7236.42	35.90	3.40	39.30	54.00	-14.70	AV	Horizontal
8124.49	36.35	4.80	41.15	74.00	-32.85	PK	Vertical
8124.50	34.29	4.80	39.09	54.00	-14.91	AV	Vertical
8124.48	36.33	4.80	41.13	74.00	-32.87	PK	Horizontal
8124.51	34.32	4.80	39.12	54.00	-14.88	AV	Horizontal
9105.18	35.16	5.00	40.16	74.00	-33.84	PK	Vertical
9105.31	33.13	5.00	38.13	54.00	-15.87	AV	Vertical
9105.20	35.15	5.00	40.15	74.00	-33.85	PK	Horizontal
9105.27	33.11	5.00	38.11	54.00	-15.89	AV	Horizontal
11036.43	34.14	10.20	44.34	74.00	-29.66	PK	Vertical
11036.60	32.13	10.20	42.33	54.00	-11.67	AV	Vertical
11036.44	34.13	10.20	44.33	74.00	-29.67	PK	Horizontal
11036.62	32.08	10.20	42.28	54.00	-11.72	AV	Horizontal
11570.43	34.10	10.20	44.30	74.00	-29.70	PK	Vertical
11570.60	32.11	10.20	42.31	54.00	-11.69	AV	Vertical
11570.44	34.10	10.20	44.30	74.00	-29.70	PK	Horizontal



11570.62	32.08	10.20	42.28	54.00	-11.72	AV	Horizontal
13299.95	32.97	12.20	45.17	74.00	-28.83	PK	Vertical
13299.92	30.96	12.20	43.16	54.00	-10.84	AV	Vertical
13299.94	32.97	12.20	45.17	74.00	-28.83	PK	Horizontal
13299.96	30.96	12.20	43.16	54.00	-10.84	AV	Horizontal
14480.29	31.87	13.40	45.27	74.00	-28.73	PK	Vertical
14480.44	29.88	13.40	43.28	54.00	-10.72	AV	Vertical
14480.28	31.86	13.40	45.26	74.00	-28.74	PK	Horizontal
14480.44	29.86	13.40	43.26	54.00	-10.74	AV	Horizontal
16000.30	31.00	12.40	43.40	74.00	-30.60	PK	Vertical
16000.38	28.98	12.40	41.38	54.00	-12.62	AV	Vertical
16000.28	30.99	12.40	43.39	74.00	-30.61	PK	Horizontal
16000.38	28.96	12.40	41.36	54.00	-12.64	AV	Horizontal
17355.36	28.16	23.10	51.26	74.00	-22.74	PK	Vertical
17355.25	26.18	23.10	49.28	54.00	-4.72	AV	Vertical
17355.24	28.17	23.10	51.27	74.00	-22.73	PK	Horizontal
17355.14	26.18	23.10	49.28	54.00	-4.72	AV	Horizontal
17998.36	28.19	23.10	51.29	74.00	-22.71	PK	Vertical
17998.25	26.17	23.10	49.27	54.00	-4.73	AV	Vertical
17998.24	28.16	23.10	51.26	74.00	-22.74	PK	Horizontal
17998.14	26.16	23.10	49.26	54.00	-4.74	AV	Horizontal



High Channel (802.11/ 5825MHz)

Frequency (MHz)	Meter Reading (dB μ V)	Factor (dB)	Emission Level (dB μ V/m)	Limits (dB μ V/m)	Margin (dB)	Detector Type	Comment
3265.32	22.01	-9.80	12.21	74.00	-61.79	PK	Vertical
3265.30	20.01	-9.80	10.21	54.00	-43.79	AV	Vertical
3265.29	21.97	-9.80	12.17	74.00	-61.83	PK	Horizontal
3265.32	20.00	-9.80	10.20	54.00	-43.80	AV	Horizontal
3334.92	21.20	-9.75	11.45	74.00	-62.55	PK	Vertical
3335.10	19.11	-9.75	9.36	54.00	-44.64	AV	Vertical
3334.90	21.17	-9.75	11.42	74.00	-62.58	PK	Horizontal
3335.12	19.15	-9.75	9.40	54.00	-44.60	AV	Horizontal
3349.94	21.18	-9.75	11.43	74.00	-62.57	PK	Vertical
3350.05	19.14	-9.75	9.39	54.00	-44.61	AV	Vertical
3349.95	21.16	-9.75	11.41	74.00	-62.59	PK	Horizontal
3350.01	19.14	-9.75	9.39	54.00	-44.61	AV	Horizontal
4000.28	21.46	-6.60	14.86	74.00	-59.14	PK	Vertical
4000.17	19.51	-6.60	12.91	54.00	-41.09	AV	Vertical
4000.27	21.49	-6.60	14.89	74.00	-59.11	PK	Horizontal
4000.16	19.51	-6.60	12.91	54.00	-41.09	AV	Horizontal
7236.36	41.18	3.40	44.58	74.00	-29.42	PK	Vertical
7236.41	38.19	3.40	41.59	54.00	-12.41	AV	Vertical
7236.40	41.19	3.40	44.59	74.00	-29.41	PK	Horizontal
7236.42	38.20	3.40	41.60	54.00	-12.40	AV	Horizontal
8124.49	41.08	4.80	45.88	74.00	-28.12	PK	Vertical
8124.50	38.04	4.80	42.84	54.00	-11.16	AV	Vertical
8124.48	41.05	4.80	45.85	74.00	-28.15	PK	Horizontal
8124.51	38.03	4.80	42.83	54.00	-11.17	AV	Horizontal
9105.18	40.11	5.00	45.11	74.00	-28.89	PK	Vertical
9105.31	37.06	5.00	42.06	54.00	-11.94	AV	Vertical
9105.20	40.03	5.00	45.03	74.00	-28.97	PK	Horizontal
9105.27	37.06	5.00	42.06	54.00	-11.94	AV	Horizontal
11036.43	50.24	10.20	60.44	74.00	-13.56	PK	Vertical
11036.60	47.22	10.20	57.42	54.00	3.42	AV	Vertical
11036.44	50.22	10.20	60.42	74.00	-13.58	PK	Horizontal
11036.62	47.21	10.20	57.41	54.00	3.41	AV	Horizontal
11650.43	44.25	10.20	54.45	74.00	-19.55	PK	Vertical
11650.60	41.24	10.20	51.44	54.00	-2.56	AV	Vertical



11650.44	44.25	10.20	54.45	74.00	-19.55	PK	Horizontal
11650.62	41.22	10.20	51.42	54.00	-2.58	AV	Horizontal
13299.95	45.03	12.20	57.23	74.00	-16.77	PK	Vertical
13299.92	42.06	12.20	54.26	54.00	0.26	AV	Vertical
13299.94	45.08	12.20	57.28	74.00	-16.72	PK	Horizontal
13299.96	42.09	12.20	54.29	54.00	0.29	AV	Horizontal
14480.29	45.19	13.40	58.59	74.00	-15.41	PK	Vertical
14480.44	42.19	13.40	55.59	54.00	1.59	AV	Vertical
14480.28	45.20	13.40	58.60	74.00	-15.40	PK	Horizontal
14480.44	42.24	13.40	55.64	54.00	1.64	AV	Horizontal
16000.30	43.33	12.40	55.73	74.00	-18.27	PK	Vertical
16000.38	40.30	12.40	52.70	54.00	-1.30	AV	Vertical
16000.28	43.32	12.40	55.72	74.00	-18.28	PK	Horizontal
16000.38	40.28	12.40	52.68	54.00	-1.32	AV	Horizontal
17475.36	43.34	23.10	66.44	74.00	-7.56	PK	Vertical
17475.25	40.24	23.10	63.34	54.00	9.34	AV	Vertical
17475.24	43.31	23.10	66.41	74.00	-7.59	PK	Horizontal
17475.14	40.32	23.10	63.42	54.00	9.42	AV	Horizontal
17998.36	51.24	23.10	74.34	74.00	0.34	PK	Vertical
17998.25	48.14	23.10	71.24	54.00	17.24	AV	Vertical
17998.24	51.18	23.10	74.28	74.00	0.28	PK	Horizontal
17998.14	48.20	23.10	71.30	54.00	17.30	AV	Horizontal

Remark:

1. Factor = Antenna Factor + Cable Loss – Pre-amplifier.
2. Scan with 802.11a,802.11n (HT-20) , the worst case is 802.11a.
3. The frequency emission of peak points that did not show above the forms are at least 20dB below the limit, the frequency emission is mainly from the environment noise.



3.2.9 (Band Edge) (worst mode)

Band I(5.15-5.25) GHz

Frequency (MHz)	Reading (dBuV)	Factor (dB)	Emission Level (dBμV/m)	Limit (dBuV/m)	Margin (dB)	Detect or	Comment
802.11a BW20MHz							
5150	41.90	-3.62	38.28	74	-35.72	PK	Vertical
5150	31.86	-3.62	28.24	54	-25.76	AV	Vertical
5150	42.26	-3.62	38.64	74	-35.36	PK	Horizontal
5150	31.79	-3.62	28.17	54	-25.83	AV	Horizontal
5350	42.32	-3.25	39.07	74	-34.93	PK	Vertical
5350	32.00	-3.25	28.75	54	-25.25	AV	Vertical
5350	42.02	-3.25	38.77	74	-35.23	PK	Horizontal
5350	32.06	-3.25	28.81	54	-25.19	AV	Horizontal
802.11n BW20MHz							
5150	42.29	-3.62	38.67	74	-35.33	PK	Vertical
5150	32.22	-3.62	28.60	54	-25.40	AV	Vertical
5150	42.08	-3.62	38.46	74	-35.54	PK	Horizontal
5150	32.03	-3.62	28.41	54	-25.59	AV	Horizontal
5350	42.05	-3.25	38.80	74	-35.20	PK	Vertical
5350	31.86	-3.25	28.61	54	-25.39	AV	Vertical
5350	42.16	-3.25	38.91	74	-35.09	PK	Horizontal
5350	31.93	-3.25	28.68	54	-25.32	AV	Horizontal
802.11n BW40MHz							
5150	42.23	-3.62	38.61	74	-35.39	PK	Vertical
5150	32.13	-3.62	28.51	54	-25.49	AV	Vertical
5150	41.98	-3.62	38.36	74	-35.64	PK	Horizontal
5150	31.95	-3.62	28.33	54	-25.67	AV	Horizontal
5350	41.98	-3.25	38.73	74	-35.27	PK	Vertical
5350	31.79	-3.25	28.54	54	-25.46	AV	Vertical
5350	42.11	-3.25	38.86	74	-35.14	PK	Horizontal
5350	31.84	-3.25	28.59	54	-25.41	AV	Horizontal

**Band IV(5.725-5.85 GHz)**

Frequency (MHz)	Reading (dBuV)	Factor (dB)	Emission Level (dBμV/m)	Limit (dBuV/m)	Margin (dB)	Detector	Comment
802.11a BW20MHz							
5725	41.94	-3.62	38.32	74	-35.68	PK	Vertical
5725	31.84	-3.62	28.22	54	-25.78	AV	Vertical
5725	42.03	-3.62	38.41	74	-35.59	PK	Horizontal
5725	32.08	-3.62	28.46	54	-25.54	AV	Horizontal
5850	42.15	-3.25	38.90	74	-35.10	PK	Vertical
5850	32.08	-3.25	28.83	54	-25.17	AV	Vertical
5850	41.97	-3.25	38.72	74	-35.28	PK	Horizontal
5850	31.81	-3.25	28.56	54	-25.44	AV	Horizontal
802.11n BW20MHz							
5725	41.85	-3.62	38.23	74	-35.77	PK	Vertical
5725	32.25	-3.62	28.63	54	-25.37	AV	Vertical
5725	42.09	-3.62	38.47	74	-35.53	PK	Horizontal
5725	32.15	-3.62	28.53	54	-25.47	AV	Horizontal
5850	42.19	-3.25	38.94	74	-35.06	PK	Vertical
5850	31.82	-3.25	28.57	54	-25.43	AV	Vertical
5850	41.97	-3.25	38.72	74	-35.28	PK	Horizontal
5850	32.00	-3.25	28.75	54	-25.25	AV	Horizontal
802.11n BW40MHz							
5725	41.85	-3.62	38.23	74	-35.77	PK	Vertical
5725	32.25	-3.62	28.63	54	-25.37	AV	Vertical
5725	42.10	-3.62	38.48	74	-35.52	PK	Horizontal
5725	32.16	-3.62	28.54	54	-25.46	AV	Horizontal
5850	42.20	-3.25	38.95	74	-35.05	PK	Vertical
5850	31.82	-3.25	28.57	54	-25.43	AV	Vertical
5850	41.96	-3.25	38.71	74	-35.29	PK	Horizontal
5850	31.98	-3.25	28.73	54	-25.27	AV	Horizontal

4. CONDUCTED SPURIOUS EMISSIONS

4.1 APPLIED PROCEDURES / LIMIT

Undesirable emission limits. Except as shown in paragraph (b)(7) of this section, the maximum emissions outside of the frequency bands of operation shall be attenuated in accordance with the following limits:

(1) For transmitters operating in the 5.15-5.25 GHz band: All emissions outside of the 5.15-5.35 GHz band shall not exceed an e.i.r.p. of -27 dBm/MHz.

(2) For transmitters operating in the 5.725-5.85 GHz band: All emissions within the frequency range from the band edge to 10 MHz above or below the band edge shall not exceed an e.i.r.p. of -17 dBm/MHz; for frequencies 10 MHz or greater above or below the band edge, emissions shall not exceed an e.i.r.p. of -27 dBm/MHz.

4.1.1 TEST PROCEDURE

Spectrum Parameter	Setting
Detector	Peak
Start/Stop Frequency	30 MHz to 10th carrier harmonic
RB / VB (emission in restricted band)	1000 KHz/3000 KHz
Trace-Mode:	Max hold

For Band edge

Spectrum Parameter	Setting
Detector	Peak
Start/Stop Frequency	Lower Band Edge: 5700 to 5725 MHz Upper Band Edge: 5850 to 5870 MHz
RB / VB (emission in restricted band)	1000 KHz/3000 KHz
Trace-Mode:	Max hold

4.1.2 DEVIATION FROM STANDARD

No deviation.

4.1.3 TEST SETUP

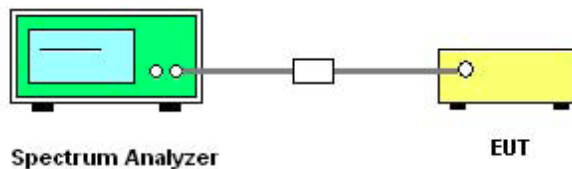

The EUT which is powered by the Battery, is coupled to the Spectrum Analyzer; the RF load attached to the EUT antenna terminal is 50Ohm; the path loss as the factor is calibrated to correct the reading.

Make the measurement with the spectrum analyzer's resolution bandwidth (RBW) = 1000 kHz. In order to make an accurate measurement, set the span greater than RBW.

4.1.4 EUT OPERATION CONDITIONS

The EUT tested system was configured as the statements of 2.3 Unless otherwise a special operating condition is specified in the follows during the testing.



4.1.5 TEST RESULTS

Not:

1. Above 26.5GHz amplitude of spurious emissions which are attenuated by more than 20dB below the permissible value has.
2. Transmissions Level (dBm)=(Antenna A) Port. Antenna A Signal strength strongest.
3. Antenna A and Antenna B have a test, only provides the worst antenna of A plot.

Band I (5.15-5.25GHz)(Antenna A)

TX Spurious Emissions /802.11a Mode CH 36 (30M-1G)

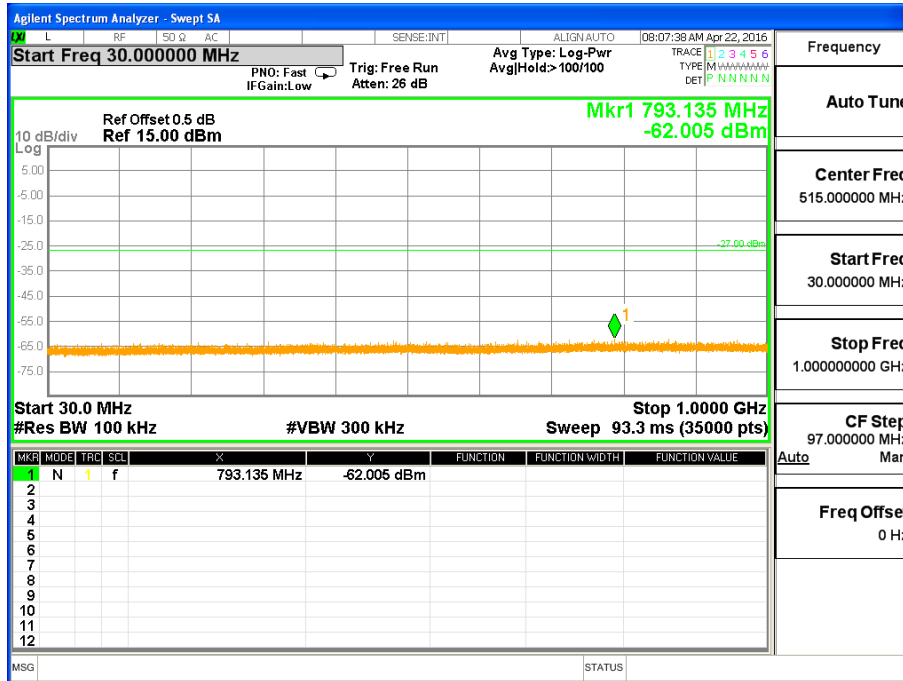

TX Spurious Emissions /802.11a Mode CH 36 (1G-26.5G)

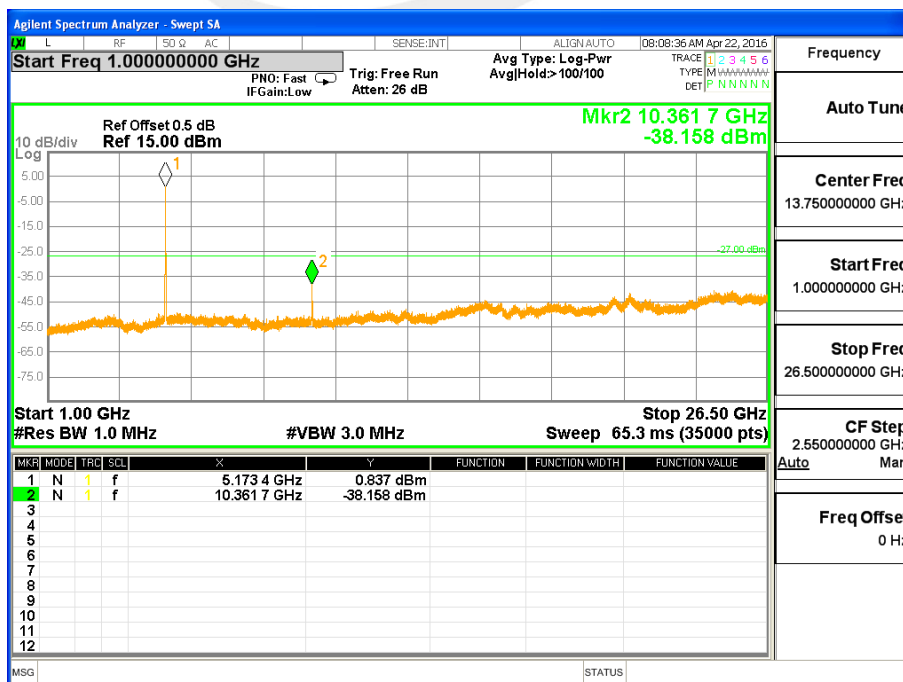



TX Spurious Emissions /802.11a Mode CH 40(30M-1G)

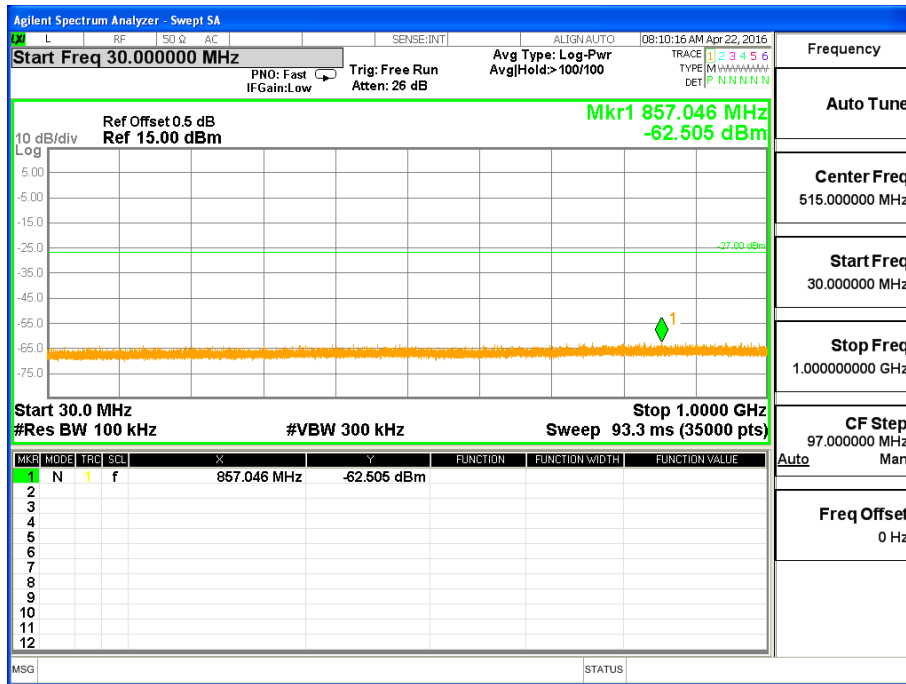

TX Spurious Emissions /802.11a Mode CH 40(1G-26.5G)

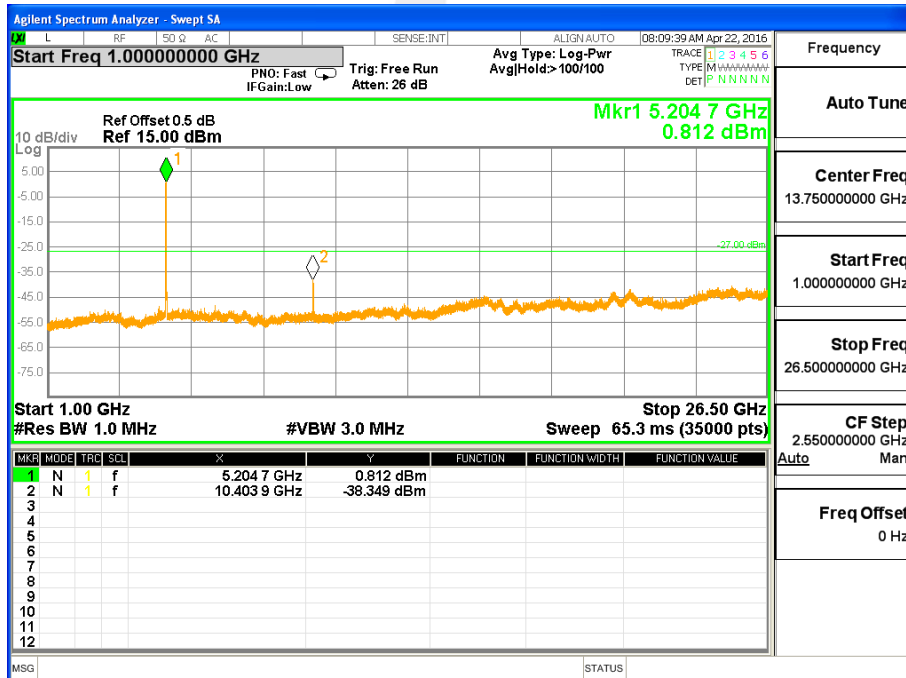



TX Spurious Emissions /802.11a Mode CH 48(30M-1G)

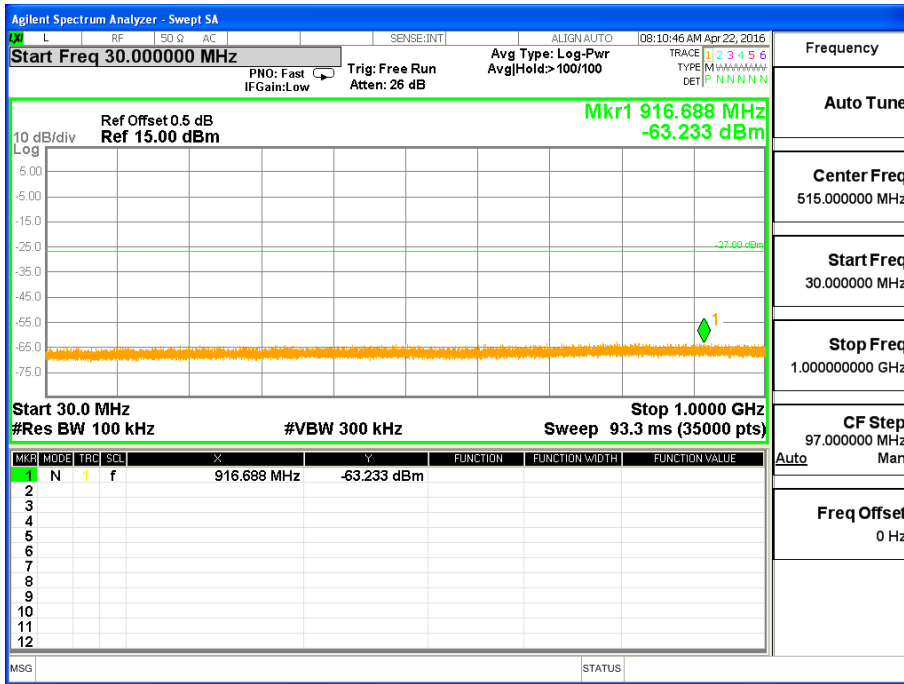

TX Spurious Emissions /802.11a Mode CH 48(1G-26.5G)

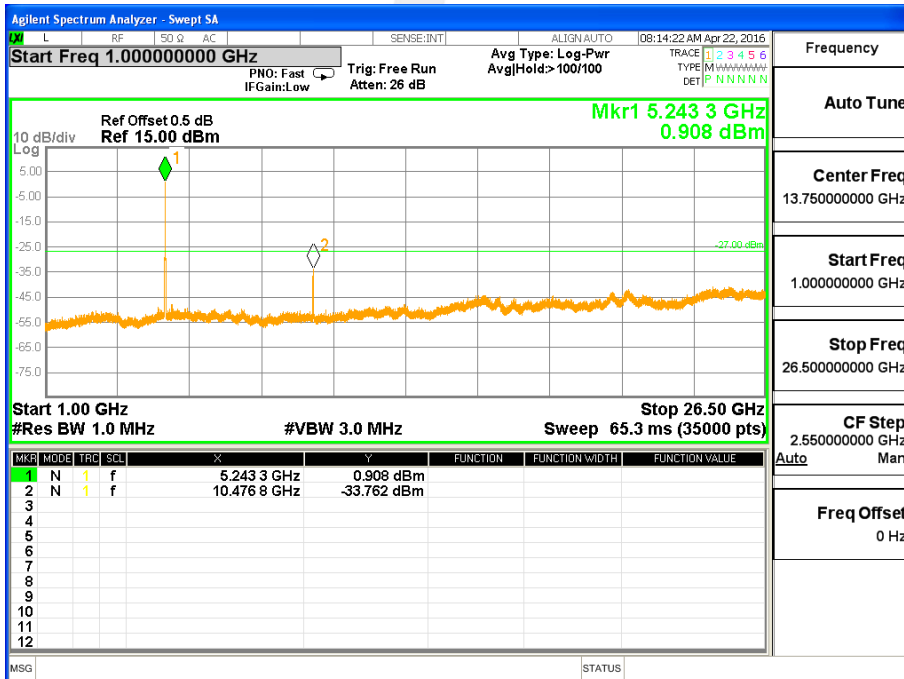



Band edge

TX Band edge /802.11a Mode CH 36

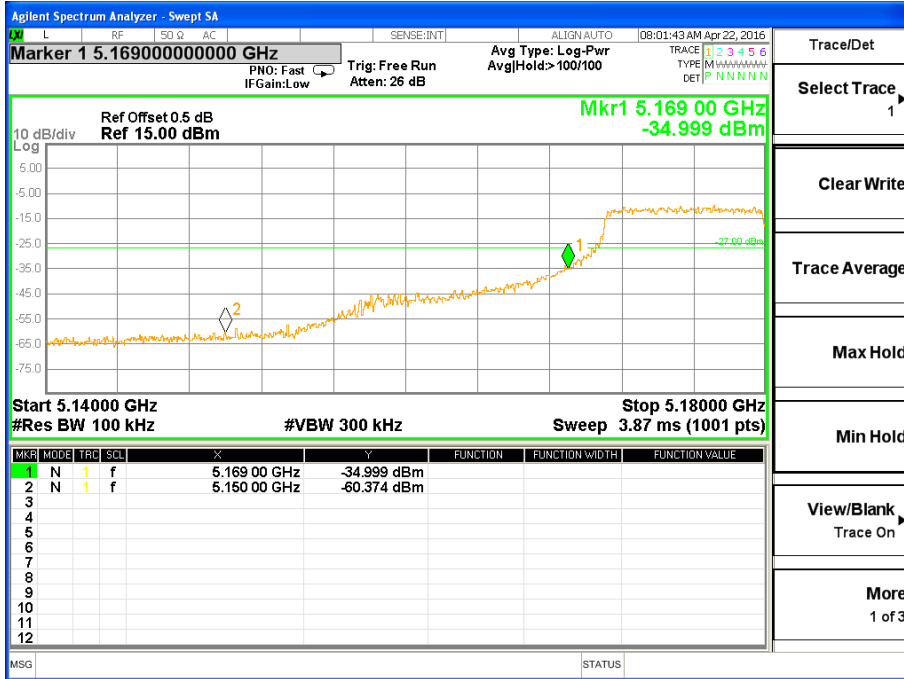

TX Band edge /802.11a Mode CH 48

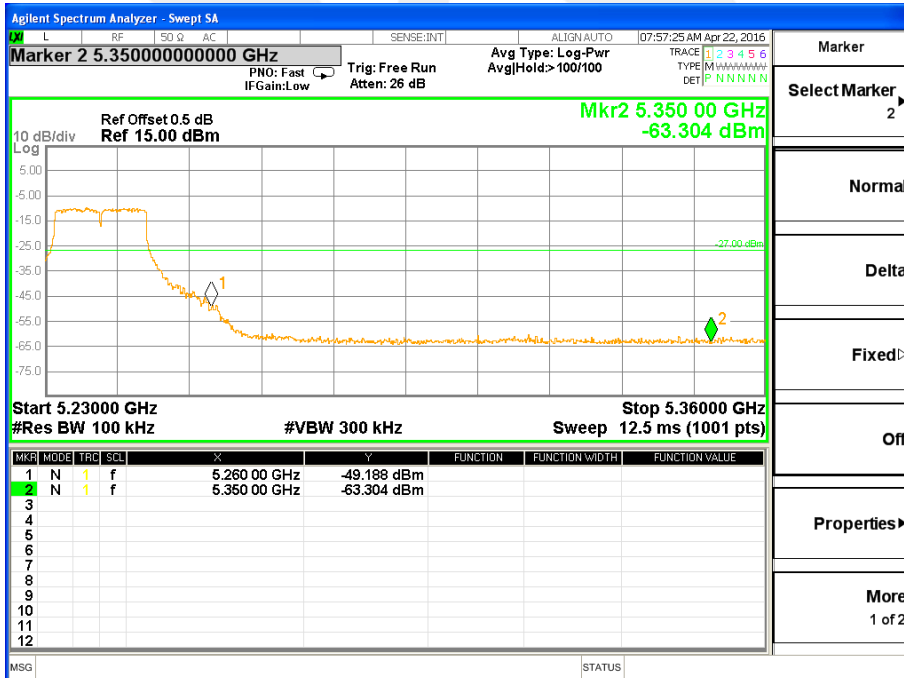



Band I (5.15-5.25GHz) (Antenna A)

TX Spurious Emissions /802.11n(HT20) Mode CH 36 (30M-1G)

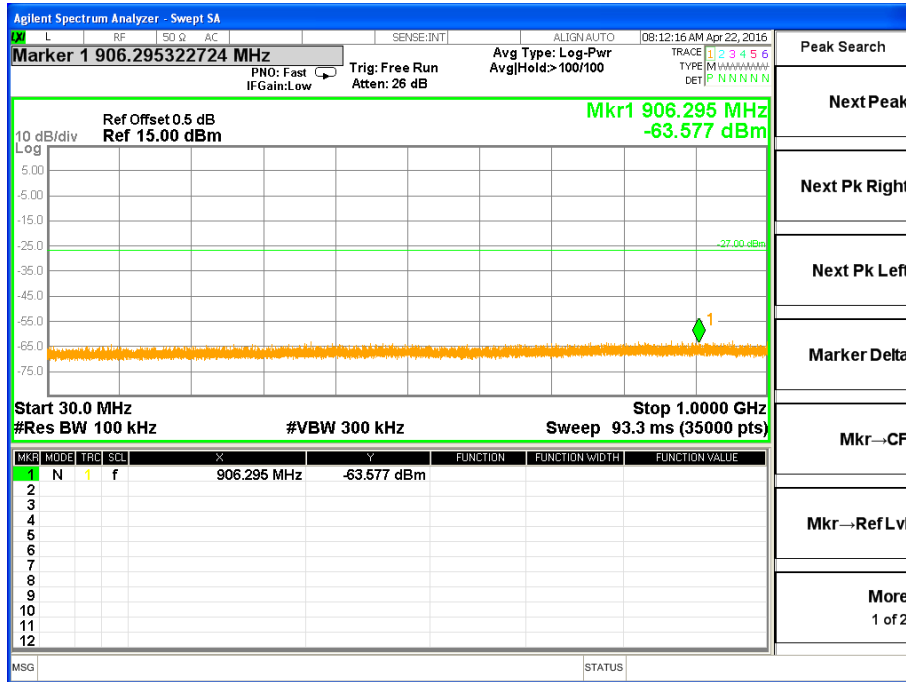

TX Spurious Emissions /802.11n(HT20) Mode CH 36 (1G-26.5G)

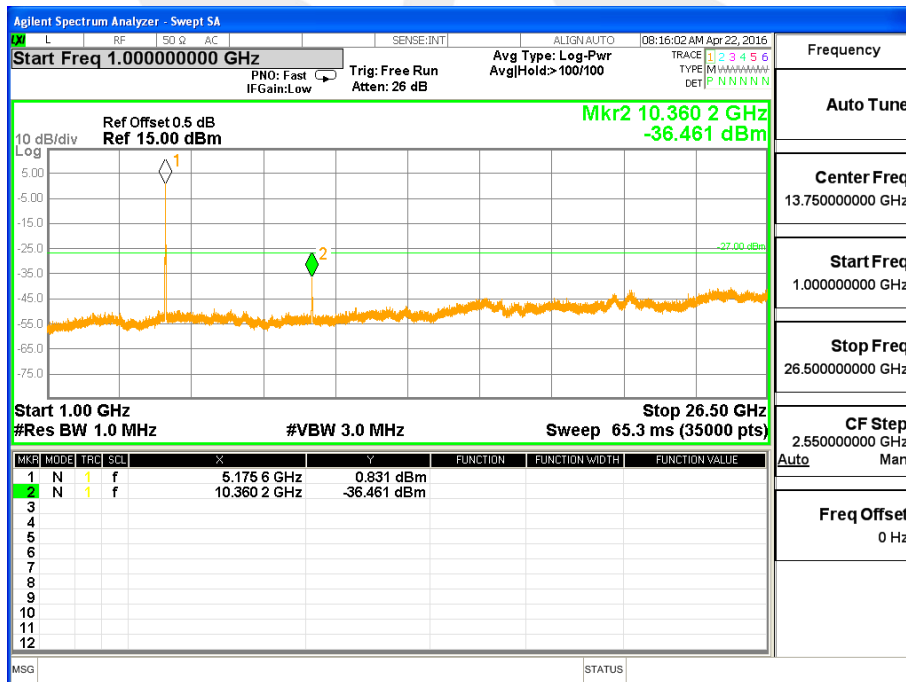



TX Spurious Emissions /802.11n(HT20) Mode CH 40 (30M-1G)

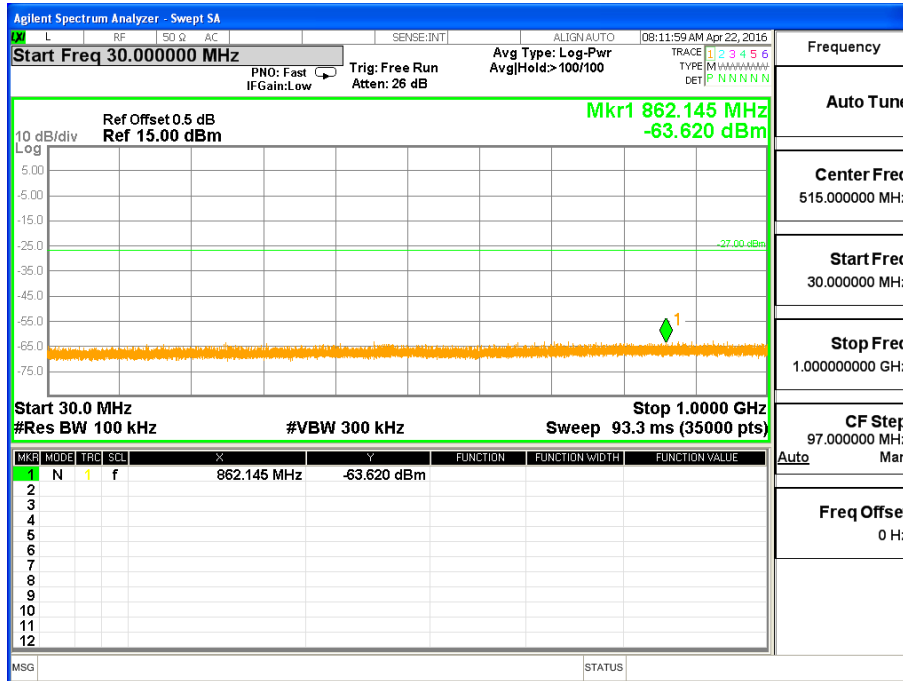

TX Spurious Emissions /802.11n(HT20) Mode CH 40 (1G-26.5G)

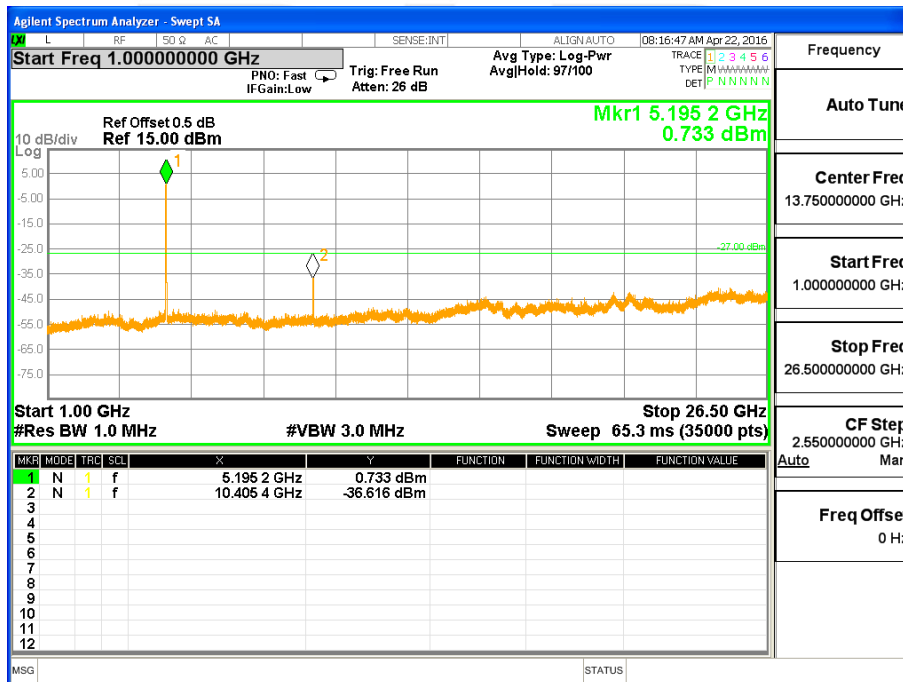



TX Spurious Emissions /802.11n(HT20) Mode CH 48(30M-1G)

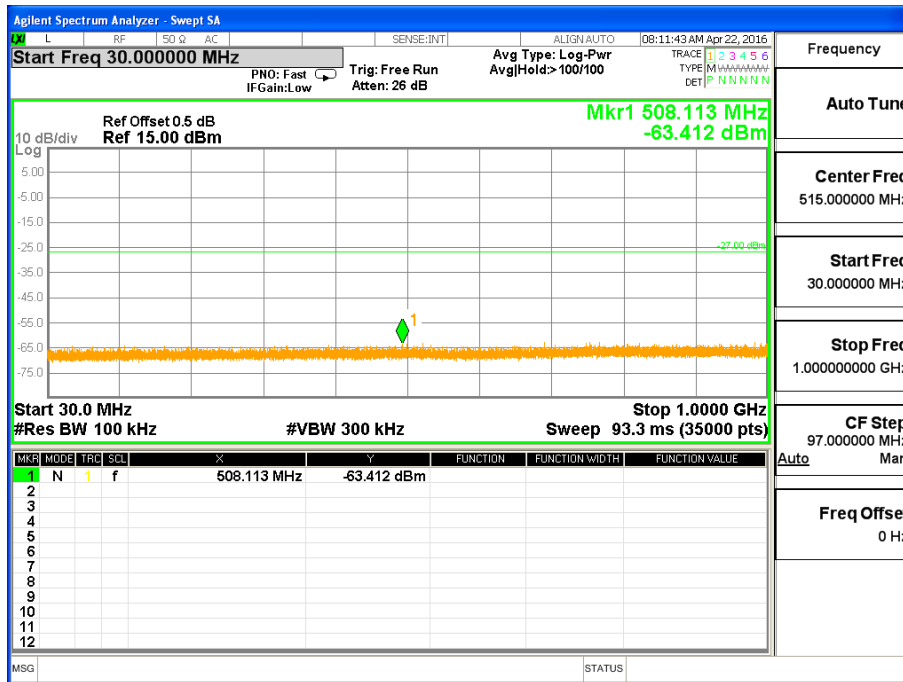

TX Spurious Emissions /802.11n(HT20) Mode CH 48(1G-26.5G)

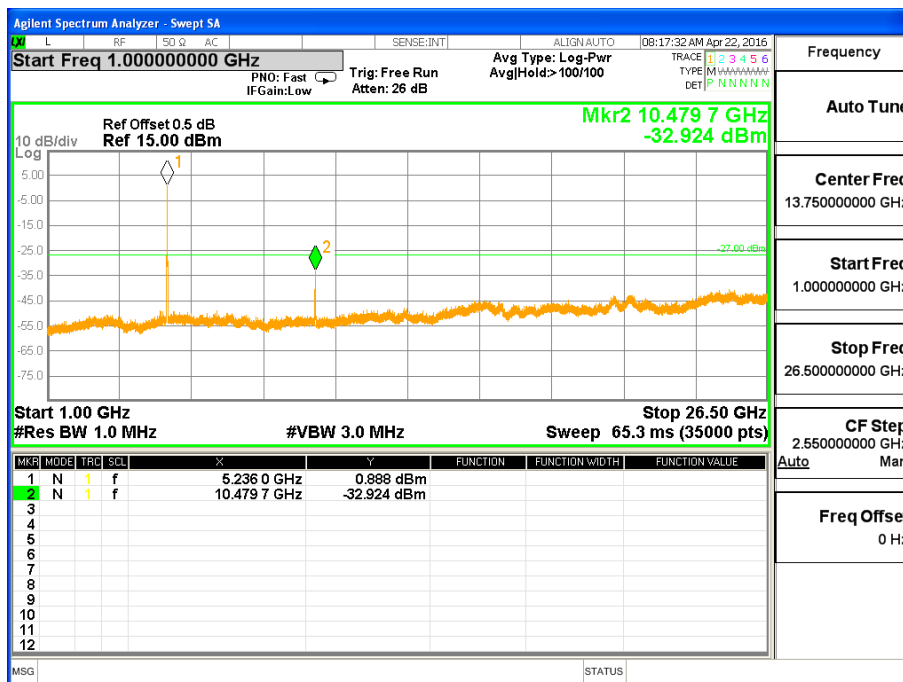



Band edge

TX Band edge /802.11n(HT20) Mode CH 36

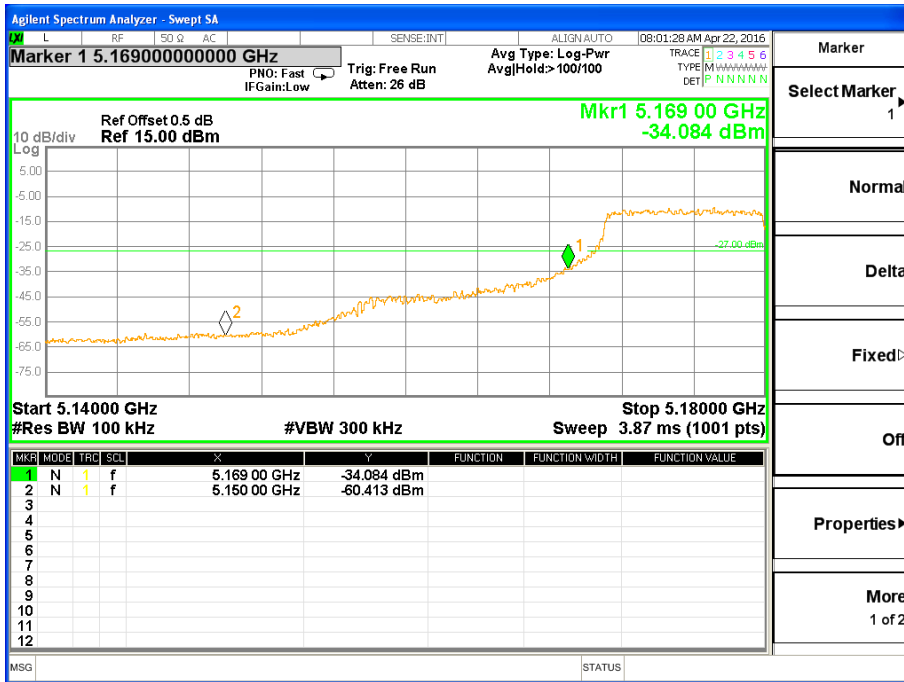

TX Band edge /802.11n(HT20) Mode CH 48

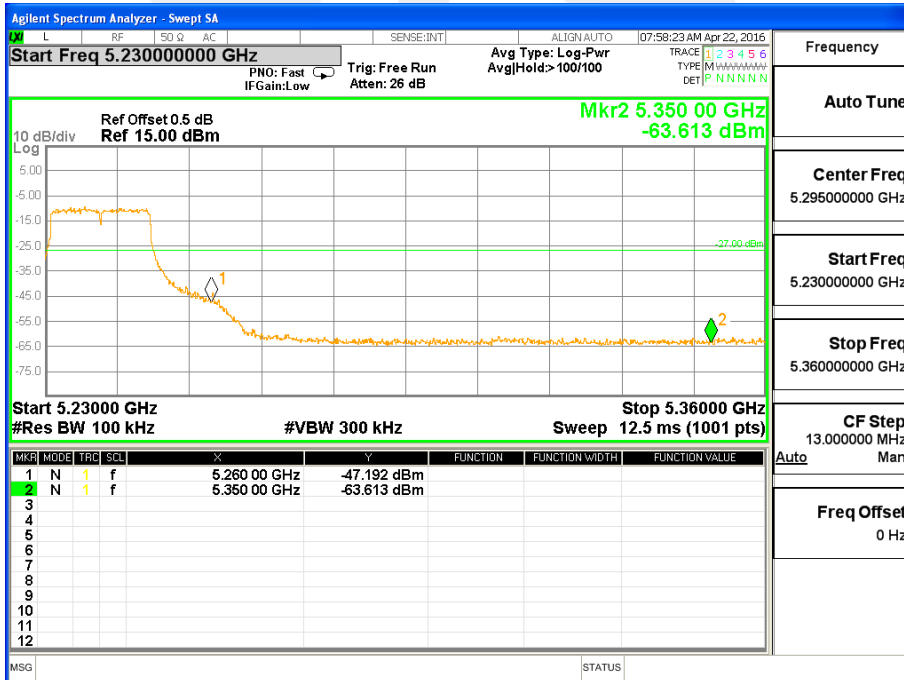



Band I (5.15-5.25GHz) (Antenna A)

TX Spurious Emissions /802.11n(HT40) Mode CH 38 (30M-1G)

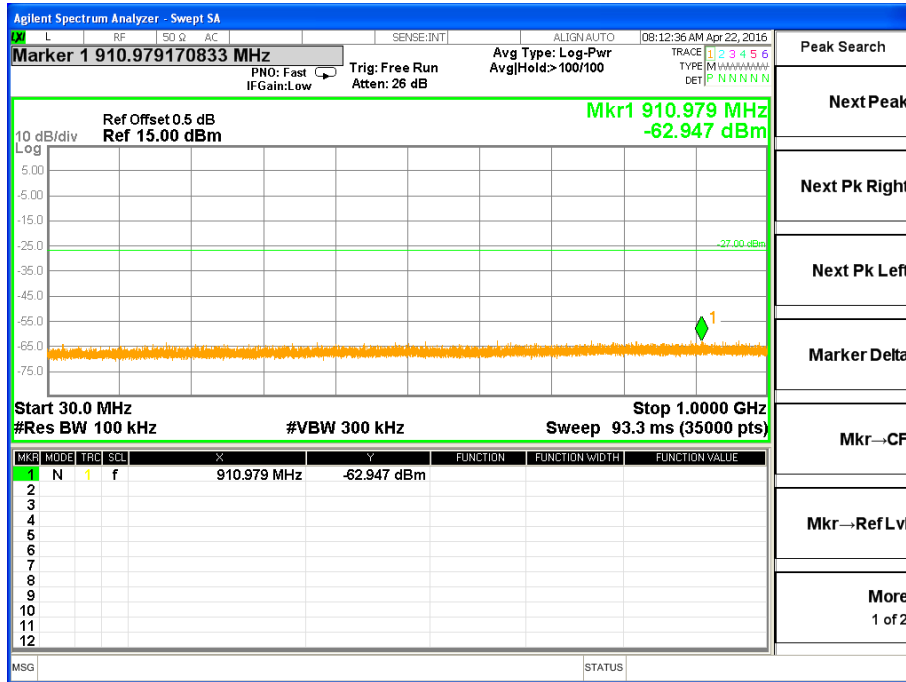

TX Spurious Emissions /802.11n(HT40) Mode CH 38 (1G-26.5G)

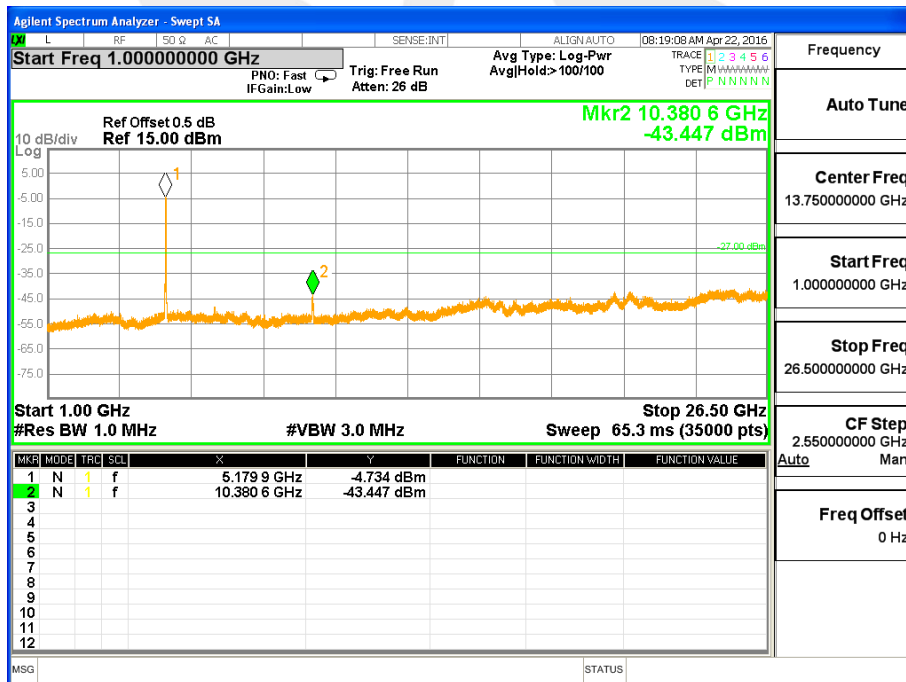



TX Spurious Emissions /802.11n(HT40) Mode CH 46 (30M-1G)

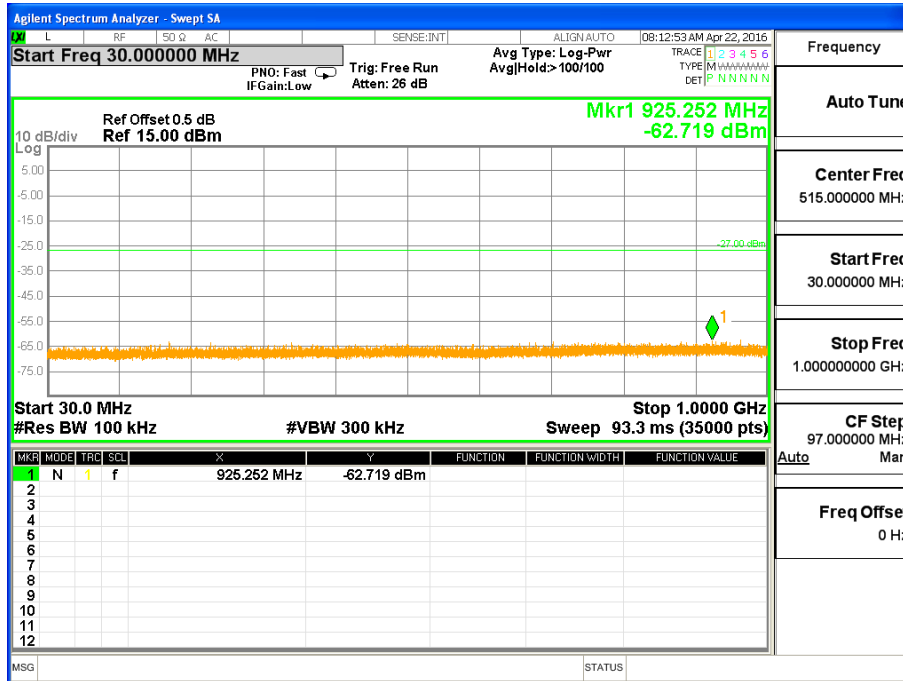

TX Spurious Emissions /802.11n(HT40) Mode CH 46 (1G-26.5G)

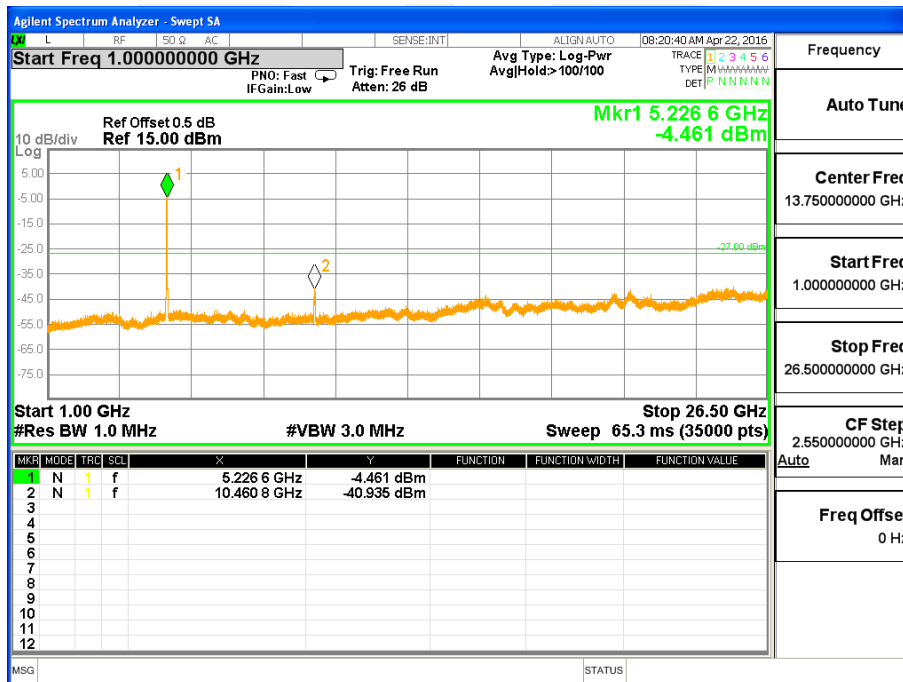



Band edge

TX Band edge /802.11n(HT40) Mode CH 38

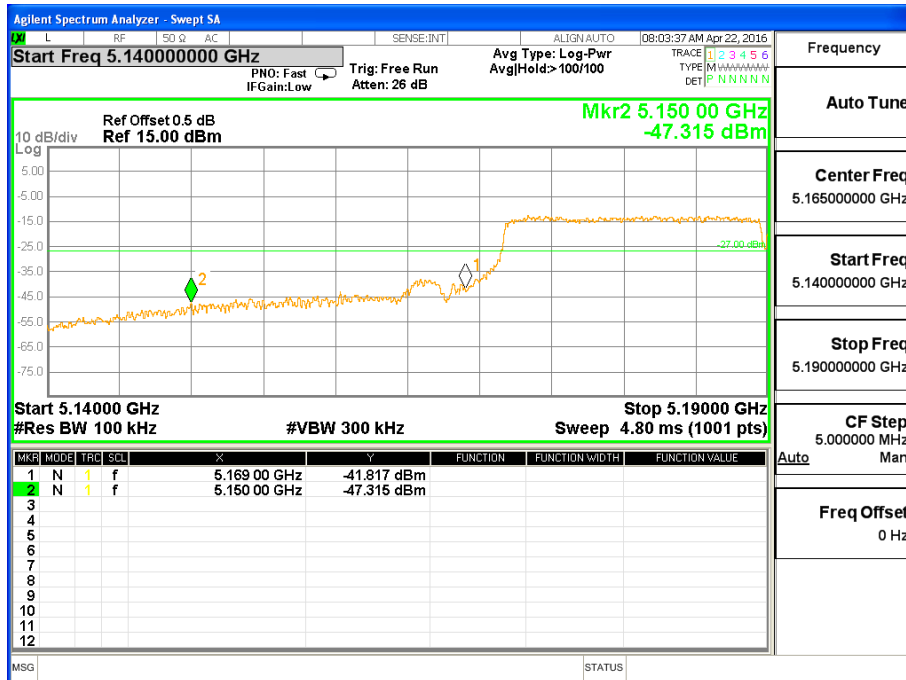

TX Band edge /802.11n(HT40) Mode CH 46

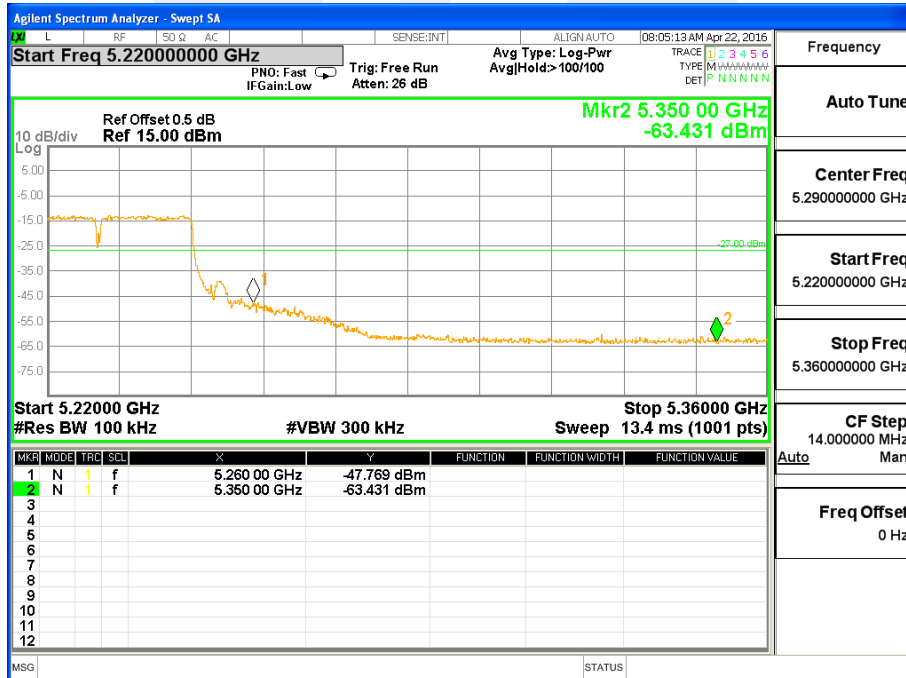



Band IV (5.725-5.85GHz) (Antenna A)

TX Spurious Emissions /802.11a Mode CH 149 (30M-1G)

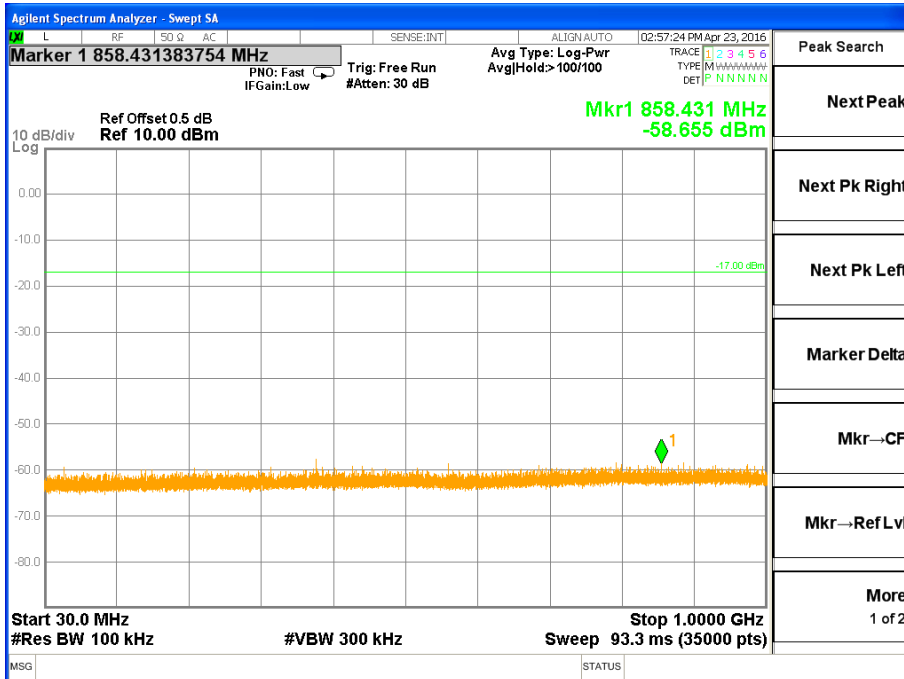

TX Spurious Emissions /802.11a Mode CH 3149 (1G-26.5G)

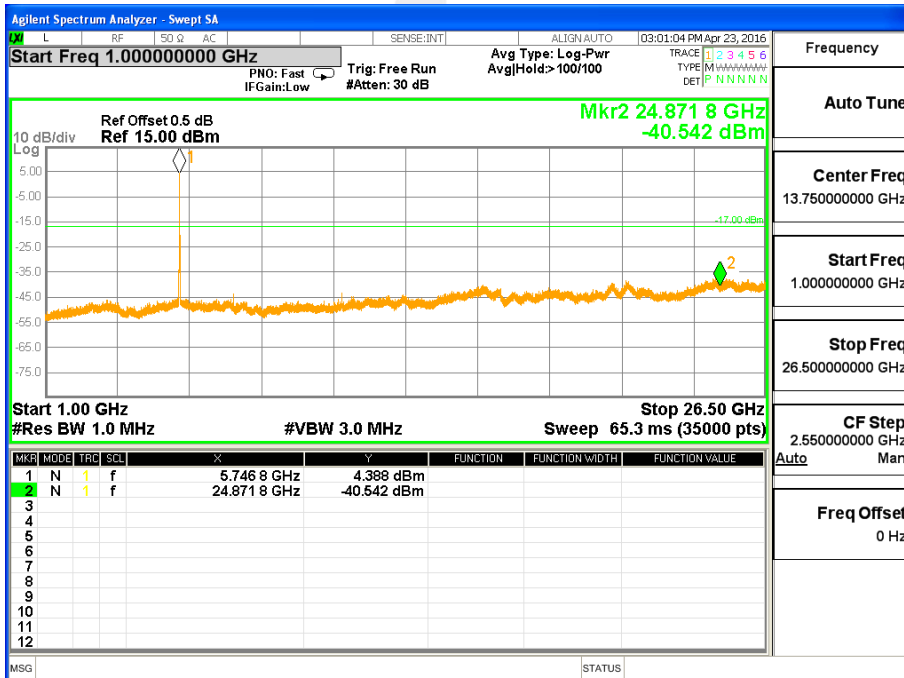



TX Spurious Emissions /802.11a Mode CH 157(30M-1G)

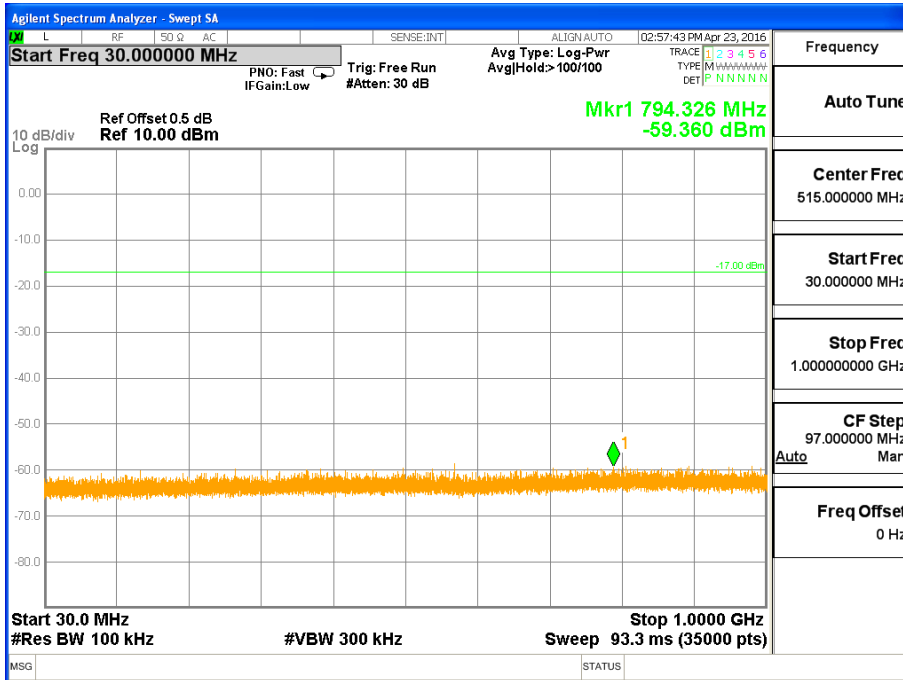

TX Spurious Emissions /802.11a Mode CH 157(1G-26.5G)

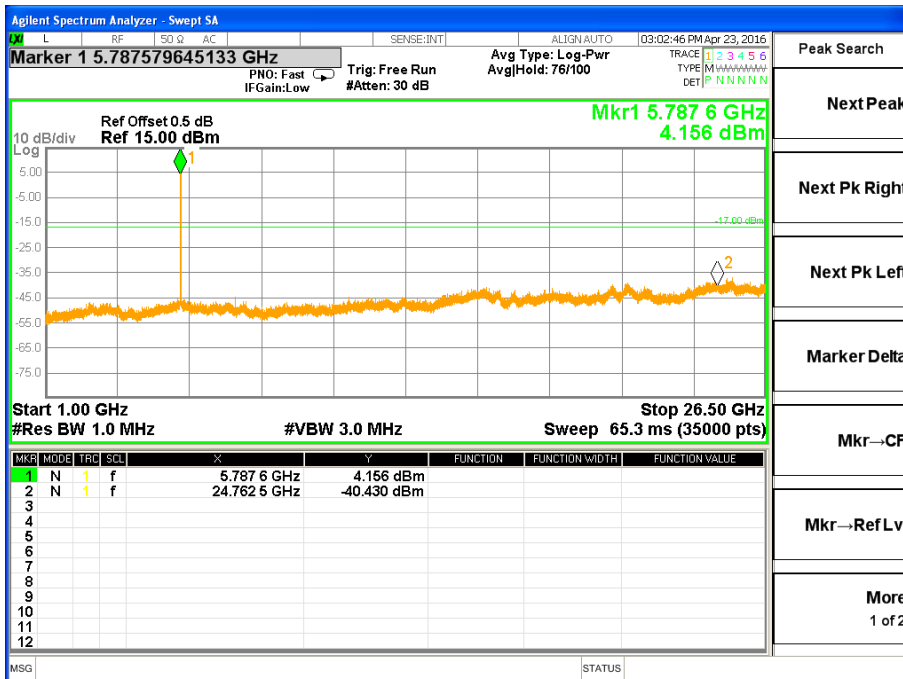



TX Spurious Emissions /802.11a Mode CH 165 (30M-1G)

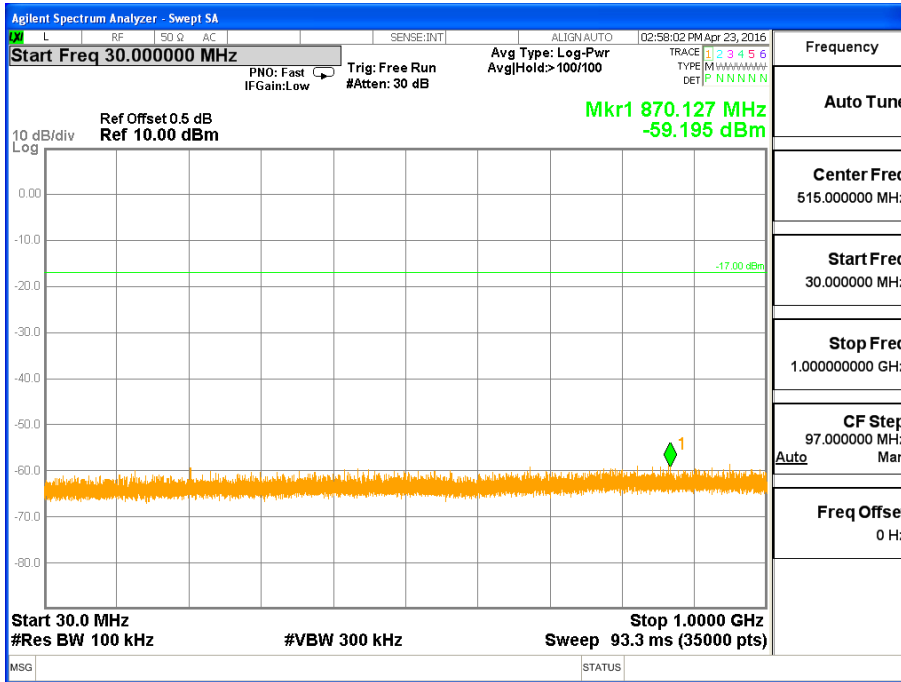

TX Spurious Emissions /802.11a Mode CH 165(1G-26.5G)

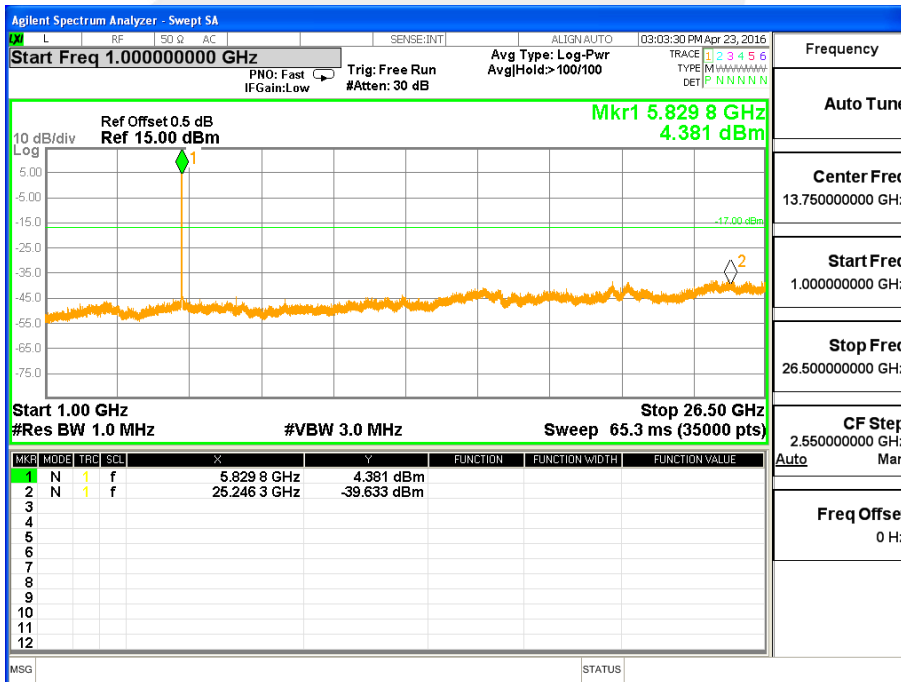



Band edge

TX Band edge /802.11a Mode CH 149

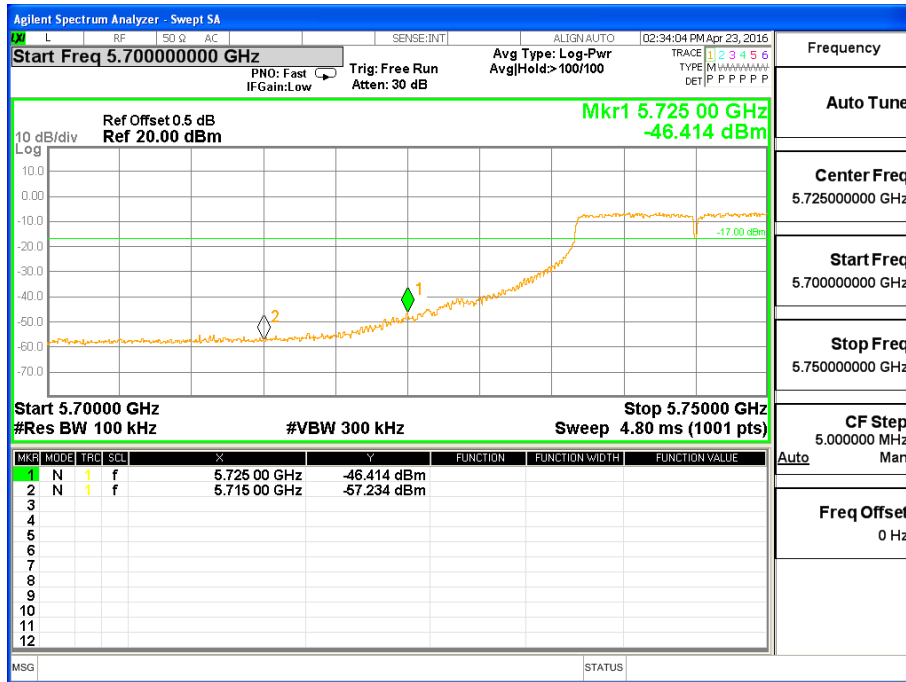

TX Band edge /802.11a Mode CH 165

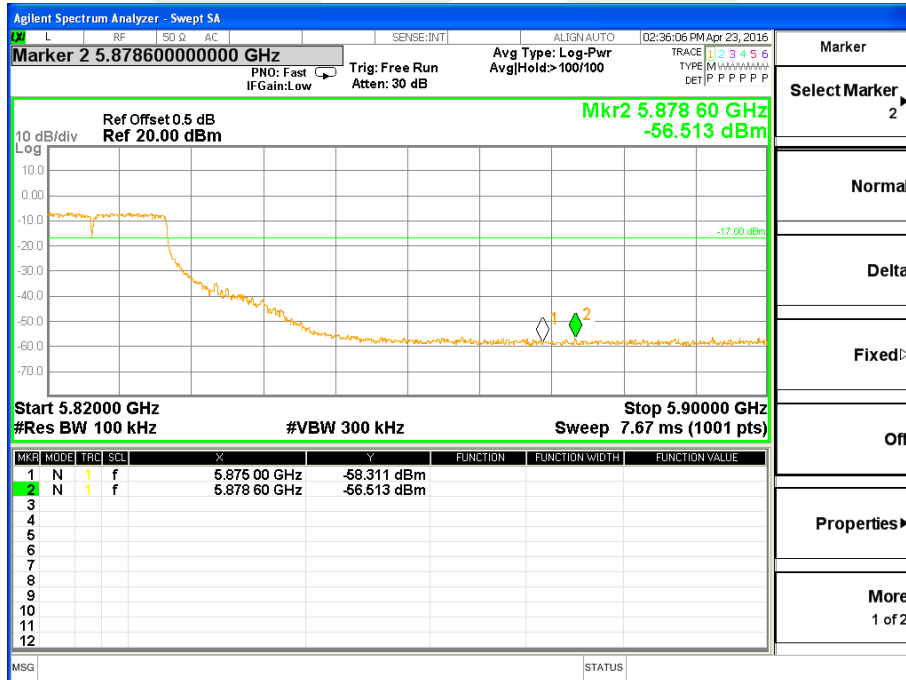



Band IV (5.725-5.85GHz) (Antenna A)

TX Spurious Emissions /802.11n(HT20) Mode CH 149 (30M-1G)

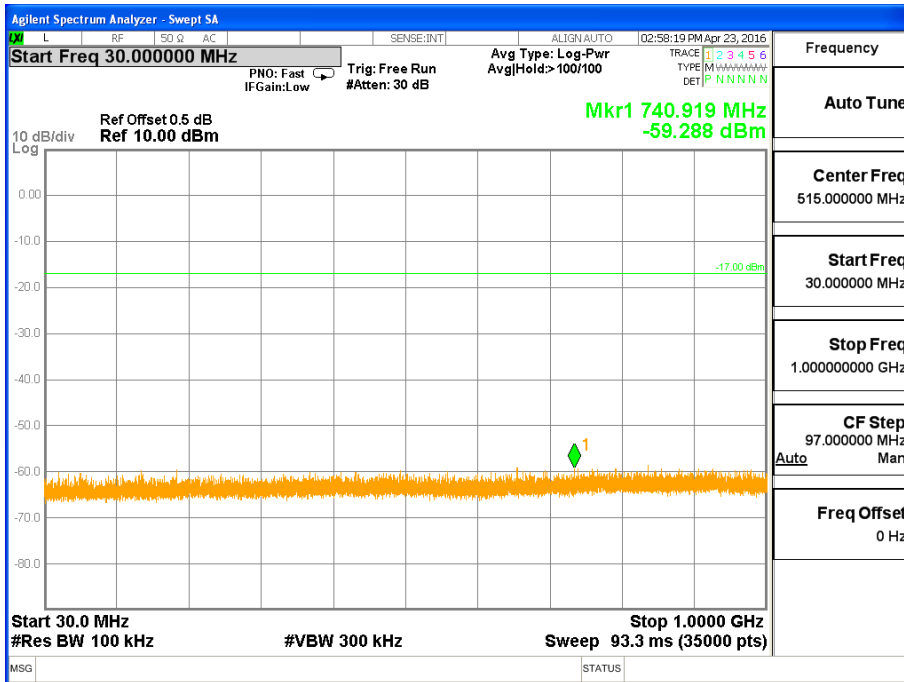

TX Spurious Emissions /802.11n(HT20) Mode CH 149 (1G-26.5G)

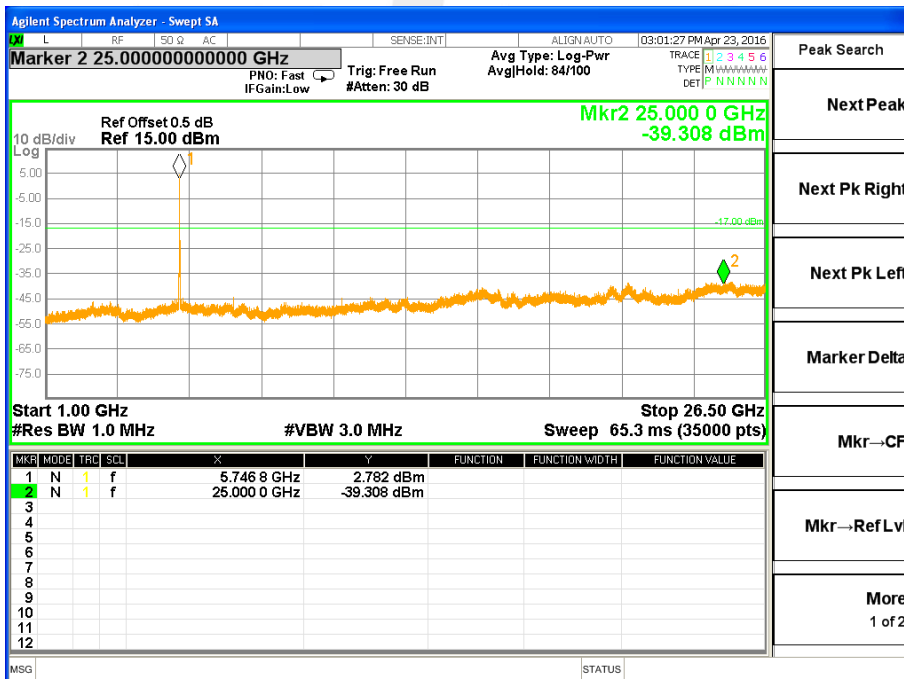



TX Spurious Emissions /802.11n(HT20) Mode CH 157 (30M-1G)

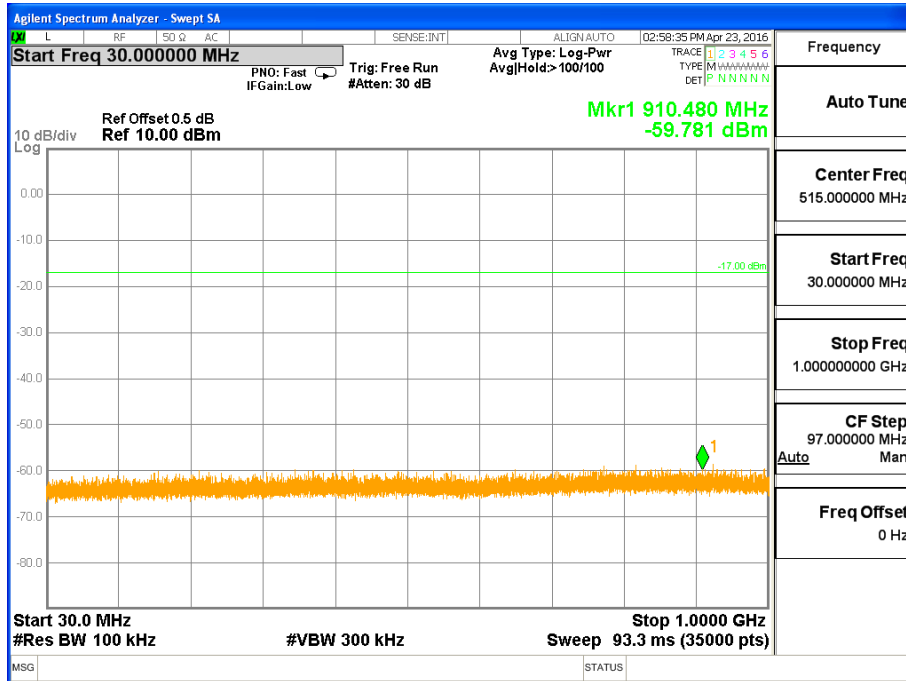

TX Spurious Emissions /802.11n(HT20) Mode CH 157 (1G-26.5G)

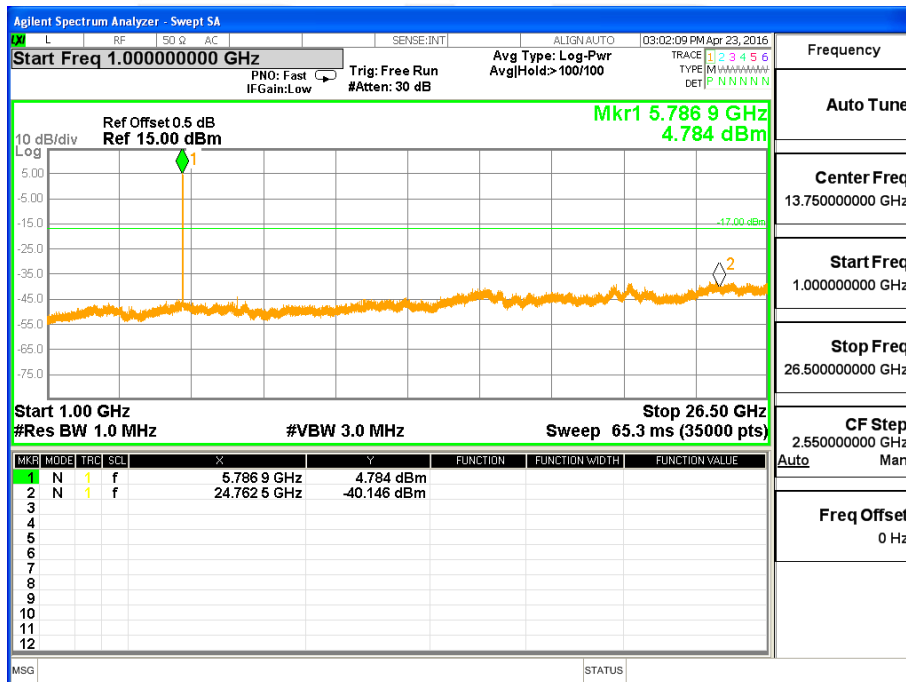



TX Spurious Emissions /802.11n(HT20) Mode CH 165(30M-1G)

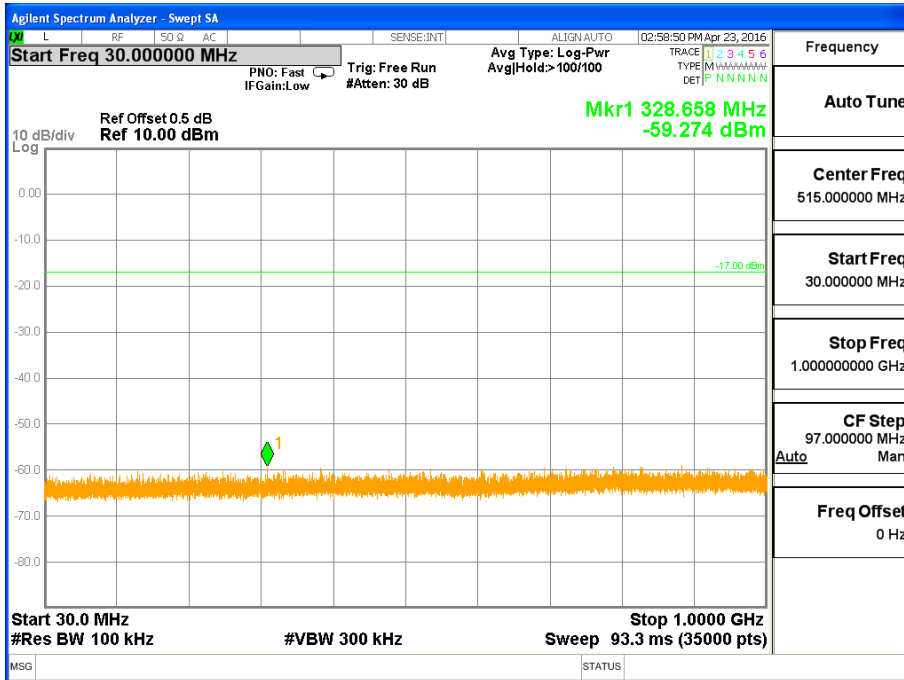

TX Spurious Emissions /802.11n(HT20) Mode CH 165(1G-26.5G)

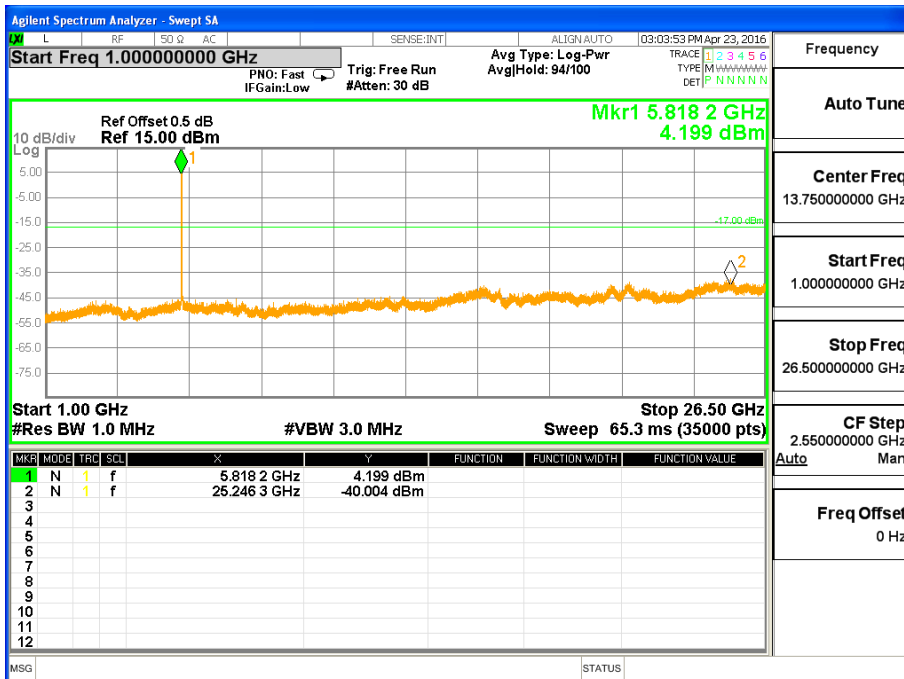



Band edge

TX Band edge /802.11n(HT20) Mode CH 149

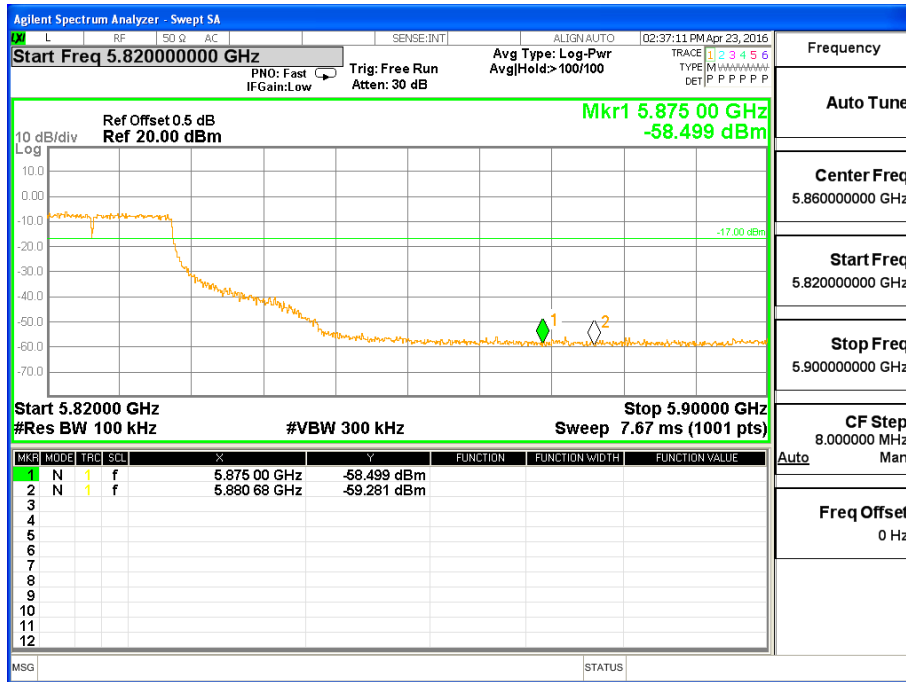

TX Band edge /802.11n(HT20) Mode CH 165

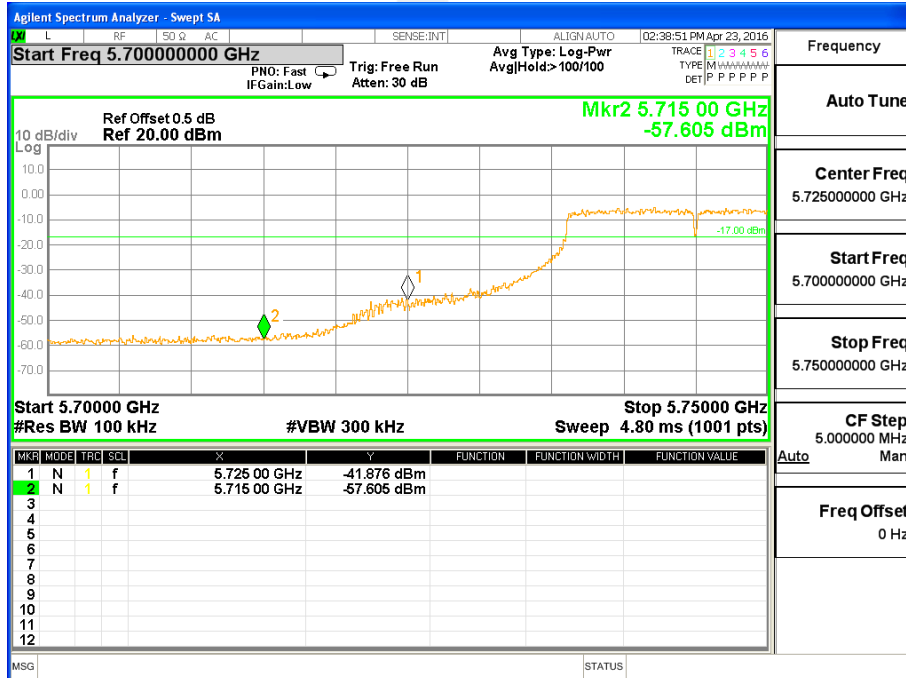



Band IV (5.725-5.85GHz) (Antenna A)

TX Spurious Emissions /802.11n(HT40) Mode CH 151 (30M-1G)

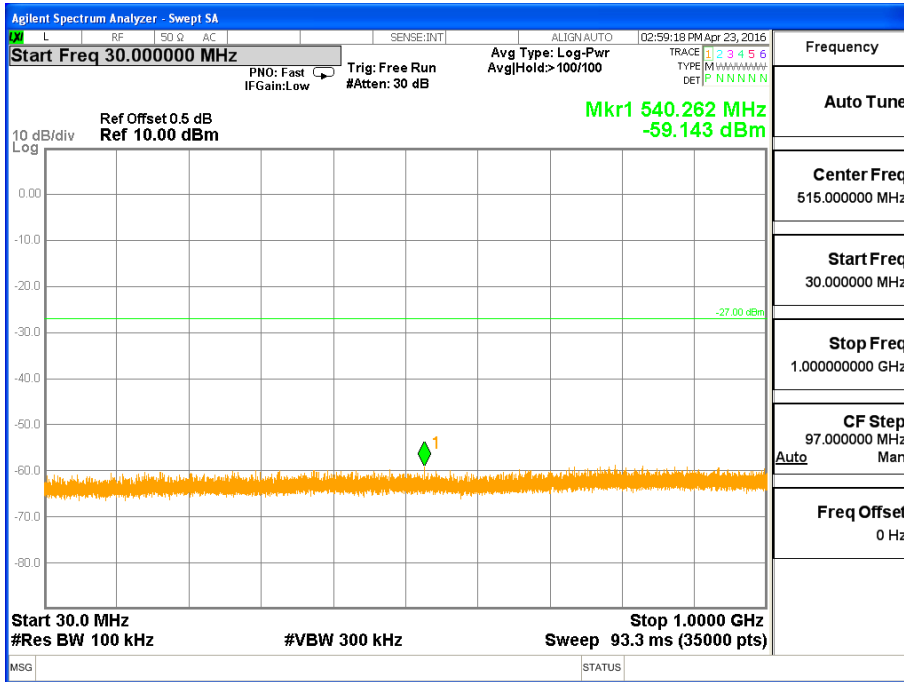

TX Spurious Emissions /802.11n(HT40) Mode CH 151 (1G-26.5G)

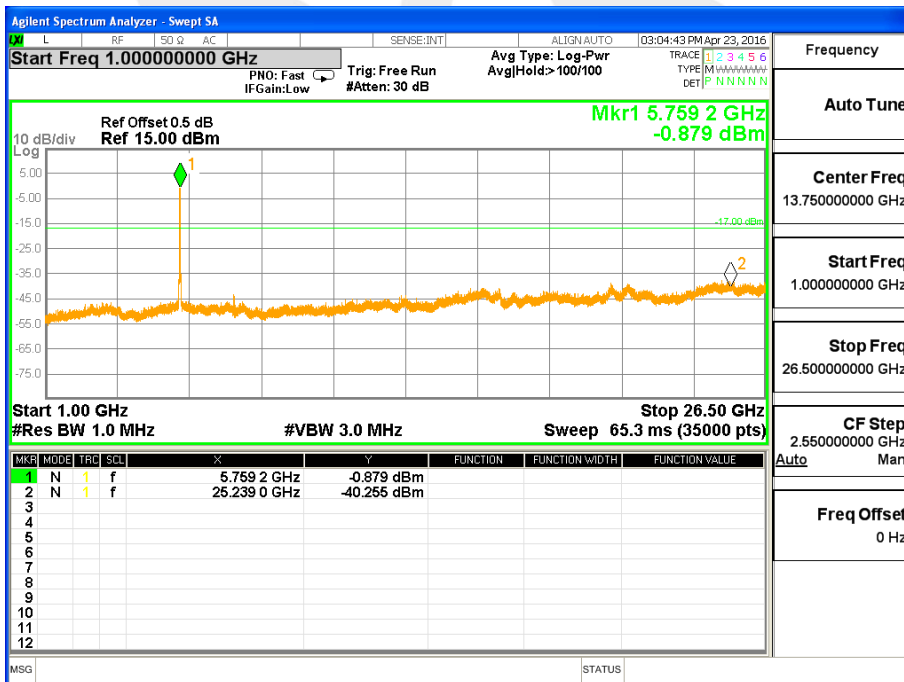



TX Spurious Emissions /802.11n(HT40) Mode CH 159 (30M-1G)

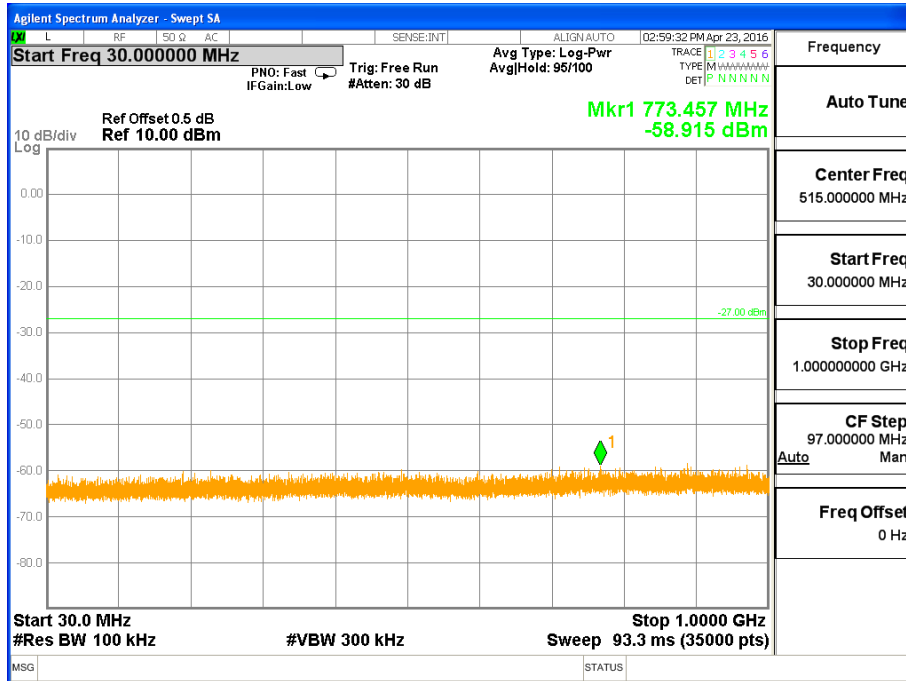

TX Spurious Emissions /802.11n(HT40) Mode CH 159 (1G-26.5G)

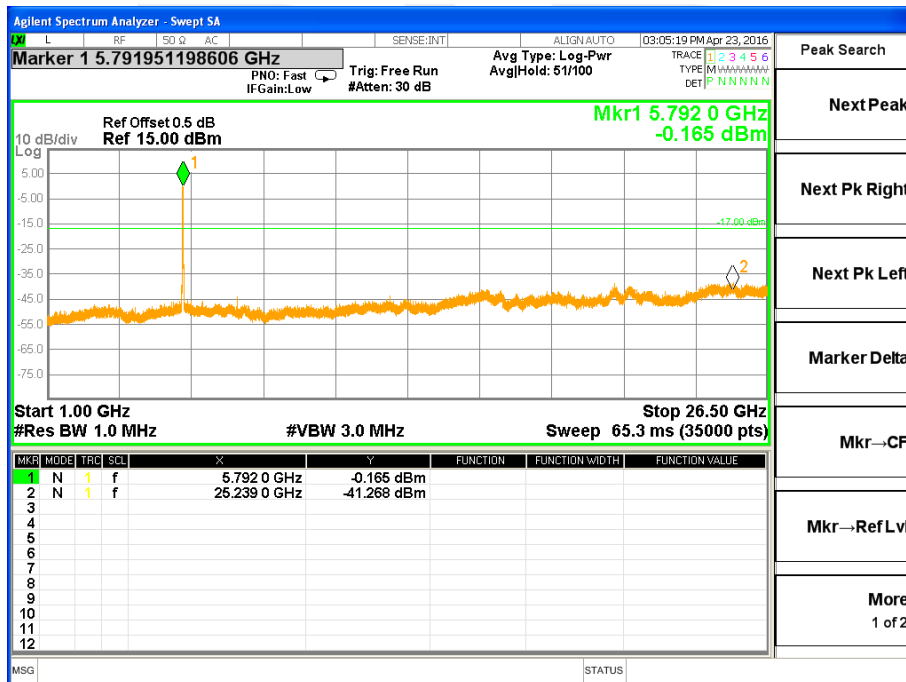



Band edge

TX Band edge /802.11n(HT40) Mode CH 151

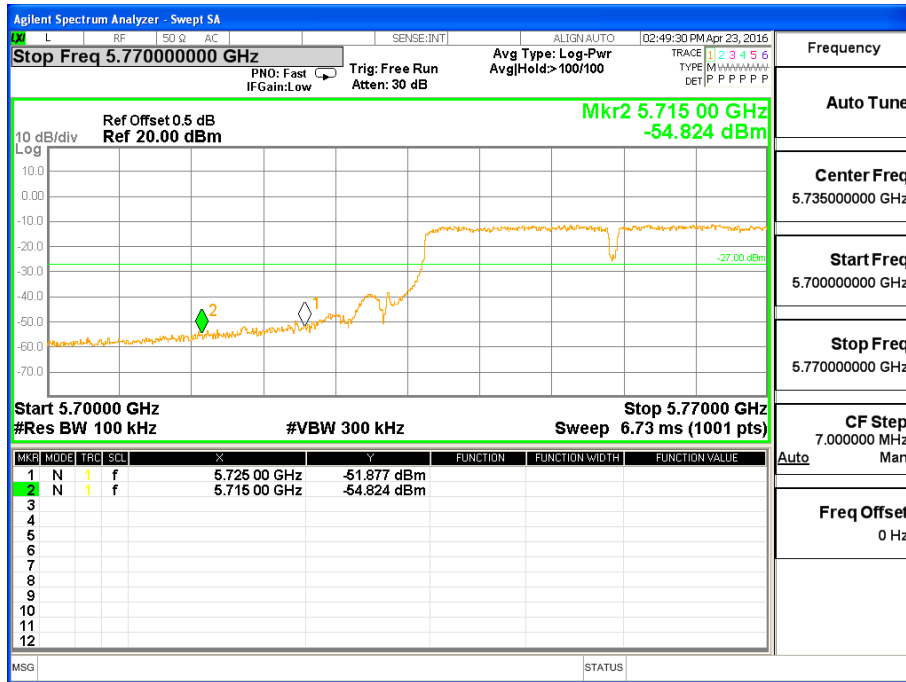

TX Band edge /802.11n(HT40) Mode CH 149

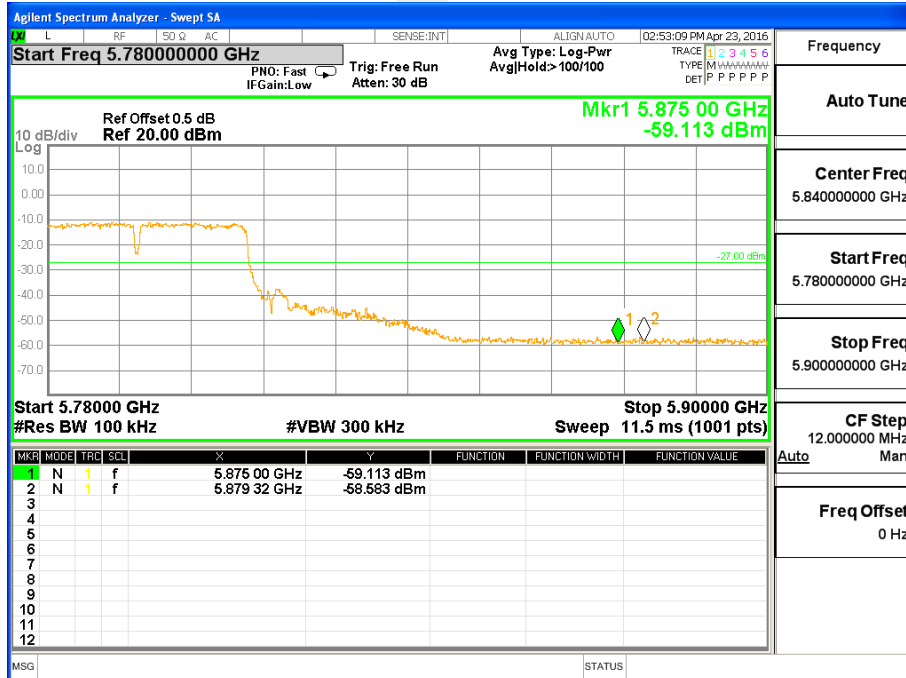



5. POWER SPECTRAL DENSITY TEST

5.1 APPLIED PROCEDURES / LIMIT

1. For mobile and portable client devices in the 5.15-5.25 GHz band, the peak power spectral density shall not exceed 11dBm in any 1MHz band.
2. For the band 5.725-5.850 GHz, the peak power spectral density shall not exceed 30 dBm in any 500KHz band. If transmitting antenna directional gain is greater than 6 dBi, both the maximum conducted output power and the peak power spectral density shall be reduced by the amount in dB that the directional gain of the antenna exceeds 6 dBi.

5.1.1 TEST PROCEDURE

1. The setting follows Method SA-1 of FCC KDB 789033 D02 General UNII Test Procedures New Rules v01r01.

For devices operating in the band, the rules specify a measurement bandwidth of 500 kHz. Many spectrum analyzers do not have 500 kHz RBW, thus a narrower RBW may need to be used. The rules permit the use of a RBWs less than 1 MHz, or 500 kHz, "provided that the measured power is integrated over the full reference bandwidth" to show the total power over the specified measurement bandwidth (*i.e.*, 1 MHz, or 500 kHz). If measurements are performed using a reduced resolution bandwidth (< 1 MHz, or < 500 kHz) and integrated over 1 MHz, or 500 KHz bandwidth, the following adjustments to the procedures apply:

- a) Set $RBW \geq 1/T$, where T is defined in section II.B.I.a).
- b) Set $VBW \geq 3 RBW$.
- c) If measurement bandwidth of Maximum PSD is specified in 500 kHz, add $10 \log (500\text{kHz}/RBW)$ to the measured result, whereas $RBW (< 500 \text{ kHz})$ is the reduced resolution bandwidth of the spectrum analyzer set during measurement.
- d) If measurement bandwidth of Maximum PSD is specified in 1 MHz, add $10 \log (1\text{MHz}/RBW)$ to the measured result, whereas $RBW (< 1 \text{ MHz})$ is the reduced resolution bandwidth of spectrum analyzer set during measurement.
- e) Care must be taken to ensure that the measurements are performed during a period of continuous transmission or are corrected upward for duty cycle.

Note: As a practical matter, it is recommended to use reduced RBW of 100 kHz for the sections 5.c) and 5.d) above, since $RBW=100 \text{ KHZ}$ is available on nearly all spectrum analyzers.

5.1.2 DEVIATION FROM STANDARD

No deviation.

5.1.3 TEST SETUP



5.1.4 EUT OPERATION CONDITIONS

The EUT tested system was configured as the statements of 2.1 Unless otherwise a special operating condition is specified in the follows during the testing.





5.1.5 TEST RESULTS

- NOT:1. Transmissions Level (dBm)=(Antenna A) Port. Antenna A Signal strength strongest.
- 2. Antenna A and Antenna B have a test, only provides the worst antenna of A plot.

Band I (5.15-5.25GHz)802.11a (Antenna A)

Frequency	Power Density			Limit (dBm)	Result
	ANT A (dBm)	ANT B (dBm)	TOTAL (dBm)		
5180	-8.79	-9.26	-6.01	11	PASS
5200	-7.88	-8.15	-5.00	11	PASS
5240	-7.69	-8.20	-4.93	11	PASS

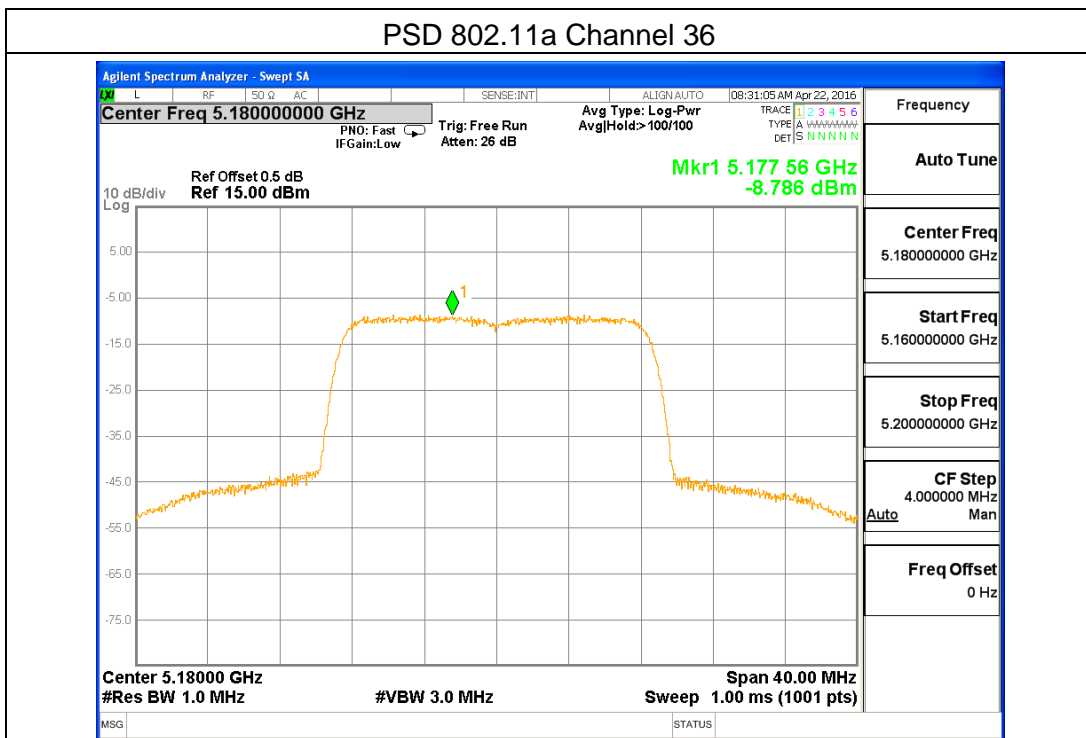

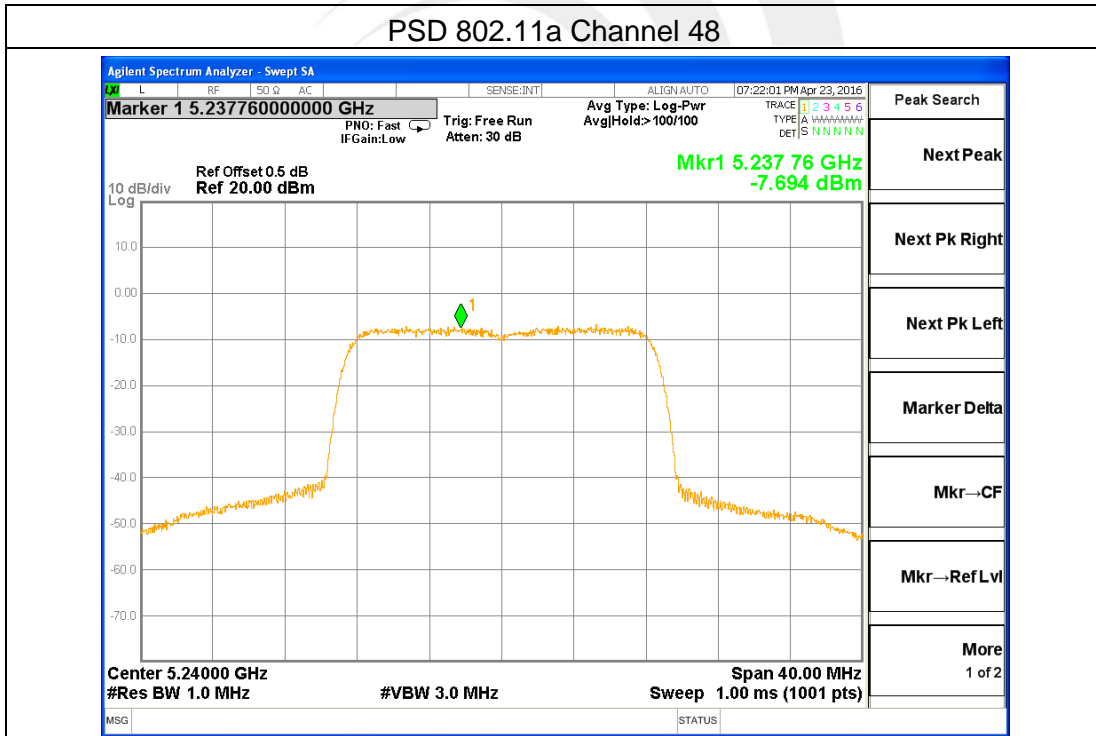
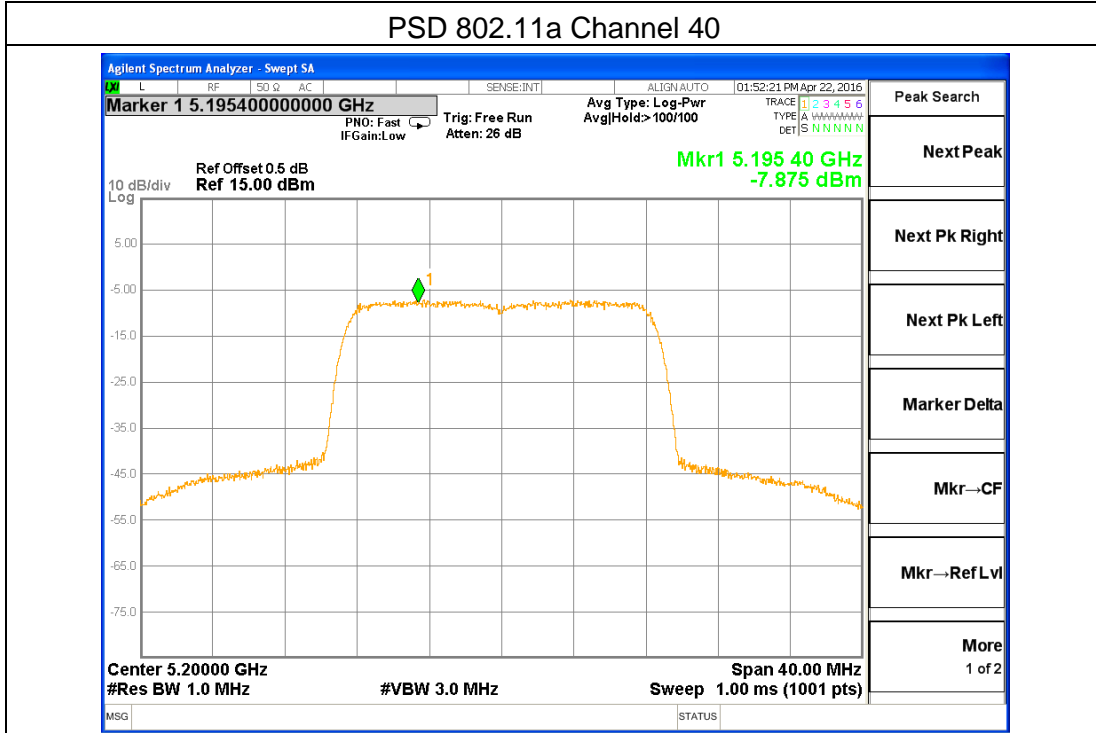



Band I (5.15-5.25GHz) 802.11n(HT20) (Antenna A)

Frequency	Power Density			Limit (dBm)	Result
	ANT A (dBm)	ANT B (dBm)	TOTAL (dBm)		
5180	-7.91	-8.20	-5.04	11	PASS
5200	-7.97	-8.14	-5.04	11	PASS
5240	-7.44	-8.26	-4.82	11	PASS

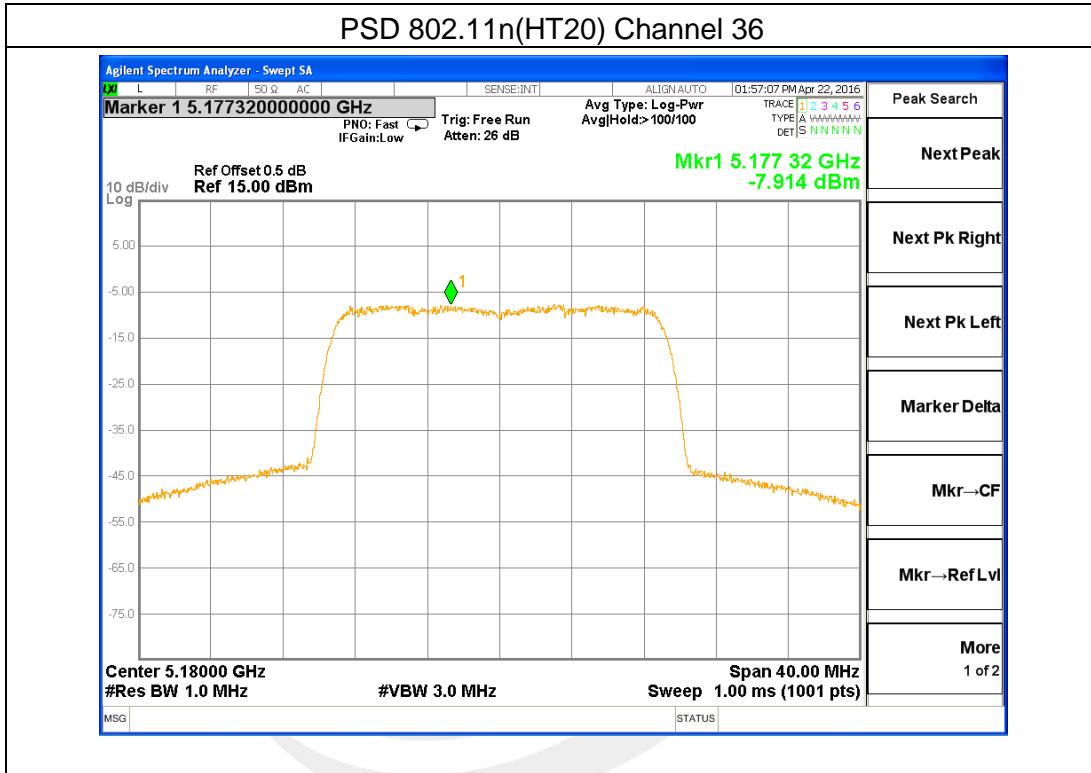

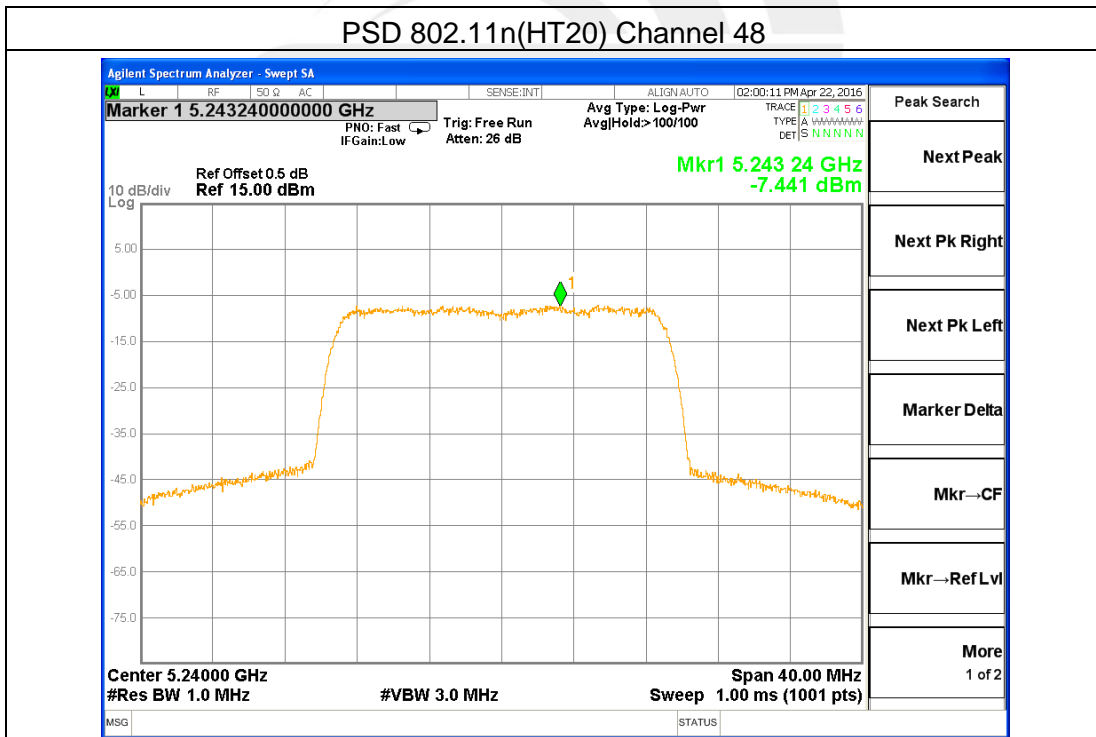
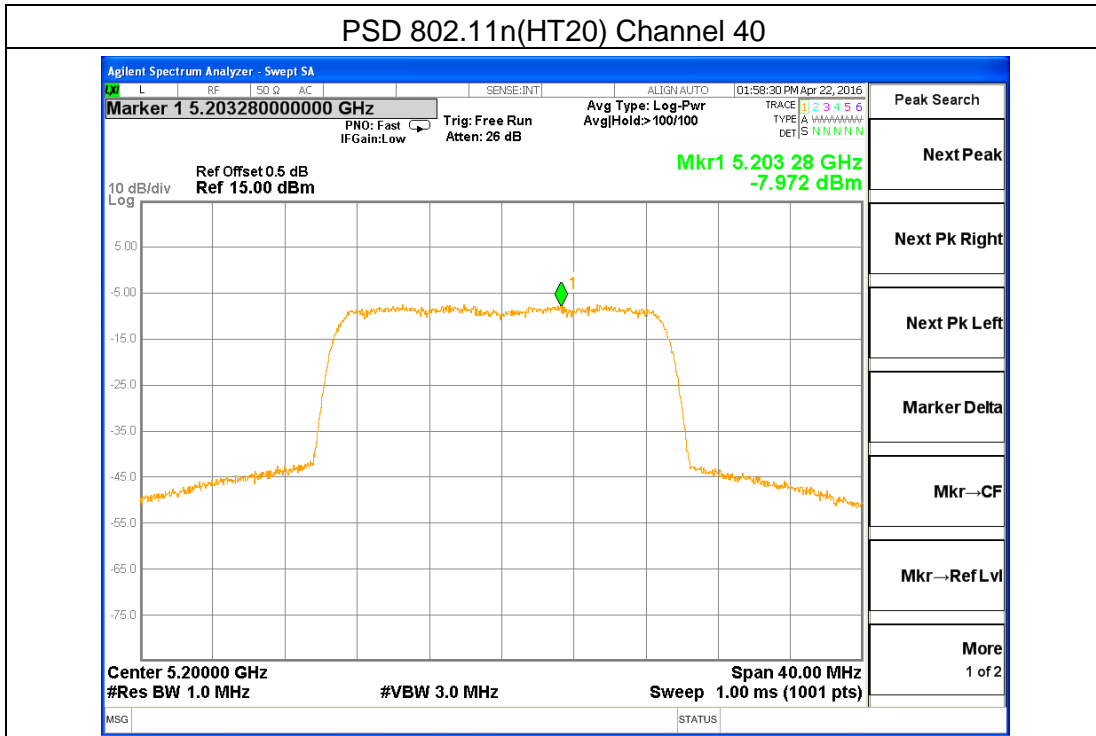



Band I (5.15-5.25GHz) 802.11n(HT40) (Antenna A)

Frequency	Power Density			Limit (dBm)	Result
	ANT A (dBm)	ANT B (dBm)	TOTAL (dBm)		
5190	-13.16	-14.04	-10.57	11	PASS
5230	-12.46	-12.78	-9.60	11	PASS

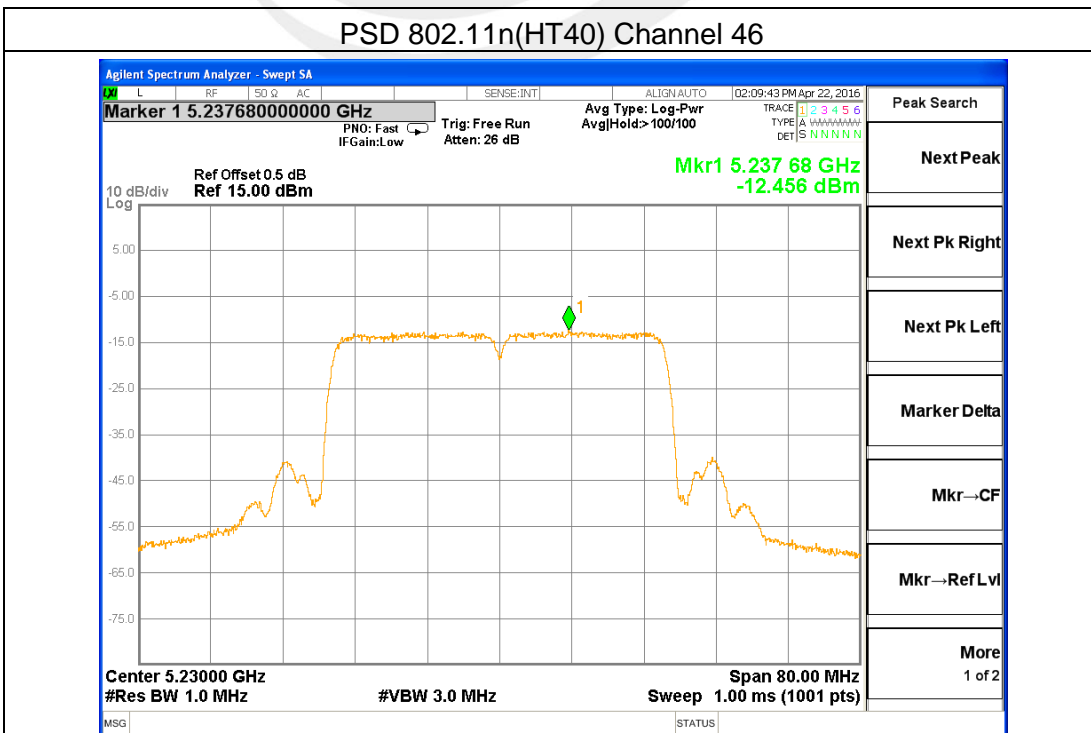
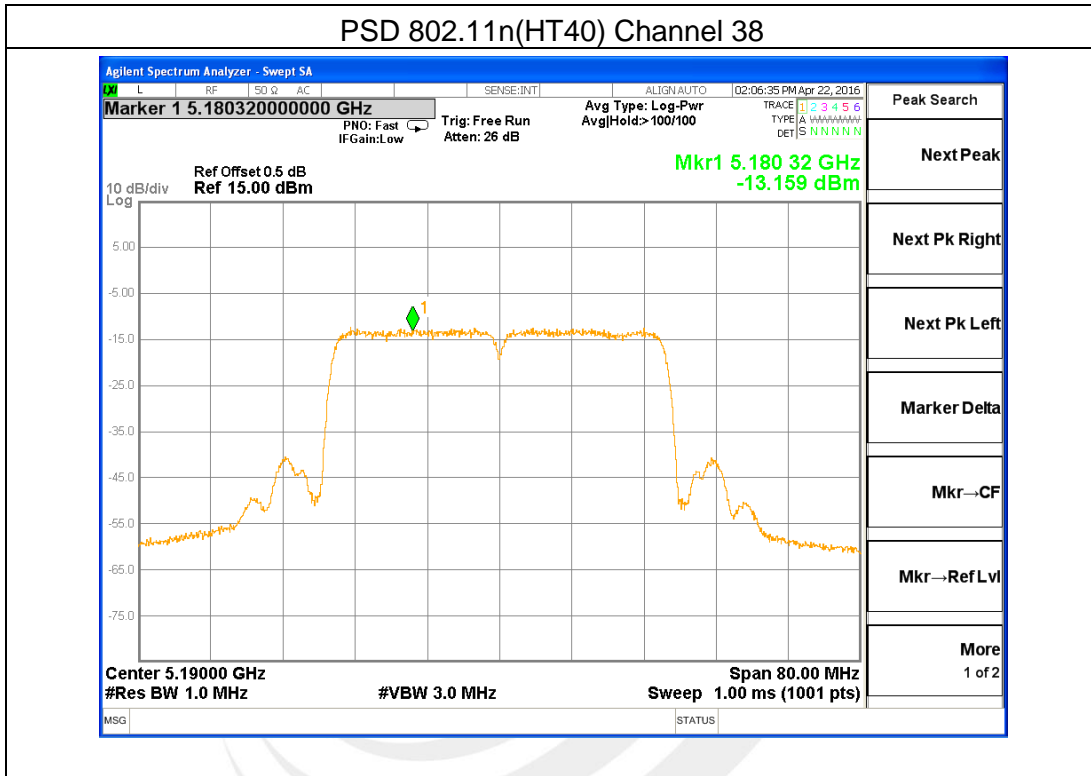



Band IV (5.725-5.850GHz)802.11a (Antenna A)

Frequency	Power Density			Limit (dBm)	Result
	ANT A (dBm)	ANT B (dBm)	TOTAL (dBm)		
5745	-8.37	-8.91	-5.62	30	PASS
5785	-6.44	-7.30	-3.84	30	PASS
5825	-7.38	-7.43	-4.39	30	PASS

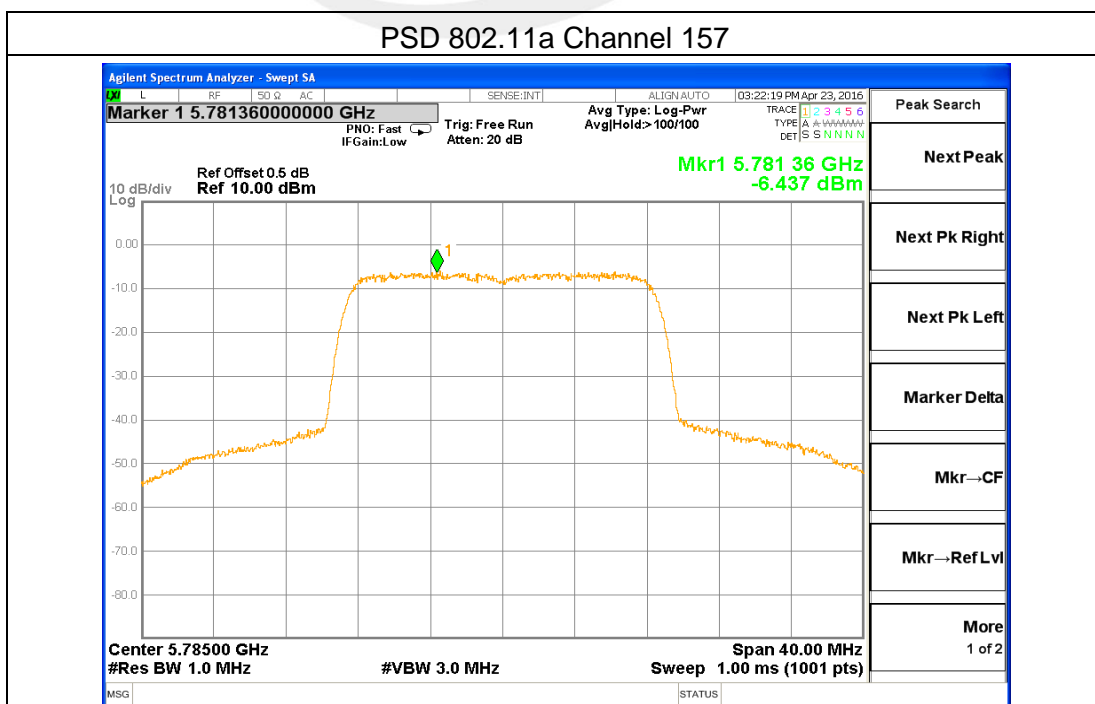
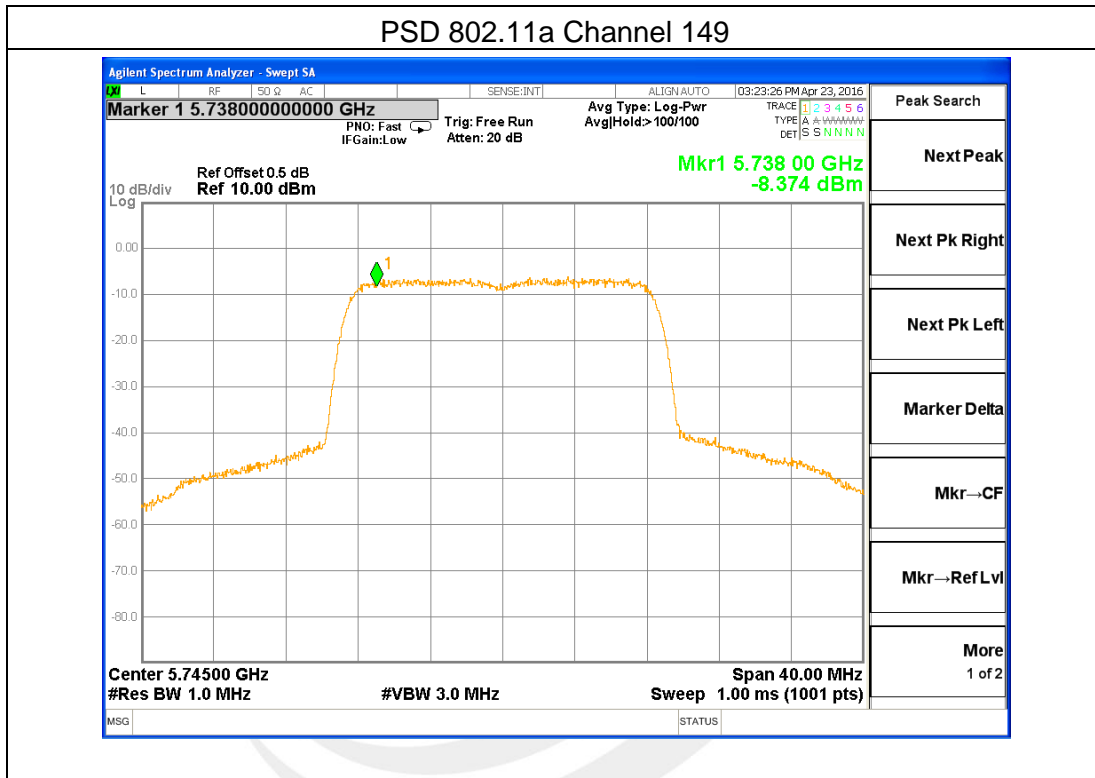

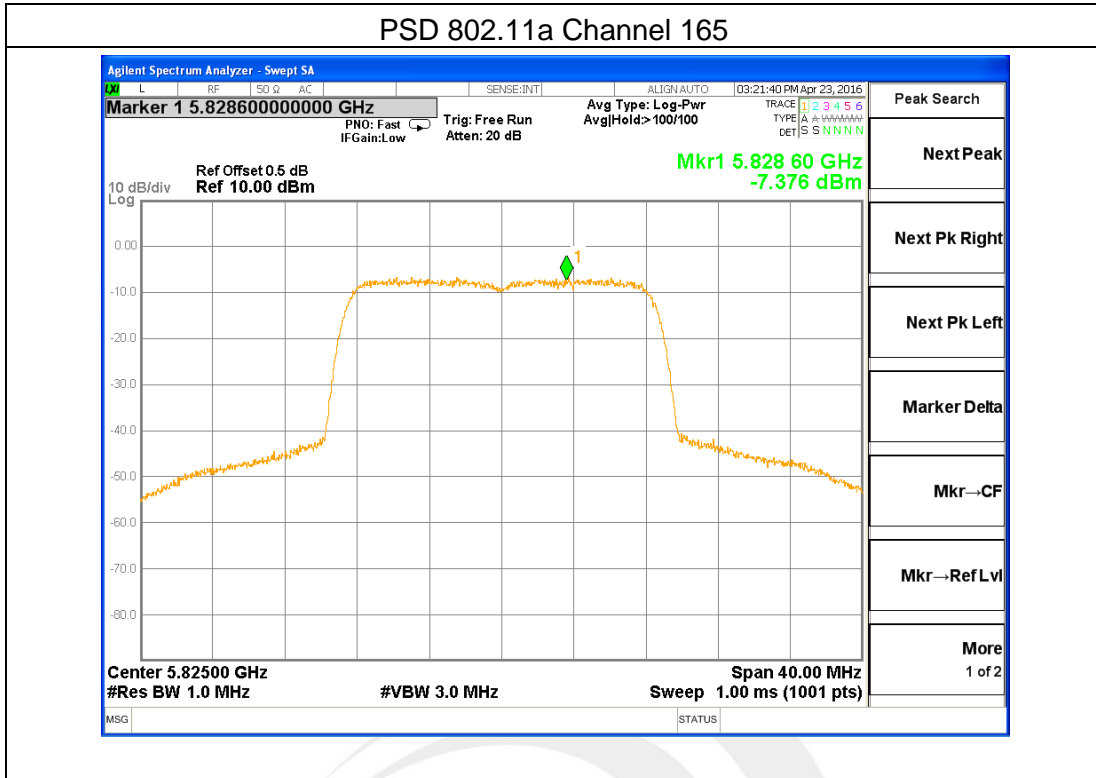



Band IV (5.725-5.850GHz)802.11n(HT20) (Antenna A)

Frequency	Power Density			Limit (dBm)	Result
	ANT A (dBm)	ANT B (dBm)	TOTAL (dBm)		
5745	-7.93	-8.51	-5.20	30	PASS
5785	-6.62	-7.32	-3.95	30	PASS
5825	-7.27	-7.53	-4.39	30	PASS

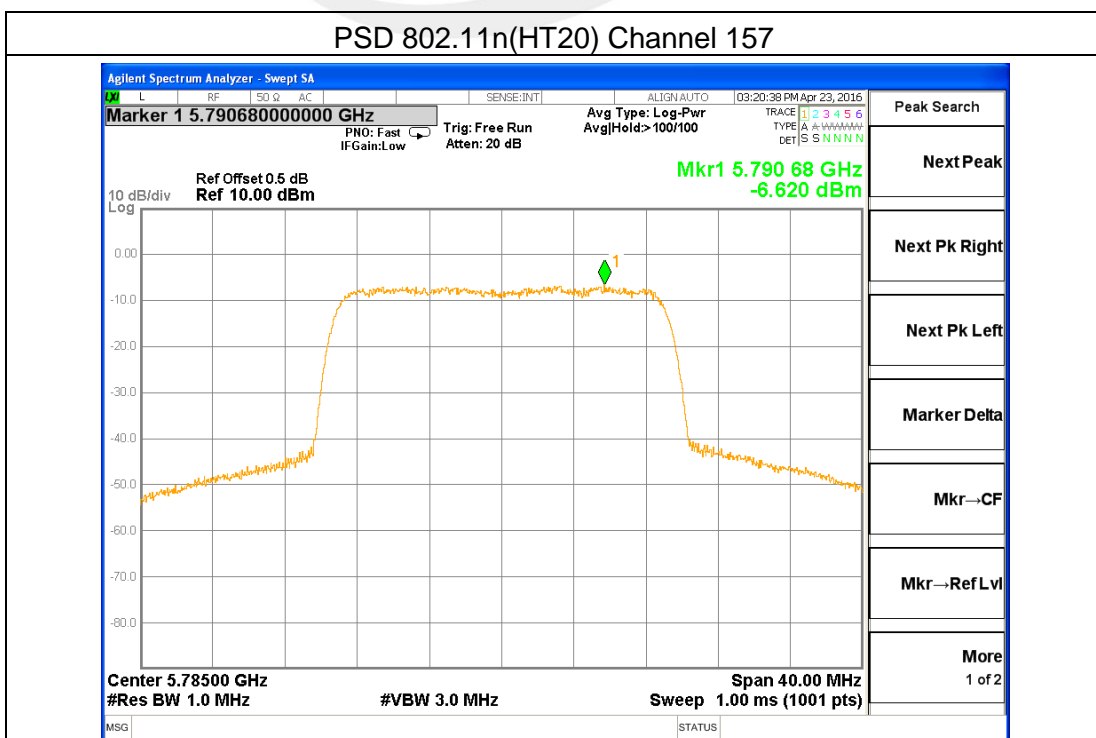
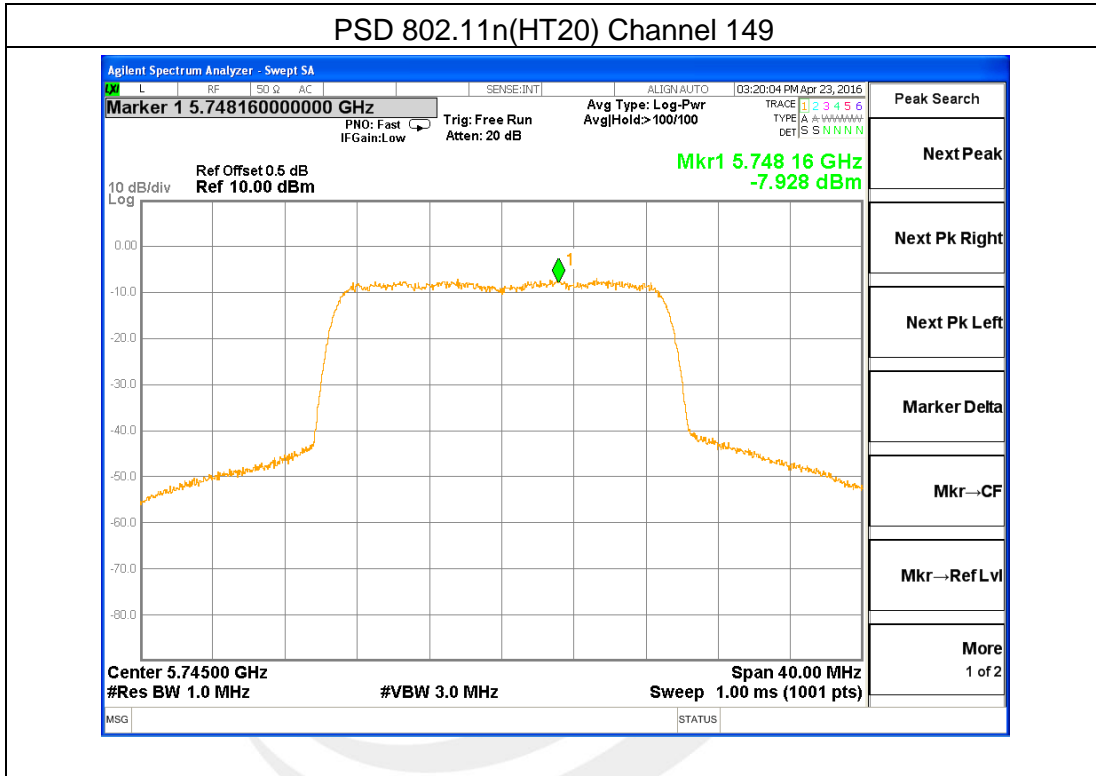

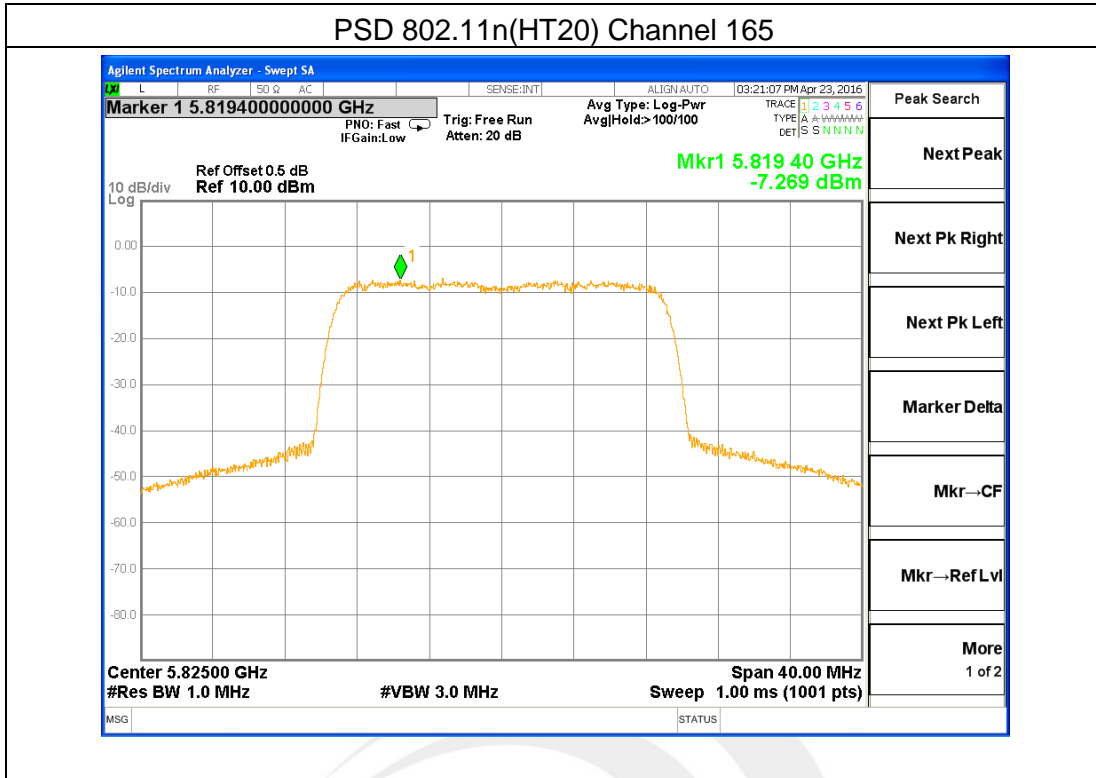



Band IV (5.725-5.850GHz)802.11n(HT40) (Antenna A)

Frequency	Power Density			Limit (dBm)	Result
	ANT A (dBm)	ANT B (dBm)	TOTAL (dBm)		
5755	-13.31	-13.69	-10.49	30	PASS
5795	-12.21	-13.25	-9.69	30	PASS

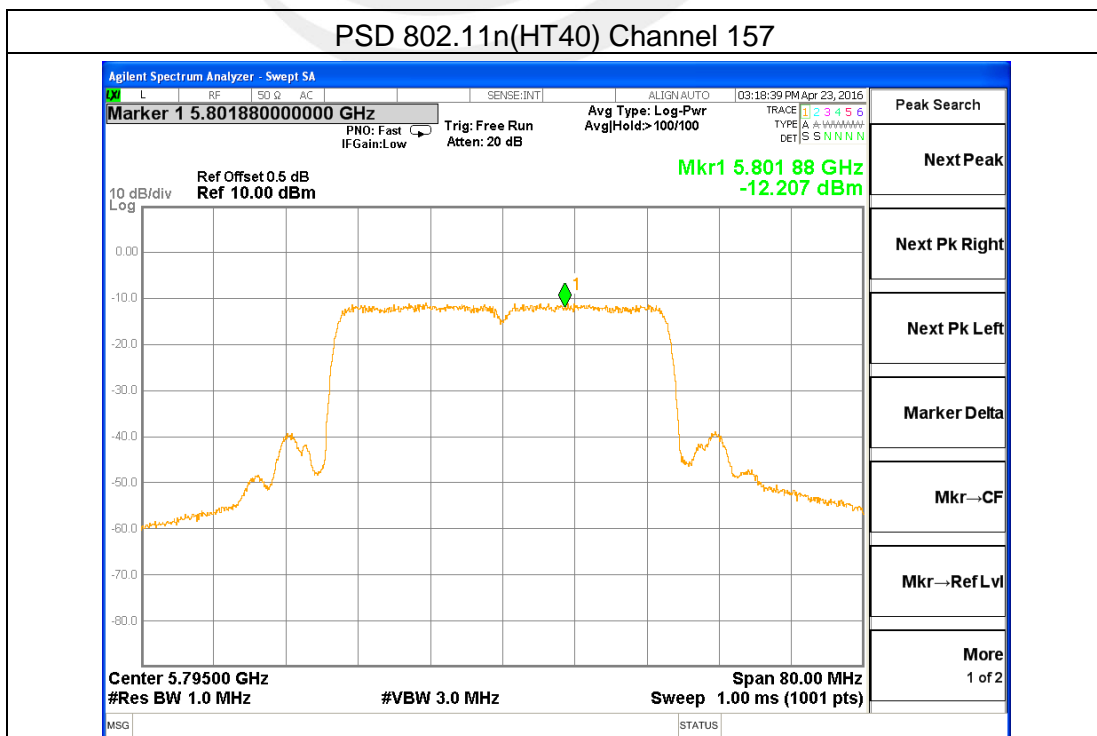
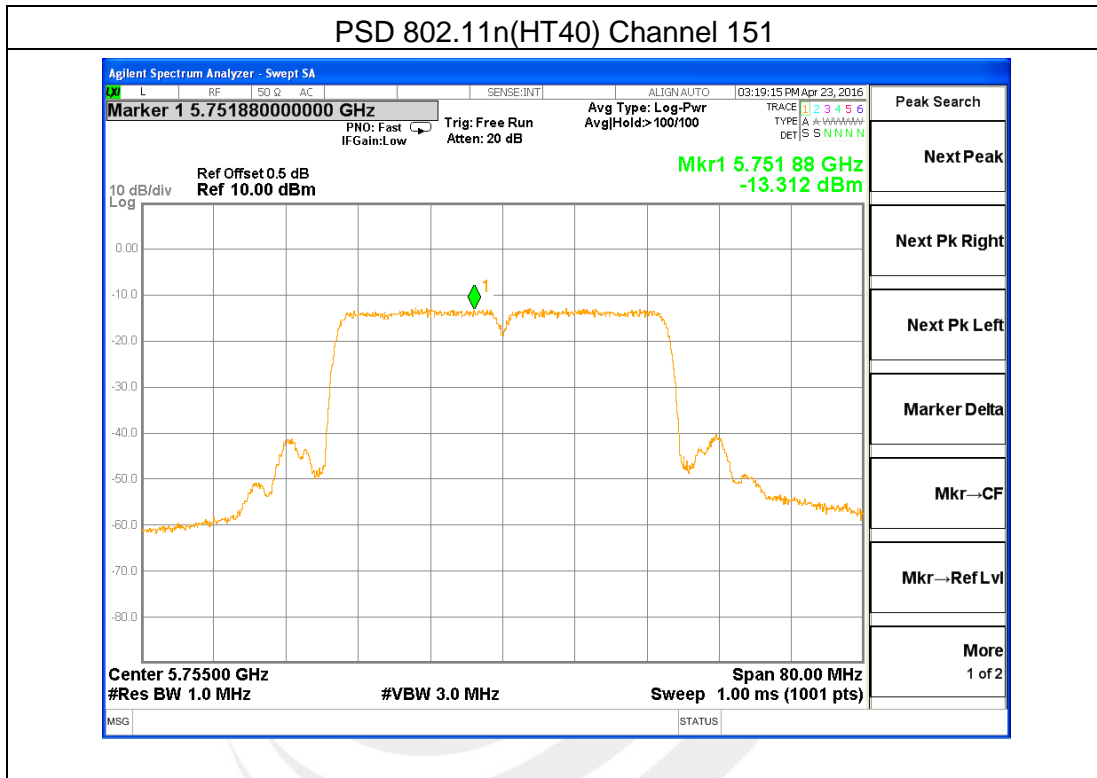

6. BANDWIDTH MEASUREMENT

6.1 EMISSION BANDWIDTH (EBW) 26 BANDWID PROCEDURES / LIMIT

See list of measuring instruments of this test report.

6.1.1 TEST PROCEDURE

1. The testing follows FCC KDB 789033 D02 General UNII Test Procedures New Rules v01r01
2. Set RBW = approximately 1% of the emission bandwidth.
3. Set the VBW \geq RBW.
4. Detector = Peak.
5. Trace mode = max hold.
6. Measure the maximum width of the emission that is 26 dB down from the peak of the emission. Compare this with the RBW setting of the analyzer. Readjust RBW and repeat measurement as needed until the RBW/EBW ratio is approximately 1%.

6.1.2 DEVIATION FROM STANDARD

No deviation.

6.1.3 TEST SETUP

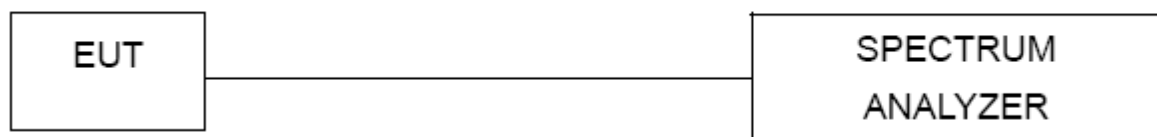

6.1.4 EUT OPERATION CONDITIONS

The EUT tested system was configured as the statements of 2.4 Unless otherwise a special operating condition is specified in the follows during the testing.

**6.1.5 TEST RESULTS**

- NOT:1. Transmissions Level (dBm)=(Antenna A) Port. Antenna A Signal strength strongest.
2. Antenna A and Antenna B have a test, only provides the worst antenna of A plot.

Band I (5.150-5.250GHz)

Frequency (MHz)	802.11a 26dB Bandwidth(MHz)		Pass/Fail
	Antenna A	Antenna B	
5180	21.98	21.68	N/A
5200	21.37	21.21	N/A
5240	20.41	20.13	N/A

Note: N/A, 26 db bandwidth measurement limit only embodied in the report.

Frequency (MHz)	802.11n(HT20) 26dB Bandwidth(MHz)		Pass/Fail
	Antenna A	Antenna B	
5180	22.53	22.21	N/A
5200	22.82	22.67	N/A
5240	20.13	20.09	N/A

Note: N/A, 26 db bandwidth measurement limit only embodied in the report.

Frequency (MHz)	802.11n(HT40) 26dB Bandwidth(MHz)		Pass/Fail
	Antenna A	Antenna B	
5190	57.15	57.02	N/A
5230	58.83	58.71	N/A

Note: N/A, 26 db bandwidth measurement limit only embodied in the report.

Band IV (5.725-5.850GHz)

Frequency (MHz)	802.11a 26dB Bandwidth(MHz)		Pass/Fail
	Antenna A	Antenna B	
5745	22.86	22.65	N/A
5785	21.38	21.24	N/A
5825	19.86	19.62	N/A

Note: N/A, 26 db bandwidth measurement limit only embodied in the report.

Frequency (MHz)	802.11n(HT20) 26dB Bandwidth(MHz)		Pass/Fail
	Antenna A	Antenna B	
5745	20.88	20.34	N/A
5785	20.12	20.08	N/A
5825	23.21	23.14	N/A

Note: N/A, 26 db bandwidth measurement limit only embodied in the report.

Frequency (MHz)	802.11n(HT40) 26dB Bandwidth(MHz)		Pass/Fail
	Antenna A	Antenna B	
5755	61.86	61.74	N/A
5795	55.26	55.21	N/A

Note: N/A, 26 db bandwidth measurement limit only embodied in the report.

6.2 OCCUPIED BANDWIDTH (99%) TEST APPLIED PROCEDURES / LIMIT

The following procedure shall be used for measuring (99 %) power bandwidth:

6.2.1 TEST PROCEDURE

1. The testing follows FCC KDB 789033 D02 General UNII Test Procedures v01r01.

The following procedure shall be used for measuring (99 %) power bandwidth:

1. Set center frequency to the nominal EUT channel center frequency.
2. Set span = 1.5 times to 5.0 times the OBW.
3. Set RBW = 1 % to 5 % of the OBW
4. Set VBW $\geq 3 \cdot$ RBW
5. Video averaging is not permitted. Where practical, a sample detection and single sweep mode shall be used. Otherwise, peak detection and max hold mode (until the trace stabilizes) shall be used.
6. Use the 99 % power bandwidth function of the instrument (if available).
7. If the instrument does not have a 99 % power bandwidth function, the trace data points are recovered and directly summed in power units. The recovered amplitude data points, beginning at the lowest frequency, are placed in a running sum until 0.5 % of the total is reached; that frequency is recorded as the lower frequency. The process is repeated until 99.5 % of the total is reached; that frequency is recorded as the upper frequency. The 99% occupied bandwidth is the difference between these two frequencies.

6.2.2 DEVIATION FROM STANDARD

No deviation.

6.2.3 TEST SETUP



6.2.4 EUT OPERATION CONDITIONS

The EUT tested system was configured as the statements of 2.4 Unless otherwise a special operating condition is specified in the follows during the testing.

**6.2.5 TEST RESULTS**

NOT:1.Transmissions Level (dBm)=(Antenna A) Port. Antenna A Signal strength strongest.

2. Antenna A and Antenna B have a test, only provides the worst antenna of A plot.

Band I (5.150-5.250GHz)

Frequency (MHz)	802.11a 99% Bandwidth(MHz)		Pass/Fail
	Antenna A	Antenna B	
5180	16.668	16.654	N/A
5200	16.581	16.580	N/A
5240	16.569	16.562	N/A

Note: N/A, 99% bandwidth measurement limit only embodied in the report.

Frequency (MHz)	802.11n(HT20) 99% Bandwidth(MHz)		Pass/Fail
	Antenna A	Antenna B	
5180	17.682	17.678	N/A
5200	17.711	17.710	N/A
5240	17.648	17.646	N/A

Note: N/A, 99% bandwidth measurement limit only embodied in the report.

Frequency (MHz)	802.11n(HT20) 99% Bandwidth(MHz)		Pass/Fail
	Antenna A	Antenna B	
5190	36.244	36.242	N/A
5230	36.185	36.181	N/A

Note: N/A, 99% bandwidth measurement limit only embodied in the report.

Band IV (5.725-5.850GHz)

Frequency (MHz)	802.11a 99% Bandwidth(MHz)		Pass/Fail
	Antenna A	Antenna B	
5745	16.686	16.681	N/A
5785	16.589	16.583	N/A
5825	16.598	16.595	N/A

Note: N/A, 99% bandwidth measurement limit only embodied in the report.

Frequency (MHz)	802.11n(HT20) 99% Bandwidth(MHz)		Pass/Fail
	Antenna A	Antenna B	
5745	17.632	17.630	N/A
5785	17.655	17.652	N/A
5825	17.662	17.661	N/A

Note: N/A, 99% bandwidth measurement limit only embodied in the report.

Frequency (MHz)	802.11n(HT20) 99% Bandwidth(MHz)		Pass/Fail
	Antenna A	Antenna B	
5755	36.227	36.222	N/A
5795	36.125	36.121	N/A

Note: N/A, 99% bandwidth measurement limit only embodied in the report.

6.3 MINIMUM EMISSION BANDWIDTH(6 DB) PROCEDURES / LIMIT

Section 15.407(e) specifies the minimum 6 dB emission bandwidth of at least 500 KHz for the band 5.725-5.85 GHz. The following procedure shall be used for measuring this bandwidth:

6.3.1 TEST PROCEDURE

1. The testing follows FCC KDB 789033 D02 General UNII Test Procedures v01r01.
 - a) Set RBW = 100 kHz.
 - b) Set the video bandwidth (VBW) $\geq 3 \times$ RBW.
 - c) Detector = Peak.
 - d) Trace mode = max hold.
 - e) Sweep = auto couple.
 - f) Allow the trace to stabilize.
 - g) Measure the maximum width of the emission that is constrained by the frequencies associated with the two outermost amplitude points (upper and lower frequencies) that are attenuated by 6 dB relative to the maximum level measured in the fundamental emission.

6.3.2 DEVIATION FROM STANDARD

No deviation.

6.3.3 TEST SETUP

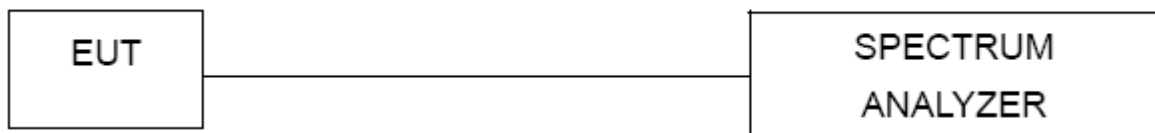

6.3.4 EUT OPERATION CONDITIONS

The EUT tested system was configured as the statements of 2.4 Unless otherwise a special operating condition is specified in the follows during the testing.

**6.3.5 TEST RESULTS**

NOT:1.Transmissions Level (dBm)=(Antenna A) Port. Antenna A Signal strength strongest.

2. Antenna A and Antenna B have a test, only provides the worst antenna of A plot.

Band IV (5.725-5.850GHz)

Frequency (MHz)	802.11n(HT20) 6dB Bandwidth(MHz)		Pass/Fail
	Antenna A	Antenna B	
5745	16.60	16.60	>500KHz
5785	16.60	16.60	>500KHz
5825	16.60	16.60	>500KHz

Note: N/A, 6 db bandwidth measurement limit only embodied in the report

Frequency (MHz)	802.11n(HT20) 6dB Bandwidth(MHz)		Pass/Fail
	Antenna A	Antenna B	
5745	17.82	17.80	>500KHz
5785	17.81	17.80	>500KHz
5825	17.82	17.81	>500KHz

Note: N/A, 6 db bandwidth measurement limit only embodied in the report

Frequency (MHz)	802.11n(HT40) 6dB Bandwidth(MHz)		Pass/Fail
	Antenna A	Antenna B	
5755	36.49	36.49	>500KHz
5795	36.50	36.49	>500KHz

Note: N/A, 6 db bandwidth measurement limit only embodied in the report



6.4 BANDWIDTH TEST POLT

- NOT:1. Transmissions Level (dBm)=(Antenna A) Port. Antenna A Signal strength strongest.
- 2. Antenna A and Antenna B have a test, only provides the worst antenna of A plot.

Band I (5.150-5.250GHz) 802.11a 26 dB & 99% Bandwidth (Antenna A)

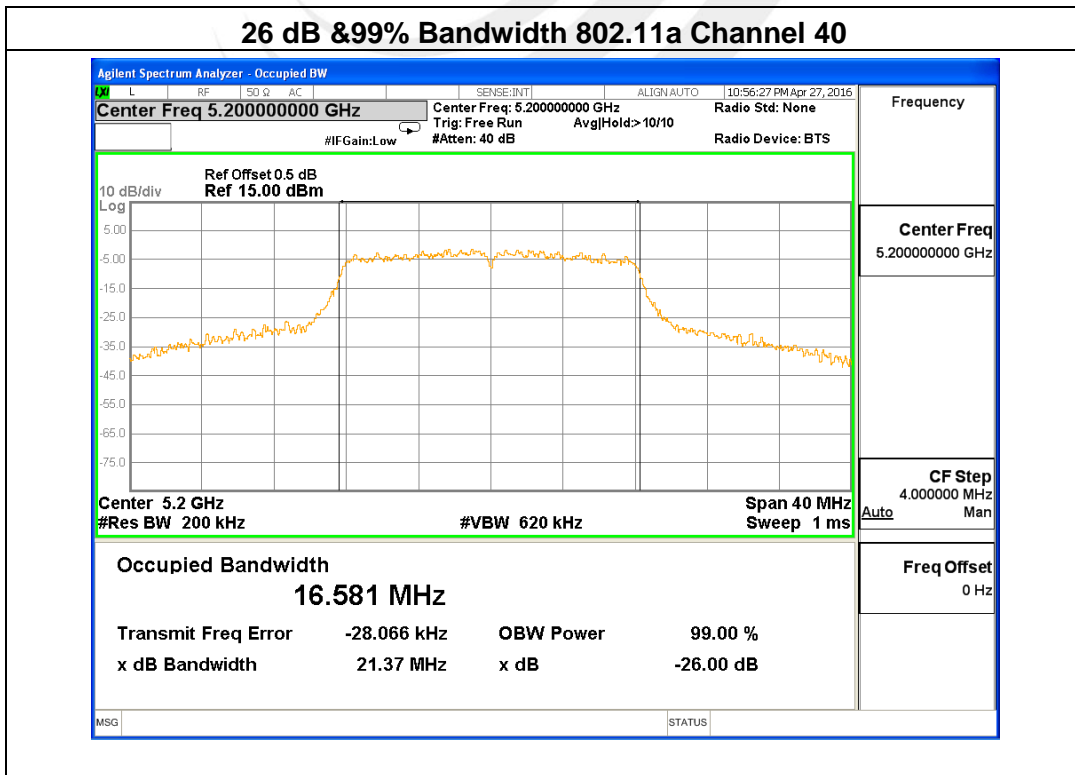
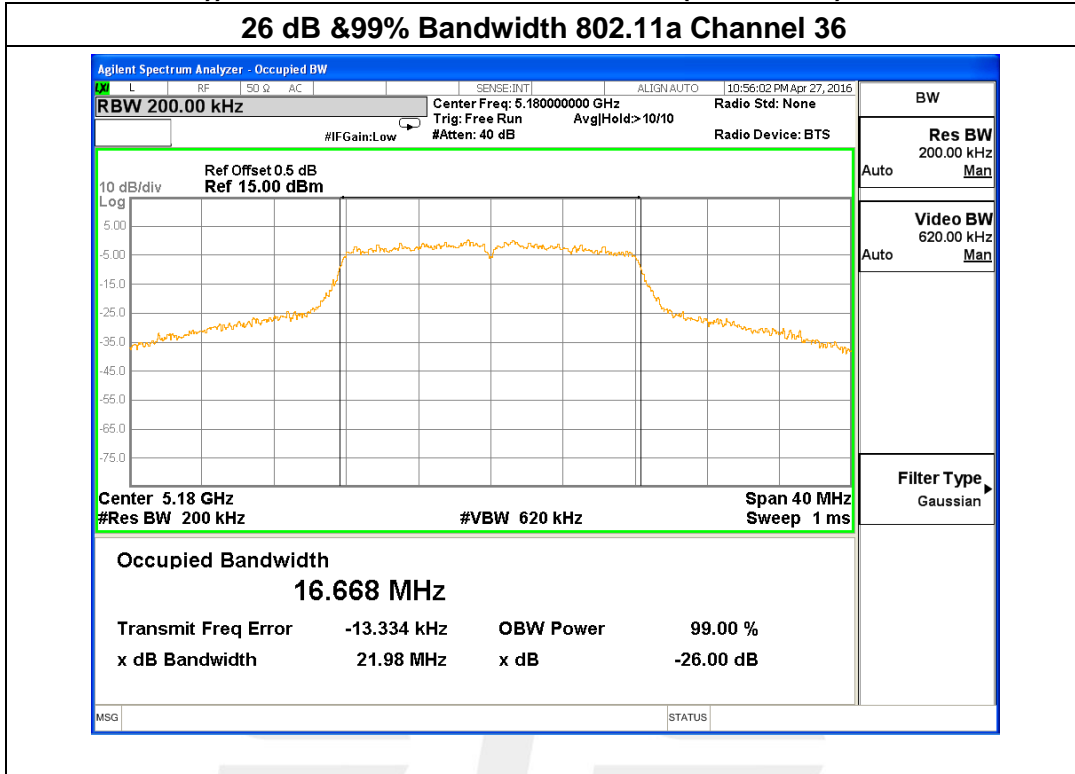



26 dB & 99% Bandwidth 802.11a Channel 48

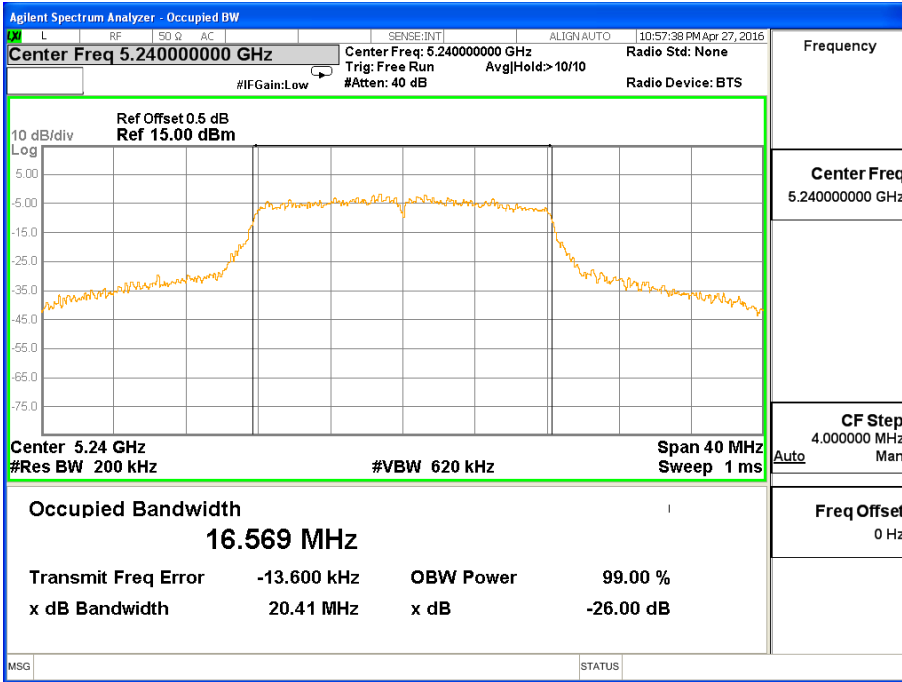



Band I (5.150-5.250GHz) 802.11n(HT20) 26 dB &99% Bandwidth (Antenna A)

26 dB &99% Bandwidth 802.11n(HT20) Channel 36

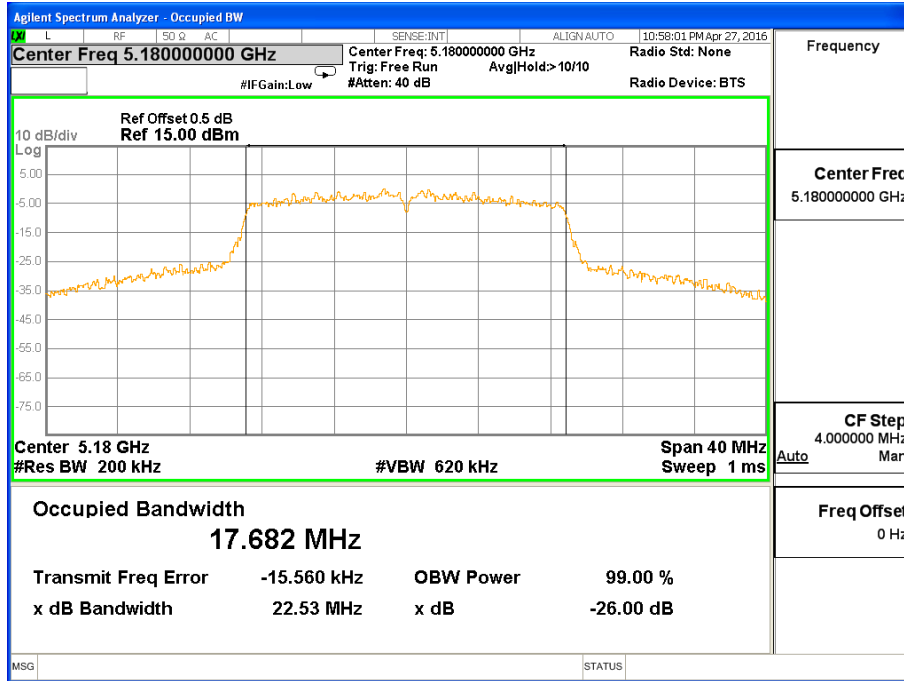

26 dB &99% Bandwidth 802.11n(HT20) Channel 40

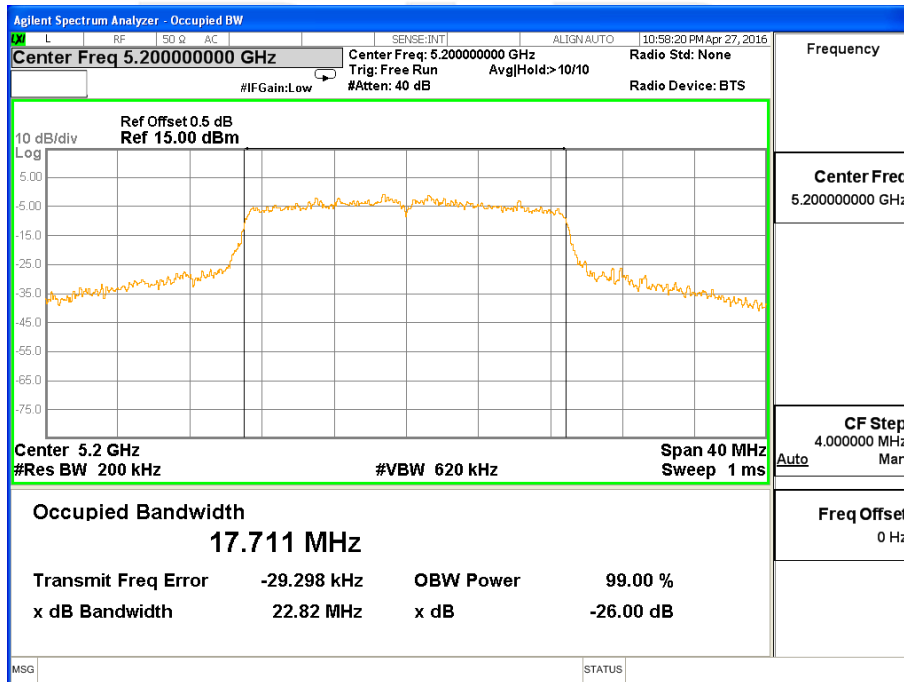



26 dB & 99% Bandwidth 802.11n(HT20) Channel 48

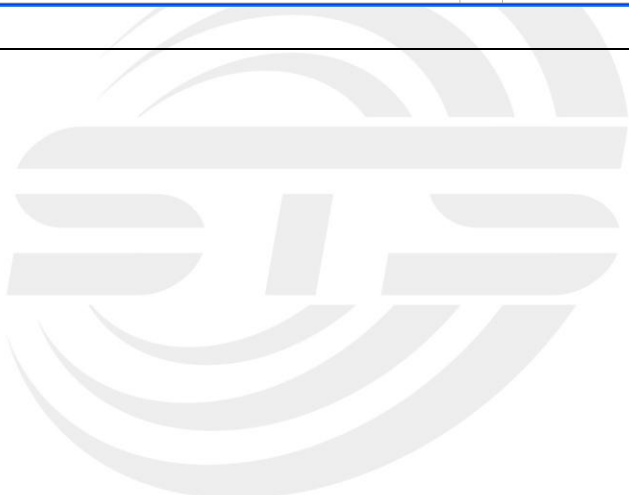
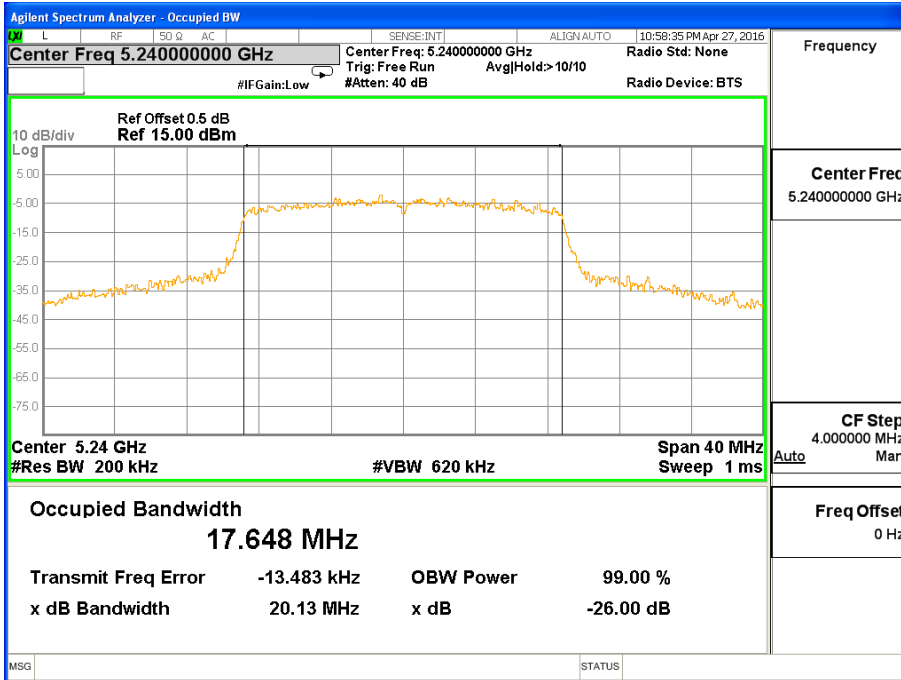



Band I (5.150-5.250GHz) 802.11n(HT40) 26 dB &99% Bandwidth (Antenna A)

26 dB &99% Bandwidth 802.11n(HT40) Channel 38

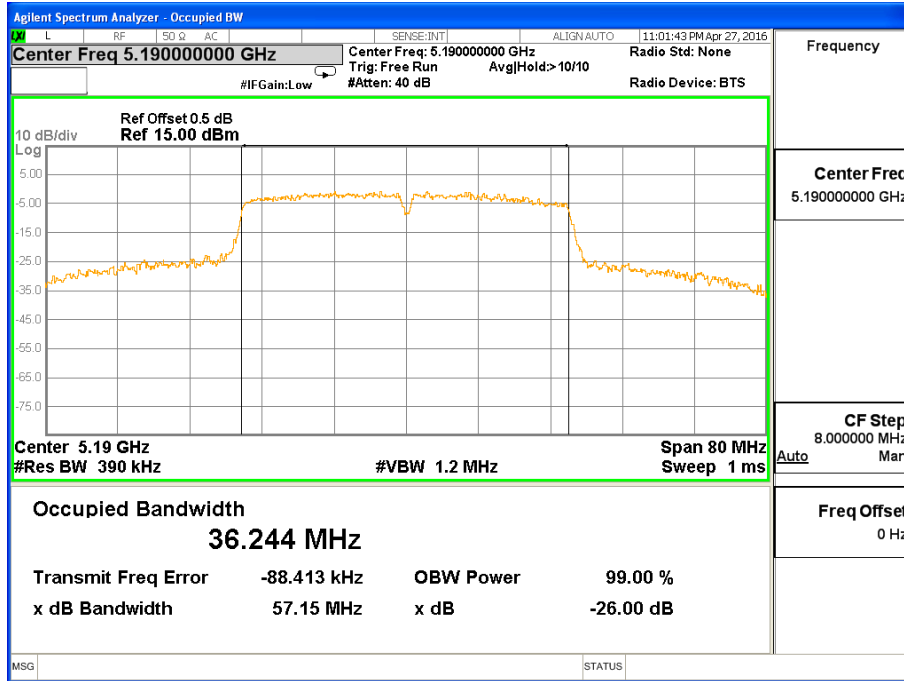

26 dB &99% Bandwidth 802.11n(HT40) Channel 46

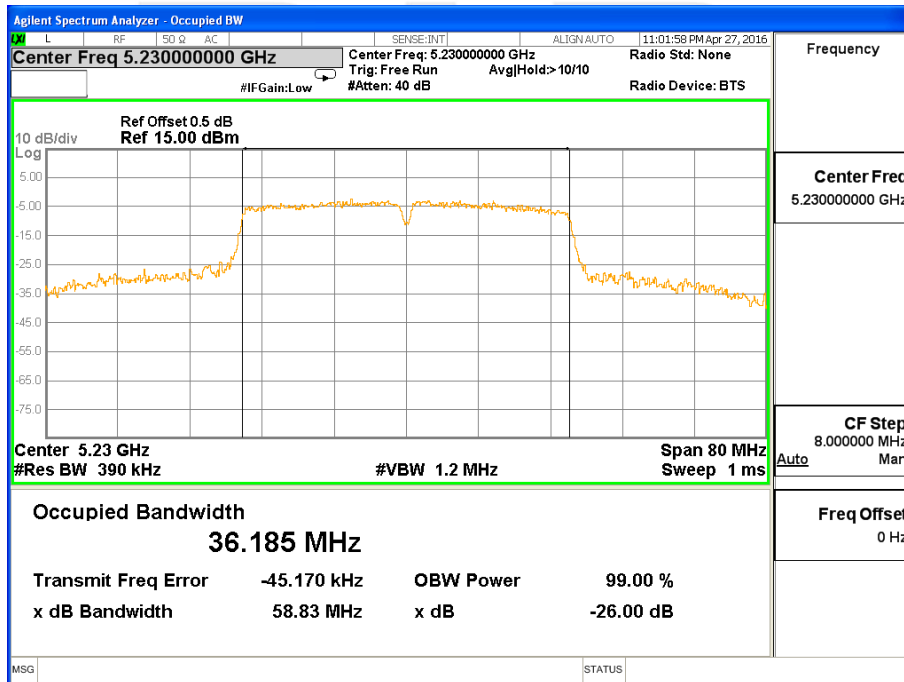



Band IV (5.725-5.850GHz) 802.11a, 26 dB &99% Bandwidth (Antenna A)

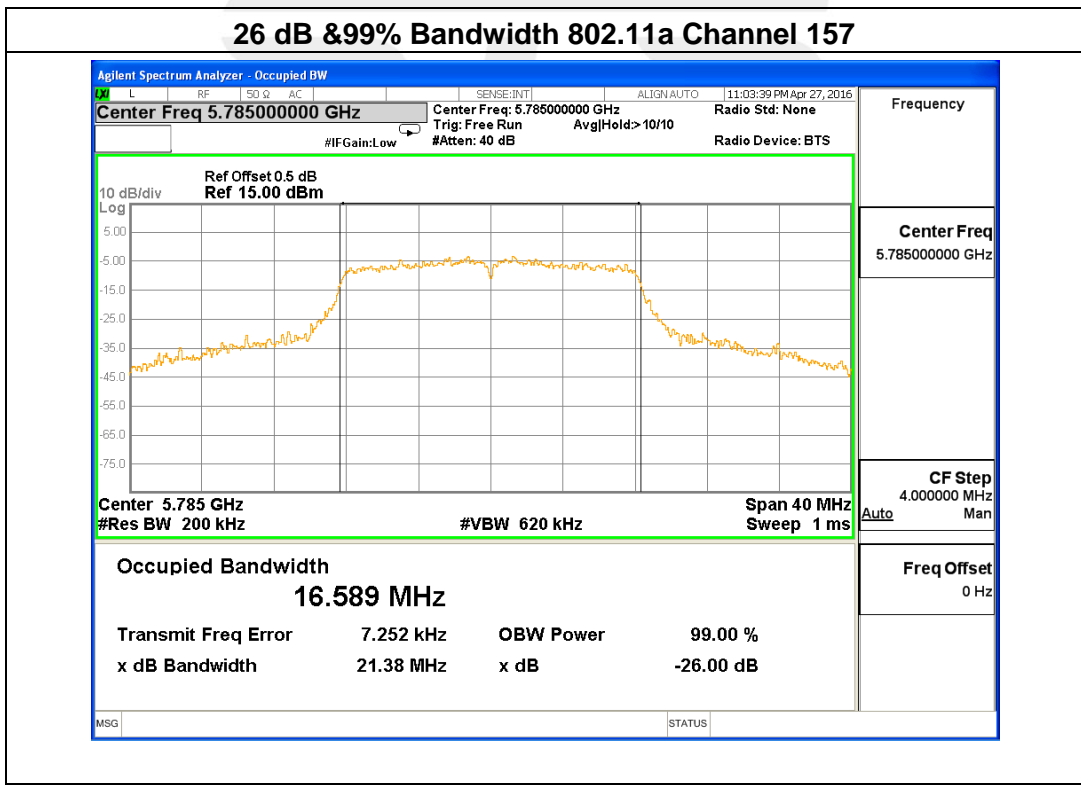
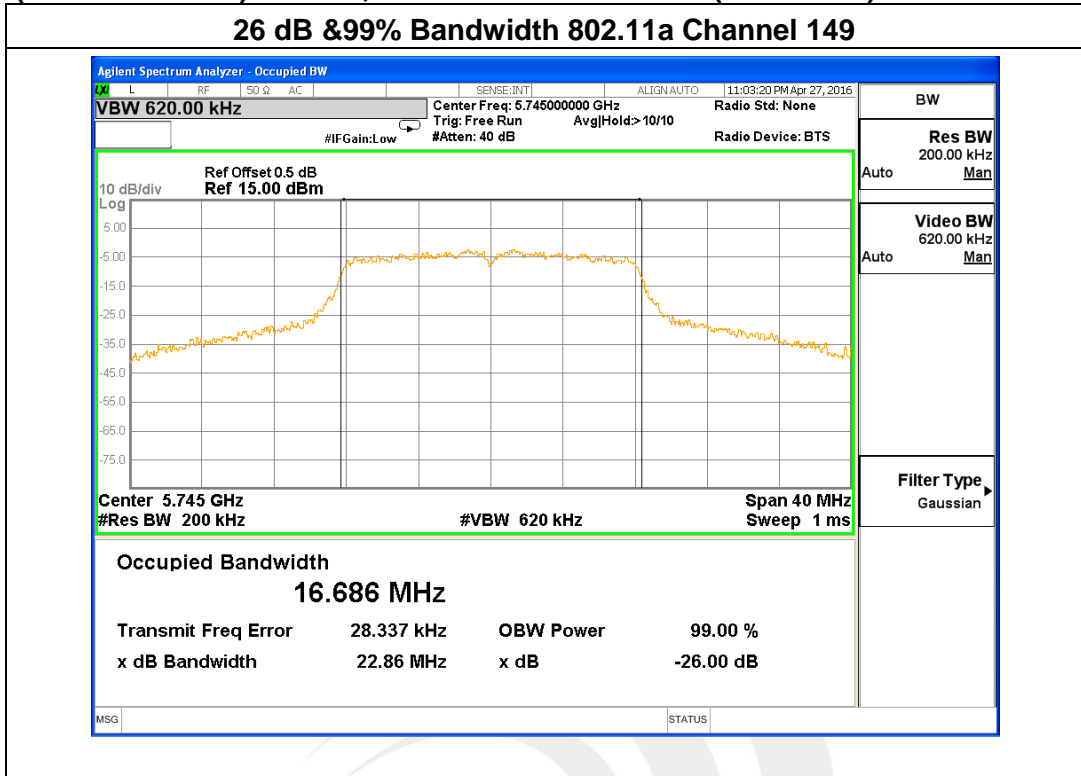



26 dB &99% Bandwidth 802.11a Channel 165

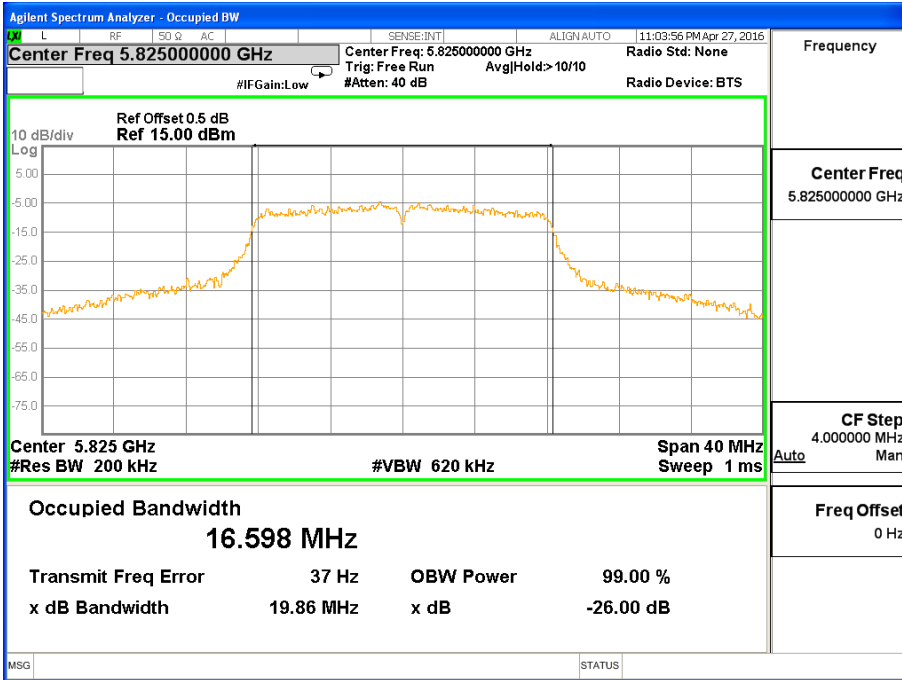



Band IV (5.725-5.850GHz) 802.11n(HT20) 26 dB &99% Bandwidth (Antenna A)

26 dB &99% Bandwidth 802.11n(HT20) Channel 149

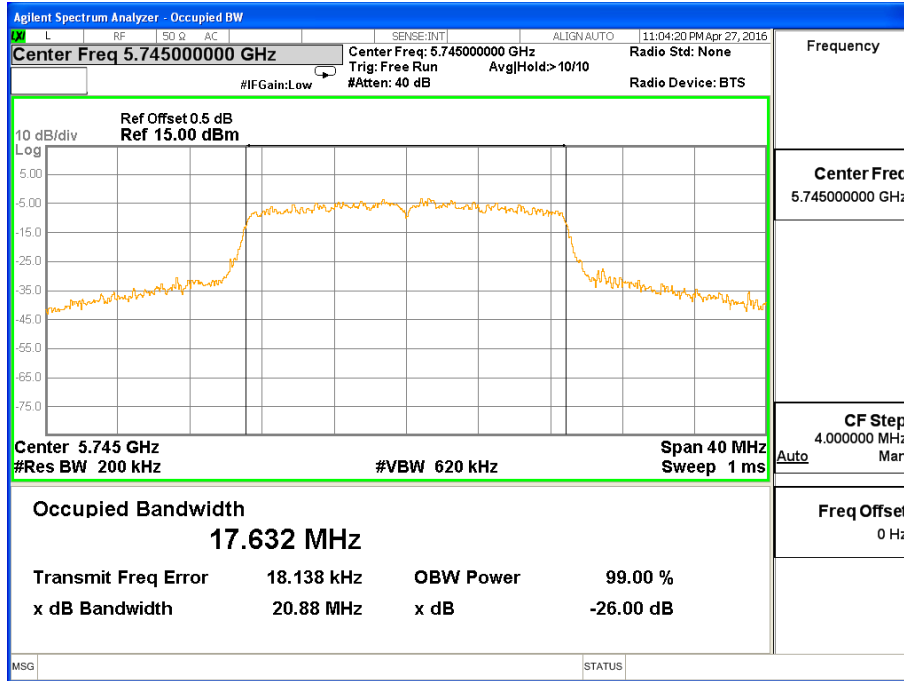

26 dB &99% Bandwidth 802.11n(HT20) Channel 157

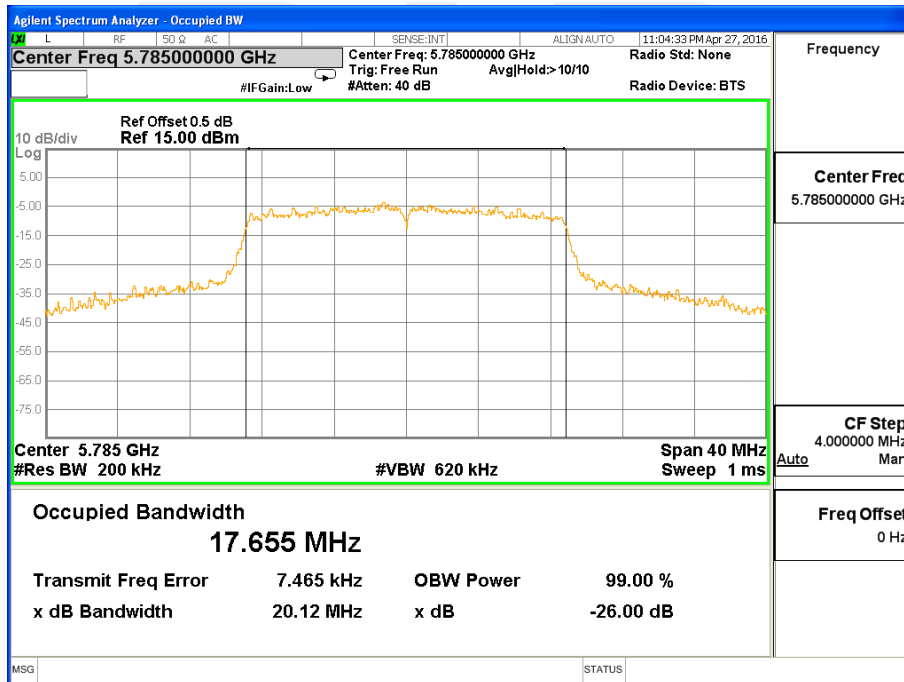



26 dB &99% Bandwidth 802.11n(HT20) Channel 165

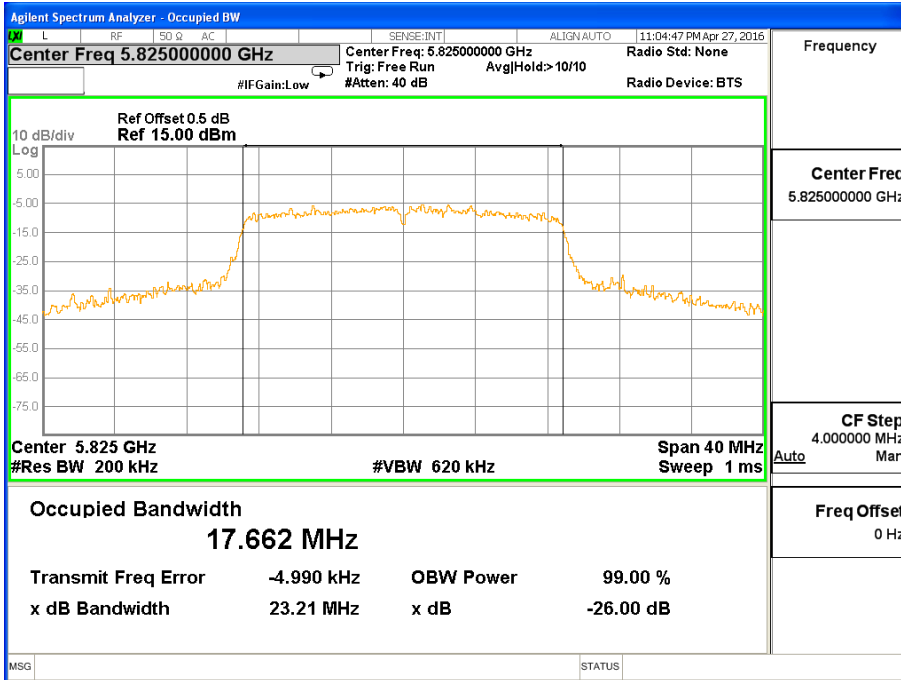



Band IV (5.725-5.850GHz) 802.11n(HT40) 26 dB &99% Bandwidth (Antenna A)

26 dB &99% Bandwidth 802.11n(HT40) Channel 151

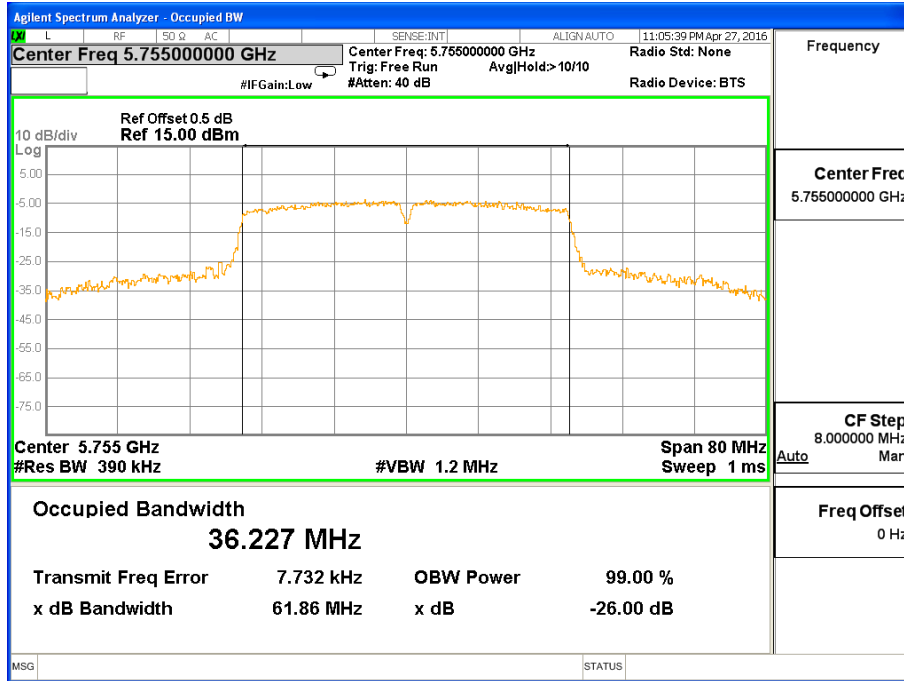

26 dB &99% Bandwidth 802.11n(HT40) Channel 159

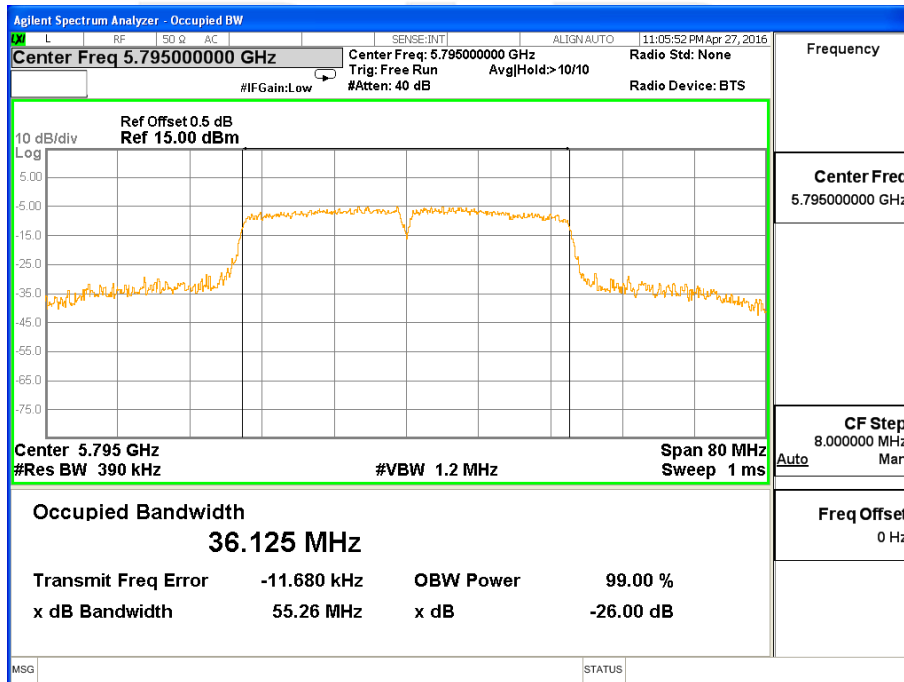



Band IV (5.725-5.850GHz) 802.11a, 6 dB Bandwidth (Antenna A)

6 dB Bandwidth 802.11a Channel 149

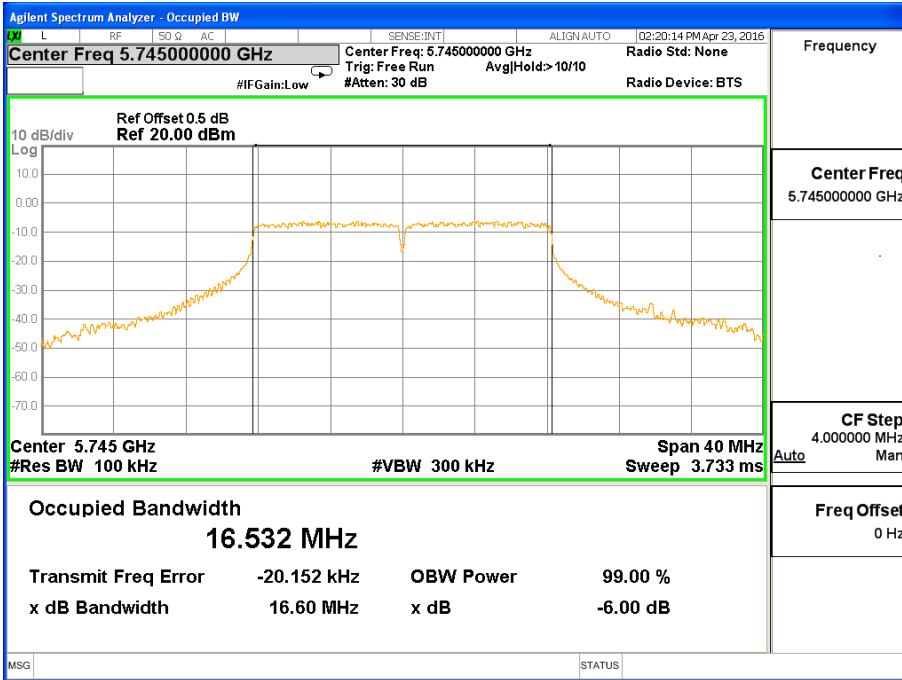

6 dB Bandwidth 802.11a Channel 157

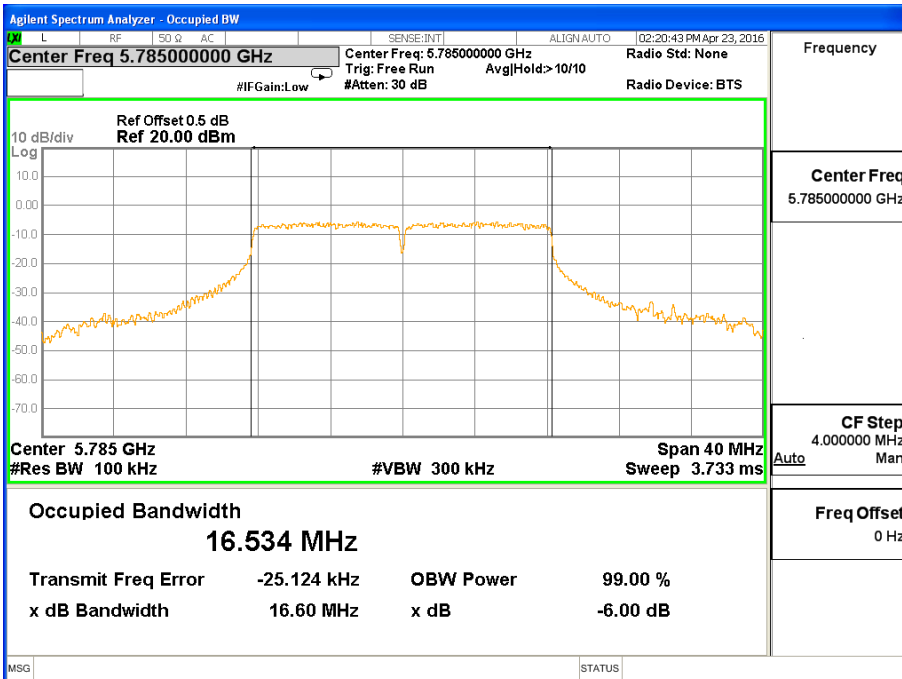



6 dB Bandwidth 802.11a Channel 165

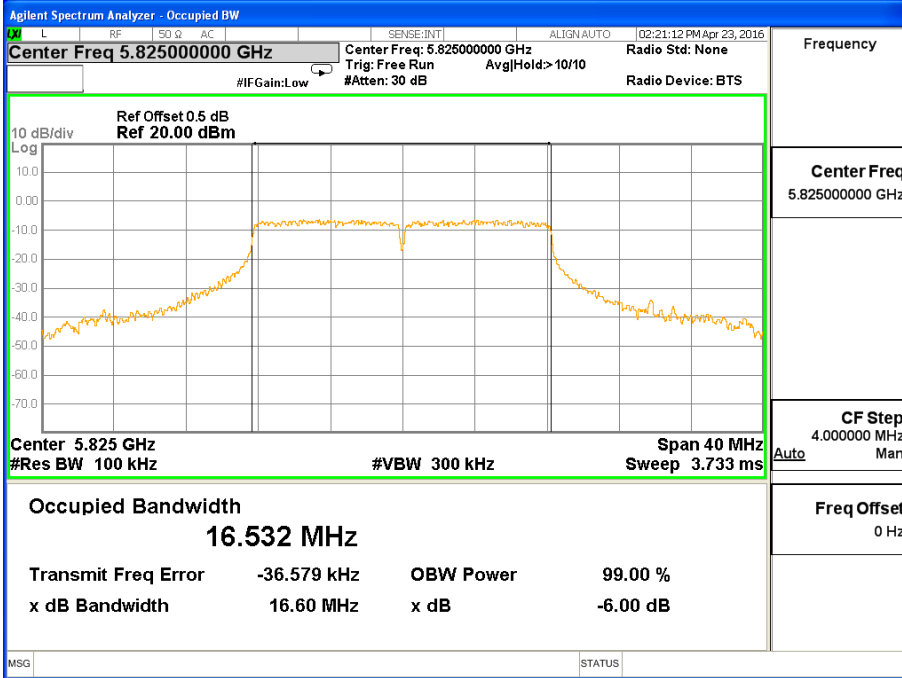



Band IV (5.725-5.850GHz) 802.11n(HT20) 6 dB Bandwidth (Antenna A)

6 dB Bandwidth 802.11n(HT20) Channel 149

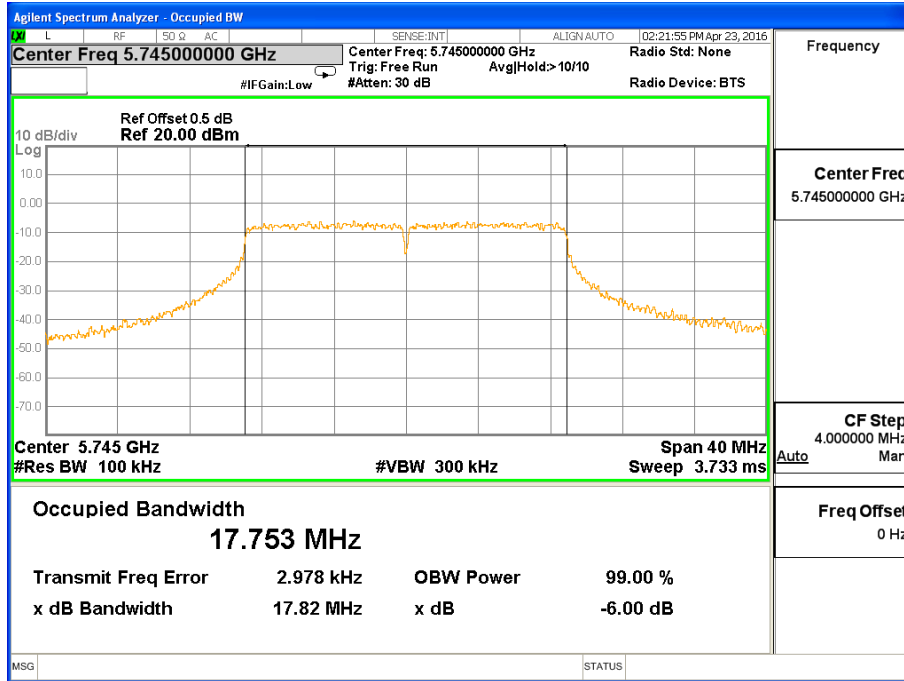

6 dB Bandwidth 802.11n(HT20) Channel 157

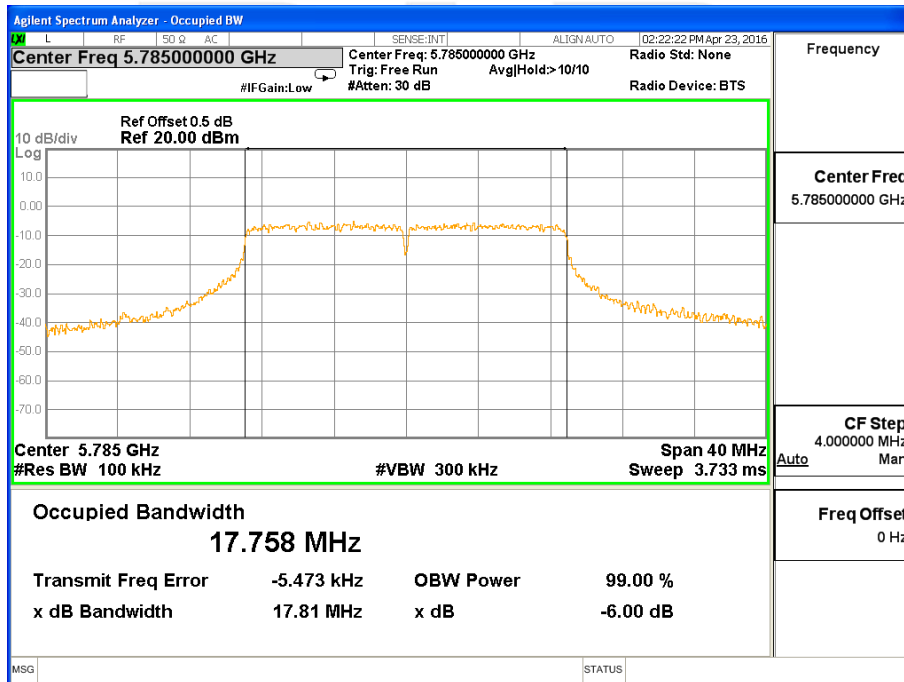



6 dB Bandwidth 802.11n(HT20) Channel 165

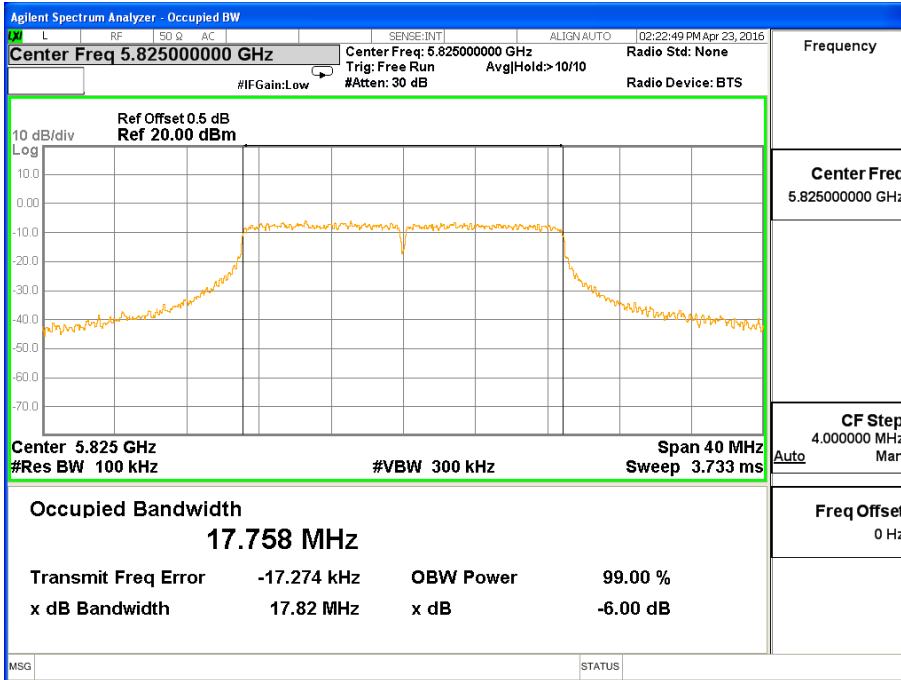



Band IV (5.725-5.850GHz) 802.11n(HT40) 6 dB Bandwidth (Antenna A)

6 dB Bandwidth 802.11n(HT40) Channel 151

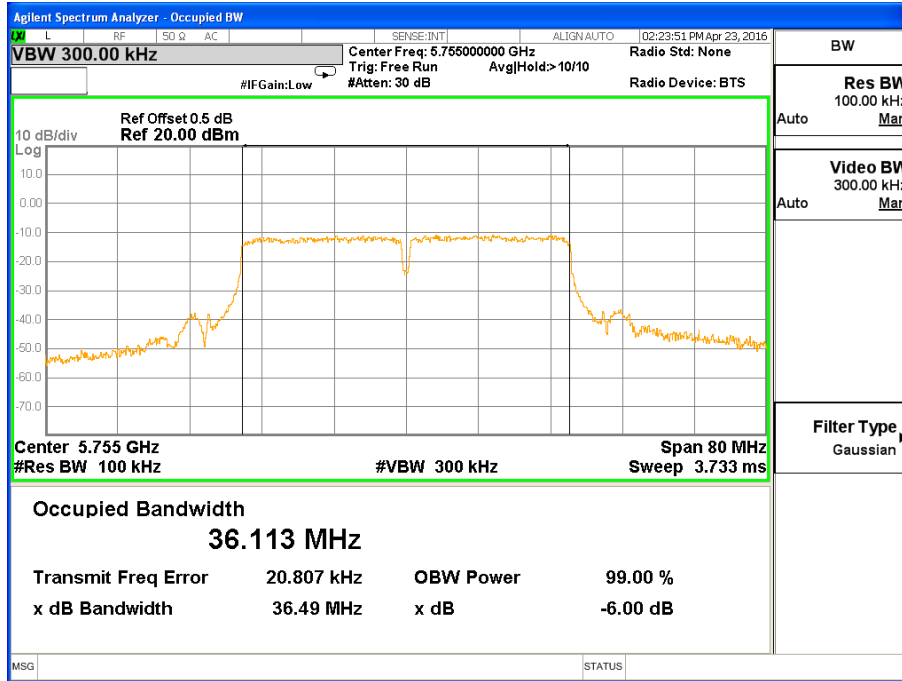

6 dB Bandwidth 802.11n(HT40) Channel 159

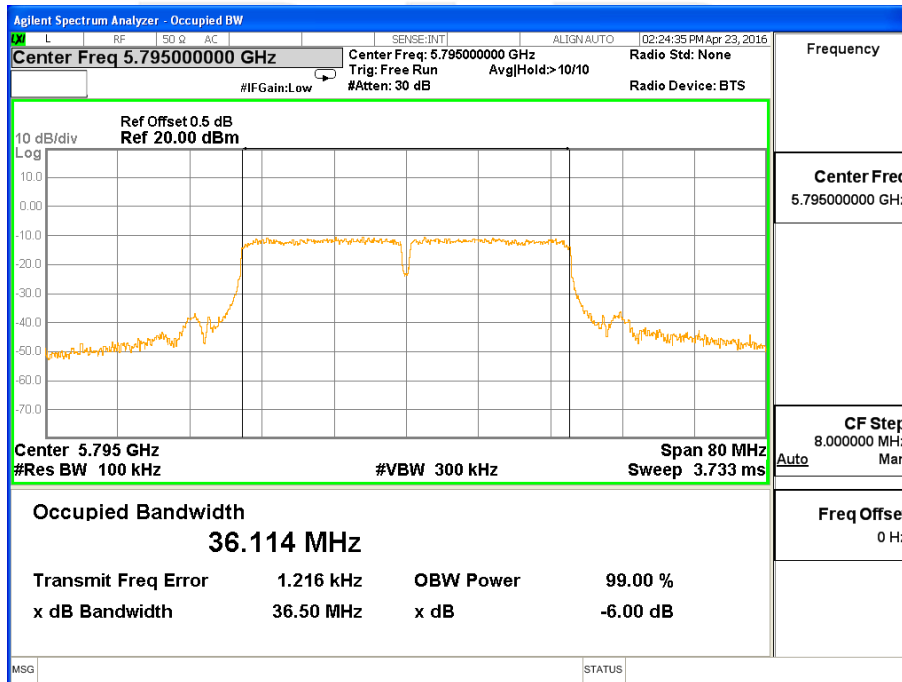

7. MAXIMUM CONDUCTED OUTPUT POWER

7.1 APPLIED PROCEDURES / LIMIT

For mobile and portable client devices in the 5.15-5.25 GHz band, the maximum conducted output power over the frequency band of operation shall not exceed 250 mW provided the maximum antenna gain does not exceed 6 dBi. In addition, the maximum power spectral density shall not exceed 11 dBm in any 1 megahertz band. If transmitting antennas of directional gain greater than 6 dBi are used, both the maximum conducted output power and the maximum power spectral density shall be reduced by the amount in dB that the directional gain of the antenna exceeds 6 dBi.

For the band 5.725-5.85 GHz, the maximum conducted output power over the frequency band of operation shall not exceed 1 W. In addition, the maximum power spectral density shall not exceed 30 dBm in any 500-kHz band. If transmitting antennas of directional gain greater than 6 dBi are used, both the maximum conducted output power and the maximum power spectral density shall be reduced by the amount in dB that the directional gain of the antenna exceeds 6 dBi. However, fixed point-to-point U-NII devices operating in this band may employ transmitting antennas with directional gain greater than 6 dBi without any corresponding reduction in transmitter conducted power. Fixed, point-to-point operations exclude the use of point-to-multipoint systems, omnidirectional applications, and multiple collocated transmitters transmitting the same information. The operator of the U-NII device, or if the equipment is professionally installed, the installer, is responsible for ensuring that systems employing high gain directional antennas are used exclusively for fixed, point-to-point operations.

FCC Part15 (15.407) , Subpart E

Section	Test Item	Limit	Frequency Range (MHz)	Result
15.407(a) (1) (iv)	Peak Output Power	0.25 watt	5150-5250	PASS
15.407(a) (3)		1 watt	5725-5825	

7.1.1 TEST PROCEDURE

The EUT was directly connected to the Power Sensor&PC

7.1.2 DEVIATION FROM STANDARD

No deviation.

7.1.3 TEST SETUP





7.1.4 EUT OPERATION CONDITIONS

The EUT tested system was configured as the statements of 5 Unless otherwise a special operating condition is specified in the follows during the testing.

7.1.5 TEST RESULTS

Band I (5.15-5.25GHz)

Test Channe	Frequency (MHz)	Conducted Output Power PK(dBm) ANT A	Conducted Output Power PK(dBm) ANT B	Conducted Output Power PK(dBm) Total	LIMIT dBm
802.11a					
36	5180	4.25	4.24	7.26	24.00
40	5200	4.35	4.18	7.28	24.00
48	5240	4.32	4.42	7.38	24.00
802.11n(HT20)					
36	5180	4.68	4.52	7.61	24.00
40	5200	4.33	4.47	7.41	24.00
48	5240	4.56	4.71	7.65	24.00
802.11n(HT40)					
38	5190	4.10	4.11	7.12	24.00
46	5230	4.28	4.14	7.22	24.00

Note:

- For mobile and portable client devices in the 5.15-5.25 GHz band, the maximum conducted output power over the frequency band of operation shall not exceed the lesser of 0.25 W.

Band IV (5.725-5.85GHz)

Test Channe	Frequency (MHz)	Conducted Output Power PK(dBm) ANT A	Conducted Output Power PK(dBm) ANT B	Conducted Output Power PK(dBm) Total	LIMIT dBm
802.11a					
149	5745	4.30	4.14	7.23	30.00
157	5785	4.25	4.28	7.28	30.00
161	5825	4.12	4.10	7.12	30.00
802.11n(HT20)					
149	5745	4.00	4.01	7.02	30.00
157	5785	4.15	4.17	7.17	30.00
161	5825	4.12	4.24	7.19	30.00
802.11n(HT40)					
151	5755	3.92	3.45	6.70	30.00
159	5795	3.21	3.41	6.32	30.00

Note:

- For the band 5.745-5.850 GHz, the maximum conducted output power over the frequency band of operation shall not exceed the lesser of 1 W.

8. FREQUENCY STABILITY MEASUREMENT

8.1 LIMIT OF FREQUENCY STABILITY

Manufacturers of U-NII devices are responsible for ensuring frequency stability such that an Emission is maintained within the band of operation under all conditions of normal operation as specified in the user's manual.

8.1.1 MEASURING INSTRUMENTS

See list of measuring instruments of this test report.

8.1.2 TEST PROCEDURES

1. To ensure emission at the band edge is maintained within the authorized band, those values shall be measured by radiation emissions at upper and lower frequency points, and finally compensated by frequency deviation as procedures below.
2. The EUT was operated at the maximum output power, and connected to the spectrum analyzer, which is set to maximum hold function and peak detector. The peak value of the power envelope was measured and noted. The upper and lower frequency points were respectively measured relatively 10dB lower than the measured peak value.
3. The frequency deviation was calculated by adding the upper frequency point and the lower frequency point divided by two. Those detailed values of frequency deviation are provided in table below.

8.1.3 TEST SETUP



**8.1.4 TEST RESULTS**

Voltage	Band I (5.15-5.25GHz) Measurement Frequency(MHz)
DC (V)	5200
4.5	5199.9643
5.0	5199.9441
5.5	5199.9441
Max.Deviation(MHz)	0.0558
Max.Deviation(ppm)	10.7

Temperature Vs. Frequency Stability:

Temperature	Measurement Frequency(MHz)
(°C)	5200
-30	5199.9578
-20	5199.9589
-10	5199.9543
0	5199.9567
10	5199.9568
20	5199.9579
30	5199.9568
40	5199.9579
50	5199.9569
Max.Deviation(MHz)	0.0457
Max.Deviation(ppm)	8.79



Voltage	Band IV (5.725-5.85GHz) Measurement Frequency(MHz)
DC (V)	5785
4.5	5784.9565
5.0	5784.9546
5.5	5784.9532
Max.Deviation(MHz)	0.0468
Max.Deviation(ppm)	9.00

Temperature Vs. Frequency Stability:

Temperature	Measurement Frequency(MHz)
(°C)	5785
-30	5785.9653
-20	5785.9642
-10	5785.9667
0	5785.9648
10	5785.9625
20	5785.9641
30	5785.9667
40	5785.9665
50	5785.9663
Max.Deviation(MHz)	0.9667
Max.Deviation(ppm)	1



9. AUTOMATICALLY DISCONTINUE TRANSMISSION

9.1 LIMIT OF AUTOMATICALLY DISCONTINUE TRANSMISSION

The device shall automatically discontinue transmission in case of either absence of information to transmit or operational failure. These provisions are not intended to preclude the transmission of control or signaling information or the use of repetitive codes used by certain digital technologies to complete frame or burst intervals. Applicants shall include in their application for equipment authorization to describe how this requirement is met.

9.2 TEST RESULT OF AUTOMATICALLY DISCONTINUE TRANSMISSION

During no any information transmission, the EUT can automatically discontinue transmission and become standby mode for power saving. The EUT can detect the controlling signal of ACK message transmitting from remote device and verify whether it shall resend or discontinue transmission





10. ANTENNA REQUIREMENT

10.1 STANDARD REQUIREMENT

15.203 requirement: For intentional device, according to 15.203: an intentional radiator shall be designed to ensure that no antenna other than that furnished by the responsible party shall be used with the device.

10.2 EUT ANTENNA

The EUT antenna is PCB Antenna. It comply with the standard requirement.



APPENDIX - PHOTOS OF TEST SETUP

Radiated Measurement Photos

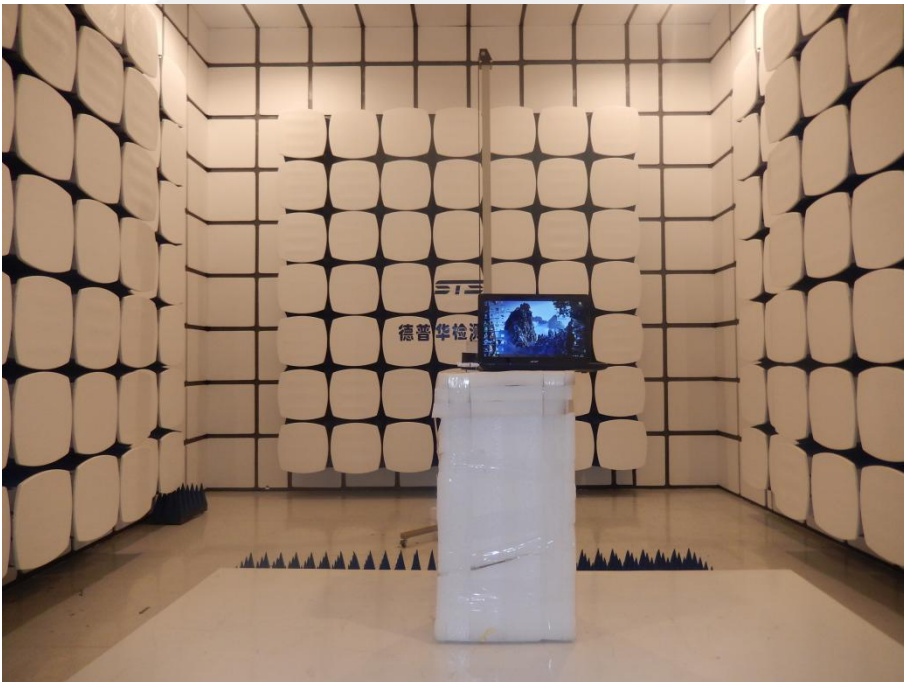
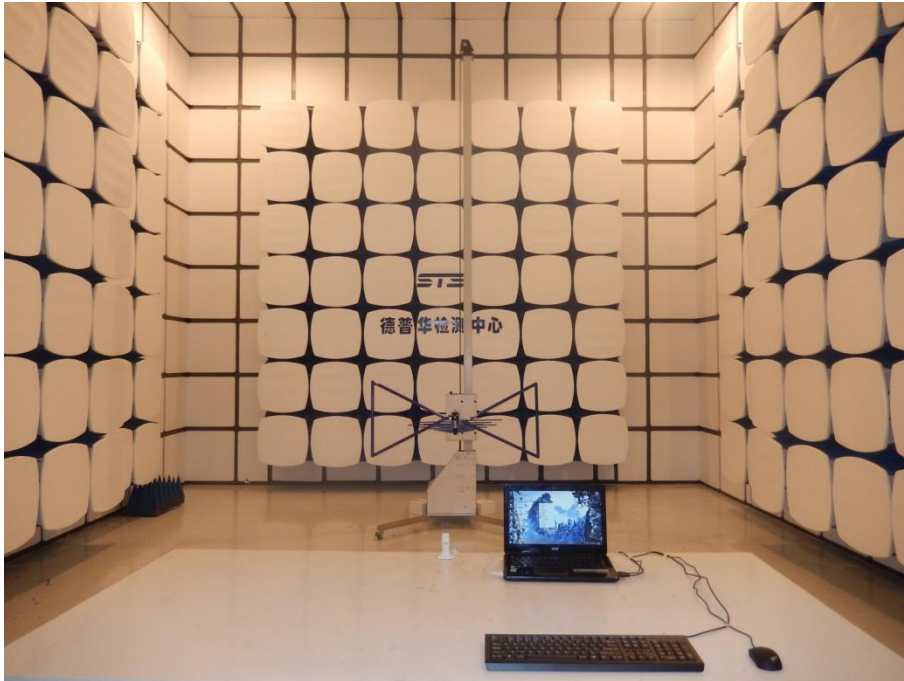

Conducted Measurement Photos

