

S

T

S

L

A

B



# RADIO TEST REPORT

Report No.: STS2111026W02

Issued for

Shenzhen EDUP Electronics Technology Co., Ltd.

6 Floor, #6 Building, No.48, Kangzheng Road Liantang  
Industrial Area, Buji Town, Shenzhen, china

<b>Product Name:</b>	Bluetooth adapter
<b>Brand Name:</b>	EDUP, EDUP LOVE , EPSKY, ISEKIE, Deeyaple, EDUP HOME, WISE TIGER, CardKing, SXUNLIK KWYDYP
<b>Model Name:</b>	EP-B3536
<b>Series Model:</b>	EL-B3536, ES-B3536, EH-B3536, WT-B3536, CK-B3536, BA3536, EP-B3536S, EP-B3536GS
<b>FCC ID:</b>	2AHRDEP-B3536
<b>Test Standard:</b>	FCC Part 15.247

Any reproduction of this document must be done in full. No single part of this document may be reproduced without permission from STS, all test data presented in this report is only applicable to presented test sample.

Shenzhen STS Test Services Co., Ltd.  
A 1/F, Building B, Zhuoke Science Park, No.190 Chongqing Road, HepingShequ,  
Fuyong Sub-District, Bao'an District, Shenzhen, Guang Dong, China  
TEL: +86-755 3688 6288 FAX: +86-755 3688 6277 E-mail:sts@stsapp.com





### TEST RESULT CERTIFICATION

Applicant's Name .....: Shenzhen EDUP Electronics Technology Co., Ltd.  
 Address .....: 6 Floor, #6 Building, No.48, Kangzheng Road Liantang Industrial Area, Buji Town, Shenzhen, china  
 Manufacturer's Name .....: Shenzhen EDUP Electronics Technology Co., Ltd.  
 Address .....: 6 Floor, #6 Building, No.48, Kangzheng Road Liantang Industrial Area, Buji Town, Shenzhen, china

#### Product Description

Product Name .....: Bluetooth adapter  
 Brand Name .....: EDUP, EDUP LOVE , EPSKY, ISEKIE, Deeyaple, EDUP HOME, WISE TIGER. CardKind. SXUNLIK KWYDYP  
 Model Name .....: EP-B3536  
 Series Model .....: EL-B3536, ES-B3536, EH-B3536, WT-B3536, CK-B3536, BA3536, EP-B3536S, EP-B3536GS  
 Test Standards .....: FCC Part15.247  
 Test Procedure .....: ANSI C63.10-2013

This device described above has been tested by STS, the test results show that the equipment under test (EUT) is in compliance with the FCC requirements. And it is applicable only to the tested sample identified in the report.  
 This report shall not be reproduced except in full, without the written approval of STS, this document may be altered or revised by STS, personal only, and shall be noted in the revision of the document.

**Date of Test**.....:  
 Date of receipt of test item.....: 04 Nov. 2021  
 Date (s) of performance of tests.: 04 Nov. 2021 ~ 18 Nov. 2021  
 Date of Issue .....: 18 Nov. 2021  
 Test Result .....: Pass

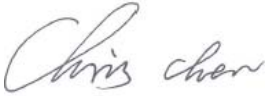
Testing Engineer :   
 \_\_\_\_\_  
 (Chris Chen)

Technical Manager :   
 \_\_\_\_\_  
 (Sean she)

Authorized Signatory :   
 \_\_\_\_\_  
 (Vita Li)





Table of Contents	Page
<b>1. SUMMARY OF TEST RESULTS</b>	<b>6#</b>
1.1 TEST FACTORY	7#
1.2 MEASUREMENT UNCERTAINTY	7#
<b>2. GENERAL INFORMATION</b>	<b>8#</b>
2.1 GENERAL DESCRIPTION OF THE EUT	8#
2.2 DESCRIPTION OF THE TEST MODES	10#
2.3 FREQUENCY HOPPING SYSTEM REQUIREMENTS	10#
2.4 TABLE OF PARAMETERS OF TEST SOFTWARE SETTING	12#
2.5 BLOCK DIAGRAM SHOWING THE CONFIGURATION OF SYSTEM TESTED	12#
2.6 DESCRIPTION OF NECESSARY ACCESSORIES AND SUPPORT UNITS	13#
2.7 EQUIPMENTS LIST	14#
<b>3. EMC EMISSION TEST</b>	<b>16#</b>
3.1 CONDUCTED EMISSION MEASUREMENT	16#
3.2 RADIATED EMISSION MEASUREMENT	20#
<b>4. CONDUCTED SPURIOUS &amp; BAND EDGE EMISSION</b>	<b>32#</b>
4.1 LIMIT	32#
4.2 TEST PROCEDURE	32#
4.3 TEST SETUP	33#
4.4 EUT OPERATION CONDITIONS	33#
4.5 TEST RESULTS	34#
<b>5. NUMBER OF HOPPING CHANNEL</b>	<b>49#</b>
5.1 LIMIT	49#
5.2 TEST PROCEDURE	49#
5.3 TEST SETUP	49#
5.4 EUT OPERATION CONDITIONS	49#
5.5 TEST RESULTS	50#
<b>6. AVERAGE TIME OF OCCUPANCY</b>	<b>51#</b>
6.1 LIMIT	51#
6.2 TEST PROCEDURE	51#
6.3 TEST SETUP	51#
6.4 EUT OPERATION CONDITIONS	51#
6.5 TEST RESULTS	52#
<b>7. HOPPING CHANNEL SEPARATION MEASUREMENT</b>	<b>58#</b>



Table of Contents	Page
7.1 LIMIT	58#
7.2 TEST PROCEDURE	58#
7.3 TEST SETUP	58#
7.4 EUT OPERATION CONDITIONS	58#
7.5 TEST RESULTS	59#
<b>8. BANDWIDTH TEST</b>	<b>65#</b>
8.1 LIMIT	65#
8.2 TEST PROCEDURE	65#
8.3 TEST SETUP	65#
8.4 EUT OPERATION CONDITIONS	65#
8.5 TEST RESULTS	66#
<b>9. OUTPUT POWER TEST</b>	<b>72#</b>
9.1 LIMIT	72#
9.2 TEST PROCEDURE	72#
9.3 TEST SETUP	72#
9.4 EUT OPERATION CONDITIONS	72#
9.5 TEST RESULTS	73#
<b>10. ANTENNA REQUIREMENT</b>	<b>74#</b>
10.1 STANDARD REQUIREMENT	74#
10.2 EUT ANTENNA	74#

**Revision History**

Rev.	Issue Date	Report NO.	Effect Page	Contents
00	18 Nov. 2021	STS2111026W02	ALL	Initial Issue





## 1. SUMMARY OF TEST RESULTS

Test procedures according to the technical standards:  
KDB 558074 D01 15.247 Meas Guidance v05r02.

FCC Part 15.247, Subpart C			
Standard Section	Test Item	Judgment	Remark
15.207	Conducted Emission	PASS	--
15.247(a)(1)	Hopping Channel Separation	PASS	--
15.247(a)(1)&(b)(1)	Output Power	PASS	--
15.209	Radiated Spurious Emission	PASS	--
15.247(d)	Conducted Spurious & Band Edge Emission	PASS	--
15.247(a)(1)(iii)	Number of Hopping Frequency	PASS	--
15.247(a)(1)(iii)	Dwell Time	PASS	--
15.247(a)(1)	Bandwidth	PASS	--
15.205	Restricted bands of operation	PASS	--
Part 15.247(d)/part 15.209(a)	Band Edge Emission	PASS	--
15.203	Antenna Requirement	PASS	--

### NOTE:

- (1) 'N/A' denotes test is not applicable in this Test Report.
- (2) All tests are according to ANSI C63.10-2013.



### 1.1 TEST FACTORY

SHENZHEN STS TEST SERVICES CO., LTD

Add. : A 1/F, Building B, Zhuoke Science Park, No.190 Chongqing Road, HepingShequ, Fuyong Sub-District, Bao'an District, Shenzhen, Guang Dong, China

FCC test Firm Registration Number: 625569

IC test Firm Registration Number: 12108A

A2LA Certificate No.: 4338.01

### 1.2 MEASUREMENT UNCERTAINTY

The reported uncertainty of measurement  $y \pm U$ , where expanded uncertainty  $U$  is based on a standard uncertainty multiplied by a coverage factor of  $k=2$ , providing a level of confidence of approximately **95 %**.

No.	Item	Uncertainty
1	RF output power, conducted	$\pm 0.68\text{dB}$
2	Unwanted Emissions, conducted	$\pm 2.988\text{dB}$
3	All emissions, radiated 9K-30MHz	$\pm 2.84\text{dB}$
4	All emissions, radiated 30M-1GHz	$\pm 4.39\text{dB}$
5	All emissions, radiated 1G-6GHz	$\pm 5.10\text{dB}$
6	All emissions, radiated >6G	$\pm 5.48\text{dB}$
7	Conducted Emission (9KHz-150KHz)	$\pm 2.79\text{dB}$
8	Conducted Emission (150KHz-30MHz)	$\pm 2.80\text{dB}$



## 2. GENERAL INFORMATION

### 2.1 GENERAL DESCRIPTION OF THE EUT

Product Name	Bluetooth adapter
Trade Name	EDUP, EDUP LOVE , EPSKY, ISEKIE, Deeyaple, EDUP HOME, WISE TIGER, CardKing, SXUNLIK KWYDYP
Model Name	EP-B3536
Series Model	EL-B3536, ES-B3536, EH-B3536, WT-B3536, CK-B3536, BA3536, EP-B3536S, EP-B3536GS
Model Difference	The shell is different, everything else is the same
Channel List	Please refer to the Note 2.
Bluetooth	Frequency:2402 – 2480 MHz Modulation: GFSK(1Mbps), $\pi/4$ -DQPSK(2Mbps), 8DPSK(3Mbps)
Bluetooth Version	5.1
Bluetooth Configuration	BR+EDR
Antenna Type	Please refer to the Note 3.
Rating	Input: 5V
Hardware version number	V1.2
Software version number	V1.0
Connecting I/O Port(s)	Please refer to the Note 1.

Note:

1. For a more detailed features description, please refer to the manufacturer's specifications or the User Manual.





2.

Channel List					
Channel	Frequency (MHz)	Channel	Frequency (MHz)	Channel	Frequency (MHz)
00	2402	27	2429	54	2456
01	2403	28	2430	55	2457
02	2404	29	2431	56	2458
03	2405	30	2432	57	2459
04	2406	31	2433	58	2460
05	2407	32	2434	59	2461
06	2408	33	2435	60	2462
07	2409	34	2436	61	2463
08	2410	35	2437	62	2464
09	2411	36	2438	63	2465
10	2412	37	2439	64	2466
11	2413	38	2440	65	2467
12	2414	39	2441	66	2468
13	2415	40	2442	67	2469
14	2416	41	2443	68	2470
15	2417	42	2444	69	2471
16	2418	43	2445	70	2472
17	2419	44	2446	71	2473
18	2420	45	2447	72	2474
19	2421	46	2448	73	2475
20	2422	47	2449	74	2476
21	2423	48	2450	75	2477
22	2424	49	2451	76	2478
23	2425	50	2452	77	2479
24	2426	51	2453	78	2480
25	2427	52	2454		
26	2428	53	2455		

3. Table for Filed Antenna

Ant.	Brand	Model Name	Antenna Type	Connector	Gain (dBi)	NOTE
1	EDUP, EDUP LOVE , EPSKY, ISEKIE, Deeyaple, EDUP HOME, WISE TIGER, CardKing, SXUNLIK KWYDYP	EP-B3536	External	N/A	2dBi	BT Antenna

Note: The antenna information refer the manufacturer provide report, applicable only to the tested sample identified in the report.



## 2.2 DESCRIPTION OF THE TEST MODES

To investigate the maximum EMI emission characteristics generates from EUT, the test system was pre-scanning tested base on the consideration of following EUT operation mode or test configuration mode which possible have effect on EMI emission level. Each of these EUT operation mode(s) or test configuration mode(s) mentioned above was evaluated respectively.

Worst Mode	Description	Data Rate/Modulation
Mode 1	TX CH00	1Mbps/GFSK
Mode 2	TX CH39	1Mbps/GFSK
Mode 3	TX CH78	1Mbps/GFSK
Mode 4	TX CH00	2 Mbps/ $\pi/4$ -DQPSK
Mode 5	TX CH39	2 Mbps/ $\pi/4$ -DQPSK
Mode 6	TX CH78	2 Mbps/ $\pi/4$ -DQPSK
Mode7	TX CH00	3 Mbps/8DPSK
Mode 8	TX CH39	3 Mbps/8DPSK
Mode 9	TX CH78	3 Mbps/8DPSK
Mode 10	Hopping	GFSK
Mode 11	Hopping	$\pi/4$ -DQPSK
Mode 12	Hopping	8DPSK

Note:

(1) The measurements are performed at all Bit Rate of Transmitter, the worst data was reported.

(2) We tested for all available U.S. voltage and frequencies (For 120V, 50/60Hz and 240V, 50/60Hz) for which the device is capable of operation, and the worst case of 120V/ 60Hz is shown in the report.

(3) The battery is fully-charged during the radiated and RF conducted test.

For AC Conducted Emission

Test Case	
AC Conducted Emission	Mode 13 : Keeping BT TX

## 2.3 FREQUENCY HOPPING SYSTEM REQUIREMENTS

(1)Standard and Limit

According to FCC Part 15.247(a)(1), The system shall hop to channel frequencies that are selected at the system hopping rate from a pseudo randomly ordered list of hopping frequencies. Each frequency must be used equally on the average by each transmitter. The system receivers shall have input bandwidths that match the hopping channel bandwidths of their corresponding transmitters and shall shift frequencies in synchronization with the transmitted signals.

Frequency hopping spread spectrum systems are not required to employ all available hopping channels during each transmission. However, the system, consisting of both the transmitter and the receiver, must be designed to comply with all of the regulations in this section should the transmitter be presented with a continuous data (or information) stream. In addition, a system employing short transmission bursts must comply with the definition of a frequency hopping system and must distribute its transmissions over the minimum number of hopping channels specified in this section.

The incorporation of intelligence within a frequency hopping spread spectrum system that permits the system to recognize other users within the spectrum band so that it individually and independently chooses and adapts its hop sets to avoid hopping on occupied channels is permitted. The coordination of frequency hopping systems in any other manner for the express purpose of avoiding the simultaneous occupancy of individual hopping frequencies by multiple transmitters is not permitted.

(2)The Pseudorandom sequence may be generated in a nine-stage shift register whose 5<sup>th</sup> and 9<sup>th</sup> stage outputs are added in a modulo-two addition stage. And the result is fed back to the input of the first stage. The sequence begins with the first one of 9 consecutive ones: i.e. the shift register is initialized with nine ones.

Number of shift register stages:9

Length of pseudo-random sequence: $2^9-1=511$ bits

Longest sequence of zeros: 8(non-inverted signal)

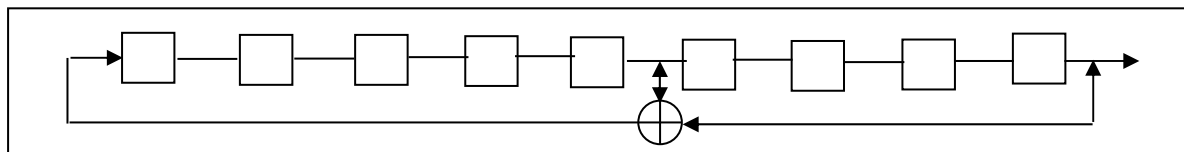

Linear Feedback Shift Register for Generator of the PRBS sequence

An example of Pseudorandom Frequency Hopping Sequence as follow:

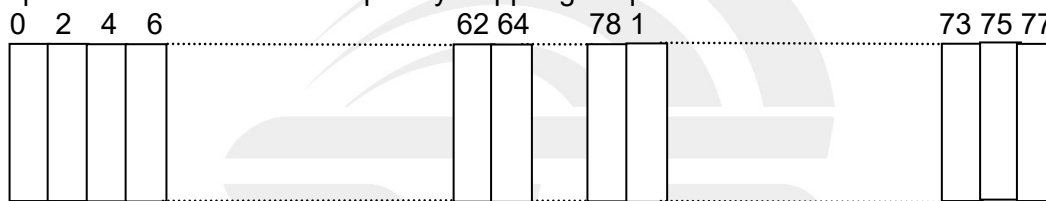

Each frequency used equally on the average by each transmitter.

The system receivers have input bandwidths that match the hopping channel bandwidths of their corresponding transmitters and shift frequencies in synchronization with the transmitted signals.

### (3)Frequency Hopping System

This transmitter device is frequency hopping device, and complies with FCC part 15.247 rule.

This device uses Bluetooth radio which operates in 2400-2483.5 MHz band. Bluetooth uses a radio technology called frequency-hopping spread spectrum, which chops up the data being sent and transmits chunks of it on up to 79 bands (1 MHz each; centred from 2402 to 2480 MHz) in the range 2,400-2,483.5MHz. The transmitter switches hop frequencies 1,600 times per second to assure a high degree of data security. All Bluetooth devices participating in a given piconet are synchronized to the frequency-hopping channel for the piconet. The frequency hopping sequence is determined by the master's device address and the phase of the hopping sequence (the frequency to hop at a specific time) is determined by the master's internal clock. Therefore, all slaves in a piconet must know the master's device address and must synchronize their clocks with the master's clock.

Adaptive Frequency Hopping (AFH) was introduced in the Bluetooth specification to provide an effective way for a Bluetooth radio to counteract normal interference. AFH identifies "bad" channels, where either other wireless devices are interfering with the Bluetooth signal or the Bluetooth signal is interfering with another device. The AFH-enabled Bluetooth device will then communicate with other devices within its piconet to share details of any identified bad channels. The devices will then switch to alternative available "good" channels, away from the areas of interference, thus having no impact on the bandwidth used.

This device was tested with a bluetooth system receiver to check that the device maintained hopping synchronization, and the device complied with these requirements FCC Part 15.247 rule.



### 2.4 TABLE OF PARAMETERS OF TEST SOFTWARE SETTING

During testing channel & power controlling software provided by the customer was used to control the operating channel as well as the output power level. The RF output power selection is for the setting of RF output power expected by the customer and is going to be fixed on the firmware of the final end product power parameters of FHSS.

Test software Version	Test program: Bluetooth		
(Power control software) Parameters(1/2/3Mbps)	Power class: DH1 rate:4:27 2DH1 rate:20:54 3DH1 rate:24:83	Power class: DH3 rate:11:183 2DH3 rate:26:367 3DH3 rate:27:552	Power class: DH5 rate:15:339 2DH5 rate:30:679 3DH5 rate:31:1021

RF Function	Type	Mode Or Modulation type	ANT Gain(dBi)	Power Class	Software For Testing
BT	BR+EDR	GFSK	2	default	RTLBTAPP
		$\pi/4$ -DQPSK	2	default	
		8DPSK	2	default	

### 2.5 BLOCK DIAGRAM SHOWING THE CONFIGURATION OF SYSTEM TESTED

#### Radiated Spurious Emission Test

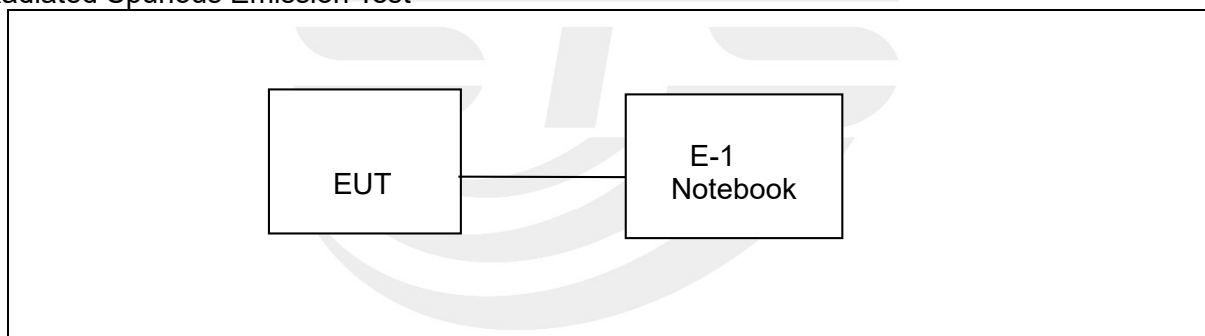

#### Conducted Emission Test

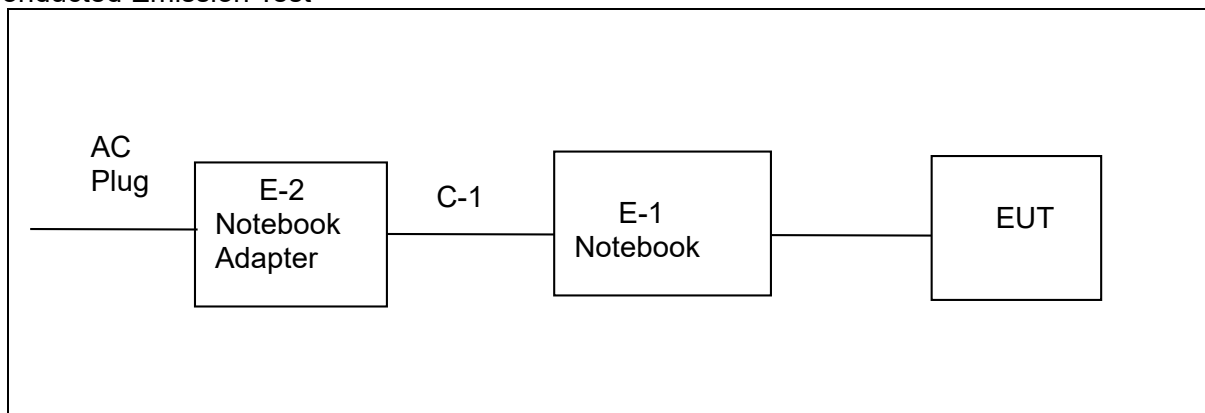



## 2.6 DESCRIPTION OF NECESSARY ACCESSORIES AND SUPPORT UNITS

The EUT has been tested as an independent unit together with other necessary accessories or support units. The following support units or accessories were used to form a representative test configuration during the tests.

### Necessary accessories

Item	Equipment	Mfr/Brand	Model/Type No.	Length	Note
N/A	N/A	N/A	N/A	N/A	N/A

### Support units

Item	Equipment	Mfr/Brand	Model/Type No.	Length	Note
E-2	Notebook Adapter	DELL	HSTNN-CA15	N/A	N/A
E-1	Notebook	DELL	500-320cx	N/A	N/A
C-1	DC Cable	N/A	N/A	110cm	NO

#### Note:

- (1) For detachable type I/O cable should be specified the length in cm in 『Length』 column.
- (2) “YES” is means “with core”; “NO” is means “without core”.



## 2.7 EQUIPMENTS LIST

## Radiation Test equipment

Kind of Equipment	Manufacturer	Type No.	Serial No.	Last calibration	Calibrated until
Test Receiver	R&S	ESCI	101427	2021.09.30	2022.09.29
Signal Analyzer	R&S	FSV 40-N	101823	2021.09.30	2022.09.29
Active loop Antenna	ZHINAN	ZN30900C	16035	2021.04.11	2023.04.10
Bilog Antenna	TESEQ	CBL6111D	34678	2020.10.12	2022.10.11
Horn Antenna	SCHWARZBECK	BBHA 9120D	02014	2021.10.11	2023.10.10
SHF-EHF Horn Antenna (18G-40GHz)	A-INFO	LB-180400-KF	J211020657	2020.10.12	2022.10.11
Pre-Amplifier (0.1M-3GHz)	EM	EM330	060665	2021.10.08	2022.10.07
Pre-Amplifier (1G-18GHz)	SKET	LNPA-01018G-45	SK2018080901	2021.09.30	2022.09.29
Pre-Amplifier (18G-40GHz)	SKET	LNPA-1840-50	SK2018101801	2021.09.28	2022.09.27
Temperature & Humidity	HH660	Mieo	N/A	2021.10.09	2022.10.08
Turn table	EM	SC100_1	60531	N/A	N/A
Antenna mast	EM	SC100	N/A	N/A	N/A
Test SW	FARAD	EZ-EMC(Ver.STSLAB-03A1 RE)			

## Conduction Test equipment

Kind of Equipment	Manufacturer	Type No.	Serial No.	Last calibration	Calibrated until
Test Receiver	R&S	ESCI	101427	2021.09.30	2022.09.29
LISN	R&S	ENV216	101242	2021.09.30	2022.09.29
LISN	EMCO	3810/2NM	23625	2021.09.30	2022.09.29
Temperature & Humidity	HH660	Mieo	N/A	2021.10.09	2022.10.08
Test SW	FARAD	EZ-EMC(Ver.STSLAB-03A1 RE)			



## RF Connected Test

Kind of Equipment	Manufacturer	Type No.	Serial No.	Last calibration	Calibrated until
Power Sensor	Keysight	U2021XA	MY55520005	2021.09.30	2022.09.29
			MY55520006	2021.09.30	2022.09.29
			MY56120038	2021.09.30	2022.09.29
			MY56280002	2021.09.30	2022.09.29
Signal Analyzer	Agilent	N9020A	MY51110105	2021.03.04	2022.03.03
Temperature & Humidity	HH660	Mieo	N/A	2021.10.09	2022.10.08
Test SW	FARAD	EZ-EMC(Ver.STSLAB-03A1 RE)			





### 3. EMC EMISSION TEST

#### 3.1 CONDUCTED EMISSION MEASUREMENT

##### 3.1.1 POWER LINE CONDUCTED EMISSION LIMITS

The radio frequency voltage that is conducted back onto the AC power line on any frequency or frequencies, within the band 150 kHz to 30 MHz, shall not exceed the limits in the following table.

FREQUENCY (MHz)	Conducted Emissionlimit (dBuV)	
	Quasi-peak	Average
0.15 -0.5	66 - 56 *	56 - 46 *
0.50 -5.0	56.00	46.00
5.0 -30.0	60.00	50.00

Note:

- (1) The tighter limit applies at the band edges.
- (2) The limit of “ \* ” marked band means the limitation decreases linearly with the logarithm of the frequency in the range.

The following table is the setting of the receiver

Receiver Parameters	Setting
Attenuation	10 dB
Start Frequency	0.15 MHz
Stop Frequency	30 MHz
IF Bandwidth	9 kHz



### 3.1.2 TEST PROCEDURE

- a. The EUT is 0.8 m from the horizontal ground plane and 0.4 m from the vertical ground plane with EUT being connected to the power mains through a line impedance stabilization network (LISN). All other support equipments are powered from additional LISN(s). The LISN provides 50 Ohm/ 50uH of coupling impedance for the measuring instrument.
- b. Interconnecting cables that hang closer than 40 cm to the ground plane shall be folded back and forth in the center forming a bundle 30 to 40 cm long.
- c. I/O cables that are not connected to a peripheral shall be bundled in the center. The end of the cable may be terminated, if required, using the correct terminating impedance. The overall length shall not exceed 1 m.
- d. LISN is at least 80 cm from the nearest part of EUT chassis.
- e. For the actual test configuration, please refer to the related Item –EUT Test Photos.

### 3.1.3 TEST SETUP

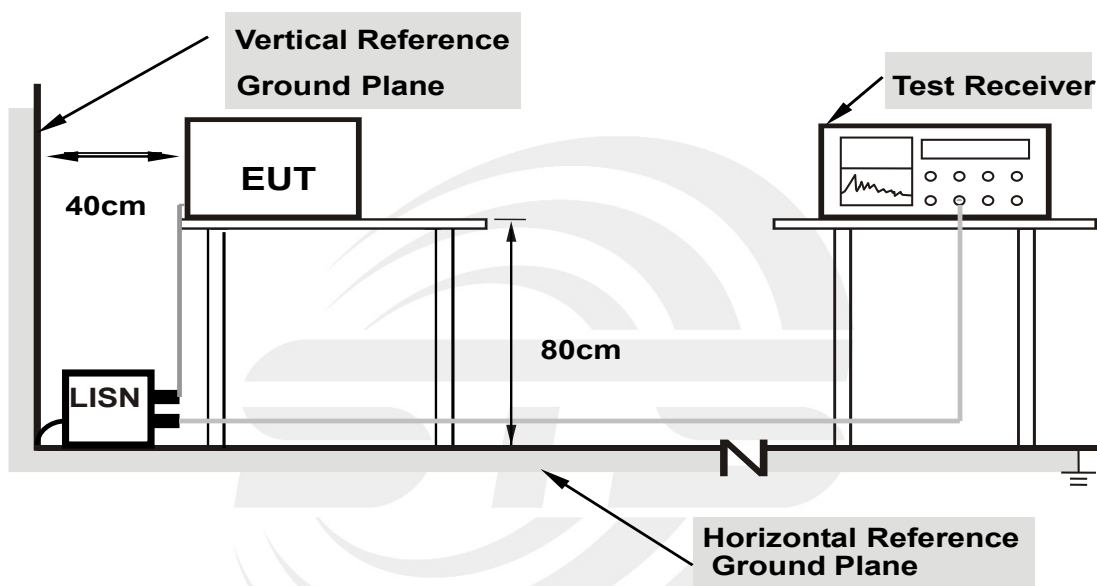

- Note: 1. Support units were connected to second LISN.**
- 2. Both of LISNs (AMN) are 80 cm from EUT and at least 80 cm from other units and other metal planes support units.**

### 3.1.4 EUT OPERATING CONDITIONS

The EUT was configured for testing in a typical fashion (as a customer would normally use it). The EUT has been programmed to continuously transmit during test. This operating condition was tested and used to collect the included data.



3.1.5 TEST RESULT

Temperature:	26.7(C)	Relative Humidity:	45%RH
Test Voltage:	AC 120V/60Hz	Phase:	L
Test Mode:	Mode 13		

No.	Frequency (MHz)	Reading (dBUV)	Correct Factor(dB)	Result (dBUV)	Limit (dBUV)	Margin (dB)	Remark
1	0.1500	34.73	20.33	55.06	66.00	-10.94	QP
2	0.1500	13.40	20.33	33.73	56.00	-22.27	AVG
3	0.4660	13.63	20.54	34.17	56.58	-22.41	QP
4	0.4660	2.76	20.54	23.30	46.58	-23.28	AVG
5	1.8980	17.90	20.30	38.20	56.00	-17.80	QP
6	1.8980	9.88	20.30	30.18	46.00	-15.82	AVG
7	4.3380	10.11	20.42	30.53	56.00	-25.47	QP
8	4.3380	-2.09	20.42	18.33	46.00	-27.67	AVG
9	8.1940	8.03	20.82	28.85	60.00	-31.15	QP
10	8.1940	-2.23	20.82	18.59	50.00	-31.41	AVG
11	20.8860	8.14	22.85	30.99	60.00	-29.01	QP
12	20.8860	-2.35	22.85	20.50	50.00	-29.50	AVG

Remark:

1. All readings are Quasi-Peak and Average values
2. Margin = Result (Result = Reading + Factor )–Limit
3. Factor=LISN factor+Cable loss+Limiter (10dB)

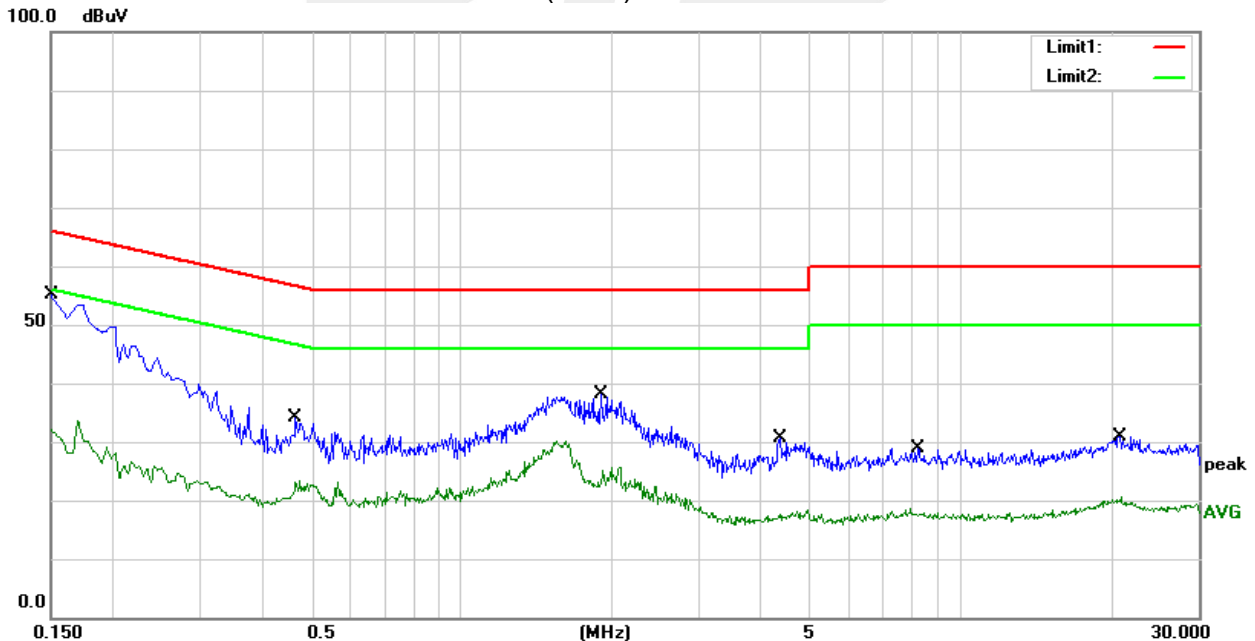



Temperature:	26.7(C)	Relative Humidity:	45%RH
Test Voltage:	AC 120V/60Hz	Phase:	N
Test Mode:	Mode 13		

No.	Frequency (MHz)	Reading (dBuV)	Correct Factor(dB)	Result (dBuV)	Limit (dBuV)	Margin (dB)	Remark
1	0.1500	35.46	20.33	55.79	66.00	-10.21	QP
2	0.1500	14.46	20.33	34.79	56.00	-21.21	AVG
3	0.1940	31.73	20.31	52.04	63.86	-11.82	QP
4	0.1940	12.25	20.31	32.56	53.86	-21.30	AVG
5	0.5660	15.76	20.48	36.24	56.00	-19.76	QP
6	0.5660	5.51	20.48	25.99	46.00	-20.01	AVG
7	1.5940	19.39	20.30	39.69	56.00	-16.31	QP
8	1.5940	11.03	20.30	31.33	46.00	-14.67	AVG
9	2.0980	18.56	20.30	38.86	56.00	-17.14	QP
10	2.0980	8.25	20.30	28.55	46.00	-17.45	AVG
11	4.7860	12.24	20.45	32.69	56.00	-23.31	QP
12	4.7860	0.69	20.45	21.14	46.00	-24.86	AVG

Remark:

1. All readings are Quasi-Peak and Average values
2. Margin = Result (Result = Reading + Factor) – Limit
3. Factor=LISN factor+Cable loss+Limiter (10dB)

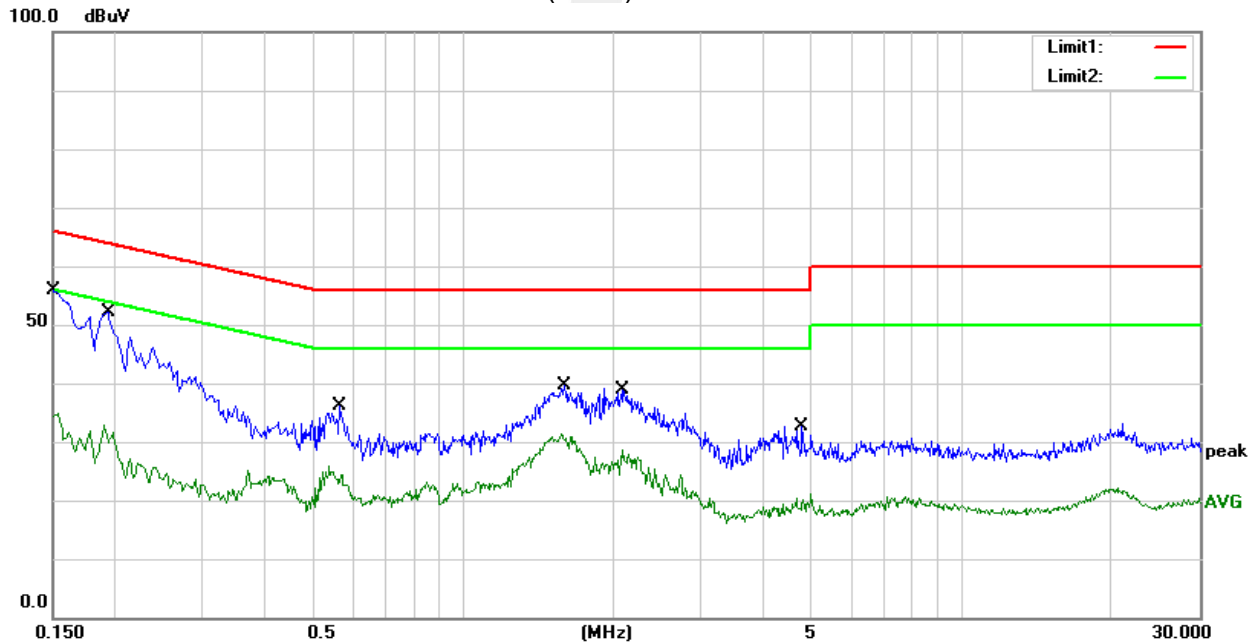



3.2 RADIATED EMISSION MEASUREMENT

3.2.1 RADIATED EMISSION LIMITS

In any 100 kHz bandwidth outside the operating frequency band. In case the emission fall within the Restricted band specified on Part15.205 (a)&209(a) limit in the table and according to ANSI C63.10-2013 below has to be followed.

LIMITS OF RADIATED EMISSION MEASUREMENT (0.009MHz - 1000MHz)

Frequencies (MHz)	Field Strength (micorvolts/meter)	Measurement Distance (meters)
0.009~0.490	2400/F(KHz)	300
0.490~1.705	24000/F(KHz)	30
1.705~30.0	30	30
30~88	100	3
88~216	150	3
216~960	200	3
Above 960	500	3

LIMITS OF RADIATED EMISSION MEASUREMENT (1GHz-25 GHz)

FREQUENCY (MHz)	(dBuV/m) (at 3M)	
	PEAK	AVERAGE
Above 1000	74	54

Notes:

- (1) The limit for radiated test was performed according to FCC PART 15C.
- (2) The tighter limit applies at the band edges.
- (3) Emission level (dBuV/m)=20log Emission level (uV/m).

LIMITS OF RESTRICTED FREQUENCY BANDS

FREQUENCY (MHz)	FREQUENCY (MHz)	FREQUENCY (MHz)	FREQUENCY (GHz)
0.090-0.110	16.42-16.423	399.9-410	4.5-5.15
0.495-0.505	16.69475-16.69525	608-614	5.35-5.46
2.1735-2.1905	16.80425-16.80475	960-1240	7.25-7.75
4.125-4.128	25.5-25.67	1300-1427	8.025-8.5
4.17725-4.17775	37.5-38.25	1435-1626.5	9.0-9.2
4.20725-4.20775	73-74.6	1645.5-1646.5	9.3-9.5
6.215-6.218	74.8-75.2	1660-1710	10.6-12.7
6.26775-6.26825	108-121.94	1718.8-1722.2	13.25-13.4
6.31175-6.31225	123-138	2200-2300	14.47-14.5
8.291-8.294	149.9-150.05	2310-2390	15.35-16.2
8.362-8.366	156.52475-156.52525	2483.5-2500	17.7-21.4
8.37625-8.38675	156.7-156.9	2690-2900	22.01-23.12
8.41425-8.41475	162.0125-167.17	3260-3267	23.6-24.0
12.29-12.293	167.72-173.2	3332-3339	31.2-31.8
12.51975-12.52025	240-285	3345.8-3358	36.43-36.5
12.57675-12.57725	322-335.4	3600-4400	Above 38.6
13.36-13.41			



For Radiated Emission

Spectrum Parameter	Setting
Attenuation	Auto
Detector	Peak/QP/AV
Start Frequency	9 KHz/150KHz(Peak/QP/AV)
Stop Frequency	150KHz/30MHz(Peak/QP/AV)
RB / VB (emission in restricted band)	200Hz (From 9kHz to 0.15MHz)/ 9KHz (From 0.15MHz to 30MHz); 200Hz (From 9kHz to 0.15MHz)/ 9KHz (From 0.15MHz to 30MHz)

Spectrum Parameter	Setting
Attenuation	Auto
Detector	Peak/QP
Start Frequency	30 MHz(Peak/QP)
Stop Frequency	1000 MHz (Peak/QP)
RB / VB (emission in restricted band)	120 KHz / 300 KHz

Spectrum Parameter	Setting
Attenuation	Auto
Detector	Peak/AV
Start Frequency	1000 MHz(Peak/AV)
Stop Frequency	10th carrier hamonic(Peak/AV)
RB / VB (emission in restricted band)	1 MHz / 3 MHz(Peak) 1 MHz/1/T MHz(AVG)

For Restricted band

Spectrum Parameter	Setting
Detector	Peak/AV
Start/Stop Frequency	Lower Band Edge: 2310 to 2410 MHz Upper Band Edge: 2476 to 2500 MHz
RB / VB	1 MHz / 3 MHz(Peak) 1 MHz/1/T MHz(AVG)



Receiver Parameter	Setting
Attenuation	Auto
Start ~ Stop Frequency	9kHz~90kHz / RB 200Hz for PK & AV
Start ~ Stop Frequency	90kHz~110kHz / RB 200Hz for QP
Start ~ Stop Frequency	110kHz~490kHz / RB 200Hz for PK & AV
Start ~ Stop Frequency	490kHz~30MHz / RB 9kHz for QP
Start ~ Stop Frequency	30MHz~1000MHz / RB 120kHz for QP

### 3.2.2 TEST PROCEDURE

- The measuring distance at 3 m shall be used for measurements at frequency 0.009MHz up to 1GHz, and above 1GHz.
- The EUT was placed on the top of a rotating table 0.8 m (above 1GHz is 1.5 m) above the ground at a 3 m anechoic chamber test site. The table was rotated 360 degree to determine the position of the highest radiation.
- The height of the equipment shall be 0.8 m (above 1GHz is 1.5 m); the height of the test antenna shall vary between 1 m to 4 m. Horizontal and vertical polarization of the antenna are set to make the measurement.
- The initial step in collecting conducted emission data is a spectrum analyzer peak detector mode pre-scanning the measurement frequency range. Significant peaks are then marked and QuasiPeak detector mode will be re-measured.
- If the Peak Mode measured value is compliance with and lower than Quasi Peak Mode Limit, the EUT shall be deemed to meet QP Limits and no additional QP Mode measurement was performed.
- For the actual test configuration, please refer to the related Item –EUT Test Photos.

Note:

Both horizontal and vertical antenna polarities were tested and performed pretest to three orthogonal axis. The worst case emissions were reported.

### 3.2.3 DEVIATION FROM TEST STANDARD

No deviation.

### 3.2.4 TESTSETUP

#### (A) Radiated Emission Test-Up Frequency Below 30MHz

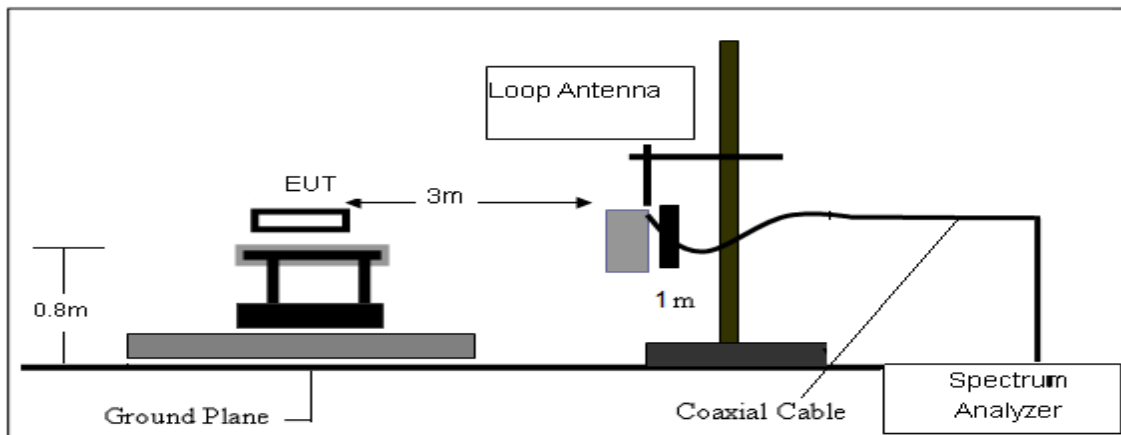

#### (B) Radiated Emission Test-Up Frequency 30MHz~1GHz

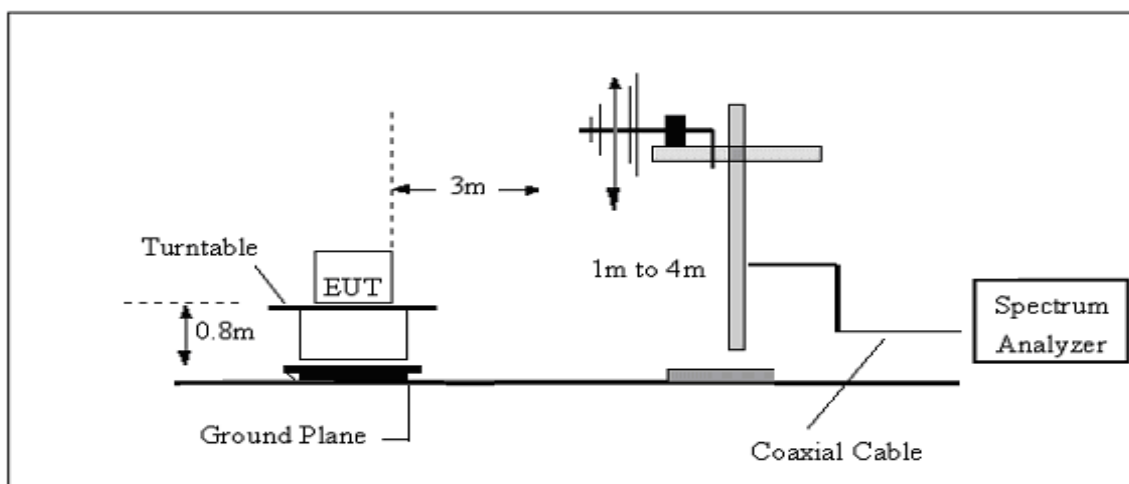

#### (C) Radiated Emission Test-Up Frequency Above 1GHz

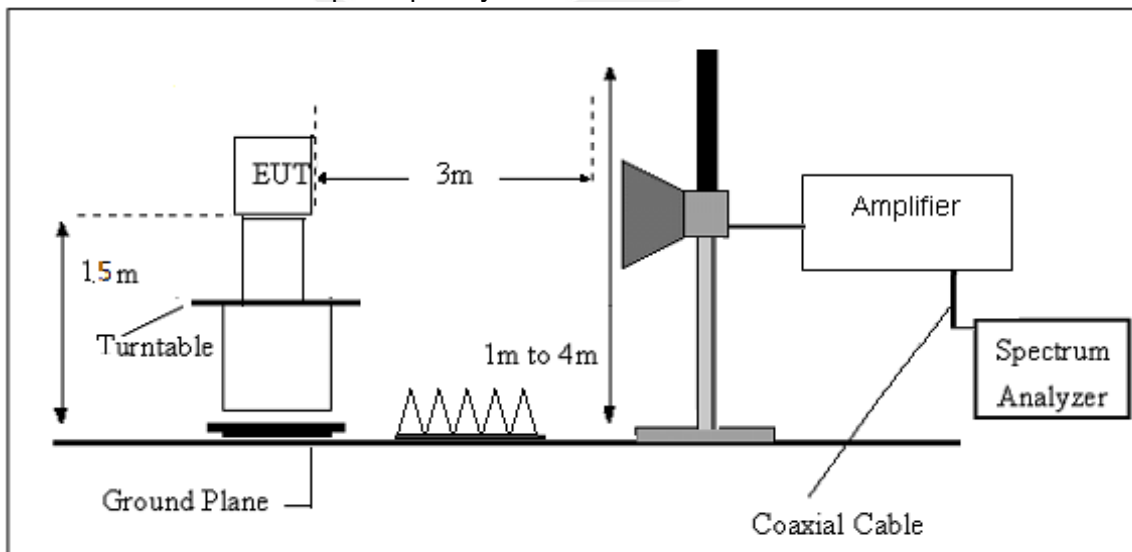

### 3.2.5 EUT OPERATING CONDITIONS

Please refer to section 3.1.4 of this report.



### 3.2.6 FIELD STRENGTH CALCULATION

The field strength is calculated by adding the Antenna Factor and Cable Factor and subtracting the Amplifier Gain and Duty Cycle Correction Factor (if any) from the measured reading. The basic equation with a sample calculation is as follows:

$$FS = RA + AF + CL - AG$$

Where

FS = Field Strength

CL = Cable Attenuation Factor (Cable Loss)

RA = Reading Amplitude

AG = Amplifier Gain

AF = Antenna Factor

For example

Frequency (MHz)	FS (dB $\mu$ V/m)	RA (dB $\mu$ V/m)	AF (dB)	CL (dB)	AG (dB)	Factor (dB)
300	40	58.1	12.2	1.6	31.9	-18.1

$$\text{Factor} = \text{AF} + \text{CL} - \text{AG}$$







## 3.2.7 TEST RESULTS

(9KHz-30MHz)

Temperature:	23.1(C)	Relative Humidity:	60%RH
Test Voltage:	DC 5V	Test Mode:	TX Mode

Freq. (MHz)	Reading (dBuV/m)	Limit (dBuV/m)	Margin (dB)	State P/F	Test Result
--	--	--	--	--	PASS
--	--	--	--	--	PASS

## Note:

The amplitude of spurious emissions which are attenuated by more than 20dB below the permissible value has no need to be reported.

Distance extrapolation factor =  $40 \log(\text{specific distance}/\text{test distance})$ (dB);

Limit line = specific limits (dBuV) + distance extrapolation factor.



(30MHz-1000MHz)

Temperature:	23.1(C)	Relative Humidity:	60%RH
Test Voltage:	DC 5V	Phase:	Horizontal
Test Mode:	Mode 1/2/3/4/5/6/7/8/9(Mode 8 worst mode)		

No.	Frequency (MHz)	Reading (dBuV)	Correct Factor(dB/m)	Result (dBuV/m)	Limit (dBuV/m)	Margin (dB)	Remark
1	119.2400	32.64	-18.38	14.26	43.50	-29.24	QP
2	408.3000	36.12	-10.66	25.46	46.00	-20.54	QP
3	551.8600	37.73	-5.72	32.01	46.00	-13.99	QP
4	733.2500	30.06	-2.35	27.71	46.00	-18.29	QP
5	860.3200	28.86	-0.42	28.44	46.00	-17.56	QP
6	982.5400	27.90	2.52	30.42	54.00	-23.58	QP

Remark:

1. Margin = Result (Result =Reading + Factor )-Limit
2. Factor= Antenna factor+Cable attenuation factor(cable loss)-Amplifier gain

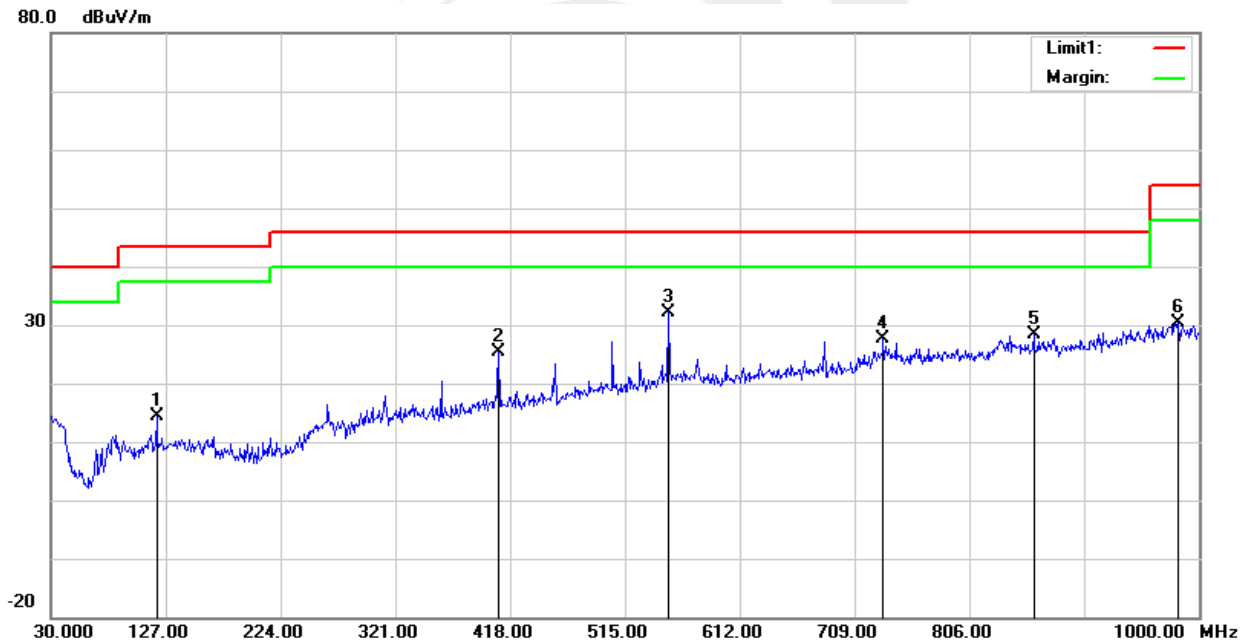



Temperature:	23.1(C)	Relative Humidity:	60%RH
Test Voltage:	DC 5V	Phase:	Vertical
Test Mode:	Mode 1/2/3/4/5/6/7/8/9(Mode 8 worst mode)		

No.	Frequency (MHz)	Reading (dBuV)	Correct Factor(dB/m)	Result (dBuV/m)	Limit (dBuV/m)	Margin (dB)	Remark
1	40.6700	45.37	-18.40	26.97	40.00	-13.03	QP
2	263.7700	36.20	-14.75	21.45	46.00	-24.55	QP
3	408.3000	39.97	-10.66	29.31	46.00	-16.69	QP
4	504.3300	39.58	-7.98	31.60	46.00	-14.40	QP
5	647.8900	30.71	-4.88	25.83	46.00	-20.17	QP
6	973.8100	28.52	2.25	30.77	54.00	-23.23	QP

Remark:

- Margin = Result (Result =Reading + Factor )-Limit
- Factor= Antenna factor+Cable attenuation factor(cable loss)-Amplifier gain

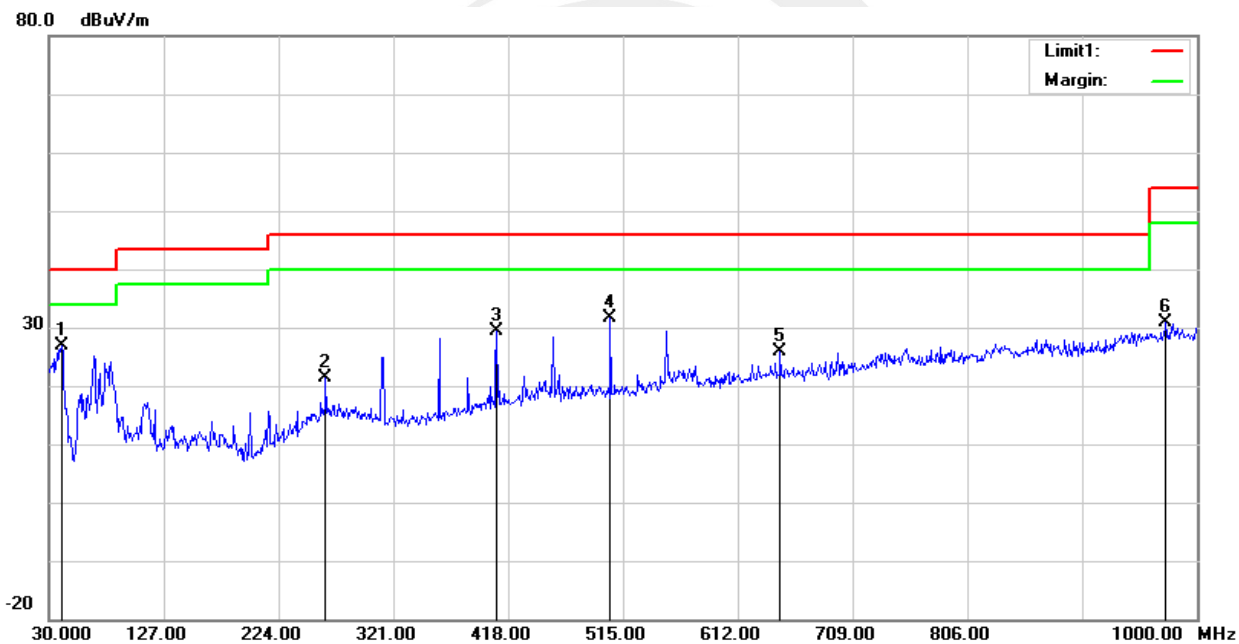



(1GHz~25GHz)#Spurious emission Requirements

Frequency (MHz)	Meter Reading (dBμV)	Amplifier (dB)	Loss (dB)	Antenna Factor (dB/m)	Corrected Factor (dB)	Emission Level (dBμV/m)	Limits (dBμV/m)	Margin (dB)	Detector Type	Comment
Low Channel (8DPSK/2402 MHz)										
3264.82	61.20	44.70	6.70	28.20	-9.80	51.40	74.00	-22.60	PK	Vertical
3264.82	51.30	44.70	6.70	28.20	-9.80	41.50	54.00	-12.50	AV	Vertical
3264.65	61.95	44.70	6.70	28.20	-9.80	52.15	74.00	-21.85	PK	Horizontal
3264.65	50.28	44.70	6.70	28.20	-9.80	40.48	54.00	-13.52	AV	Horizontal
4804.32	58.47	44.20	9.04	31.60	-3.56	54.91	74.00	-19.09	PK	Vertical
4804.32	49.40	44.20	9.04	31.60	-3.56	45.84	54.00	-8.16	AV	Vertical
4804.52	58.28	44.20	9.04	31.60	-3.56	54.72	74.00	-19.28	PK	Horizontal
4804.52	50.53	44.20	9.04	31.60	-3.56	46.97	54.00	-7.03	AV	Horizontal
5359.61	49.37	44.20	9.86	32.00	-2.34	47.02	74.00	-26.98	PK	Vertical
5359.61	39.31	44.20	9.86	32.00	-2.34	36.96	54.00	-17.04	AV	Vertical
5359.70	47.32	44.20	9.86	32.00	-2.34	44.98	74.00	-29.02	PK	Horizontal
5359.70	38.91	44.20	9.86	32.00	-2.34	36.57	54.00	-17.43	AV	Horizontal
7205.80	54.30	43.50	11.40	35.50	3.40	57.70	74.00	-16.30	PK	Vertical
7205.80	43.73	43.50	11.40	35.50	3.40	47.13	54.00	-6.87	AV	Vertical
7205.71	54.65	43.50	11.40	35.50	3.40	58.05	74.00	-15.95	PK	Horizontal
7205.71	43.69	43.50	11.40	35.50	3.40	47.09	54.00	-6.91	AV	Horizontal
Middle Channel (8DPSK/2441 MHz)										
3264.85	61.78	44.70	6.70	28.20	-9.80	51.98	74.00	-22.02	PK	Vertical
3264.85	50.62	44.70	6.70	28.20	-9.80	40.82	54.00	-13.18	AV	Vertical
3264.59	61.25	44.70	6.70	28.20	-9.80	51.45	74.00	-22.55	PK	Horizontal
3264.59	49.94	44.70	6.70	28.20	-9.80	40.14	54.00	-13.86	AV	Horizontal
4882.33	59.56	44.20	9.04	31.60	-3.56	56.00	74.00	-18.00	PK	Vertical
4882.33	49.32	44.20	9.04	31.60	-3.56	45.76	54.00	-8.24	AV	Vertical
4882.57	58.72	44.20	9.04	31.60	-3.56	55.16	74.00	-18.84	PK	Horizontal
4882.57	49.75	44.20	9.04	31.60	-3.56	46.19	54.00	-7.81	AV	Horizontal
5359.66	48.91	44.20	9.86	32.00	-2.34	46.57	74.00	-27.43	PK	Vertical
5359.66	40.17	44.20	9.86	32.00	-2.34	37.83	54.00	-16.17	AV	Vertical
5359.82	47.67	44.20	9.86	32.00	-2.34	45.33	74.00	-28.67	PK	Horizontal
5359.82	38.55	44.20	9.86	32.00	-2.34	36.20	54.00	-17.80	AV	Horizontal
7323.90	54.02	43.50	11.40	35.50	3.40	57.42	74.00	-16.58	PK	Vertical
7323.90	44.90	43.50	11.40	35.50	3.40	48.30	54.00	-5.70	AV	Vertical
7323.95	54.13	43.50	11.40	35.50	3.40	57.53	74.00	-16.47	PK	Horizontal
7323.95	44.41	43.50	11.40	35.50	3.40	47.81	54.00	-6.19	AV	Horizontal



High Channel (8DPSK2480 MHz)										
3264.86	62.23	44.70	6.70	28.20	-9.80	52.43	74.00	-21.57	PK	Vertical
3264.86	51.19	44.70	6.70	28.20	-9.80	41.39	54.00	-12.61	AV	Vertical
3264.79	61.75	44.70	6.70	28.20	-9.80	51.95	74.00	-22.05	PK	Horizontal
3264.79	50.55	44.70	6.70	28.20	-9.80	40.75	54.00	-13.25	AV	Horizontal
4960.36	58.66	44.20	9.04	31.60	-3.56	55.10	74.00	-18.90	PK	Vertical
4960.36	49.76	44.20	9.04	31.60	-3.56	46.20	54.00	-7.80	AV	Vertical
4960.37	59.54	44.20	9.04	31.60	-3.56	55.98	74.00	-18.02	PK	Horizontal
4960.37	49.99	44.20	9.04	31.60	-3.56	46.43	54.00	-7.57	AV	Horizontal
5359.74	48.45	44.20	9.86	32.00	-2.34	46.11	74.00	-27.89	PK	Vertical
5359.74	39.30	44.20	9.86	32.00	-2.34	36.96	54.00	-17.04	AV	Vertical
5359.64	48.30	44.20	9.86	32.00	-2.34	45.96	74.00	-28.04	PK	Horizontal
5359.64	38.03	44.20	9.86	32.00	-2.34	35.69	54.00	-18.31	AV	Horizontal
7439.94	53.64	43.50	11.40	35.50	3.40	57.04	74.00	-16.96	PK	Vertical
7439.94	43.81	43.50	11.40	35.50	3.40	47.21	54.00	-6.79	AV	Vertical
7439.93	54.23	43.50	11.40	35.50	3.40	57.63	74.00	-16.37	PK	Horizontal
7439.93	43.67	43.50	11.40	35.50	3.40	47.07	54.00	-6.93	AV	Horizontal

**Note:**

- 1) Scan with GFSK,  $\pi/4$ -DQPSK, 8DPSK, the worst case is 8DPSK Mode.
- 2) Factor = Antenna Factor + Cable Loss – Pre-amplifier.  
Emission Level = Reading + Factor
- 3) The frequency emission of peak points that did not show above the forms are at least 20dB below the limit, the frequency emission is mainly from the environment noise.



Restricted band Requirements

8DPSK-Low  
Horizontal

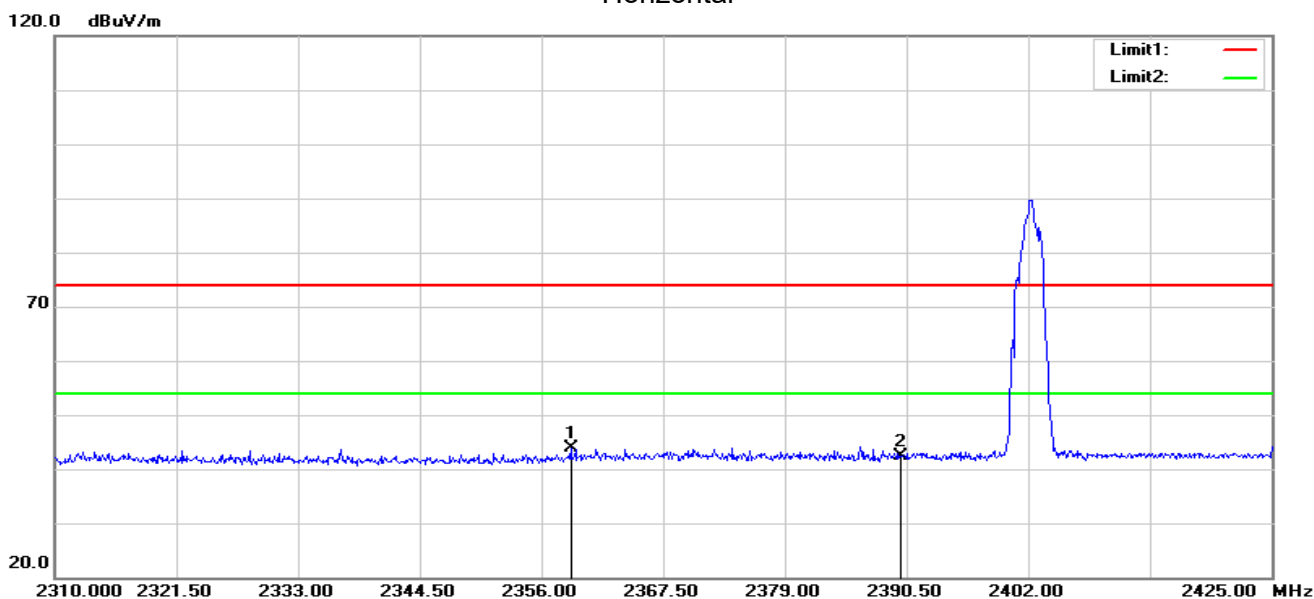

No.	Frequency (MHz)	Reading (dBuV)	Correct Factor(dB/m)	Result (dBuV/m)	Limit (dBuV/m)	Margin (dB)	Remark
1	2358.760	39.99	3.87	43.86	74.00	-30.14	peak
2	2390.000	37.96	4.34	42.30	74.00	-31.70	peak

Vertical

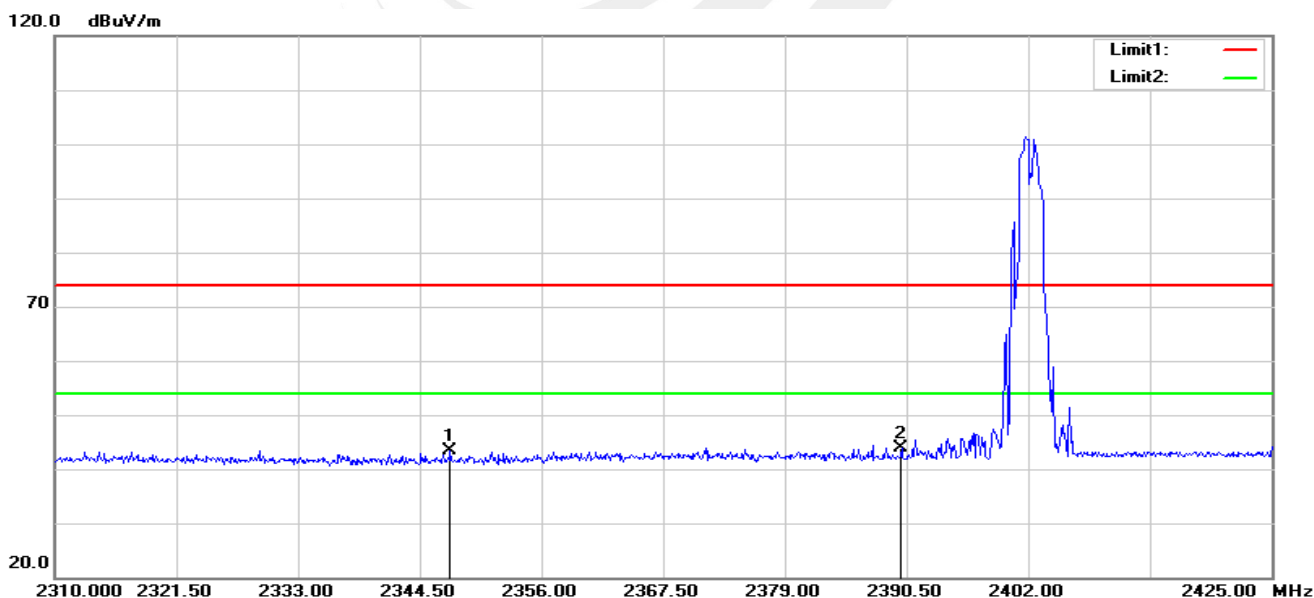

No.	Frequency (MHz)	Reading (dBuV)	Correct Factor(dB/m)	Result (dBuV/m)	Limit (dBuV/m)	Margin (dB)	Remark
1	2347.375	39.56	3.72	43.28	74.00	-30.72	peak
2	2390.000	39.58	4.34	43.92	74.00	-30.08	peak



8DPSK-High  
Horizontal

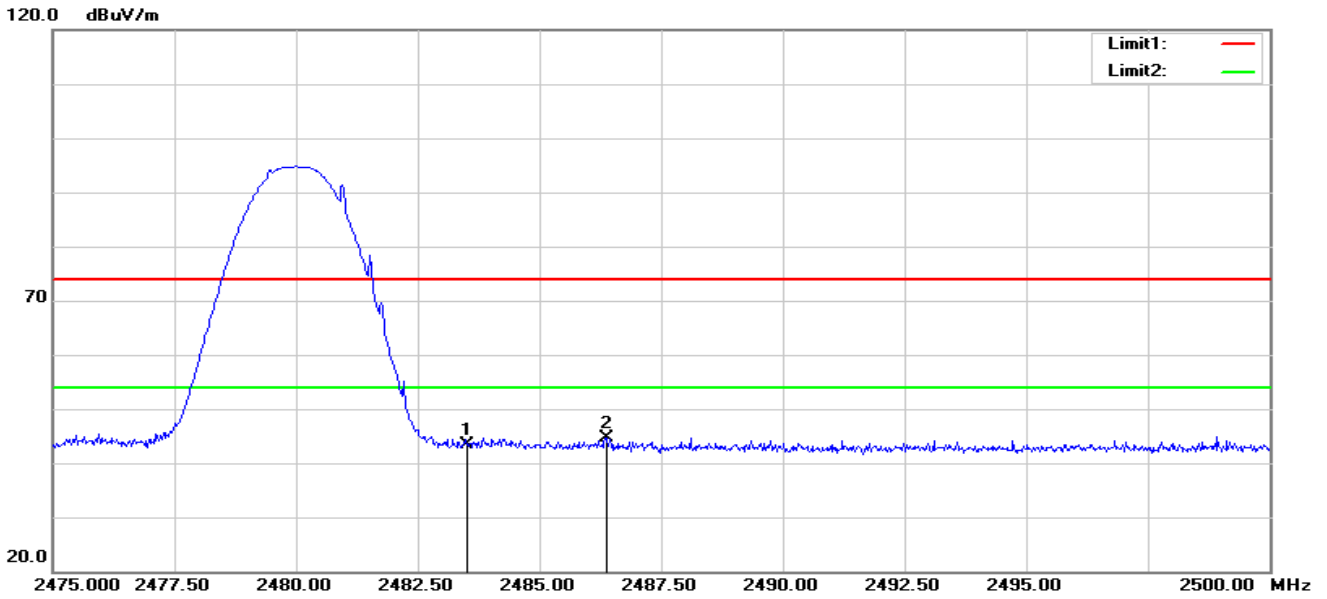

No.	Frequency (MHz)	Reading (dBuV)	Correct Factor(dB/m)	Result (dBuV/m)	Limit (dBuV/m)	Margin (dB)	Remark
1	2483.500	38.76	4.60	43.36	74.00	-30.64	peak
2	2486.375	40.07	4.61	44.68	74.00	-29.32	peak

Vertical

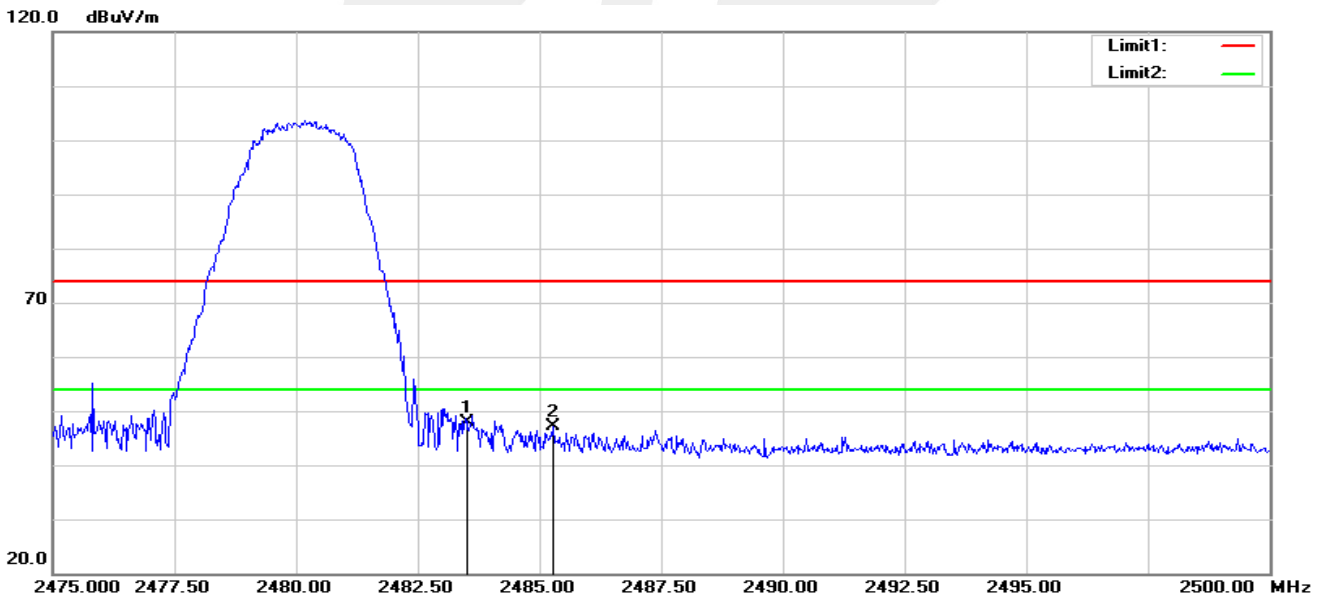

No.	Frequency (MHz)	Reading (dBuV)	Correct Factor(dB/m)	Result (dBuV/m)	Limit (dBuV/m)	Margin (dB)	Remark
1	2483.500	43.39	4.60	47.99	74.00	-26.01	peak
2	2485.275	42.51	4.61	47.12	74.00	-26.88	peak

Note: GFSK,  $\pi/4$ -DQPSK, 8DPSK of the nohopping and hopping mode all have been test, the worst case is 8DPSK of the nohopping mode, this report only show the worst case.



## 4. CONDUCTED SPURIOUS & BAND EDGE EMISSION

### 4.1 LIMIT

According to FCC section 15.247(d), in any 100kHz bandwidth outside the frequency band in which the spread spectrum or digitally modulated intentional radiator is operating, the radio frequency power that is produced by the intentional radiator shall be at least 20dB below that in the 100kHz bandwidth within the band that contains the highest level of the desired power, based on either an RF conducted or a radiated measurement.

### 4.2 TEST PROCEDURE

Spectrum Parameter	Setting
Detector	Peak
Start/Stop Frequency	30 MHz to 10th carrier harmonic
RB / VB (emission in restricted band)	100 KHz/300 KHz
Trace-Mode:	Max hold

For Band edge

Spectrum Parameter	Setting
Detector	Peak
Start/Stop Frequency	Lower Band Edge: 2300 – 2407 MHz Upper Band Edge: 2475 – 2500 MHz
RB / VB (emission in restricted band)	100 KHz/300 KHz
Trace-Mode:	Max hold

For Hopping Band edge

Spectrum Parameter	Setting
Detector	Peak
Start/Stop Frequency	Lower Band Edge: 2300– 2403 MHz Upper Band Edge: 2479 – 2500 MHz
RB / VB (emission in restricted band)	100 KHz/300 KHz
Trace-Mode:	Max hold



### 4.3 TEST SETUP

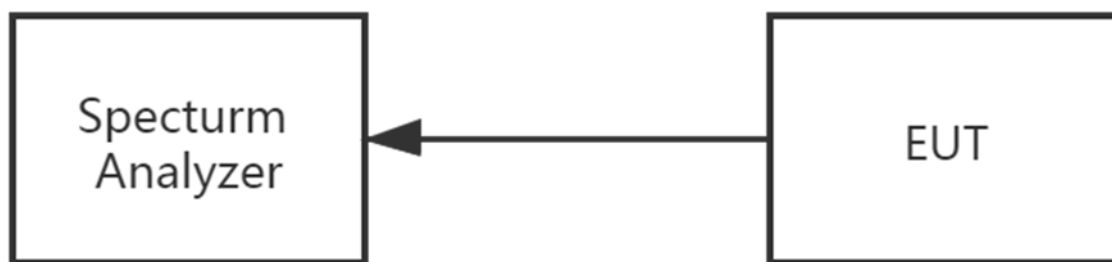

The EUT is connected to the Spectrum Analyzer; the RF load attached to the EUT antenna terminal is 50Ohm; the path loss as the factor is calibrated to correct the reading. Tune the measurement with the spectrum analyzer's resolution bandwidth (RBW) = 100 kHz. In order to make an accurate measurement, the span is set to be greater than RBW.

### 4.4 EUT OPERATION CONDITIONS

Please refer to section 3.1.4 of this report.

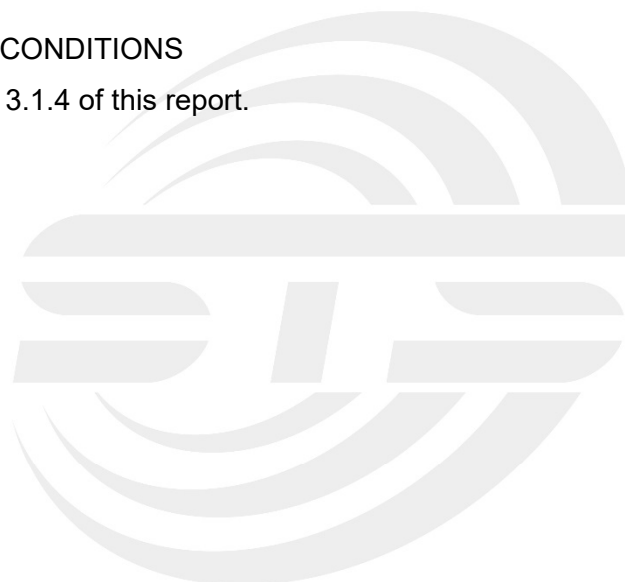



4.5 TEST RESULTS

Temperature:	25°C	Relative Humidity:	50%
Test Mode:	GFSK(1Mbps)-00/39/78 CH	Test Voltage:	DC 5V

00 CH

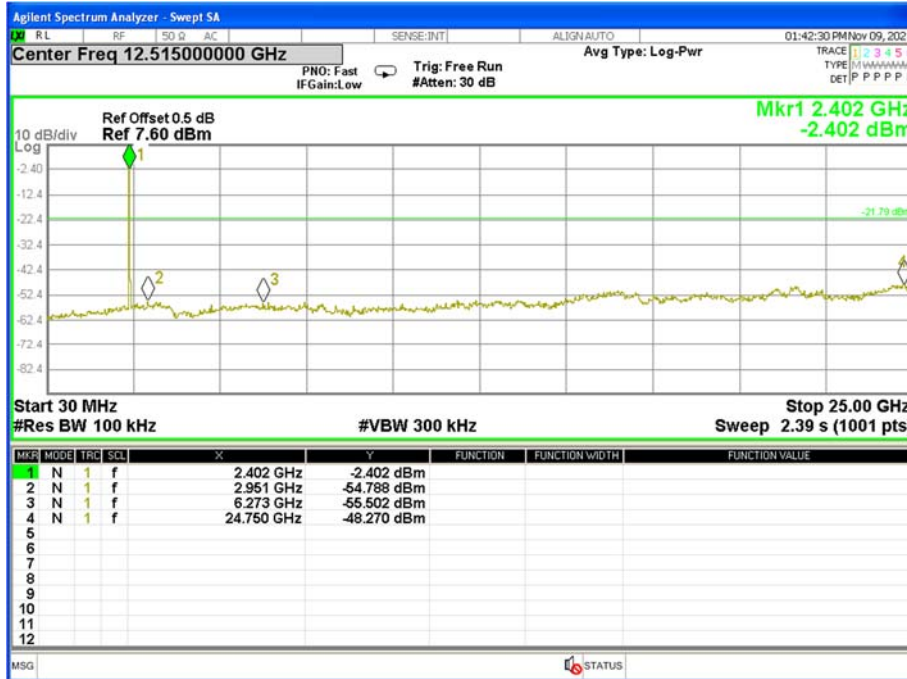

39 CH

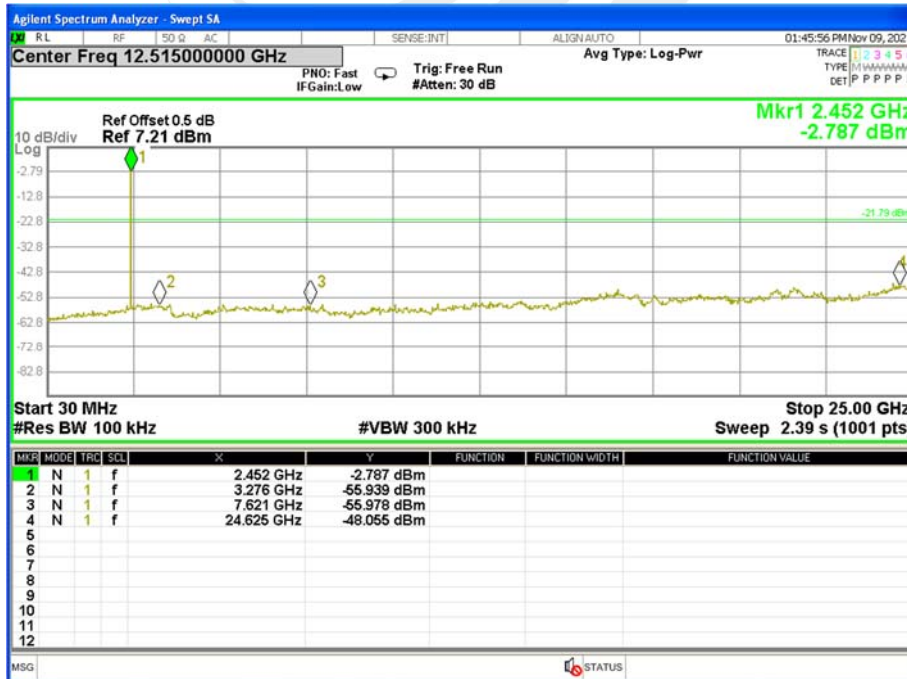



78 CH

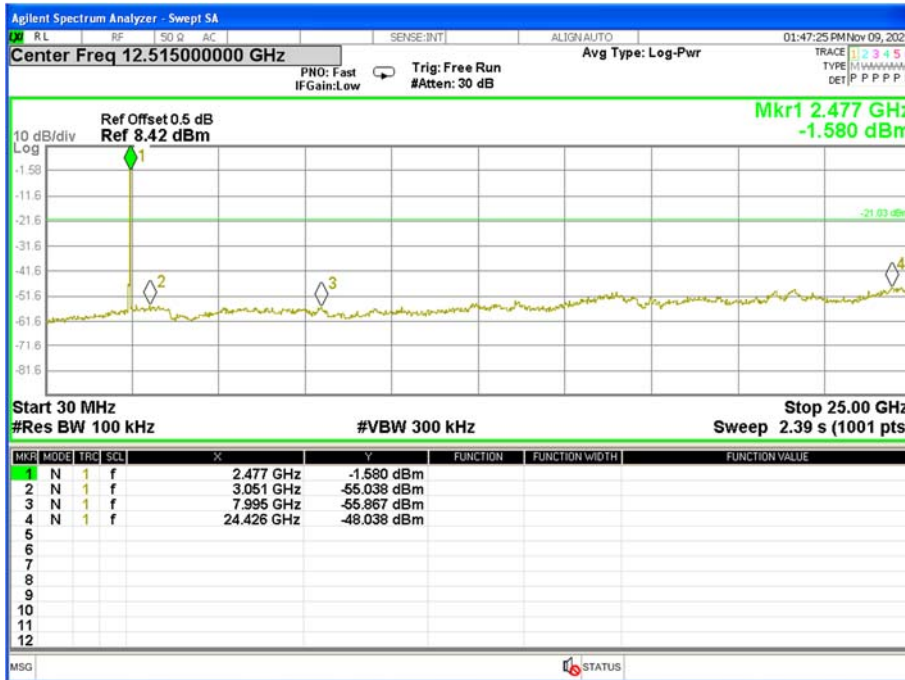



For Band edge(it's also the reference level for conducted spurious emission)

00 CH

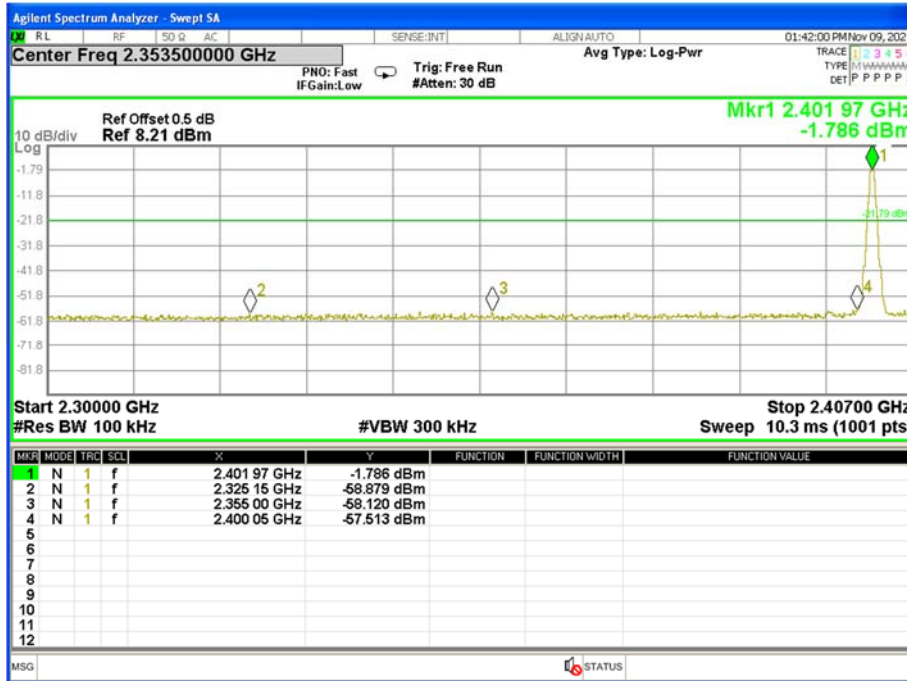

39 CH

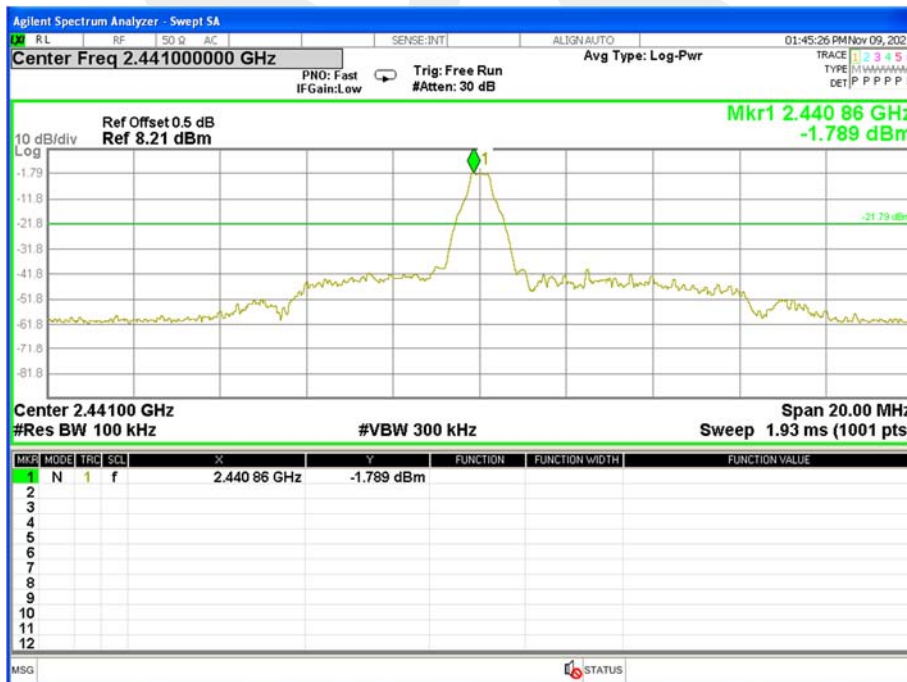



78 CH

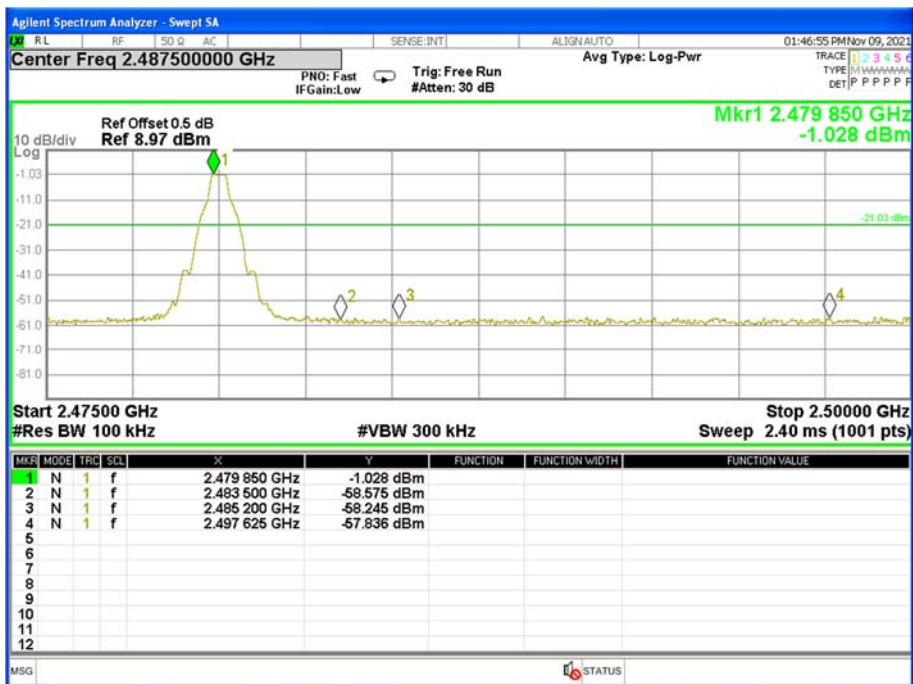



For Hopping Band edge

GFSK

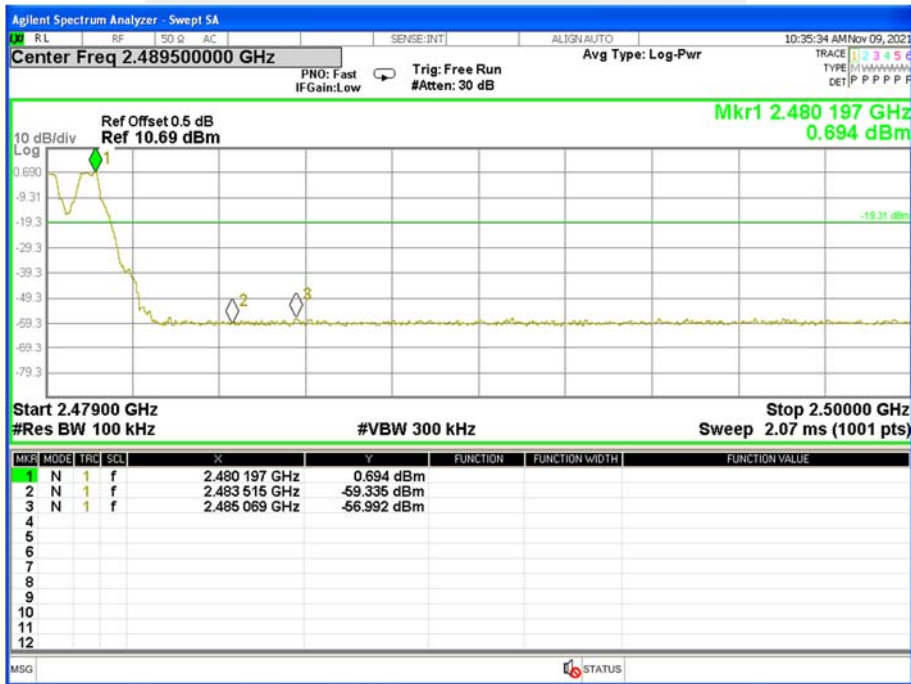
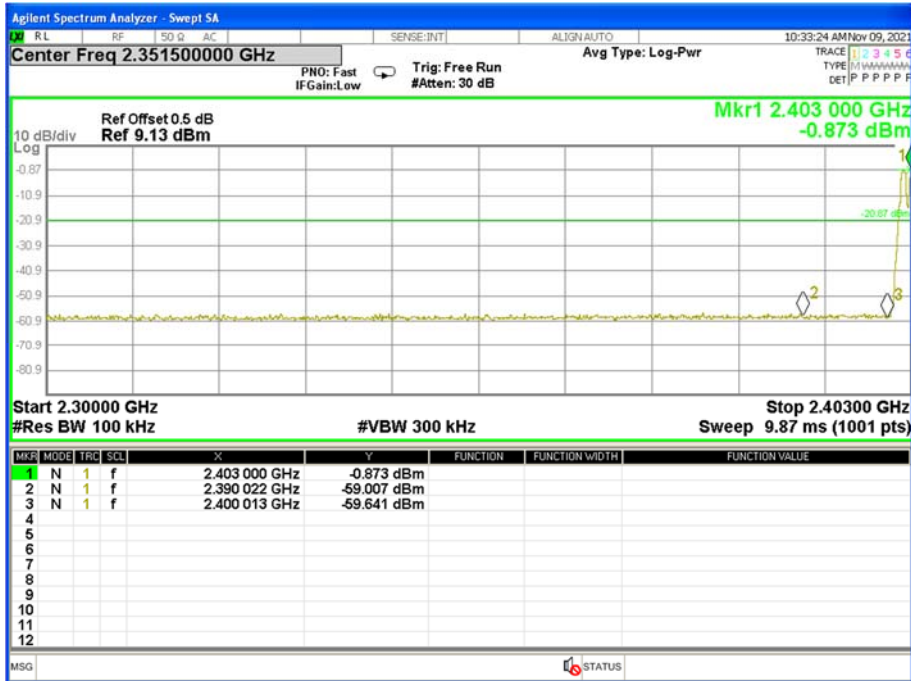



Temperature:	25°C	Relative Humidity:	50%
Test Mode:	$\pi/4$ -DQPSK(2Mbps)- 00/39/78 CH	Test Voltage:	DC 5V

00 CH

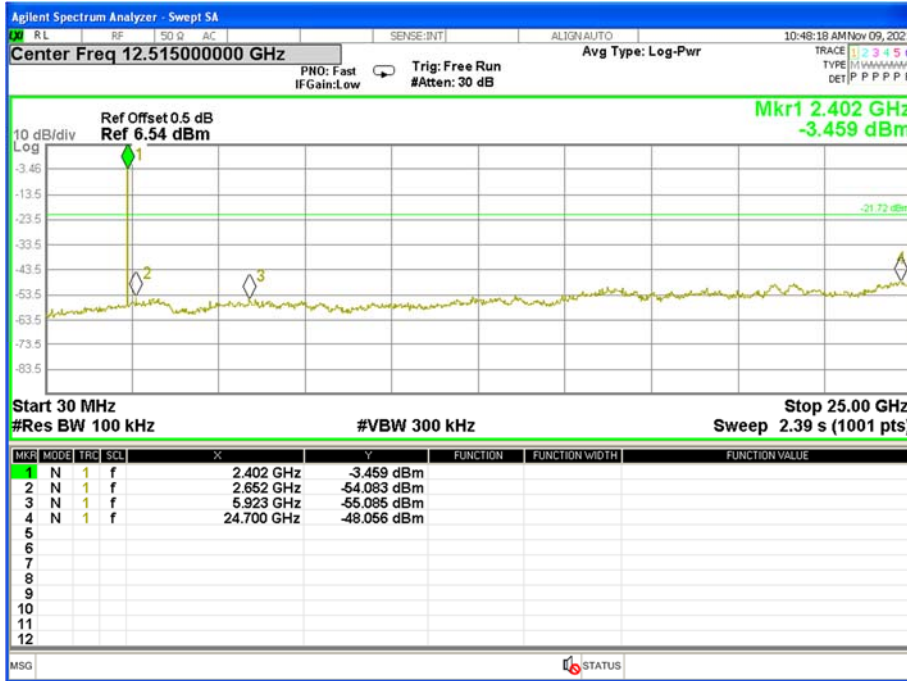

39 CH

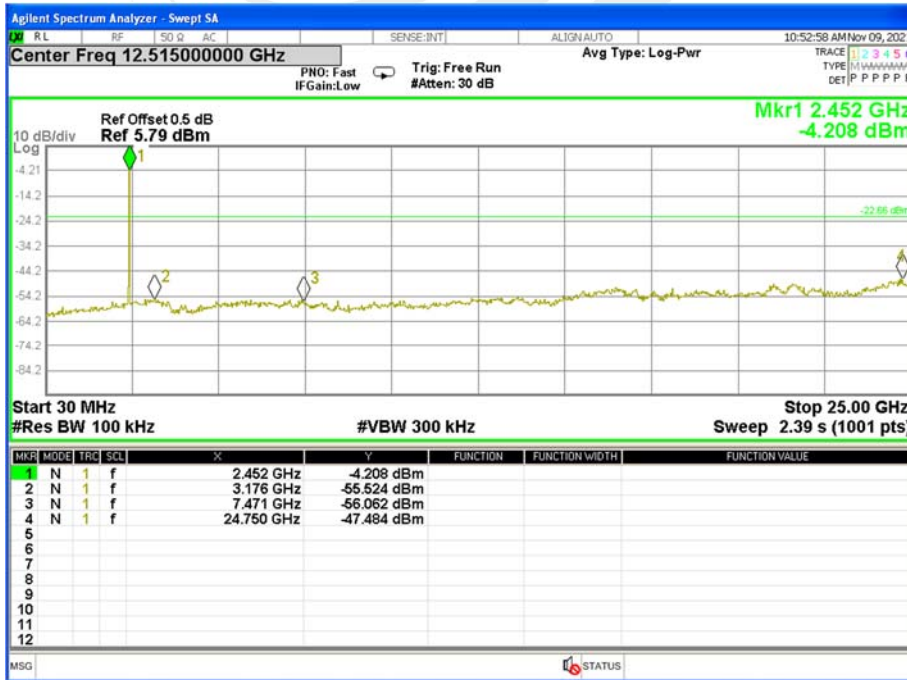



78 CH

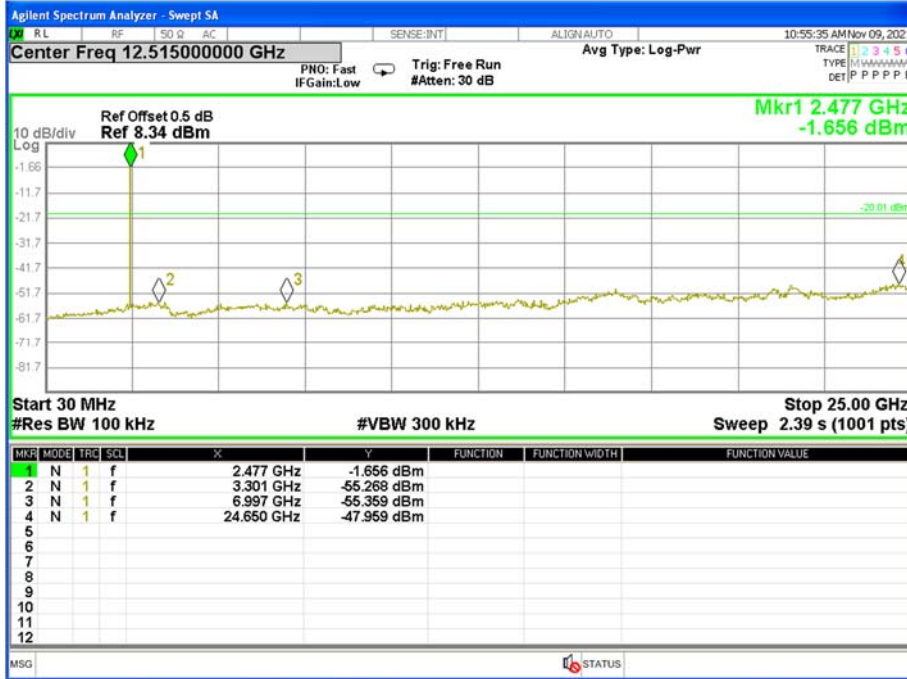





For Band edge(it's also the reference level for conducted spurious emission)

00 CH

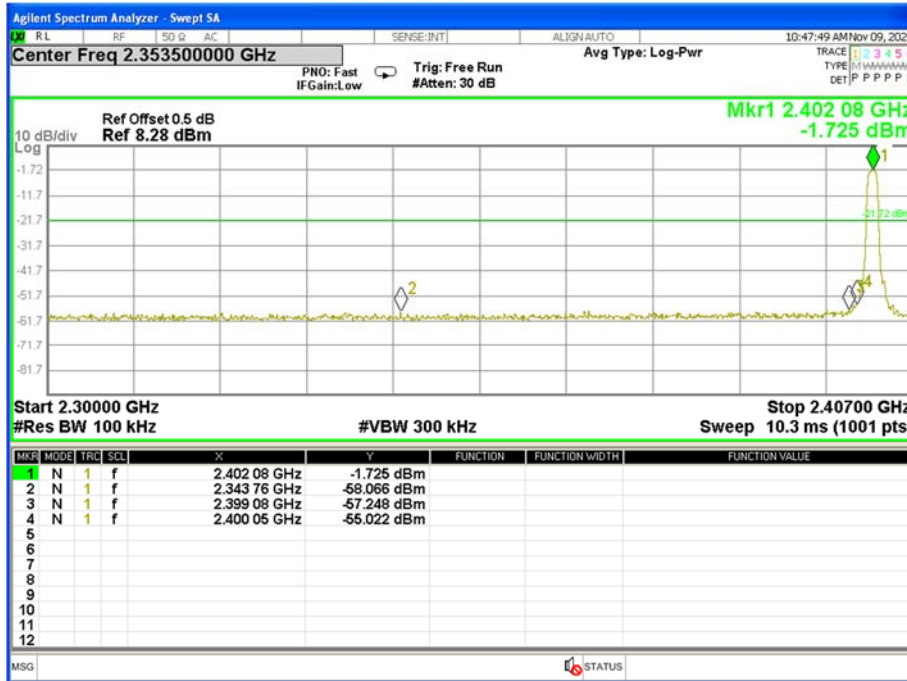

39 CH

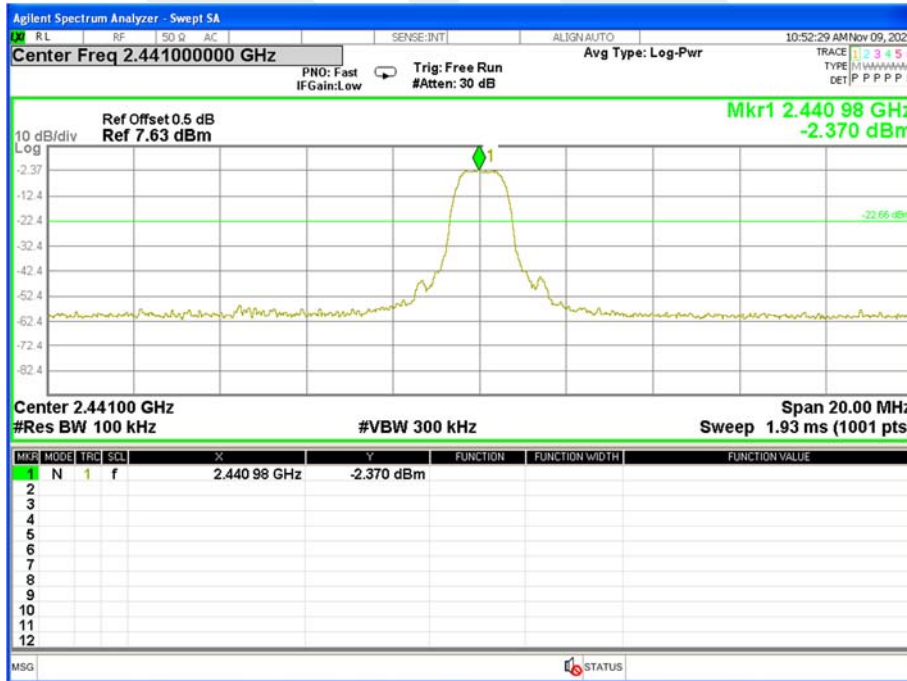



78 CH

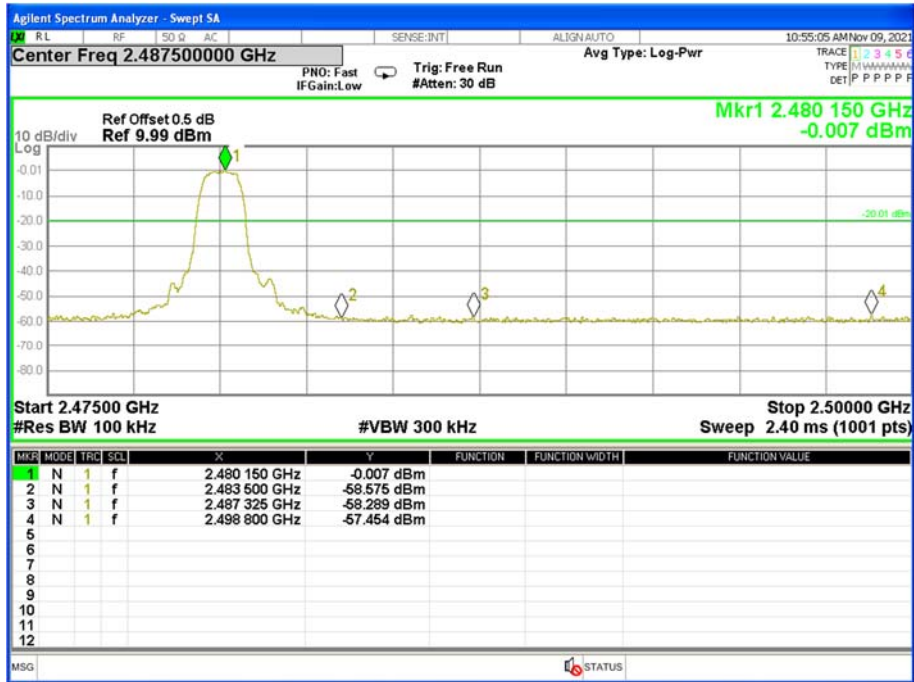



For Hopping Band edge

$\pi/4$ -DQPSK

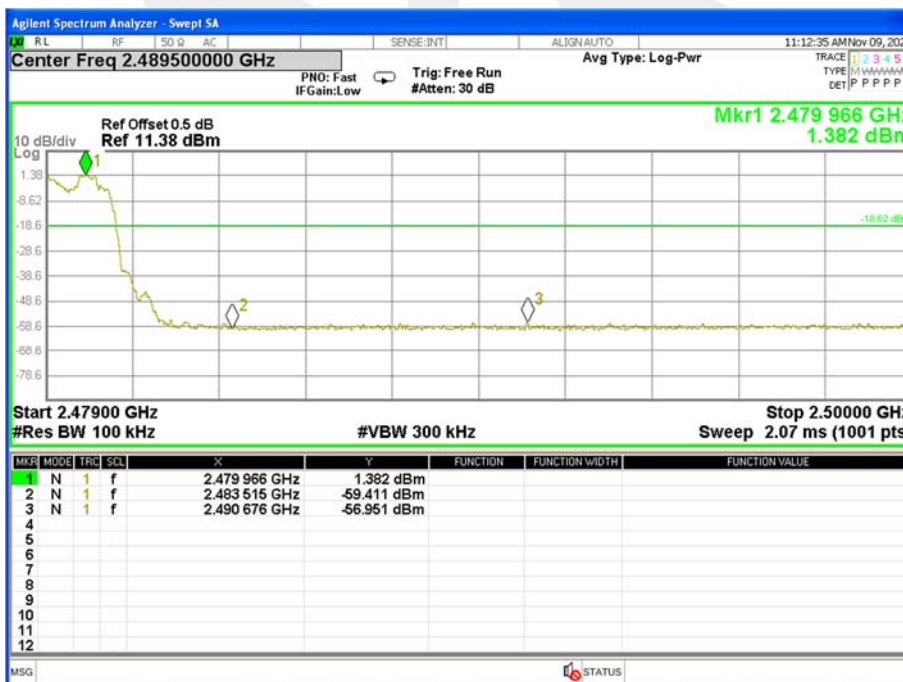
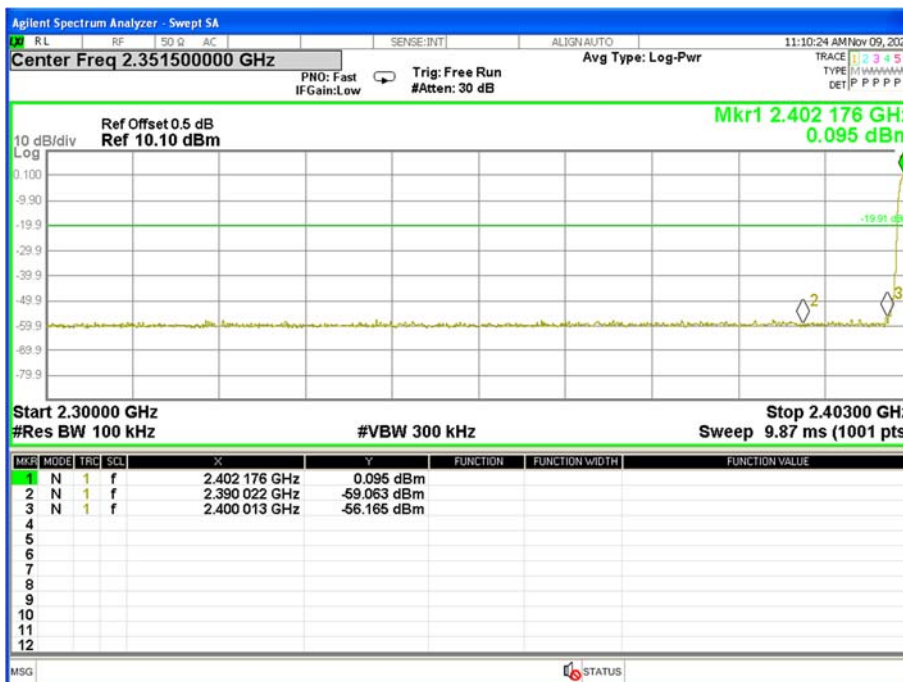



Temperature:	25°C	Relative Humidity:	50%
Test Mode:	8DPSK(3Mbps) -00/39/78 CH	Test Voltage:	DC 5V

00 CH



39 CH





78 CH

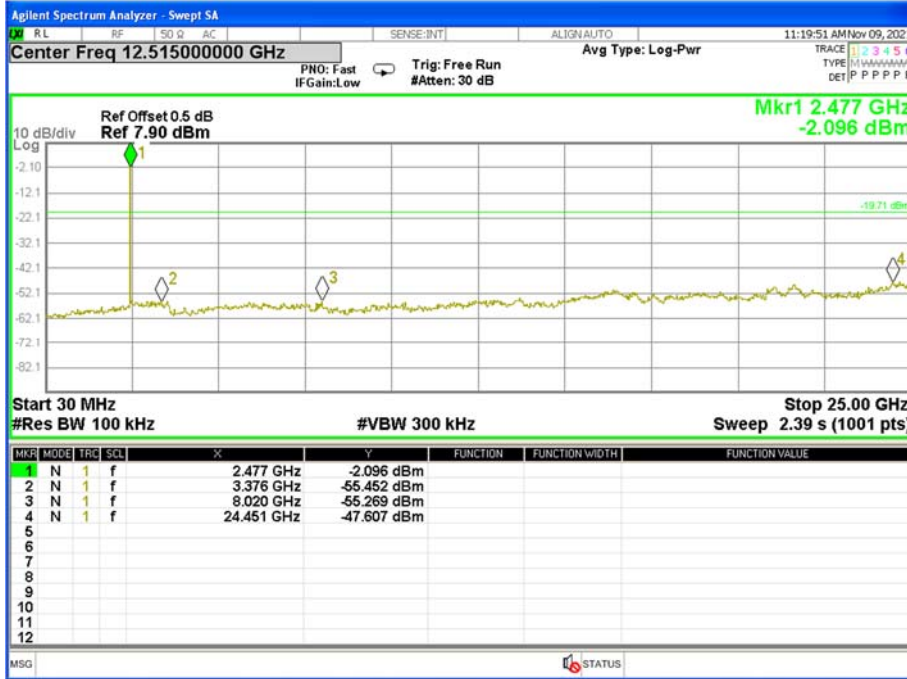



For Band edge(it's also the reference level for conducted spurious emission)

00 CH

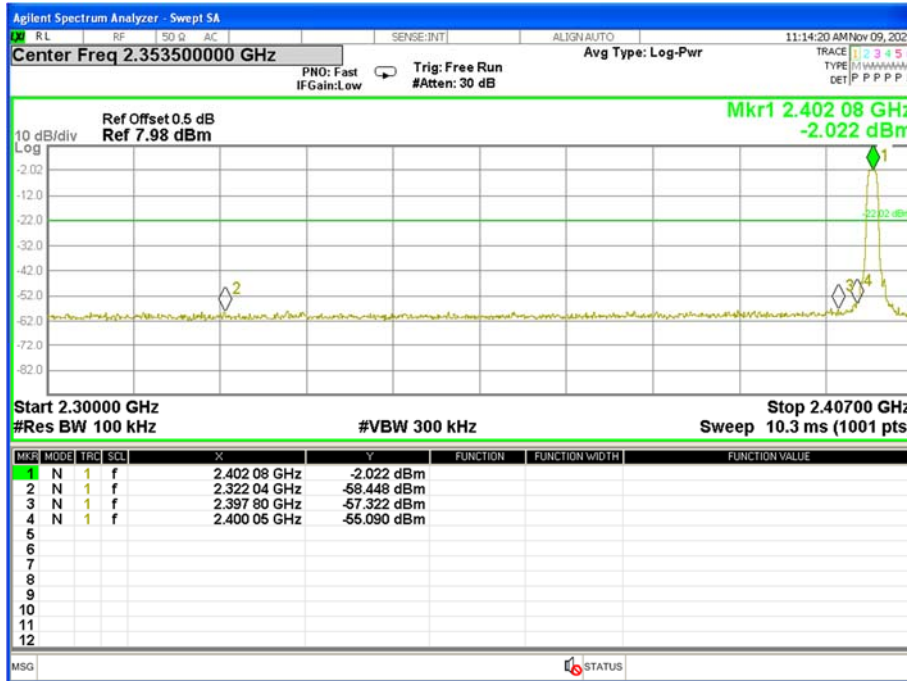

39 CH

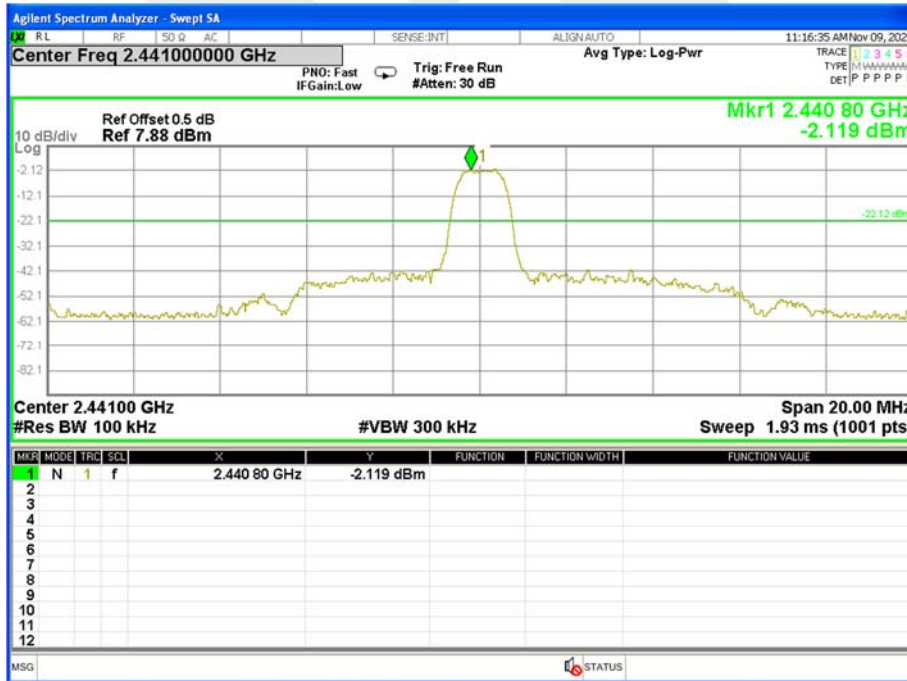



78 CH

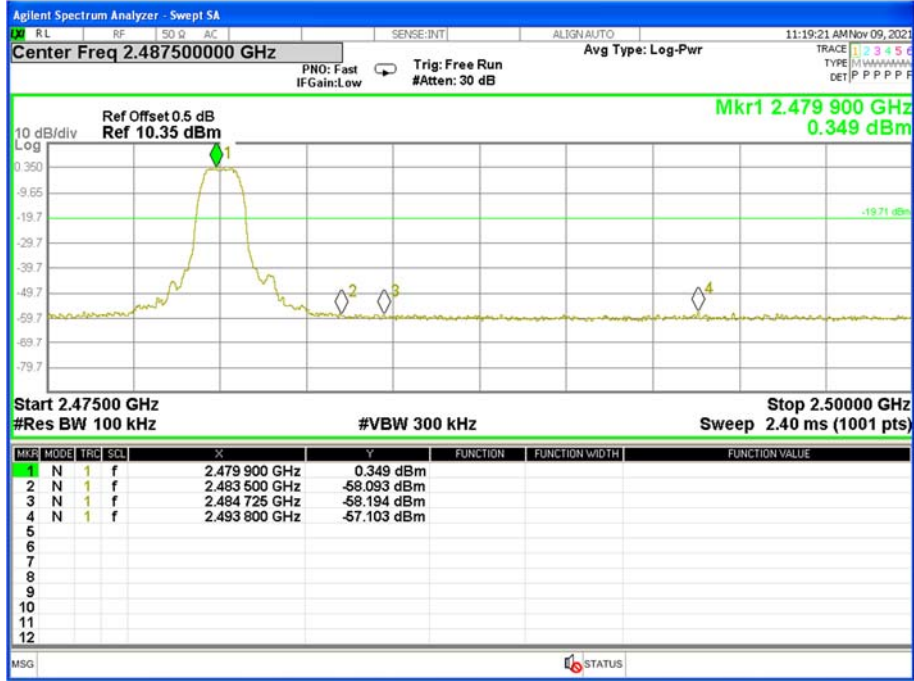



For Hopping Band edge

8DPSK

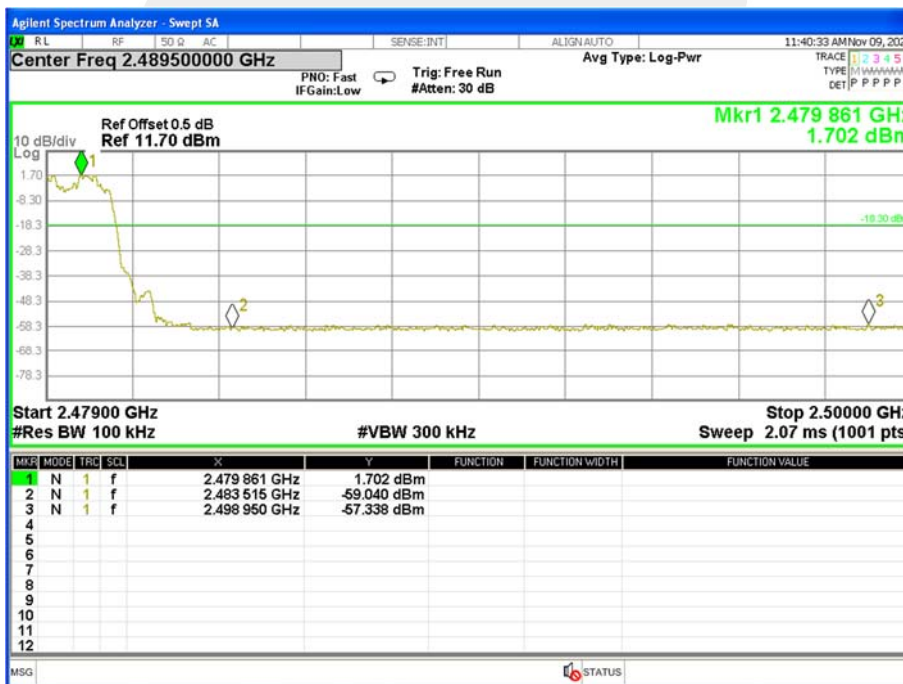
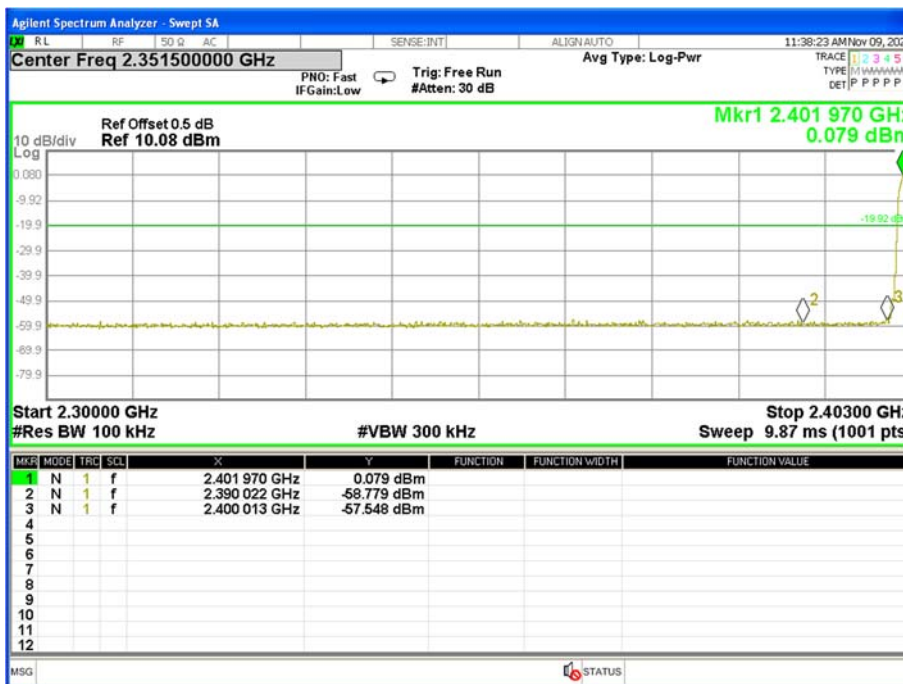



## 5. NUMBER OF HOPPING CHANNEL

### 5.1 LIMIT

FCC Part 15.247, Subpart C				
Section	Test Item	Limit	FrequencyRange (MHz)	Result
15.247 (a)(1)(iii)	Number of Hopping Channel	≥15	2400-2483.5	PASS

Spectrum Parameters	Setting
Attenuation	Auto
Span Frequency	> Operating FrequencyRange
RB	300KHz
VB	300KHz
Detector	Peak
Trace	Max Hold
Sweep Time	Auto

### 5.2 TEST PROCEDURE

- a. The EUT was directly connected to the spectrum analyzer and antenna output port as show in the block diagram below.
- b. Spectrum Setting: RBW= 300KHz, VBW=300KHz, Sweep time = Auto.

### 5.3 TEST SETUP



### 5.4 EUT OPERATION CONDITIONS

Please refer to section 3.1.4 of this report.



5.5 TEST RESULTS

Temperature:	25°C	Relative Humidity:	60%
Test Mode:	Hopping Mode -GFSK Mode	Test Voltage:	DC 5V

Number of Hopping Channel

79

Hopping channel

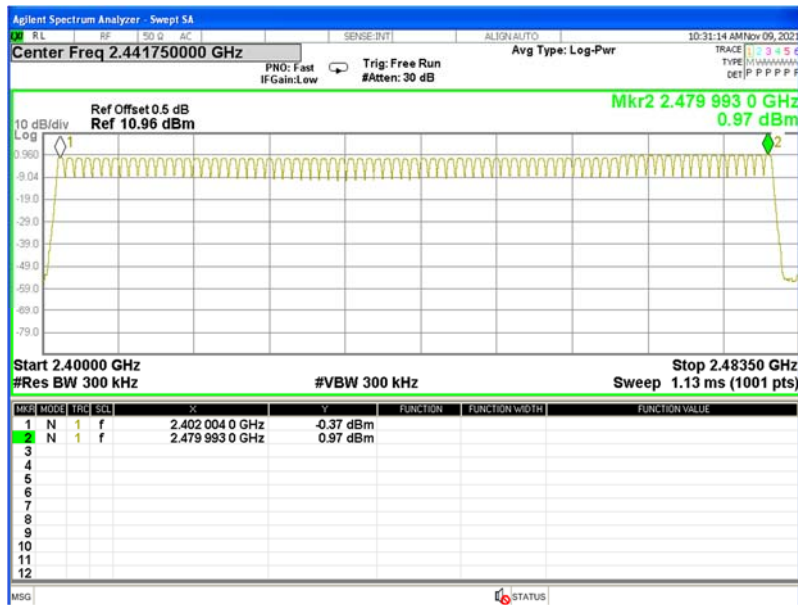

## 6. AVERAGE TIME OF OCCUPANCY

### 6.1 LIMIT

FCC Part 15.247, Subpart C				
Section	Test Item	Limit	Frequency Range (MHz)	Result
15.247 (a)(1)(iii)	Average Time of Occupancy	0.4sec	2400-2483.5	PASS

### 6.2 TEST PROCEDURE

- a. The transmitter output (antenna port) was connected to the spectrum analyzer.
- b. Set RBW = 1MHz/VBW = 3MHz.
- c. Use a video trigger with the trigger level set to enable triggering only on full pulses.
- d. Sweep Time is more than once pulse time.
- e. Set the center frequency on any frequency would be measure and set the frequency span to zero span.
- f. Measure the maximum time duration of one single pulse.
- g. Set the EUT for DH5, DH3 and DH1 packet transmitting.
- h. Measure the maximum time duration of one single pulse.
- i. DH5 Packet permit maximum  $1600 / 79 / 6 = 3.37$  hops per second in each channel (5 time slots RX, 1 time slot TX). So the number of pulses in the observation period of 31.6 seconds is  $3.37 \times 31.6 = 106.6$ .
- j. DH3 Packet permit maximum  $1600 / 79 / 4 = 5.06$  hops per second in each channel (3 time slots RX, 1 time slot TX). So the number of pulses in the observation period of 31.6 seconds is  $5.06 \times 31.6 = 160$ .
- k. DH1 Packet permit maximum  $1600 / 79 / 2 = 10.12$  hops per second in each channel (1 time slot RX, 1 time slot TX). So the number of pulses in the observation period of 31.6 seconds is  $10.12 \times 31.6 = 320$ .

### 6.3 TEST SETUP



### 6.4 EUT OPERATION CONDITIONS

Please refer to section 3.1.4 of this report.



## 6.5 TEST RESULTS

Temperature:	25°C	Relative Humidity:	50%
Test Mode:	GFSK(1Mbps)-DH1/DH3/DH5	Test Voltage:	DC 5V

Data Packet	Channel	pulse time(ms)	Dwell Time(s)	Limits(s)
DH1	middle	0.370	0.118	0.4
DH3	middle	1.630	0.261	0.4
DH5	middle	2.880	0.307	0.4





### CH39-DH1

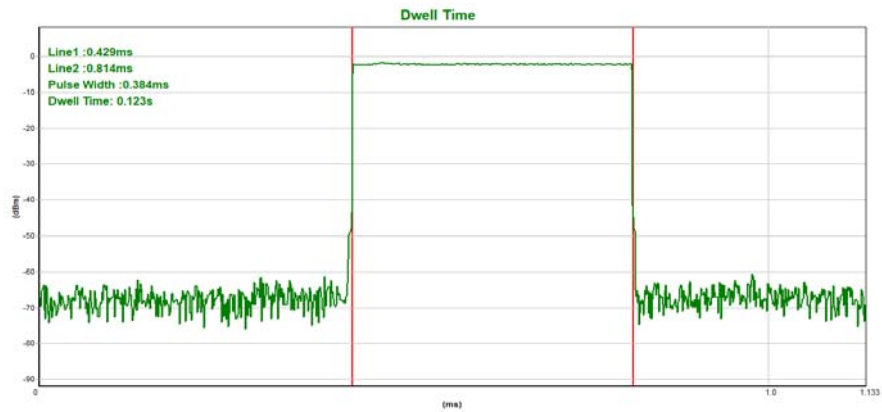

### CH39-DH3

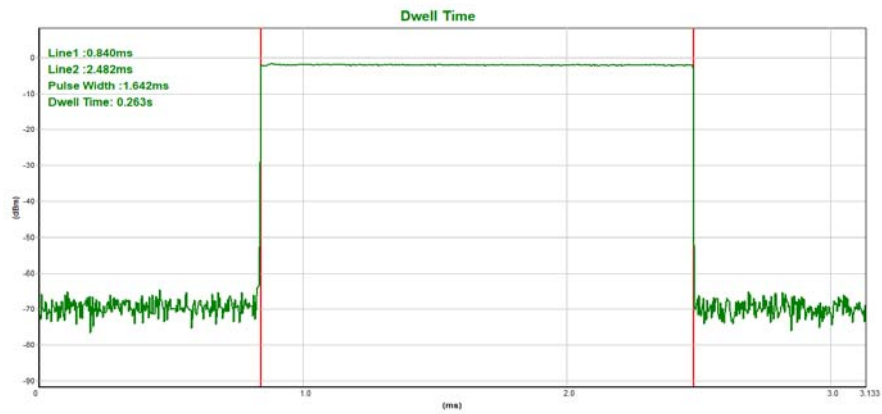

### CH39-DH5

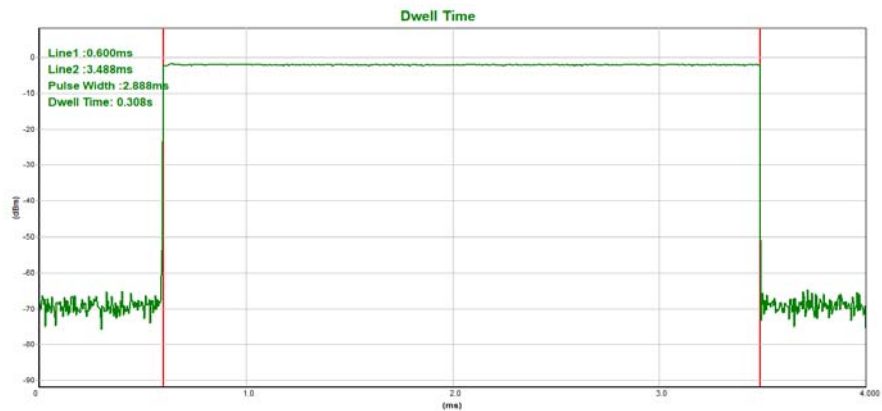



Temperature:	25°C	Relative Humidity:	50%
Test Mode:	$\pi/4$ -DQPSK(2Mbps)- 2DH1/2DH3/2DH5	Test Voltage:	DC 5V

Data Packet	Channel	pulse time(ms)	Dwell Time(s)	Limits(s)
2DH1	middle	0.380	0.122	0.4
2DH3	middle	1.640	0.262	0.4
2DH5	middle	2.930	0.313	0.4





### CH39-2DH1

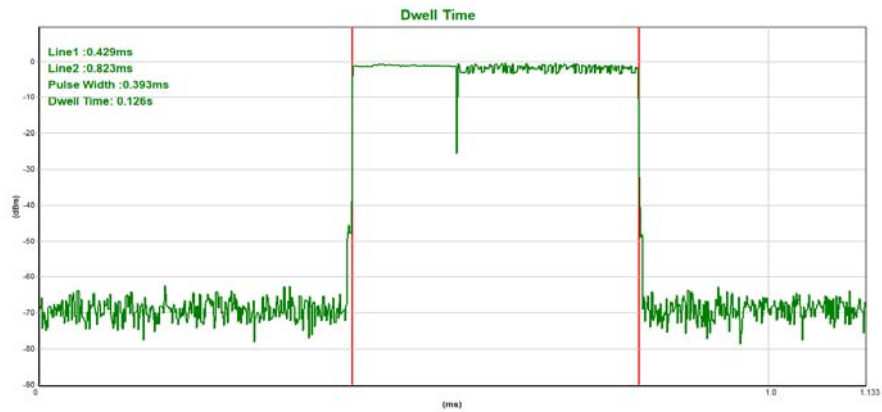

### CH39-2DH3

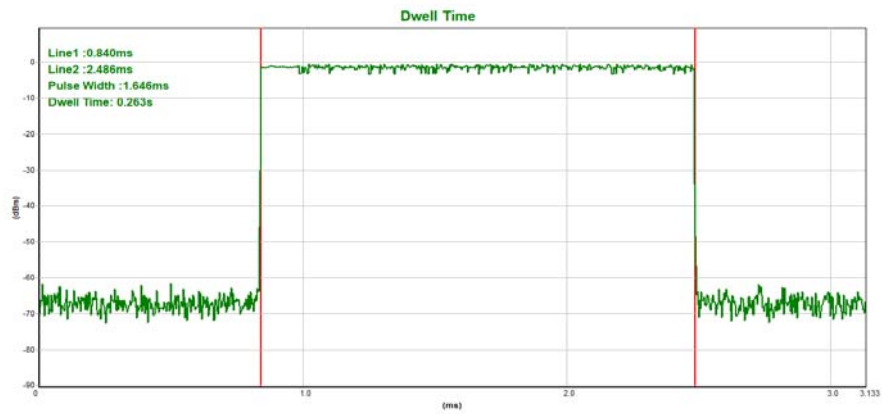

### CH39-2DH5

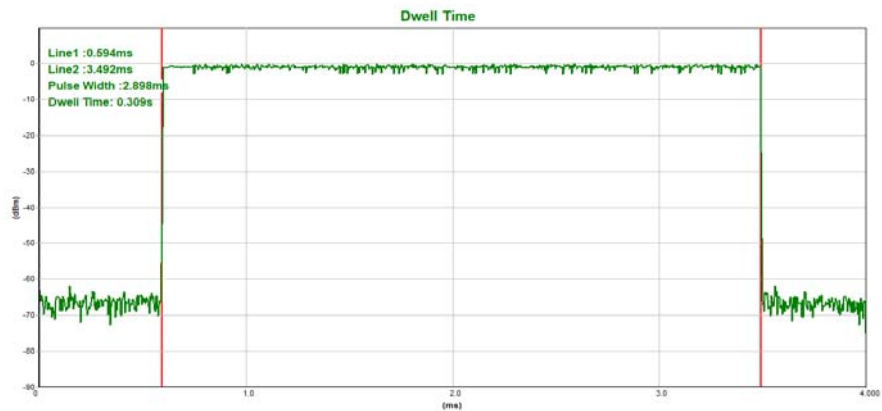



Temperature:	25°C	Relative Humidity:	50%
Test Mode:	8DPSK(3Mbps)- 3DH1/3DH3/3DH5	Test Voltage:	DC 5V

Data Packet	Channel	pulse time(ms)	Dwell Time(s)	Limits(s)
3DH1	middle	0.390	0.125	0.4
3DH3	middle	1.640	0.262	0.4
3DH5	middle	2.930	0.313	0.4







### CH39-3DH1

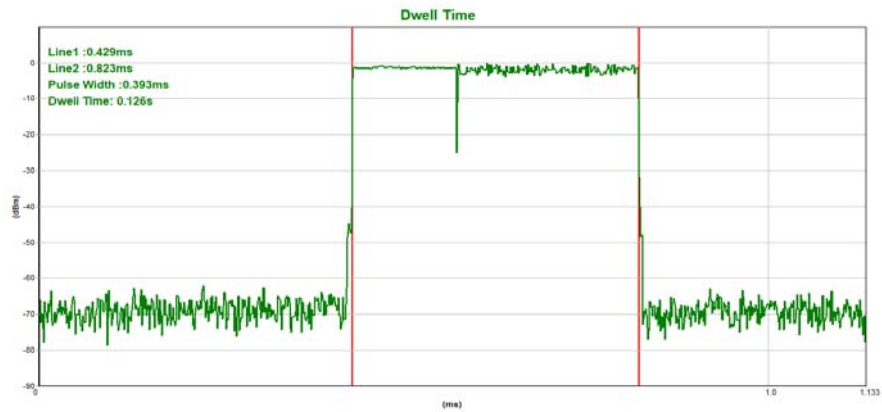

### CH39-3DH3

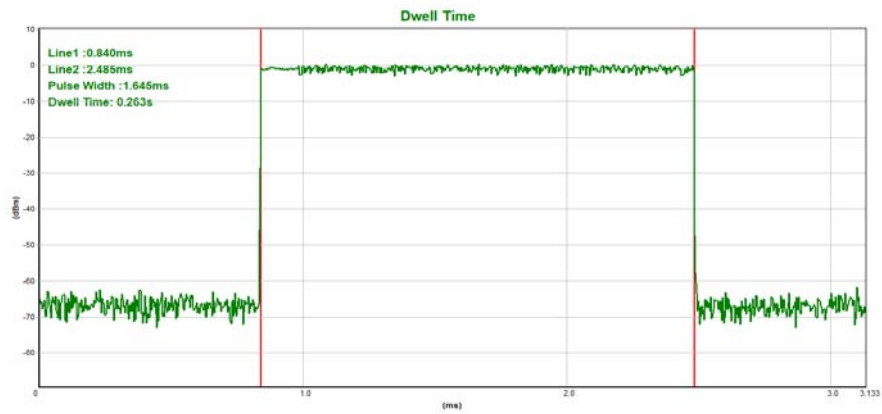

### CH39-3DH5

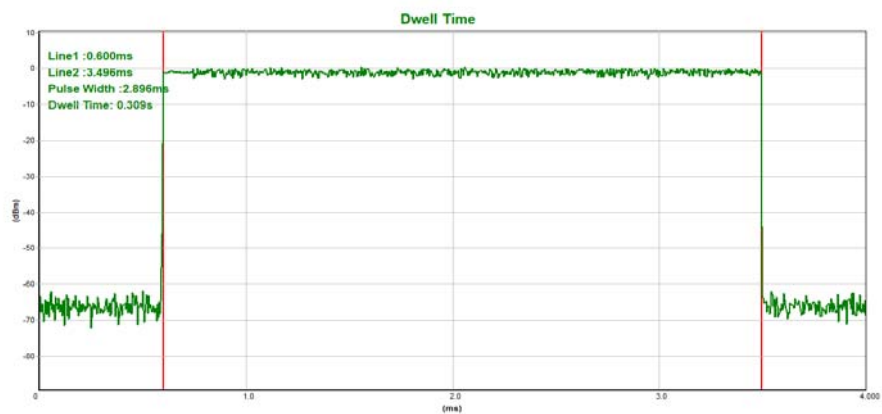

## 7. HOPPING CHANNEL SEPARATION MEASUREMENT

### 7.1 LIMIT

Frequency hopping systems shall have hopping channel carrier frequencies separated by a minimum of 25 kHz or the 20 dB bandwidth of the hopping channel, whichever is greater. Alternatively, frequency hopping systems operating in the 2400-2483.5 MHz band may have hopping channel carrier frequencies that are separated by 25 kHz or two-thirds of the 20 dB bandwidth of the hopping channel, whichever is greater, provided the systems operate with an output power no greater than 125 mW.

Spectrum Parameter	Setting
Attenuation	Auto
Span Frequency	> 20 dB Bandwidth or Channel Separation
RB	30 kHz (20dB Bandwidth) / 30 kHz (Channel Separation)
VB	100 kHz (20dB Bandwidth) / 100 kHz (Channel Separation)
Detector	Peak
Trace	Max Hold
Sweep Time	Auto

### 7.2 TEST PROCEDURE

- The transmitter output (antenna port) was connected to the spectrum analyser in peak hold mode.
- The resolution bandwidth of 30 kHz and the video bandwidth of 100 kHz were utilised for 20 dB bandwidth measurement.
- The resolution bandwidth of 30 kHz and the video bandwidth of 100 kHz were utilised for channel separation measurement.

### 7.3 TEST SETUP



### 7.4 EUT OPERATION CONDITIONS

The EUT was programmed to be in continuously transmitting mode.



7.5 TEST RESULTS

Temperature:	25°C	Relative Humidity:	50%
Test Mode:	CH00 / CH39 / CH78 (GFSK(1Mbps) Mode)	Test Voltage:	DC 5V

Frequency	Mark1 Frequency (MHz)	Mark2 Frequency (MHz)	Ch. Separation (MHz)	Limit (MHz)	Result
2402 MHz	2402.035	2403.100	1.065	0.915	Complies
2441 MHz	2440.945	2442.073	1.128	0.909	Complies
2480 MHz	2479.056	2480.034	0.978	0.914	Complies

For GFSK: Ch. Separation Limits: > 20dB bandwidth

CH00 -1Mbps

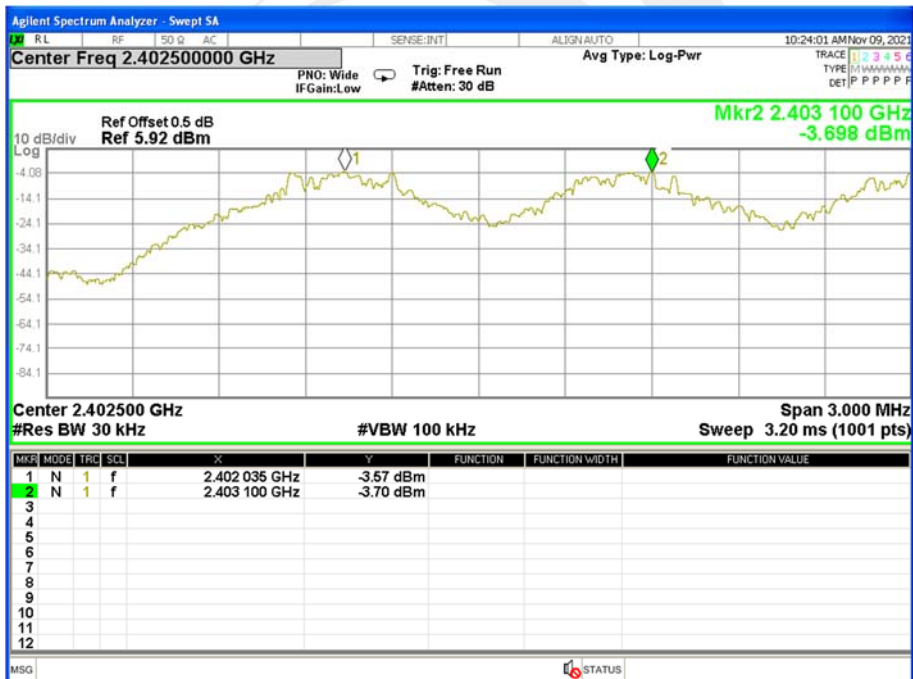



### CH39 -1Mbps

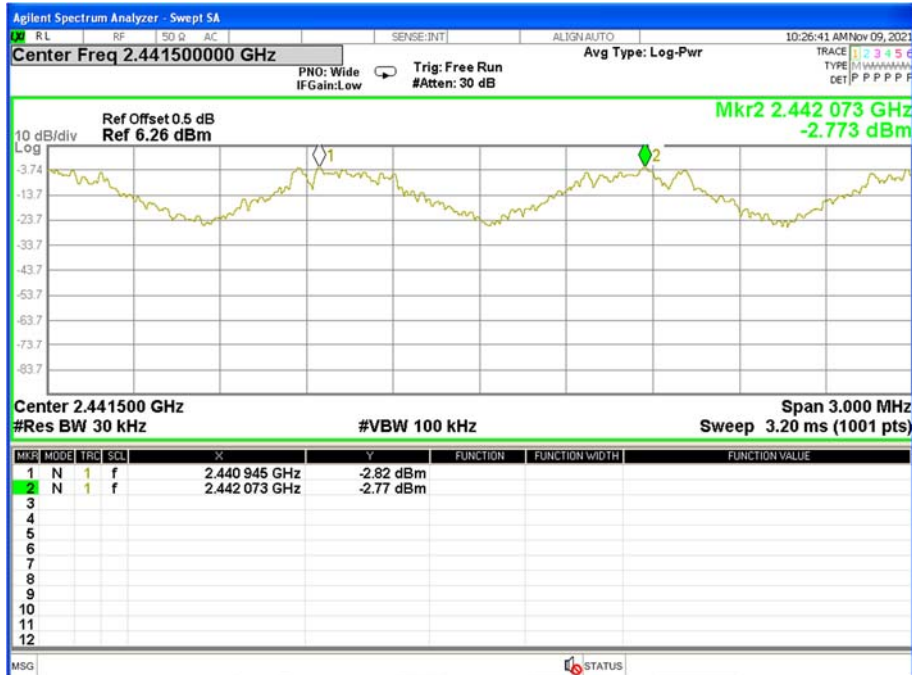

### CH78 -1Mbps

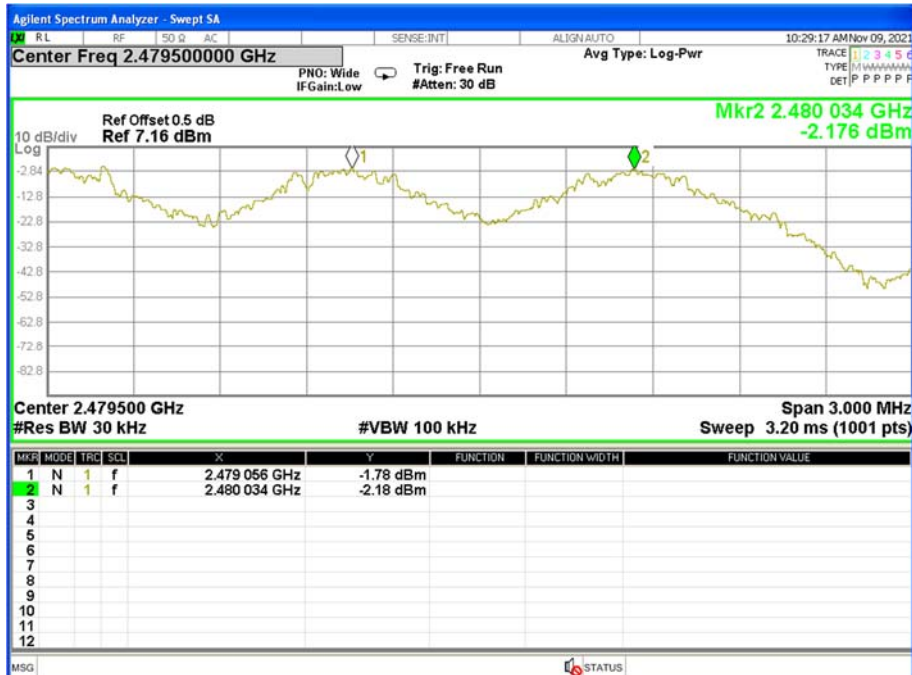



Temperature:	25°C	Relative Humidity:	50%
Test Mode:	CH00 / CH39 / CH78 ( $\pi/4$ -DQPSK(2Mbps) Mode)	Test Voltage:	DC 5V

Frequency	Mark1 Frequency (MHz)	Mark2 Frequency (MHz)	Ch. Separation (MHz)	Limit (MHz)	Result
2402 MHz	2401.834	2402.836	1.002	0.800	Complies
2441 MHz	2440.858	2441.851	0.993	0.798	Complies
2480 MHz	2479.191	2480.187	0.996	0.796	Complies

For  $\pi/4$ -DQPSK(2Mbps): Ch. Separation Limits: > two-thirds 20dB bandwidth

CH00 -2Mbps

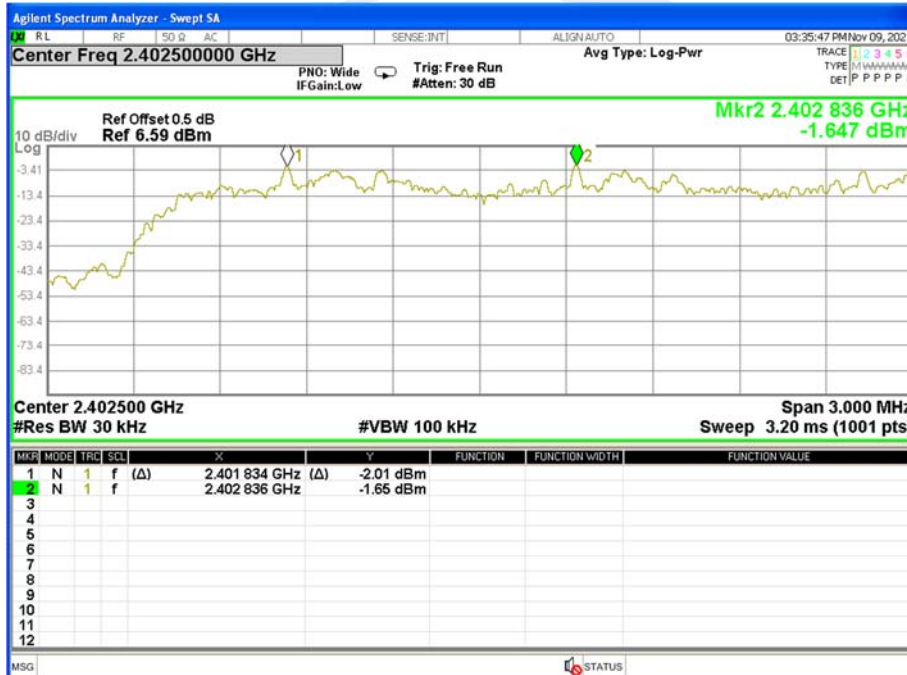



### CH39 -2Mbps

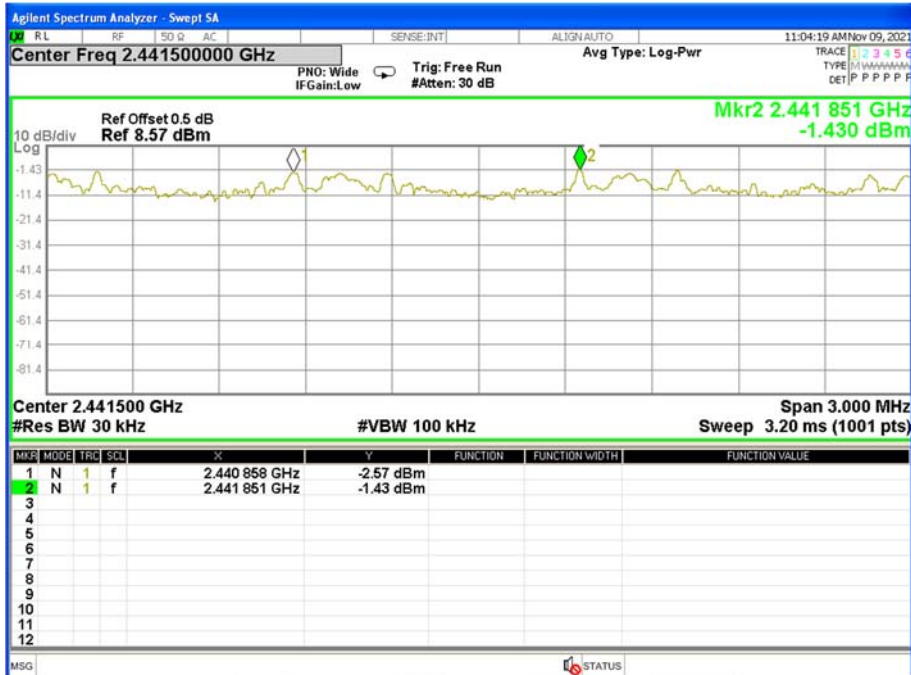

### CH78 -2Mbps

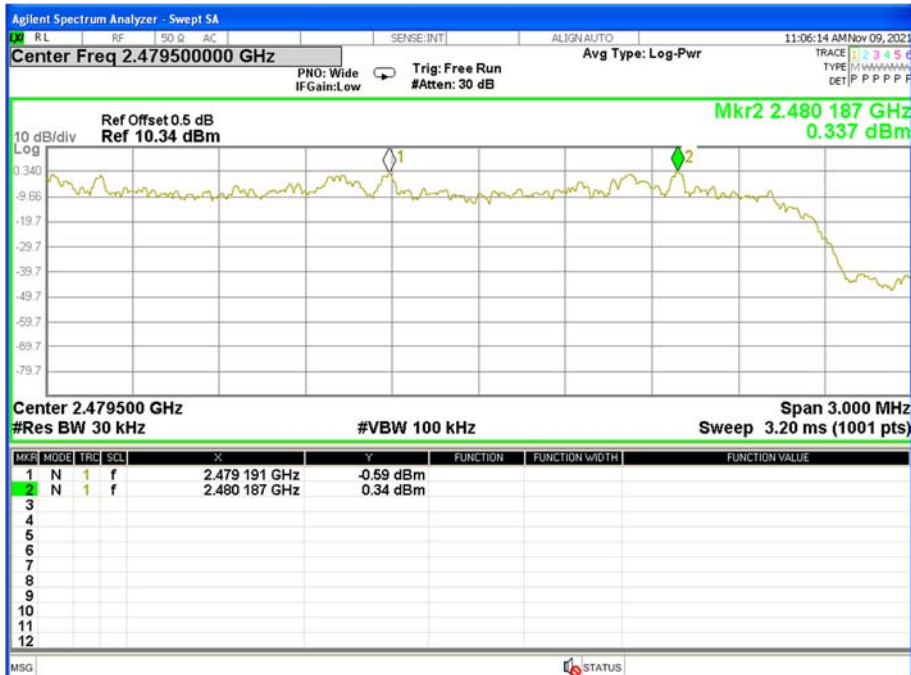



Temperature:	25°C	Relative Humidity:	50%
Test Mode:	CH00 / CH39 / CH78 (8DPSK(3Mbps)Mode)	Test Voltage:	DC 5V

Frequency	Mark1 Frequency (MHz)	Mark2 Frequency (MHz)	Ch. Separation (MHz)	Limit (MHz)	Result
2402 MHz	2402.029	2403.019	0.990	0.797	Complies
2441 MHz	2440.858	2442.193	1.335	0.796	Complies
2480 MHz	2479.020	2480.190	1.170	0.794	Complies

For 8DPSK(3Mbps):Ch. Separation Limits: > two-thirds 20dB bandwidth

**CH00 -3Mbps**

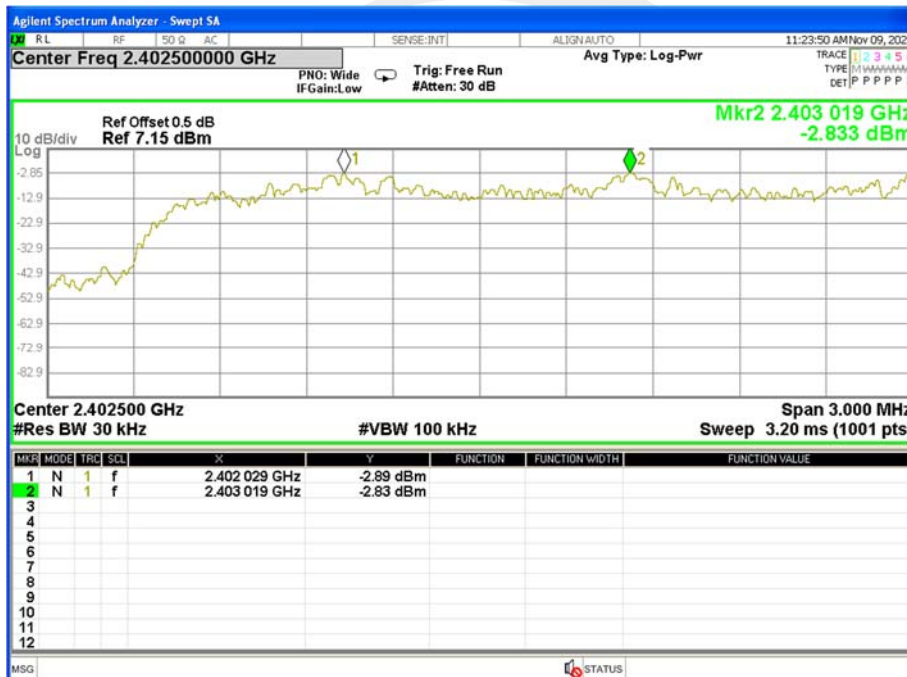



### CH39 -3Mbps

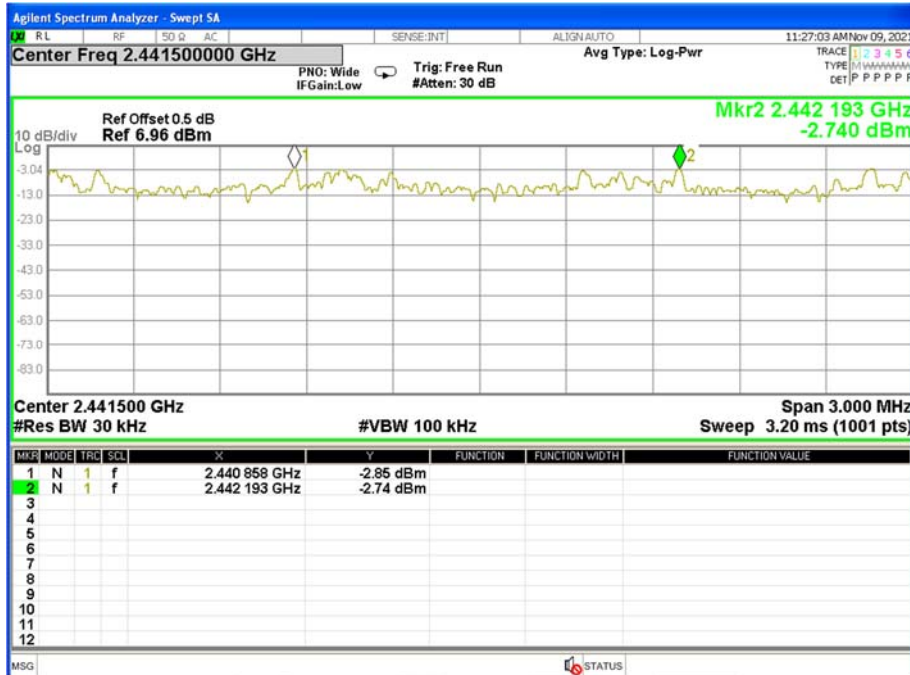

### CH78 -3Mbps

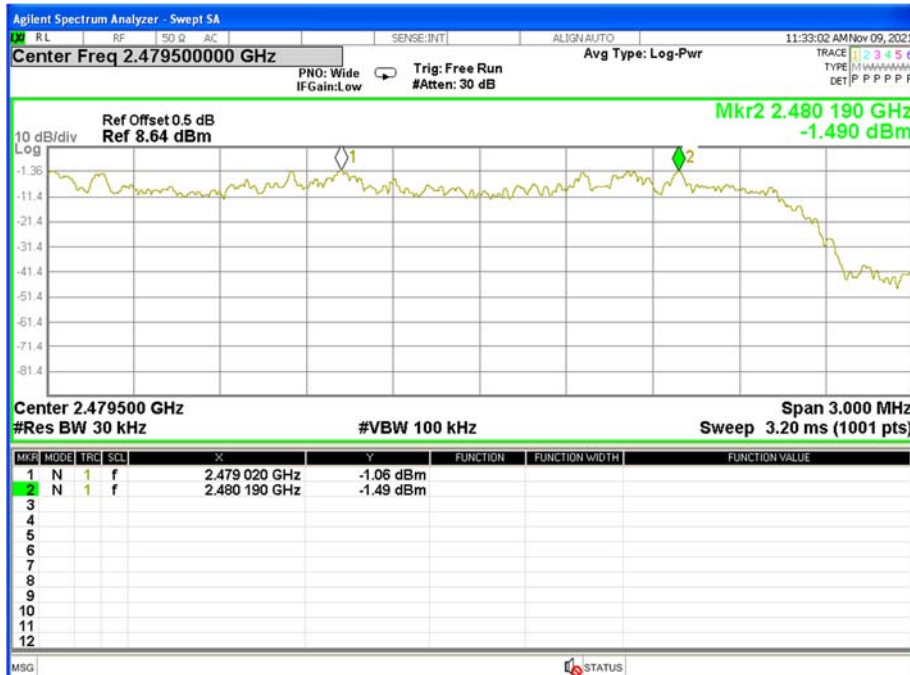



## 8. BANDWIDTH TEST

### 8.1 LIMIT

FCC Part15 15.247,Subpart C				
Section	Test Item	Limit	FrequencyRange (MHz)	Result
15.247 (a)(1)	Bandwidth	N/A	2400-2483.5	PASS

Spectrum Parameter	Setting
Attenuation	Auto
Span Frequency	> Measurement Bandwidth or Channel Separation
RB	30 kHz (20dB Bandwidth) / 30 kHz (Channel Separation)
VB	100 kHz (20dB Bandwidth) / 100 kHz (Channel Separation)
Detector	Peak
Trace	Max Hold
Sweep Time	Auto

### 8.2 TEST PROCEDURE

- a. The EUT was directly connected to the spectrum analyzer and antenna output port as show in the block diagram below.
- b. Spectrum Setting: RBW= 30KHz, VBW=100KHz, Sweep time = Auto.

### 8.3 TEST SETUP



### 8.4 EUT OPERATION CONDITIONS

Please refer to section 3.1.4 of this report.



8.5 TEST RESULTS

Temperature:	25°C	Relative Humidity:	50%
Test Mode:	GFSK(1Mbps) CH00 / CH39 / C78	Test Voltage:	DC 5V

Frequency	20dB Bandwidth (MHz)	Result
2402 MHz	0.9147	PASS
2441 MHz	0.9086	PASS
2480 MHz	0.9144	PASS

CH00 -1Mbps

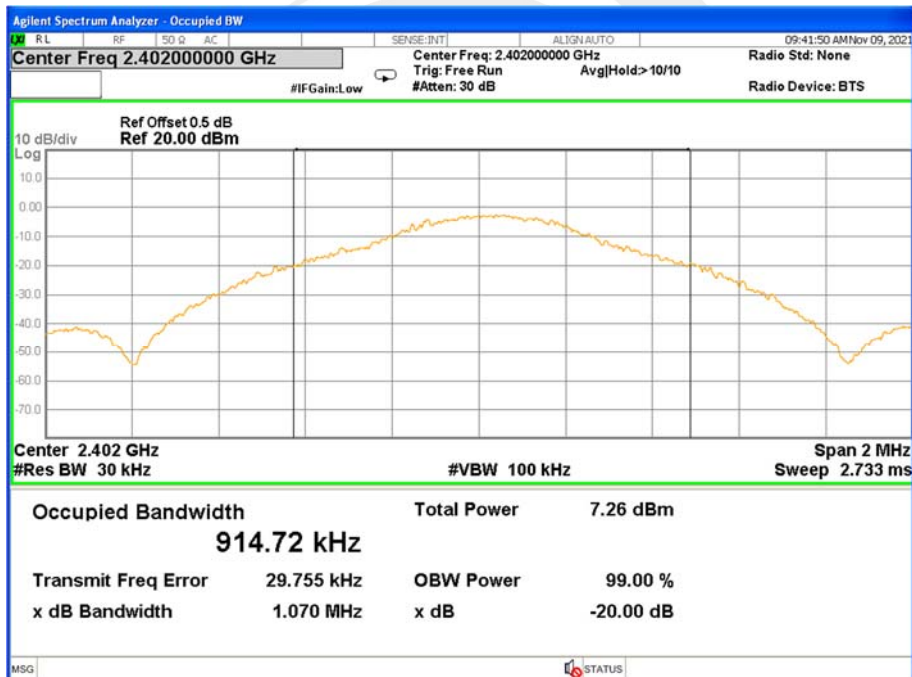



### CH39 -1Mbps

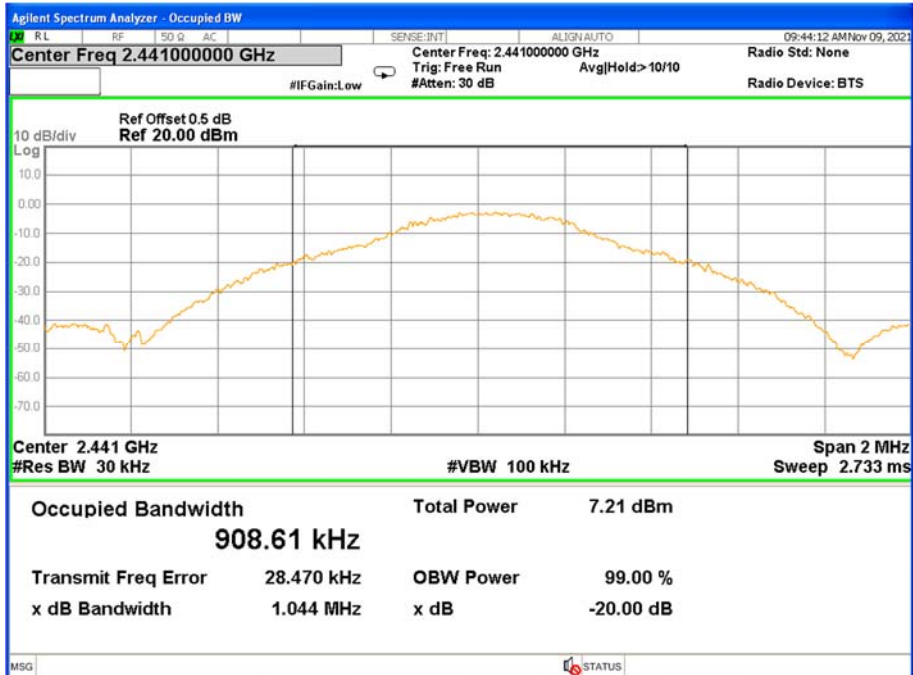

### CH78 -1Mbps

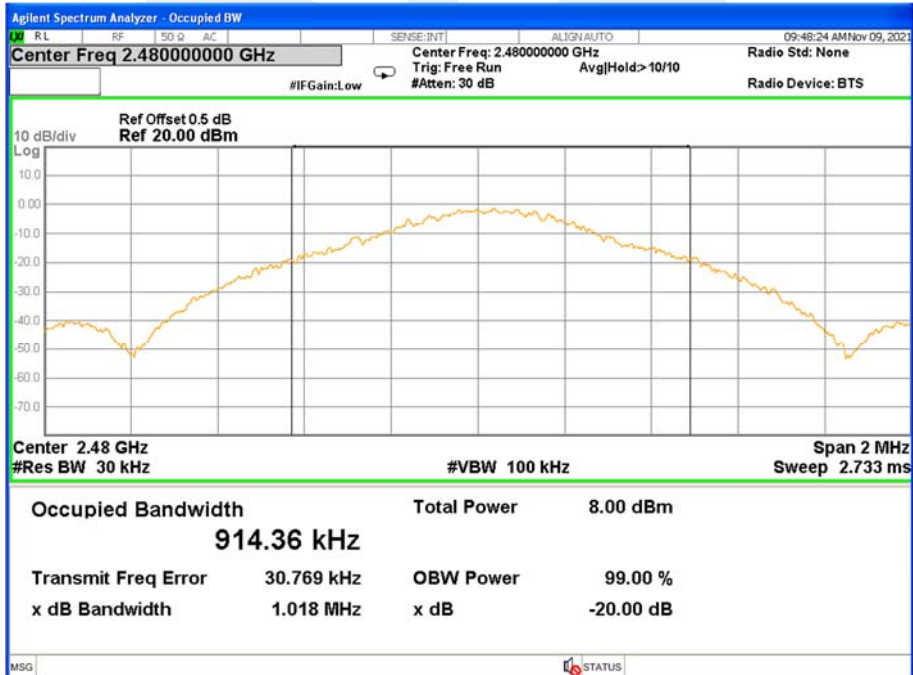



Temperature:	25°C	Relative Humidity:	50%
Test Mode:	$\pi/4$ -DQPSK(2Mbps) CH00 / CH39 / C78	Test Voltage:	DC 5V

Frequency	20dB Bandwidth (MHz)	Result
2402 MHz	1.2	PASS
2441 MHz	1.197	PASS
2480 MHz	1.194	PASS

### CH00 -2Mbps

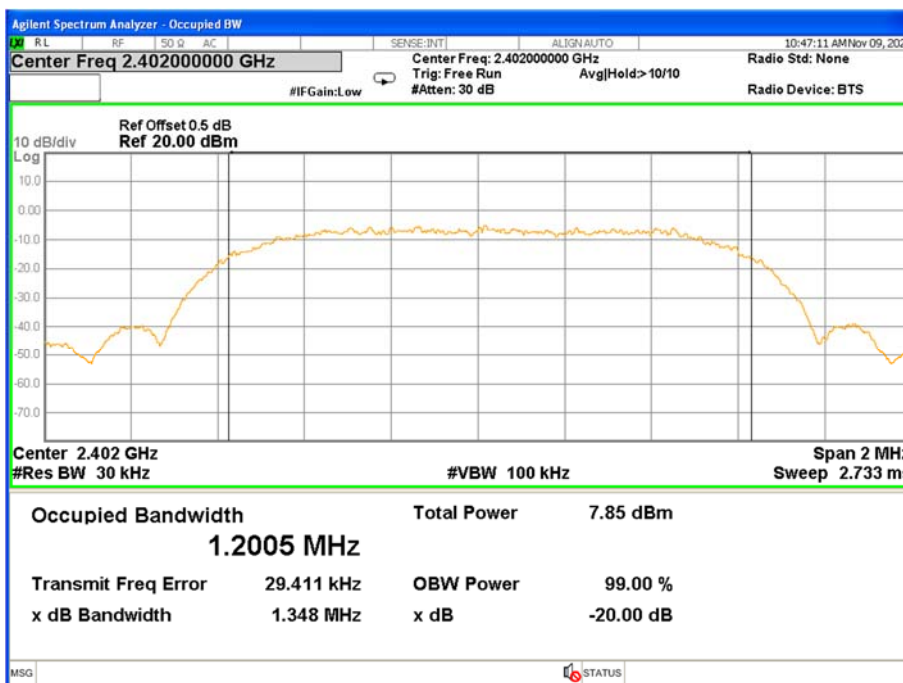



## CH39 -2Mbps

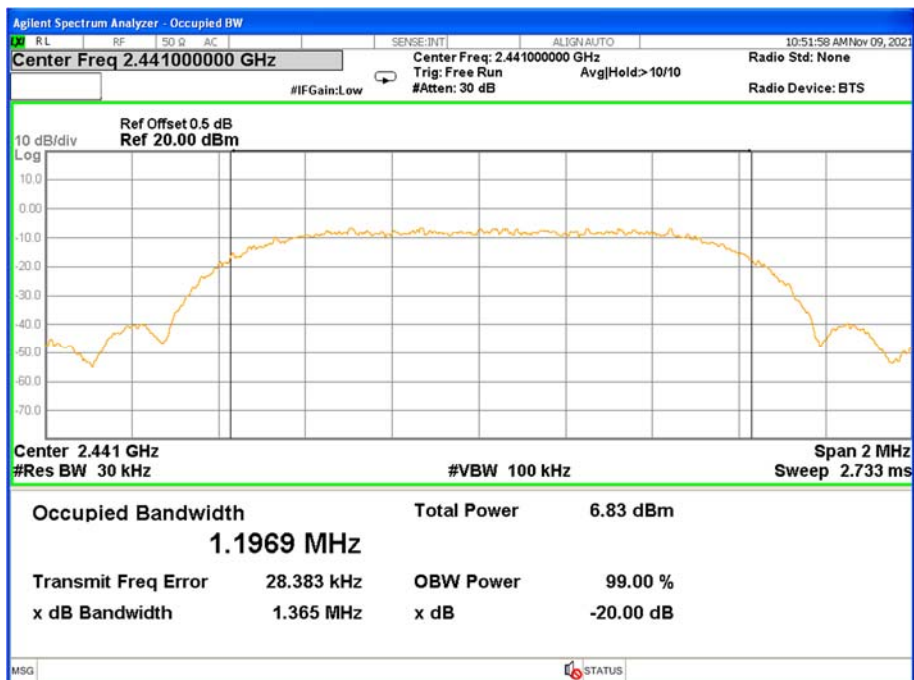

## CH78 -2Mbps

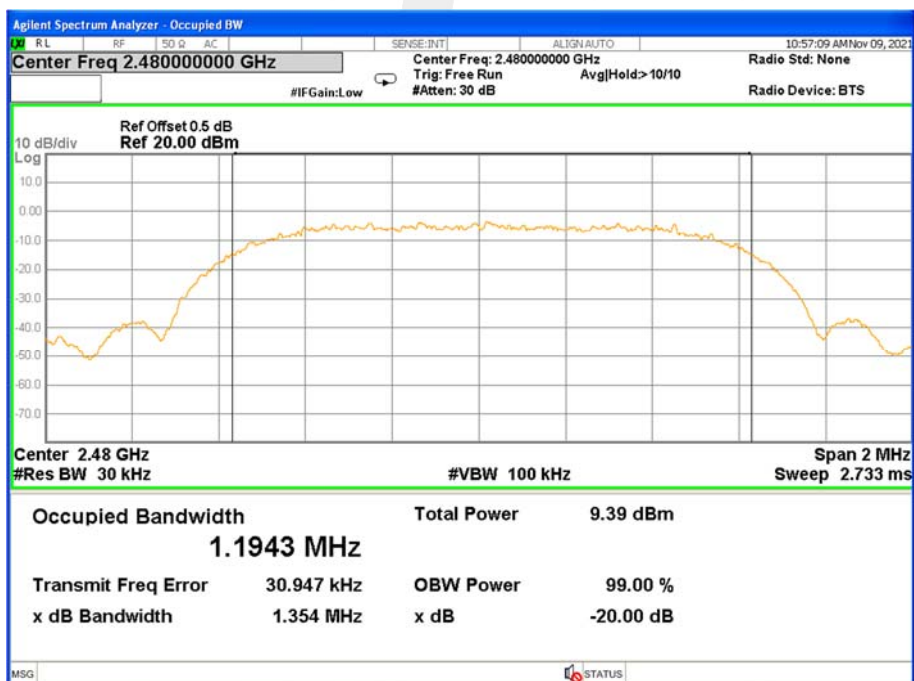



Temperature:	25°C	Relative Humidity:	50%
Test Mode:	8DPSK(3Mbps) CH00 / CH39 / CH78	Test Voltage:	DC 5V

Frequency	20dB Bandwidth (MHz)	Result
2402 MHz	1.196	PASS
2441 MHz	1.1938	PASS
2480 MHz	1.1915	PASS

CH00 -3Mbps

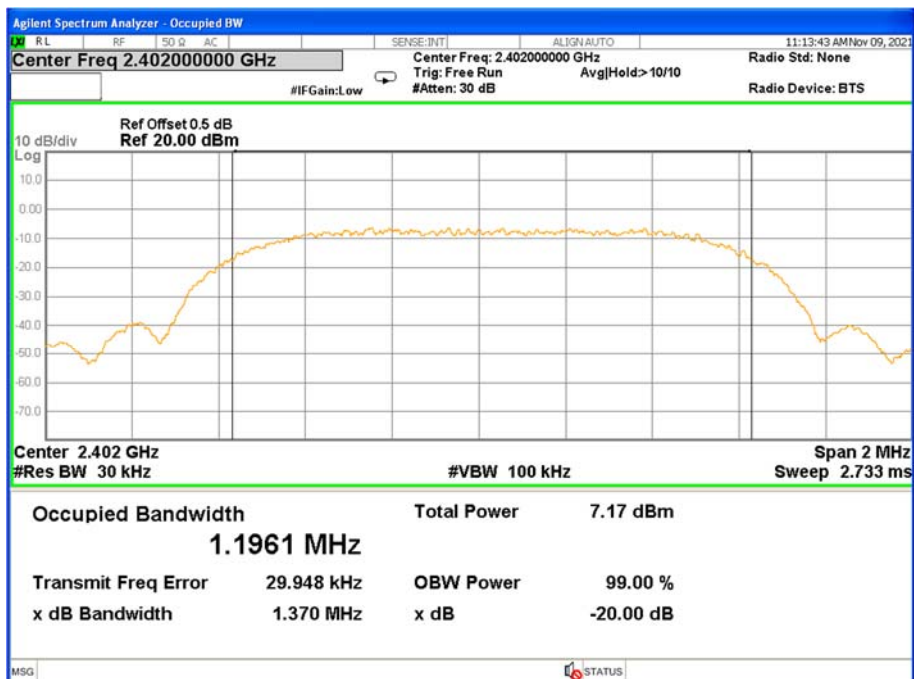



### CH39 -3Mbps

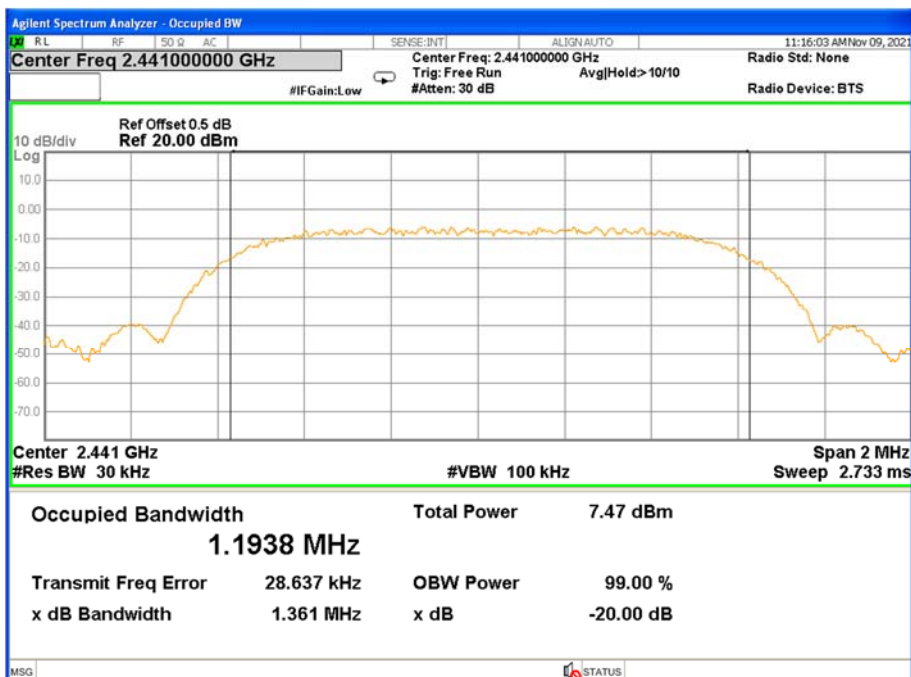

### CH78 -3Mbps

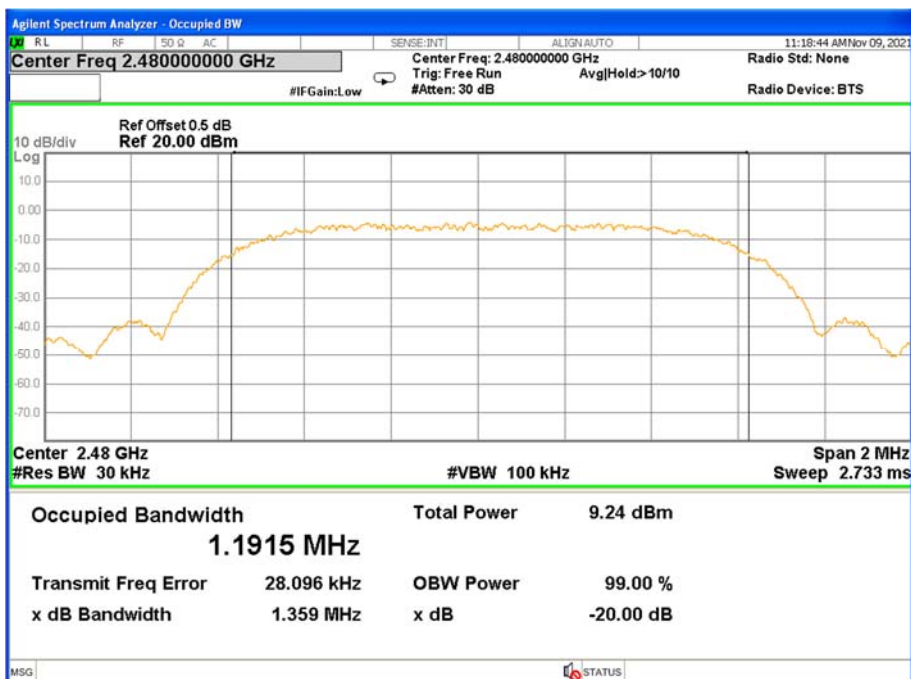

## 9. OUTPUT POWER TEST

### 9.1 LIMIT

FCC Part 15.247, Subpart C				
Section	Test Item	Limit	Frequency Range (MHz)	Result
15.247 (a)(1)&(b)(1)	Output Power	1 W or 0.125W	2400-2483.5	PASS
		if channel separation > 2/3 bandwidth provided the systems operate with an output power no greater than 125 mW (20.97dBm)		

### 9.2 TEST PROCEDURE

This is an RF-conducted test to evaluate maximum peak output power. Use a direct connection between the antenna port of the unlicensed wireless device and the spectrum analyzer, through suitable attenuation. The hopping shall be disabled for this test:

a) Use the following spectrum analyzer settings:

- 1) Span: Approximately five times the 20 dB bandwidth, centered on a hopping channel.
- 2) RBW > 20 dB bandwidth of the emission being measured.
- 3) VBW ≥ RBW.
- 4) Sweep: Auto.
- 5) Detector function: Peak.
- 6) Trace: Max hold.

b) Allow trace to stabilize.

c) Use the marker-to-peak function to set the marker to the peak of the emission.

d) The indicated level is the peak output power, after any corrections for external attenuators and cables.

e) A plot of the test results and setup description shall be included in the test report.

NOTE—A peak responding power meter may be used, where the power meter and sensor system video bandwidth is greater than the occupied bandwidth of the unlicensed wireless device, rather than a spectrum analyzer.

PKPM1 Peak power meter method:

The maximum peak conducted output power may be measured using a broadband peak RF power meter. The power meter shall have a video bandwidth that is greater than or equal to the DSS bandwidth and shall use a fast-responding diode detector.

### 9.3 TEST SETUP

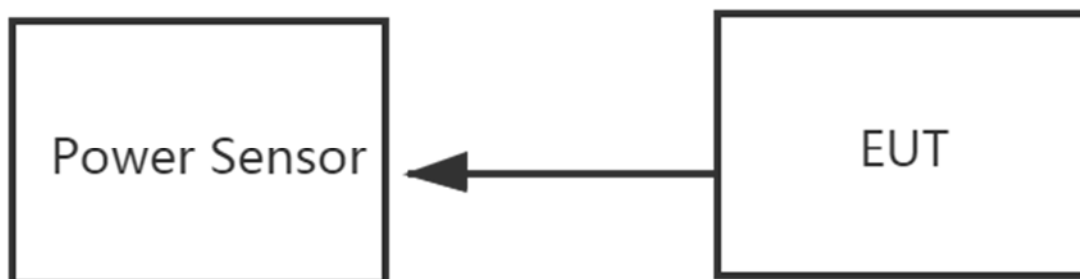

### 9.4 EUT OPERATION CONDITIONS

Please refer to section 3.1.4 of this report.





## 9.5 TEST RESULTS

Temperature:	25°C	Relative Humidity:	60%
Test Voltage:	DC 5V		

Mode	Channel Number	Frequency (MHz)	Peak Power	Average Power	Limit
			(dBm)	(dBm)	(dBm)
GFSK(1M)	0	2402	-0.54	-0.97	30.00
	39	2441	-0.81	-1.21	30.00
	78	2480	0.70	-0.33	30.00

Note: the channel separation >20dB bandwidth

Mode	Channel Number	Frequency (MHz)	Peak Power	Average Power	Limit
			(dBm)	(dBm)	(dBm)
$\pi/4$ -DQPSK(2M)	0	2402	1.63	-1.16	20.97
	39	2441	1.53	-1.30	20.97
	78	2480	2.52	-0.31	20.97

Note: the channel separation >2/3 20dB bandwidth

Mode	Channel Number	Frequency (MHz)	Peak Power	Average Power	Limit
			(dBm)	(dBm)	(dBm)
8-DPSK(3M)	0	2402	2.73	-0.66	20.97
	39	2441	2.43	0.89	20.97
	78	2480	3.42	0.05	20.97

Note: the channel separation >2/3 20dB bandwidth



## 10. ANTENNA REQUIREMENT

### 10.1 STANDARD REQUIREMENT

15.203 requirement: For intentional device, according to 15.203: an intentional radiator shall be designed to ensure that no antenna other than that furnished by the responsible party shall be used with the device.

### 10.2 EUT ANTENNA

The EUT antenna is External Antenna. It comply with the standard requirement.





## APPENDIX-PHOTOS OF TEST SETUP

Note: See test photos in setup photo document for the actual connections between Product and support equipment.

※※※※END OF THE REPORT※※※※※

