



RADIO TEST REPORT

Report No.: STS2202082W04

Issued for

Shenzhen EDUP Electronics Technology Co., Ltd.

6 Floor, #6 Building, No.48, Kangzheng Road, Liantang Industrial Area, Buji Town, Longgang District, Shenzhen, China

Product Name:	1200M Wireless Adapter with Bluetooth Function
Brand Name:	EDUP, EDUP HOME, EDUP LOVE, WISE TIGER, EPSKY, Card-King
Model Name:	EP-AC1690
Series Model:	EP-AC1690S, EP-AC1690GS, EP-AC1690-Pro, EP-1690, EP-1690S, EP-1690GS, EP-1690GS-Pro, EH-AC1690S, EH-AC1690GS, EH-AC1690, EH-AC1690-Pro, EH-1690, EH-1690S, EH-1690GS, EH-1690GS-Pro, WT-AC1690S, WT-AC1690GS, WT-AC1690, WT-AC1690-Pro, WT-1690, WT-1690S, WT-1690GS, WT-1690GS-Pro, KW-AC1690, KW-AC1690-Pro, KW-1690, KW-1690S, KW-1690GS, KW-1690GS-Pro, KW-AC1690S, KW-AC1690GS
FCC ID:	2AHRD-EPAC1690
Test Standard:	FCC Part 15.407

Any reproduction of this document must be done in full. No single part of this document may be reproduced without permission from STS, all test data presented in this report is only applicable to presented test sample.

Shenzhen STS Test Services Co., Ltd.
A 1/F, Building B, Zhuoke Science Park, No.190 Chongqing Road, HepingShequ,
Fuyong Sub-District, Bao'an District, Shenzhen, Guang Dong, China
TEL: +86-755 3688 6288 FAX: +86-755 3688 6277 E-mail: sts@stsapp.com





TEST RESULT CERTIFICATION

Applicant's Name : Shenzhen EDUP Electronics Technology Co.,Ltd.
Address : 6 Floor, #6 Building, No.48, Kangzheng Road, Liantang Industrial Area, Buji Town, Longgang District, Shenzhen, China
Manufacturer's Name : Shenzhen EDUP Electronics Technology Co.,Ltd.
Address : 6 Floor, #6 Building, No.48, Kangzheng Road, Liantang Industrial Area, Buji Town, Longgang District, Shenzhen, China

Product Description

Product Name : 1200M Wireless Adapter with Bluetooth Function
Brand Name : EDUP, EDUP HOME, EDUP LOVE, WISE TIGER, EPSKY, Card-King
Model Name : EP-AC1690
 EP-AC1690S, EP-AC1690GS, EP-AC1690-Pro, EP-1690, EP-1690S, EP-1690GS, EP-1690GS-Pro, EH-AC1690S, EH-AC1690GS, EH-AC1690, EH-AC1690-Pro, EH-1690, EH-1690S, EH-1690GS,
Series Model : EH-1690GS-Pro, WT-AC1690S, WT-AC1690GS, WT-AC1690, WT-AC1690-Pro, WT-1690, WT-1690S, WT-1690GS, WT-1690GS-Pro, KW-AC1690, KW-AC1690-Pro, KW-1690, KW-1690S, KW-1690GS, KW-1690GS-Pro, KW-AC1690S, KW-AC1690GS

Test Standards..... : FCC Part15.407

Test Procedure..... ANSI C63.10-2013

This device described above has been tested by STS, the test results show that the equipment under test (EUT) is in compliance with the FCC requirements. And it is applicable only to the tested sample identified in the report.

This report shall not be reproduced except in full, without the written approval of STS, this document only be altered or revised by STS, personal only, and shall be noted in the revision of the document.

Date of Test..... :
Date of receipt of test item : 21 Feb. 2022
Date (s) of performance of tests..... : 21 Feb. 2022 ~ 25 Feb. 2022
Date of Issue..... : 25 Feb. 2022
Test Result..... : **Pass**

Testing Engineer : *Chris Chen*

(Chris Chen)

Technical Manager : *Sean She*

(Sean she)

Authorized Signatory : *Vita Li*

(Vita Li)





Table of Contents	Page
1 . SUMMARY OF TEST RESULTS	6
1.1 TEST FACTORY	7
1.2 MEASUREMENT UNCERTAINTY	7
2 . GENERAL INFORMATION	8
2.1 GENERAL DESCRIPTION OF THE EUT	8
2.2 DESCRIPTION OF TEST MODES	10
2.3 TEST SOFTWARE AND POWER LEVEL	10
2.4 BLOCK DIAGRAM SHOWING THE CONFIGURATION OF SYSTEM TESTED	11
2.5 DESCRIPTION OF NECESSARY ACCESSORIES AND SUPPORT UNITS	12
2.6 EQUIPMENTS LIST FOR ALL TEST ITEMS	13
3 . EMC EMISSION TEST	14
3.1 CONDUCTED EMISSION MEASUREMENT	14
3.2 RADIATED EMISSION AND (BANDEDGE) MEASUREMENT	18
4. POWER SPECTRAL DENSITY TEST	38
4.1 LIMIT	38
4.2 TEST PROCEDURE	38
4.3 DEVIATION FROM STANDARD	39
4.4 TEST SETUP	39
4.5 EUT OPERATION CONDITIONS	39
4.6 TEST RESULTS	39
5. BANDWIDTH MEASUREMENT	40
5.1 EMISSION BANDWIDTH (EBW) 26 BANDWID PROCEDURES / LIMIT	40
5.2 OCCUPIED BANDWIDTH (99%) TEST APPLIED PROCEDURES / LIMIT	42
5.3 MINIMUM EMISSION BANDWIDTH(6 DB) PROCEDURES / LIMIT	44
6. MAXIMUM CONDUCTED OUTPUT POWER	46
6.1 LIMIT	46
6.2 TEST PROCEDURE	46
6.3 DEVIATION FROM STANDARD	46
6.4 TEST SETUP	46
6.5 EUT OPERATION CONDITIONS	46
6.6 TEST RESULTS	47
7. AUTOMATICALLY DISCONTINUE TRANSMISSION	50
7.1 LIMIT OF AUTOMATICALLY DISCONTINUE TRANSMISSION	50
7.2 TEST RESULT OF AUTOMATICALLY DISCONTINUE TRANSMISSION	50



Table of Contents	Page
8. ANTENNA REQUIREMENT	51
8.1 STANDARD REQUIREMENT	51
8.2 EUT ANTENNA	51
APPENDIX - PHOTOS OF TEST SETUP	52





Revision History

Rev.	Issue Date	Report NO.	Effect Page	Contents
00	25 Feb. 2022	STS2202082W04	ALL	Initial Issue





1. SUMMARY OF TEST RESULTS

Test procedures according to the technical standards:

§ 15.407, KDB 789033 D02 General U-NII Test Procedures New Rules v02r01.

FCC Part 15.407		
FCC standard	Test Item	Results
15.207	AC Conducted Emission	PASS
15.407 (a) /15.407 (e)	26dB/6dB &99% Bandwidth	PASS
15.407(a)	Maximum Conducted Output Power	PASS
15.407(b)/15.205/15.209	Radiated Emission And (bandedge Emissions) Measurement	PASS
15.407(a)	Power Spectral Density	PASS
15.407(c)	Automatically Discontinue Transmission	PASS
15.203	Antenna Requirement	PASS

NOTE:

(1) 'N/A' denotes test is not applicable in this Test Report.

(2) All tests are according to ANSI C63.10-2013.



1.1 TEST FACTORY

SHENZHEN STS TEST SERVICES CO., LTD

Add. : A 1/F, Building B, Zhuoke Science Park, No.190 Chongqing Road, HepingShequ, Fuyong Sub-District, Bao'an District, Shenzhen, Guang Dong, China

FCC test Firm Registration Number: 625569

IC test Firm Registration Number: 12108A

A2LA Certificate No.: 4338.01

1.2 MEASUREMENT UNCERTAINTY

The reported uncertainty of measurement $y \pm U$, where expanded uncertainty U is based on a standard uncertainty multiplied by a coverage factor of $k=2$, providing a level of confidence of approximately **95 %**.

No.	Item	Uncertainty
1	RF output power, conducted	$\pm 0.87\text{dB}$
2	Unwanted Emissions, conducted	$\pm 2.895\text{dB}$
3	All emissions, radiated 9K-30MHz	$\pm 3.80\text{dB}$
4	All emissions, radiated 30M-1GHz	$\pm 4.09\text{dB}$
5	All emissions, radiated 1G-6GHz	$\pm 4.92\text{dB}$
6	All emissions, radiated >6G	$\pm 5.49\text{dB}$
7	Conducted Emission (9KHz-30MHz)	$\pm 2.73\text{dB}$



2. GENERAL INFORMATION

2.1 GENERAL DESCRIPTION OF THE EUT

Product Name	1200M Wireless Adapter with Bluetooth Function	
Trade Name	EDUP, EDUP HOME, EDUP LOVE, WISE TIGER, EPSKY, Card-King	
Model Name	EP-AC1690	
Series Model	EP-AC1690S, EP-AC1690GS, EP-AC1690-Pro, EP-1690, EP-1690S, EP-1690GS, EP-1690GS-Pro, EH-AC1690S, EH-AC1690GS, EH-AC1690, EH-AC1690-Pro, EH-1690, EH-1690S, EH-1690GS, EH-1690GS-Pro, WT-AC1690S, WT-AC1690GS, WT-AC1690, WT-AC1690-Pro, WT-1690, WT-1690S, WT-1690GS, WT-1690GS-Pro, KW-AC1690, KW-AC1690-Pro, KW-1690, KW-1690S, KW-1690GS, KW-1690GS-Pro, KW-AC1690S, KW-AC1690GS	
Model Difference	Different appearance size and shape	
Product Description	The EUT is a 1200M Wireless Adapter with Bluetooth Function	
	Operation Frequency:	IEEE 802.11a/ n(HT20)/ac(VHT20): 5.745GHz-5.825GHz IEEE 802.11n(HT40)/ac(VHT40): 5.755GHz-5.795GHz IEEE 802.11ac(VHT80): 5.775GHz
	Modulation Type:	802.11a(OFDM): BPSK,QPSK,16-QAM,64-QAM 802.11n(OFDM): BPSK,QPSK,16-QAM,64-QAM 802.11ac(OFDM): BPSK,QPSK,16-QAM,64-QAM,256-QAM
	Antenna Designation:	Please refer to the Note 3.
	Max.Output Power(Conducted):	12.61 dBm
More details of EUT technical specification, please refer to the User's Manual.		
Test Channel	Please refer to the Note 2.	
Rating	Input: DC 5V	
Hardware version number	V1.0	
Software version number	V6.08	
Connecting I/O Port(s)	Please refer to the Note 1.	

Note:

- For a more detailed features description, please refer to the manufacturer's specifications or the User Manual.



2. Operation Frequency of channel
5.745GHz-5.825GHz

Channel	Frequency
149	5745
151	5755
153	5765
157	5785
159	5795
161	5805
165	5825

Note:

In section 15.31(m), regards to the operating frequency range over 10 MHz, the Lowest frequency, the middle frequency, and the highest frequency of channel were selected to perform the test, and the selected channel see below:

Carrier Frequency Channel

5GHz:

For 802.11a/n(HT20) /ac (VHT20)

Channel	Freq.(MHz)
149	5745
157	5785
165	5825

For 802.11n(HT40) /ac (VHT40)

Channel	Freq.(MHz)
151	5755
159	5795

For 802.11ac (VHT80)

Channel	Freq.(MHz)
155	5775

3.

Ant	Brand	Model Name	Ant Type	Connector	Gain (dBi)	NOTE
A	EDUP, EDUP HOME, EDUP LOVE, WISE TIGER, EPSKY, Card-King	EP-AC1690	Dipole	N/A	2dBi	WLAN Ant.

Note: The antenna information refer the manufacturer provide report, applicable only to the tested sample identified in the report.



2.2 DESCRIPTION OF TEST MODES

To investigate the maximum EMI emission characteristics generates from EUT, the test system was pre-scanning tested base on the consideration of following EUT operation mode or test configuration mode which possible have effect on EMI emission level. Each of these EUT operation mode(s) or test configuration mode(s) mentioned above was evaluated respectively.

Worst Mode	Description	Data Rate
Mode 1	TX IEEE 802.11a HT20 CH149&CH157&CH165	6 Mbps
Mode 2	TX IEEE 802.11n HT20 CH149&CH157&CH165	MCS 0
Mode 3	TX IEEE 802.11ac VHT20 CH149&CH157&CH165	NSS1 MCS0
Mode 4	TX IEEE 802.11n HT40 CH151&CH159	MCS 0
Mode 5	TX IEEE 802.11ac VHT40 CH151&CH159	NSS1 MCS0
Mode 6	TX IEEE 802.11ac VHT80 CH155	NSS1 MCS0

- Note: (1) The measurements are performed at the highest, middle, lowest available channels.
 (2) The measurements are performed at all Bit Rate of Transmitter, the worst data was reported.
 (3) We have be tested for all avaiable U.S. voltage and frequencies(For 120V,50/60Hz and 240V, 50/60Hz) for which the device is capable of operation.
 (4) The battery is fully-charged during the radited and RF conducted test.

AC Conducted Emission

Test Case	
AC Conducted Emission	Mode 7: Keeping TX + WLAN Link

2.3 TEST SOFTWARE AND POWER LEVEL

During testing channel & power controlling software provided by the customer was used to control the operating channel as well as the output power level.

RF Function	Type	Mode Or Modulation type	ANT Gain(dBi)	Power Class	Software For Testing
WIFI(5G)	U-NII-3 (5725MHz-5875MHz)	802.11a	2	Default	MP Tool
		802.11n(HT20)		Default	
		802.11n(HT40)		Default	
		802.11ac(VHT20)		Default	
		802.11ac(VHT40)		Default	
		802.11ac(VHT80)		Default	

2.4 BLOCK DIAGRAM SHOWING THE CONFIGURATION OF SYSTEM TESTED

Radiated Spurious Emission Test

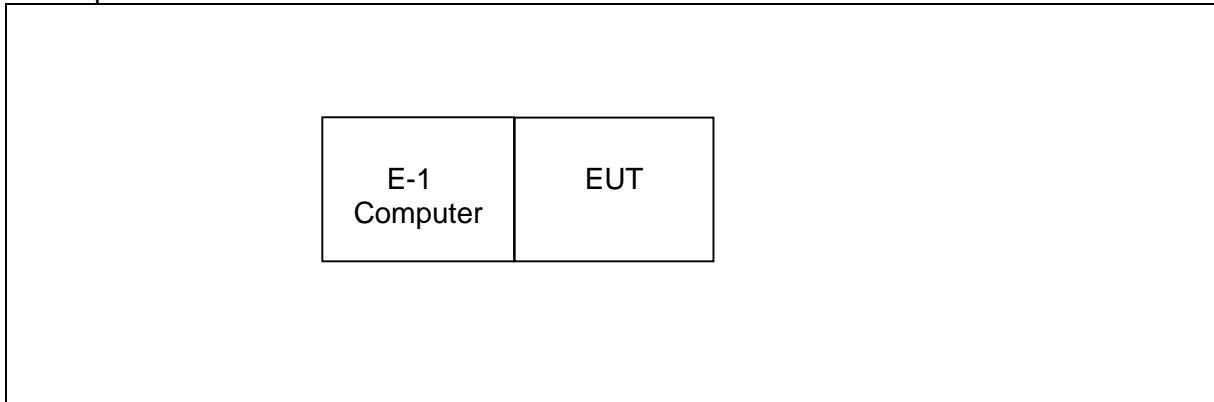

Conducted Emission Test

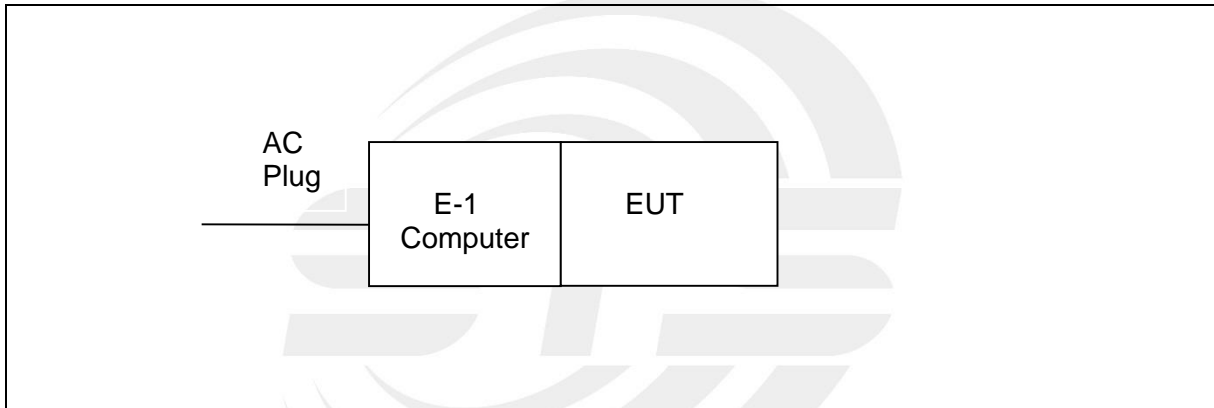



2.5 DESCRIPTION OF NECESSARY ACCESSORIES AND SUPPORT UNITS

The EUT has been tested as an independent unit together with other necessary accessories or support units. The following support units or accessories were used to form a representative test configuration during the tests.

Necessary accessories

Item	Equipment	Mfr/Brand	Model/Type No.	Length	Note
N/A	N/A	N/A	N/A	N/A	N/A

Support units

Item	Equipment	Mfr/Brand	Model/Type No.	Length	Note
E-1	Computer	HP	880-190cn	N/A	N/A

Note:

- (1) For detachable type I/O cable should be specified the length in cm in 『Length』 column.
- (2) “YES” is means “with core”; “NO” is means “without core”.



2.6 EQUIPMENTS LIST FOR ALL TEST ITEMS

Radiation Test equipment

Kind of Equipment	Manufacturer	Type No.	Serial No.	Last calibration	Calibrated until
Test Receiver	R&S	ESCI	101427	2021.09.30	2022.09.29
Signal Analyzer	Agilent	N9020A	MY51110105	2021.09.30	2022.09.29
Active loop Antenna	ZHINAN	ZN30900C	16035	2021.04.11	2023.04.10
Bilog Antenna	TESEQ	CBL6111D	34678	2020.10.12	2022.10.11
Horn Antenna	SCHWARZBECK	BBHA 9120D(1201)	9120D-1343	2021.10.11	2023.10.10
SHF-EHF Horn Antenna (18G-40GHz)	A-INFO	LB-180400-KF	J211020657	2020.10.12	2022.10.11
Pre-Amplifier (0.1M-3GHz)	EM	EM330	060665	2021.10.08	2022.10.07
Pre-Amplifier (1G-18GHz)	SKET	LNPA-01018G-45	SK2018080901	2021.09.30	2022.09.29
Pre-Amplifier (18G-40GHz)	SKET	LNPA-1840-50	SK2018101801	2021.09.28	2022.09.27
Temperature & Humidity	HH660	Mieo	N/A	2021.10.09	2022.10.08
turn table	EM	SC100_1	60531	N/A	N/A
Antenna mast	EM	SC100	N/A	N/A	N/A
Test SW	FARAD	EZ-EMC(Ver.STSLAB-03A1 RE)			

Conduction Test equipment

Kind of Equipment	Manufacturer	Type No.	Serial No.	Last calibration	Calibrated until
Test Receiver	R&S	ESCI	101427	2021.09.30	2022.09.29
LISN	R&S	ENV216	101242	2021.09.30	2022.09.29
LISN	EMCO	3810/2NM	23625	2021.09.30	2022.09.29
Temperature & Humidity	HH660	Mieo	N/A	2021.10.09	2022.10.08
Test SW	FARAD	EZ-EMC(Ver.STSLAB-03A1 CE)			

RF Connected Test

Kind of Equipment	Manufacturer	Type No.	Serial No.	Last calibration	Calibrated until
Power Sensor	Keysight	U2021XA	MY55520005	2021.09.30	2022.09.29
			MY55520006	2021.09.30	2022.09.29
			MY56120038	2021.09.30	2022.09.29
			MY56280002	2021.09.30	2022.09.29
Signal Analyzer	Agilent	N9020A	MY51110105	2021.03.04	2022.03.03
Temperature & Humidity	HH660	Mieo	N/A	2021.10.09	2022.10.08
Test SW	FARAD	LZ-RF /LzRf-3A3			



3. EMC EMISSION TEST

3.1 CONDUCTED EMISSION MEASUREMENT

3.1.1 POWER LINE CONDUCTED EMISSION Limits (Frequency Range 150KHz-30MHz)

FREQUENCY (MHz)	Class B (dBuV)		Standard
	Quasi-peak	Average	
0.15 -0.5	66 - 56 *	56 - 46 *	CISPR
0.50 -5.0	56.00	46.00	CISPR
5.0 -30.0	60.00	50.00	CISPR

0.15 -0.5	66 - 56 *	56 - 46 *	FCC
0.50 -5.0	56.00	46.00	FCC
5.0 -30.0	60.00	50.00	FCC

Note:

- (1) The tighter limit applies at the band edges.
- (2) The limit of “ * ” marked band means the limitation decreases linearly with the logarithm of the frequency in the range.

The following table is the setting of the receiver

Receiver Parameters	Setting
Attenuation	10 dB
Start Frequency	0.15 MHz
Stop Frequency	30 MHz
IF Bandwidth	9 kHz

3.1.2 TEST PROCEDURE

- a. The EUT is 0.8 m from the horizontal ground plane and 0.4 m from the vertical ground plane with EUT being connected to the power mains through a line impedance stabilization network (LISN). All other support equipments are powered from additional LISN(s). The LISN provides 50 Ohm/ 50uH of coupling impedance for the measuring instrument.
- b. Interconnecting cables that hang closer than 40 cm to the ground plane shall be folded back and forth in the center forming a bundle 30 to 40 cm long.
- c. I/O cables that are not connected to a peripheral shall be bundled in the center. The end of the cable may be terminated, if required, using the correct terminating impedance. The overall length shall not exceed 1 m.
- d. LISN is at least 80 cm from the nearest part of EUT chassis.
- e. For the actual test configuration, please refer to the related Item –EUT Test Photos.

3.1.3 DEVIATION FROM TEST STANDARD

No deviation

3.1.4 TEST SETUP

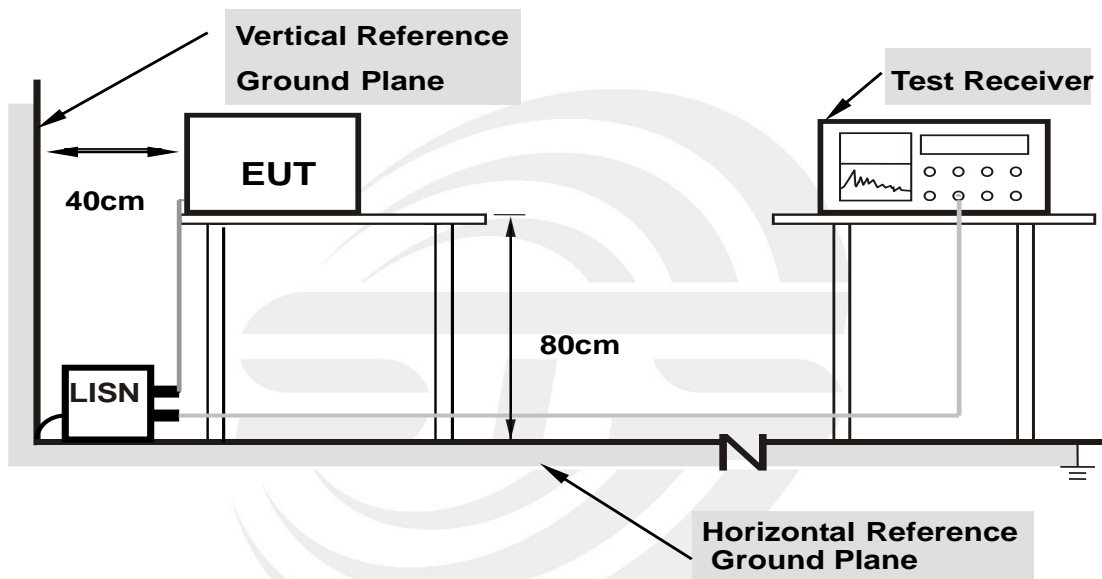

Note: 1. Support units were connected to second LISN.

2. Both of LISNs (AMN) are 80 cm from EUT and at least 80 cm from other units and other metal planes support units.

3.1.5 EUT OPERATING CONDITIONS

The EUT was configured for testing in a typical fashion (as a customer would normally use it). The EUT has been programmed to continuously transmit during test. This operating condition was tested and used to collect the included data.



3.1.6 TEST RESULTS

Temperature:	23.2(C)	Relative Humidity:	44%RH
Test Voltage:	AC 120V/60Hz	Phase:	L
Test Mode :	Mode 7		

No.	Frequency (MHz)	Reading (dBUV)	Correct Factor(dB)	Result (dBUV)	Limit (dBUV)	Margin (dB)	Remark
1	0.5940	23.88	20.43	44.31	56.00	-11.69	QP
2	0.5940	21.22	20.43	41.65	46.00	-4.35	AVG
3	0.7660	23.69	20.35	44.04	56.00	-11.96	QP
4	0.7660	21.14	20.35	41.49	46.00	-4.51	AVG
5	0.9380	23.52	20.31	43.83	56.00	-12.17	QP
6	0.9380	21.48	20.31	41.79	46.00	-4.21	AVG
7	1.2740	22.97	20.33	43.30	56.00	-12.70	QP
8	1.2740	20.78	20.33	41.11	46.00	-4.89	AVG
9	1.6100	23.04	20.35	43.39	56.00	-12.61	QP
10	1.6100	18.40	20.35	38.75	46.00	-7.25	AVG
11	2.1340	21.87	20.39	42.26	56.00	-13.74	QP
12	2.1340	18.88	20.39	39.27	46.00	-6.73	AVG

Remark:

1. All readings are Quasi-Peak and Average values
2. Margin = Result (Result =Reading + Factor)–Limit
3. Factor=LISN factor+Cable loss+Limiter (10dB)

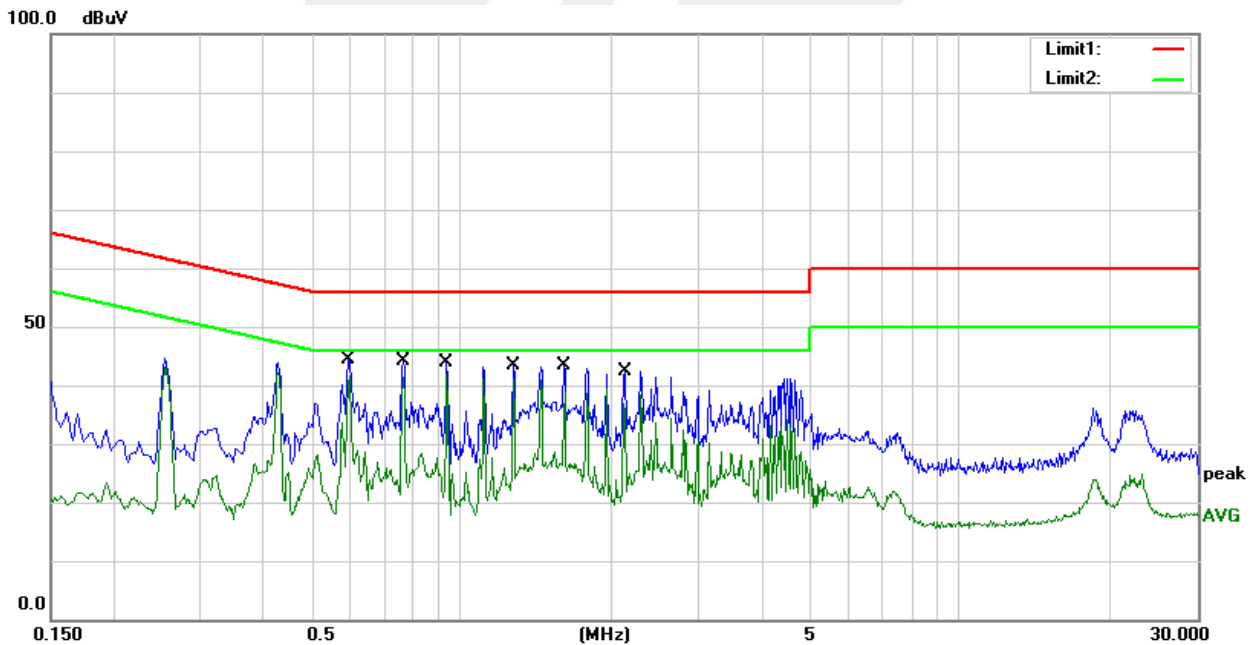



Temperature:	23.2(C)	Relative Humidity:	44%RH
Test Voltage	AC 120V/60Hz	Phase:	N
Test Mode	Mode 7		

No.	Frequency (MHz)	Reading (dBUV)	Correct Factor(dB)	Result (dBUV)	Limit (dBUV)	Margin (dB)	Remark
1	0.4260	23.53	20.55	44.08	57.33	-13.25	QP
2	0.4260	21.26	20.55	41.81	47.33	-5.52	AVG
3	0.5980	24.13	20.43	44.56	56.00	-11.44	QP
4	0.5980	21.36	20.43	41.79	46.00	-4.21	AVG
5	0.7660	23.40	20.35	43.75	56.00	-12.25	QP
6	0.7660	21.72	20.35	42.07	46.00	-3.93	AVG
7	0.9420	23.13	20.31	43.44	56.00	-12.56	QP
8	0.9420	21.10	20.31	41.41	46.00	-4.59	AVG
9	1.1060	22.81	20.31	43.12	56.00	-12.88	QP
10	1.1060	20.71	20.31	41.02	46.00	-4.98	AVG
11	1.2660	23.13	20.33	43.46	56.00	-12.54	QP
12	1.2660	20.05	20.33	40.38	46.00	-5.62	AVG

Remark:

1. All readings are Quasi-Peak and Average values
2. Margin = Result (Result =Reading + Factor) –Limit
3. Factor=LISN factor+Cable loss+Limiter (10dB)

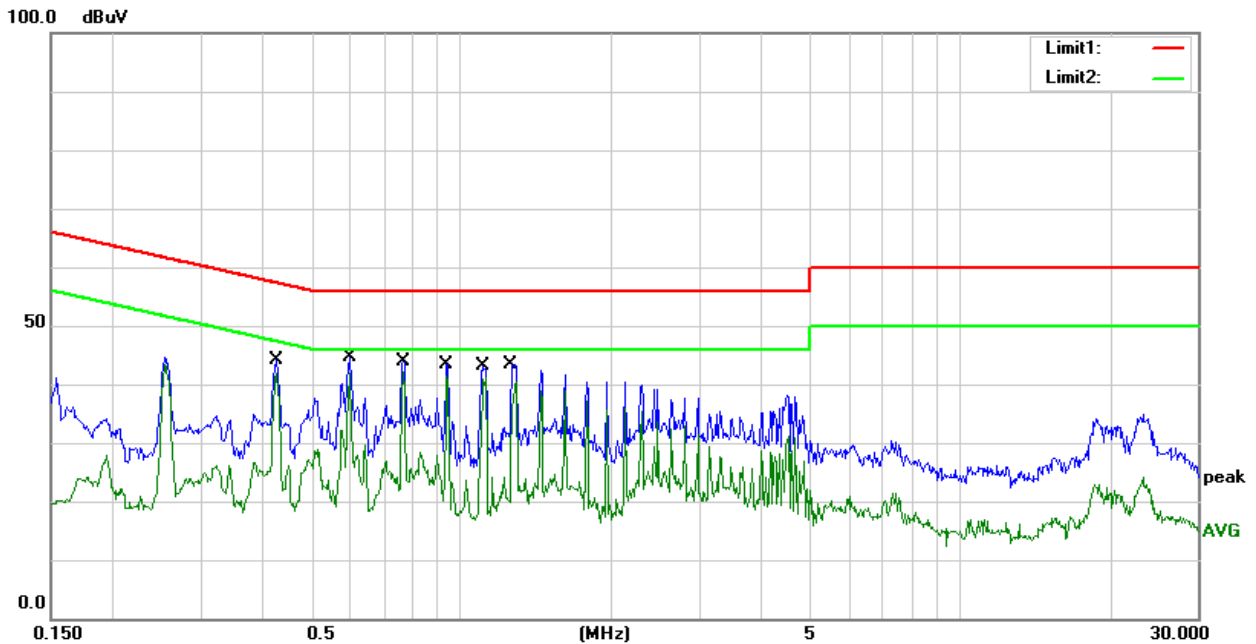

3.2 RADIATED EMISSION AND (BANDEDGE) MEASUREMENT

3.2.1 RADIATED EMISSION LIMITS (Frequency Range 9kHz-1000MHz)

In case the emission fall within the restricted band specified on 15.407(b)7& 15.205/209(a), then the limit in the table below has to be followed.

Frequencies (MHz)	Field Strength (microrvolts/meter)	Measurement Distance (meters)
0.009~0.490	2400/F(KHz)	300
0.490~1.705	24000/F(KHz)	30
1.705~30.0	30	30
30~88	100	3
88~216	150	3
216~960	200	3
Above 960	500	3

LIMITS OF RADIATED EMISSION MEASUREMENT (Above 1000MHz)

FREQUENCY (MHz)	Class B (dBuV/m) (at 3M)	
	PEAK	AVERAGE
Above 1000	68.2	54

Notes:

- (1) The limit for radiated test was performed according to FCC PART 15E.
- (2) The tighter limit applies at the band edges.
- (3) Emission level (dBuV/m)=20log Emission level (uV/m).

LIMITS OF RESTRICTED FREQUENCY BANDS

FREQUENCY (MHz)	FREQUENCY (MHz)	FREQUENCY (MHz)	FREQUENCY (GHz)
0.090-0.110	16.42-16.423	399.9-410	4.5-5.15
0.495-0.505	16.69475-16.69525	608-614	5.35-5.46
2.1735-2.1905	16.80425-16.80475	960-1240	7.25-7.75
4.125-4.128	25.5-25.67	1300-1427	8.025-8.5
4.17725-4.17775	37.5-38.25	1435-1626.5	9.0-9.2
4.20725-4.20775	73-74.6	1645.5-1646.5	9.3-9.5
6.215-6.218	74.8-75.2	1660-1710	10.6-12.7
6.26775-6.26825	108-121.94	1718.8-1722.2	13.25-13.4
6.31175-6.31225	123-138	2200-2300	14.47-14.5
8.291-8.294	149.9-150.05	2310-2390	15.35-16.2
8.362-8.366	156.52475-156.52525	2483.5-2500	17.7-21.4
8.37625-8.38675	156.7-156.9	2690-2900	22.01-23.12
8.41425-8.41475	162.0125-167.17	3260-3267	23.6-24.0
12.29-12.293	167.72-173.2	3332-3339	31.2-31.8
12.51975-12.52025	240-285	3345.8-3358	36.43-36.5
12.57675-12.57725	322-335.4	3600-4400	Above 38.6
13.36-13.41			

Note: In case the emission radiated emission above 1000MHz fall within the restricted band the restricted frequency bands, the peak limit is 74 dBuV/m.

**LIMITS OF EMISSIONS OUTSIDE OF THE FREQUENCY BANDS**

Undesirable emission limits. Except as shown in paragraph (b)(7) of this section, the maximum emissions outside of the frequency bands of operation shall be attenuated in accordance with the following limits:

((1) For transmitters operating in the 5.15-5.25 GHz band: All emissions outside of the 5.15-5.35 GHz band shall not exceed an e.i.r.p. of -27 dBm/MHz.

(2) For transmitters operating in the 5.25-5.35 GHz band: All emissions outside of the 5.15-5.35 GHz band shall not exceed an e.i.r.p. of -27 dBm/MHz.

(3) For transmitters operating in the 5.47-5.725 GHz band: All emissions outside of the 5.47-5.725 GHz band shall not exceed an e.i.r.p. of -27 dBm/MHz.

(4) For transmitters operating in the 5.725-5.85 GHz band:

(i) All emissions shall be limited to a level of -27 dBm/MHz at 75 MHz or more above or below the band edge increasing linearly to 10 dBm/MHz at 25 MHz above or below the band edge, and from 25 MHz above or below the band edge increasing linearly to a level of 15.6 dBm/MHz at 5 MHz above or below the band edge, and from 5 MHz above or below the band edge increasing linearly to a level of 27 dBm/MHz at the band edge.

Note: dBuV/m(at 3M) = EIRP(dBm) + 95.2.

Peak Limit = -27dBm/MHz + 95.3 = 68.2 dBuV/m.

Spectrum Parameter	Setting
Attenuation	Auto
Detector	Peak
Start Frequency	1000 MHz(Peak/AV)
Stop Frequency	10th carrier harmonic (Peak/AV)
RB / VB (emission in restricted band)	1 MHz / 1 MHz, AV=1 MHz /3 MHz

For Band edge

Spectrum Parameter	Setting
Detector	Peak
RB / VB (emission in restricted band)	1 MHz / 1 MHz, AV=1 MHz /3 MHz

Receiver Parameter	Setting
Attenuation	Auto
Start ~ Stop Frequency	9kHz~90kHz / RB 200Hz for PK & AV
Start ~ Stop Frequency	90kHz~110kHz / RB 200Hz for QP
Start ~ Stop Frequency	110kHz~490kHz / RB 200Hz for PK & AV
Start ~ Stop Frequency	490kHz~30MHz / RB 9kHz for QP
Start ~ Stop Frequency	30MHz~1000MHz / RB 120kHz for QP



3.2.2 TEST PROCEDURE

- a. The measuring distance at 3 m shall be used for measurements at frequency 0.009MHz up to 1GHz, and above 1GHz.
- b. The EUT was placed on the top of a rotating table 0.8 m (above 1GHz is 1.5 m) above the ground at a 3 m anechoic chamber test site. The table was rotated 360 degree to determine the position of the highest radiation.
- c. The height of the equipment shall be 0.8 m (above 1GHz is 1.5 m); the height of the test antenna shall vary between 1 m to 4 m. Horizontal and vertical polarization of the antenna are set to make the measurement.
- d. The initial step in collecting conducted emission data is a spectrum analyzer peak detector mode pre-scanning the measurement frequency range. Significant peaks are then marked and QuasiPeak detector mode will be re-measured.
- e. If the Peak Mode measured value is compliance with and lower than Quasi Peak Mode Limit, the EUT shall be deemed to meet QP Limits and no additional QP Mode measurement was performed.
- f. For the actual test configuration, please refer to the related Item –EUT Test Photos.

Note:

Both horizontal and vertical antenna polarities were tested and performed pretest to three orthogonal axis. The worst case emissions were reported.

3.2.2 DEVIATION FROM TEST STANDARD

No deviation



3.2.3 TEST SETUP

(A) Radiated Emission Test-Up Frequency Below 30MHz

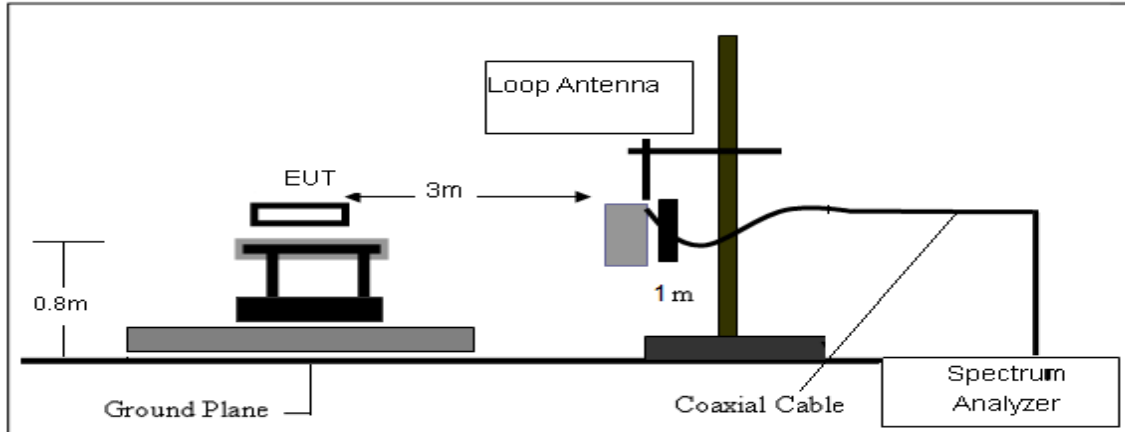

(B) Radiated Emission Test-Up Frequency 30MHz~1GHz

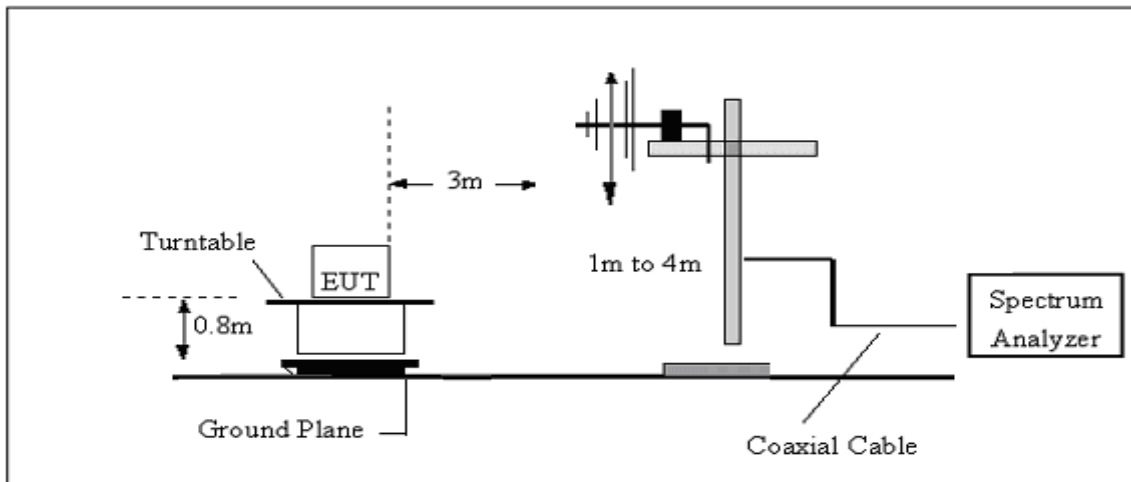

(C) Radiated Emission Test-Up Frequency Above 1GHz

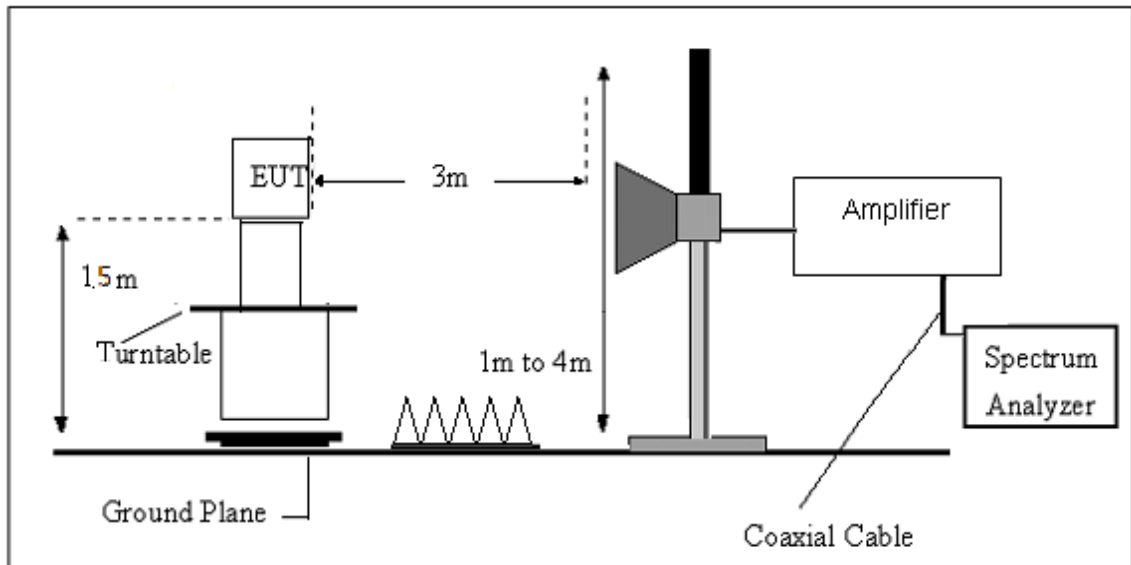



3.2.4 EUT OPERATING CONDITIONS

The EUT tested system was configured as the statements of 2.4 Unless otherwise a special operating condition is specified in the follows during the testing.

3.2.5 FIELD STRENGTH CALCULATION

The field strength is calculated by adding the Antenna Factor and Cable Factor and subtracting the Amplifier Gain and Duty Cycle Correction Factor (if any) from the measured reading. The basic equation with a sample calculation is as follows:

$$FS = RA + AF + CL - AG$$

Where

FS = Field Strength

CL = Cable Attenuation Factor (Cable Loss)

RA = Reading Amplitude

AG = Amplifier Gain

AF = Antenna Factor

For example

Frequency (MHz)	FS (dB μ V/m)	RA (dB μ V/m)	AF (dB)	CL (dB)	AG (dB)	Factor (dB)
300	40	58.1	12.2	1.6	31.9	-18.1

$$\text{Factor} = \text{AF} + \text{CL} - \text{AG}$$

**3.2.6 TEST RESULTS (Between 9KHz – 30 MHz)**

Temperature:	23.1(C)	Relative Humidity:	60%RH
Test Voltage:	DC 5V	Polarization :	--
Test Mode:	TX Mode		

Freq. (MHz)	Reading (dBuV/m)	Limit (dBuV/m)	Margin (dB)	State P/F
--	--	--	--	PASS
--	--	--	--	PASS

Note:

The amplitude of spurious emissions which are attenuated by more than 20dB below the permissible value has no need to be reported.

Distance extrapolation factor = $40 \log(\text{specific distance}/\text{test distance})$ (dB);

Limit line = specific limits(dBuv) + distance extrapolation factor.

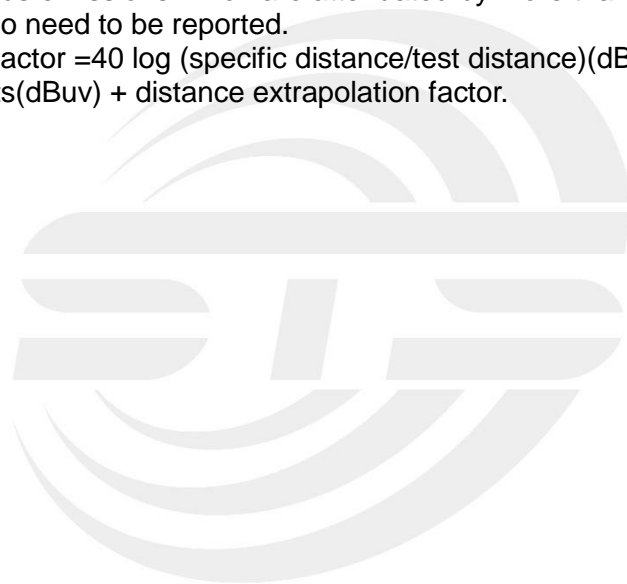



3.2.7 TEST RESULTS (Between 30MHz – 1GHz)

Temperature	23.1(C)	Relative Humidity:	60%RH
Test Voltage	DC 5V	Polarization:	Horizontal
Test Mode	Mode 1~6(Mode 1 worst mode)		

No.	Frequency (MHz)	Reading (dBuV)	Correct Factor(dB/m)	Result (dBuV/m)	Limit (dBuV/m)	Margin (dB)	Remark
1	128.9400	28.93	-18.26	10.67	43.50	-32.83	peak
2	335.5500	29.31	-13.54	15.77	46.00	-30.23	peak
3	506.2700	27.46	-7.97	19.49	46.00	-26.51	peak
4	733.2500	27.83	-2.35	25.48	46.00	-20.52	peak
5	840.9200	27.38	-0.38	27.00	46.00	-19.00	peak
6	978.6600	27.95	2.58	30.53	54.00	-23.47	peak

Remark:

1. Margin = Result (Result =Reading + Factor) –Limit
2. Factor= Antenna factor+Cable attenuation factor(cable loss)-Amplifier gain

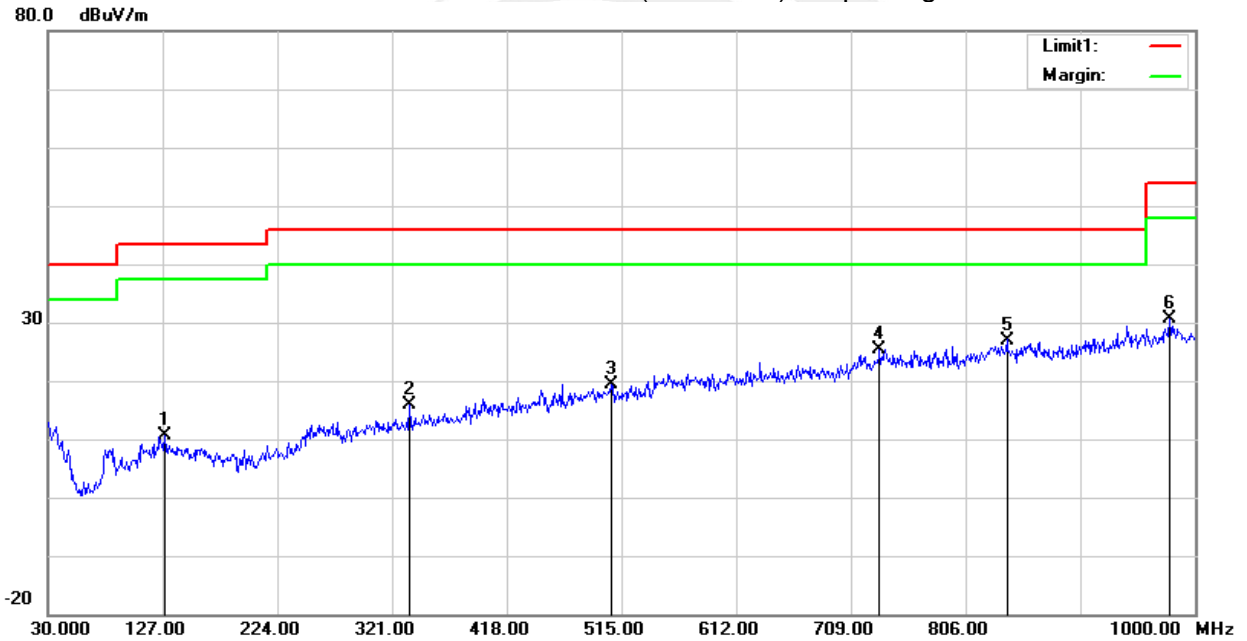



Temperature	23.1(C)	Relative Humidity:	60%RH
Test Voltage	DC 5V	Polarization:	Vertical
Test Mode	Mode 1~6(Mode 1 worst mode)		

No.	Frequency (MHz)	Reading (dBuV)	Correct Factor(dB/m)	Result (dBuV/m)	Limit (dBuV/m)	Margin (dB)	Remark
1	83.3500	48.53	-22.52	26.01	40.00	-13.99	peak
2	255.0400	28.84	-15.35	13.49	46.00	-32.51	peak
3	397.6300	32.74	-11.24	21.50	46.00	-24.50	peak
4	629.4600	27.80	-5.07	22.73	46.00	-23.27	peak
5	872.9300	28.14	-0.57	27.57	46.00	-18.43	peak
6	980.6000	28.06	2.63	30.69	54.00	-23.31	peak

Remark:

- Margin = Result (Result =Reading + Factor) –Limit
- Factor= Antenna factor+Cable attenuation factor(cable loss)-Amplifier gain

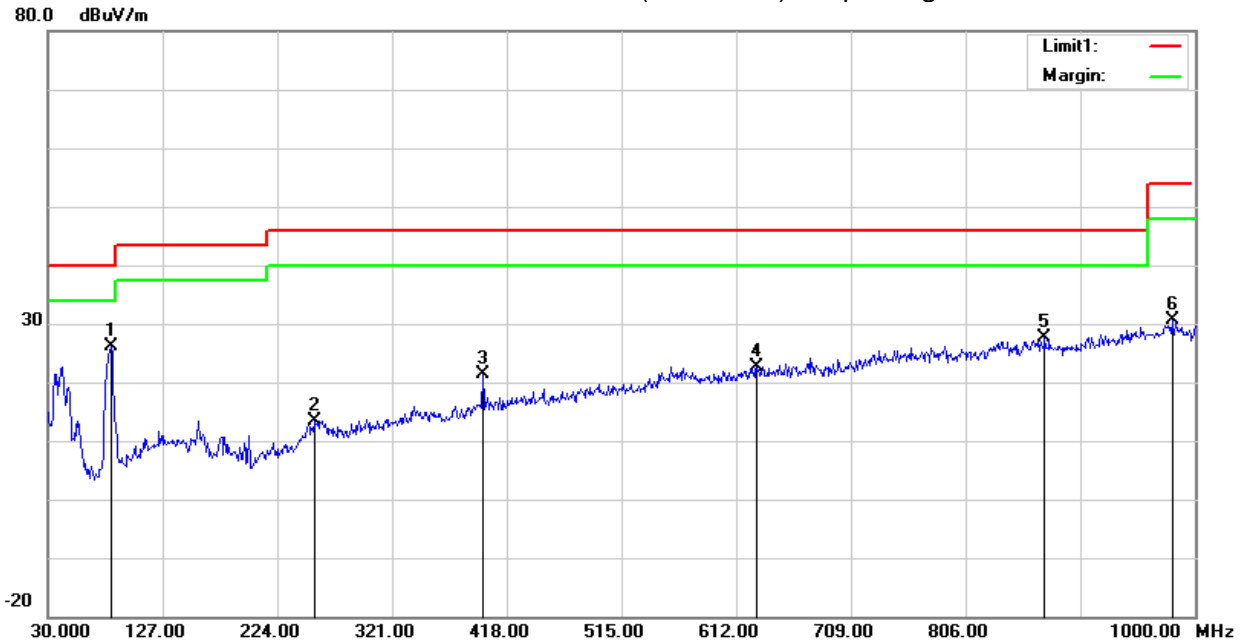



3.2.8 TEST RESULTS (Above 1000 MHz)

Band IV(5.725-5.850) GHz

Frequency (MHz)	Reading (dBuV)	Amplifier (dB)	Loss (dB)	Antenna Factor (dB/m)	Orrected Factor (dB)	Emission Level (dBμV/m)	Limit (dBuV/m)	Margin (dB)	Detector	Comment
Low Channel (802.11a/ 5745 MHz)										
3263.78	44.42	44.70	6.70	28.20	-9.80	34.62	74.00	-39.38	Pk	Vertical
3263.78	41.74	44.70	6.70	28.20	-9.80	31.94	54.00	-22.06	AV	Vertical
3265.02	44.94	44.70	6.70	28.20	-9.80	35.14	74.00	-38.86	Pk	Horizontal
3265.02	41.12	44.70	6.70	28.20	-9.80	31.32	54.00	-22.68	AV	Horizontal
3992.67	39.71	44.20	7.90	29.70	-6.60	33.11	74.00	-40.89	Pk	Vertical
3992.67	35.77	44.20	7.90	29.70	-6.60	29.17	54.00	-24.83	AV	Vertical
3983.89	38.72	44.20	7.90	29.70	-6.60	32.12	74.00	-41.88	Pk	Horizontal
3983.89	35.68	44.20	7.90	29.70	-6.60	29.08	54.00	-24.92	AV	Horizontal
7232.73	37.71	43.50	11.40	35.50	3.40	41.11	68.20	-27.09	Pk	Vertical
7232.73	34.82	43.50	11.40	35.50	3.40	38.22	54.00	-15.78	AV	Vertical
7222.66	36.63	43.50	11.40	35.50	3.40	40.03	68.20	-28.17	Pk	Horizontal
7222.66	33.48	43.50	11.40	35.50	3.40	36.88	54.00	-17.12	AV	Horizontal
10512.15	39.73	44.50	13.90	38.80	8.20	47.93	68.20	-20.27	Pk	Vertical
10512.15	35.87	44.50	13.90	38.80	8.20	44.07	54.00	-9.93	AV	Vertical
10503.52	39.43	44.50	13.90	38.80	8.20	47.63	68.20	-20.57	Pk	Horizontal
10503.52	36.61	44.50	13.90	38.80	8.20	44.81	54.00	-9.19	AV	Horizontal
11490.14	33.58	43.60	14.30	39.50	10.20	43.78	74.00	-30.22	Pk	Vertical
11490.14	30.23	43.60	14.30	39.50	10.20	40.43	54.00	-13.57	AV	Vertical
11489.99	33.21	43.60	14.30	39.50	10.20	43.41	74.00	-30.59	Pk	Horizontal
11489.99	30.43	43.60	14.30	39.50	10.20	40.63	54.00	-13.37	AV	Horizontal
13280.22	32.93	42.60	15.90	38.90	12.20	45.13	74.00	-28.87	Pk	Vertical
13280.22	29.35	42.60	15.90	38.90	12.20	41.55	54.00	-12.45	AV	Vertical
13298.08	32.01	42.60	15.90	38.90	12.20	44.21	74.00	-29.79	Pk	Horizontal
13298.08	29.71	42.60	15.90	38.90	12.20	41.91	54.00	-12.09	AV	Horizontal
Mid Channel (802.11a/ 5785 MHz)										
3257.05	45.22	44.70	6.70	28.20	-9.80	35.42	68.20	-32.78	Pk	Vertical
3257.05	41.08	44.70	6.70	28.20	-9.80	31.28	54.00	-22.72	AV	Vertical
3258.40	45.02	44.70	6.70	28.20	-9.80	35.22	68.20	-32.98	Pk	Horizontal
3258.40	41.79	44.70	6.70	28.20	-9.80	31.99	54.00	-22.01	AV	Horizontal
3985.78	39.90	44.20	7.90	29.70	-6.60	33.30	74.00	-40.70	Pk	Vertical
3985.78	36.89	44.20	7.90	29.70	-6.60	30.29	54.00	-23.71	AV	Vertical
3988.03	40.03	44.20	7.90	29.70	-6.60	33.43	74.00	-40.57	Pk	Horizontal
3988.03	35.97	44.20	7.90	29.70	-6.60	29.37	54.00	-24.63	AV	Horizontal
7233.88	37.54	43.50	11.40	35.50	3.40	40.94	68.20	-27.26	Pk	Vertical
7233.88	34.38	43.50	11.40	35.50	3.40	37.78	54.00	-16.22	AV	Vertical
7231.92	36.50	43.50	11.40	35.50	3.40	39.90	68.20	-28.30	Pk	Horizontal
7231.92	34.52	43.50	11.40	35.50	3.40	37.92	54.00	-16.08	AV	Horizontal
10582.89	39.28	44.50	13.80	38.80	8.10	47.38	68.20	-20.82	Pk	Vertical
10582.89	37.11	44.50	13.80	38.80	8.10	45.21	54.00	-8.79	AV	Vertical
10595.77	40.14	44.50	13.80	38.80	8.10	48.24	68.20	-19.96	Pk	Horizontal
10595.77	36.74	44.50	13.80	38.80	8.10	44.84	54.00	-9.16	AV	Horizontal
11569.97	34.03	43.60	14.30	39.50	10.20	44.23	74.00	-29.77	Pk	Vertical
11569.97	30.44	43.60	14.30	39.50	10.20	40.64	54.00	-13.36	AV	Vertical
11570.17	33.16	43.60	14.30	39.50	10.20	43.36	74.00	-30.64	Pk	Horizontal
11570.17	30.80	43.60	14.30	39.50	10.20	41.00	54.00	-13.00	AV	Horizontal
13294.87	32.49	42.60	15.90	38.90	12.20	44.69	74.00	-29.31	Pk	Vertical
13294.87	29.79	42.60	15.90	38.90	12.20	41.99	54.00	-12.01	AV	Vertical
13283.44	32.37	42.60	15.90	38.90	12.20	44.57	74.00	-29.43	Pk	Horizontal
13283.44	29.27	42.60	15.90	38.90	12.20	41.47	54.00	-12.53	AV	Horizontal



High Channel (802.11a/ 5825 MHz)										
3258.27	45.09	44.70	6.70	28.20	-9.80	35.29	68.20	-32.91	Pk	Vertical
3258.27	41.02	44.70	6.70	28.20	-9.80	31.22	54.00	-22.78	AV	Vertical
3258.96	45.10	44.70	6.70	28.20	-9.80	35.30	68.20	-32.90	Pk	Horizontal
3258.96	41.87	44.70	6.70	28.20	-9.80	32.07	54.00	-21.93	AV	Horizontal
3983.05	40.05	44.20	7.90	29.70	-6.60	33.45	74.00	-40.55	Pk	Vertical
3983.05	36.00	44.20	7.90	29.70	-6.60	29.40	54.00	-24.60	AV	Vertical
3985.49	39.53	44.20	7.90	29.70	-6.60	32.93	74.00	-41.07	Pk	Horizontal
3985.49	36.08	44.20	7.90	29.70	-6.60	29.48	54.00	-24.52	AV	Horizontal
7216.52	37.79	43.50	11.40	35.50	3.40	41.19	68.20	-27.01	Pk	Vertical
7216.52	34.67	43.50	11.40	35.50	3.40	38.07	54.00	-15.93	AV	Vertical
7229.46	37.66	43.50	11.40	35.50	3.40	41.06	68.20	-27.14	Pk	Horizontal
7229.46	34.43	43.50	11.40	35.50	3.40	37.83	54.00	-16.17	AV	Horizontal
10633.42	39.40	44.50	13.80	38.80	8.10	47.50	74.00	-26.50	Pk	Vertical
10633.42	35.76	44.50	13.80	38.80	8.10	43.86	54.00	-10.14	AV	Vertical
10640.29	38.81	44.50	13.80	38.80	8.10	46.91	74.00	-27.09	Pk	Horizontal
10640.29	36.33	44.50	13.80	38.80	8.10	44.43	54.00	-9.57	AV	Horizontal
11650.06	34.16	43.60	14.30	39.50	10.20	44.36	74.00	-29.64	Pk	Vertical
11650.06	30.18	43.60	14.30	39.50	10.20	40.38	54.00	-13.62	AV	Vertical
11650.15	33.97	43.60	14.30	39.50	10.20	44.17	74.00	-29.83	Pk	Horizontal
11650.15	31.09	43.60	14.30	39.50	10.20	41.29	54.00	-12.71	AV	Horizontal
13281.63	32.68	42.70	18.00	37.10	12.40	45.08	74.00	-28.92	Pk	Vertical
13281.63	30.00	42.70	18.00	37.10	12.40	42.40	54.00	-11.60	AV	Vertical
13290.28	32.96	42.70	18.00	37.10	12.40	45.36	74.00	-28.64	Pk	Horizontal
13290.28	28.91	42.70	18.00	37.10	12.40	41.31	54.00	-12.69	AV	Horizontal

Remark:

- Factor = Antenna Factor + Cable Loss – Pre-amplifier.
- Scan with 802.11a,802.11n (HT-20),802.11n (HT-40), 802.11ac (VHT-20),802.11ac (VHT-40), 802.11ac (VHT-80) the worst case is 802.11a.
- The frequency emission of peak points that did not show above the forms are at least 20dB below the limit, the frequency emission is mainly from the environment noise.

3.2.9 RESTRICTED FREQUENCY BANDS AND BAND EDGE

Band IV(5.725-5.85 GHz)

802.11n20-L-H

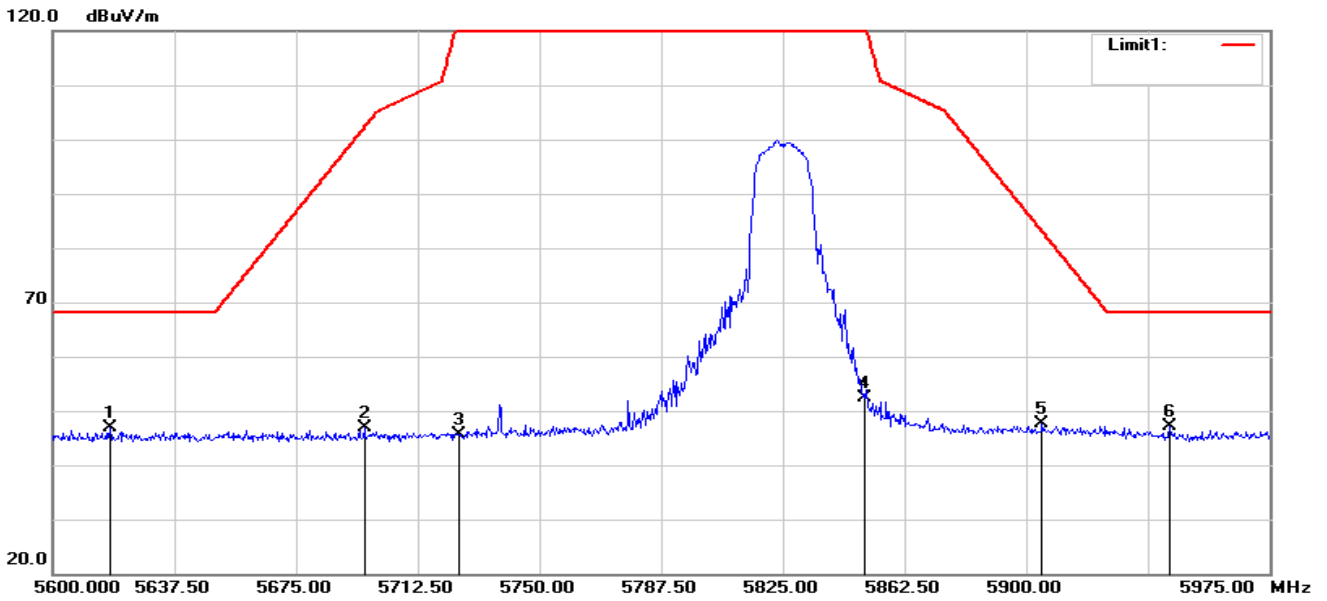

No.	Frequency (MHz)	Reading (dBuV)	Correct Factor(dB/m)	Result (dBuV/m)	Limit (dBuV/m)	Margin (dB)	Remark
1	5617.625	51.61	-4.69	46.92	68.20	-21.28	peak
2	5696.000	51.61	-4.67	46.94	102.24	-55.30	peak
3	5725.000	50.20	-4.57	45.63	122.20	-76.57	peak
4	5850.000	56.47	-4.10	52.37	122.20	-69.83	peak
5	5904.875	51.59	-3.89	47.70	83.09	-35.39	peak
6	5944.250	51.05	-3.96	47.09	68.20	-21.11	peak



802.11n20-L-V

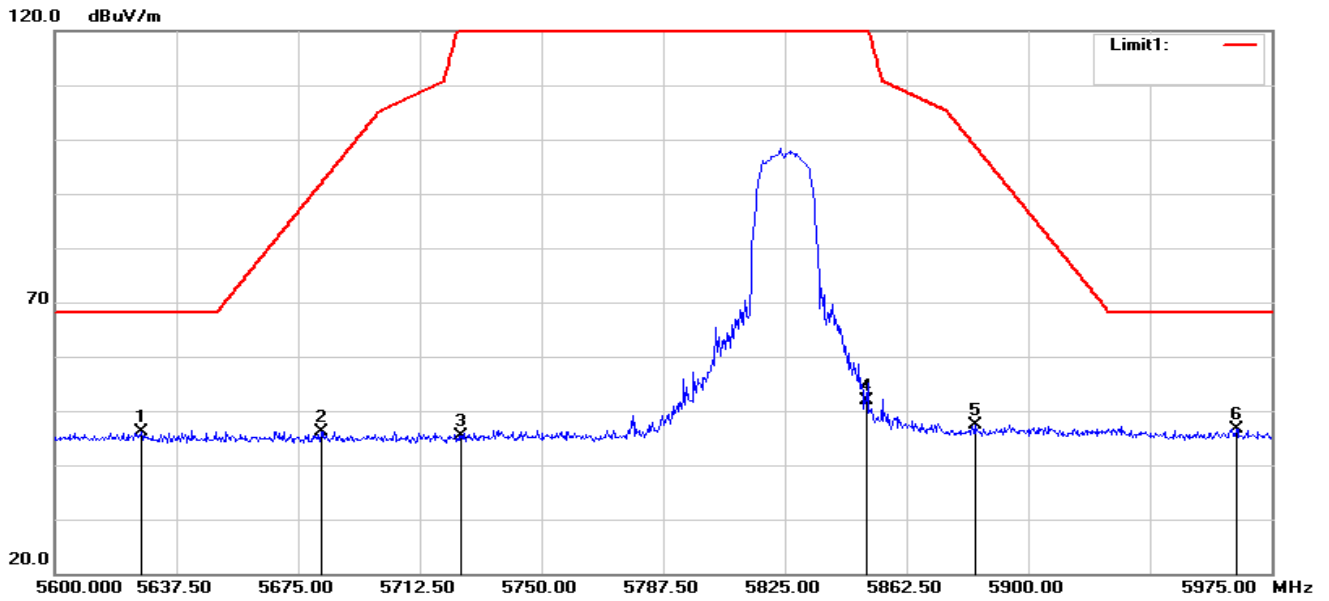

No.	Frequency (MHz)	Reading (dBuV)	Correct Factor(dB/m)	Result (dBuV/m)	Limit (dBuV/m)	Margin (dB)	Remark
1	5626.625	50.87	-4.69	46.18	68.20	-22.02	peak
2	5682.125	50.85	-4.67	46.18	91.97	-45.79	peak
3	5725.000	49.95	-4.57	45.38	122.20	-76.82	peak
4	5850.000	56.01	-4.10	51.91	122.20	-70.29	peak
5	5883.500	51.43	-3.96	47.47	98.91	-51.44	peak
6	5964.125	50.69	-3.99	46.70	68.20	-21.50	peak



802.11n20-H-H

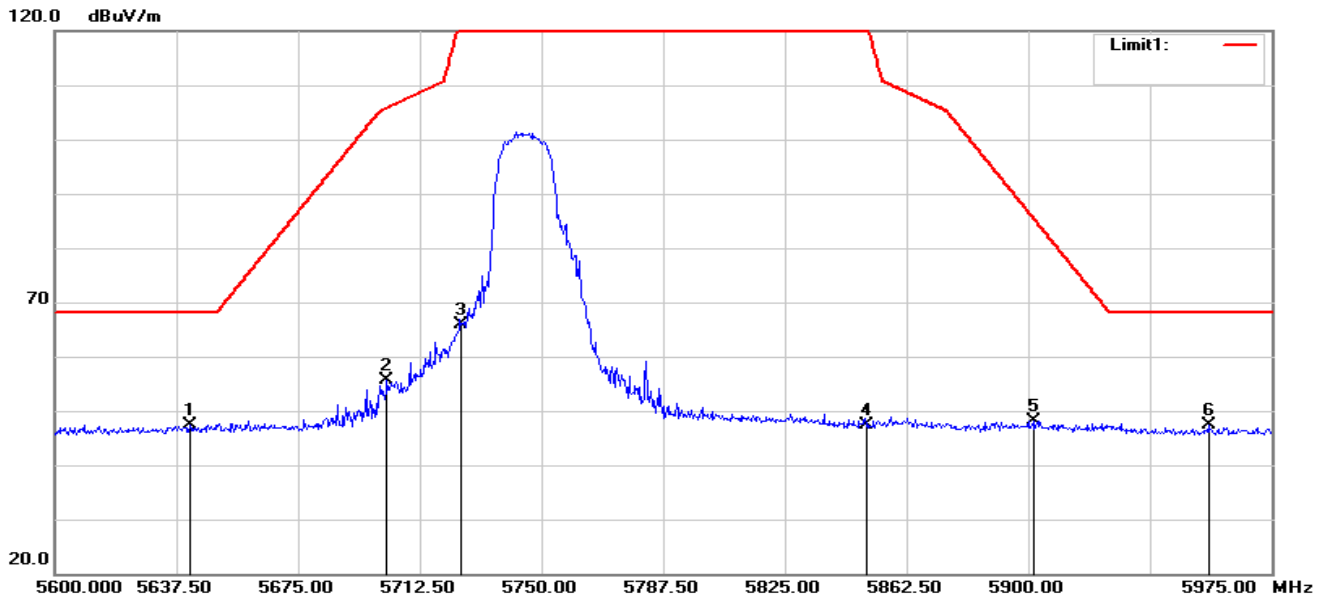

No.	Frequency (MHz)	Reading (dBuV)	Correct Factor(dB/m)	Result (dBuV/m)	Limit (dBuV/m)	Margin (dB)	Remark
1	5641.625	52.13	-4.68	47.45	68.20	-20.75	peak
2	5702.375	60.40	-4.66	55.74	105.87	-50.13	peak
3	5725.000	70.39	-4.57	65.82	122.20	-56.38	peak
4	5850.000	51.51	-4.10	47.41	122.20	-74.79	peak
5	5901.500	51.99	-3.88	48.11	85.59	-37.48	peak
6	5955.500	51.45	-3.97	47.48	68.20	-20.72	peak



802.11n20-H-V

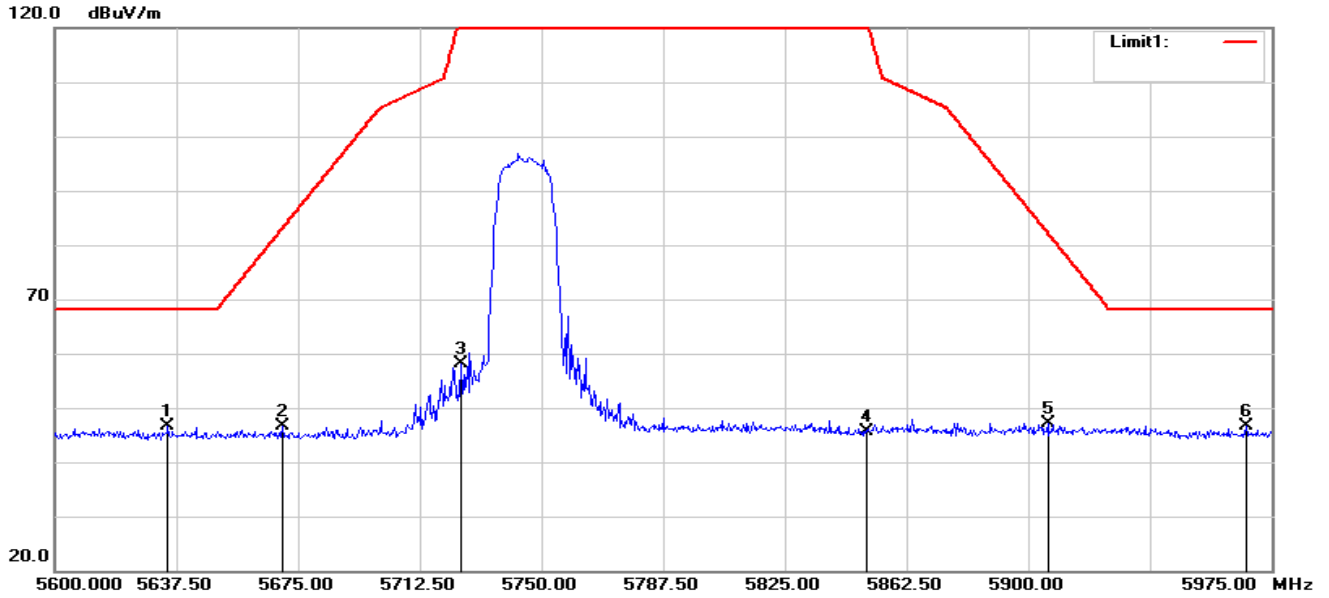

No.	Frequency (MHz)	Reading (dBuV)	Correct Factor(dB/m)	Result (dBuV/m)	Limit (dBuV/m)	Margin (dB)	Remark
1	5634.875	51.22	-4.68	46.54	68.20	-21.66	peak
2	5670.125	51.36	-4.67	46.69	83.09	-36.40	peak
3	5725.000	62.71	-4.57	58.14	122.20	-64.06	peak
4	5850.000	49.70	-4.10	45.60	122.20	-76.60	peak
5	5906.000	51.00	-3.89	47.11	82.26	-35.15	peak
6	5967.125	50.50	-3.99	46.51	68.20	-21.69	peak



802.11n40-L-H

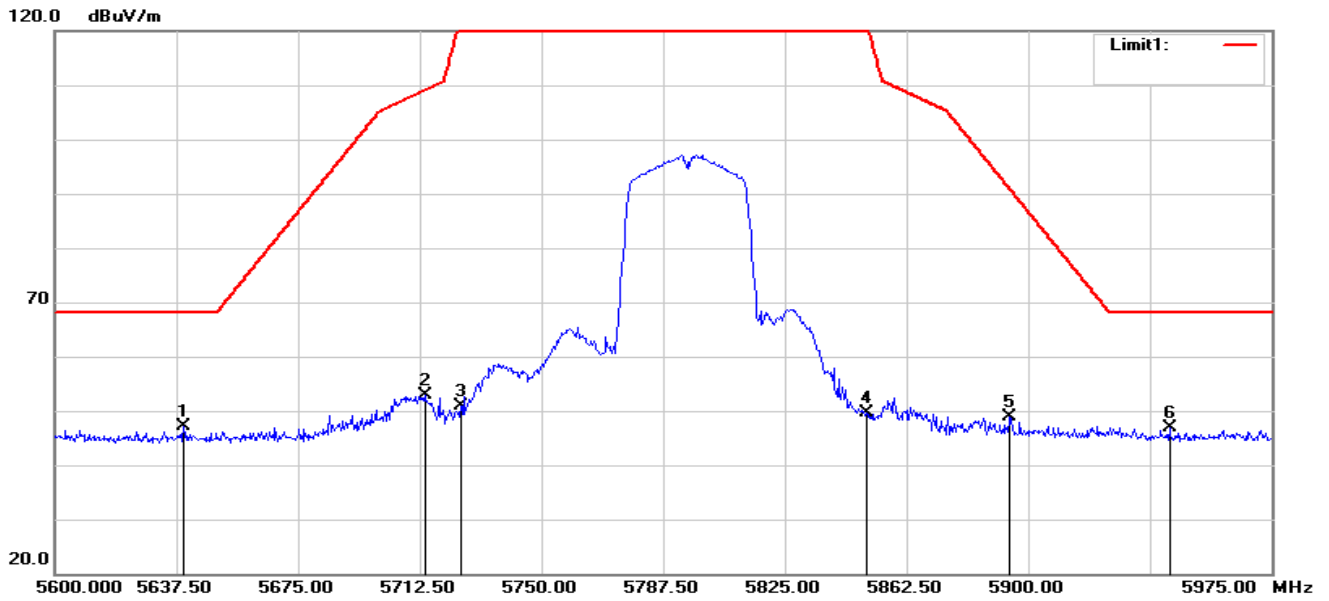

No.	Frequency (MHz)	Reading (dBuV)	Correct Factor(dB/m)	Result (dBuV/m)	Limit (dBuV/m)	Margin (dB)	Remark
1	5639.750	51.79	-4.69	47.10	68.20	-21.10	peak
2	5714.000	57.50	-4.61	52.89	109.12	-56.23	peak
3	5725.000	55.37	-4.57	50.80	122.20	-71.40	peak
4	5850.000	53.67	-4.10	49.57	122.20	-72.63	peak
5	5894.375	52.70	-3.91	48.79	90.86	-42.07	peak
6	5943.500	50.79	-3.95	46.84	68.20	-21.36	peak



802.11n40-L-V

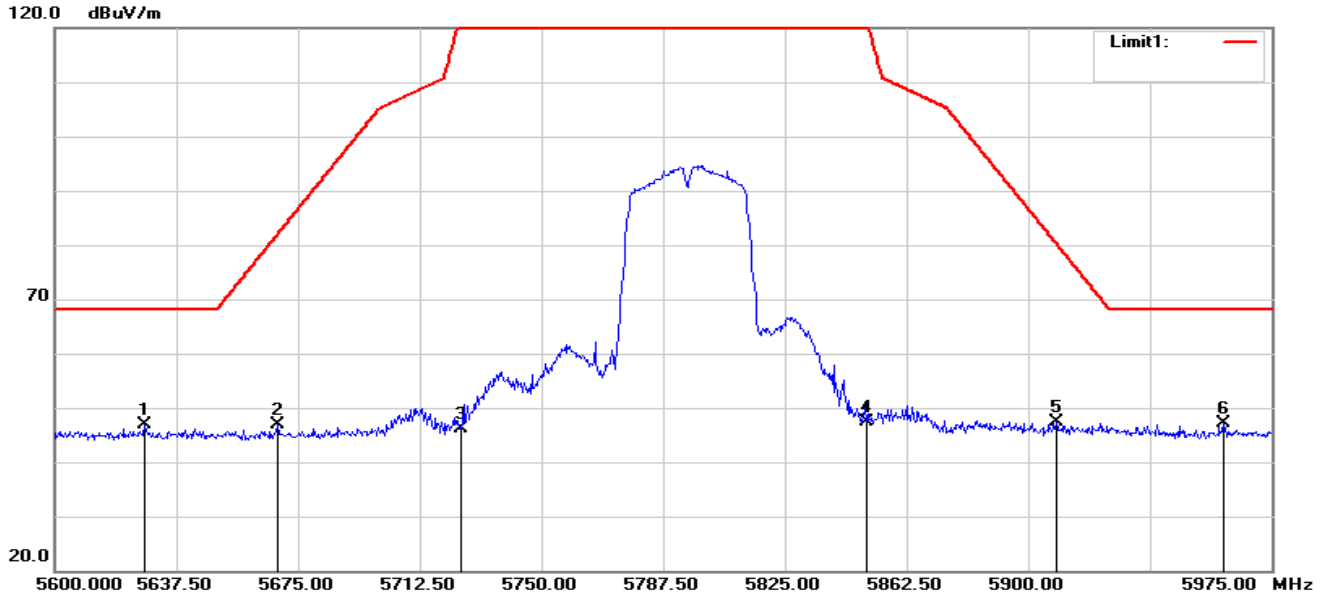

No.	Frequency (MHz)	Reading (dBuV)	Correct Factor(dB/m)	Result (dBuV/m)	Limit (dBuV/m)	Margin (dB)	Remark
1	5627.750	51.62	-4.69	46.93	68.20	-21.27	peak
2	5668.625	51.63	-4.67	46.96	81.98	-35.02	peak
3	5725.000	50.65	-4.57	46.08	122.20	-76.12	peak
4	5850.000	51.51	-4.10	47.41	122.20	-74.79	peak
5	5908.625	51.16	-3.90	47.26	80.32	-33.06	peak
6	5960.000	51.17	-3.98	47.19	68.20	-21.01	peak



802.11n40-H-H

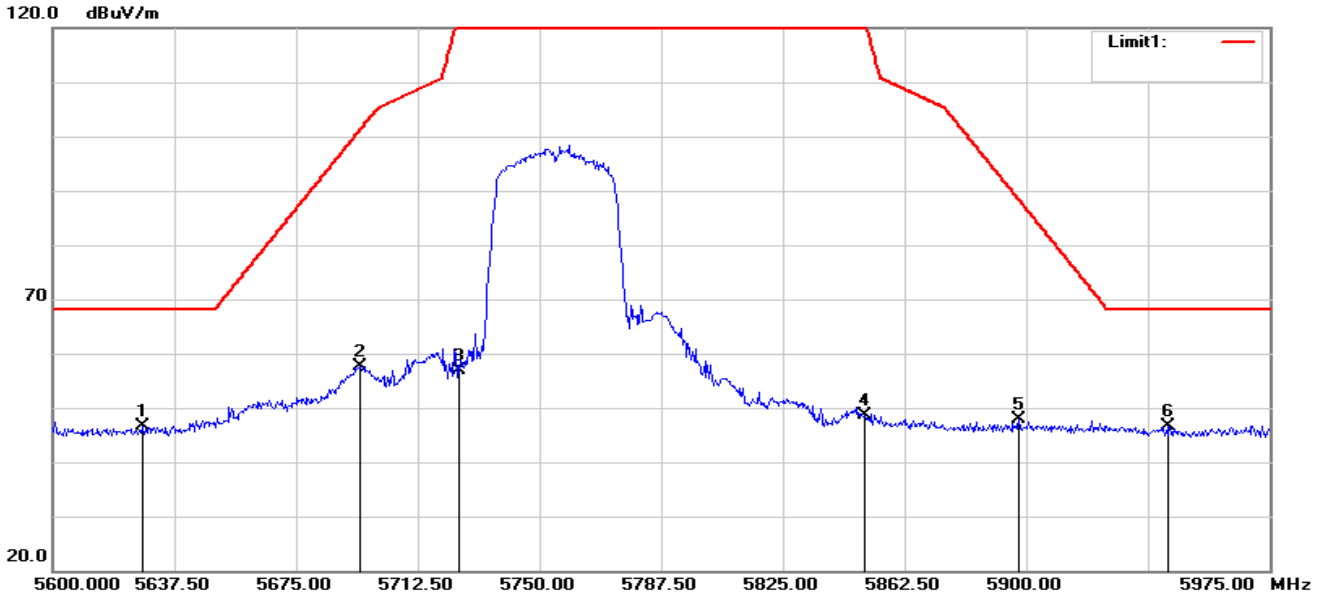

No.	Frequency (MHz)	Reading (dBuV)	Correct Factor(dB/m)	Result (dBuV/m)	Limit (dBuV/m)	Margin (dB)	Remark
1	5627.750	51.32	-4.69	46.63	68.20	-21.57	peak
2	5694.875	62.25	-4.66	57.59	101.41	-43.82	peak
3	5725.000	61.48	-4.57	56.91	122.20	-65.29	peak
4	5850.000	52.80	-4.10	48.70	122.20	-73.50	peak
5	5897.750	51.66	-3.89	47.77	88.37	-40.60	peak
6	5943.500	50.47	-3.95	46.52	68.20	-21.68	peak



802.11n40-H-V

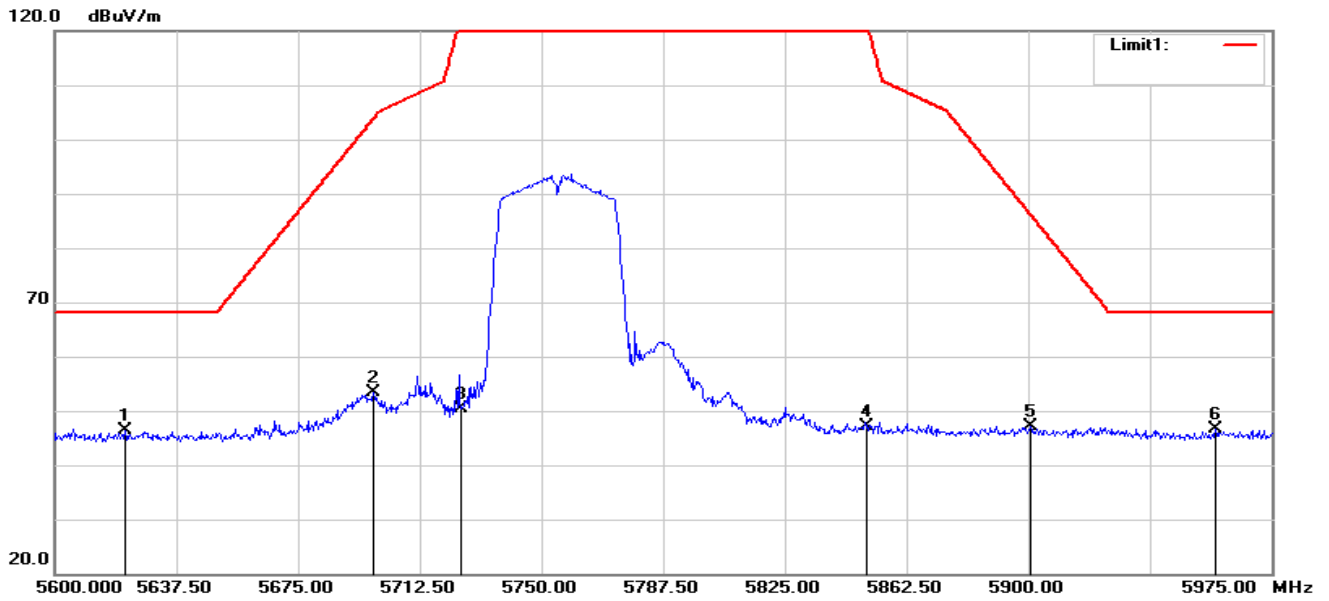

No.	Frequency (MHz)	Reading (dBuV)	Correct Factor(dB/m)	Result (dBuV/m)	Limit (dBuV/m)	Margin (dB)	Remark
1	5621.750	51.07	-4.70	46.37	68.20	-21.83	peak
2	5698.250	58.06	-4.66	53.40	103.91	-50.51	peak
3	5725.000	54.96	-4.57	50.39	122.20	-71.81	peak
4	5850.000	51.19	-4.10	47.09	122.20	-75.11	peak
5	5900.750	50.93	-3.88	47.05	86.14	-39.09	peak
6	5957.750	50.63	-3.98	46.65	68.20	-21.55	peak



802.11ac80-H

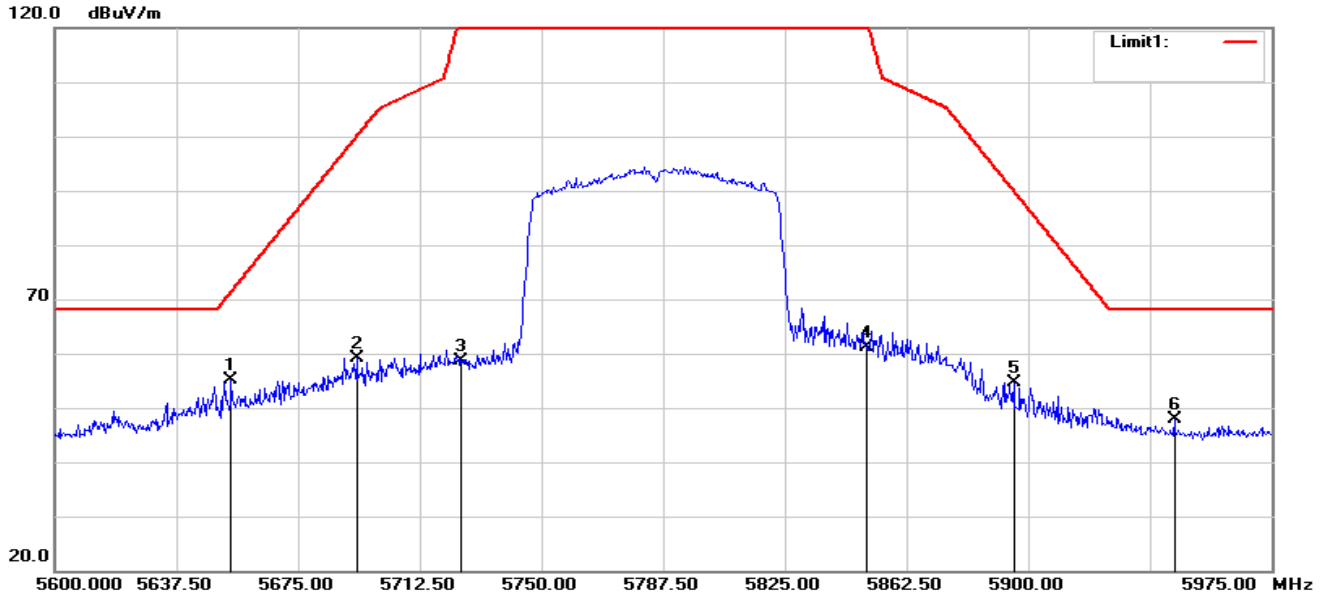

No.	Frequency (MHz)	Reading (dBuV)	Correct Factor(dB/m)	Result (dBuV/m)	Limit (dBuV/m)	Margin (dB)	Remark
1	5654.375	59.75	-4.68	55.07	71.44	-16.37	peak
2	5693.000	63.75	-4.66	59.09	100.02	-40.93	peak
3	5725.000	63.22	-4.57	58.65	122.20	-63.55	peak
4	5850.000	65.13	-4.10	61.03	122.20	-61.17	peak
5	5895.500	58.51	-3.90	54.61	90.03	-35.42	peak
6	5945.000	51.83	-3.96	47.87	68.20	-20.33	peak



802.11ac80-V

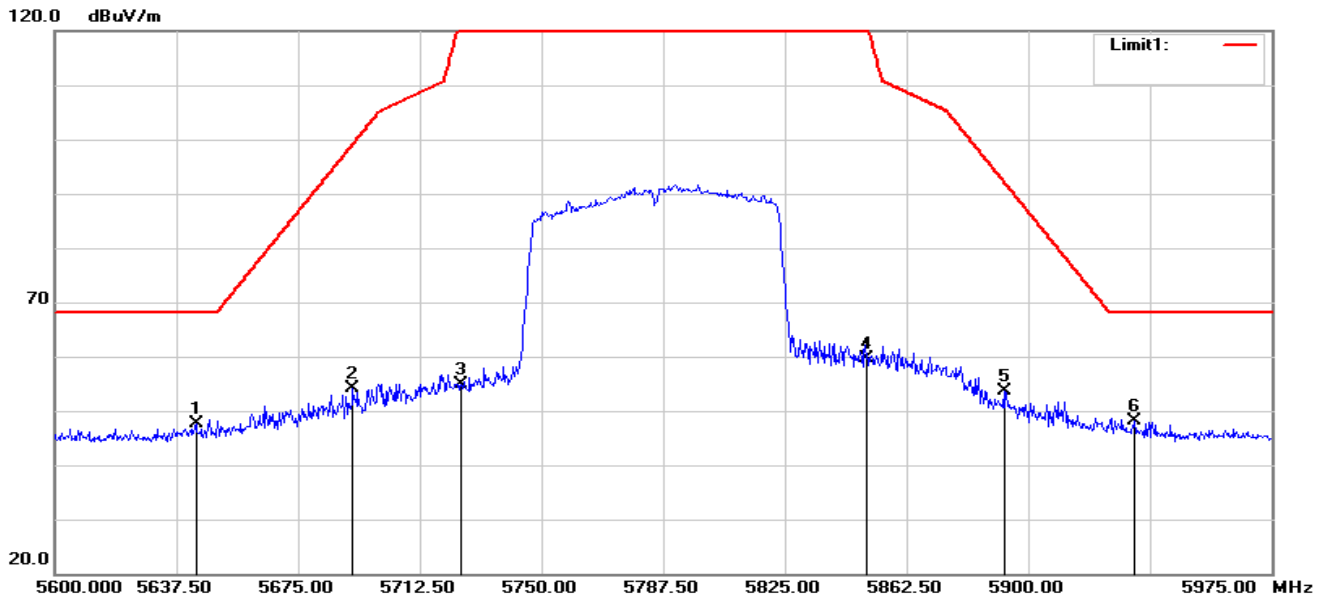

No.	Frequency (MHz)	Reading (dBuV)	Correct Factor(dB/m)	Result (dBuV/m)	Limit (dBuV/m)	Margin (dB)	Remark
1	5643.500	52.41	-4.68	47.73	68.20	-20.47	peak
2	5691.875	58.86	-4.66	54.20	99.19	-44.99	peak
3	5725.000	59.56	-4.57	54.99	122.20	-67.21	peak
4	5850.000	63.75	-4.10	59.65	122.20	-62.55	peak
5	5892.500	57.50	-3.91	53.59	92.25	-38.66	peak
6	5932.625	52.09	-3.94	48.15	68.20	-20.05	peak

Note: All modes have been tested. Only the worst mode shown in the report.



4. POWER SPECTRAL DENSITY TEST

4.1 LIMIT

1. For mobile and portable client devices in the 5.15-5.25 GHz band, , the maximum power spectral density shall not exceed 11 dBm in any 1 megahertz band. If transmitting antennas of directional gain greater than 6 dBi are used, both the maximum conducted output power and the maximum power spectral density shall be reduced by the amount in dB that the directional gain of the antenna exceeds 6 dBi.
2. For the 5.25-5.35 GHz and 5.47-5.725 GHz bands, the maximum power spectral density shall not exceed 11 dBm in any 1 megahertz band. If transmitting antennas of directional gain greater than 6 dBi are used, both the maximum conducted output power and the maximum power spectral density shall be reduced by the amount in dB that the directional gain of the antenna exceeds 6 dBi.
3. For the band 5.725-5.850 GHz, the peak power spectral density shall not exceed 30 dBm in any 500KHz band. If transmitting antenna directional gain is greater than 6 dBi, both the maximum conducted output power and the peak power spectral density shall be reduced by the amount in dB that the directional gain of the antenna exceeds 6 dBi.

4.2 TEST PROCEDURE

1. The setting follows Method SA-1 of FCC KDB D02 General UNII Test Procedures New Rules v01r03.

For devices operating in the band, the rules specify a measurement bandwidth of 500 kHz.

Many spectrum analyzers do not have 500 kHz RBW, thus a narrower RBW may need to be used.

The rules permit the use of a RBWs less than 1 MHz, or 500 kHz, "provided that the measured power is integrated over the full reference bandwidth" to show the total power over the specified measurement bandwidth (*i.e.*, 1 MHz, or 500 kHz). If measurements are performed using a reduced resolution bandwidth (< 1 MHz, or < 500 kHz) and integrated over 1 MHz, or 500 KHz bandwidth, the following adjustments to the procedures apply:

- a) Set $RBW \geq 1/T$, where T is defined in section II.B.1.a).
- b) Set $VBW \geq 3 RBW$.
- c) If measurement bandwidth of Maximum PSD is specified in 500 kHz, add $10 \log (500\text{kHz}/RBW)$ to the measured result, whereas $RBW (< 500 \text{ kHz})$ is the reduced resolution bandwidth of the spectrum analyzer set during measurement.
- d) If measurement bandwidth of Maximum PSD is specified in 1 MHz, add $10 \log (1\text{MHz}/RBW)$ to the measured result, whereas $RBW (< 1 \text{ MHz})$ is the reduced resolution bandwidth of spectrum analyzer set during measurement.
- e) Care must be taken to ensure that the measurements are performed during a period of continuous transmission or are corrected upward for duty cycle.

Note: As a practical matter, it is recommended to use reduced RBW of 100 kHz for the sections 5.c) and 5.d) above, since $RBW=100 \text{ KHZ}$ is available on nearly all spectrum analyzers.

4.3 DEVIATION FROM STANDARD

No deviation.

4.4 TEST SETUP



4.5 EUT OPERATION CONDITIONS

The EUT tested system was configured as the statements of 2.1 Unless otherwise a special operating condition is specified in the follows during the testing.

4.6 TEST RESULTS

5725-5850MHz						
Frequency	Use RBW 510KHz direct measurement Direct measurement Power Density (dBm)	Convert to RBW 500KHz direct measurement Power Density (dBm)	Duty cycle factor (dB)	Final Power Density (dBm)	Limit (dBm/500KHz)	Result
802.11a						
5745	-0.974	-1.060	0.083	-0.977	30	PASS
5785	-0.686	-0.772	0.083	-0.689	30	PASS
5825	-0.862	-0.948	0.083	-0.865	30	PASS
802.11n20						
5745	-1.369	-1.455	0.069	-1.386	30	PASS
5785	-1.254	-1.340	0.069	-1.271	30	PASS
5825	-1.336	-1.422	0.069	-1.353	30	PASS
802.11n40						
5755	-4.087	-4.173	0.194	-3.979	30	PASS
5795	-4.514	-4.600	0.194	-4.406	30	PASS
802.11ac20						
5745	-1.274	-1.360	0.088	-1.272	30	PASS
5785	-1.203	-1.289	0.088	-1.201	30	PASS
5825	-1.032	-1.118	0.088	-1.030	30	PASS
802.11ac40						
5755	-4.128	-4.214	0.180	-4.034	30	PASS
5795	-4.018	-4.104	0.180	-3.924	30	PASS
802.11ac80						
5775	-7.731	-7.817	0.366	-7.451	30	PASS

Note: 1. RB conversion formula: $10 \cdot \text{LOG}(500\text{KHz}/\text{RBW})$
 2. Test plots see Attachment A

5. BANDWIDTH MEASUREMENT

5.1 EMISSION BANDWIDTH (EBW) 26 BANDWID PROCEDURES / LIMIT

The following procedure shall be used for measuring 26 bandwidth.

5.1.1 TEST PROCEDURE

1. The testing follows FCC KDB 789033 D02 General UNII Test Procedures New Rules v02r01
2. Set RBW = approximately 1% of the emission bandwidth.
3. Set the VBW \geq RBW.
4. Detector = Peak.
5. Trace mode = max hold.
6. Measure the maximum width of the emission that is 26 dB down from the peak of the emission. Compare this with the RBW setting of the analyzer. Readjust RBW and repeat measurement as needed until the RBW/EBW ratio is approximately 1%.

5.1.2 DEVIATION FROM STANDARD

No deviation.

6.1.3 TEST SETUP



5.1.4 EUT OPERATION CONDITIONS

The EUT tested system was configured as the statements of 2.4 Unless otherwise a special operating condition is specified in the follows during the testing.

**5.1.5 TEST RESULTS**

Frequency (MHz)	26dB Bandwidth (MHz)	Pass/Fail
802.11a		
5745	19.60	Pass
5785	19.59	Pass
5825	19.97	Pass
802.11n(HT20)		
5745	20.04	Pass
5785	20.20	Pass
5825	20.01	Pass
802.11n(HT40)		
5755	40.27	Pass
5795	40.18	Pass
802.11ac(VHT20)		
5745	20.08	Pass
5785	20.03	Pass
5825	20.15	Pass
802.11ac(VHT40)		
5755	40.14	Pass
5795	39.95	Pass
802.11ac(VHT80)		
5775	80.30	Pass

Test plot see Attachment B

5.2 OCCUPIED BANDWIDTH (99%) TEST APPLIED PROCEDURES / LIMIT

The following procedure shall be used for measuring (99 %) power bandwidth.

5.2.1 TEST PROCEDURE

1. The testing follows FCC KDB 789033 D02 General UNII Test Procedures v02r01.
The following procedure shall be used for measuring (99 %) power bandwidth:
 1. Set center frequency to the nominal EUT channel center frequency.
 2. Set span = 1.5 times to 5.0 times the OBW.
 3. Set RBW = 1 % to 5 % of the OBW
 4. Set VBW $\geq 3 \cdot$ RBW
 5. Video averaging is not permitted. Where practical, a sample detection and single sweep mode shall be used. Otherwise, peak detection and max hold mode (until the trace stabilizes) shall be used.
 6. Use the 99 % power bandwidth function of the instrument (if available).
 7. If the instrument does not have a 99 % power bandwidth function, the trace data points are recovered and directly summed in power units. The recovered amplitude data points, beginning at the lowest frequency, are placed in a running sum until 0.5 % of the total is reached; that frequency is recorded as the lower frequency. The process is repeated until 99.5 % of the total is reached; that frequency is recorded as the upper frequency. The 99% occupied bandwidth is the difference between these two frequencies.

5.2.2 DEVIATION FROM STANDARD

No deviation.

5.2.3 TEST SETUP



5.2.4 EUT OPERATION CONDITIONS

The EUT tested system was configured as the statements of 2.4 Unless otherwise a special operating condition is specified in the follows during the testing.

**5.2.5 TEST RESULTS**

Frequency (MHz)	99% Bandwidth (MHz)	Pass/Fail
802.11a		
5745	16.40	Pass
5785	16.38	Pass
5825	16.40	Pass
802.11n(HT20)		
5745	17.52	Pass
5785	17.52	Pass
5825	17.54	Pass
802.11n(HT40)		
5755	35.92	Pass
5795	35.93	Pass
802.11ac(VHT20)		
5745	17.53	Pass
5785	17.55	Pass
5825	17.54	Pass
802.11ac(VHT40)		
5755	35.92	Pass
5795	35.92	Pass
802.11ac(VHT80)		
5775	75.14	Pass

Test plot See Attachment B

5.3 MINIMUM EMISSION BANDWIDTH(6 DB) PROCEDURES / LIMIT

Section 15.407(e) specifies the minimum 6 dB emission bandwidth of at least 500 KHz for the band 5.725-5.85 GHz. The following procedure shall be used for measuring this bandwidth.

5.3.1 TEST PROCEDURE

1. The testing follows FCC KDB 789033 D02 General UNII Test Procedures v02r01.
 - a) Set RBW = 100 kHz.
 - b) Set the video bandwidth (VBW) $\geq 3 \times$ RBW.
 - c) Detector = Peak.
 - d) Trace mode = max hold.
 - e) Sweep = auto couple.
 - f) Allow the trace to stabilize.
 - g) Measure the maximum width of the emission that is constrained by the frequencies associated with the two outermost amplitude points (upper and lower frequencies) that are attenuated by 6 dB relative to the maximum level measured in the fundamental emission.

5.3.2 DEVIATION FROM STANDARD

No deviation.

5.3.3 TEST SETUP



5.3.4 EUT OPERATION CONDITIONS

The EUT tested system was configured as the statements of 2.4 Unless otherwise a special operating condition is specified in the follows during the testing.

**6.3.5 TEST RESULTS**

Frequency (MHz)	6dB Bandwidth (MHz)	Pass/Fail
802.11a		
5745	15.11	Pass
5785	15.07	Pass
5825	15.11	Pass
802.11n(HT20)		
5745	15.09	Pass
5785	15.07	Pass
5825	15.11	Pass
802.11n(HT40)		
5755	35.09	Pass
5795	35.06	Pass
802.11ac(VHT20)		
5745	15.11	Pass
5785	15.10	Pass
5825	14.83	Pass
802.11ac(VHT40)		
5755	35.11	Pass
5795	35.10	Pass
802.11ac(VHT80)		
5775	75.11	Pass

Test plot see Attachment C

6. MAXIMUM CONDUCTED OUTPUT POWER

6.1 LIMIT

For mobile and portable client devices in the 5.15-5.25 GHz band, the maximum conducted output power over the frequency band of operation shall not exceed 250 mW provided the maximum antenna gain does not exceed 6 dBi. If transmitting antennas of directional gain greater than 6 dBi are used, both the maximum conducted output power and the maximum power spectral density shall be reduced by the amount in dB that the directional gain of the antenna exceeds 6 dBi.

For the 5.25-5.35 GHz and 5.47-5.725 GHz bands, the maximum conducted output power over the frequency bands of operation shall not exceed the lesser of 250 mW or 11 dBm + 10 log B, where B is the 26 dB emission bandwidth in megahertz, If transmitting antennas of directional gain greater than 6 dBi are used.

For the band 5.725-5.85 GHz, the maximum conducted output power over the frequency band of operation shall not exceed 1 W. If transmitting antennas of directional gain greater than 6 dBi are used.

FCC Part15 (15.407) , Subpart E				
Section	Test Item	Limit	Frequency Range (MHz)	Result
15.407(a) (1) (iv)	Peak Output Power	0.25 watt	5150-5250	PASS
		The lesser of 250 mW or 11 dBm + 10 log (26 dB emission bandwidth)	5250-5350 5470-5725	
15.407(a) (3)		1 watt	5725-5825	

6.2 TEST PROCEDURE

The EUT was directly connected to the Power Sensor&PC

6.3 DEVIATION FROM STANDARD

No deviation.

6.4 TEST SETUP

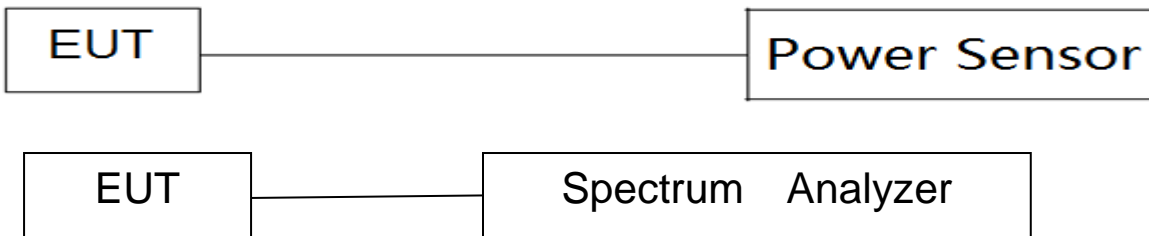

6.5 EUT OPERATION CONDITIONS

The EUT tested system was configured as the statements of 5 Unless otherwise a special operating condition is specified in the follows during the testing.



6.6 TEST RESULTS

Band IV (5.725-5.85GHz)					
Test Channel	Frequency (MHz)	Direct measurement AV Power (dBm)	Duty cycle factor (dB)	Final AV Power (dBm)	LIMIT (dBm)
802.11a					
149	5745	12.32	0.083	12.40	30.00
157	5785	12.40	0.083	12.48	30.00
165	5825	12.53	0.083	12.61	30.00
802.11n(HT20)					
149	5745	12.27	0.069	12.34	30.00
157	5785	12.33	0.069	12.40	30.00
165	5825	12.42	0.069	12.49	30.00
802.11n(HT40)					
151	5755	12.06	0.194	12.25	30.00
159	5795	12.16	0.194	12.35	30.00
802.11ac(VHT20)					
149	5745	12.29	0.088	12.38	30.00
157	5785	12.29	0.088	12.38	30.00
165	5825	12.35	0.088	12.44	30.00
802.11ac(VHT40)					
151	5755	12.11	0.180	12.29	30.00
159	5795	12.15	0.180	12.33	30.00
802.11ac(VHT80)					
155	5775	10.71	0.366	11.08	30.00

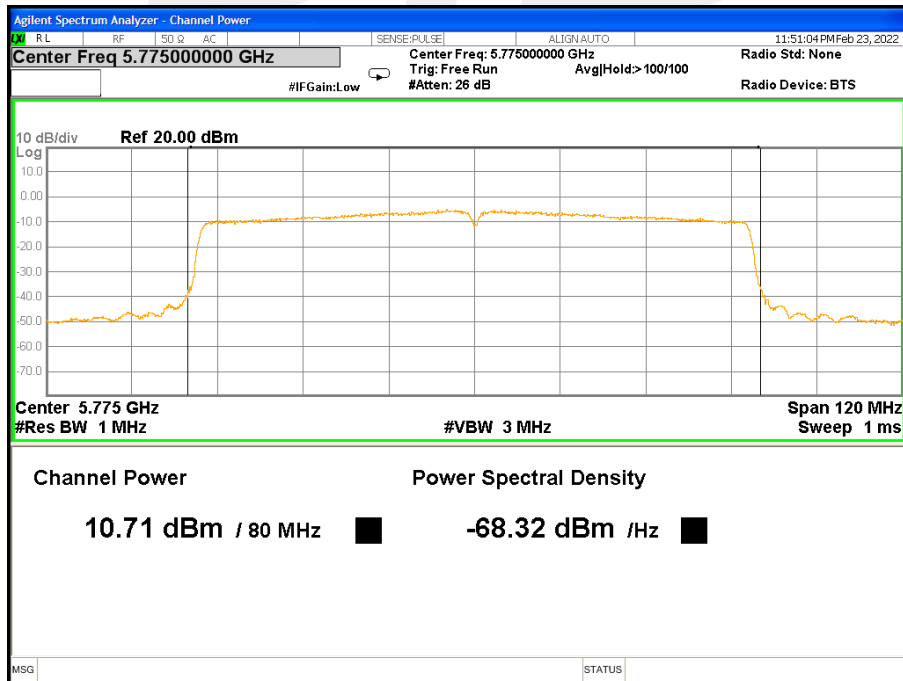

5775MHz



Duty cycle

Band4				
Mode	Ton(ms)	Tp(ms)	Duty cycle(%)	Duty factor(dB)
a	1.401	1.428	98.11%	0.083
n20	1.314	1.335	98.43%	0.069
n40	0.656	0.686	95.63%	0.194
ac20	1.320	1.347	98.00%	0.088
ac40	0.660	0.688	95.93%	0.180
ac80	0.330	0.359	91.92%	0.366



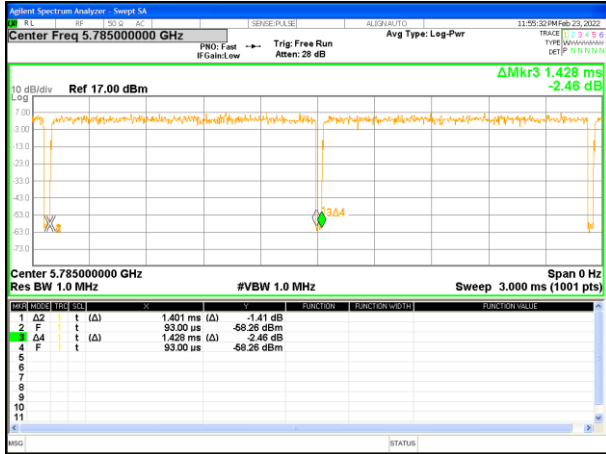

Band 4-a20

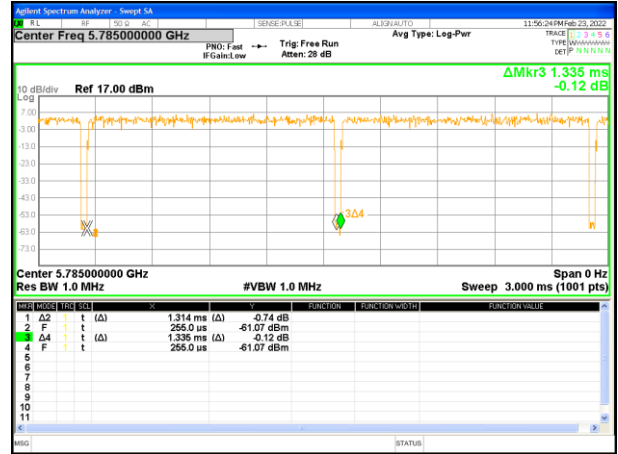

Band 4-n20



Band 4-n40

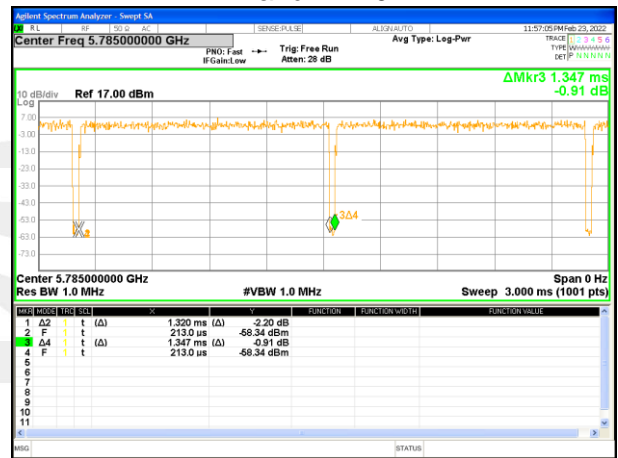

Band 4-ac20

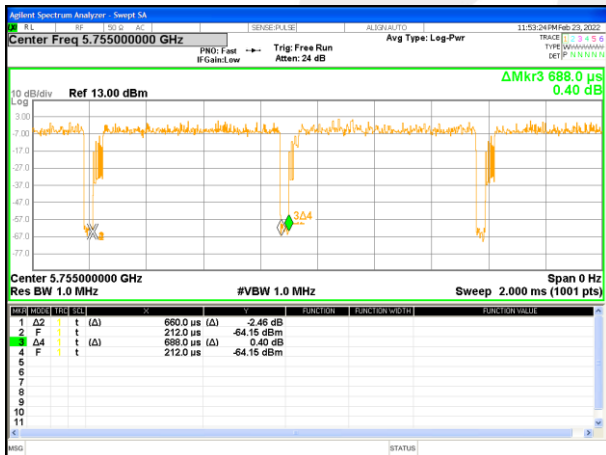

Band 4-ac40

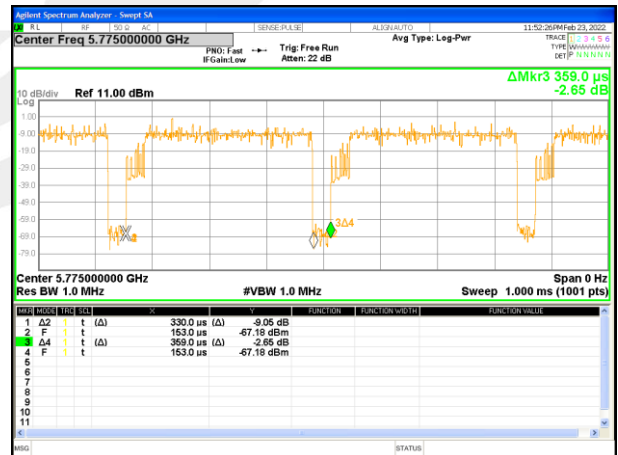

Band 4-ac80



7. AUTOMATICALLY DISCONTINUE TRANSMISSION

7.1 LIMIT OF AUTOMATICALLY DISCONTINUE TRANSMISSION

The device shall automatically discontinue transmission in case of either absence of information to transmit or operational failure. These provisions are not intended to preclude the transmission of control or signaling information or the use of repetitive codes used by certain digital technologies to complete frame or burst intervals. Applicants shall include in their application for equipment authorization to describe how this requirement is met.

7.2 TEST RESULT OF AUTOMATICALLY DISCONTINUE TRANSMISSION

During no any information transmission, the EUT can automatically discontinue transmission and become standby mode for power saving. The EUT can detect the controlling signal of ACK message transmitting from remote device and verify whether it shall resend or discontinue transmission.





8. ANTENNA REQUIREMENT

8.1 STANDARD REQUIREMENT

15.203 requirement: For intentional device, according to 15.203: an intentional radiator shall be designed to ensure that no antenna other than that furnished by the responsible party shall be used with the device.

8.2 EUT ANTENNA

The EUT antenna is Dipole Antenna. It comply with the standard requirement.





APPENDIX - PHOTOS OF TEST SETUP

Note: See test photos in setup photo document for the actual connections between Product and support equipment.

※※※※END OF THE REPORT※※※※

