



FCC Part 15C Test Report

FCC ID: 2AHR72115PBT

Product Name:	Speaker Box
Trademark:	N/A
Model Name :	BJW-2115PBT BJW-2116PBT, BJW-2117PBT, BJW-2118PBT, BJW-2119PBT, BJW-2120PBT, BJW-2121PBT, BJW-2122PBT, BJW-2123PBT, BJW-2124PBT
Prepared For :	Samson Electronics Inc.
Address :	3400 E, Slauson Ave, Maywood, CA 90270, United States
Prepared By :	Shenzhen BCTC Technology Co., Ltd.
Address :	No.101, Yousong Road, Longhua New District, Shenzhen, China
Test Date:	Mar. 18 – Mar. 24, 2016
Date of Report :	Mar. 25, 2016
Report No.:	BCTC-160302536E



VERIFICATION OF COMPLIANCE

Applicant's name : **Samson Electronics Inc.**
 Address : 3400 E, Slauson Ave, Maywood, CA 90270,United States
Manufacturer's Name : **Samson Electronics Inc.**
 Address : 3400 E, Slauson Ave, Maywood, CA 90270,United States

Product description

Product name : Speaker Box
 Trademark: N/A
 Model Name: BJW-2115PBT
 BJW-2116PBT, BJW-2117PBT, BJW-2118PBT, BJW-2119PBT,
 BJW-2120PBT, BJW-2121PBT, BJW-2122PBT, BJW-2123PBT,
 BJW-2124PBT
 Test procedure FCC Part15.249
 Standards ANSI C63.10-2013

This device described above has been tested by BCTC, and the test results show that the equipment under test (EUT) is in compliance with the FCC requirements. And it is applicable only to the tested sample identified in the report.

This report shall not be reproduced except in full, without the written approval of BCTC, this document may be altered or revised by BCTC, personal only, and shall be noted in the revision of the document.

Test Result.....: **Pass**

Testing Engineer : Eric Yang
 (Eric Yang)

Technical Manager : Sophie Lee
 (Sophia Lee)

Authorized Signatory : Carson Zhang
 (Carson. Zhang)





Table of Contents	Page
1 . SUMMARY OF TEST RESULTS	4
1.1 TEST FACILITY	4
1.2 MEASUREMENT UNCERTAINTY	4
2 . GENERAL INFORMATION	5
2.1 GENERAL DESCRIPTION OF EUT	5
2.2 DESCRIPTION OF TEST MODES	6
2.3 TABLE OF PARAMETERS OF TEXT SOFTWARE SETTING	7
2.4 BLOCK DIGRAM SHOWING THE CONFIGURATION OF SYSTEM TESTED	7
2.5 EQUIPMENTS LIST FOR ALL TEST ITEMS	8
3 . EMC EMISSION TEST	9
3.1 RADIATED EMISSION MEASUREMENT	13
3.1.1 RADIATED EMISSION LIMITS	13
3.1.2 TEST PROCEDURE	14
3.1.3 DEVIATION FROM TEST STANDARD	14
3.1.4 TEST SETUP	15
3.1.5 EUT OPERATING CONDITIONS	16
3.1.6 TEST RESULTS	17
4 . BANDWIDTH TEST	23
4.1 APPLIED PROCEDURES / LIMIT	23
4.1.1 TEST PROCEDURE	23
4.1.2 DEVIATION FROM STANDARD	23
4.1.3 TEST SETUP	23
4.1.4 EUT OPERATION CONDITIONS	23
4.1.5 TEST RESULTS	24
5 . BANDWIDTH OF FREQUENCY BAND EDGE	29
5.1 DEVIATION FROM STANDARD	29
5.2 TEST SETUP	29
5.3 EUT OPERATION CONDITIONS	29
5.4 TEST RESULTS	30
6 . ANTENNA REQUIREMENT	31
6.1 STANDARD REQUIREMENT	31
6.2 EUT ANTENNA	31
7 . EUT TEST PHOTO	32



1. SUMMARY OF TEST RESULTS

Test procedures according to the technical standards:

FCC Part15 (15.249) , Subpart C			
Standard Section	Test Item	Judgment	Remark
15.207	Conducted Emission	PASS	
15.249	Radiated Spurious Emission	PASS	
15.249	Bandwidth	PASS	
15.205	Band Edge Emission	PASS	
15.203	Antenna Requirement	PASS	

NOTE:

(1) "N/A" denotes test is not applicable in this Test Report

1.1 TEST FACILITY

Shenzhen BCTC Technology Co., Ltd.
Add.:No.101,Yousong Road,Longhua New District, Shenzhen,China
FCC Registration No.:187086

1.2 MEASUREMENT UNCERTAINTY

The reported uncertainty of measurement $y \pm U$, where expanded uncertainty U is based on a standard uncertainty multiplied by a coverage factor of $k=2$, providing a level of confidence of approximately **95%**.

No.	Item	Uncertainty
1	Conducted Emission Test	$\pm 1.38\text{dB}$
2	RF power,conducted	$\pm 0.16\text{dB}$
3	Spurious emissions,conducted	$\pm 0.21\text{dB}$
4	All emissions,radiated(<1G)	$\pm 4.68\text{dB}$
5	All emissions,radiated(>1G)	$\pm 4.89\text{dB}$
6	Temperature	$\pm 0.5^{\circ}\text{C}$
7	Humidity	$\pm 2\%$



2. GENERAL INFORMATION

2.1 GENERAL DESCRIPTION OF EUT

Equipment	Speaker Box										
Trade Name	N/A										
Model Name	BJW-2115PBT BJW-2116PBT, BJW-2117PBT, BJW-2118PBT, BJW-2119PBT, BJW-2120PBT, BJW-2121PBT, BJW-2122PBT, BJW-2123PBT, BJW-2124PBT										
Product Description	<table border="1"> <tr> <td>Operation Frequency:</td> <td>2402~2480 MHz</td> </tr> <tr> <td>Modulation Type:</td> <td>GFSK,PI/4 DPSK,8DPSK</td> </tr> <tr> <td>Bit Rate of Transmitter</td> <td>1M/2M/3Mbps</td> </tr> <tr> <td>Number Of Channel</td> <td>79 CH</td> </tr> <tr> <td>Antenna Designation:</td> <td>Please see Note 3.</td> </tr> </table> <p>Based on the application, features, or specification exhibited in User's Manual, the EUT is considered as an ITE/Computing Device. More details of EUT technical specification, please refer to the User's Manual.</p>	Operation Frequency:	2402~2480 MHz	Modulation Type:	GFSK,PI/4 DPSK,8DPSK	Bit Rate of Transmitter	1M/2M/3Mbps	Number Of Channel	79 CH	Antenna Designation:	Please see Note 3.
Operation Frequency:	2402~2480 MHz										
Modulation Type:	GFSK,PI/4 DPSK,8DPSK										
Bit Rate of Transmitter	1M/2M/3Mbps										
Number Of Channel	79 CH										
Antenna Designation:	Please see Note 3.										
Channel List	Please refer to the Note 2.										
Adapter	AC 120/60Hz AC 230V/50Hz										
Battery	N/A										
Connecting I/O Port(s)	Please refer to the User's Manual										
hardware version	--										
Software version	--										
Serial number	--										

Note:

1. For a more detailed features description, please refer to the manufacturer's specifications or the User's Manual.
- 2.

Channel List					
Channel	Frequency (MHz)	Channel	Frequency (MHz)	Channel	Frequency (MHz)
00	2402	27	2429	54	2456
01	2403	28	2430	55	2457
02	2404	29	2431	56	2458
03	2405	30	2432	57	2459
04	2406	31	2433	58	2460
05	2407	32	2434	59	2461
06	2408	33	2435	60	2462
07	2409	34	2436	61	2463
08	2410	35	2437	62	2464
09	2411	36	2438	63	2465



10	2412	37	2439	64	2466
11	2413	38	2440	65	2467
12	2414	39	2441	66	2468
13	2415	40	2442	67	2469
14	2416	41	2443	68	2470
15	2417	42	2444	69	2471
16	2418	43	2445	70	2472
17	2419	44	2446	71	2473
18	2420	45	2447	72	2474
19	2421	46	2448	73	2475
20	2422	47	2449	74	2476
21	2423	48	2450	75	2477
22	2424	49	2451	76	2478
23	2425	50	2452	77	2479
24	2426	51	2453	78	2480
25	2427	52	2454		
26	2428	53	2455		

3.

Table for Filed Antenna

Ant.	Brand	Model Name	Antenna Type	Connector	Gain (dBi)	NOTE
1	N/A	N/A	PCB Antenna	N/A	0	

2.2 DESCRIPTION OF TEST MODES

To investigate the maximum EMI emission characteristics generates from EUT, the test system was pre-scanning tested base on the consideration of following EUT operation mode or test configuration mode which possible have effect on EMI emission level. Each of these EUT operation mode(s) or test configuration mode(s) mentioned above was evaluated respectively.

Pretest Mode	Description	
Mode 1	CH00	GFSK,PI/4 DPSK,8DPSK
Mode 2	CH39	
Mode 3	CH78	
Mode 4	Link Mode	
For Conducted & Radiated Emission		
Final Test Mode	Description	
Mode 1	CH00	GFSK,PI/4 DPSK,8DPSK
Mode 2	CH39	
Mode 3	CH78	
Mode 4	Link Mode	

Note:

- (1) The measurements are performed at the highest, middle, lowest available channels.
- (2) Fully-charged battery is used during the test



2.3 TABLE OF PARAMETERS OF TEXT SOFTWARE SETTING

During testing channel & power controlling software provided by the customer was used to control the operating channel as well as the output power level. The RF output power selection is for the setting of RF output power expected by the customer and is going to be fixed on the firmware of the final end product power parameters of FHSS

Frequency	2402 MHz	2441 MHz	2480 MHz
Channel	Low	Middle	High

2.4 BLOCK DIGRAM SHOWING THE CONFIGURATION OF SYSTEM TESTED

Emission Test

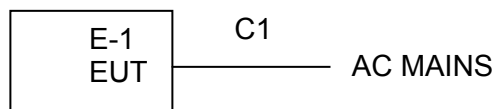

2.5 DESCRIPTION OF SUPPORT UNITS(CONDUCTED MODE)

The EUT has been tested as an independent unit together with other necessary accessories or support units. The following support units or accessories were used to form a representative test configuration during the tests.

Item	Equipment	Mfr/Brand	Model/Type No.	Series No.	Note
E-1	Speaker Box	N/A	BJW-2115PBT	01	EUT

Item	Shielded Type	Ferrite Core	Length	Note
C1	NO	NO	0.5M	

Note:

- (1) The support equipment was authorized by Declaration of Confirmation.
- (2) For detachable type I/O cable should be specified the length in cm in 『Length』 column.
- (3) “YES” is means “shielded” “with core”; “NO” is means “unshielded” “without core”.



2.6 EQUIPMENTS LIST FOR ALL TEST ITEMS

Conduction Test equipment

Item	Kind of Equipment	Manufacturer	Type No.	Serial No.	Last calibration	Calibrated until	Calibration period
1	Test Receiver	R&S	ESCI	1166.5950K03-101165-ha	2015.06.06	2016.06.05	1 year
2	LISN	R&S	NSLK8126	8126466	2015.08.24	2016.08.23	1 year
3	LISN	R&S	NSLK8126	8126487	2015.08.24	2016.08.23	1 year
4	50Ω Coaxial Switch	Anritsu	MP59B	6200264417	2015.06.06	2016.06.05	1 year
5	RF cables	R&S	R204	R20X	2015.06.06	2016.06.05	1 year

Radiation test, Band-edge test and 20db bandwidth test equipment

Item	Kind of Equipment	Manufacturer	Type No.	Serial No.	Last calibration	Calibrated until	Calibration period
1	Spectrum Analyzer	Agilent	E4407B	MY45108040	2015.06.06	2016.06.05	1 year
2	Test Receiver	R&S	ESPI	101318	2015.06.06	2016.06.05	1 year
3	Bilog Antenna	R&S	VULB9168	VULB9168-438	2015.06.06	2016.06.05	1 year
4	50Ω Coaxial Switch	Anritsu	MP59B	6200264416	2015.06.06	2016.06.05	1 year
5	Spectrum Analyzer	ADVANTEST	R3132	150900201	2015.06.06	2016.06.05	1 year
6	Horn Antenna	R&S	HF906	10027	2015.06.06	2016.06.05	1 year
7	Horn Ant	Schwarzbeck	BBHA 9170	9170-181	2015.06.06	2016.06.05	1 year
8	Amplifier	R&S	BBV9743	9743-019	2014.12.22	2015.12.21	1 year
9	Loop Antenna	ARA	PLA-1030/B	1029	2015.06.06	2016.06.05	1 year
10	RF cables	R&S	R203	R20X	2015.06.06	2016.06.05	1 year
11	Antenna connector	Florida RFLabs	Lab-Fle	RF 01#	2015.06.06	2016.06.05	1 year



3. EMC EMISSION TEST

3.1 CONDUCTED EMISSION MEASUREMENT

3.1.1 POWER LINE CONDUCTED EMISSION Limits (Frequency Range 150KHz-30MHz)

FREQUENCY (MHz)	Class B (dBuV)		Standard
	Quas -peak	Average	
0.15 -0.5	66 - 56 *	56 - 46 *	FCC
0.50 -5.0	56.00	46.00	FCC
5.0 -30.0	60.00	50.00	FCC

Note:

- (1) The tighter limit applies at the band edges.
- (2) The limit of " * " marked band means the limitation decreases linearly with the logarithm of the frequency in the range.

The following table is the setting of the receiver

Receiver Parameters	Setting
Attenuation	10 dB
Start Frequency	0.15 MHz
Stop Frequency	30 MHz
IF Bandwidth	9 kHz

3.1.2 TEST PROCEDURE

- The EUT was placed 0.1 meters from the horizontal ground plane with EUT being connected to the power mains through a line impedance stabilization network (LISN). All other support equipments powered from additional LISN(s). The LISN provide 50 Ohm/ 50uH of coupling impedance for the measuring instrument.
- Interconnecting cables that hang closer than 40 cm to the ground plane shall be folded back and forth in the center forming a bundle 30 to 40 cm long.
- I/O cables that are not connected to a peripheral shall be bundled in the center. The end of the cable may be terminated, if required, using the correct terminating impedance. The overall length shall not exceed 1 m.
- LISN at least 80 cm from nearest part of EUT chassis.
- For the actual test configuration, please refer to the related Item –EUT Test Photos.

3.1.3 DEVIATION FROM TEST STANDARD

No deviation

3.1.4 TEST SETUP

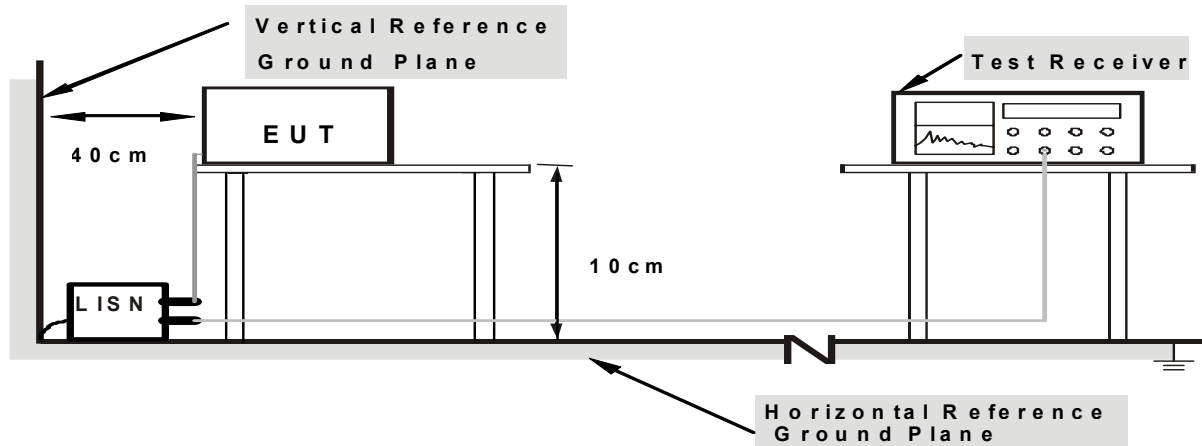

- Note: 1.Support units were connected to second LISN .
2.Both of LISNs (AMN) are 80 cm from EUT and at least 80 from other units and other metal planes

3.1.5 EUT OPERATING CONDITIONS

The EUT was configured for testing in a typical fashion (as a customer would normally use it). The EUT has been programmed to continuously transmit during test. This operating condition was tested and used to collect the included data.

We pretest AC 120V and 240V, The worst mode was AC 120V and the data recording in the report.

The data only show the worst mode.



3.1.6 TEST RESULTS

EUT :	Speaker Box	Model Name :	BJW-2115PBT
Temperature :	25 °C	Relative Humidity :	54%
Pressure :	1010hPa	Phase :	L
Test Voltage :	AC 120V/60Hz	Test Mode :	Mode 4

No.	Mk.	Freq.	Reading Level	Correct Factor	Measurement	Limit	Over	Detector	Comment
		MHz	dBuV	dB	dBuV	dBuV	dB		
1	*	0.1860	50.68	10.06	60.74	64.21	-3.47	QP	
2		0.1860	14.25	10.06	24.31	54.21	-29.90	AVG	
3		0.2420	45.10	10.08	55.18	62.02	-6.84	QP	
4		0.2420	10.90	10.08	20.98	52.02	-31.04	AVG	
5		0.4700	42.83	10.11	52.94	56.51	-3.57	QP	
6		0.4700	4.99	10.11	15.10	46.51	-31.41	AVG	
7		0.5701	42.24	10.12	52.36	56.00	-3.64	QP	
8		0.5701	5.13	10.12	15.25	46.00	-30.75	AVG	
9		2.2180	6.95	10.18	17.13	56.00	-38.87	QP	
10		2.2180	-4.66	10.18	5.52	46.00	-40.48	AVG	
11		24.5740	33.28	10.20	43.48	60.00	-16.52	QP	
12		24.5740	30.40	10.20	40.60	50.00	-9.40	AVG	

Remark:

1. All readings are Quasi-Peak and Average values.
2. Factor = Insertion Loss + Cable Loss.

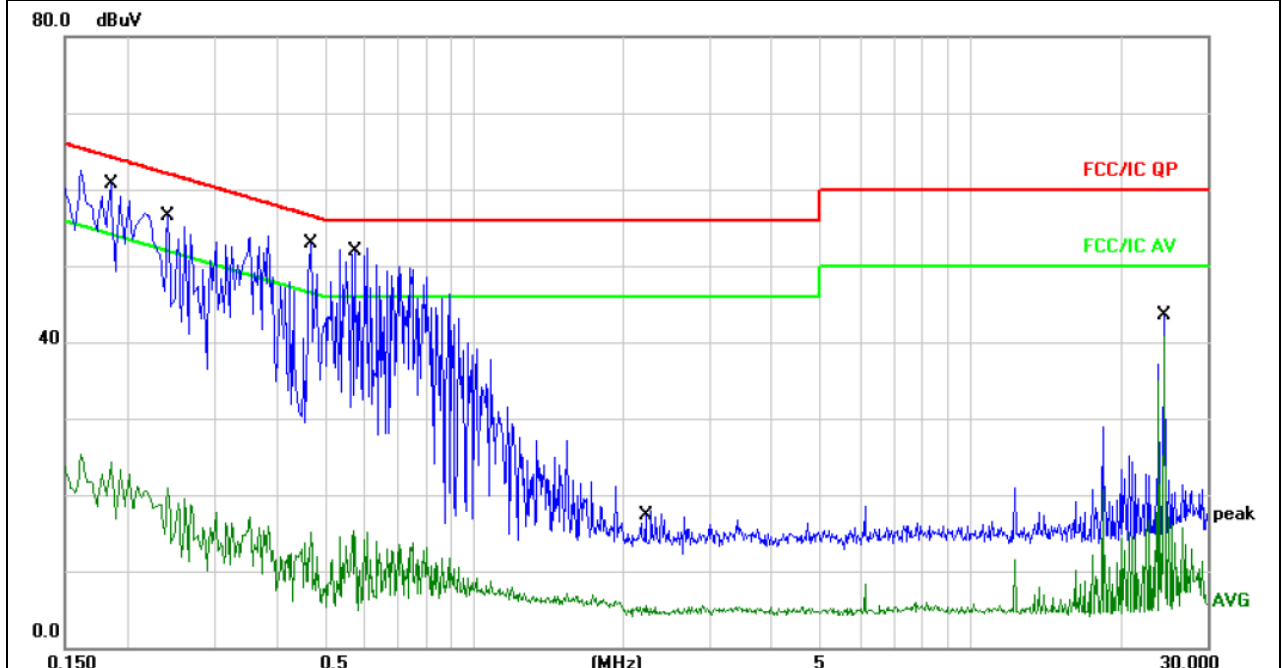



EUT :	Speaker Box	Model Name :	BJW-2115PBT
Temperature :	25 °C	Relative Humidity :	54%
Pressure :	1010hPa	Phase :	N
Test Voltage :	AC 120V/60Hz	Test Mode :	Mode 4

No.	Mk.	Freq.	Reading Level	Correct Factor	Measurement	Limit	Over	Detector	Comment
		MHz	dBuV	dB	dBuV	dBuV	dB		
1		0.1660	51.09	10.06	61.15	65.15	-4.00	QP	
2		0.1660	14.30	10.06	24.36	55.15	-30.79	AVG	
3		0.3420	47.08	10.10	57.18	59.15	-1.97	QP	
4		0.3420	8.65	10.10	18.75	49.15	-30.40	AVG	
5	*	0.6180	44.09	10.13	54.22	56.00	-1.78	QP	
6		0.6180	7.24	10.13	17.37	46.00	-28.63	AVG	
7		0.7340	41.25	10.14	51.39	56.00	-4.61	QP	
8		0.7340	4.92	10.14	15.06	46.00	-30.94	AVG	
9		3.0740	6.08	10.19	16.27	56.00	-39.73	QP	
10		3.0740	-4.64	10.19	5.55	46.00	-40.45	AVG	
11		24.5740	43.51	10.20	53.71	60.00	-6.29	QP	
12		24.5740	35.24	10.20	45.44	50.00	-4.56	AVG	

Remark:

1. All readings are Quasi-Peak and Average values.
2. Factor = Insertion Loss + Cable Loss.

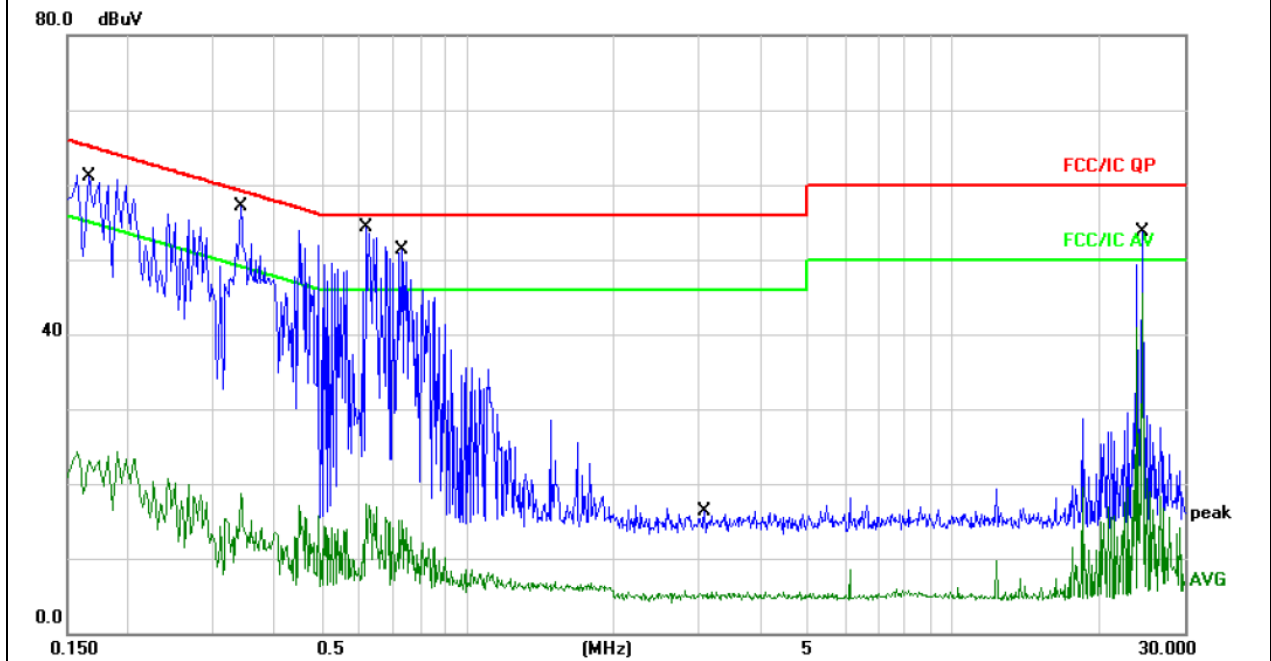



3.2 RADIATED EMISSION MEASUREMENT

3.2.1 RADIATED EMISSION LIMITS (Frequency Range 9kHz-1000MHz)

20dBc in any 100 kHz bandwidth outside the operating frequency band. In case the emission fall within the restricted band specified on 15.205(a), then the 15.209(a) limit in the table below has to be followed.

Frequencies (MHz)	Field Strength (microvolt/meter)	Measurement Distance (meters)
0.009~0.490	2400/F(KHz)	300
0.490~1.705	24000/F(KHz)	30
1.705~30.0	30	30
30~88	100	3
88~216	150	3
216~960	200	3
Above 960	500	3

LIMITS OF RADIATED EMISSION MEASUREMENT (Above 1000MHz)

FREQUENCY (MHz)	Class B (dBuV/m) (at 3M)	
	PEAK	AVERAGE
Above 1000	74	54

Notes:

- (1) The limit for radiated test was performed according to FCC PART 15C.
- (2) The tighter limit applies at the band edges.
- (3) Emission level (dBuV/m)=20log Emission level (uV/m).

FREQUENCY RANGE OF RADIATED MEASUREMENT (For unintentional radiators)

Highest frequency generated or Upper frequency of measurement used in the device or on which the device operates or tunes (MHz)	Range (MHz)
Below 1.705	30
1.705 – 108	1000
108 – 500	2000
500 – 1000	5000
Above 1000	5 th harmonic of the highest frequency or 40 GHz, whichever is lower



Spectrum Parameter	Setting
Attenuation	Auto
Start Frequency	1000 MHz
Stop Frequency	10th carrier harmonic
RB / VB (emission in restricted band)	1 MHz / 1 MHz for Peak, 1 MHz / 10Hz for Average

Receiver Parameter	Setting
Attenuation	Auto
Start ~ Stop Frequency	9kHz~150kHz / RB 200Hz for QP
Start ~ Stop Frequency	150kHz~30MHz / RB 9kHz for QP
Start ~ Stop Frequency	30MHz~1000MHz / RB 120kHz for QP

3.2.2 TEST PROCEDURE

- a. The measuring distance of at 3 m shall be used for measurements at frequency up to 25GHz. For frequencies above 1GHz, any suitable measuring distance may be used.
- b. The EUT was placed on the top of a rotating table 0.1 meters above the ground at a 3 meter open area test site. The table was rotated 360 degrees to determine the position of the highest radiation.
- c. The height of the equipment or of the substitution antenna shall be 0.1 m; the height of the test antenna shall vary between 1 m to 4 m. Both horizontal and vertical polarizations of the antenna are set to make the measurement.
- d. If the Peak Mode measured value compliance with and lower than Quasi Peak Mode Limit, the EUT shall be deemed to meet QP Limits and then no additional QP Mode measurement performed.
- e. For the actual test configuration, please refer to the related Item –EUT Test Photos.
- f. For the radiated emission test above 1GHz:

Place the measurement antenna away from each area of the EUT determined to be a source of emissions at the specified measurement distance, while keeping the measurement antenna aimed at the source of emissions at each frequency of significant emissions, with polarization oriented for maximum response.

The measurement antenna may have to be higher or lower than the EUT, depending on the radiation pattern of the emission and staying aimed at the emission source for receiving the maximum signal. The final measurement antenna elevation shall be that which maximizes the emissions. The measurement antenna elevation for maximum emissions shall be restricted to a range of heights of from 1 m to 4 m above the ground or reference ground plane.

Note:

Both horizontal and vertical antenna polarities were tested and performed pretest to three orthogonal axis. The worst case emissions were reported

3.2.3 DEVIATION FROM TEST STANDARD

No deviation

3.2.4 TEST SETUP

(A) Radiated Emission Test-Up Frequency Below 30MHz

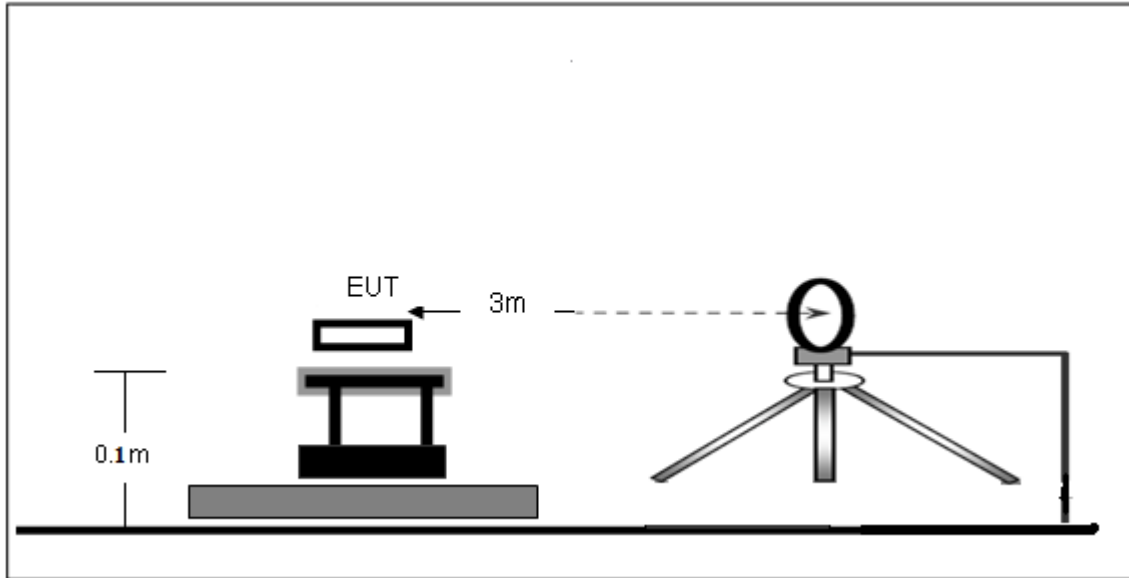

(B) Radiated Emission Test-Up Frequency 30MHz~1GHz

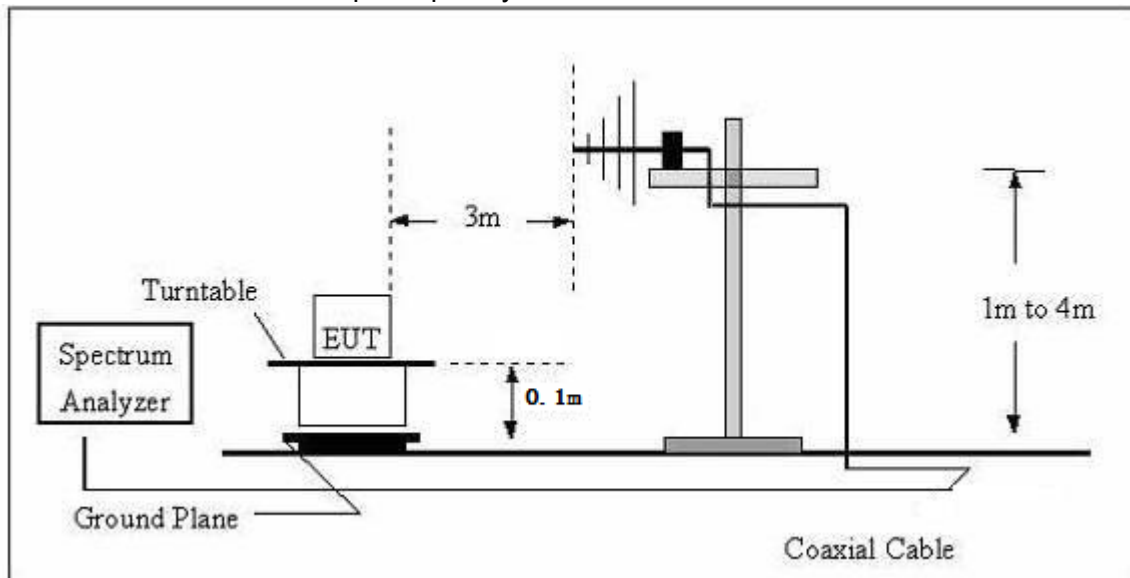

(C) Radiated Emission Test-Up Frequency Above 1GHz

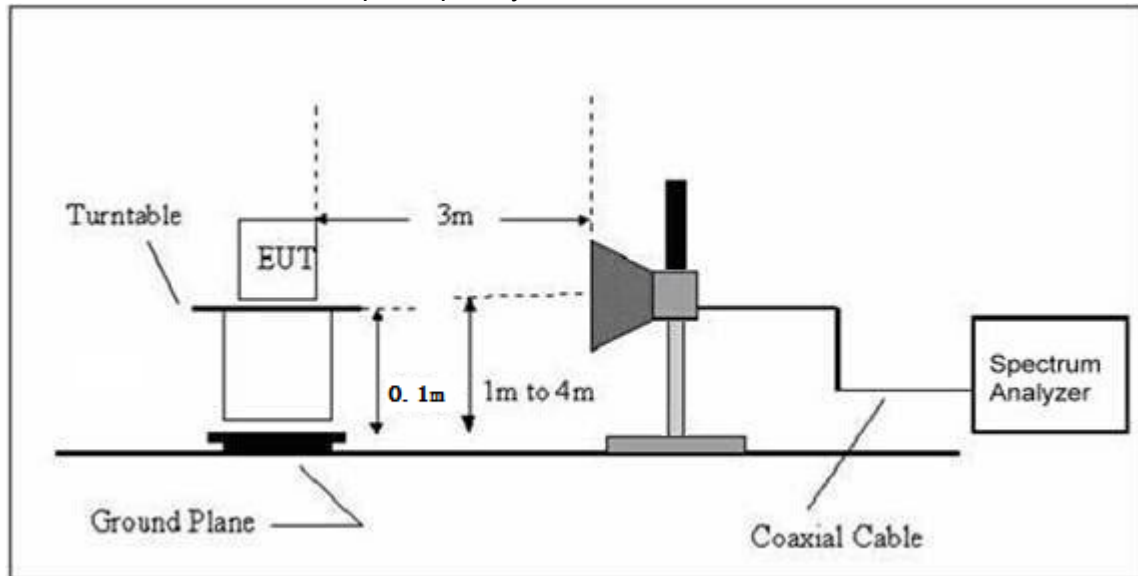
**3.2.5 EUT OPERATING CONDITIONS**

The EUT tested system was configured as the statements of 2.4 Unless otherwise a special operating condition is specified in the follows during the testing.



3.2.6 TEST RESULTS

Radiated Spurious Emission (Below 30MHz)

EUT :	Speaker Box	Model Name :	BJW-2115PBT
Temperature :	20 °C	Relative Humidity :	48%
Pressure :	1010 hPa	Polarization :	---
Test Voltage :	AC 120V/60Hz		
Test Mode :	TX		

Freq. (MHz)	Reading (dBuV/m)	Limit (dBuV/m)	Margin (dB)	State P/F
--	--	--	--	PASS
--	--	--	--	PASS

NOTE:

The amplitude of spurious emissions which are attenuated by more than 20dB below the permissible value has no need to be reported.

Distance extrapolation factor = $40 \log (\text{specific distance}/\text{test distance})$ (dB);

Limit line = specific limits(dBuv) + distance extrapolation factor.



Radiated Spurious Emission (Between 30MHz – 1GHz)

EUT :	Speaker Box	Model Name :	BJW-2115PBT
Temperature :	26 °C	Relative Humidity :	54%
Pressure :	1010 hPa	Polarization :	Horizontal
Test Voltage :	AC 120V/60Hz		
Test Mode : (Worst)	TX Low Channel		

No.	Mk.	Freq. MHz	Reading Level dBuV	Correct Factor dB/m	Measure- ment dBuV/m	Limit dBuV/m	Over dB	Detector	Antenna Height cm	Table Degree degree	Comment
1		35.4993	31.69	-8.55	23.14	40.00	-16.86	QP			
2	*	80.9275	53.81	-18.10	35.71	40.00	-4.29	QP			
3		135.0319	35.70	-13.74	21.96	43.50	-21.54	QP			
4		256.5211	51.50	-14.01	37.49	46.00	-8.51	QP			
5		383.9318	45.72	-10.57	35.15	46.00	-10.85	QP			
6		672.8445	37.35	-4.80	32.55	46.00	-13.45	QP			

Remark:

Factor = Antenna Factor + Cable Loss – Pre-amplifier.

Pretest all mode, the data only show the worst mode.

If peak level comply with Quasi-Peak limit, then the Quasi-Peak level is deemed to comply with Quasi-Peak limit.

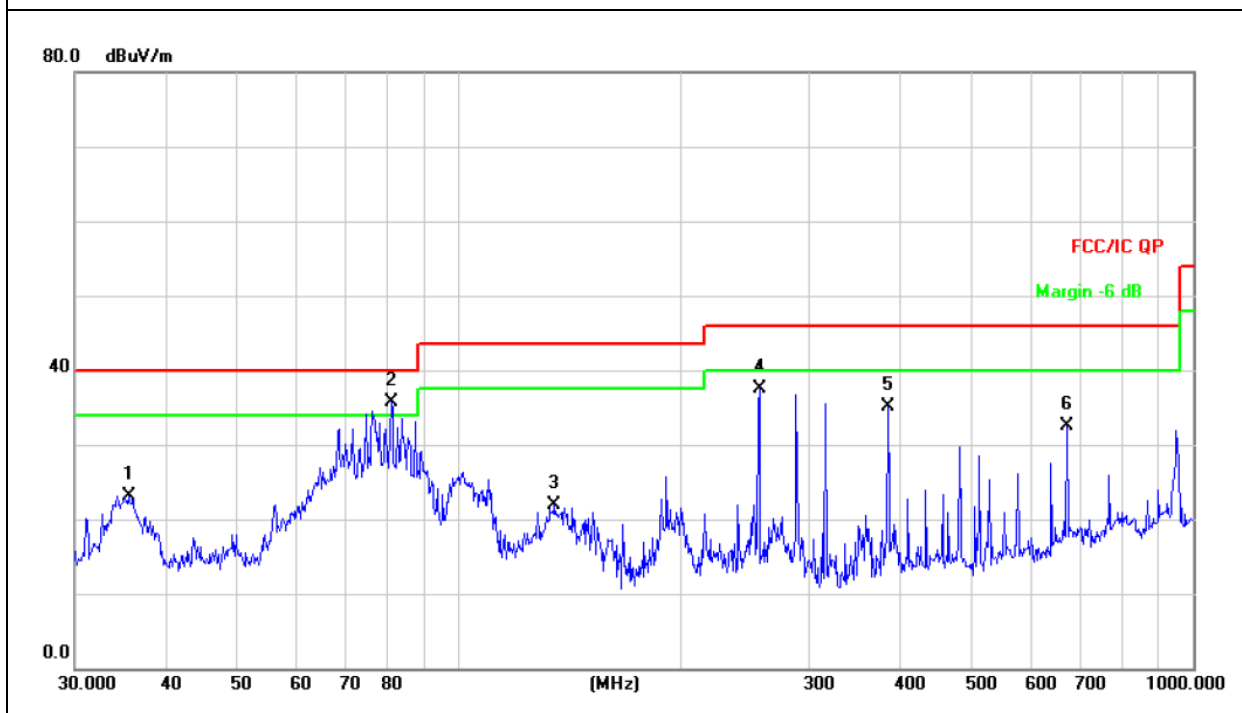



EUT :	Speaker Box	Model Name :	BJW-2115PBT
Temperature :	26 °C	Relative Humidity :	54%
Pressure :	1010 hPa	Polarization :	Vertical
Test Voltage :	AC 120V/60Hz		
Test Mode : (Worst)	TX Low Channel		

No.	Mk.	Freq.	Reading Level	Correct Factor	Measurement	Limit	Over	Antenna Height	Table Degree	
		MHz	dBuV	dB/m	dBuV/m	dBuV/m	dB	cm	degree	Comment
1		35.1278	38.36	-8.51	29.85	40.00	-10.15	QP		
2		74.9191	35.40	-16.29	19.11	40.00	-20.89	QP		
3		99.8777	47.99	-16.49	31.50	43.50	-12.00	QP		
4	*	287.9904	50.54	-12.89	37.65	46.00	-8.35	QP		
5		383.9318	44.17	-10.57	33.60	46.00	-12.40	QP		
6		672.8445	37.95	-4.80	33.15	46.00	-12.85	QP		

Remark:

Factor = Antenna Factor + Cable Loss – Pre-amplifier.

Pretest all mode, the data only show the worst mode.

If peak level comply with Quasi-Peak limit, then the Quasi-Peak level is deemed to comply with Quasi-Peak limit.

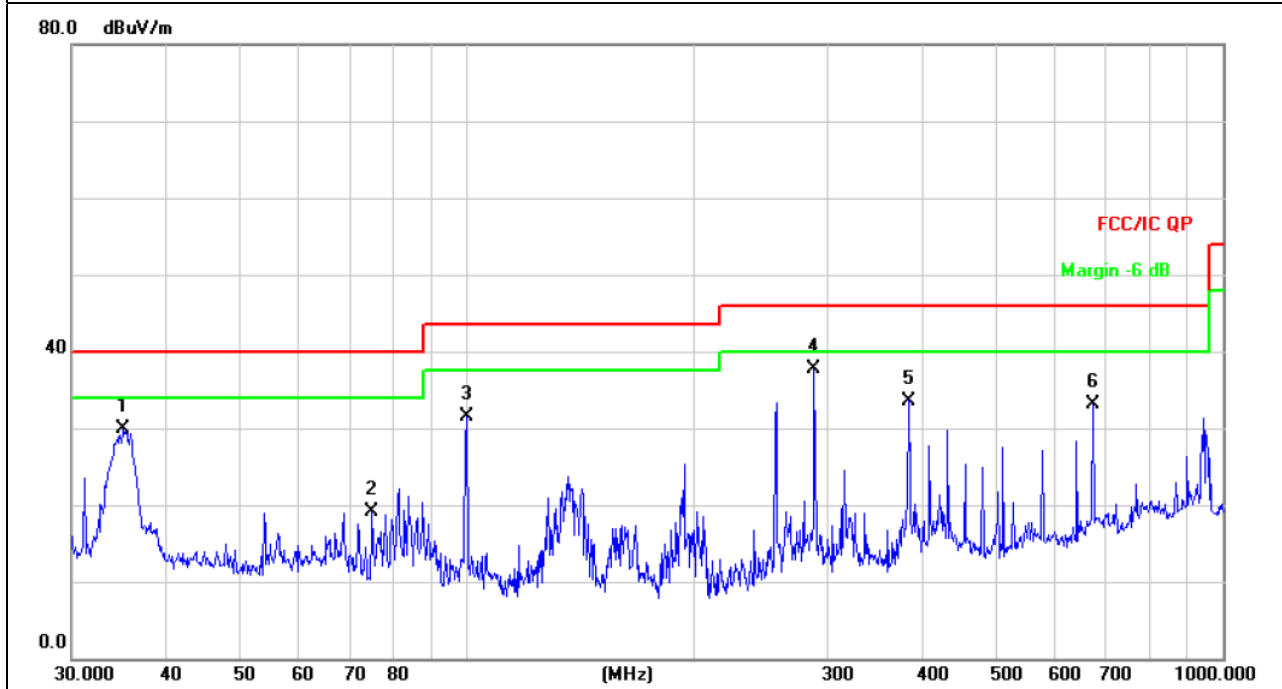



Radiated Spurious Emission (1GHz to 10th harmonics)
GFSK

	Freq.	Receiver Reading	Detector	Polar	Corrected Factor	Emission Level	Limit	Result
	(MHz)	(dBμV)	(PK/QP/Ave)	(H/V)	(dB)	(dBμV/m)	(dBμV/m)	
Lower Channel 2402MHz	2402.00	102.53	PK	H	1.31	103.84	114.00	Pass
	2402.00	88.39	Ave	H	1.31	89.70	94.00	Pass
	4804.00	57.37	PK	H	-1.06	56.31	74.00	Pass
	4804.00	48.42	Ave	H	-1.06	47.36	54.00	Pass
	2402.00	101.47	PK	V	1.31	102.78	114.00	Pass
	2402.00	87.67	Ave	V	1.31	88.98	94.00	Pass
	4804.00	58.37	PK	V	-1.06	57.31	74.00	Pass
	4804.00	46.96	Ave	V	-1.06	45.90	54.00	Pass
	Middle Channel 2441MHz	2441.00	102.39	PK	H	0.85	103.24	114.00
2441.00		87.92	Ave	H	0.85	88.77	94.00	Pass
4882.00		54.23	PK	H	-0.62	53.61	74.00	Pass
4882.00		43.44	Ave	H	-0.62	42.82	54.00	Pass
2441.00		101.20	PK	V	0.85	102.05	114.00	Pass
2441.00		86.36	Ave	V	0.85	87.21	94.00	Pass
4882.00		54.53	PK	V	-0.62	53.91	74.00	Pass
4882.00		43.31	Ave	V	-0.62	42.69	54.00	Pass
Upper Channel 2480MHz	2480.00	99.83	PK	H	0.53	100.36	114.00	Pass
	2480.00	85.62	Ave	H	0.53	86.15	94.00	Pass
	4960.00	50.94	PK	H	-0.24	50.70	74.00	Pass
	4960.00	42.18	Ave	H	-0.24	41.94	54.00	Pass
	2480.00	99.01	PK	V	0.53	99.54	114.00	Pass
	2480.00	84.92	Ave	V	0.53	85.45	94.00	Pass
	4960.00	53.04	PK	V	-0.24	52.80	74.00	Pass
	4960.00	42.38	Ave	V	-0.24	42.14	54.00	Pass

Remark:

Factor = Antenna Factor + Cable Loss – Pre-amplifier.

Emission Level = Meter Reading + Factor

Margin = Emission Level - Limit

Other harmonics emissions are lower than 20dB below the allowable limit.



PI/4 DPSK

	Freq.	Receiver Reading	Detector	Polar	Corrected Factor	Emission Level	Limit	Result
	(MHz)	(dBμV)	(PK/QP/Ave)	(H/V)	(dB)	(dBμV/m)	(dBμV/m)	
Lower Channel 2402MHz	2402.00	101.38	PK	H	1.31	102.69	114.00	Pass
	2402.00	87.39	Ave	H	1.31	88.70	94.00	Pass
	4804.00	56.71	PK	H	-1.06	55.65	74.00	Pass
	4804.00	47.89	Ave	H	-1.06	46.83	54.00	Pass
	2402.00	100.31	PK	V	1.31	101.62	114.00	Pass
	2402.00	86.67	Ave	V	1.31	87.98	94.00	Pass
	4804.00	57.73	PK	V	-1.06	56.67	74.00	Pass
	4804.00	46.43	Ave	V	-1.06	45.37	54.00	Pass
	Middle Channel 2441MHz	2441.00	101.24	PK	H	0.85	102.09	114.00
2441.00		86.94	Ave	H	0.85	87.79	94.00	Pass
4882.00		53.61	PK	H	-0.62	52.99	74.00	Pass
4882.00		42.97	Ave	H	-0.62	42.35	54.00	Pass
2441.00		100.06	PK	V	0.85	100.91	114.00	Pass
2441.00		85.39	Ave	V	0.85	86.24	94.00	Pass
4882.00		53.93	PK	V	-0.62	53.31	74.00	Pass
4882.00		42.83	Ave	V	-0.62	42.21	54.00	Pass
Upper Channel 2480MHz	2480.00	98.70	PK	H	0.53	99.23	114.00	Pass
	2480.00	84.67	Ave	H	0.53	85.20	94.00	Pass
	4960.00	50.35	PK	H	-0.24	50.11	74.00	Pass
	4960.00	41.69	Ave	H	-0.24	41.45	54.00	Pass
	2480.00	97.90	PK	V	0.53	98.43	114.00	Pass
	2480.00	83.96	Ave	V	0.53	84.49	94.00	Pass
	4960.00	52.45	PK	V	-0.24	52.21	74.00	Pass
	4960.00	41.90	Ave	V	-0.24	41.66	54.00	Pass

Remark:

Factor = Antenna Factor + Cable Loss – Pre-amplifier.

Emission Level = Meter Reading + Factor

Margin = Emission Level - Limit

Other harmonics emissions are lower than 20dB below the allowable limit.

8DPSK



	Freq.	Receiver Reading	Detector	Polar	Corrected Factor	Emission Level	Limit	Result	
	(MHz)	(dBμV)	(PK/QP/Ave)	(H/V)	(dB)	(dBμV/m)	(dBμV/m)		
Lower Channel 2402MHz	2402.00	101.93	PK	H	1.31	103.24	114.00	Pass	
	2402.00	87.87	Ave	H	1.31	89.18	94.00	Pass	
	4804.00	57.02	PK	H	-1.06	55.96	74.00	Pass	
	4804.00	48.15	Ave	H	-1.06	47.09	54.00	Pass	
	2402.00	100.85	PK	V	1.31	102.16	114.00	Pass	
	2402.00	87.17	Ave	V	1.31	88.48	94.00	Pass	
	4804.00	58.03	PK	V	-1.06	56.97	74.00	Pass	
	4804.00	46.66	Ave	V	-1.06	45.60	54.00	Pass	
	Middle Channel 2441MHz	2441.00	101.81	PK	H	0.85	102.66	114.00	Pass
		2441.00	87.40	Ave	H	0.85	88.25	94.00	Pass
4882.00		53.91	PK	H	-0.62	53.29	74.00	Pass	
4882.00		43.19	Ave	H	-0.62	42.57	54.00	Pass	
2441.00		100.61	PK	V	0.85	101.46	114.00	Pass	
2441.00		85.85	Ave	V	0.85	86.70	94.00	Pass	
4882.00		54.22	PK	V	-0.62	53.60	74.00	Pass	
4882.00		43.06	Ave	V	-0.62	42.44	54.00	Pass	
Upper Channel 2480MHz	2480.00	99.24	PK	H	0.53	99.77	114.00	Pass	
	2480.00	85.12	Ave	H	0.53	85.65	94.00	Pass	
	4960.00	50.63	PK	H	-0.24	50.39	74.00	Pass	
	4960.00	41.93	Ave	H	-0.24	41.69	54.00	Pass	
	2480.00	98.43	PK	V	0.53	98.96	114.00	Pass	
	2480.00	84.41	Ave	V	0.53	84.94	94.00	Pass	
	4960.00	52.74	PK	V	-0.24	52.50	74.00	Pass	
	4960.00	42.13	Ave	V	-0.24	41.89	54.00	Pass	

Remark:

Factor = Antenna Factor + Cable Loss – Pre-amplifier.

Emission Level = Meter Reading + Factor

Margin = Emission Level - Limit

Other harmonics emissions are lower than 20dB below the allowable limit.



4. BANDWIDTH TEST

4.1 APPLIED PROCEDURES / LIMIT

FCC Part15 (15.249) , Subpart C				
Section	Test Item	Limit	Frequency Range (MHz)	Result
15.249	Bandwidth	(20dB bandwidth)	2400-2483.5	PASS

Spectrum Parameter	Setting
Attenuation	Auto
Span Frequency	> Measurement Bandwidth or Channel Separation
RB	30KHz
VB	\geq RBW
Detector	Peak
Trace	Max Hold
Sweep Time	Auto

4.1.1 TEST PROCEDURE

- The EUT was directly connected to the spectrum analyzer and antenna output port as show in the block diagram below,
- Spectrum Setting : RBW= 30KHz, VBW \geq RBW, Sweep time = Auto.

4.1.2 DEVIATION FROM STANDARD

No deviation.

4.1.3 TEST SETUP



4.1.4 EUT OPERATION CONDITIONS

The EUT tested system was configured as the statements of 2.4 Unless otherwise a special operating condition is specified in the follows during the testing.



4.1.5 TEST RESULTS

EUT :	Speaker Box	Model Name :	BJW-2115PBT
Temperature :	25 °C	Relative Humidity :	60%
Pressure :	1012 hPa	Test Voltage :	DC 5V from adapter
Test Mode :	CH00 / CH39 /C78		

	Frequency	20dB Bandwidth (MHz)	Result
GFSK	2402 MHz	0.931	PASS
	2441 MHz	0.927	PASS
	2480 MHz	0.943	PASS
PI/4 DPSK	2402 MHz	1.101	PASS
	2441 MHz	1.167	PASS
	2480 MHz	1.167	PASS
8DPSK	2402 MHz	1.228	PASS
	2441 MHz	1.201	PASS
	2480 MHz	1.178	PASS

GFSK

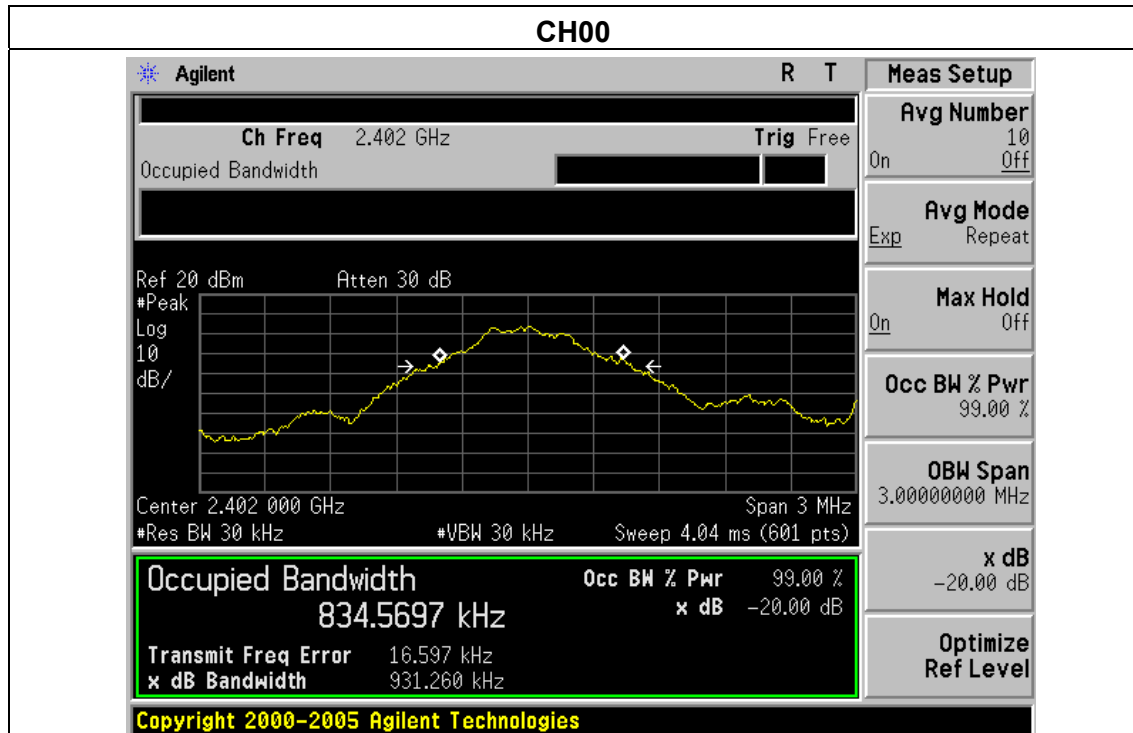

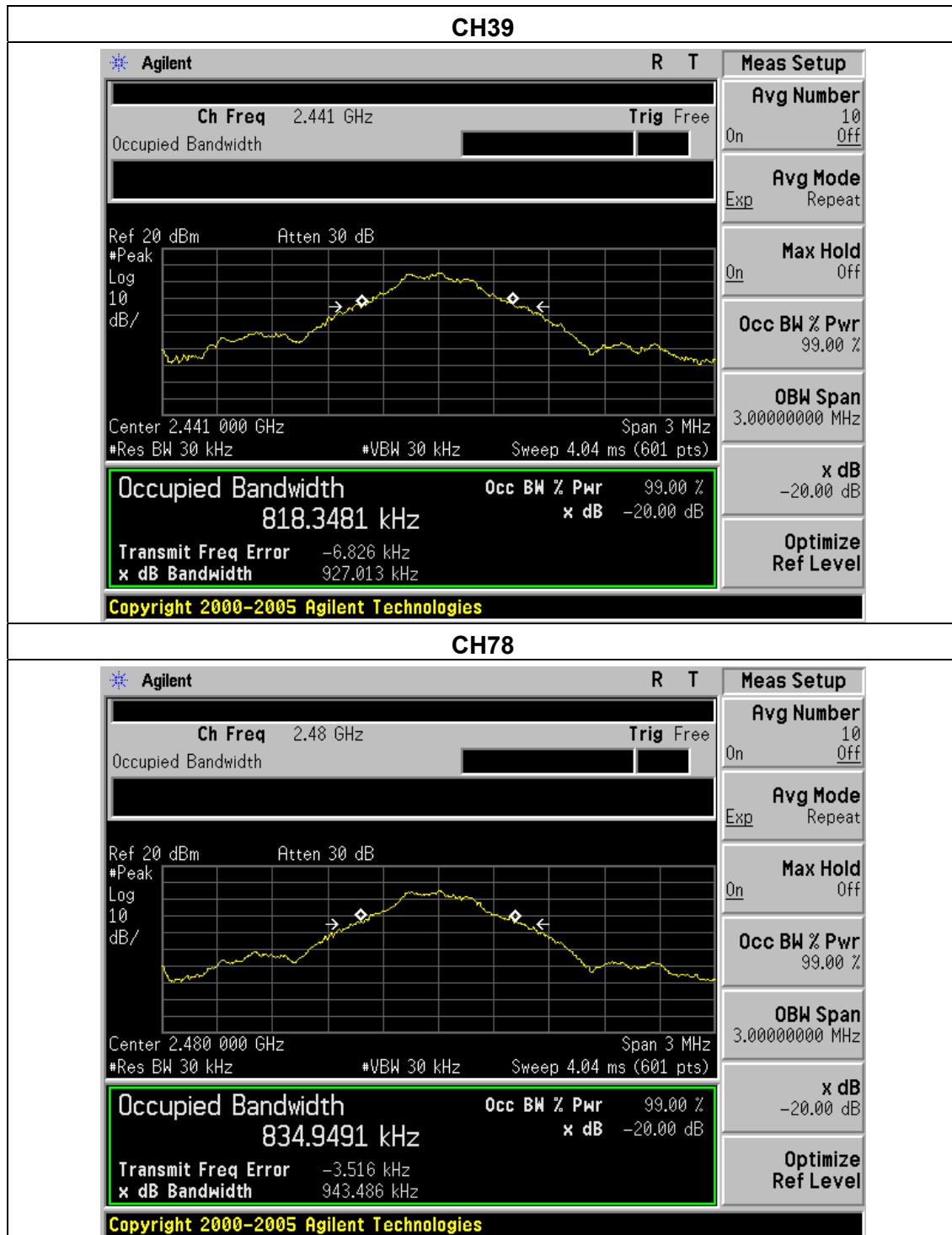



PI/4 DPSK

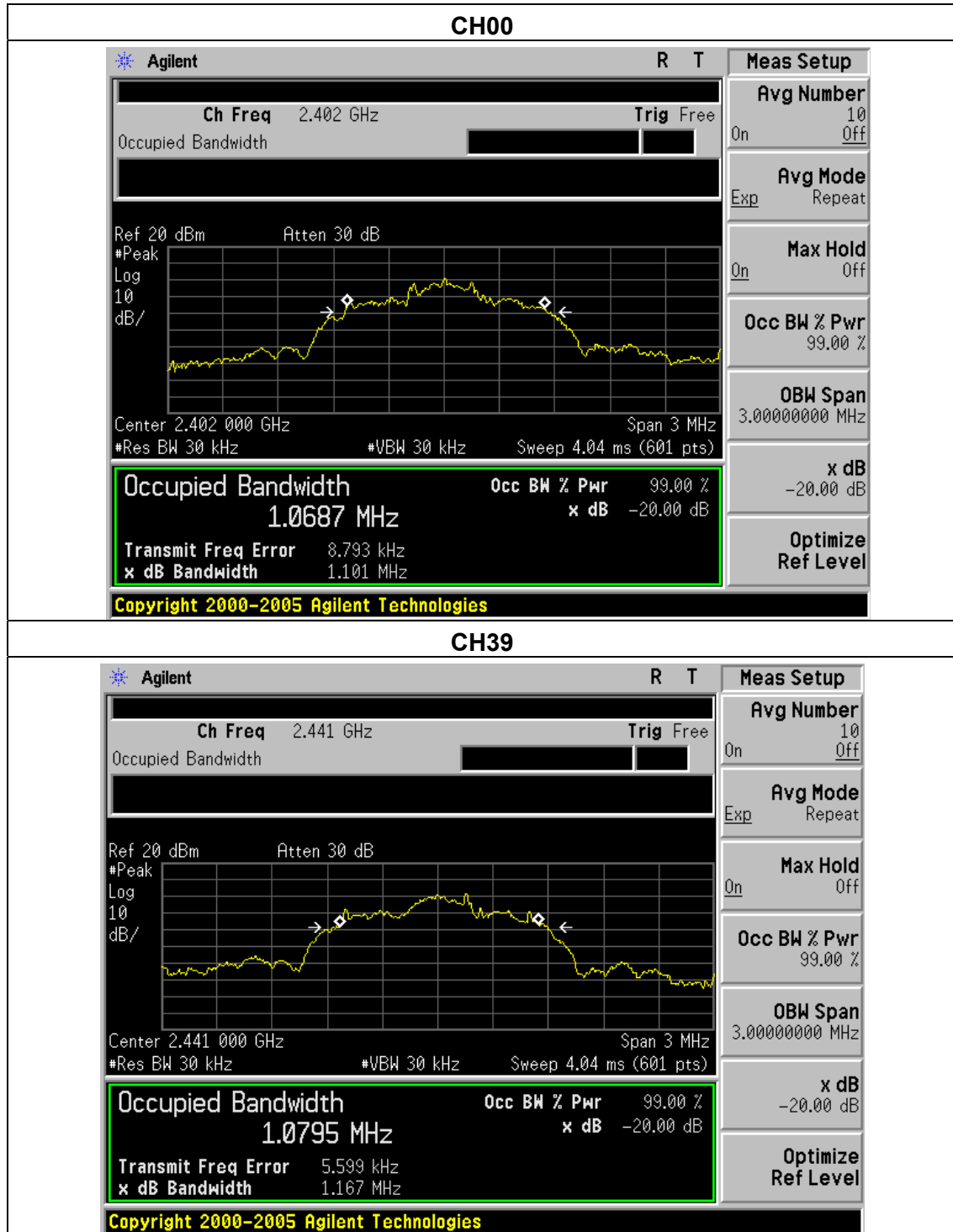

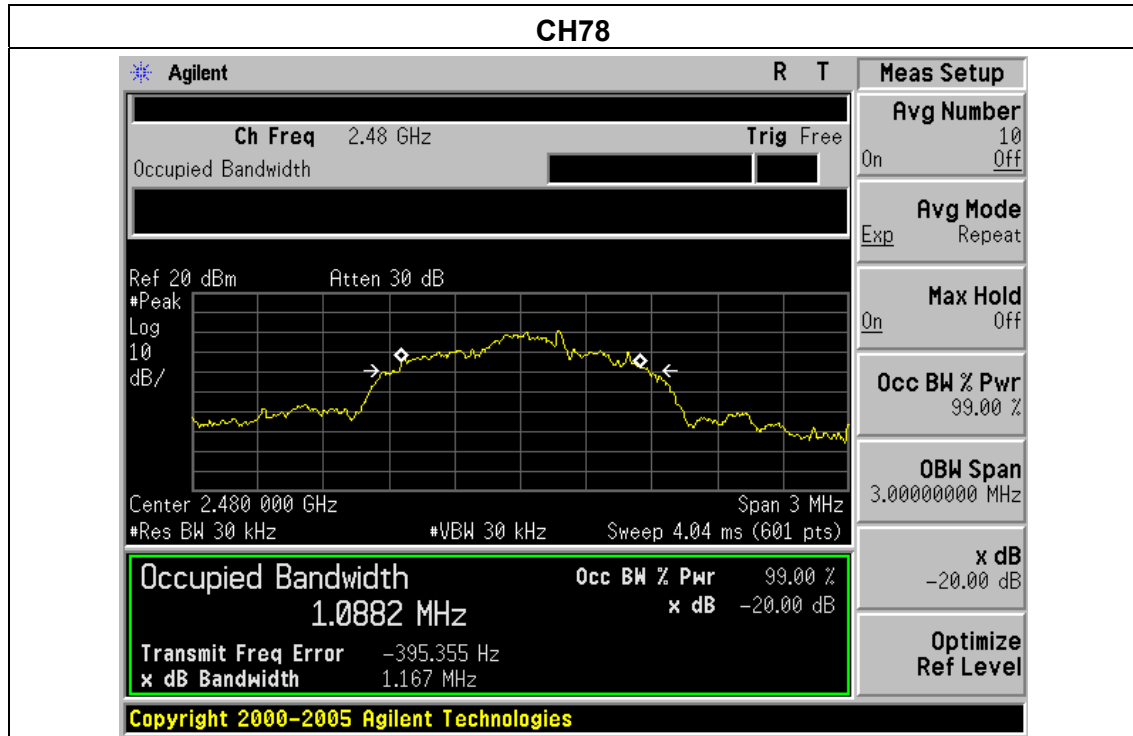

8DPSK

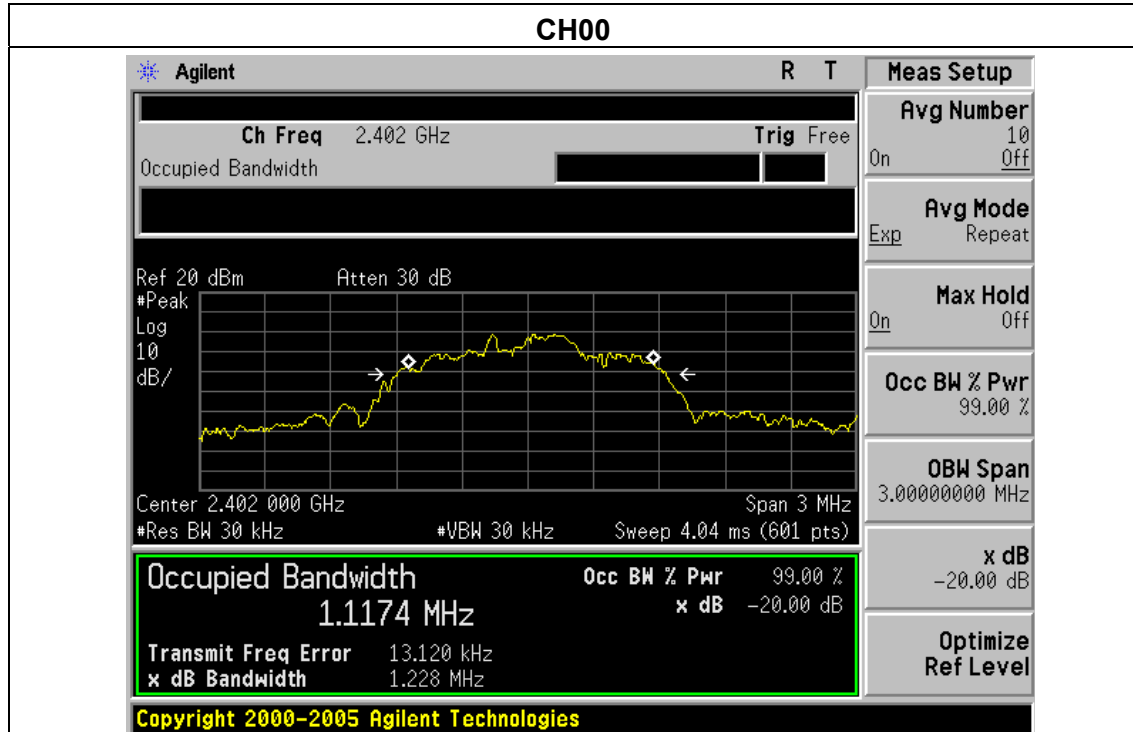

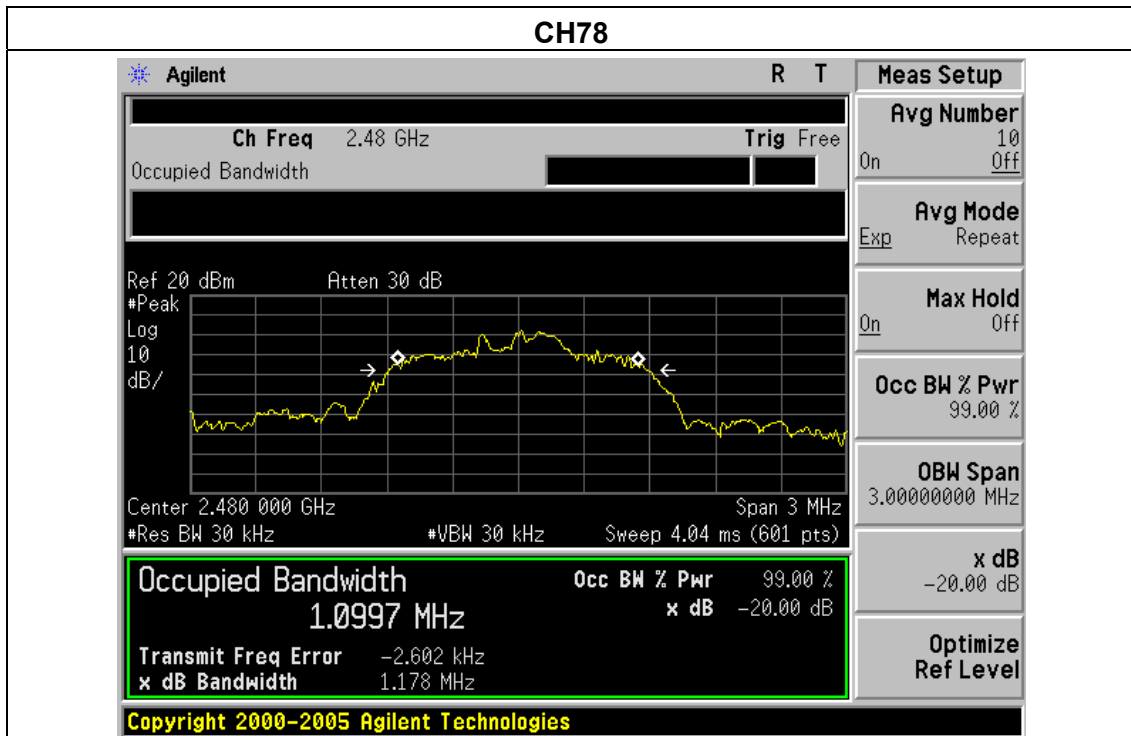
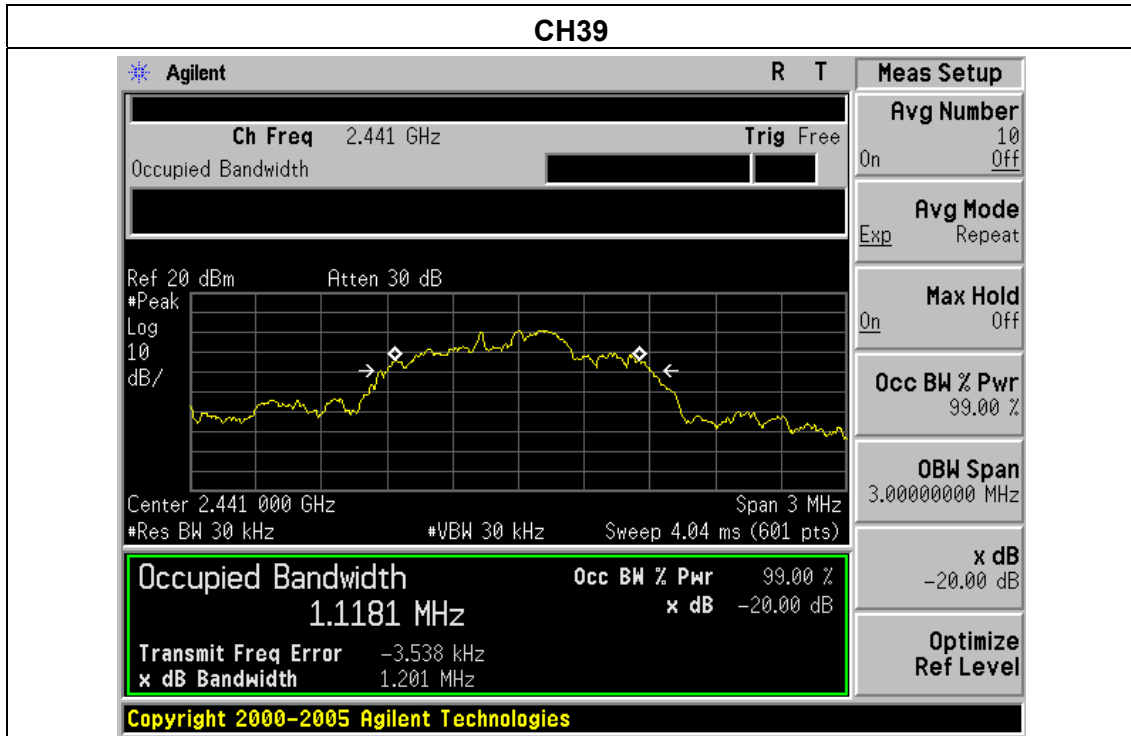



5. BANDWIDTH OF FREQUENCY BAND EDGE

APPLICABLE STANDARD

Emissions radiated outside of the specified frequency bands, except for harmonics, shall be attenuated by at least 50 dB below the level of the fundamental or to the general radiated emission limits in §15.209, whichever is the lesser attenuation.

TEST PROCEDURE

- a. The measuring distance of at 3 m shall be used for measurements at frequency up to 25GHz. For frequencies above 1GHz, any suitable measuring distance may be used.
- b. The EUT was placed on the top of a rotating table 1.5 meters above the ground at a 3 meter open area test site. The table was rotated 360 degrees to determine the position of the highest radiation.
- c. The height of the equipment or of the substitution antenna shall be 1.5 m; the height of the test antenna shall vary between 1 m to 4 m. Both horizontal and vertical polarizations of the antenna are set to make the measurement.
- d. If the Peak Mode measured value compliance with and lower than Quasi Peak Mode Limit, the EUT shall be deemed to meet QP Limits and then no additional QP Mode measurement performed.
- e. For the actual test configuration, please refer to the related Item –EUT Test Photos.
- f. For the radiated emission test above 1GHz:
Place the measurement antenna away from each area of the EUT determined to be a source of emissions at the specified measurement distance, while keeping the measurement antenna aimed at the source of emissions at each frequency of significant emissions, with polarization oriented for maximum response.
The measurement antenna may have to be higher or lower than the EUT, depending on the radiation pattern of the emission and staying aimed at the emission source for receiving the maximum signal. The final measurement antenna elevation shall be that which maximizes the emissions. The measurement antenna elevation for maximum emissions shall be restricted to a range of heights of from 1 m to 4 m above the ground or reference ground plane.
- g Spectrum Setting : RBW= 1MHz, VBW=3MHz, Sweep time = Auto for peak
RBW= 1MHz, VBW=10Hz, Sweep time = Auto for average

Note:

Both horizontal and vertical antenna polarities were tested and performed pretest to three orthogonal axis. The worst case emissions were reported

5.1 DEVIATION FROM STANDARD

No deviation.

5.2 TEST SETUP

5.3 EUT OPERATION CONDITIONS

The EUT tested system was configured as the statements of 2.4 Unless otherwise a special operating condition is specified in the follows during the testing.



5.4 TEST RESULTS

		Frequency (MHz)	Antenna polarization (H/V)	Emission (dBuV/m)	Band edge Limit (dBuV/m)		Result
				PK	PK	AV	
GFSK	Hopping	<2400	H	50.71	74.00	54.00	Pass
		<2400	V	49.94	74.00	54.00	Pass
		>2483.5	H	49.81	74.00	54.00	Pass
		>2483.5	V	50.39	74.00	54.00	Pass
	Unhopping	<2400	H	50.00	74.00	54.00	Pass
		<2400	V	49.74	74.00	54.00	Pass
		>2483.5	H	50.04	74.00	54.00	Pass
		>2483.5	V	50.49	74.00	54.00	Pass
PI/4 DPSK	Hopping	<2400	H	50.23	74.00	54.00	Pass
		<2400	V	49.71	74.00	54.00	Pass
		>2483.5	H	49.59	74.00	54.00	Pass
		>2483.5	V	50.24	74.00	54.00	Pass
	Unhopping	<2400	H	49.48	74.00	54.00	Pass
		<2400	V	49.12	74.00	54.00	Pass
		>2483.5	H	49.03	74.00	54.00	Pass
		>2483.5	V	48.78	74.00	54.00	Pass
8DPSK	Hopping	<2400	H	50.54	74.00	54.00	Pass
		<2400	V	50.02	74.00	54.00	Pass
		>2483.5	H	49.89	74.00	54.00	Pass
		>2483.5	V	50.55	74.00	54.00	Pass
	Unhopping	<2400	H	49.78	74.00	54.00	Pass
		<2400	V	49.42	74.00	54.00	Pass
		>2483.5	H	49.33	74.00	54.00	Pass
		>2483.5	V	49.08	74.00	54.00	Pass

If the PK measured levels comply with average limit, then the average level were deemed to comply with average limit.



6. ANTENNA REQUIREMENT

6.1 STANDARD REQUIREMENT

15.203 requirement: For intentional device, according to 15.203: an intentional radiator shall be designed to ensure that no antenna other than that furnished by the responsible party shall be used with the device.

6.2 EUT ANTENNA

The EUT antenna is PCB antenna. It complies with the standard requirement.

7. EUT TEST PHOTO

Radiated Measurement Photos

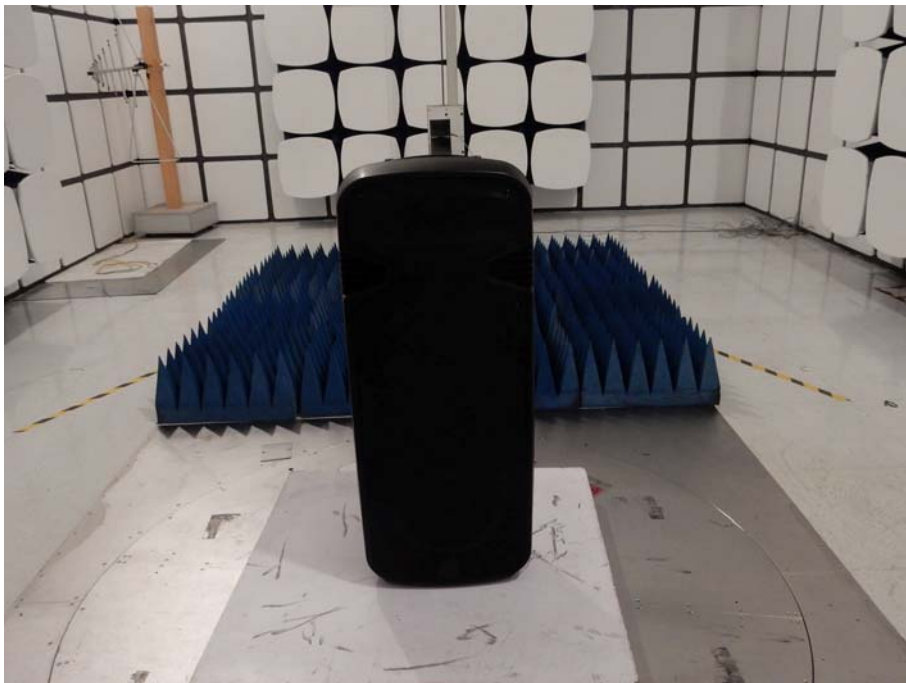

Conducted Emission



8. PHOTO OF THE EUT





