



FCC RADIO TEST REPORT

FCC ID: 2AHR2SP3178-BK6

Product : Portable Bluetooth Speaker

Trade Name : E-LIVI

Model Name : SP3178-BK6

SP3178-CO6,SP3178-SF6,SP3178-WH6,
SP3201-BKA, SP3201-BLA, SP3201-STA,

Serial Model : SP3202-BKA,SP3202-CCA,SP3202-STA,
ps-01,ps-02A,ps-02B,ps-02C,ps-03A,ps-03B
ps-04A,ps-04B,ps-04C

Report No. : POCE2016080149F

Prepared for

E-LIVI (SHENZHEN) ELECTRONICS CO.,LTD

ROOM 7168, 7TH FLOOR, BLOCK C. ELECTRONICS TECHNOLOGY
BUILDING NO. 2070 SHENNAN MIDDLE ROAD ,SHENZHEN, CHINA

Prepared by

Shenzhen POCE Technology Co.,Ltd.

Room 502, Bldg. 1, Xinghua Garden, Baoan Road Xixiang,
Baoan District,Shenzhen, China

TEST RESULT CERTIFICATION

Applicant's name : E-LIVI (SHENZHEN) ELECTRONICS CO.,LTD
Address : ROOM 7168, 7TH FLOOR, BLOCK C. ELECTRONICS
TECHNOLOGY BUILDING NO. 2070 SHENNAN MIDDLE
ROAD ,SHENZHEN, CHINA
Manufacture's Name..... : E-LIVI (SHENZHEN) ELECTRONICS CO.,LTD
Address : ROOM 7168, 7TH FLOOR, BLOCK C. ELECTRONICS
TECHNOLOGY BUILDING NO. 2070 SHENNAN MIDDLE
ROAD ,SHENZHEN, CHINA

Product description

Product name : Portable Bluetooth Speaker

Standards : FCC Part15.247

Test procedure ANSI C63.10-2013

This device described above has been tested by POCE, and the test results show that the equipment under test (EUT) is in compliance with the FCC requirements. And it is applicable only to the tested sample identified in the report.

This report shall not be reproduced except in full, without the written approval of POCE, this document may be altered or revised by POCE, personal only, and shall be noted in the revision of the document.

Date of Test :
Date (s) of performance of tests : 20 Aug. 2016 ~31 Aug. 2016
Date of Issue..... : 31 Aug. 2016
Test Result..... : **Pass**

Testing Engineer : 
(Ken Li)

Technical Manager : 
(Jimmy Yao)

Authorized Signatory : 
(Terry Yang)

Table of Contents

	Page
1 . SUMMARY OF TEST RESULTS	5
1.1 TEST FACILITY	6
1.2 MEASUREMENT UNCERTAINTY	6
2 . GENERAL INFORMATION	7
2.1 GENERAL DESCRIPTION OF EUT	7
2.2 DESCRIPTION OF TEST MODES	9
2.3 TABLE OF PARAMETERS OF TEXT SOFTWARE SETTING	9
2.4 BLOCK DIGRAM SHOWING THE CONFIGURATION OF SYSTEM TESTED	10
2.5 DESCRIPTION OF SUPPORT UNITS(CONDUCTED MODE)	11
2.6 EQUIPMENTS LIST FOR ALL TEST ITEMS	12
3 . EMC EMISSION TEST	13
3.1 CONDUCTED EMISSION MEASUREMENT	13
3.1.1 POWER LINE CONDUCTED EMISSION LIMITS	13
3.1.2 TEST PROCEDURE	14
3.1.3 DEVIATION FROM TEST STANDARD	14
3.1.4 TEST SETUP	14
3.1.5 EUT OPERATING CONDITIONS	14
3.1.6 TEST RESULTS	15
3.2 RADIATED EMISSION MEASUREMENT	17
3.2.1 RADIATED EMISSIONLIMITS(FREQUENCY RANGE 9KHZ-1000MHZ)	17
3.2.2 TEST PROCEDURE	17
3.2.3 DEVIATION FROM TEST STANDARD	18
3.2.4 TEST SETUP	19
3.2.5 EUT OPERATING CONDITIONS	20
3.2.6 TEST RESULTS (BELOW 30 MHZ)	21
3.2.7 TEST RESULTS (30MHZ-1GHZ)	22
3.2.8 TEST RESULTS (1G-25GHZ)	24
4 . NUMBER OF HOPPING CHANNEL	27
4.1 APPLIED PROCEDURES / LIMIT	27
4.1.1 TEST PROCEDURE	27
4.1.2 DEVIATION FROM STANDARD	27
4.1.3 TEST SETUP	27
4.1.4 EUT OPERATION CONDITIONS	27
4.1.5 TEST RESULTS	28
5 . AVERAGE TIME OF OCCUPANCY	29
5.1 APPLIED PROCEDURES / LIMIT	29
5.1.1 TEST PROCEDURE	29

Table of Contents		Page
5.1.2 DEVIATION FROM STANDARD		29
5.1.3 TEST SETUP		30
5.1.4 EUT OPERATION CONDITIONS		30
5.1.5 TEST RESULTS		31
6 . HOPPING CHANNEL SEPARATION MEASUREMENT		37
6.1 APPLIED PROCEDURES / LIMIT		37
6.1.1 TEST PROCEDURE		37
6.1.2 DEVIATION FROM STANDARD		37
6.1.3 TEST SETUP		37
6.1.4 EUT OPERATION CONDITIONS		37
6.1.5 TEST RESULTS		38
7 . BANDWIDTH TEST		44
7.1 APPLIED PROCEDURES / LIMIT		44
7.1.1 TEST PROCEDURE		44
7.1.2 DEVIATION FROM STANDARD		44
7.1.3 TEST SETUP		44
7.1.4 EUT OPERATION CONDITIONS		44
7.1.5 TEST RESULTS		45
8 . PEAK OUTPUT POWER TEST		51
8.1 APPLIED PROCEDURES / LIMIT		51
8.1.1 TEST PROCEDURE		51
8.1.2 DEVIATION FROM STANDARD		51
8.1.3 TEST SETUP		51
8.1.4 EUT OPERATION CONDITIONS		51
8.1.5 TEST RESULTS		52
9 . ANTENNA REQUIREMENT		58
9.1 STANDARD REQUIREMENT		58
9.2 EUT ANTENNA		58
10.CONDUCTED SPURIOUS EMISSIONS		59
11 . EUT TEST PHOTO		69

1. SUMMARY OF TEST RESULTS

Test procedures according to the technical standards:

FCC Part15 (15.247) , Subpart C			
Standard Section	Test Item	Judgment	Remark
15.207	Conducted Emission	PASS	
15.247(a)(1)	Hopping Channel Separation	PASS	
15.247(b)(1)	Peak Output Power	PASS	
15.247(c)	Radiated Spurious Emission	PASS	
15.247(d)	Conducted spurious Emission	PASS	
15.247(a)(iii)	Number of Hopping Frequency	PASS	
15.247(a)(iii)	Dwell Time	PASS	
15.247(a)(1)	Bandwidth	PASS	
15.205	Band Edge Emission	PASS	
15.203	Antenna Requirement	PASS	

1.1 TEST FACILITY

Shenzhen POCE Technology Co.,Ltd.

Add. : Room 502, Bldg. 1, Xinghua Garden, Baoan Road Xixiang, Baoan District, Shenzhen, China

FCC Registered No.: 222278

1.2 MEASUREMENT UNCERTAINTY

The reported uncertainty of measurement $y \pm U$, where expanded uncertainty U is based on a standard uncertainty multiplied by a coverage factor of $k=2$, providing a level of confidence of approximately 95 %.

No.	Item	Uncertainty
1	Conducted Emission Test	$\pm 1.38\text{dB}$
2	RF power,conducted	$\pm 0.16\text{dB}$
3	Spurious emissions,conducted	$\pm 0.21\text{dB}$
4	All emissions,radiated(<1G)	$\pm 4.68\text{dB}$
5	All emissions,radiated(>1G)	$\pm 4.89\text{dB}$
6	Temperature	$\pm 0.5^{\circ}\text{C}$
7	Humidity	$\pm 2\%$

2. GENERAL INFORMATION

2.1 GENERAL DESCRIPTION OF EUT

Equipment	Portable Bluetooth Speaker	
Trade Name	E-LIVI	
Model Name	SP3178-BK6	
Serial Model	SP3178-CO6,SP3178-SF6,SP3178-WH6, SP3201-BKA, SP3201-BLA, SP3201-STA, SP3202-BKA,SP3202-CCA,SP3202-STA, ps-01,ps-02A,ps-02B,ps-02C,ps-03A,ps-03B ps-04A,ps-04B,ps-04C	
Model Difference	All the same,Only model name is different.	
Product Description	The EUT is a Portable Bluetooth Speaker	
	Operation Frequency:	2402~2480 MHz
	Modulation Type:	BT(1Mbps): GFSK BT EDR(2Mbps): $\pi/4$ -DQPSK BT EDR(3Mbps): 8-DPSK
	Bit Rate of Transmitter	1Mbps/2Mbps/3Mbps
	Number Of Channel	79 CH
	Antenna Designation:	Please see Note 3.
	Output Power(Conducted):	BT(1Mbps): 7.337dBm BT EDR(2Mbps): 6.125dBm BT EDR(3Mbps): 6.562dBm
	Based on the application, features, or specification exhibited in User's Manual, the EUT is considered as an ITE/Computing Device. More details of EUT technical specification, please refer to the User's Manual.	
Channel List	Please refer to the Note 2.	
Adapter	N/A	
Battery	DC 3.7V	
Connecting I/O Port(s)	Please refer to the User's Manual	

Note:

1. For a more detailed features description, please refer to the manufacturer's specifications or the User's Manual.
- 2.

Channel List					
Channel	Frequency (MHz)	Channel	Frequency (MHz)	Channel	Frequency (MHz)
00	2402	27	2429	54	2456
01	2403	28	2430	55	2457
02	2404	29	2431	56	2458
03	2405	30	2432	57	2459
04	2406	31	2433	58	2460
05	2407	32	2434	59	2461
06	2408	33	2435	60	2462
07	2409	34	2436	61	2463
08	2410	35	2437	62	2464
09	2411	36	2438	63	2465
10	2412	37	2439	64	2466
11	2413	38	2440	65	2467
12	2414	39	2441	66	2468
13	2415	40	2442	67	2469
14	2416	41	2443	68	2470
15	2417	42	2444	69	2471
16	2418	43	2445	70	2472
17	2419	44	2446	71	2473
18	2420	45	2447	72	2474
19	2421	46	2448	73	2475
20	2422	47	2449	74	2476
21	2423	48	2450	75	2477
22	2424	49	2451	76	2478
23	2425	50	2452	77	2479
24	2426	51	2453	78	2480
25	2427	52	2454		
26	2428	53	2455		

- 3.

Table for Filed Antenna

Ant	Brand	Model Name	Antenna Type	Connector	Gain (dBi)	NOTE
1	N/A	N/A	PCB Antenna	NA	1.0	BT Antenna

2.2 DESCRIPTION OF TEST MODES

To investigate the maximum EMI emission characteristics generates from EUT, the test system was pre-scanning tested base on the consideration of following EUT operation mode or test configuration mode which possible have effect on EMI emission level. Each of these EUT operation mode(s) or test configuration mode(s) mentioned above was evaluated respectively.

Pretest Mode	Description
Mode 1	CH00
Mode 2	CH39
Mode 3	CH78
Mode 4	BT Link

For Conducted Emission	
Final Test Mode	Description
Mode 4	BT Link

For Radiated Emission	
Final Test Mode	Description
Mode 1	CH00
Mode 2	CH39
Mode 3	CH78

Note:

- (1) The measurements are performed at the highest, middle, lowest available channels.
- (2) The EUT use new battery.
- (3)The data rate was set in 1Mbps for radiated emission due to the highest RF output power.

2.3 TABLE OF PARAMETERS OF TEXT SOFTWARE SETTING

During testing channel & power controlling software provided by the customer was used to control the operating channel as well as the output power level. The RF output power selection is for the setting of RF output power expected by the customer and is going to be fixed on the firmware of the final end product power parameters of FHSS

Test software Version	Test program: Broadcom		
Frequency	2402 MHz	2441 MHz	2480 MHz
Parameters(1Mbps/2Mbps/3Mbps)	DEF	DEF	DEF

2.4 BLOCK DIGRAM SHOWING THE CONFIGURATION OF SYSTEM TESTED

Conducted Emission:

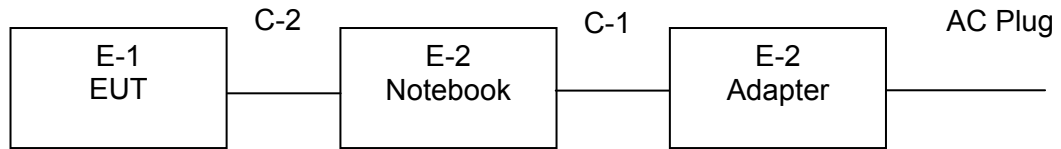

Radiated Emission:

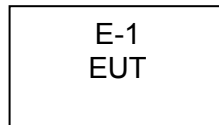

2.5 DESCRIPTION OF SUPPORT UNITS(CONDUCTED MODE)

The EUT has been tested as an independent unit together with other necessary accessories or support units. The following support units or accessories were used to form a representative test configuration during the tests.

Item	Equipment	Mfr/Brand	Model/Type No.	Series No.	Note
E-1	Portable Bluetooth Speaker	E-LIVI	SP3178-BK6	N/A	EUT
E-2	Notebook	IBM	08K8202	N/A	
E-3	Adapter	IBM	2366	N/A	

Item	Shielded Type	Ferrite Core	Length	Note
C-1	NO	NO	80cm	
C-2	NO	NO	40cm	

Note:

- (1) The support equipment was authorized by Declaration of Confirmation.
- (2) For detachable type I/O cable should be specified the length in cm in 『Length』 column.
- (3) “YES” is means “shielded” “with core”; “NO” is means “unshielded” “without core”.

2.6 EQUIPMENTS LIST FOR ALL TEST ITEMS

Radiation Test equipment

Item	Kind of Equipment	Manufacturer	Type No.	Serial No.	Last calibration	Calibrated until	Calibration period
1	Spectrum Analyzer	Agilent	E4407B	MY45108040	2016.07.06	2017.07.05	1 year
2	Test Receiver	R&S	ESPI	101318	2016.06.07	2017.06.06	1 year
3	Bilog Antenna	TESEQ	CBL6111D	31216	2016.07.06	2017.07.05	1 year
4	50Ω Coaxial Switch	Anritsu	MP59B	6200264416	2016.06.07	2017.06.06	1 year
5	Spectrum Analyzer	ADVANTEST	R3132	150900201	2016.06.07	2017.06.06	1 year
6	Horn Antenna	EM	EM-AH-10180	2011071402	2016.07.06	2017.07.05	1 year
7	Horn Ant	Schwarzbeck	BBHA 9170	9170-181	2016.07.06	2017.07.05	1 year
8	Amplifier	EM	EM-30180	060538	2015.12.22	2016.12.21	1 year
9	Loop Antenna	ARA	PLA-1030/B	1029	2016.06.08	2017.06.07	1 year
10	Power Meter	R&S	NRVS	100696	2016.07.06	2017.07.05	1 year
11	Power Sensor	R&S	URV5-Z4	0395.1619.05	2016.07.06	2017.07.05	1 year
12	Signal Analyzer	Agilent	N9020A	MY49100060	2016.07.06	2017.07.05	1 year

Conduction Test equipment

Item	Kind of Equipment	Manufacturer	Type No.	Serial No.	Last calibration	Calibrated until	Calibration period
1	Test Receiver	R&S	ESCI	101160	2016.06.06	2017.06.05	1 year
2	LISN	R&S	ENV216	101313	2016.08.24	2017.08.23	1 year
3	LISN	EMCO	3816/2	00042990	2016.08.24	2017.08.23	1 year
4	50Ω Coaxial Switch	Anritsu	MP59B	6200264417	2016.06.07	2017.06.06	1 year
5	Passive Voltage Probe	R&S	ESH2-Z3	100196	2016.06.07	2017.06.06	1 year
6	Absorbing clamp	R&S	MOS-21	100423	2016.06.08	2017.06.07	1 year

3. EMC EMISSION TEST

3.1 CONDUCTED EMISSION MEASUREMENT

3.1.1 POWER LINE CONDUCTED EMISSION Limits (Frequency Range 150KHz-30MHz)

FREQUENCY (MHz)	Class A (dBuV)		Class B (dBuV)		Standard
	Quasi-peak	Average	Quasi-peak	Average	
0.15 -0.5	79.00	66.00	66 - 56 *	56 - 46 *	CISPR
0.50 -5.0	73.00	60.00	56.00	46.00	CISPR
5.0 -30.0	73.00	60.00	60.00	50.00	CISPR

0.15 -0.5	79.00	66.00	66 - 56 *	56 - 46 *	FCC
0.50 -5.0	73.00	60.00	56.00	46.00	FCC
5.0 -30.0	73.00	60.00	60.00	50.00	FCC

Note:

- (1) The tighter limit applies at the band edges.
- (2) The limit of " * " marked band means the limitation decreases linearly with the logarithm of the frequency in the range.

The following table is the setting of the receiver

Receiver Parameters	Setting
Attenuation	10 dB
Start Frequency	0.15 MHz
Stop Frequency	30 MHz
IF Bandwidth	9 kHz

3.1.2 TEST PROCEDURE

- a. The EUT was placed 0.4 meters from the horizontal ground plane with EUT being connected to the power mains through a line impedance stabilization network (LISN). All other support equipments powered from additional LISN(s). The LISN provide 50 Ohm/ 50uH of coupling impedance for the measuring instrument.
- b. Interconnecting cables that hang closer than 40 cm to the ground plane shall be folded back and forth in the center forming a bundle 30 to 40 cm long.
- c. I/O cables that are not connected to a peripheral shall be bundled in the center. The end of the cable may be terminated, if required, using the correct terminating impedance. The overall length shall not exceed 1 m.
- d. LISN at least 80 cm from nearest part of EUT chassis.
- e. For the actual test configuration, please refer to the related Item –EUT Test Photos.

3.1.3 DEVIATION FROM TEST STANDARD

No deviation

3.1.4 TEST SETUP

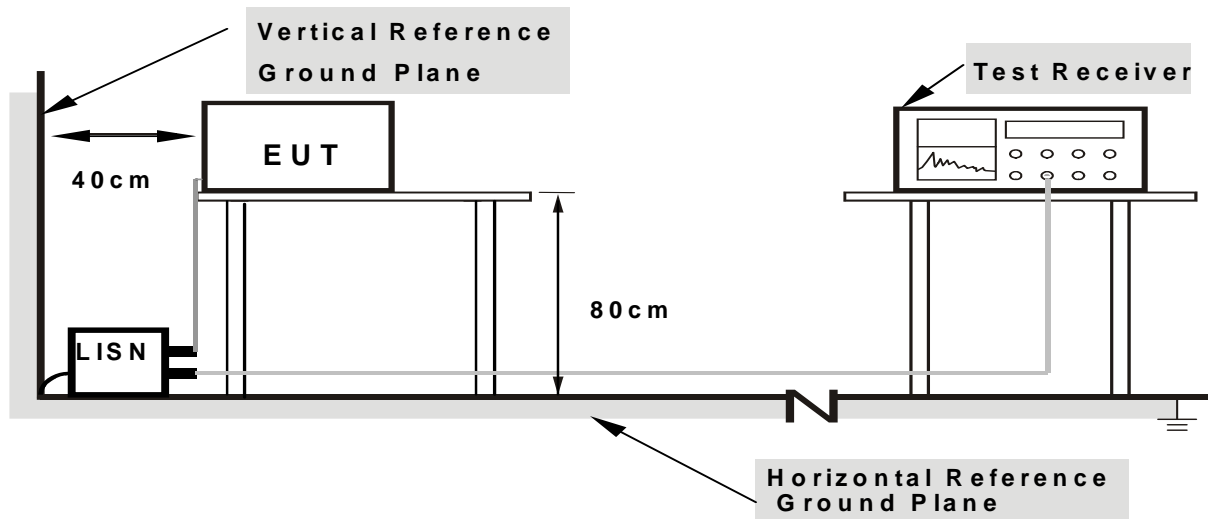

- Note:**
- 1. Support units were connected to second LISN.
 - 2. Both of LISNs (AMN) are 80 cm from EUT and at least 80 from other units and other metal planes

3.1.5 EUT OPERATING CONDITIONS

The EUT was configured for testing in a typical fashion (as a customer would normally use it). The EUT has been programmed to continuously transmit during test. This operating condition was tested and used to collect the included data.

3.1.6 TEST RESULTS

EUT :	Portable Bluetooth Speaker	Model Name :	SP3178-BK6
Temperature :	26 °C	Relative Humidity :	54%
Pressure :	1010hPa	Phase :	L
Test Voltage :	AC 120V/60Hz	Test Mode :	Mode 4

Frequency (MHz)	Reading Level (dBμV)	Correct Factor (dB)	Measure-ment (dBμV)	Limits (dBμV)	Margin (dB)	Detector Type
0.1900	36.87	10.00	46.87	64.03	-17.16	QP
0.1900	31.16	10.00	41.16	54.03	-12.87	AVG
0.5060	34.63	10.02	44.65	56.00	-11.35	QP
0.5060	28.61	10.02	38.63	46.00	-7.37	AVG
1.1140	30.67	10.06	40.73	56.00	-15.27	QP
1.1140	19.17	10.06	29.23	46.00	-16.77	AVG
2.4380	28.88	10.05	38.93	56.00	-17.07	QP
2.4380	20.14	10.05	30.19	46.00	-15.81	AVG
14.4820	34.15	10.25	44.40	60.00	-15.60	QP
14.4820	16.25	10.25	26.50	50.00	-23.50	AVG

Remark:

1. All readings are Quasi-Peak and Average values.
2. Factor = Insertion Loss + Cable Loss.

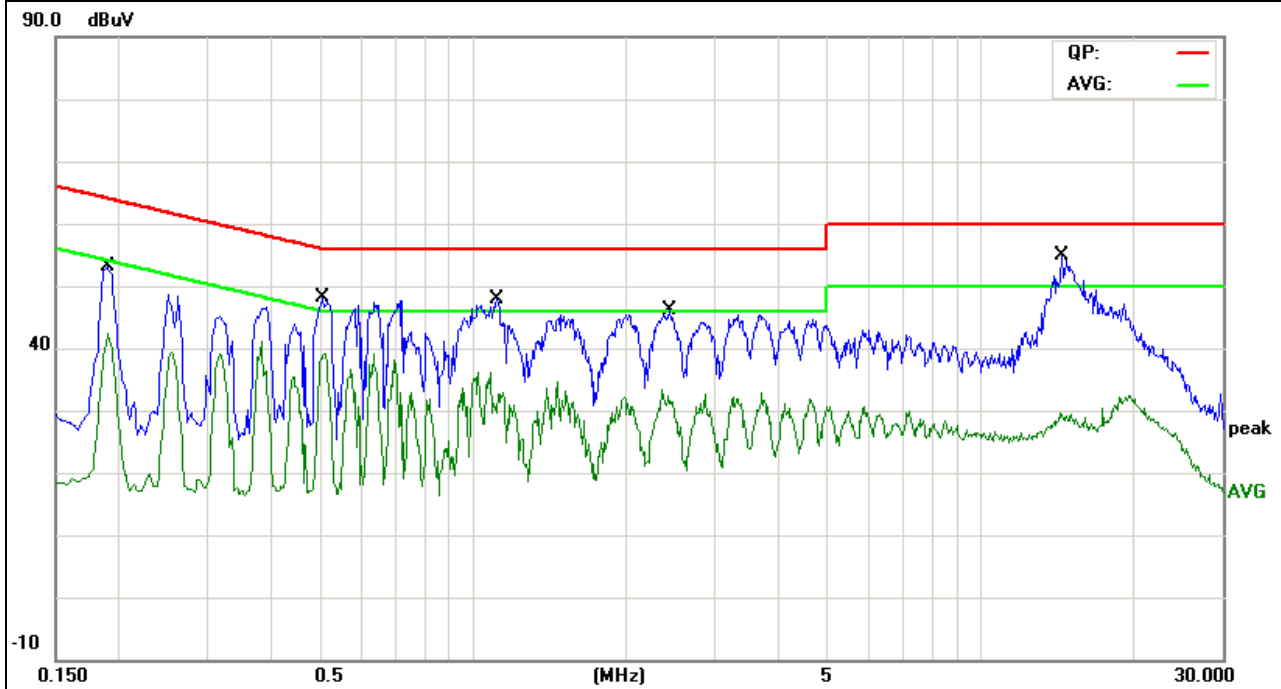

EUT :	Portable Bluetooth Speaker	Model Name :	SP3178-BK6
Temperature :	26 °C	Relative Humidity :	54%
Pressure :	1010hPa	Phase :	N
Test Voltage :	AC 120V/60Hz	Test Mode :	Mode 4

Frequency (MHz)	Reading Level (dBμV)	Correct Factor (dB)	Measure-ment (dBμV)	Limits (dBμV)	Margin (dB)	Detector Type
0.5020	33.19	10.02	43.21	56.00	-12.79	QP
0.5020	24.57	10.02	34.59	46.00	-11.41	AVG
1.0100	30.88	10.06	40.94	56.00	-15.06	QP
1.0100	20.01	10.06	30.07	46.00	-15.93	AVG
2.3900	27.30	10.05	37.35	56.00	-18.65	QP
2.3900	16.10	10.05	26.15	46.00	-19.85	AVG
2.4539	27.03	10.04	37.07	56.00	-18.93	QP
2.4539	15.21	10.04	25.25	46.00	-20.75	AVG
4.6140	28.47	9.97	38.44	56.00	-17.56	QP
4.6140	16.89	9.97	26.86	46.00	-19.14	AVG

Remark:

1. All readings are Quasi-Peak and Average values.
2. Factor = Insertion Loss + Cable Loss.

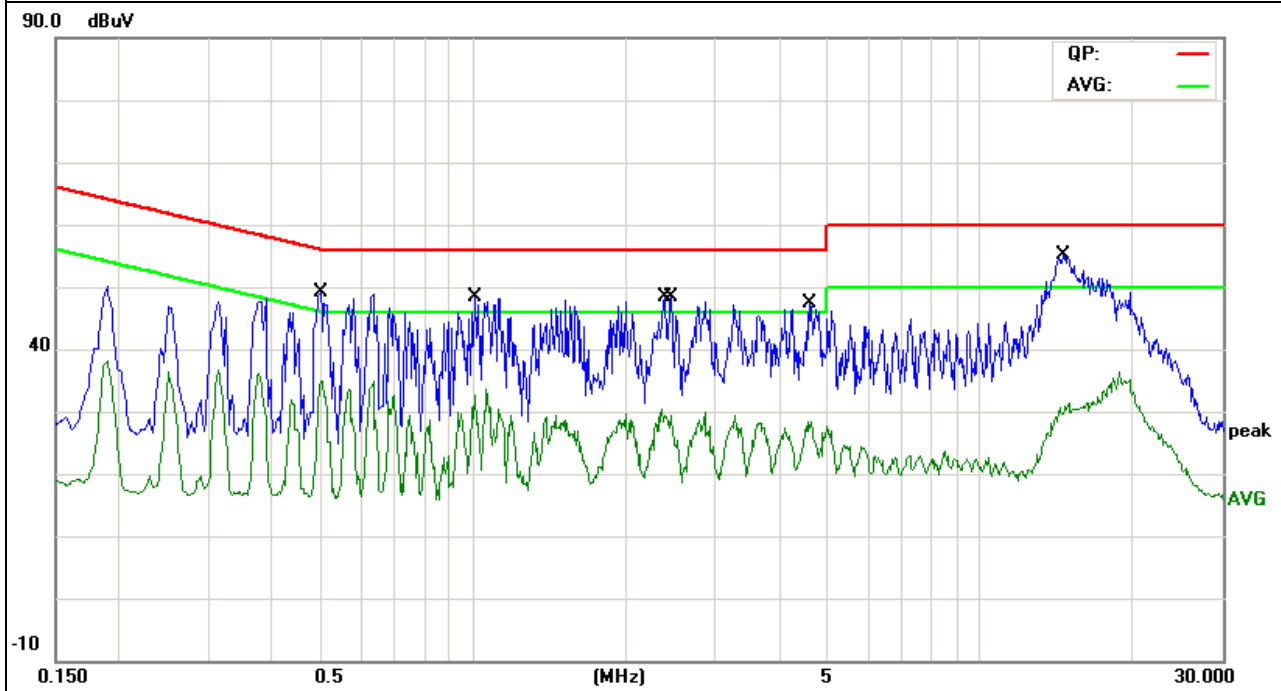

3.2 RADIATED EMISSION MEASUREMENT

3.2.1 RADIATED EMISSION LIMITS (FREQUENCY RANGE 9KHZ-1000MHZ)

20dBc in any 100 kHz bandwidth outside the operating frequency band. In case the emission fall within the restricted band specified on 15.205(a), then the 15.209(a) limit in the table below has to be followed. (unintentional radiator)

Frequencies (MHz)	Field Strength (micovolts/meter)	Measurement Distance (meters)
0.009~0.490	2400/F(KHz)	300
0.490~1.705	24000/F(KHz)	30
1.705~30.0	30	30
30~88	100	3
88~216	150	3
216~960	200	3
Above 960	500	3

The following table is the setting of the receiver

Spectrum Parameter	Setting
Attenuation	Auto
Start Frequency	1000 MHz
Stop Frequency	10th carrier harmonic
RB / VB (emission in restricted band)	1 MHz / 1 MHz for Peak, 1 MHz / 10Hz for Average

Receiver Parameter	Setting
Attenuation	Auto
Start ~ Stop Frequency	9kHz~150kHz / RB 200Hz for QP
Start ~ Stop Frequency	150kHz~30MHz / RB 9kHz for QP
Start ~ Stop Frequency	30MHz~1000MHz / RB 120kHz for QP

3.2.2 TEST PROCEDURE

- The measuring distance of at 3 m shall be used for measurements at frequency up to 1GHz. For frequencies above 1GHz, any suitable measuring distance may be used.
- The EUT was placed on the top of a rotating table 0.8 meters above the ground at a 3 meter open area test site. The table was rotated 360 degrees to determine the position of the highest radiation.
- The height of the equipment or of the substitution antenna shall be 0.8 m; the height of the test antenna shall vary between 1 m to 4 m. Both horizontal and vertical polarizations of the antenna are set to make the measurement.
- The initial step in collecting conducted emission data is a spectrum analyzer peak detector mode pre-scanning the measurement frequency range. Significant peaks are then marked and then Quasi Peak detector mode re-measured.
- If the Peak Mode measured value compliance with and lower than Quasi Peak Mode Limit, the EUT shall be deemed to meet QP Limits and then no additional QP Mode measurement performed.
- For the actual test configuration, please refer to the related Item –EUT Test Photos.

Note:

Both horizontal and vertical antenna polarities were tested and performed pretest to three orthogonal axis. The worst case emissions were reported

3.2.3 DEVIATION FROM TEST STANDARD

No deviation

3.2.4 TEST SETUP

(A) Radiated Emission Test-Up Frequency Below 30MHz

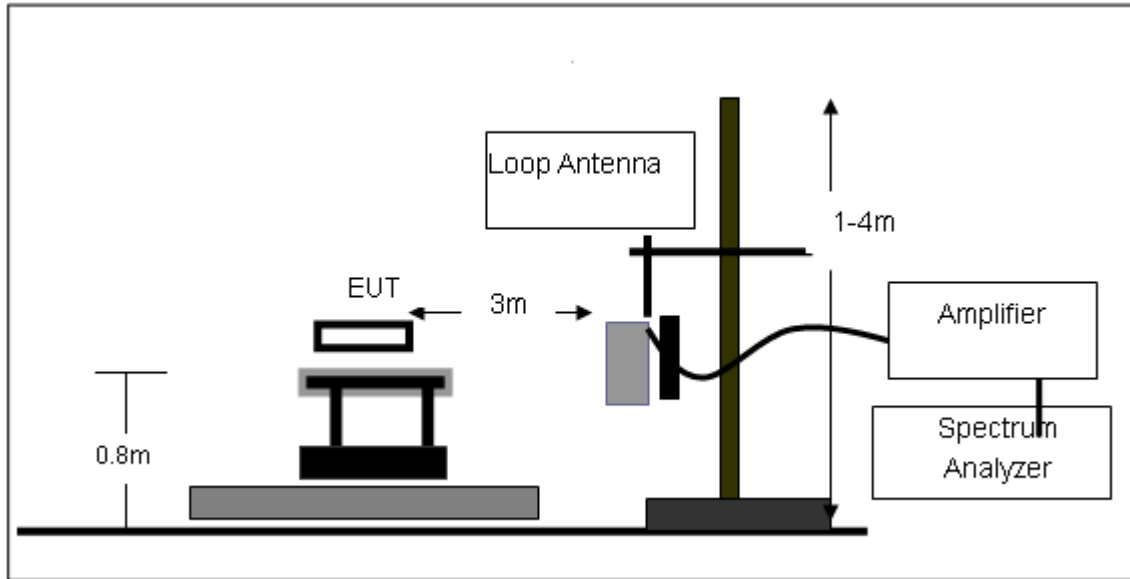

(B) Radiated Emission Test-Up Frequency 30MHz~1GHz

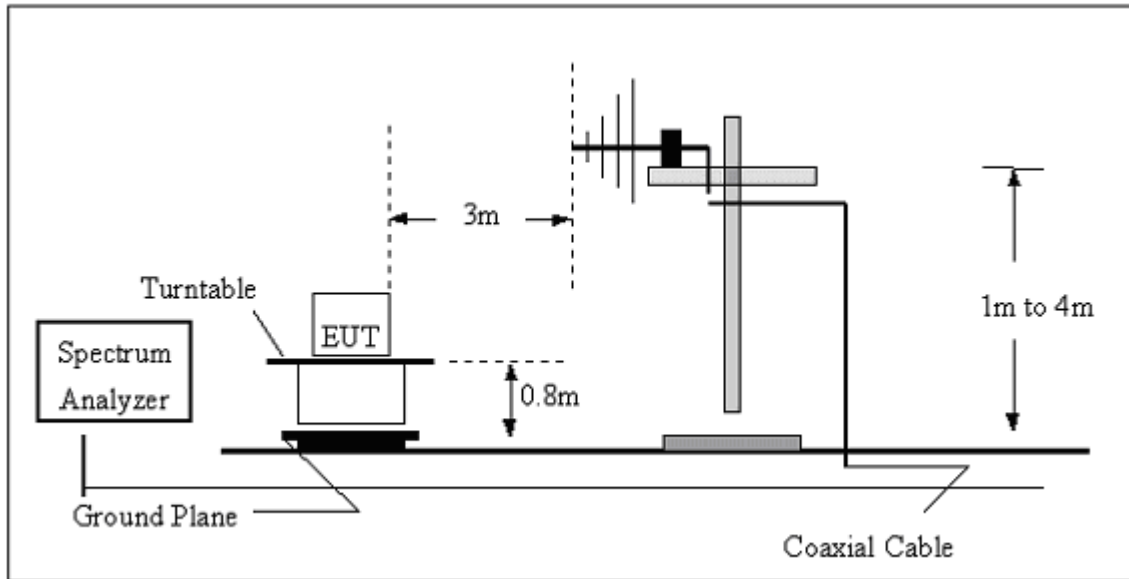

(C) Radiated Emission Test-Up Frequency Above 1GHz

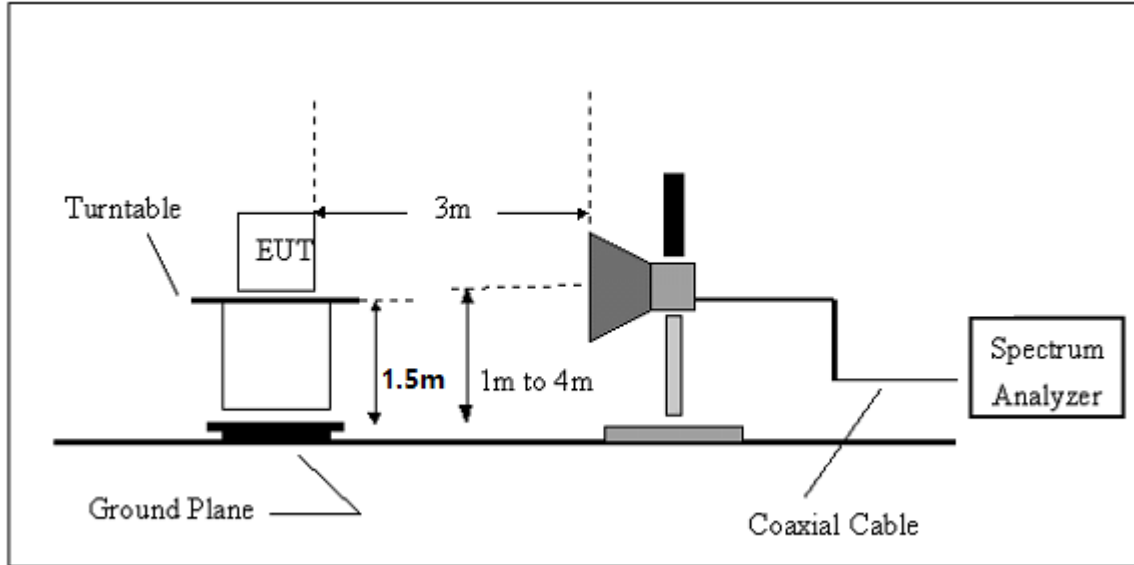

3.2.5 EUT OPERATING CONDITIONS

The EUT tested system was configured as the statements of 2.4 Unless otherwise a special operating condition is specified in the follows during the testing.

3.2.6 TEST RESULTS (BELOW 30 MHZ)

EUT :	Portable Bluetooth Speaker	Model Name :	SP3178-BK6
Temperature :	20 °C	Relative Humidity :	48%
Pressure :	1010 hPa	Polarization :	---
Test Voltage :	DC 3.7V by battery		
Test Mode :	TX		

Freq. (MHz)	Reading (dBuV/m)	Limit (dBuV/m)	Margin (dB)	State P/F
--	--	--	--	PASS
--	--	--	--	PASS

NOTE:

The amplitude of spurious emissions which are attenuated by more than 20dB below the permissible value has no need to be reported.

Distance extrapolation factor = $40 \log (\text{specific distance}/\text{test distance})$ (dB);

Limit line = specific limits(dBuV) + distance extrapolation factor.

3.2.7 TEST RESULTS (30MHZ-1GHZ)

EUT :	Portable Bluetooth Speaker	Model Name :	SP3178-BK6
Temperature :	20 °C	Relative Humidity :	48%
Pressure :	1010 hPa	Polarization :	Horizontal
Test Voltage :	DC 3.7V by battery		
Test Mode :	TX		

Frequency (MHz)	Meter Reading (dBμV)	Factor (dB)	Emission Level (dBμV/m)	Limits (dBμV/m)	Margin (dB)	Detector Type
199.2855	26.88	8.71	35.59	43.5	-7.91	QP
331.3546	24.23	14.97	39.2	46	-6.8	QP
394.8543	23.77	17.03	40.8	46	-5.2	QP
531.9633	18.85	19.76	38.61	46	-7.39	QP
793.3958	16.51	23.91	40.42	46	-5.58	QP

Remark:
 Factor = Antenna Factor + Cable Loss – Pre-amplifier.
 Factor added by measurement software automatically.

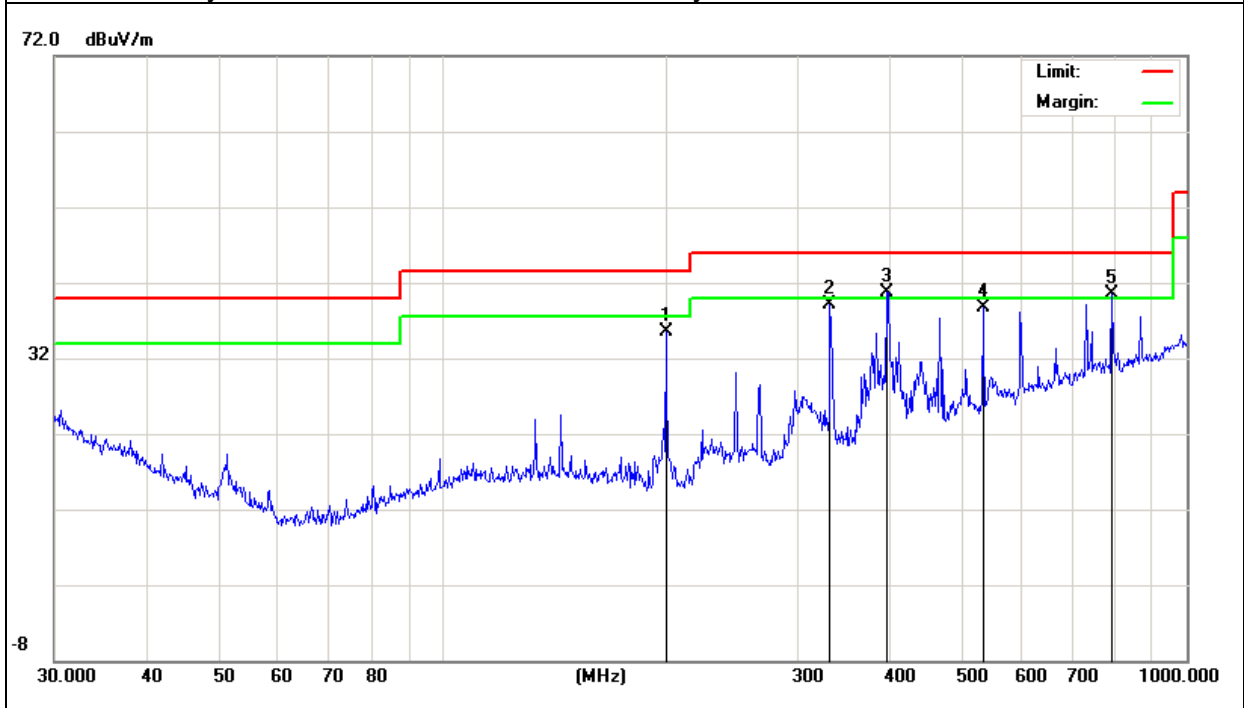

EUT :	Portable Bluetooth Speaker	Model Name :	SP3178-BK6
Temperature :	20 °C	Relative Humidity :	48%
Pressure :	1010 hPa	Polarization :	Vertical
Test Voltage :	DC 3.7V by battery		
Test Mode :	TX		

Frequency (MHz)	Meter Reading (dBμV)	Factor (dB)	Emission Level (dBμV/m)	Limits (dBμV/m)	Margin (dB)	Detector Type
199.2855	30.12	8.71	38.83	43.5	-4.67	QP
392.0951	25.41	16.93	42.34	46	-3.66	QP
531.9633	20.35	19.76	40.11	46	-5.89	QP
590.9737	14.71	20.79	35.5	46	-10.5	QP

Remark:
 Factor = Antenna Factor + Cable Loss – Pre-amplifier.
 Factor added by measurement software automatically.

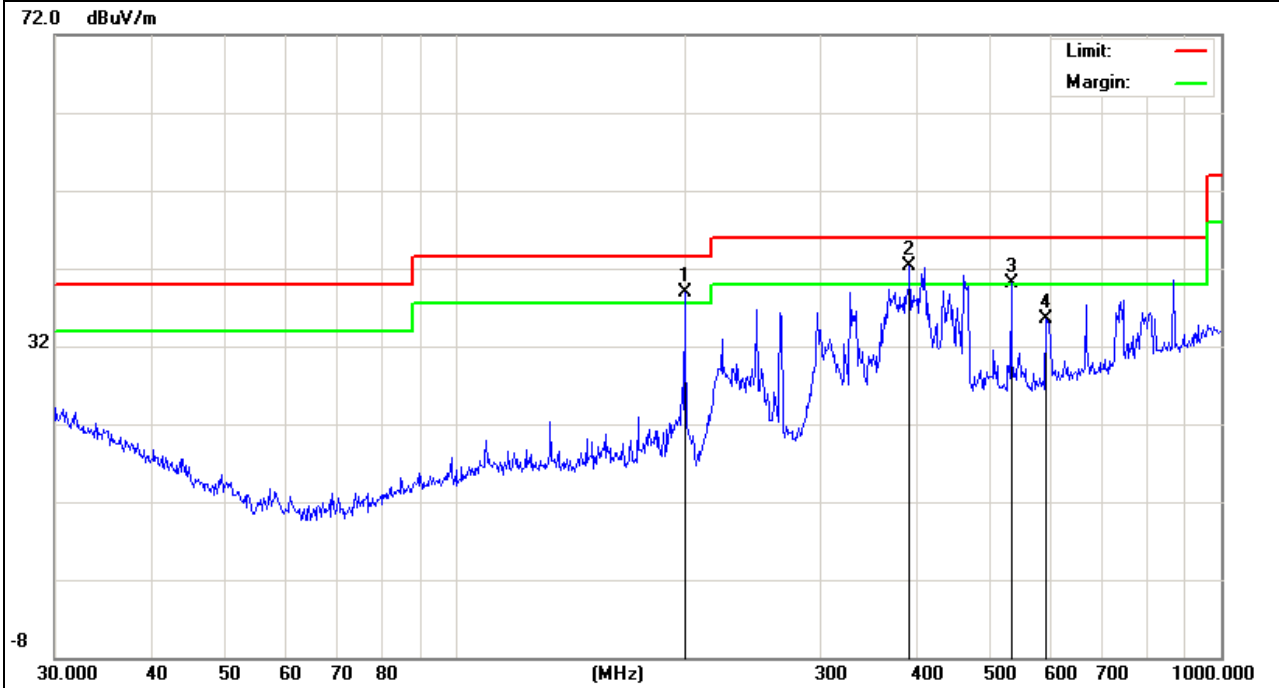

3.2.8 TEST RESULTS (1G-25GHZ)

Frequency (MHz)	Meter Reading (dBμV)	Factor (dB)	Emission Level (dBμV/m)	Limits (dBμV/m)	Margin (dB)	Detector Type	Comment
Low Channel (2402 MHz)							
4804.20	67.34	-3.62	63.72	74	-10.28	PK	Vertical
4804.22	47.30	-3.62	43.68	54	-10.32	AV	Vertical
7206.13	62.88	-0.9	61.98	74	-12.02	PK	Vertical
7206.12	42.23	-0.9	41.33	54	-12.67	AV	Vertical
4804.00	62.76	-3.65	59.11	74	-14.89	PK	Horizontal
4803.99	45.39	-3.65	41.74	54	-12.26	AV	Horizontal
Mid Channel (2441 MHz)							
4882.09	65.57	-3.65	61.92	74	-12.08	PK	Vertical
4882.07	50.22	-3.65	46.57	54	-7.43	AV	Vertical
7323.21	61.47	-0.84	60.63	74	-13.37	PK	Vertical
7323.21	45.09	-0.84	44.25	54	-9.75	AV	Vertical
4882.18	62.14	-3.68	58.46	74	-15.54	PK	Horizontal
4882.14	45.75	-3.68	42.07	54	-11.93	AV	Horizontal
High Channel (2480 MHz)							
4960.25	61.80	-3.59	58.21	74	-15.79	PK	Vertical
4960.30	46.37	-3.59	42.78	54	-11.22	AV	Vertical
7440.33	61.79	-0.83	60.96	74	-13.04	PK	Vertical
7440.30	46.18	-0.83	45.35	54	-8.65	AV	Vertical
4960.32	61.77	-3.59	58.18	74	-15.82	PK	Horizontal
4960.31	46.14	-3.59	42.55	54	-11.45	AV	Horizontal

Note: 1) Scan with GFSK, π/4-DQPSK,8DPSK, the worst case is GFSK Mode

2) Factor = Antenna Factor + Cable Loss – Pre-amplifier.

Emission Level = Meter Reading + Factor

Margin = Limit - Emission Level

Unhopping-Band edge:

Frequency (MHz)	Meter Reading (dBμV)	Factor (dB)	Emission Level (dBμV/m)	Limits (dBμV/m)	Margin (dB)	Detector Type	Comment
GFSK							
2390.0	69.55	-12.99	56.56	74	-17.44	PK	Vertical
2390.0	55.21	-12.99	42.22	54	-11.78	AV	Vertical
2390.0	70.26	-12.99	57.27	74	-16.73	PK	Horizontal
2390.0	54.16	-12.99	41.17	54	-12.83	AV	Horizontal
2483.6	71.15	-12.78	58.37	74	-15.63	PK	Vertical
2483.6	54.17	-12.78	41.39	54	-12.61	AV	Vertical
2483.6	71.40	-12.78	58.62	74	-15.38	PK	Horizontal
2483.6	54.33	-12.78	41.55	54	-12.45	AV	Horizontal

π/4-DQPSK

2390.0	71.52	-12.99	58.53	74	-15.47	PK	Vertical
2390.0	54.48	-12.99	41.49	54	-12.51	AV	Vertical
2390.0	70.17	-12.99	57.18	74	-16.82	PK	Horizontal
2390.0	55.08	-12.99	42.09	54	-11.91	AV	Horizontal
2483.6	71.48	-12.78	58.70	74	-15.30	PK	Vertical
2483.6	56.23	-12.78	43.45	54	-10.55	AV	Vertical
2483.6	71.24	-12.78	58.46	74	-15.54	PK	Horizontal
2483.6	54.57	-12.78	41.79	54	-12.21	AV	Horizontal

8DPSK

2390.0	71.52	-12.99	58.53	74	-15.47	PK	Vertical
2390.0	54.48	-12.99	41.49	54	-12.51	AV	Vertical
2390.0	70.17	-12.99	57.18	74	-16.82	PK	Horizontal
2390.0	55.08	-12.99	42.09	54	-11.91	AV	Horizontal
2483.6	71.48	-12.78	58.70	74	-15.30	PK	Vertical
2483.6	56.23	-12.78	43.45	54	-10.55	AV	Vertical
2483.6	71.24	-12.78	58.46	74	-15.54	PK	Horizontal
2483.6	54.57	-12.78	41.79	54	-12.21	AV	Horizontal

Low measurement frequencies is range from 2310 to 2400 MHz, high measurement frequencies is range from 2483.5 to 2500 MHz. Only show the worst point data of the emissions in the frequency 2310-2400 MHz and 2483.5-2500 MHz.

Hopping-Band edge:

Frequency (MHz)	Meter Reading (dBμV)	Factor (dB)	Emission Level (dBμV/m)	Limits (dBμV/m)	Margin (dB)	Detector Type	Comment
GFSK							
2390.0	69.15	-12.99	56.16	74	-17.84	PK	Vertical
2390.0	55.19	-12.99	42.20	54	-11.80	AV	Vertical
2390.0	68.46	-12.99	55.47	74	-18.53	PK	Horizontal
2390.0	54.14	-12.99	41.15	54	-12.85	AV	Horizontal
2483.6	67.18	-12.78	54.40	74	-19.60	PK	Vertical
2483.6	55.23	-12.78	42.45	54	-11.55	AV	Vertical
2483.6	68.14	-12.78	55.36	74	-18.64	PK	Horizontal
2483.6	55.11	-12.78	42.33	54	-11.67	AV	Horizontal

π/4-DQPSK

2390.0	69.10	-12.99	56.11	74	-17.89	PK	Vertical
2390.0	56.24	-12.99	43.25	54	-10.75	AV	Vertical
2390.0	68.06	-12.99	55.07	74	-18.93	PK	Horizontal
2390.0	54.07	-12.99	41.08	54	-12.92	AV	Horizontal
2483.6	68.09	-12.78	55.31	74	-18.69	PK	Vertical
2483.6	54.22	-12.78	41.44	54	-12.56	AV	Vertical
2483.6	69.15	-12.78	56.37	74	-17.63	PK	Horizontal
2483.6	55.23	-12.78	42.45	54	-11.55	AV	Horizontal

8DPSK

2390.0	69.11	-12.99	56.12	74	-17.88	PK	Vertical
2390.0	55.11	-12.99	42.12	54	-11.88	AV	Vertical
2390.0	68.07	-12.99	55.08	74	-18.92	PK	Horizontal
2390.0	55.22	-12.99	42.23	54	-11.77	AV	Horizontal
2483.6	69.16	-12.78	56.38	74	-17.62	PK	Vertical
2483.6	55.24	-12.78	42.46	54	-11.54	AV	Vertical
2483.6	68.08	-12.78	55.30	74	-18.70	PK	Horizontal
2483.6	55.14	-12.78	42.36	54	-11.64	AV	Horizontal

Low measurement frequencies is range from 2310 to 2400 MHz, high measurement frequencies is range from 2483.5 to 2500 MHz. Only show the worst point data of the emissions in the frequency 2310-2400 MHz and 2483.5-2500 MHz.

4. NUMBER OF HOPPING CHANNEL

4.1 APPLIED PROCEDURES / LIMIT

FCC Part15 (15.247) , Subpart C				
Section	Test Item	Limit	Frequency Range (MHz)	Result
15.247 (a)(1)(iii)	Number of Hopping Channel	≥15	2400-2483.5	PASS

Spectrum Parameters	Setting
Attenuation	Auto
Span Frequency	= the frequency band of operation
RB	RBW ≥ 1% of the span
VB	VBW ≥ RBW
Detector	Peak
Trace	Max Hold
Sweep Time	Auto

4.1.1 TEST PROCEDURE

- a. The EUT was directly connected to the spectrum analyzer and antenna output port as show in the block diagram below,
- b. Spectrum Setting : RBW= 1MHz, VBW=1MHz, Sweep time = Auto.

4.1.2 DEVIATION FROM STANDARD

No deviation.

4.1.3 TEST SETUP



4.1.4 EUT OPERATION CONDITIONS

The EUT tested system was configured as the statements of 2.4 Unless otherwise a special operating condition is specified in the follows during the testing.

4.1.5 TEST RESULTS

EUT :	Portable Bluetooth Speaker	Model Name :	SP3178-BK6
Temperature :	25 °C	Relative Humidity :	60%
Pressure :	1015 hPa	Test Voltage :	DC 3.7V
Test Mode :	Hopping Mode		

Number of Hopping Channel	79
---------------------------	----

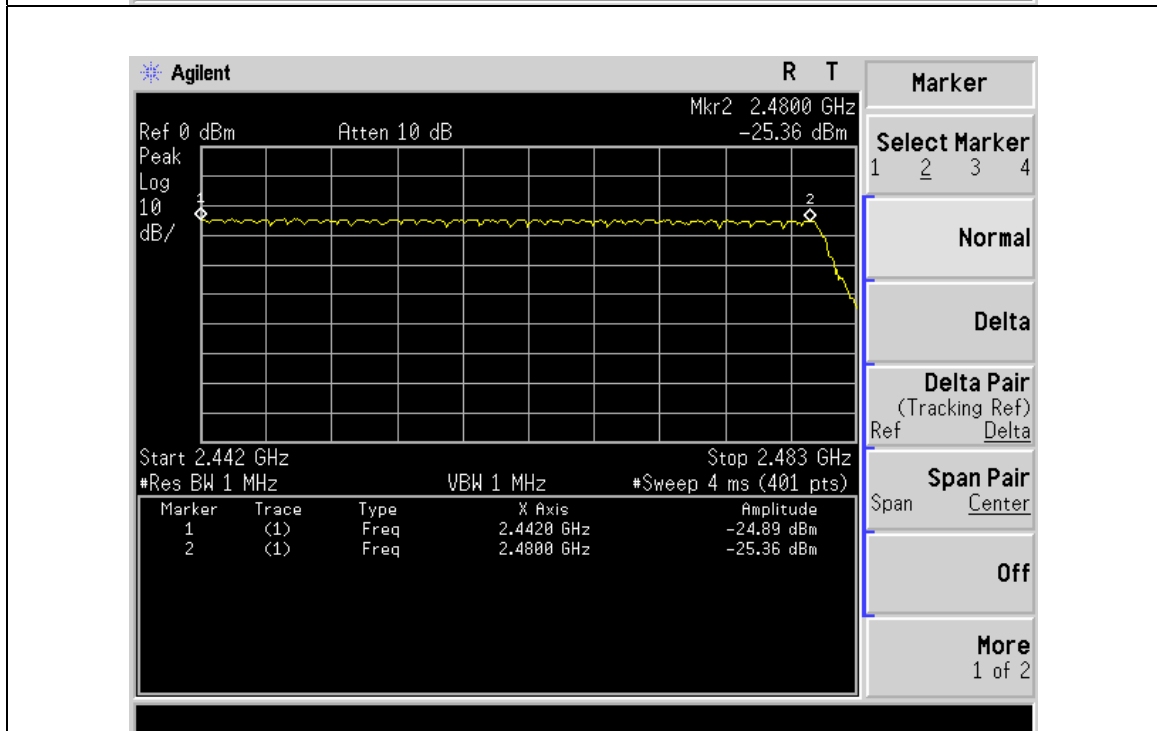
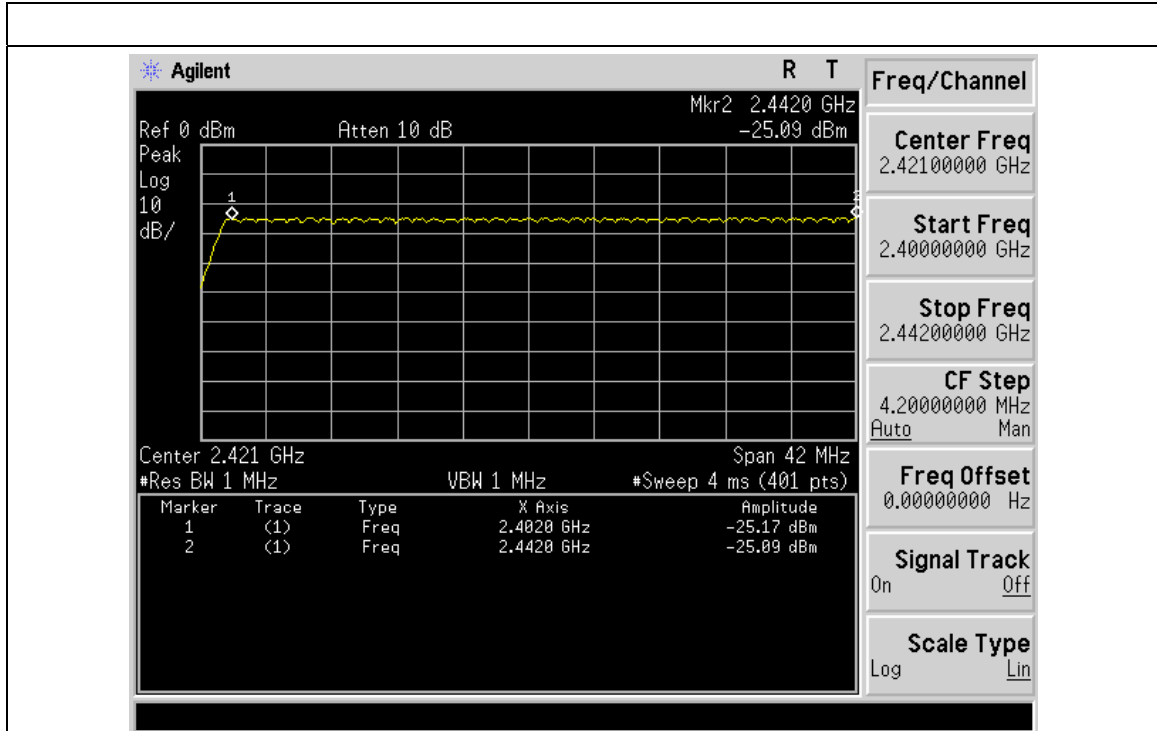

5. AVERAGE TIME OF OCCUPANCY

5.1 APPLIED PROCEDURES / LIMIT

FCC Part15 (15.247) , Subpart C				
Section	Test Item	Limit	Frequency Range (MHz)	Result
15.247 (a)(1)(iii)	Average Time of Occupancy	0.4sec	2400-2483.5	PASS

5.1.1 TEST PROCEDURE

- a. The transmitter output (antenna port) was connected to the spectrum analyzer
- b. Set RBW of spectrum analyzer to 1MHz and VBW to 1MHz.
- c. Use a video trigger with the trigger level set to enable triggering only on full pulses.
- d. Sweep Time is more than once pulse time.
- e. Set the center frequency on any frequency would be measure and set the frequency span to zero span.
- f. Measure the maximum time duration of one single pulse.
- g. Set the EUT for DH5, DH3 and DH1 packet transmitting.
- h. Measure the maximum time duration of one single pulse.
- i. A Period Time = (channel number)*0.4
 DH1 Time Slot: Reading * (1600/2)*31.6/(channel number)
 DH3 Time Slot: Reading * (1600/4)*31.6/(channel number)
 DH5 Time Slot: Reading * (1600/6)*31.6/(channel number)

5.1.2 DEVIATION FROM STANDARD

No deviation.

5.1.3 TEST SETUP



5.1.4 EUT OPERATION CONDITIONS

The EUT tested system was configured as the statements of 2.4 Unless otherwise a special operating condition is specified in the follows during the testing.

5.1.5 TEST RESULTS

EUT :	Portable Bluetooth Speaker	Model Name :	SP3178-BK6
Temperature :	25 °C	Relative Humidity :	60%
Pressure :	1012 hPa	Test Voltage :	DC 3.7V
Test Mode :	CH39-DH5 ,2DH5,3DH5		

Data Packet	Frequency	Pulse Duration (ms)	Dwell Time (s)	Limits (s)
DH5	2441 MHz	3.00	0.32	0.4
2DH5	2441 MHz	3.05	0.33	0.4
3DH5	2441 MHz	3.00	0.32	0.4

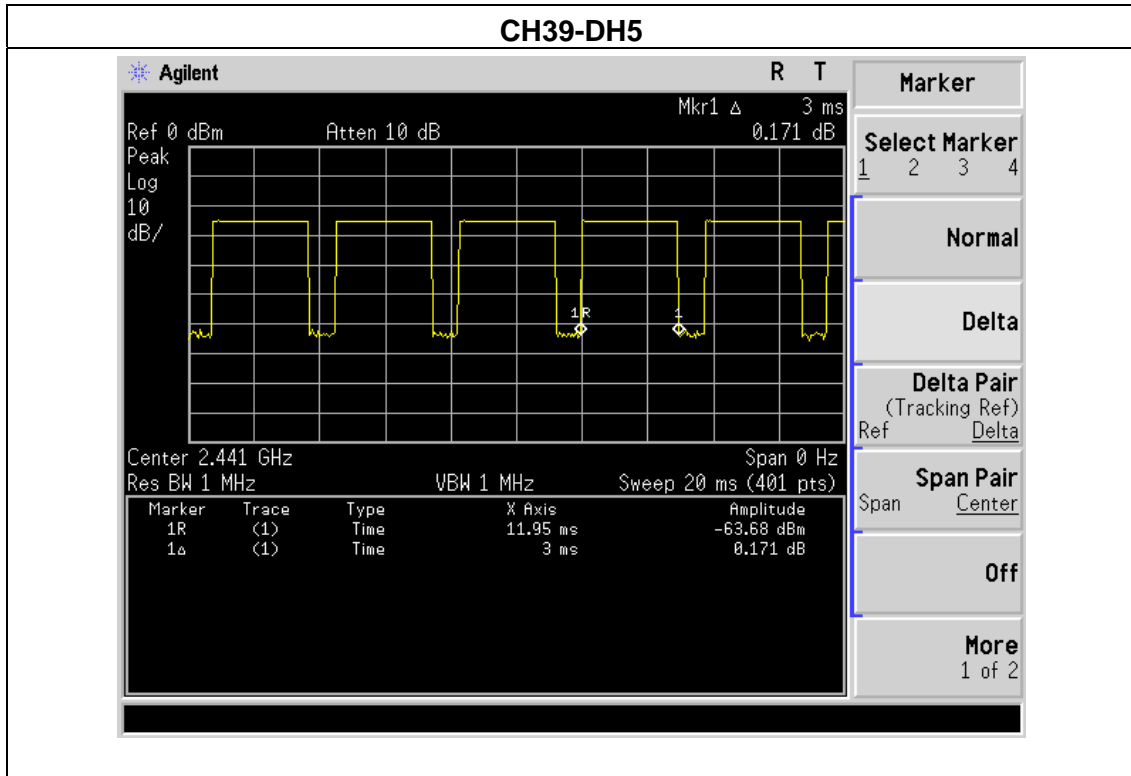

CH39-2DH5

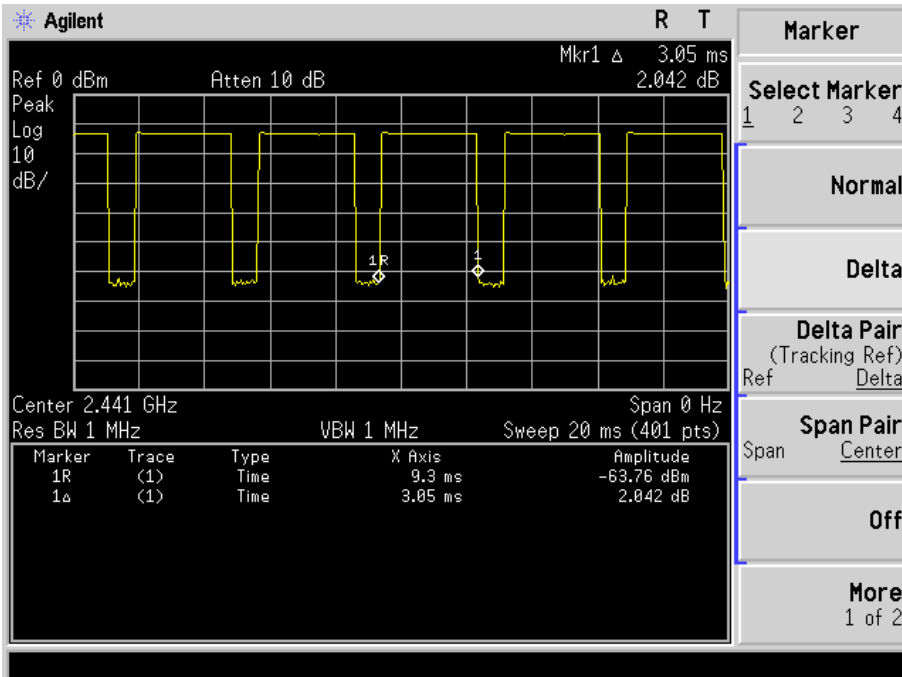

CH39-3DH5

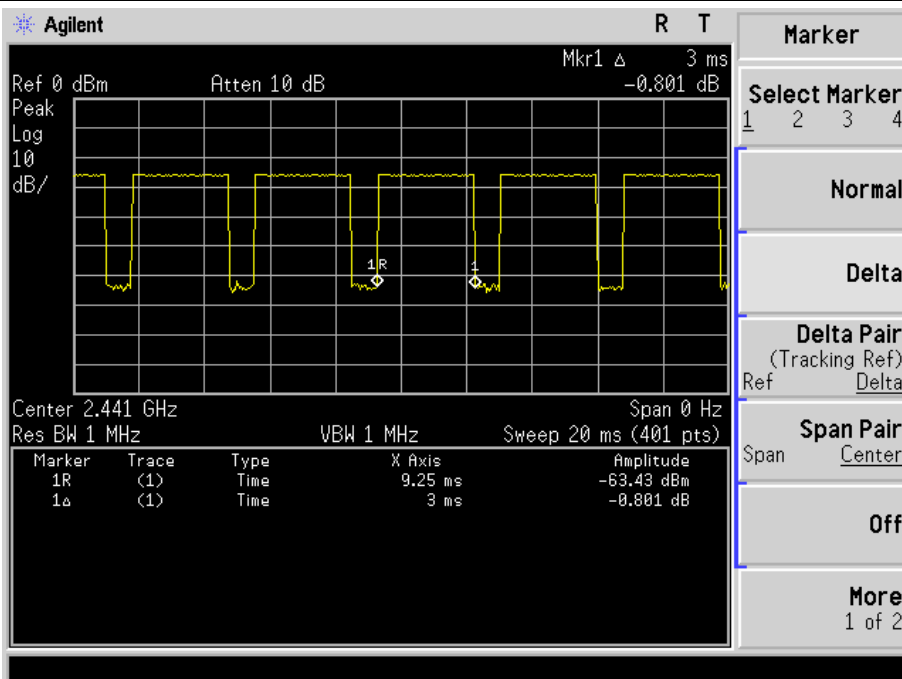

EUT :	Portable Bluetooth Speaker	Model Name :	SP3178-BK6
Temperature :	25 °C	Relative Humidity :	60%
Pressure :	1012 hPa	Test Voltage :	DC 3.7V
Test Mode :	CH39-DH3,2DH3,3DH3		

Data Packet	Frequency	Pulse Duration (ms)	Dwell Time (s)	Limits (s)
DH3	2441 MHz	1.75	0.28	0.4
2DH3	2441 MHz	1.75	0.28	0.4
3DH3	2441 MHz	1.80	0.29	0.4

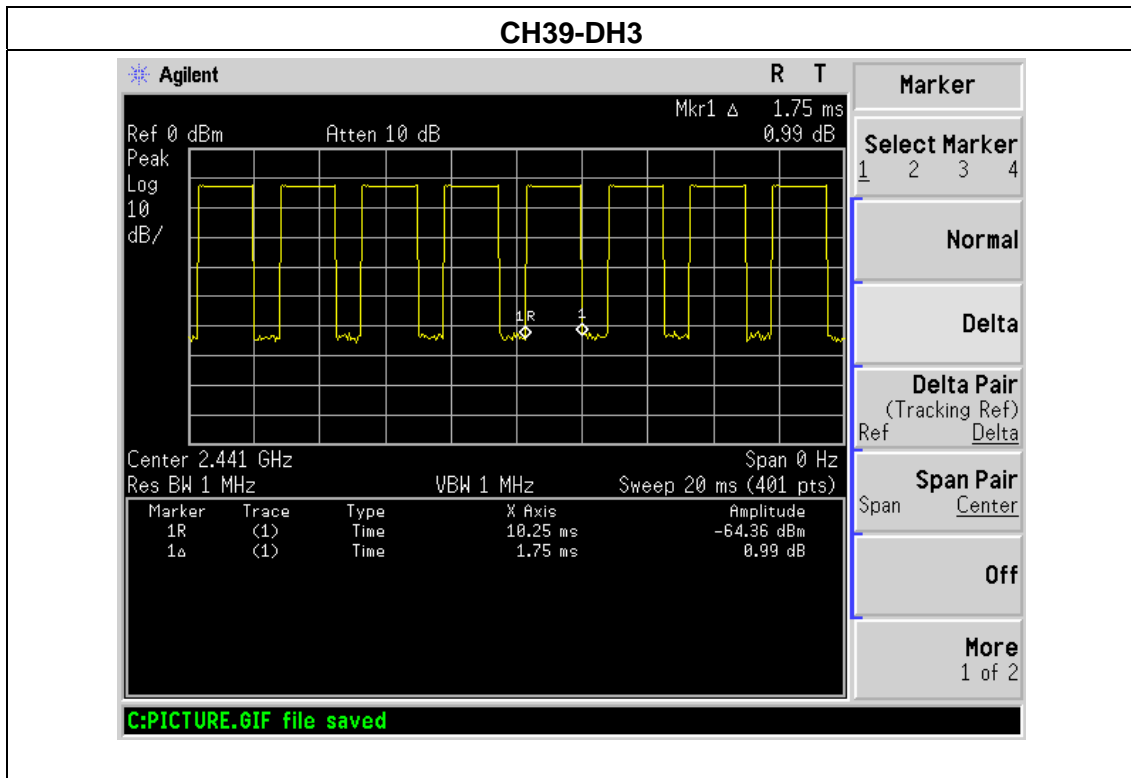

CH39-2DH3

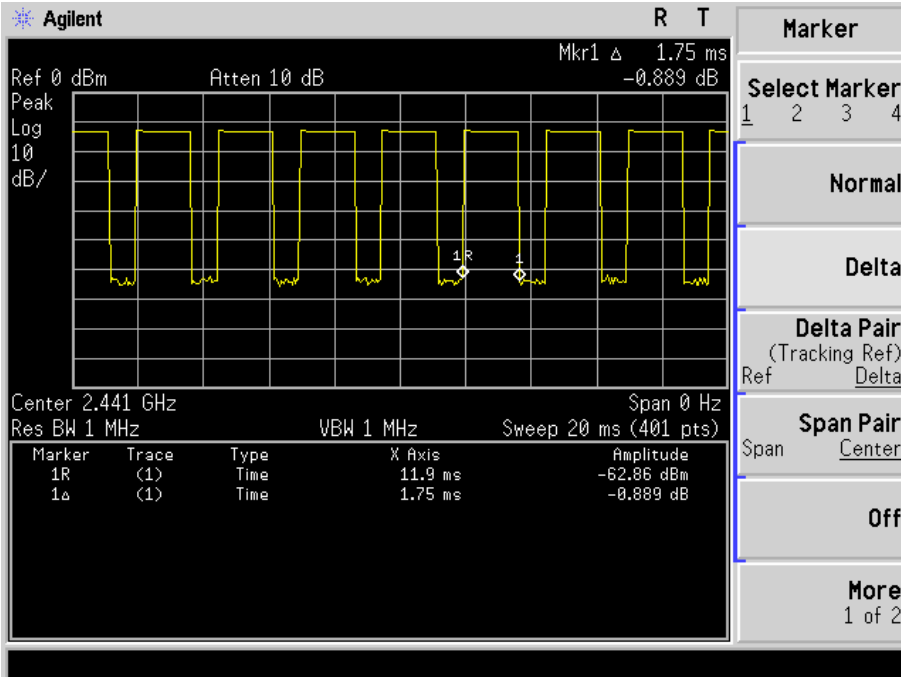

CH39-3DH3

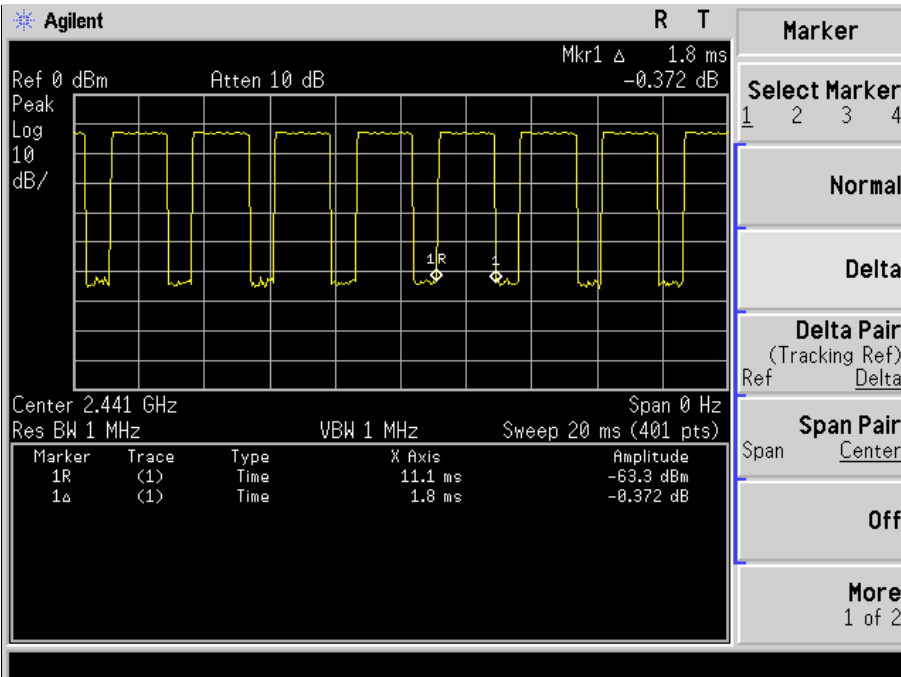

EUT :	Portable Bluetooth Speaker	Model Name :	SP3178-BK6
Temperature :	25 °C	Relative Humidity :	60%
Pressure :	1012 hPa	Test Voltage :	DC 3.7V
Test Mode :	CH39-DH1,2DH1,3DH1		

Data Packet	Frequency	Pulse Duration (ms)	Dwell Time (s)	Limits (s)
DH1	2441 MHz	0.435	0.14	0.4
2DH1	2441 MHz	0.450	0.14	0.4
3DH1	2441 MHz	0.435	0.14	0.4

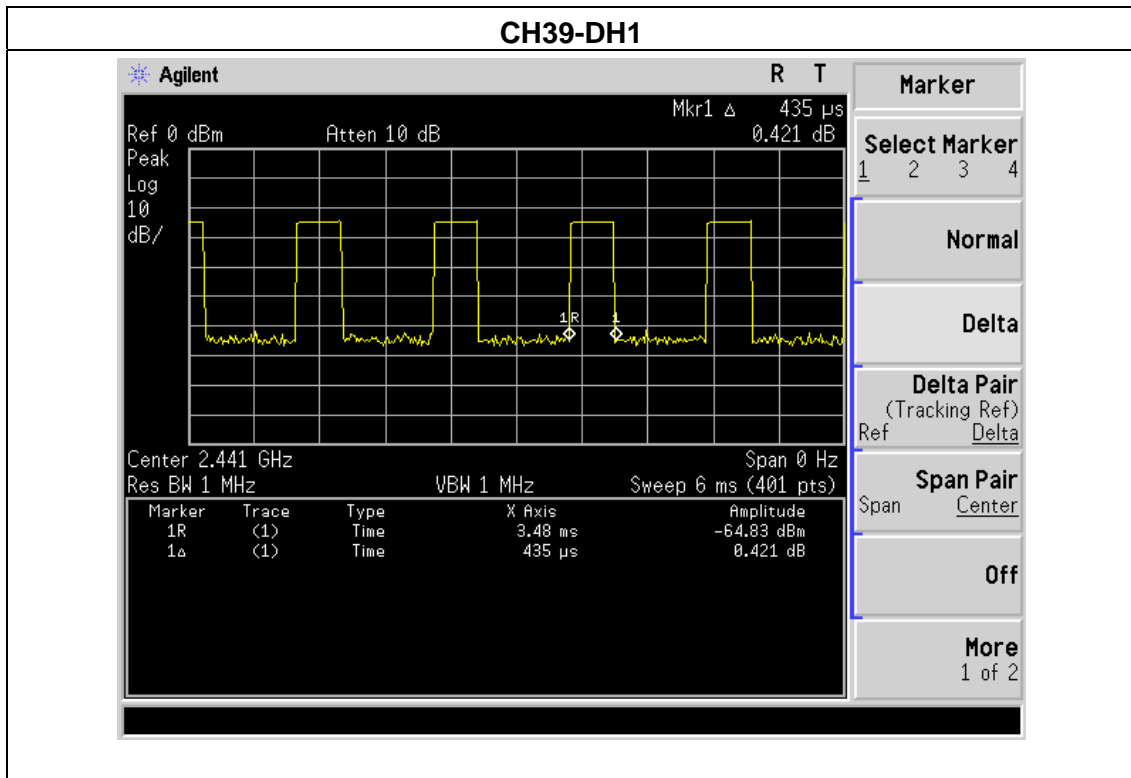

CH39-2DH1

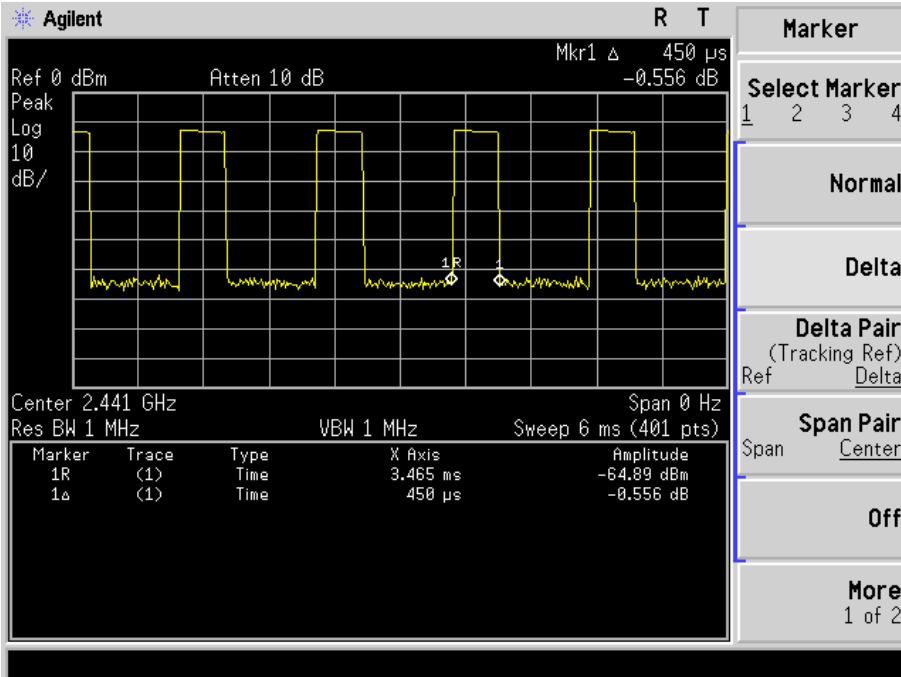

CH39-3DH1

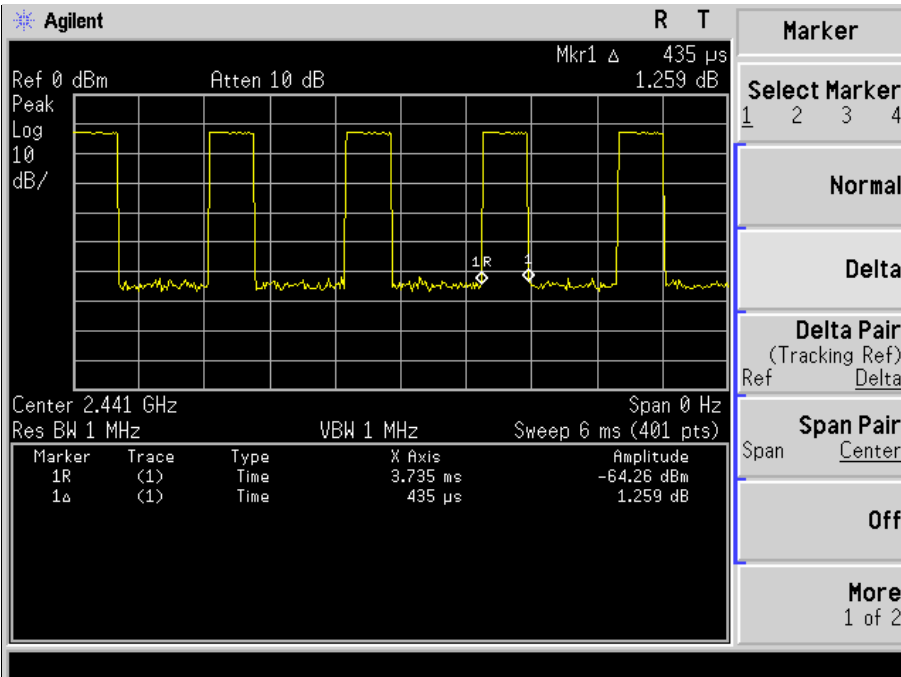

6. HOPPING CHANNEL SEPARATION MEASUREMENT

6.1 APPLIED PROCEDURES / LIMIT

Frequency hopping systems operating in the 2400-2483.5 MHz band may have hopping channel carrier frequencies that are separated by 25 kHz or two-thirds of the 20 dB bandwidth of the hopping channel, whichever is greater.

Spectrum Parameter	Setting
Attenuation	Auto
Span Frequency	> Measurement Bandwidth or Channel Separation
RB	100 kHz (Channel Separation)
VB	300 kHz (Channel Separation)
Detector	Peak
Trace	Max Hold
Sweep Time	Auto

6.1.1 TEST PROCEDURE

- a. The transmitter output (antenna port) was connected to the spectrum analyser in peak hold mode.
- b. The resolution bandwidth of 100 kHz and the video bandwidth of 300 kHz were utilised for channel separation measurement.

6.1.2 DEVIATION FROM STANDARD

No deviation.

6.1.3 TEST SETUP

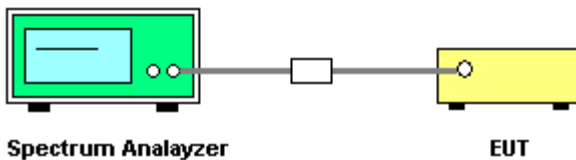

6.1.4 EUT OPERATION CONDITIONS

The EUT was programmed to be in continuously transmitting mode.

6.1.5 TEST RESULTS

EUT :	Portable Bluetooth Speaker	Model Name :	SP3178-BK6
Temperature :	25 °C	Relative Humidity :	60%
Pressure :	1012 hPa	Test Voltage :	DC 3.7V
Test Mode :	CH00 / CH39 /CH78 (1Mbps Mode)		

Frequency	Ch. Separation (MHz)	Result
2402 MHz	1.00	Complies
2441 MHz	1.00	Complies
2480 MHz	1.00	Complies

Ch. Separation Limits: > 20dB bandwidth

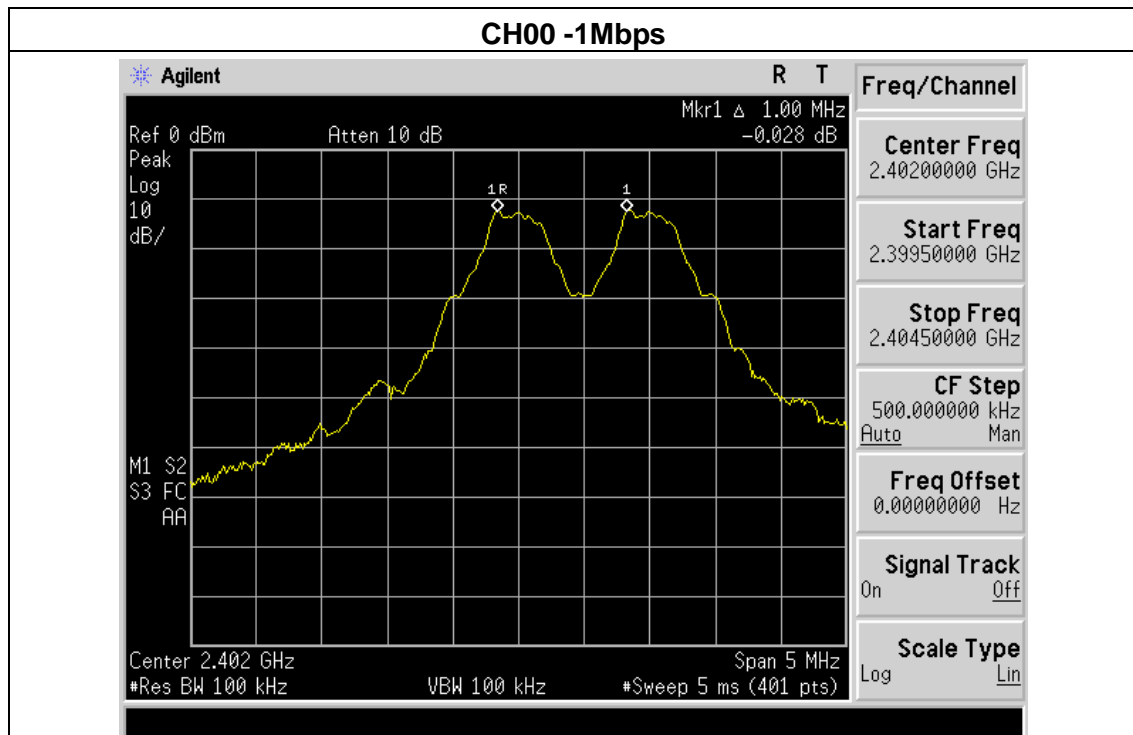

CH39 -1Mbps

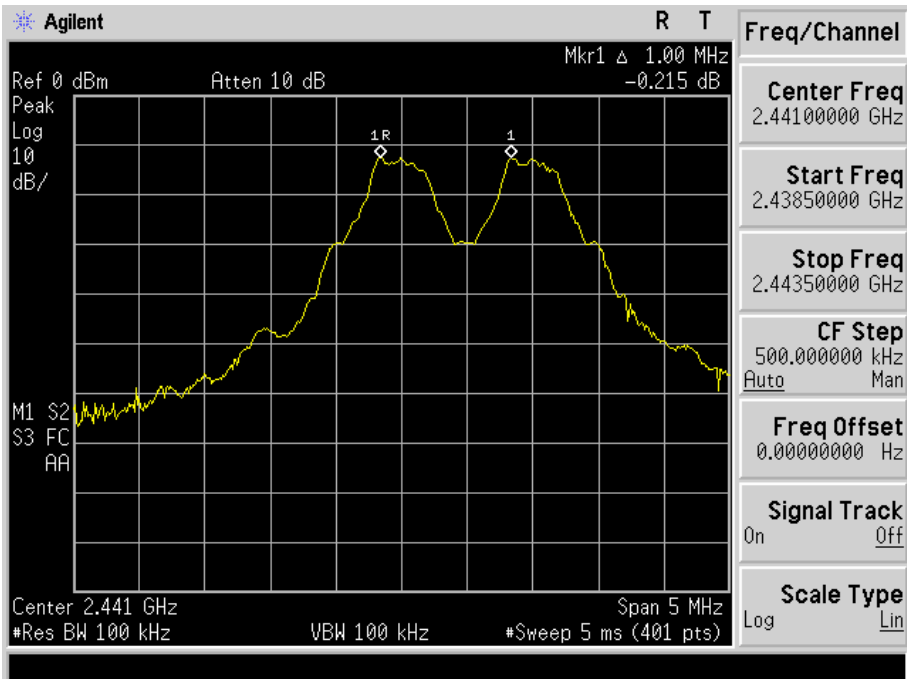

CH78 -1Mbps

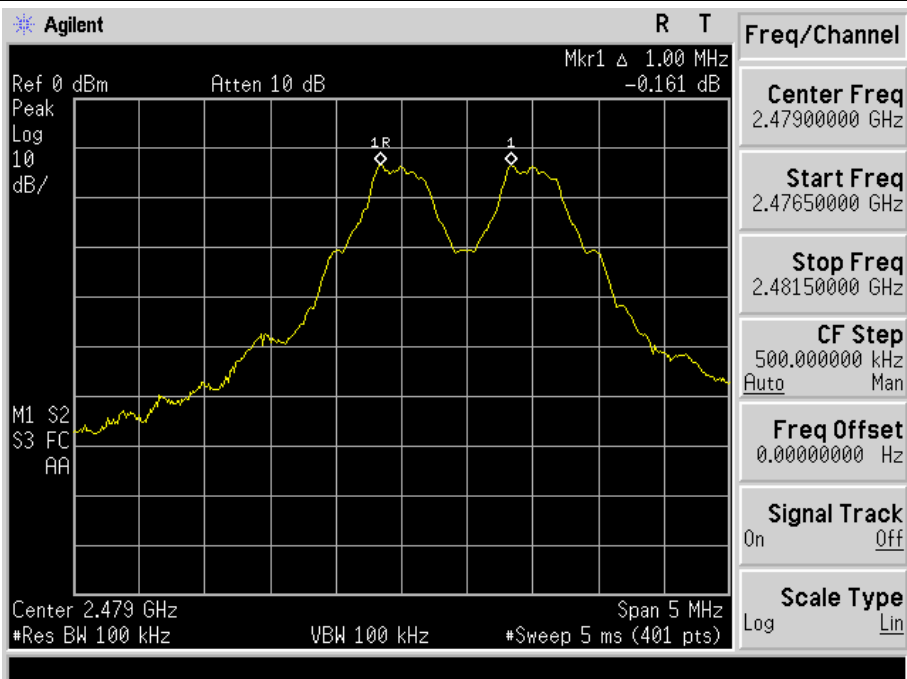

EUT :	Portable Bluetooth Speaker	Model Name :	SP3178-BK6
Temperature :	25 °C	Relative Humidity :	60%
Pressure :	1012 hPa	Test Voltage :	DC 3.7V
Test Mode :	CH00 / CH39 /CH78 (2Mbps Mode)		

Frequency	Ch. Separation (MHz)	Result
2402 MHz	1.00	Complies
2441 MHz	1.00	Complies
2480 MHz	1.00	Complies

Ch. Separation Limits: >2/3 of 20dB bandwidth

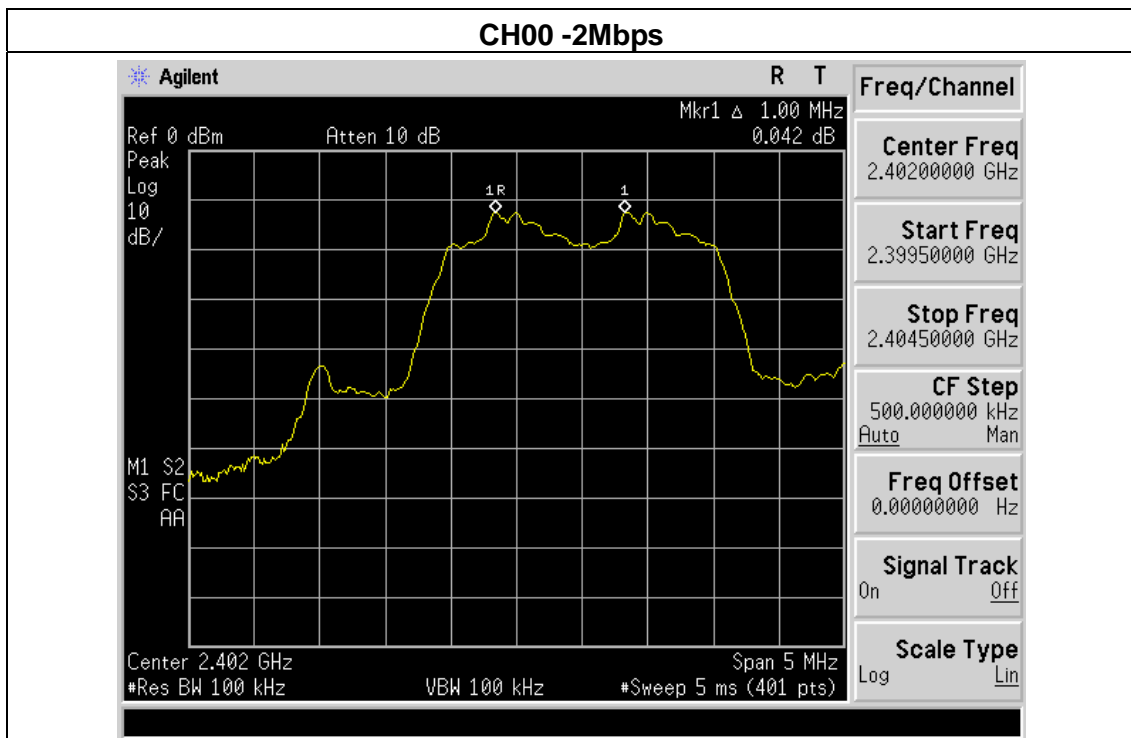

CH39 -2Mbps

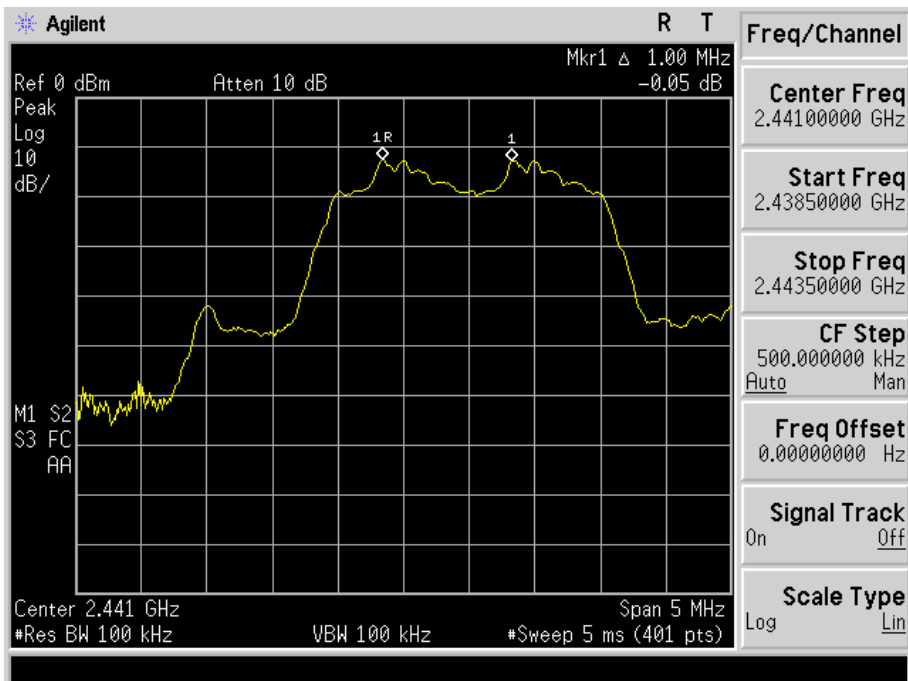

CH78 -2Mbps

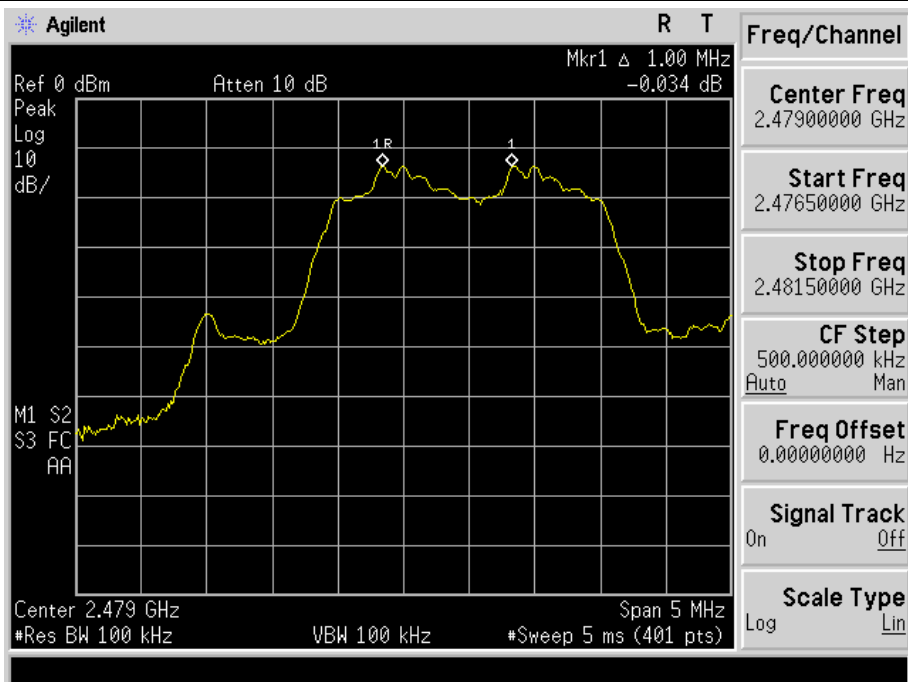

EUT :	Portable Bluetooth Speaker	Model Name :	SP3178-BK6
Temperature :	25 °C	Relative Humidity :	60%
Pressure :	1012 hPa	Test Voltage :	DC 3.7V
Test Mode :	CH00 / CH39 /CH78 (3Mbps Mode)		

Frequency	Ch. Separation (MHz)	Result
2402 MHz	1.00	Complies
2441 MHz	1.00	Complies
2480 MHz	1.00	Complies

Ch. Separation Limits: >2/3 of 20dB bandwidth

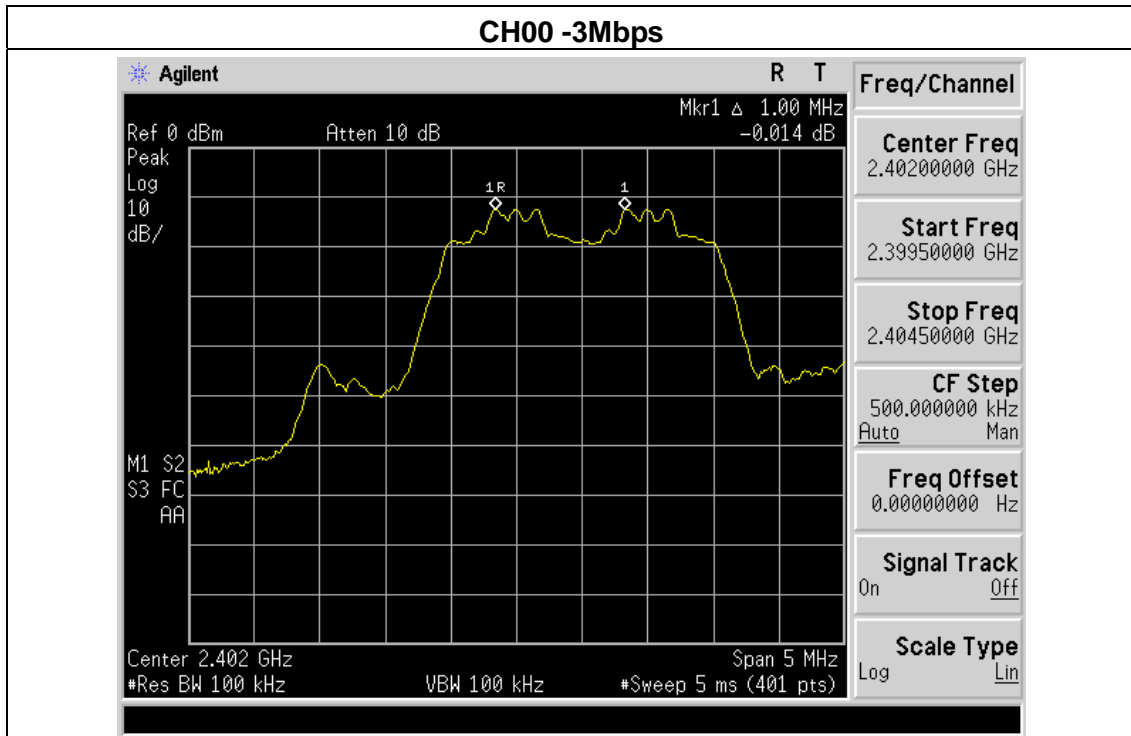

CH39 -3Mbps

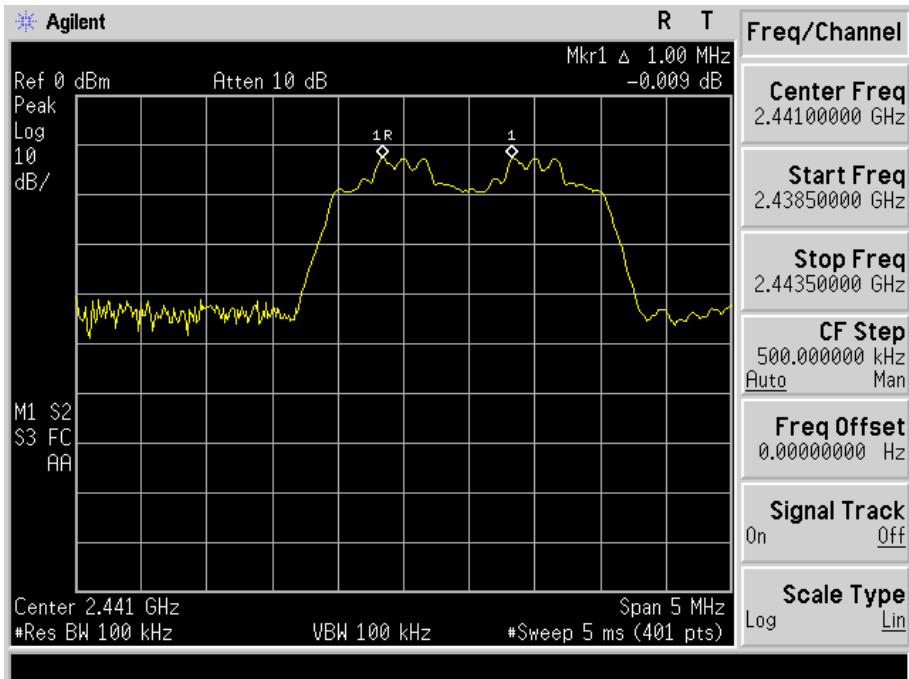

CH78 -3Mbps

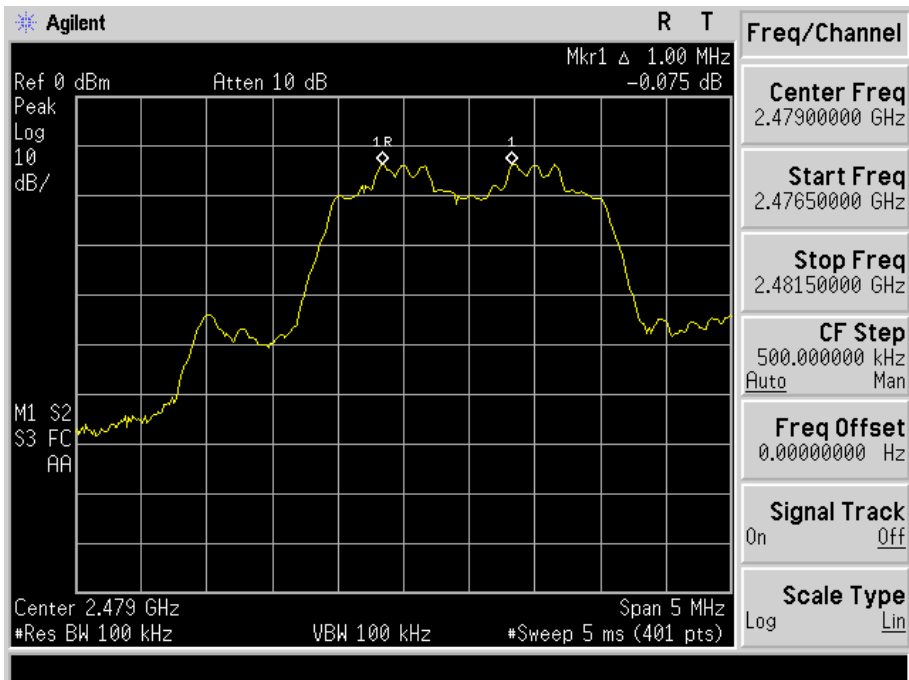

7. BANDWIDTH TEST

7.1 APPLIED PROCEDURES / LIMIT

FCC Part15 (15.247) , Subpart C				
Section	Test Item	Limit	Frequency Range (MHz)	Result
15.247 (a)(1)	Bandwidth	(20dB bandwidth)	2400-2483.5	PASS

Spectrum Parameter	Setting
Attenuation	Auto
Span Frequency	> Measurement Bandwidth or Channel Separation
RB	30 kHz
VB	100 kHz
Detector	Peak
Trace	Max Hold
Sweep Time	Auto

7.1.1 TEST PROCEDURE

- a. The EUT was directly connected to the spectrum analyzer and antenna output port as show in the block diagram below,
- b. Spectrum Setting : RBW= 100KHz, VBW=100KHz, Sweep time = Auto.

7.1.2 DEVIATION FROM STANDARD

No deviation.

7.1.3 TEST SETUP

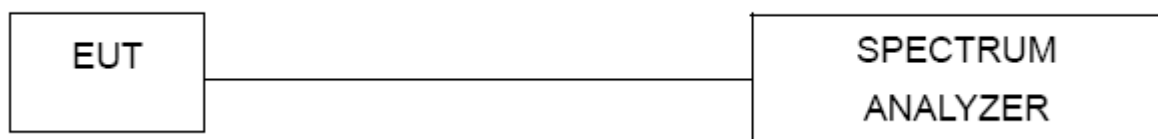

7.1.4 EUT OPERATION CONDITIONS

The EUT tested system was configured as the statements of 2.4 Unless otherwise a special operating condition is specified in the follows during the testing.

7.1.5 TEST RESULTS

EUT :	Portable Bluetooth Speaker	Model Name :	SP3178-BK6
Temperature :	25 °C	Relative Humidity :	60%
Pressure :	1012 hPa	Test Voltage :	DC 3.7V
Test Mode :	CH00 / CH39 /C78(1Mbps)		

Frequency	20dB Bandwidth (MHz)	Result
2402 MHz	825.515	PASS
2441 MHz	674.702	PASS
2480 MHz	673.420	PASS

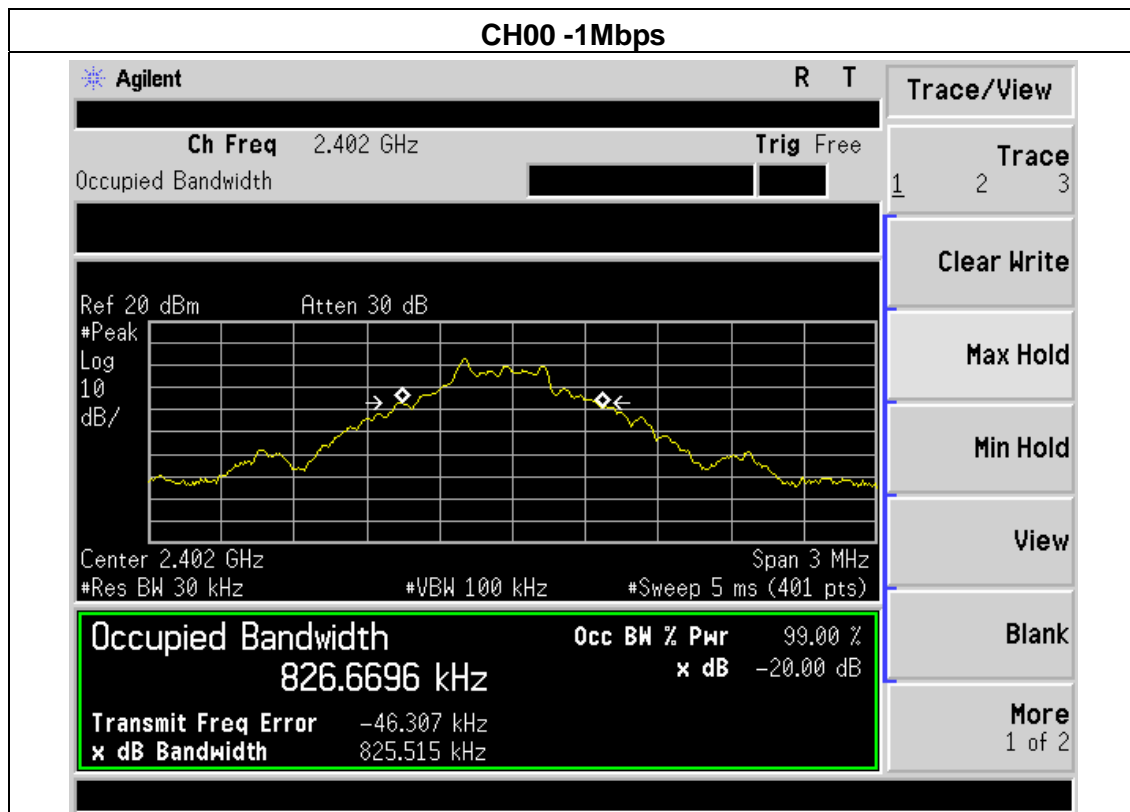

CH39 -1Mbps

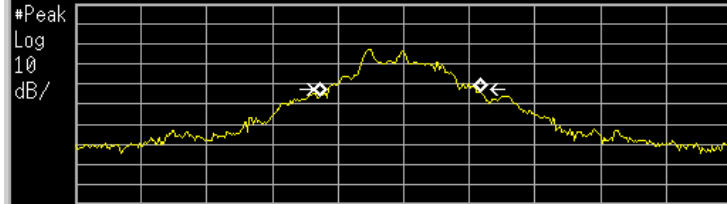
Agilent R T		Freq/Channel	
Ch Freq 2.441 GHz Trig Free		Center Freq 2.44100000 GHz	
Occupied Bandwidth █ █		Start Freq 2.43950000 GHz	
Center 2.44100000 GHz		Stop Freq 2.44250000 GHz	
Ref 10 dBm Atten 20 dB		CF Step 300.000000 kHz Auto Man	
		Freq Offset 0.00000000 Hz	
Center 2.441 GHz Span 3 MHz #Res BW 30 kHz #VBW 100 kHz Sweep 5 ms (401 pts)		Signal Track On Off	
Occupied Bandwidth 739.5647 kHz		Occ BW % Pwr 99.00 % x dB -20.00 dB	
Transmit Freq Error -14.269 kHz x dB Bandwidth 674.702 kHz		Scale Type Log Lin	
C:PICTURE.GIF file saved			

CH78 -1Mbps

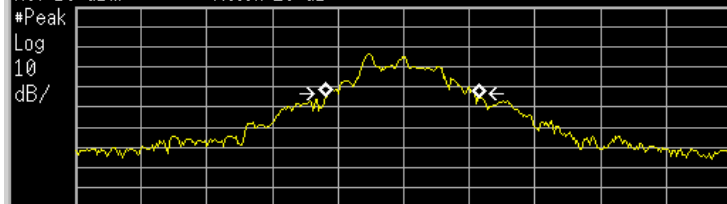
Agilent R T		Trace/View	
Ch Freq 2.48 GHz Trig Free		Trace 1 2 3	
Occupied Bandwidth █ █		Clear Write	
Center 2.48000000 GHz		Max Hold	
Ref 10 dBm Atten 20 dB		Min Hold	
		View	
Center 2.48 GHz Span 3 MHz #Res BW 30 kHz #VBW 100 kHz Sweep 5 ms (401 pts)		Blank	
Occupied Bandwidth 705.9251 kHz		More 1 of 2	
Transmit Freq Error -4.590 kHz x dB Bandwidth 673.420 kHz			
C:PICTURE.GIF file saved			

EUT :	Portable Bluetooth Speaker	Model Name :	SP3178-BK6
Temperature :	25 °C	Relative Humidity :	60%
Pressure :	1012 hPa	Test Voltage :	DC 3.7V
Test Mode :	CH00 / CH39 /C78(2Mbps)		

Frequency	20dB Bandwidth (MHz)	Result
2402 MHz	1.235	PASS
2441 MHz	1.239	PASS
2480 MHz	1.217	PASS

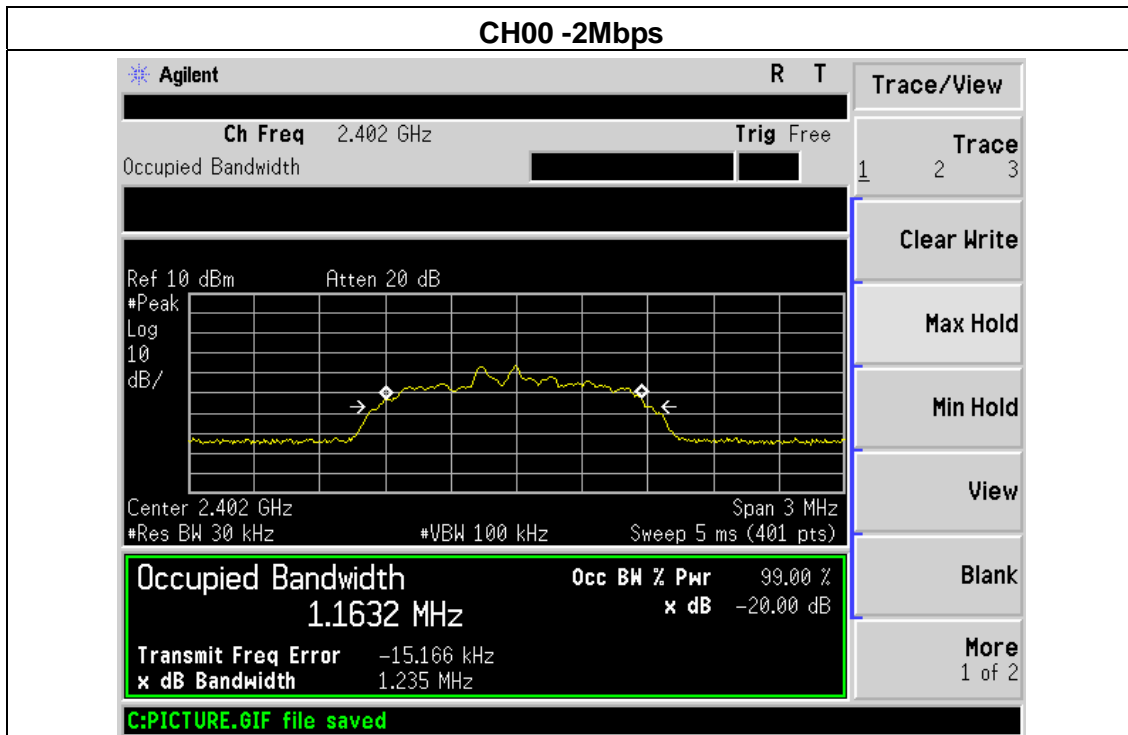

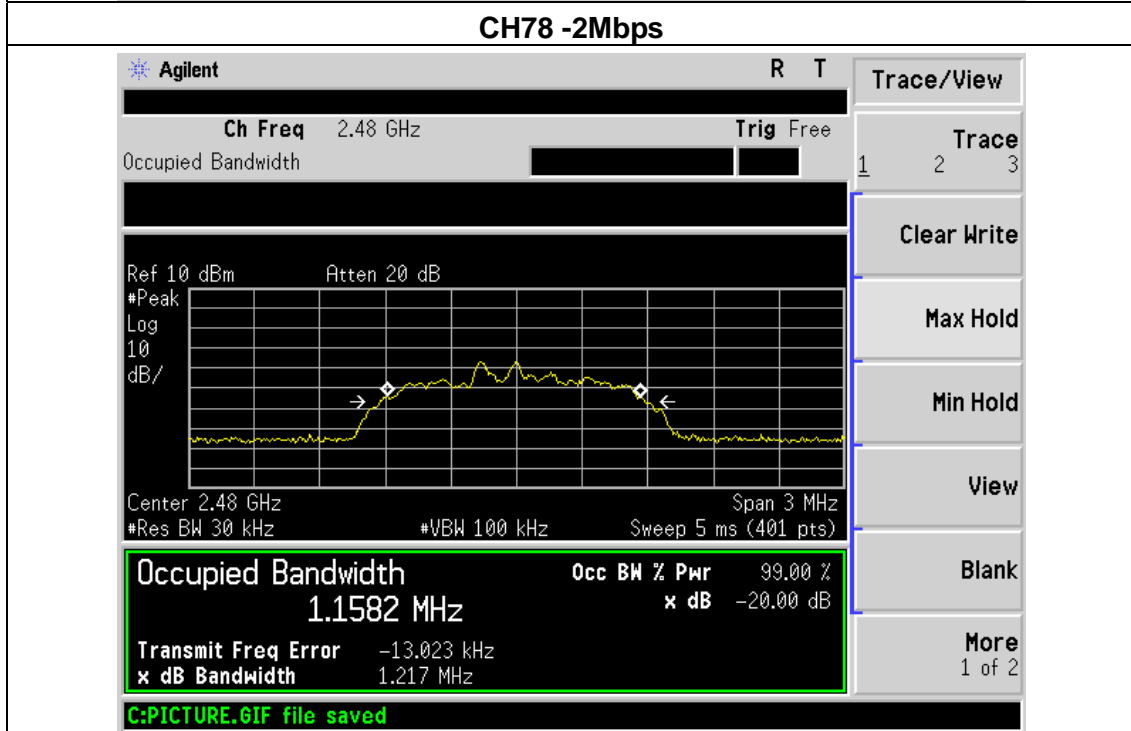
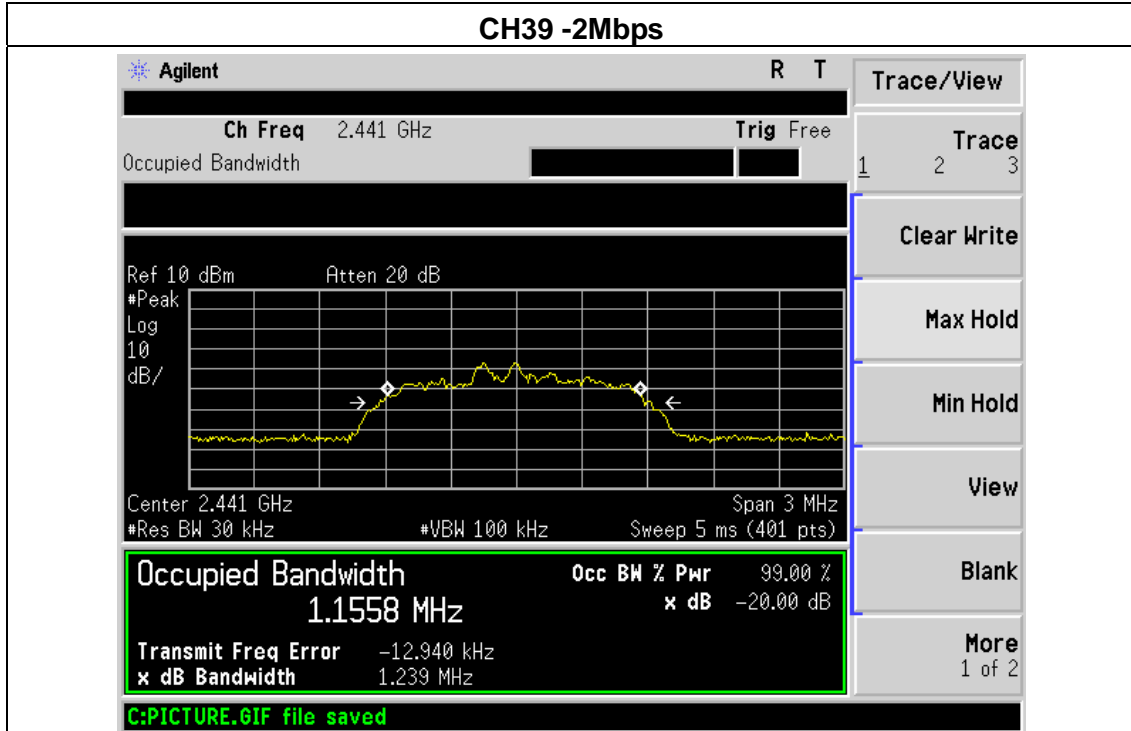

EUT :	Portable Bluetooth Speaker	Model Name :	SP3178-BK6
Temperature :	25 °C	Relative Humidity :	60%
Pressure :	1012 hPa	Test Voltage :	DC 3.7V
Test Mode :	CH00 / CH39 /C78(3Mbps)		

Frequency	20dB Bandwidth (MHz)	Result
2402 MHz	1.219	PASS
2441 MHz	1.213	PASS
2480 MHz	1.204	PASS

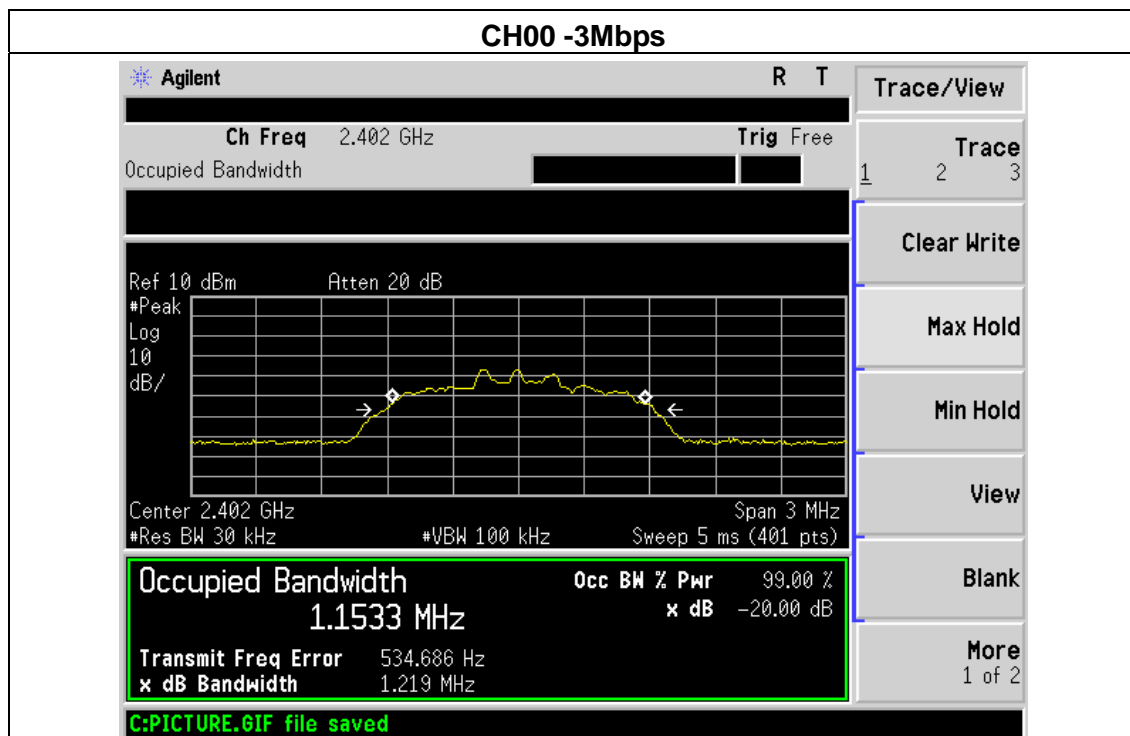

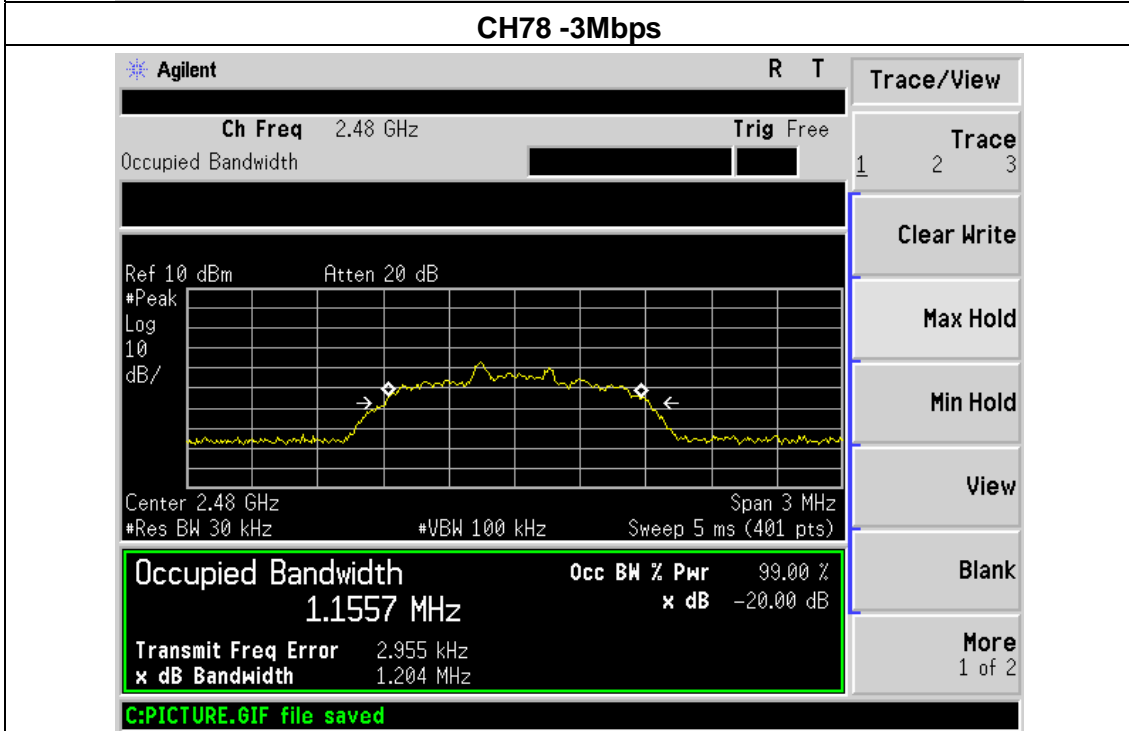
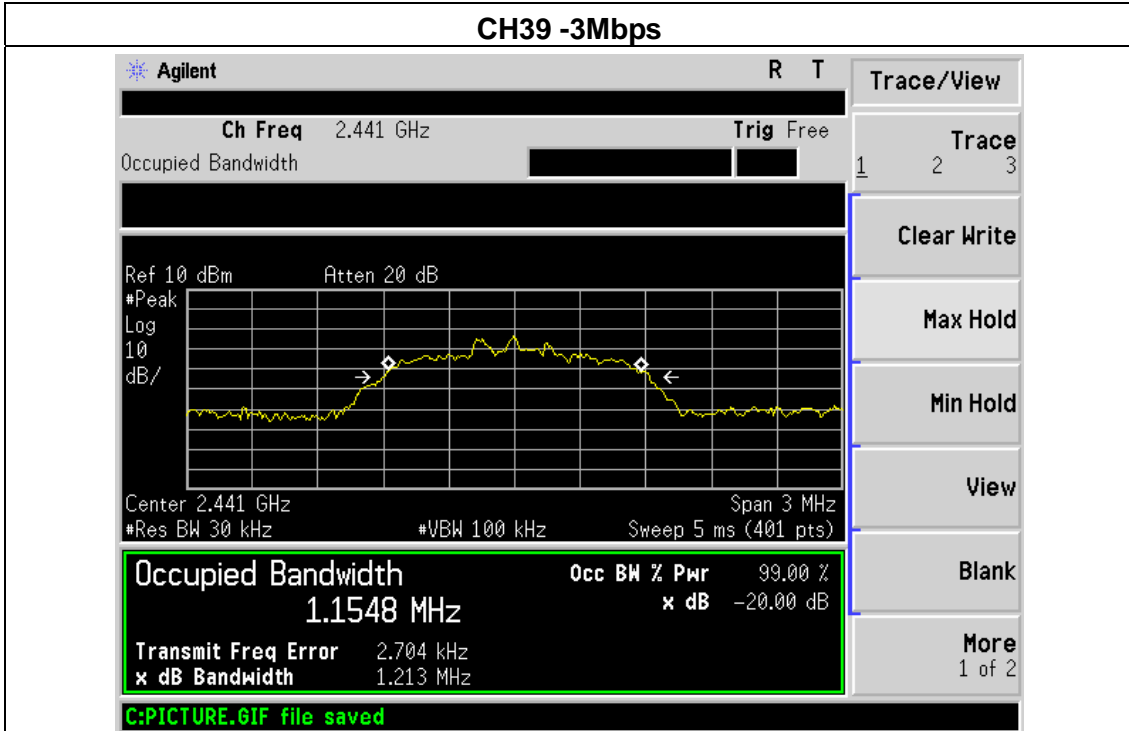

8. PEAK OUTPUT POWER TEST

8.1 APPLIED PROCEDURES / LIMIT

FCC Part15 (15.247) , Subpart C				
Section	Test Item	Limit	Frequency Range (MHz)	Result
15.247 (b)(i)	Peak Output Power	30dbm or 20.96dBm	2400-2483.5	PASS

8.1.1 TEST PROCEDURE

- a. The EUT was directly connected to the spectrum analyzer and antenna output port as show in the block diagram below,
- b. Spectrum Setting : RBW > the 20 dB bandwidth of the emission being measured
 - Span = approximately 5 times the 20 dB bandwidth, centered on a hopping channel
 - VBW ≥ RBW
 - Sweep = auto
 - Detector function = peak
 - Trace = max hold

8.1.2 DEVIATION FROM STANDARD

No deviation.

8.1.3 TEST SETUP



8.1.4 EUT OPERATION CONDITIONS

The EUT tested system was configured as the statements of 2.4 Unless otherwise a special operating condition is specified in the follows during the testing.

8.1.5 TEST RESULTS

EUT :	Portable Bluetooth Speaker	Model Name :	SP3178-BK6
Temperature :	25 °C	Relative Humidity :	60%
Pressure :	1012 hPa	Test Voltage :	DC 3.7V
Test Mode :	CH00/ CH39 /CH78 (1M/2M/3Mbps Mode)		

1Mbps			
Test Channel	Frequency (MHz)	Peak Output Power (dBm)	LIMIT (dBm)
CH00	2402	6.313	20.96
CH39	2441	6.924	20.96
CH78	2480	7.337	20.96
2Mbps			
CH00	2402	5.049	20.96
CH39	2441	5.682	20.96
CH78	2480	6.125	20.96
3Mbps			
CH00	2402	5.646	20.96
CH39	2441	6.271	20.96
CH78	2480	6.562	20.96

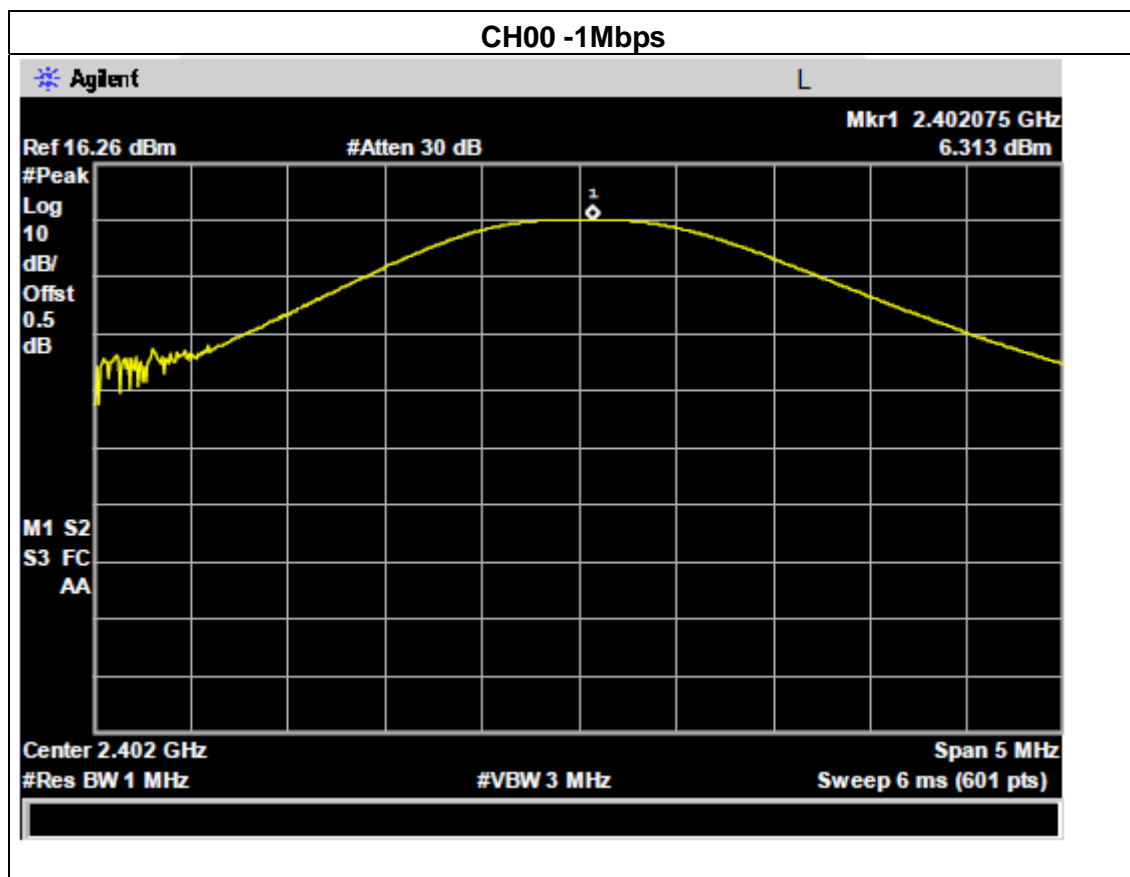

CH39 -1Mbps

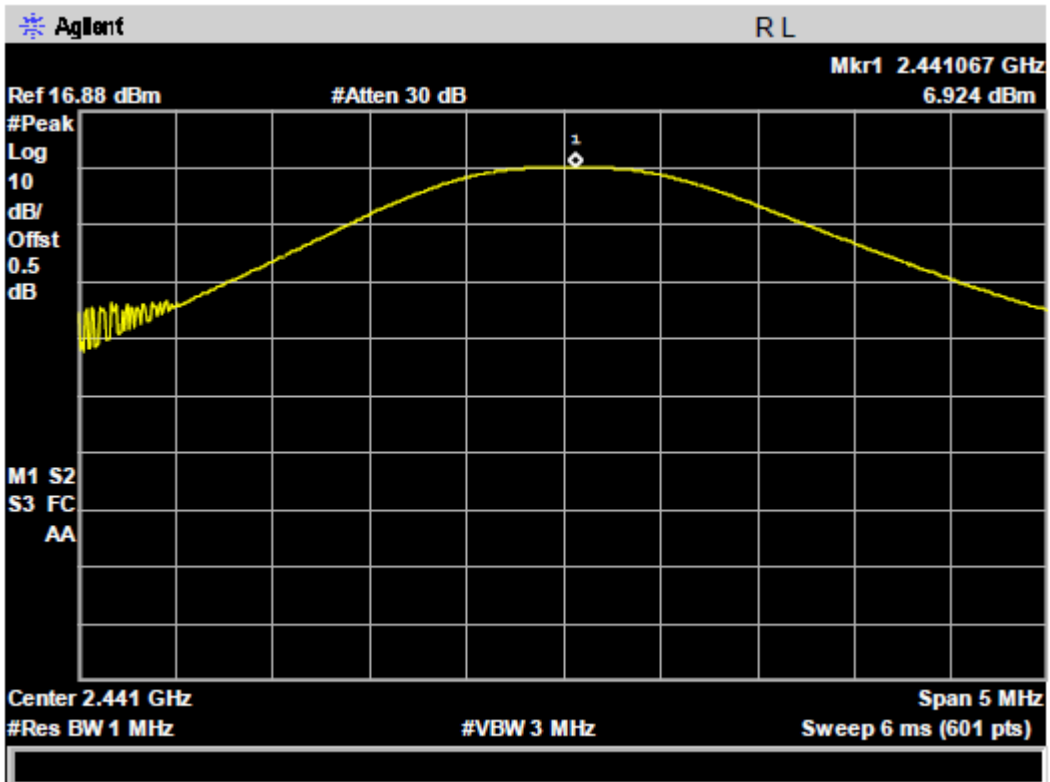

CH78 -1Mbps

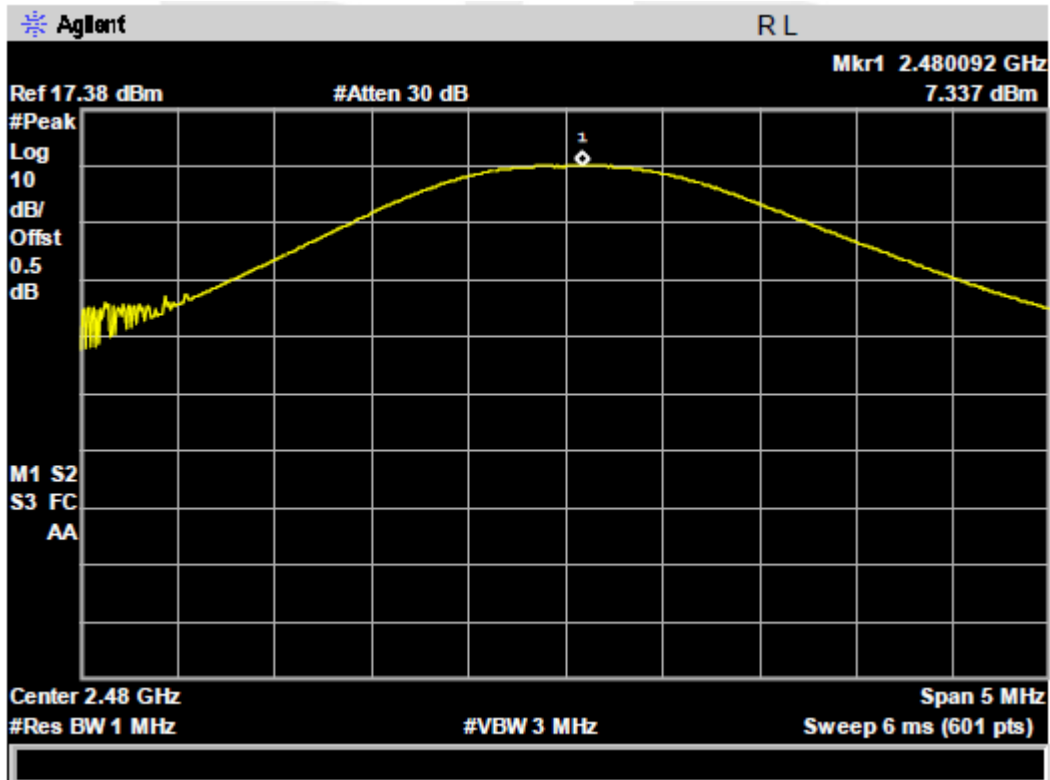

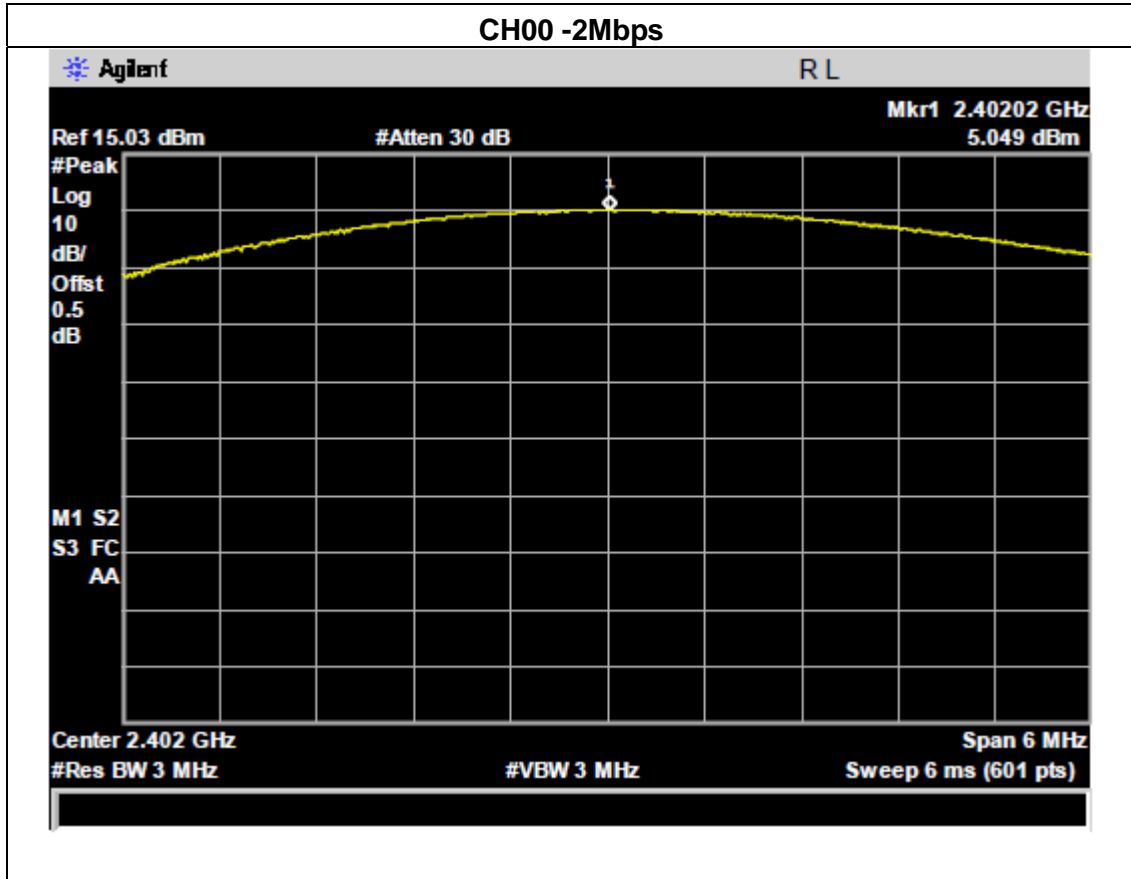

CH39 -2Mbps

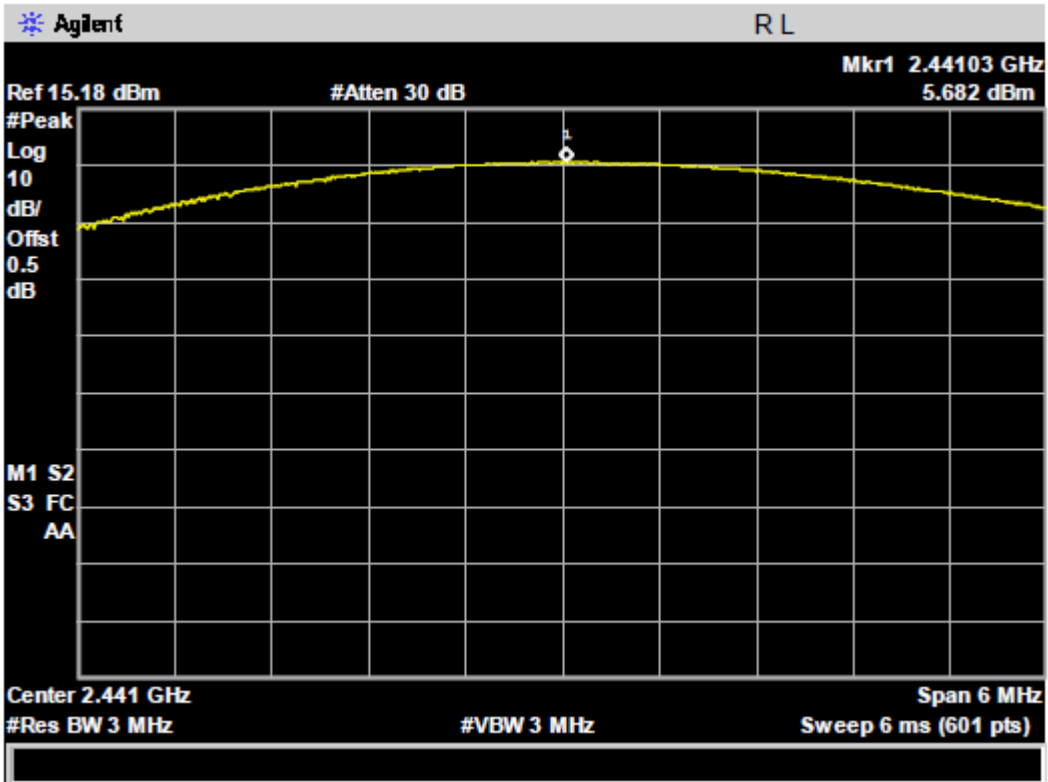

CH78 -2Mbps

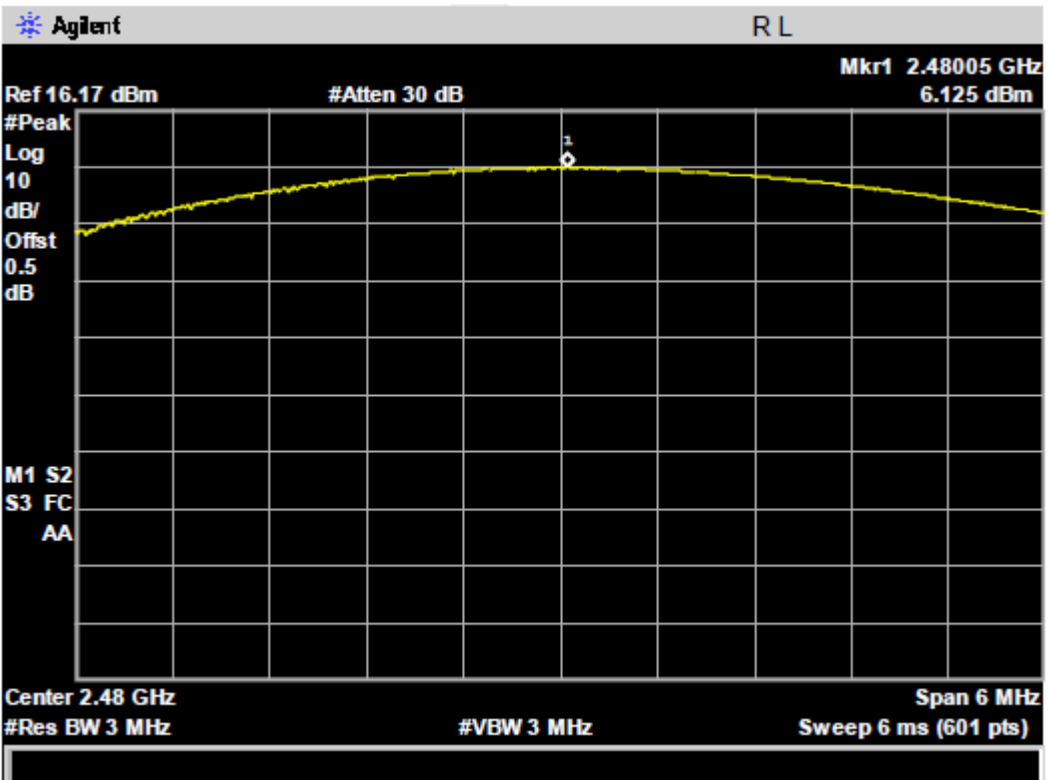

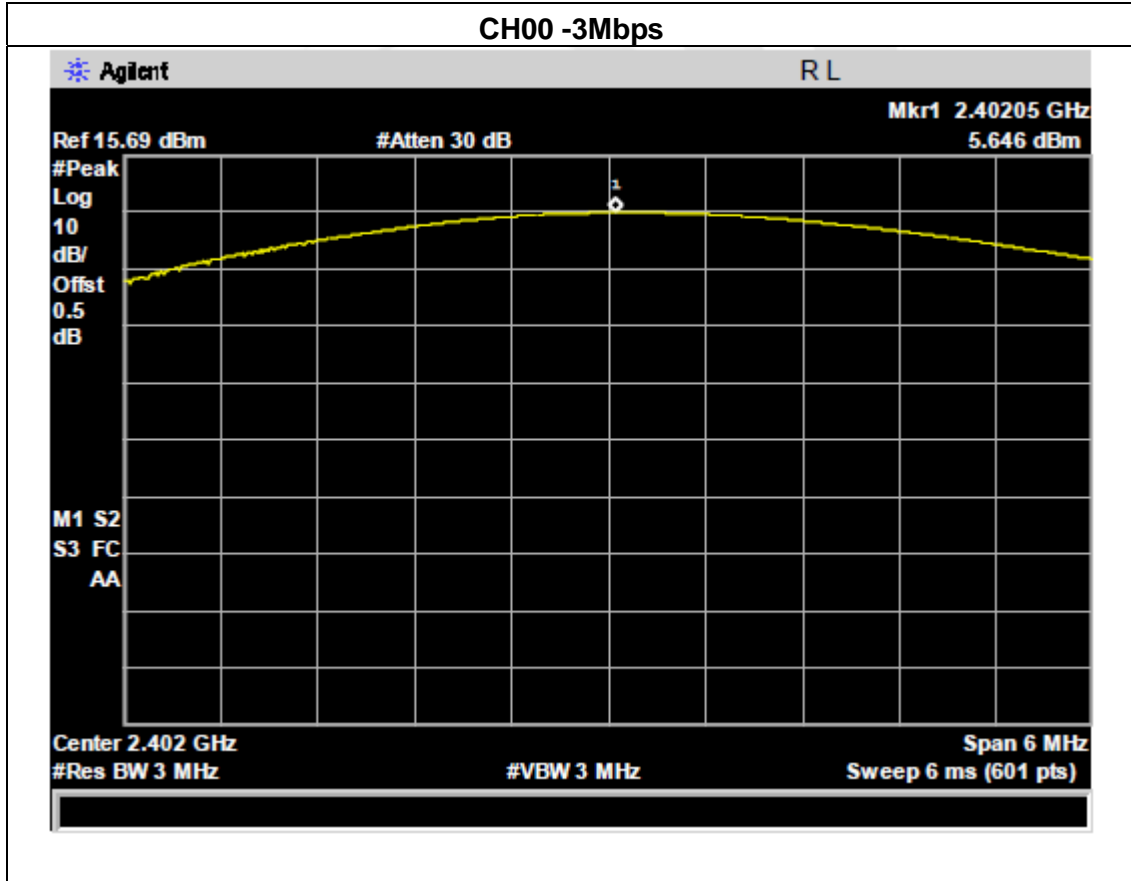

CH39 -3Mbps

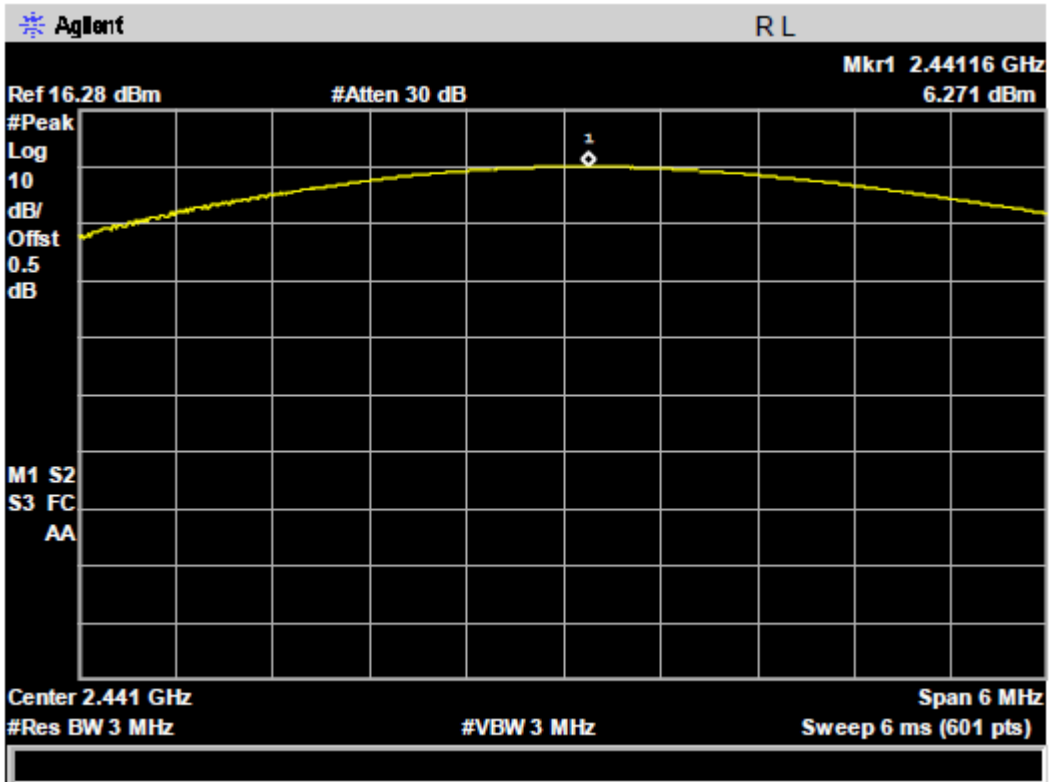

CH78 -3Mbps

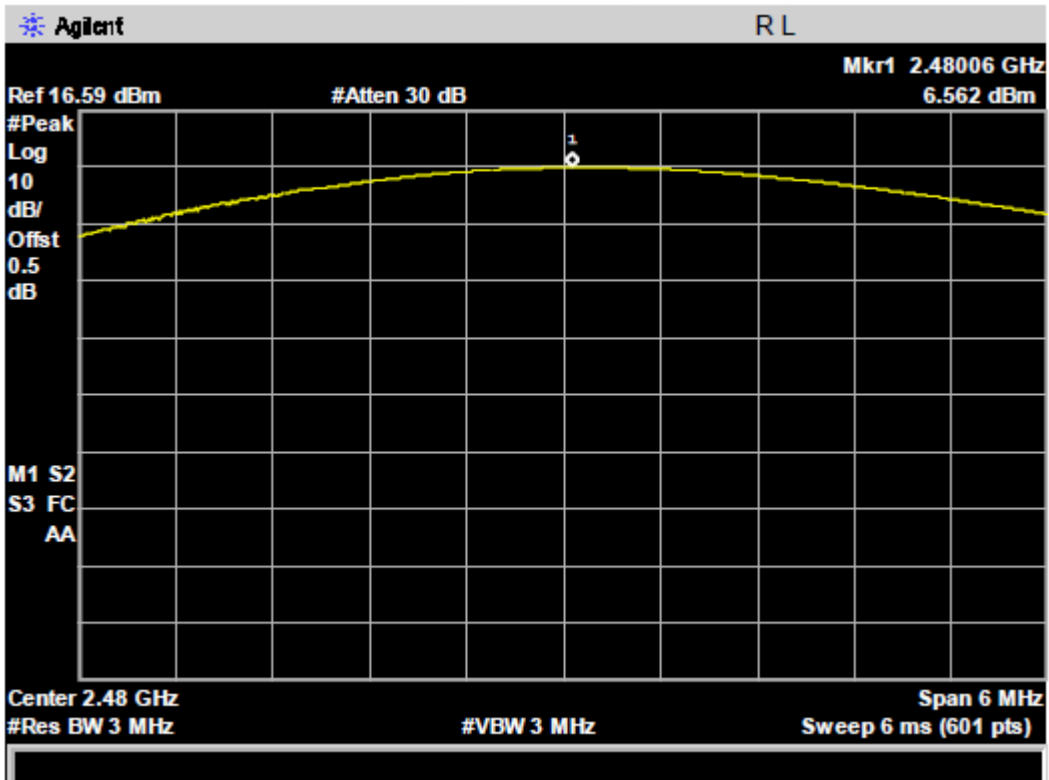

9. ANTENNA REQUIREMENT

9.1 STANDARD REQUIREMENT

15.203 requirement: For intentional device, according to 15.203: an intentional radiator shall be designed to ensure that no antenna other than that furnished by the responsible party shall be used with the device.

9.2 EUT ANTENNA

The EUT antenna is PCB antenna. It comply with the standard requirement.

10. CONDUCTED SPURIOUS EMISSIONS

10.1 REQUIREMENT

According to FCC section 15.247(d), in any 100kHz bandwidth outside the frequency band in which the spread spectrum or digitally modulated intentional radiator is operating, the radio frequency power that is produced by the intentional radiator shall be at least 20dB below that in the 100kHz bandwidth within the band that contains the highest level of the desired power, based on either an RF conducted or a radiated measurement.

10.2 TEST PROCEDURE

According to FCC section 15.247(d), in any 100kHz bandwidth outside the frequency band in which the spread spectrum or digitally modulated intentional radiator is operating, the radio frequency power that is produced by the intentional radiator shall be at least 20dB below that in the 100kHz bandwidth within the band that contains the highest level of the desired power, based on either an RF conducted or a radiated measurement.

10.3 TEST SETUP

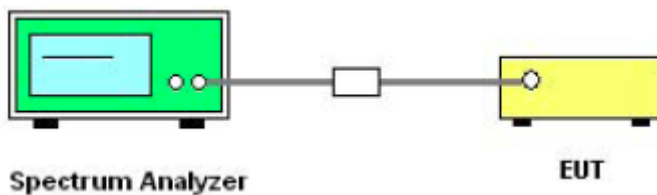

The EUT which is powered by the Battery, is coupled to the Spectrum Analyzer; the RF load attached to the EUT antenna terminal is 50Ohm; the path loss as the factor is calibrated to correct the reading. Make the measurement with the spectrum analyzer's resolution bandwidth(RBW) = 100 kHz. In order to make an accurate measurement, set the span greater than RBW.

10.4 EUT OPERATION CONDITIONS

The EUT tested system was configured as the statements of 2.3 Unless otherwise a special operating condition is specified in the follows during the testing.

10.5 TEST RESULTS

1Mbps:

CH0

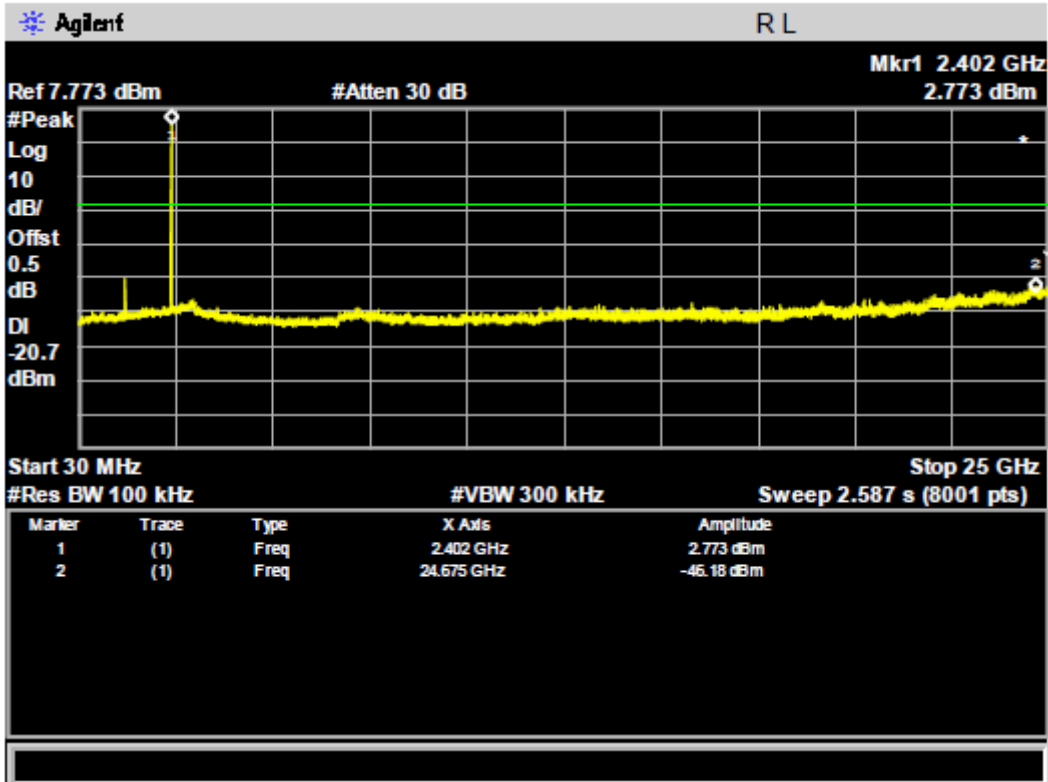

CH 39

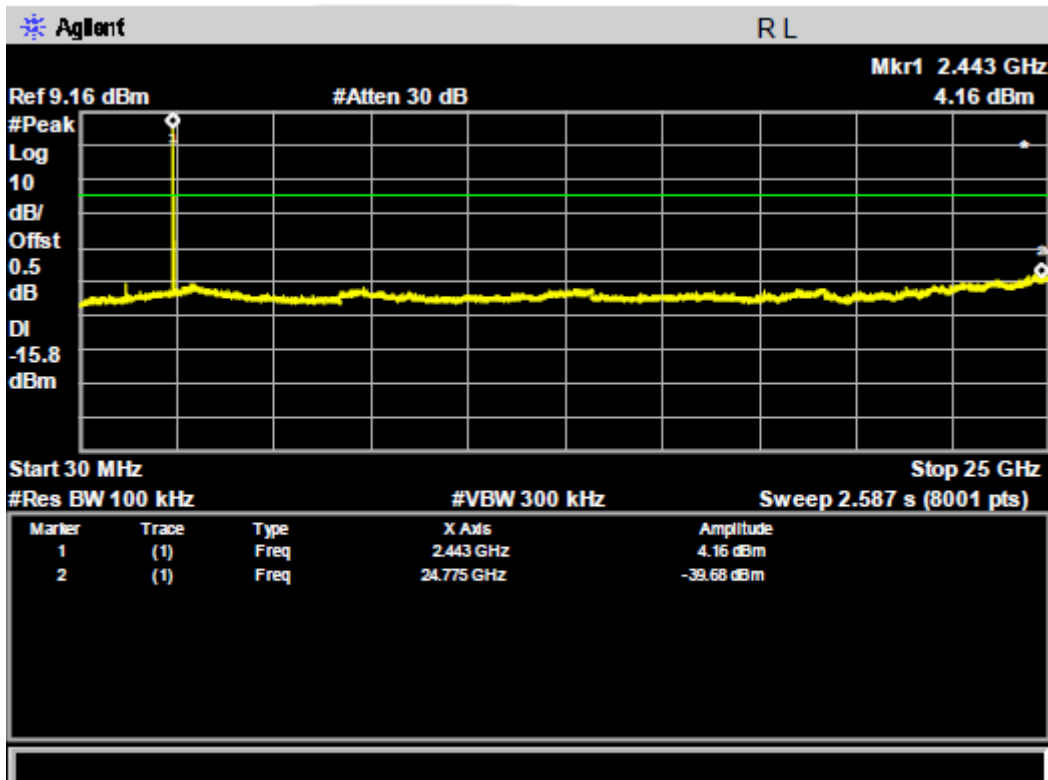

CH78

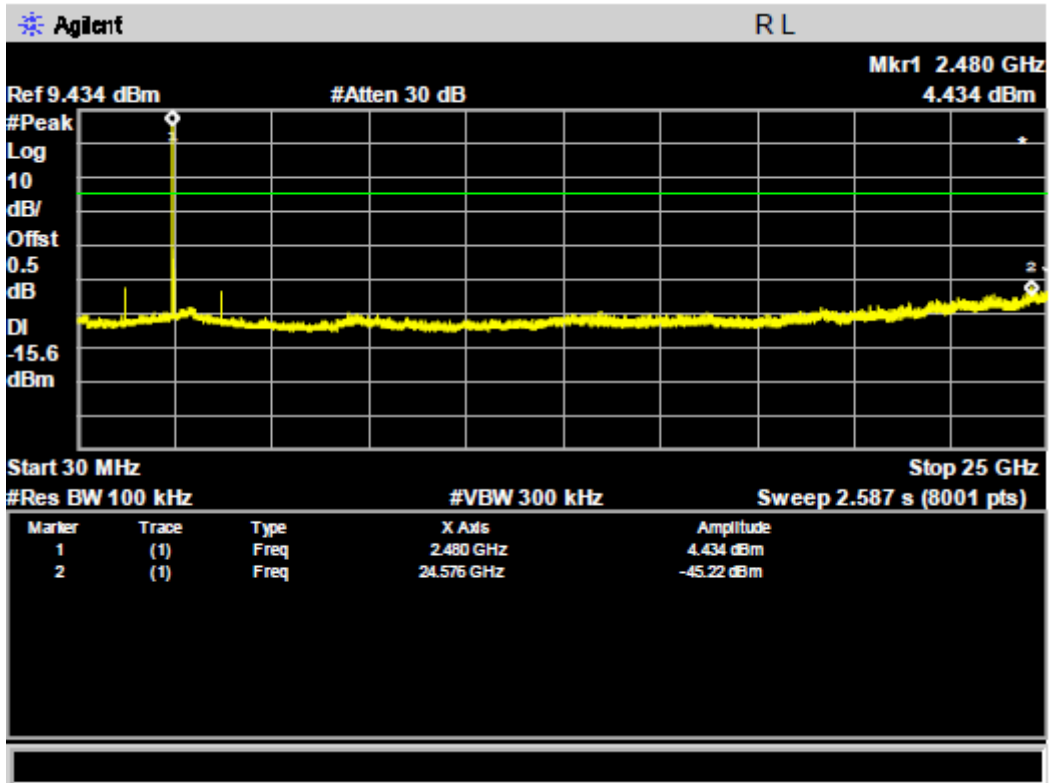

For Band Edge:

CH0

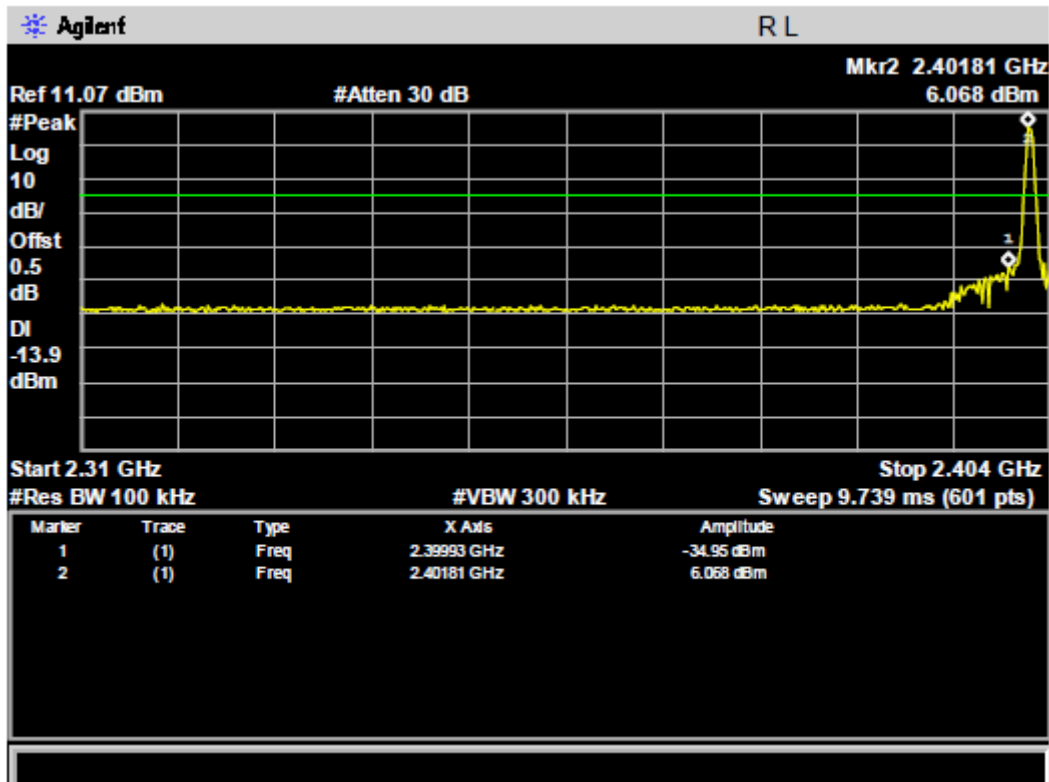

CH78

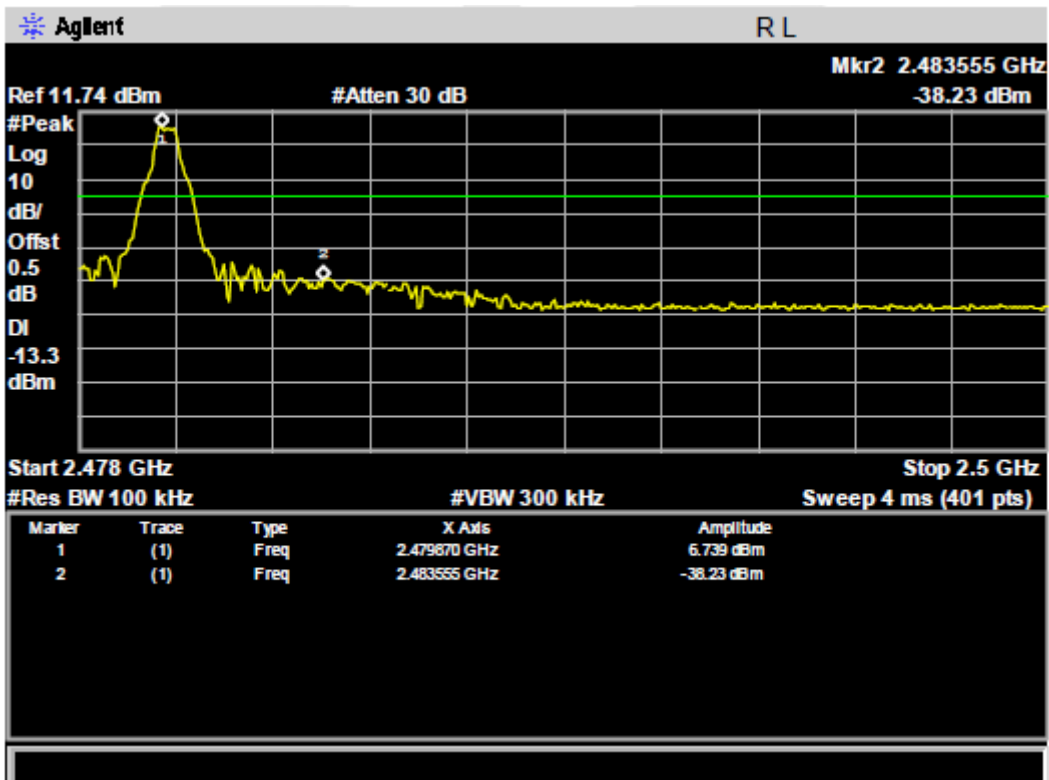

2Mbps:

CH0

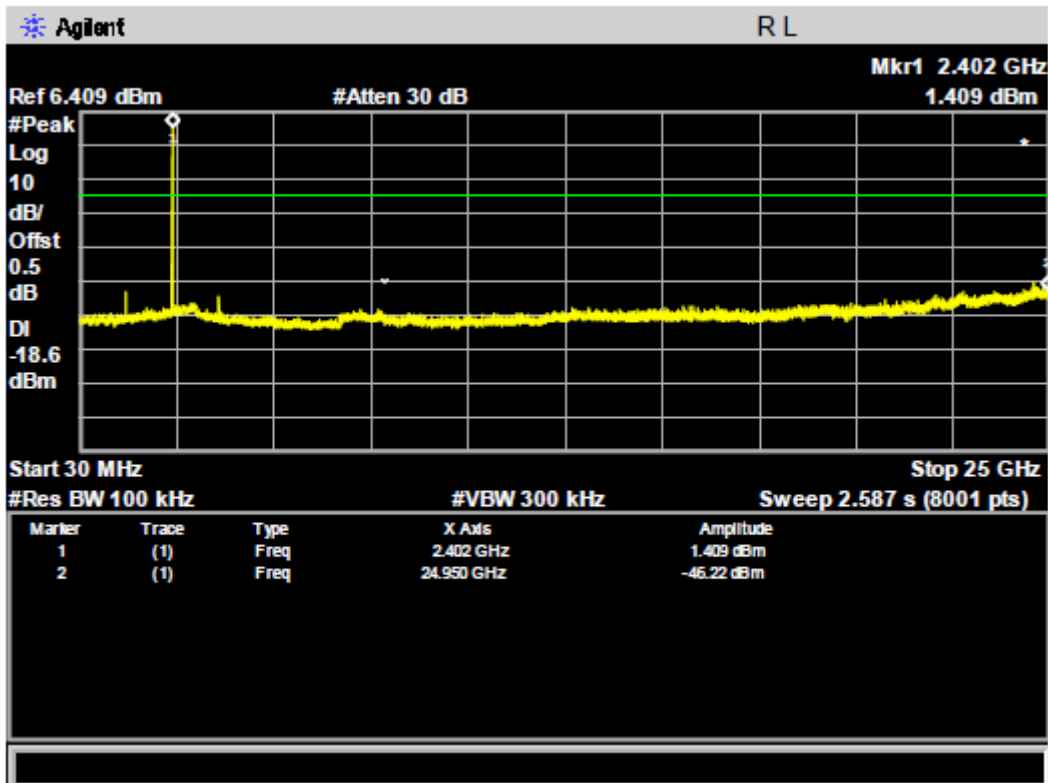

Ch39

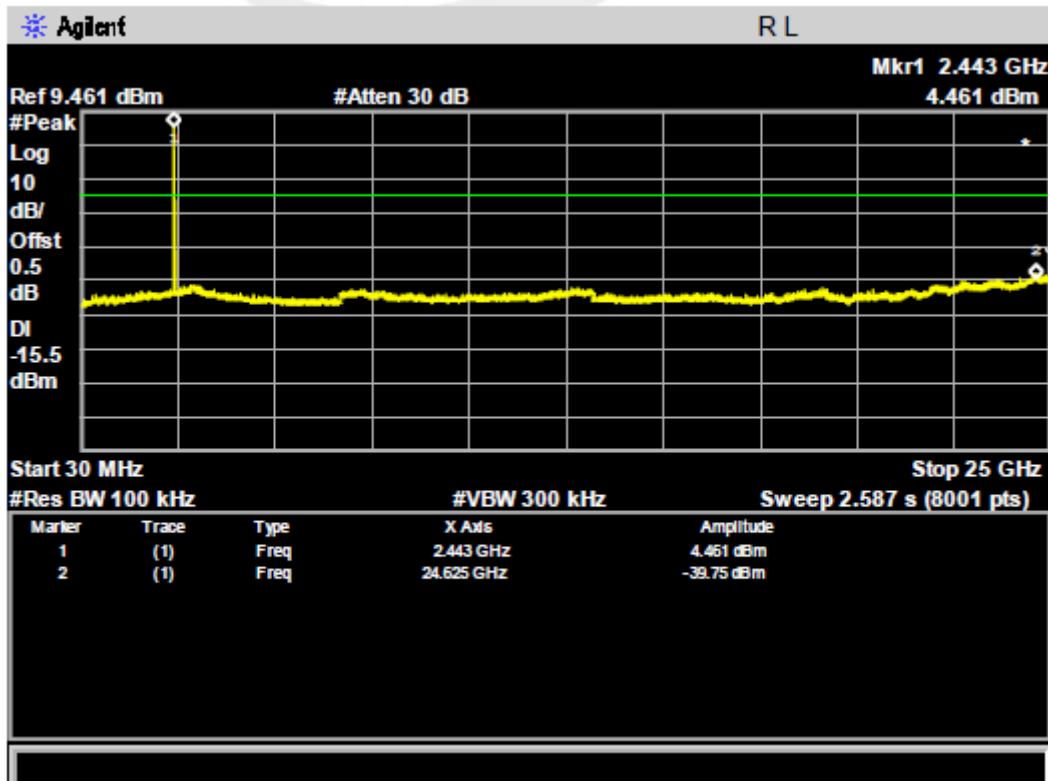

Ch78

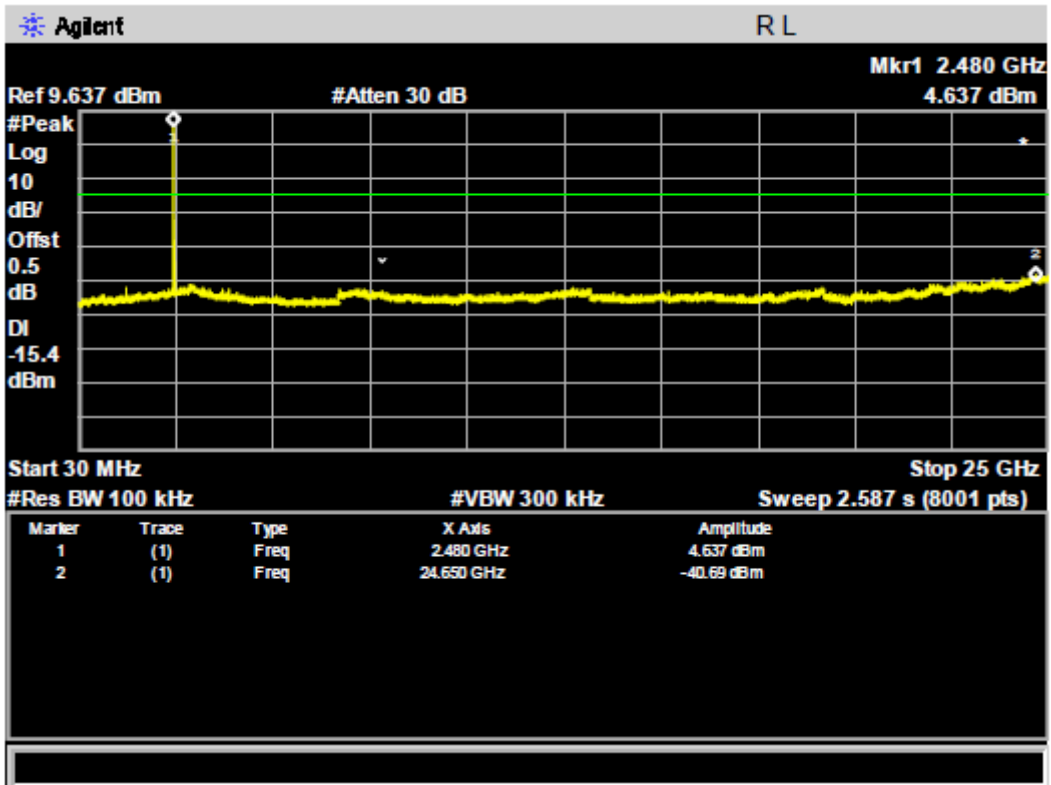

For Band Edge:

CH0

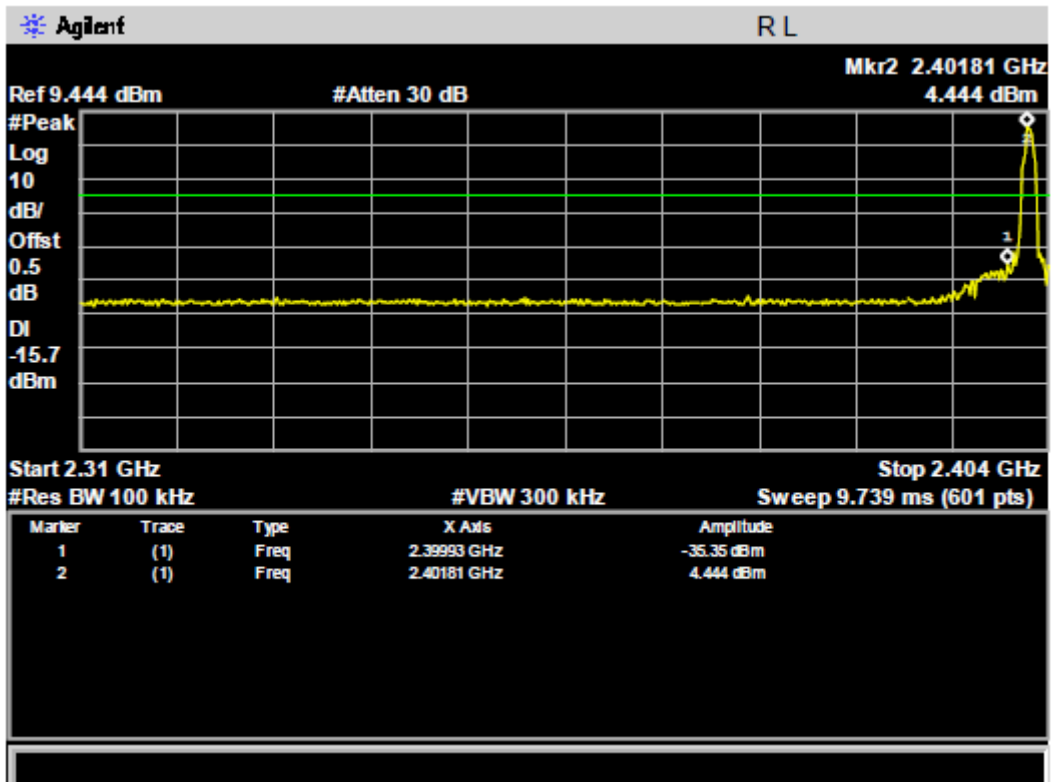

CH78

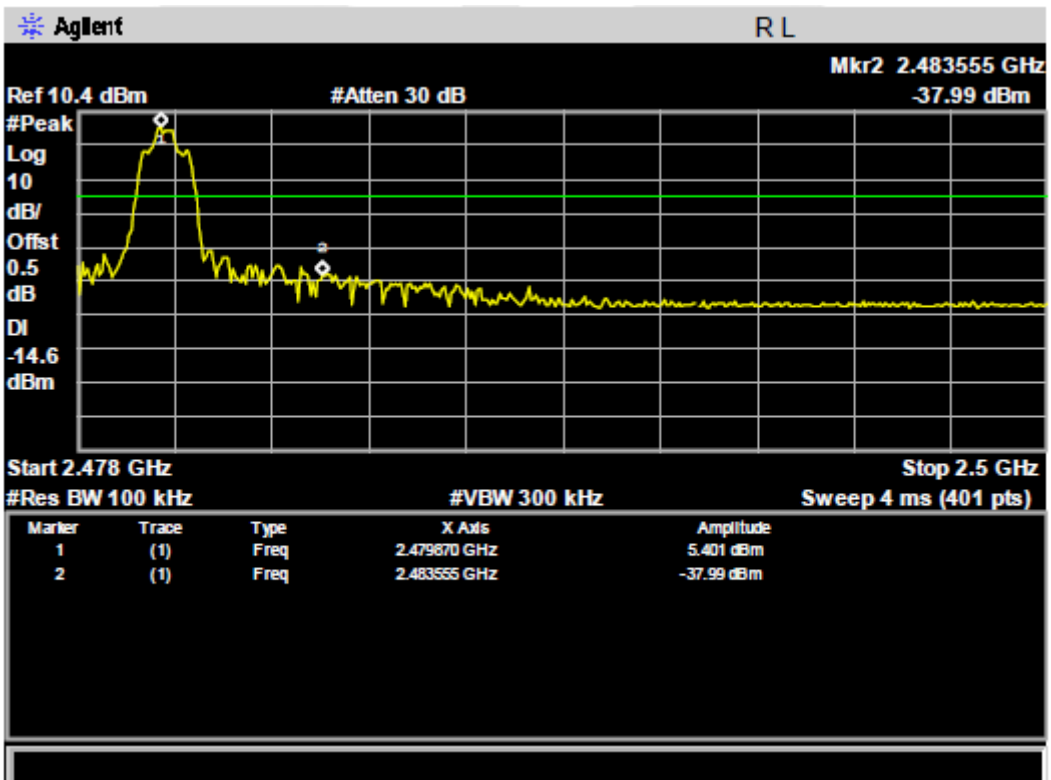

3Mbps:

CH0

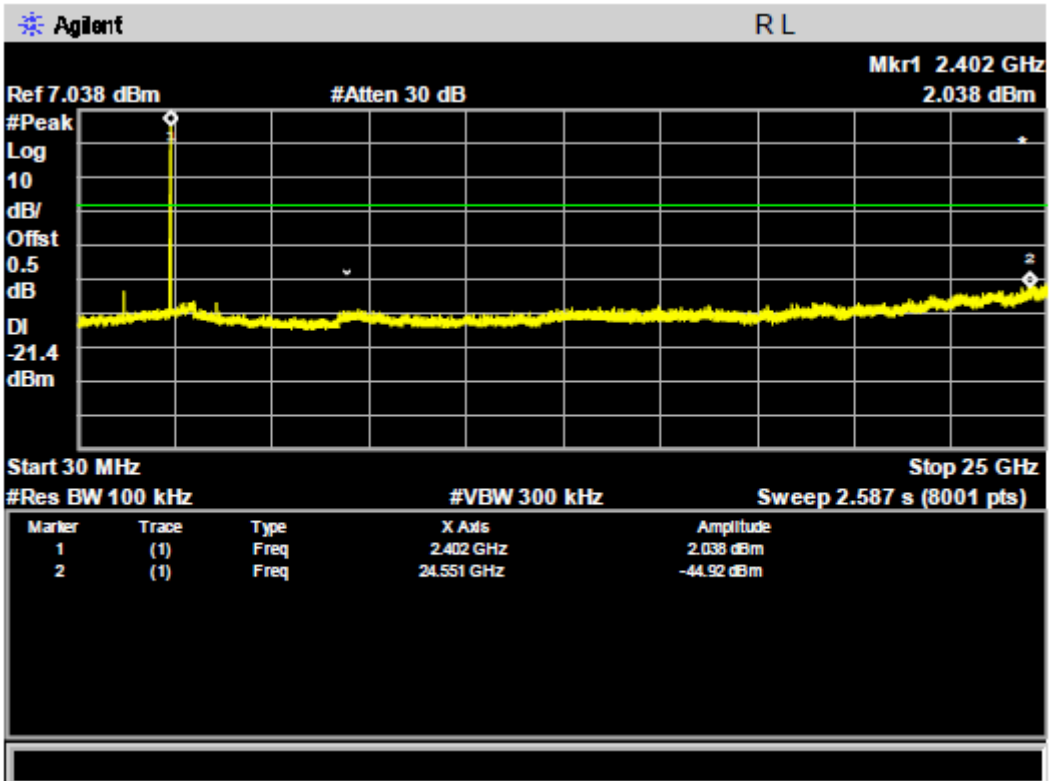

CH39

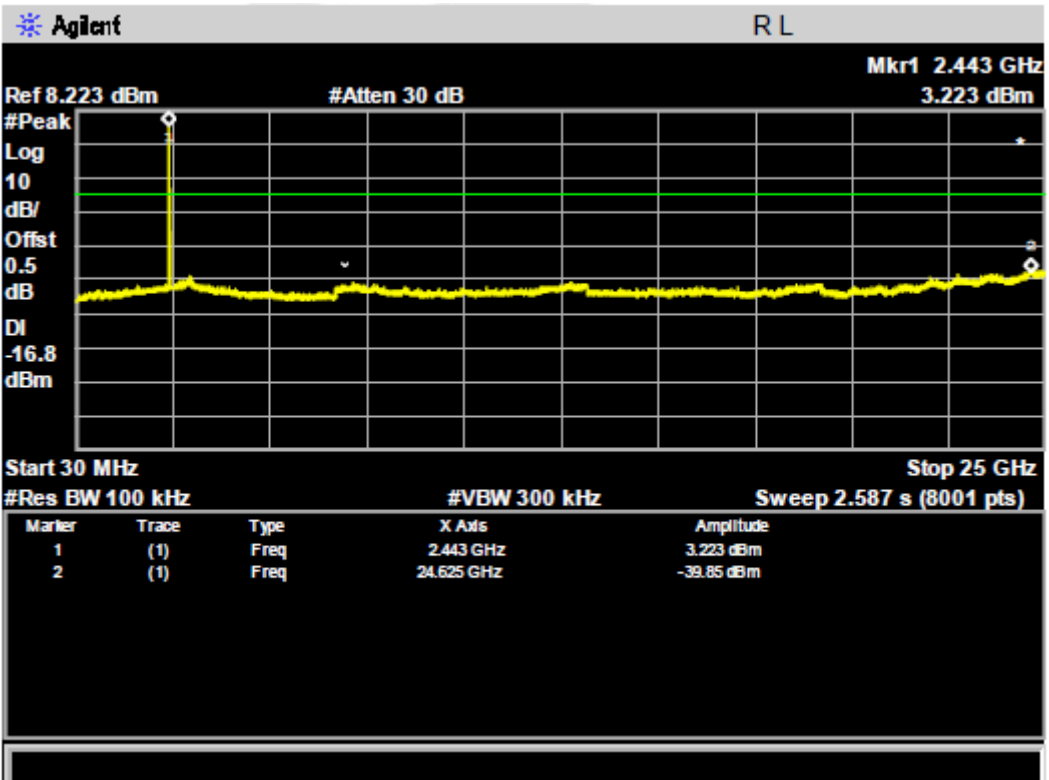

CH78

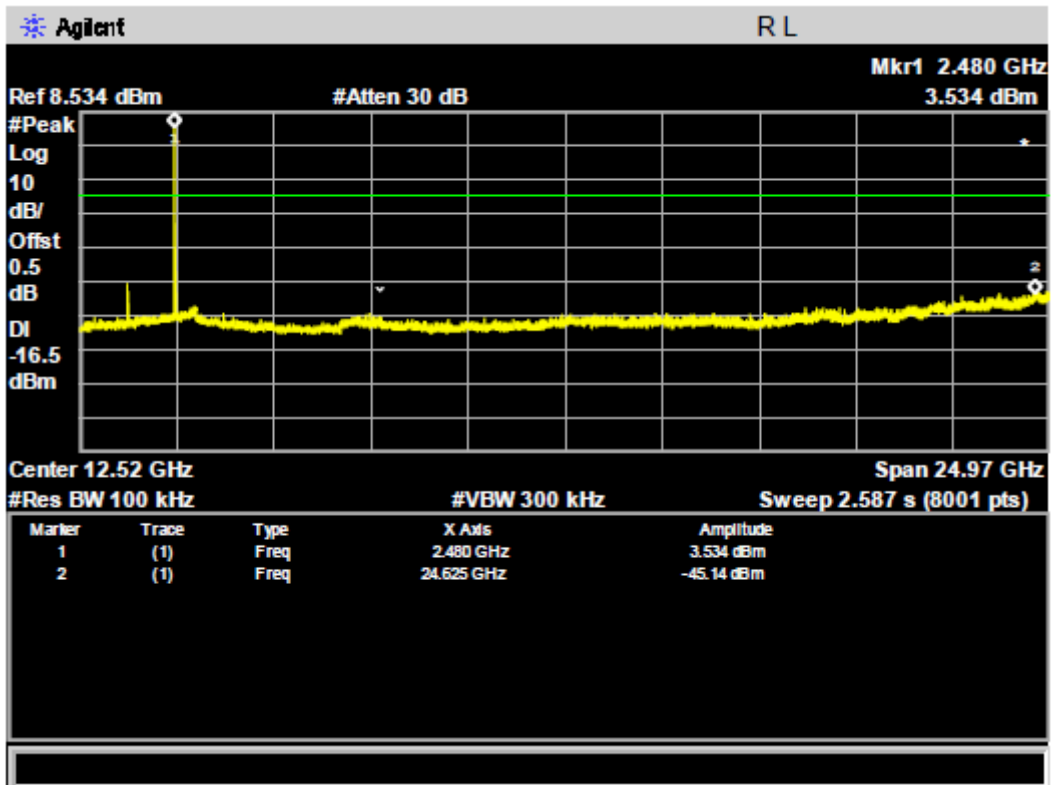

For Band Edge

CH0

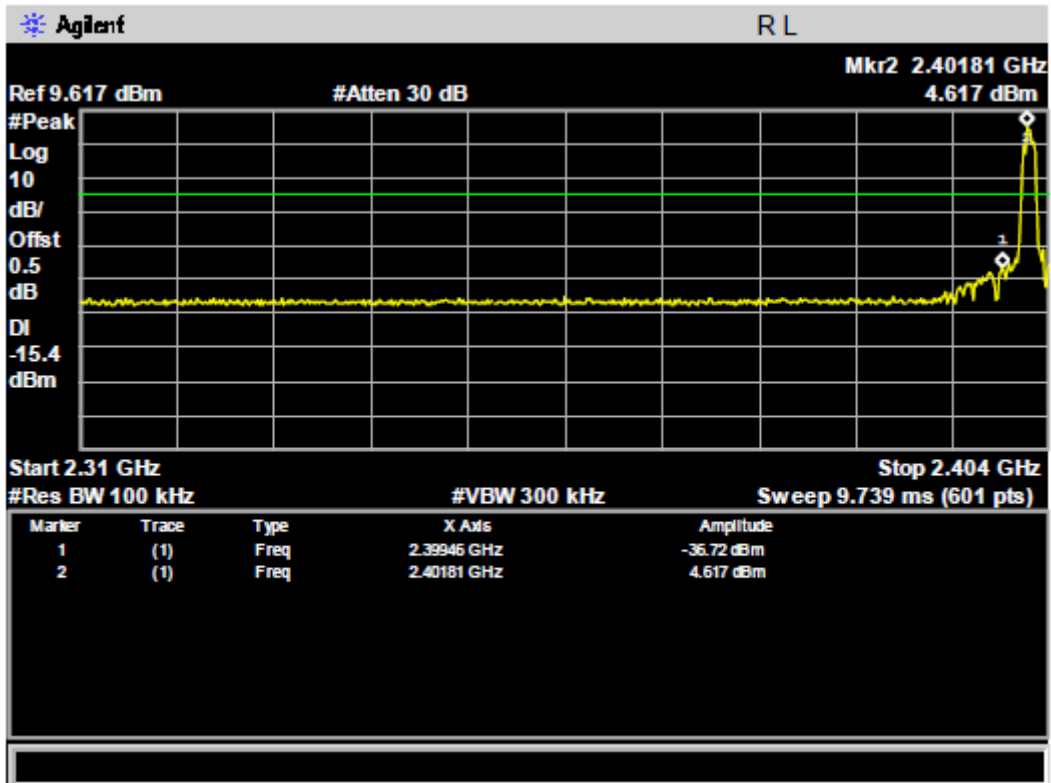

CH78

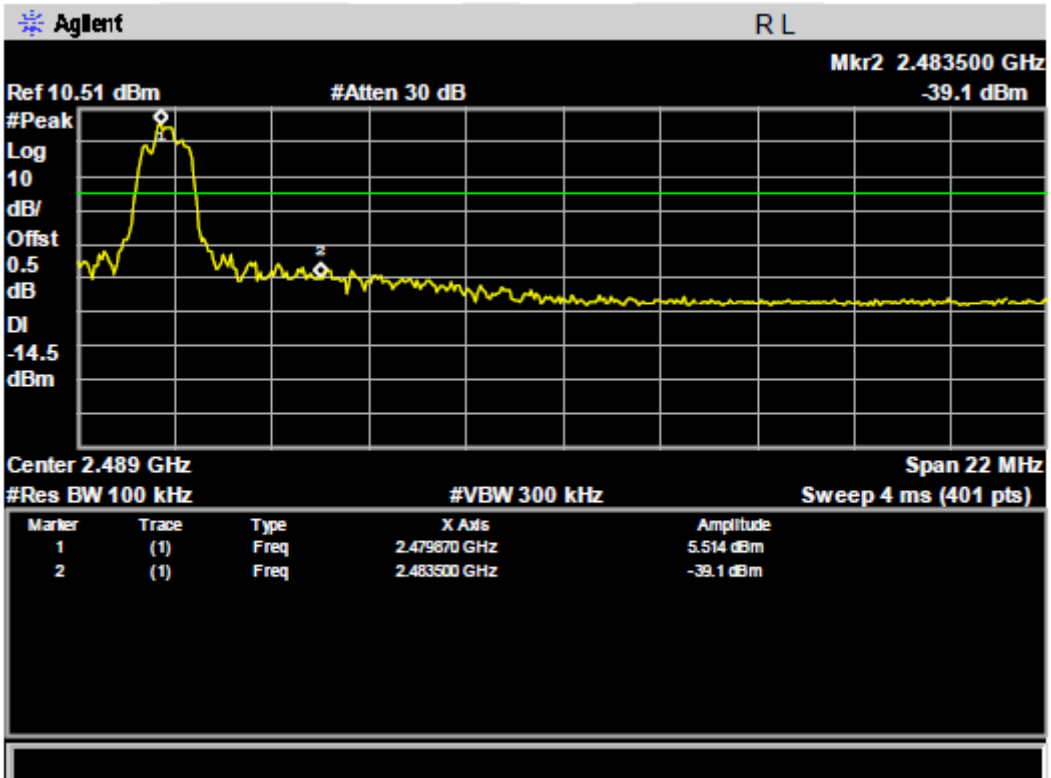

11. EUT TEST PHOTO

Radiated Measurement Photos

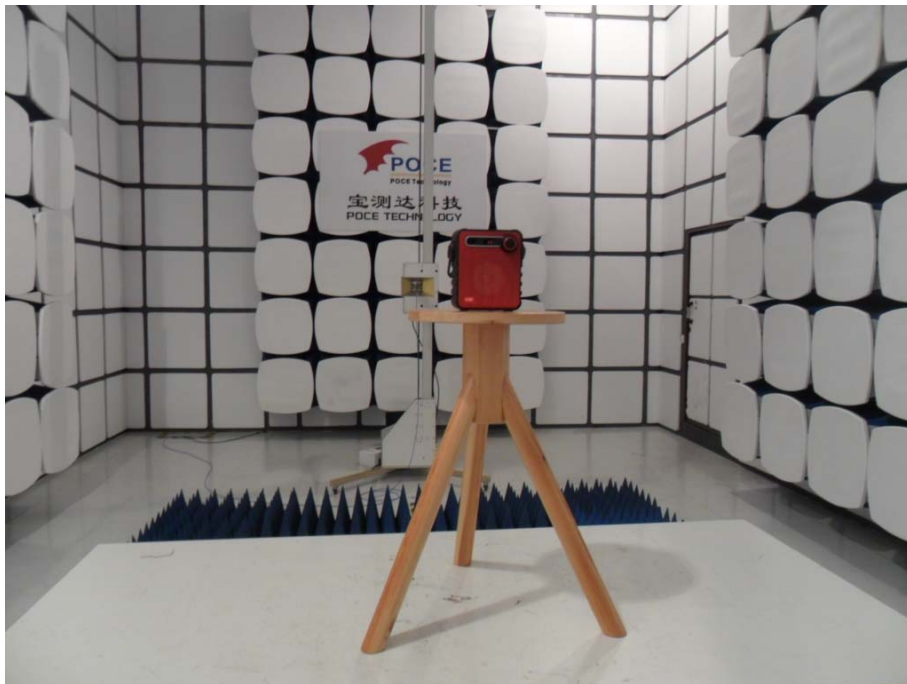
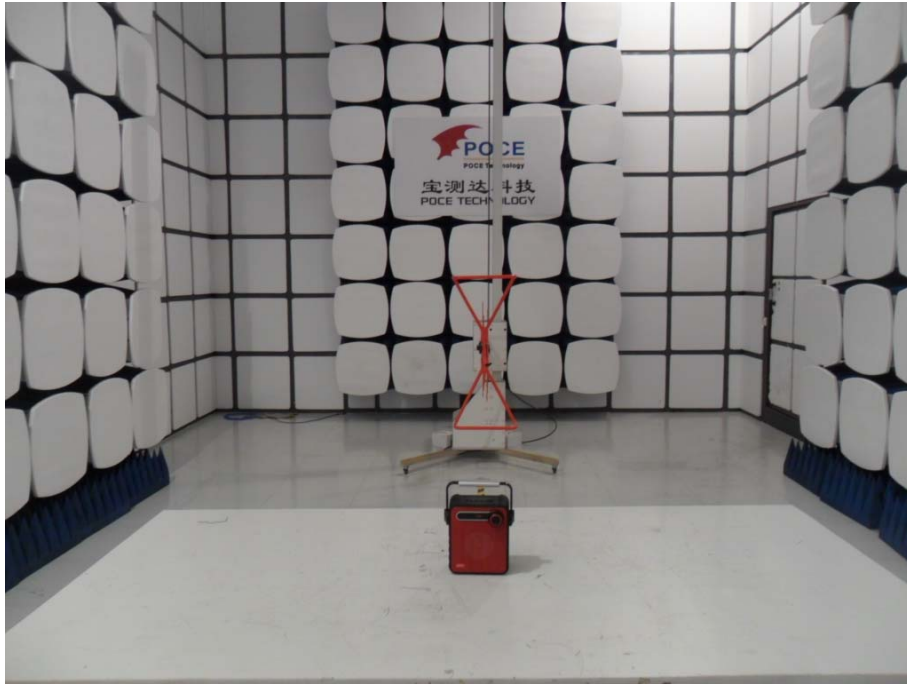

CONDUCTED EMISSION Photos

