

**CETECOM™**

**CETECOM ICT Services**  
consulting - testing - certification >>>

## TEST REPORT

Test report no.: 1-1364/16-01-06



Deutsche  
Akkreditierungsstelle  
D-PL-12076-01-01

### Testing laboratory

**CETECOM ICT Services GmbH**  
Untertuerkheimer Strasse 6 – 10  
66117 Saarbruecken / Germany  
Phone: + 49 681 5 98 - 0  
Fax: + 49 681 5 98 - 9075  
Internet: <http://www.cetecom.com>  
e-mail: [ict@cetecom.com](mailto:ict@cetecom.com)

#### Accredited Testing Laboratory:

The testing laboratory (area of testing) is accredited according to DIN EN ISO/IEC 17025 (2005) by the Deutsche Akkreditierungsstelle GmbH (DAkkS). The accreditation is valid for the scope of testing procedures as stated in the accreditation certificate with the registration number: D-PL-12076-01-01

### Applicant

**Continental Automotive GmbH**  
Heinrich-Hertz-Str. 45  
78052 Villingen-Schwenningen / GERMANY  
Phone: +49 7721 94 72-0  
Fax: +49 772 167-793069  
Contact: Tom Gollasch  
e-mail: [Tom.Gollasch@continental-corporation.com](mailto:Tom.Gollasch@continental-corporation.com)  
Phone: +49 772 167-3069

### Manufacturer

**Continental Automotive GmbH**  
Heinrich-Hertz-Str. 45  
78052 Villingen-Schwenningen / GERMANY

### Test standard/s

47 CFR Part 15 Title 47 of the Code of Federal Regulations; Chapter I; Part 15 - Radio frequency devices  
RSS - 247 Issue 1 Digital Transmission Systems (DTSS), Frequency Hopping Systems (FHSs) and Licence - Exempt Local Area Network (LE-LAN) Devices

For further applied test standards please refer to section 3 of this test report.

### Test Item

**Kind of test item:** Vehicle Data Recorder  
**Model name:** VDO RoadLog  
**FCC ID:** 2AHPQ-3290X  
**IC:** 21323-3290X  
**Frequency:** DTS band 2400 MHz to 2483.5 MHz  
**Technology tested:** Bluetooth® LE  
**Antenna:** Integrated PCB antenna  
**Power supply:** 12 V DC by battery  
**Temperature range:** -40°C to +85°C



This test report is electronically signed and valid without handwriting signature. For verification of the electronic signatures, the public keys can be requested at the testing laboratory.

### Test report authorized:

Marco Bertolino  
Lab Manager  
Radio Communications & EMC

### Test performed:

Mihail Dorongovskij  
Testing Manager  
Radio Communications & EMC

**1 Table of contents**

1 Table of contents .....2

2 General information .....3

    2.1 Notes and disclaimer .....3

    2.2 Application details.....3

3 Test standard/s and references .....3

4 Test environment.....5

5 Test item .....5

    5.1 General description .....5

    5.2 Additional information .....5

6 Test laboratories sub-contracted .....5

7 Description of the test setup .....6

    7.1 Shielded semi anechoic chamber.....7

    7.2 Shielded fully anechoic chamber .....8

    7.3 Radiated measurements > 18 GHz.....9

    7.4 Conducted measurements C.BER system.....10

8 Sequence of testing .....11

    8.1 Sequence of testing radiated spurious 9 kHz to 30 MHz.....11

    8.2 Sequence of testing radiated spurious 30 MHz to 1 GHz.....12

    8.3 Sequence of testing radiated spurious 1 GHz to 18 GHz .....13

    8.4 Sequence of testing radiated spurious above 18 GHz .....14

9 Measurement uncertainty .....15

10 Summary of measurement results .....16

11 Additional comments .....17

12 Measurement results .....18

    12.1 System gain.....18

    12.2 Power spectral density.....19

    12.3 DTS bandwidth – 6 dB bandwidth .....22

    12.4 Occupied bandwidth – 99% emission bandwidth.....25

    12.5 Maximum output power.....28

    12.6 Detailed spurious emissions @ the band edge - conducted .....31

    12.7 Band edge compliance radiated.....33

    12.8 TX spurious emissions conducted .....35

    12.9 Spurious emissions radiated below 30 MHz.....38

    12.10 Spurious emissions radiated 30 MHz to 1 GHz.....41

    12.11 Spurious emissions radiated above 1 GHz .....46

13 Observations .....56

Annex A Document history .....56

Annex B Further information.....56

Annex C Accreditation Certificate .....57

## 2 General information

### 2.1 Notes and disclaimer

The test results of this test report relate exclusively to the test item specified in this test report. CETECOM ICT Services GmbH does not assume responsibility for any conclusions and generalizations drawn from the test results with regard to other specimens or samples of the type of the equipment represented by the test item.

The test report may only be reproduced or published in full. Reproduction or publication of extracts from the report requires the prior written approval of CETECOM ICT Services GmbH.

The testing service provided by CETECOM ICT Services GmbH has been rendered under the current "General Terms and Conditions for CETECOM ICT Services GmbH".

CETECOM ICT Services GmbH will not be liable for any loss or damage resulting from false, inaccurate, inappropriate or incomplete product information provided by the customer.

Under no circumstances does the CETECOM ICT Services GmbH test report include any endorsement or warranty regarding the functionality, quality or performance of any other product or service provided.

Under no circumstances does the CETECOM ICT Services GmbH test report include or imply any product or service warranties from CETECOM ICT Services GmbH, including, without limitation, any implied warranties of merchantability, fitness for purpose, or non-infringement, all of which are expressly disclaimed by CETECOM ICT Services GmbH.

All rights and remedies regarding vendor's products and services for which CETECOM ICT Services GmbH has prepared this test report shall be provided by the party offering such products or services and not by CETECOM ICT Services GmbH.

In no case this test report can be considered as a Letter of Approval.

This test report is electronically signed and valid without handwritten signature. For verification of the electronic signatures, the public keys can be requested at the testing laboratory.

### 2.2 Application details

Date of receipt of order:	2016-04-13
Date of receipt of test item:	2016-05-02
Start of test:	2016-05-02
End of test:	2016-05-19
Person(s) present during the test:	Mr. Tom Gollasch

## 3 Test standard/s and references

Test standard	Date	Description
47 CFR Part 15	-/-	Title 47 of the Code of Federal Regulations; Chapter I; Part 15 - Radio frequency devices
RSS - 247 Issue 1	May 2015	Digital Transmission Systems (DTSs), Frequency Hopping Systems (FHSs) and Licence - Exempt Local Area Network (LE-LAN) Devices

<b>Guidance</b>	<b>Version</b>	<b>Description</b>
DTS: KDB 558074 D01	v03r05	Guidance for Performing Compliance Measurements on Digital Transmission Systems (DTS) Operating Under §15.247
ANSI C63.4-2014	-/-	American national standard for methods of measurement of radio-noise emissions from low-voltage electrical and electronic equipment in the range of 9 kHz to 40 GHz
ANSI C63.10-2013	-/-	American national standard of procedures for compliance testing of unlicensed wireless devices

#### 4 Test environment

Temperature	:	T <sub>nom</sub> T <sub>max</sub> T <sub>min</sub>	+22 °C during room temperature tests No tests under extreme conditions required. No tests under extreme conditions required.
Relative humidity content	:		55 %
Barometric pressure	:		not relevant for this kind of testing
Power supply	:	V <sub>nom</sub> V <sub>max</sub> V <sub>min</sub>	12.0 V DC by battery (by external power supply during tests) No tests under extreme conditions required. No tests under extreme conditions required.

#### 5 Test item

##### 5.1 General description

Kind of test item	:	Vehicle Data Recorder	
Type identification	:	VDO RoadLog	
HMN	:	RoadLog	
PMN	:	RoadLog	
HVIN	:	3290-A	
FVIN	:	2.22.9	
S/N serial number	:	Rad. 670160100065 Cond. 6701601000980	
HW hardware status	:	3290-A	
SW software status	:	2.22.9	
Frequency band	:	DTS band 2400 MHz to 2483.5 MHz (lowest channel 2402 MHz; highest channel 2480 MHz)	
Type of radio transmission	:	DSSS	
Use of frequency spectrum	:	DSSS	
Type of modulation	:	GFSK	
Number of channels	:	40	
Antenna	:	Integrated PCB antenna	
Power supply	:	12 V DC by battery	
Temperature range	:	-40°C to +85°C	

##### 5.2 Additional information

The content of the following annexes is defined in the QA. It may be that not all of the listed annexes are necessary for this report, thus some values in between may be missing.

Test setup- and EUT-photos are included in test report: 1-1364/16-01-01\_AnnexA  
 1-1364/16-01-01\_AnnexB  
 1-1364/16-01-01\_AnnexD

#### 6 Test laboratories sub-contracted

None

## 7 Description of the test setup

Typically, the calibrations of the test apparatus are commissioned to and performed by an accredited calibration laboratory. The calibration intervals are determined in accordance with the DIN EN ISO/IEC 17025. In addition to the external calibrations, the laboratory executes comparison measurements with other calibrated test systems or effective verifications. Weekly chamber inspections and range calibrations are performed. Where possible, RF generating and signaling equipment as well as measuring receivers and analyzers are connected to an external high-precision 10 MHz reference (GPS-based or rubidium frequency standard).

In order to simplify the identification of the equipment used at some special tests, some items of test equipment and ancillaries can be provided with an identifier or number in the equipment list below (Lab/Item).

### **Agenda:** Kind of Calibration

k	calibration / calibrated	EK	limited calibration
ne	not required (k, ev, izw, zw not required)	zw	cyclical maintenance (external cyclical maintenance)
ev	periodic self verification	izw	internal cyclical maintenance
Ve	long-term stability recognized	g	blocked for accredited testing
v/k!	Attention: extended calibration interval		
NK!	Attention: not calibrated	*)	next calibration ordered / currently in progress

### 7.1 Shielded semi anechoic chamber

The radiated measurements are performed in vertical and horizontal plane in the frequency range from 9 kHz to 1 GHz in semi-anechoic chambers. The EUT is positioned on a non-conductive support with a height of 0.80 m above a conductive ground plane that covers the whole chamber. The receiving antennas are confirmed with specifications ANSI C63. These antennas can be moved over the height range between 1.0 m and 4.0 m in order to search for maximum field strength emitted from EUT. The measurement distances between EUT and receiving antennas are indicated in the test setups for the various frequency ranges. For each measurement, the EUT is rotated in all three axes until the maximum field strength is received. The wanted and unwanted emissions are received by spectrum analyzers where the detector modes and resolution bandwidths over various frequency ranges are set according to requirement ANSI C63.

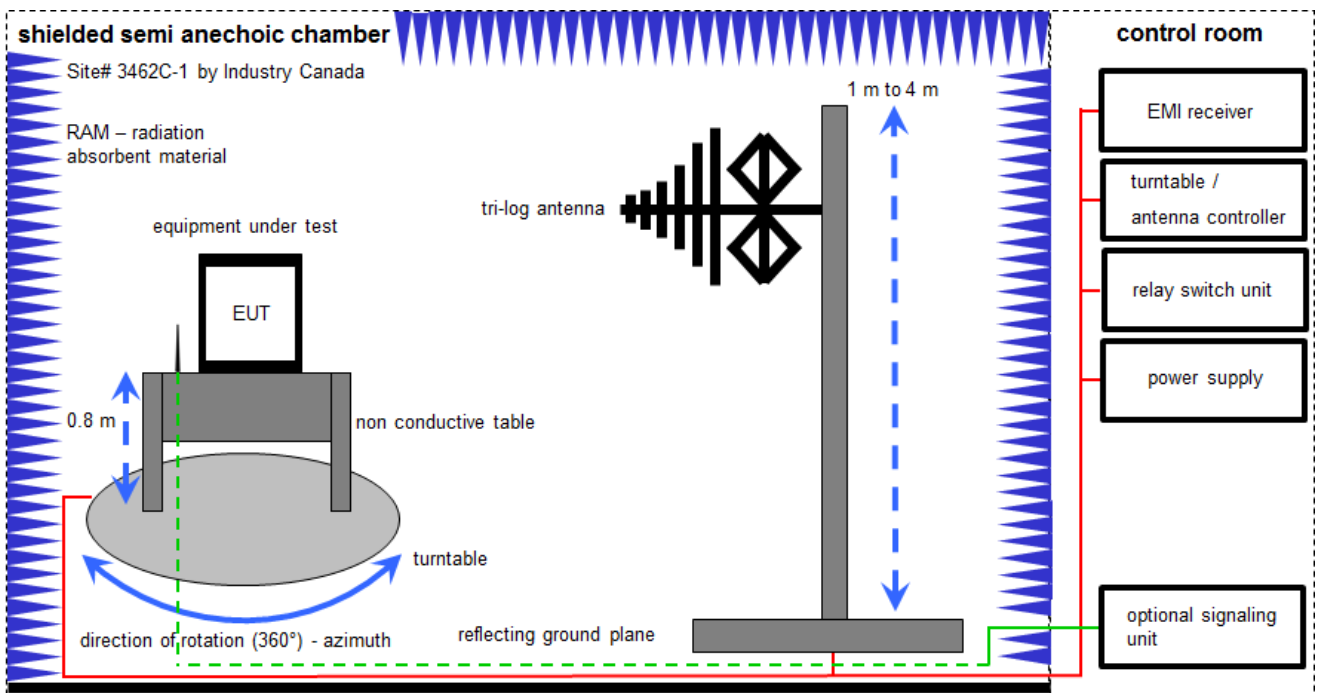

Measurement distance: tri-log antenna 10 meter

$$FS = UR + CL + AF$$

(FS-field strength; UR-voltage at the receiver; CL-loss of the cable; AF-antenna factor)

Example calculation:

$$FS [dB\mu V/m] = 12.35 [dB\mu V/m] + 1.90 [dB] + 16.80 [dB/m] = 31.05 [dB\mu V/m] (35.69 \mu V/m)$$

**Equipment table:**

No.	Lab / Item	Equipment	Type	Manufacturer	Serial No.	INV. No Cetecom	Kind of Calibration	Last Calibration	Next Calibration
1	A	Switch-Unit	3488A	HP	2719A14505	300000368	ev	-/-	-/-
2	A	DC power supply, 60Vdc, 50A, 1200 W	6032A	HP	2920A04466	300000580	ne	-/-	-/-
3	A	EMI Test Receiver	ESCI 3	R&S	100083	300003312	k	08.03.2016	08.03.2017
4	A	Antenna Tower	Model 2175	ETS-Lindgren	64762	300003745	izw	-/-	-/-
5	A	Positioning Controller	Model 2090	ETS-Lindgren	64672	300003746	izw	-/-	-/-
6	A	TRILOG Broadband Test-Antenna 30 MHz - 3 GHz	VULB9163	Schwarzbeck	295	300003787	k	25.04.2016	25.04.2018

## 7.2 Shielded fully anechoic chamber

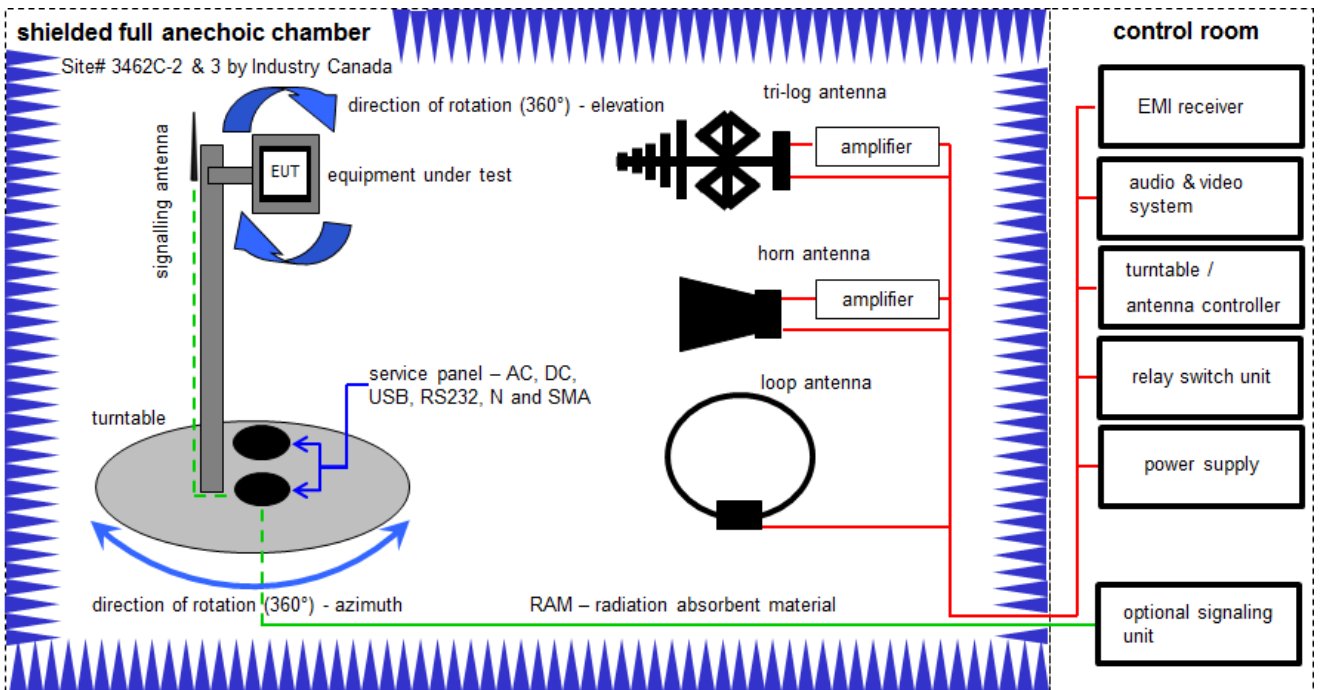

Measurement distance: tri-log antenna and horn antenna 3 meter; loop antenna 3 meter

$$FS = UR + CA + AF$$

(FS-field strength; UR-voltage at the receiver; CA-loss of the signal path; AF-antenna factor)

Example calculation:

$$FS [dB\mu V/m] = 40.0 [dB\mu V/m] + (-35.8) [dB] + 32.9 [dB/m] = 37.1 [dB\mu V/m] (71.61 \mu V/m)$$

### Equipment table:

No.	Lab / Item	Equipment	Type	Manufacturer	Serial No.	INV. No Cetecom	Kind of Calibration	Last Calibration	Next Calibration
1	A, B, C	DC power supply, 60Vdc, 50A, 1200 W	6032A	HP	2818A03450	300001040	Ve	20.01.2015	20.01.2018
2	A	Double-Ridged Waveguide Horn Antenna 1-18.0GHz	3115	EMCO	8812-3088	300001032	vIKI!	20.05.2015	20.05.2017
3	A, B, C	Anechoic chamber	FAC 3/5m	MWB / TDK	87400/02	300000996	ev	-/-	-/-
4	A, B, C	Switch / Control Unit	3488A	HP	*	300000199	ne	-/-	-/-
5	AC	Active Loop Antenna 10 kHz to 30 MHz	6502	EMCO/2	8905-2342	300000256	k	24.06.2015	24.06.2017
6	A	Amplifier	js42-00502650-28-5a	Parzich GMBH	928979	300003143	ne	-/-	-/-
7	A	Band Reject filter	WRCG2400/2483-2375/2505-50/10SS	Wainwright	11	300003351	ev	-/-	-/-
8	A	Highpass Filter	WHKX7.0/18G-8SS	Wainwright	18	300003789	ne	-/-	-/-
9	A, B	TRILOG Broadband Test-Antenna 30 MHz - 3 GHz	VULB9163	Schwarzbeck	371	300003854	vIKI!	29.10.2014	29.10.2017
10	A, B, C	4U RF Switch Platform	L4491A	Agilent Technologies	MY50000037	300004509	ne	-/-	-/-
11	A, B, C	EMI Test Receiver 9kHz-26,5GHz	ESR26	R&S	101376	300005063	k	04.09.2015	04.09.2016



### 7.3 Radiated measurements > 18 GHz

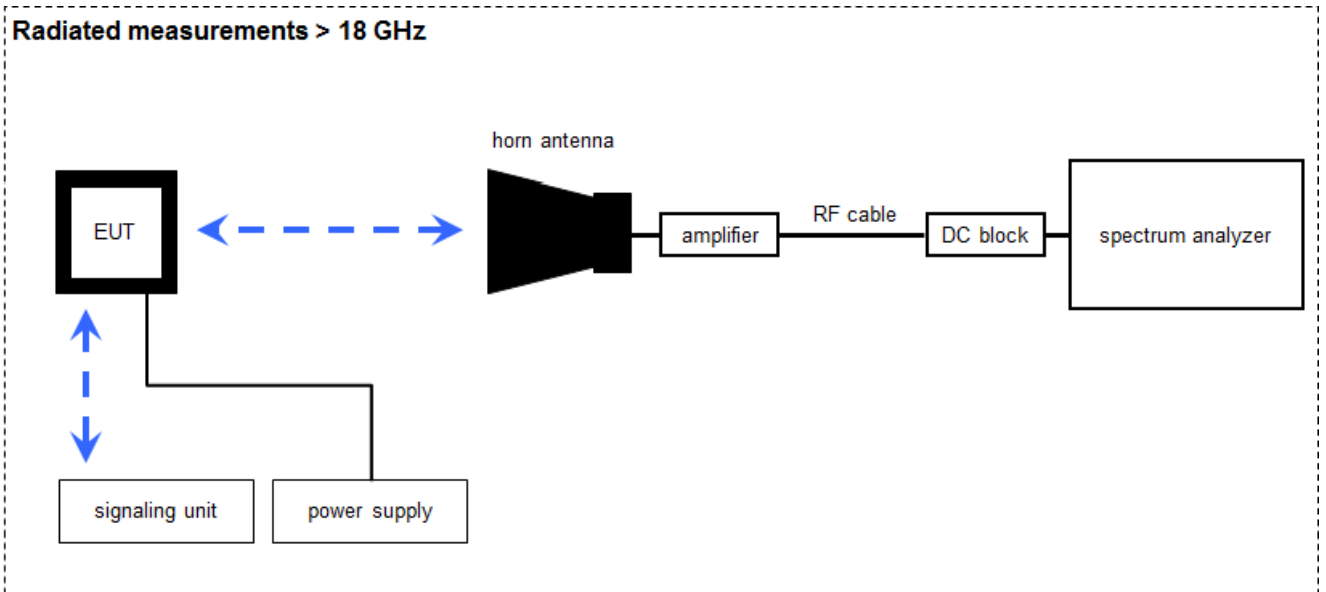

Measurement distance: horn antenna 50 cm

$$FS = U_R + CA + AF$$

(FS-field strength;  $U_R$ -voltage at the receiver; CA-loss signal path & distance correction; AF-antenna factor)

Example calculation:

$$FS [dB\mu V/m] = 40.0 [dB\mu V/m] + (-60.1) [dB] + 36.74 [dB/m] = 16.64 [dB\mu V/m] (6.79 \mu V/m)$$

#### Equipment table:

No.	Lab / Item	Equipment	Type	Manufacturer	Serial No.	INV. No Cetecom	Kind of Calibration	Last Calibration	Next Calibration
1	A	Std. Gain Horn Antenna 18.0 to 26.5 GHz	638	Narda	-/-	300000486	k	10.09.2015	10.09.2017
2	A	Signal Analyzer 40 GHz	FSV40	R&S	101042	300004517	k	21.01.2016	21.01.2017
3	A	Amplifier 2-40 GHz	JS32-02004000-57-5P	MITEQ	1777200	300004541	ev	-/-	-/-
4	A	DC Power Supply 0 - 32V	1108-32	Heiden Elektronik	001802	300001383	Ve	29.01.2014	29.01.2017
5	A	RF-Cable	ST18/SMAm/SMAm/60	Huber & Suhner	Batch no. 606844	400001181	ev	-/-	-/-
6	A	RF-Cable	ST18/SMAm/SMAm/48	Huber & Suhner	Batch no. 600918	400001182	ev	-/-	-/-

### 7.4 Conducted measurements C.BER system

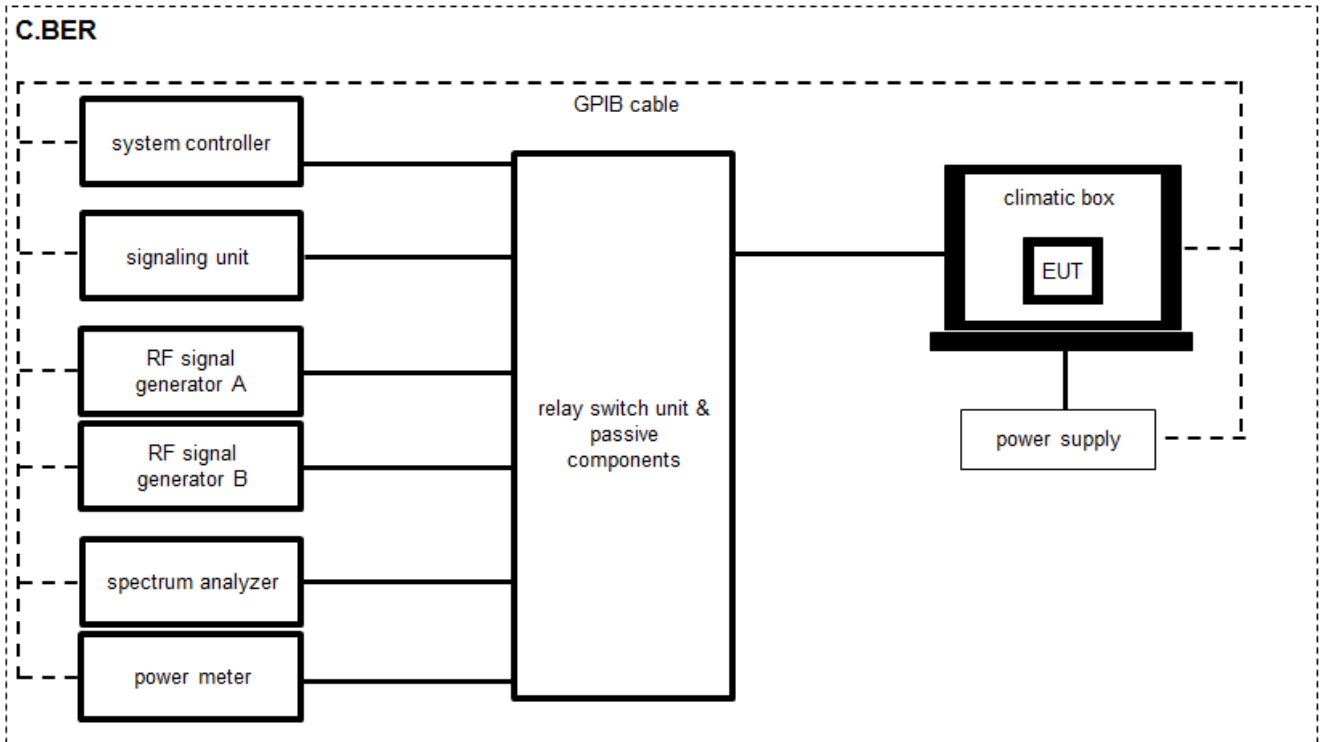

OP = AV + CA  
 (OP-output power; AV-analyzer value; CA-loss signal path)

Example calculation:  
 OP [dBm] = 6.0 [dBm] + 11.7 [dB] = 17.7 [dBm] (58.88 mW)

**Equipment table:**

No.	Lab / Item	Equipment	Type	Manufacturer	Serial No.	INV. No Cetecom	Kind of Calibration	Last Calibration	Next Calibration
1	A	Switch / Control Unit	3488A	HP		300000929	ne	-/-	-/-
2	A	System DC Power Supply	N5767A	Agilent Technologies	US14J1569P	300004851	vIKI!	04.09.2014	04.09.2016
3	A	Signal Analyzer 30GHz	FSV30	R&S	103170	300004855	k	25.01.2016	25.01.2017
4	A	DC-Blocker	8143	Inmet Corp.	none	300002842	ne	-/-	-/-
5	A	Powersplitter	6005-3	Inmet Corp.	none	300002841	ev	-/-	-/-
6	A	Temperature Test Chamber	VT 4002	Heraeus Voetsch	58566046820010	300003019	ev	03.09.2015	03.09.2017
7	A	RF-Cable	ST18/SMAm/SMAm/72	Huber & Suhner	Batch no. 605505	400001187	ev	-/-	-/-
8	A	RF-Cable	Sucoflex 104	Huber & Suhner	147636/4	400001188	ev	-/-	-/-

## 8 Sequence of testing

### 8.1 Sequence of testing radiated spurious 9 kHz to 30 MHz

#### Setup

- The equipment is set up to simulate normal operation mode as described in the user manual or defined by the manufacturer.
- If the EUT is a tabletop system, a 2-axis positioner with 1.5 m height is used.
- If the EUT is a floor standing device, it is placed directly on the turn table.
- Auxiliary equipment and cables are positioned to simulate normal operation conditions as described in ANSI C 63.4.
- The AC power port of the EUT (if available) is connected to a power outlet below the turntable.
- Measurement distance is 3 m (see ANSI C 63.4) – see test details.
- EUT is set into operation.

#### Premeasurement

- The turntable rotates from 0° to 315° using 45° steps.
- The antenna height is 1.5 m.
- At each turntable position the analyzer sweeps with positive-peak detector to find the maximum of all emissions.

#### Final measurement

- Identified emissions during the premeasurement are maximized by the software by rotating the turntable from 0° to 360°. In case of the 2-axis positioner is used the elevation axis is also rotated from 0° to 360°.
- The final measurement is done in the position (turntable and elevation) causing the highest emissions with quasi-peak (as described in ANSI C 63.4).
- Final levels, frequency, measuring time, bandwidth, turntable position, correction factor, margin to the limit and limit will be recorded. A plot with the graph of the premeasurement and the limit is stored.

## 8.2 Sequence of testing radiated spurious 30 MHz to 1 GHz

### Setup

- The equipment is set up to simulate normal operation mode as described in the user manual or defined by the manufacturer.
- If the EUT is a tabletop system, a table with 0.8 m height is used, which is placed on the ground plane.
- If the EUT is a floor standing device, it is placed on the ground plane with insulation between both.
- Auxiliary equipment and cables are positioned to simulate normal operation conditions as described in ANSI C 63.4.
- The AC power port of the EUT (if available) is connected to a power outlet below the turntable.
- Measurement distance is 10 m or 3 m (see ANSI C 63.4) – see test details.
- EUT is set into operation.

### Premeasurement

- The turntable rotates from 0° to 315° using 45° steps.
- The antenna is polarized vertical and horizontal.
- The antenna height changes from 1 m to 3 m.
- At each turntable position, antenna polarization and height the analyzer sweeps three times in peak to find the maximum of all emissions.

### Final measurement

- The final measurement is performed for at least six highest peaks according to the requirements of the ANSI C63.4.
- Based on antenna and turntable positions at which the peak values are measured the software maximize the peaks by changing turntable position  $\pm 45^\circ$  and antenna height between 1 and 4 m.
- The final measurement is done with quasi-peak detector (as described in ANSI C 63.4).
- Final levels, frequency, measuring time, bandwidth, antenna height, antenna polarization, turntable angle, correction factor, margin to the limit and limit are recorded. A plot with the graph of the premeasurement with marked maximum final results and the limit is stored.

### 8.3 Sequence of testing radiated spurious 1 GHz to 18 GHz

#### Setup

- The equipment is set up to simulate normal operation mode as described in the user manual or defined by the manufacturer.
- If the EUT is a tabletop system, a 2-axis positioner with 1.5 m height is used.
- If the EUT is a floor standing device, it is placed directly on the turn table.
- Auxiliary equipment and cables are positioned to simulate normal operation conditions as described in ANSI C 63.4.
- The AC power port of the EUT (if available) is connected to a power outlet below the turntable.
- Measurement distance is 3 m (see ANSI C 63.4) – see test details.
- EUT is set into operation.

#### Premeasurement

- The turntable rotates from 0° to 315° using 45° steps.
- The antenna is polarized vertical and horizontal.
- The antenna height is 1.5 m.
- At each turntable position and antenna polarization the analyzer sweeps with positive peak detector to find the maximum of all emissions.

#### Final measurement

- The final measurement is performed for at least six highest peaks according to the requirements of the ANSI C63.4.
- Based on antenna and turntable positions at which the peak values are measured the software maximizes the peaks by rotating the turntable from 0° to 360°. This measurement is repeated for different EUT-table positions (0° to 150° in 30°-steps) and for both antenna polarizations.
- The final measurement is done in the position (turntable, EUT-table and antenna polarization) causing the highest emissions with Peak and RMS detector (as described in ANSI C 63.4).
- Final levels, frequency, measuring time, bandwidth, turntable position, EUT-table position, antenna polarization, correction factor, margin to the limit and limit are recorded. A plot with the graph of the premeasurement with marked maximum final results and the limit is stored.

## 8.4 Sequence of testing radiated spurious above 18 GHz

### Setup

- The equipment is set up to simulate normal operation mode as described in the user manual or defined by the manufacturer.
- Auxiliary equipment and cables are positioned to simulate normal operation conditions as described in ANSI C 63.4.
- The AC power port of the EUT (if available) is connected to a power outlet.
- The measurement distance is as appropriate (e.g. 0.5 m).
- The EUT is set into operation.

### Premeasurement

- The test antenna is handheld and moved carefully over the EUT to cover the EUT's whole sphere and different polarizations of the antenna.

### Final measurement

- The final measurement is performed at the position and antenna orientation causing the highest emissions with Peak and RMS detector (as described in ANSI C 63.4).
- Final levels, frequency, measuring time, bandwidth, correction factor, margin to the limit and limit are recorded. A plot with the graph of the premeasurement and the limit is stored.

**9 Measurement uncertainty**

<b>Measurement uncertainty</b>	
<b>Test case</b>	<b>Uncertainty</b>
Antenna gain	± 3 dB
Spectrum bandwidth	± 21.5 kHz absolute; ± 15.0 kHz relative
Maximum output power	± 1 dB
Detailed conducted spurious emissions @ the band edge	± 1 dB
Band edge compliance radiated	± 3 dB
Spurious emissions conducted	± 3 dB
Spurious emissions radiated below 30 MHz	± 3 dB
Spurious emissions radiated 30 MHz to 1 GHz	± 3 dB
Spurious emissions radiated 1 GHz to 12.75 GHz	± 3.7 dB
Spurious emissions radiated above 12.75 GHz	± 4.5 dB
Spurious emissions conducted below 30 MHz (AC conducted)	± 2.6 dB

## 10 Summary of measurement results

<input checked="" type="checkbox"/>	No deviations from the technical specifications were ascertained
<input type="checkbox"/>	There were deviations from the technical specifications ascertained
<input type="checkbox"/>	This test report is only a partial test report. The content and verdict of the performed test cases are listed below.

TC Identifier	Description	Verdict	Date	Remark
RF-Testing	CFR Part 15 RSS - 247, Issue 1	See table!	2016-05-27	-/-

Test specification clause	Test case	Guideline	Temperature conditions	Power source voltages	Mode	C	NC	NA	NP	Remark
§15.247(b)(4) RSS - 247 / 5.4 (4)	System gain	-/-	Nominal	Nominal	GFSK	<input checked="" type="checkbox"/>	<input type="checkbox"/>	<input type="checkbox"/>	<input type="checkbox"/>	-/-
§15.247(e) RSS - 247 / 5.2 (2)	Power spectral density	KDB 558074 DTS clause: 10.6	Nominal	Nominal	GFSK	<input checked="" type="checkbox"/>	<input type="checkbox"/>	<input type="checkbox"/>	<input type="checkbox"/>	-/-
§15.247(a)(2) RSS - 247 / 5.2 (1)	DTS bandwidth – 6 dB bandwidth	KDB 558074 DTS clause: 8.1	Nominal	Nominal	GFSK	<input checked="" type="checkbox"/>	<input type="checkbox"/>	<input type="checkbox"/>	<input type="checkbox"/>	-/-
RSS Gen clause 4.6.1	Occupied bandwidth	-/-	Nominal	Nominal	GFSK	<input checked="" type="checkbox"/>	<input type="checkbox"/>	<input type="checkbox"/>	<input type="checkbox"/>	-/-
§15.247(b)(3) RSS - 247 / 5.4 (4)	Maximum output power	KDB 558074 DTS clause: 9.1.1	Nominal	Nominal	GFSK	<input checked="" type="checkbox"/>	<input type="checkbox"/>	<input type="checkbox"/>	<input type="checkbox"/>	-/-
§15.247(d) RSS - 247 / 5.5	Detailed spurious emissions @ the band edge - conducted	-/-	Nominal	Nominal	GFSK	<input checked="" type="checkbox"/>	<input type="checkbox"/>	<input type="checkbox"/>	<input type="checkbox"/>	-/-
§15.205 RSS - 247 / 5.5 RSS - Gen	Band edge compliance radiated	KDB 558074 DTS clause: 13.3.2	Nominal	Nominal	GFSK	<input checked="" type="checkbox"/>	<input type="checkbox"/>	<input type="checkbox"/>	<input type="checkbox"/>	-/-
§15.247(d) RSS - 247 / 5.5	TX spurious emissions conducted	KDB 558074 DTS clause: 11.1 & 11.2 11.3	Nominal	Nominal	GFSK	<input checked="" type="checkbox"/>	<input type="checkbox"/>	<input type="checkbox"/>	<input type="checkbox"/>	-/-
§15.209(a) RSS - Gen	Spurious emissions radiated below 30 MHz	-/-	Nominal	Nominal	GFSK	<input checked="" type="checkbox"/>	<input type="checkbox"/>	<input type="checkbox"/>	<input type="checkbox"/>	-/-
15.247(d) RSS - 247 / 5.5 §15.109 RSS - Gen	Spurious emissions radiated 30 MHz to 1 GHz	-/-	Nominal	Nominal	-/-	<input checked="" type="checkbox"/>	<input type="checkbox"/>	<input type="checkbox"/>	<input type="checkbox"/>	-/-
§15.247(d) RSS - 247 / 5.5 §15.109 RSS - Gen	Spurious emissions radiated above 1 GHz	-/-	Nominal	Nominal	GFSK	<input checked="" type="checkbox"/>	<input type="checkbox"/>	<input type="checkbox"/>	<input type="checkbox"/>	-/-
§15.107(a) §15.207	Conducted emissions below 30 MHz (AC conducted)	-/-	Nominal	Nominal	GFSK	<input type="checkbox"/>	<input type="checkbox"/>	<input checked="" type="checkbox"/>	<input type="checkbox"/>	-/-

**Note:** C = Compliant; NC = Not compliant; NA = Not applicable; NP = Not performed



## 11 Additional comments

The Bluetooth® word mark and logos are owned by the Bluetooth SIG Inc. and any use of such marks by Cetecom ICT Services GmbH is under license.

Reference documents: None

Special test descriptions: None

Configuration descriptions: TX tests: were performed with LE packets (37 byte payload) and static PRBS pattern.  
RX/Standby tests: BT enabled, TX Idle  
tested channels: lowest: 2402 MHz (Ch 0)  
middle: 2440 MHz (Ch 19)  
- highest: 2480 MHz (Ch 39)

Test mode:

- Bluetooth LE Test mode enabled  
(EUT is controlled over CBT)
- Special software is used.  
EUT is transmitting pseudo random data by itself

## 12 Measurement results

### 12.1 System gain

**Measurement:**

The antenna gain of the complete system is calculated by the difference of radiated power in EIRP and the conducted power of the module. For normal Bluetooth® devices, the GFSK modulation is used.

Measurement parameters	
Detector	Peak
Sweep time	Auto
Resolution bandwidth	3 MHz
Video bandwidth	3 MHz
Span	5 MHz
Trace mode	Max hold
Test setup	See sub clause 7.2 B (radiated) See sub clause 7.4 A (conducted)
Measurement uncertainty	See sub clause 9

**Limits:**

FCC	IC
6 dBi / > 6 dBi output power and power density reduction required	

**Results:**

T <sub>nom</sub>	V <sub>nom</sub>	2402 MHz	2440 MHz	2480 MHz
Conducted power [dBm] Measured with GFSK modulation		4.8	5.1	5.6
Radiated power [dBm] Measured with GFSK modulation		10.7	13.3	11.7
Gain [dBi] Calculated		5.9	8.2	6.1

## 12.2 Power spectral density

**Description:**

Measurement of the power spectral density of a digital modulated system.

Measurement parameters	
Detector	Peak
Sweep time	Auto
Resolution bandwidth	3 kHz
Video bandwidth	10 kHz
Span	≥ EBW
Trace mode	Max hold
Test setup	See sub clause 7.4 A
Measurement uncertainty	See sub clause 9

**Limits:**

FCC	IC
Power spectral density	
For digitally modulated systems the transmitter power spectral density conducted from the transmitter to the antenna shall not be greater than 8 dBm in any 3 kHz band during any time interval of continuous transmission or over 1.0 second if the transmission exceeds 1.0-second duration.	

**Results:**

	Frequency		
	2402 MHz	2440 MHz	2480 MHz
Power spectral density [dBm / 3kHz]	-10.9	-10.3	-10.5

**Plots:**

**Plot 1: lowest channel**

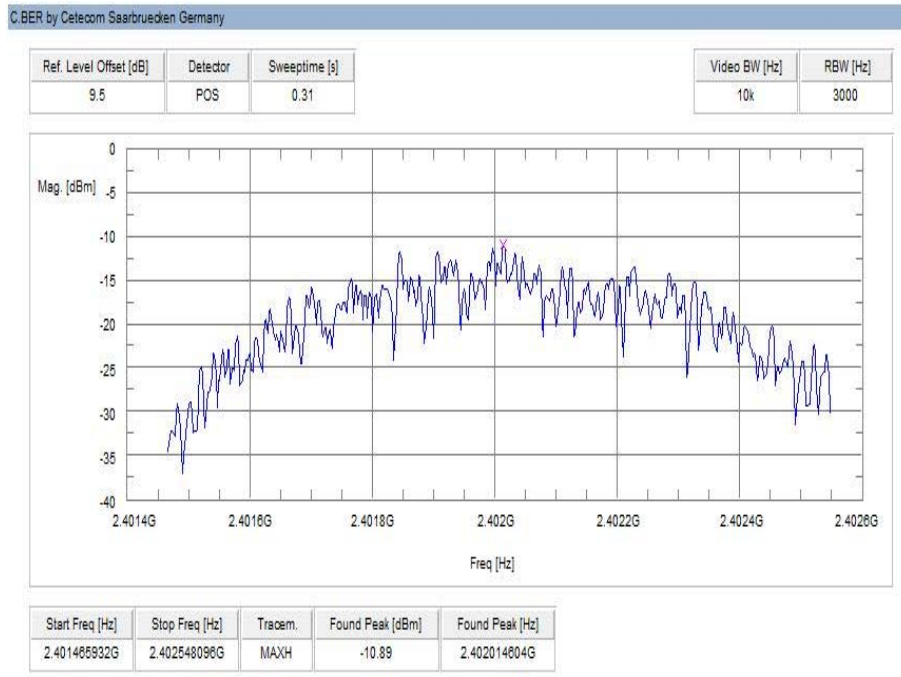

**Plot 2: mid channel**

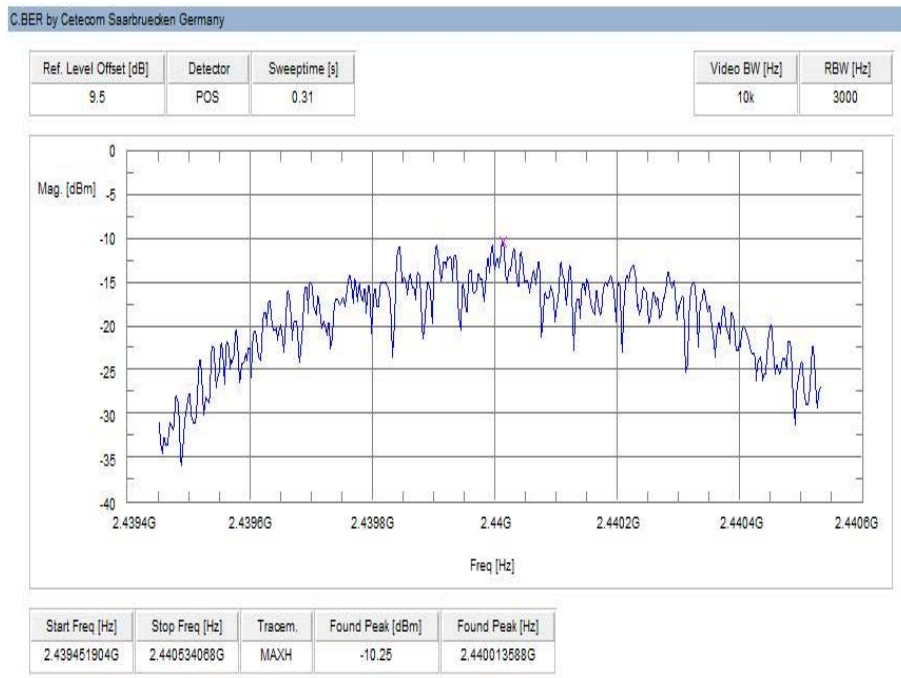

Plot 3: highest channel

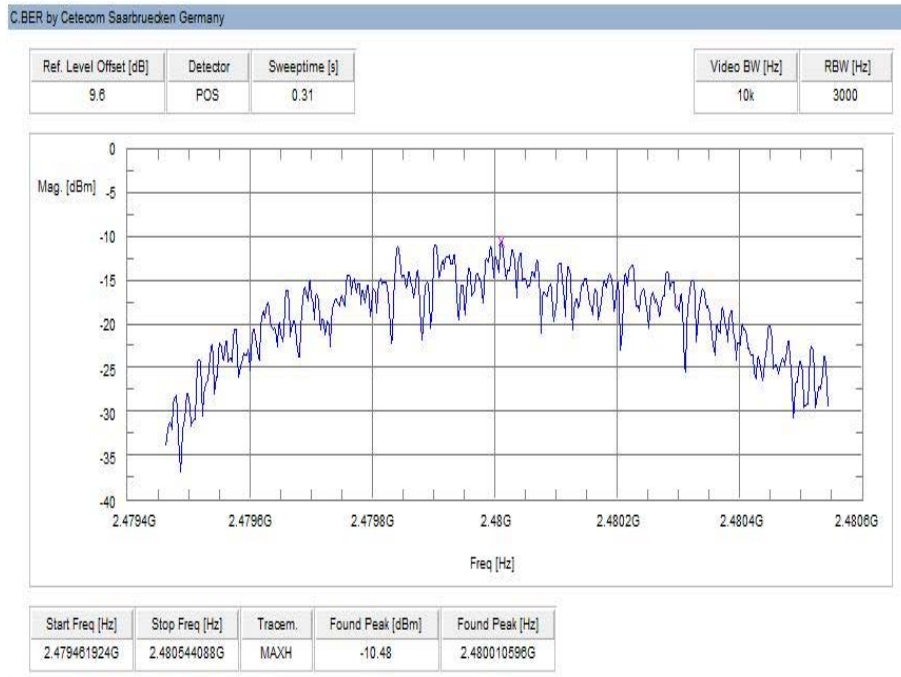

### 12.3 DTS bandwidth – 6 dB bandwidth

#### Description:

Measurement of the 6 dB bandwidth of the modulated signal.

Measurement parameters	
According to DTS clause: 8.1	
Detector	Peak
Sweep time	Auto
Resolution bandwidth	100 kHz
Video bandwidth	300 kHz
Span	5 MHz
Measurement procedure	Using 3 marker (max + 2x-6dB)
Trace mode	Max hold (allow trace to stabilize)
Test setup	See sub clause 7.4 A
Measurement uncertainty	See sub clause 9

#### Limits:

FCC	IC
DTS bandwidth – 6 dB bandwidth	
Systems using digital modulation techniques may operate in the 2400–2483.5 MHz band. The minimum 6 dB bandwidth shall be at least 500 kHz.	

#### Results:

	Frequency		
	2402 MHz	2440 MHz	2480 MHz
6 dB bandwidth [kHz]	721	721	721

**Plots:**

**Plot 1: lowest channel**

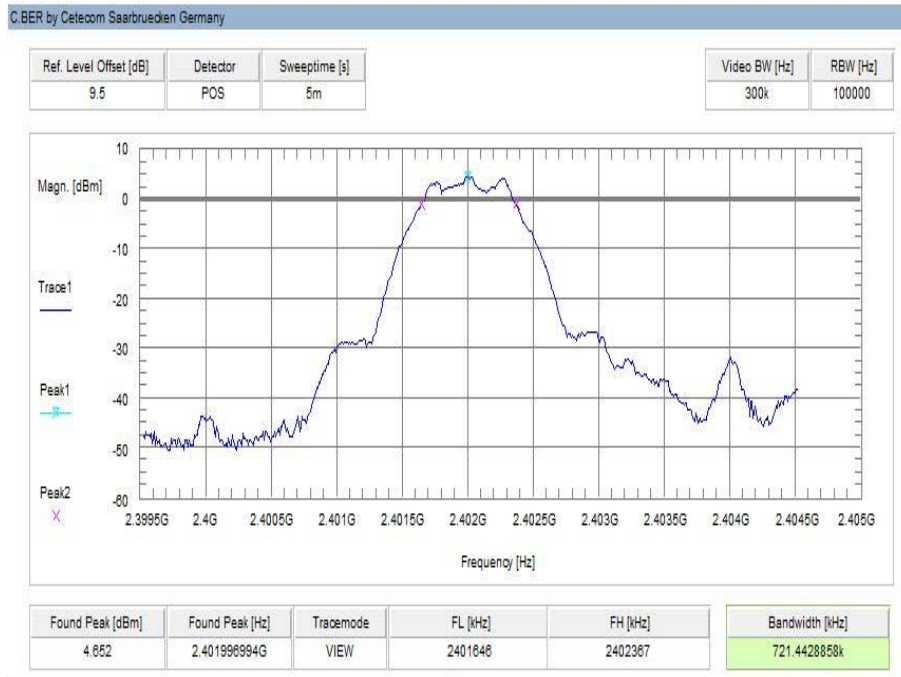

**Plot 2: mid channel**

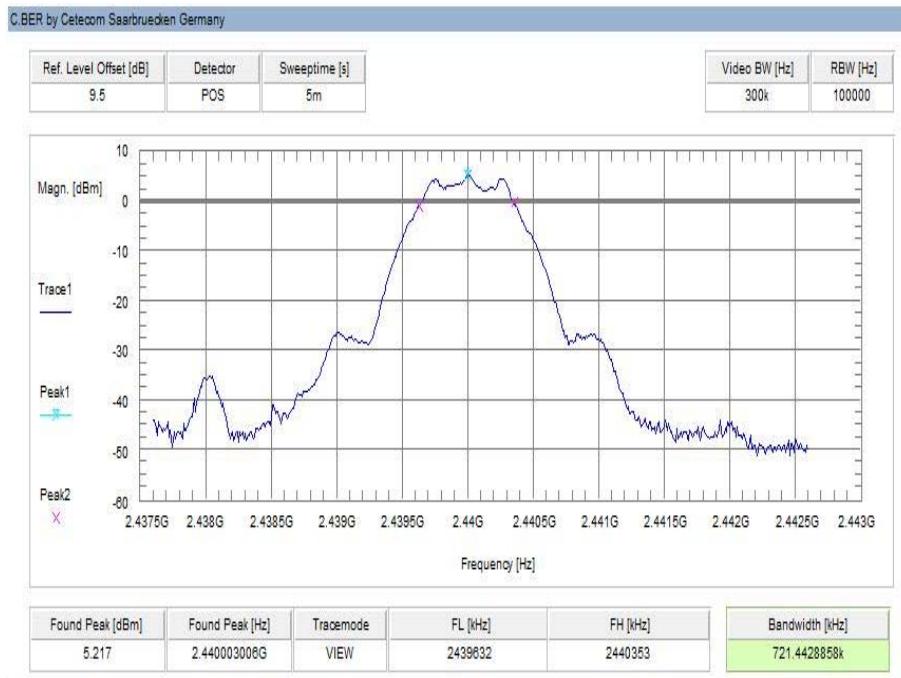

Plot 3: highest channel

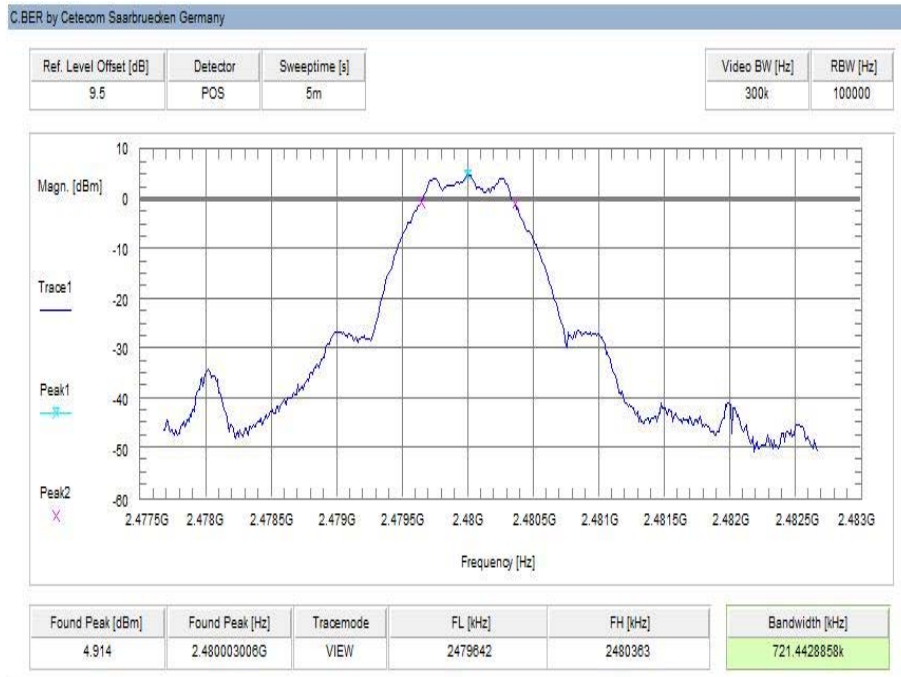



## 12.4 Occupied bandwidth – 99% emission bandwidth

**Description:**

Measurement of the 99% bandwidth of the modulated signal acc. RSS-GEN.

Measurement parameters	
Detector	Peak
Sweep time	Auto
Resolution bandwidth	30 kHz
Video bandwidth	100 kHz
Span	5 MHz
Measurement procedure	Measurement of the 99% bandwidth using the integration function of the analyzer
Trace mode	Max hold (allow trace to stabilize)
Test setup	See sub clause 7.4 A
Measurement uncertainty	See sub clause 9

**Usage:**

-/-	IC
Occupied bandwidth – 99% emission bandwidth	
OBW is necessary for emission designator	

**Results:**

	Frequency		
	2402 MHz	2440 MHz	2480 MHz
<b>99% bandwidth [kHz]</b>	1032	1032	1022

**Plots:**

**Plot 1: lowest channel**

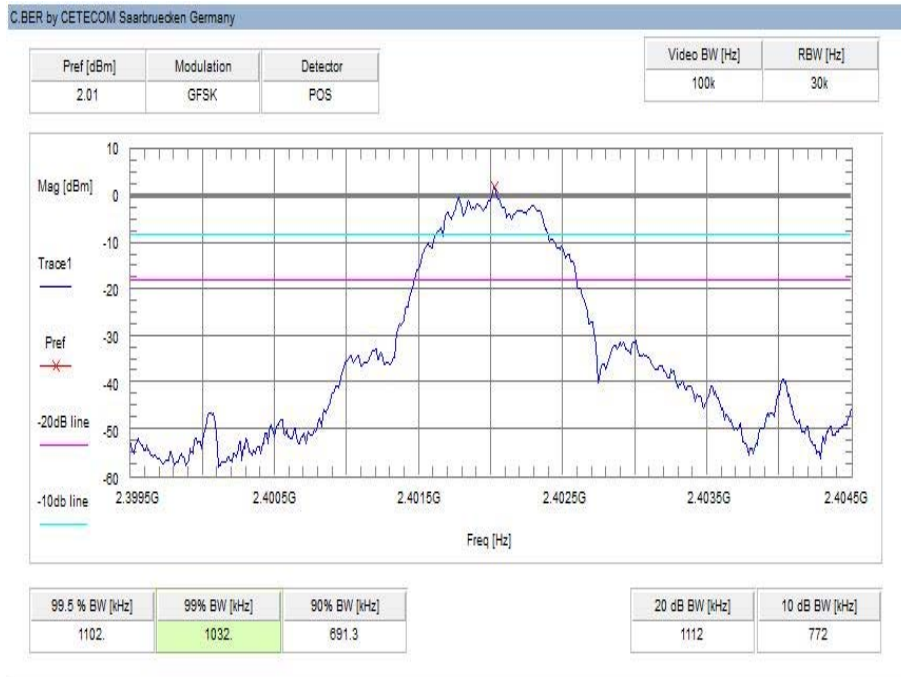

**Plot 2: mid channel**

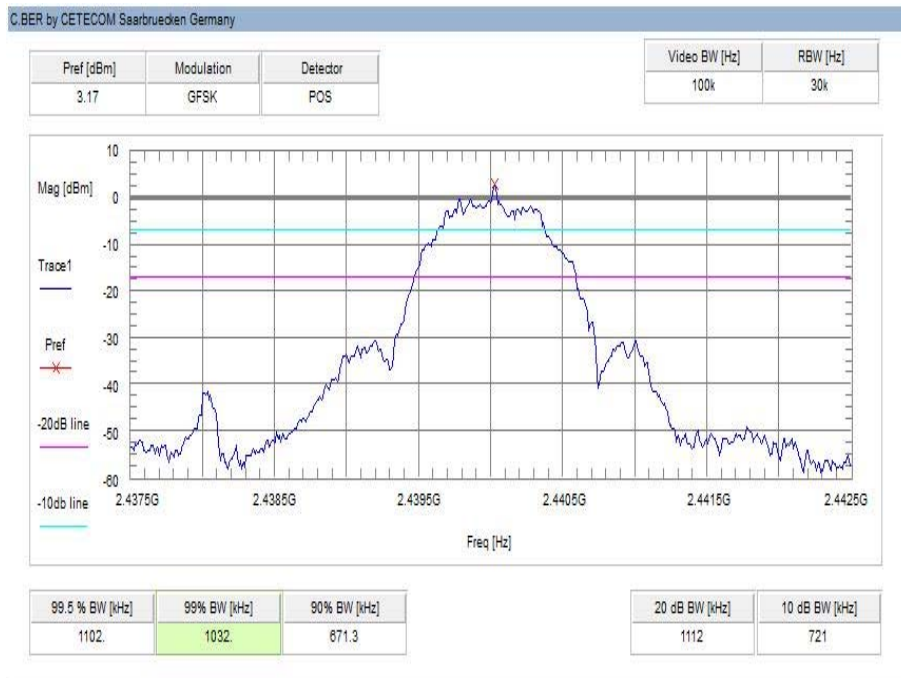

Plot 3: highest channel

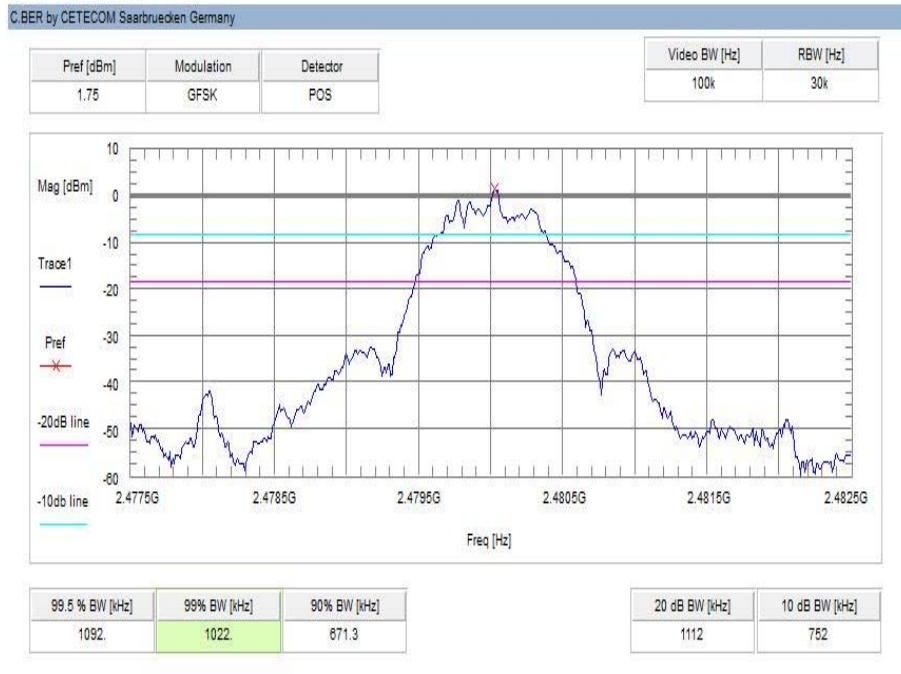

## 12.5 Maximum output power

### Description:

Measurement of the maximum output power conducted and radiated. EUT in single channel mode.

Measurement parameters	
Detector	Peak
Sweep time	Auto
Resolution bandwidth	3 MHz
Video bandwidth	10 MHz
Span	10 MHz
Trace mode	Max hold
Test setup	See sub clause 7.4 A
Measurement uncertainty	See sub clause 9

### Limits:

FCC	IC
Maximum output power	
[Conducted: 0.125 W – antenna gain max. 6 dBi] Systems using more than 75 hopping channels: Conducted: 1.0 W – antenna gain max. 6 dBi	

### Results:

	Frequency		
	2402 MHz	2440 MHz	2480 MHz
<b>Maximum output power conducted [dBm]</b>	4.9	5.3	5.5

	Frequency		
	2402 MHz	2440 MHz	2480 MHz
<b>Maximum output power radiated - EIRP [dBm]</b>	10.8	13.5	11.6

\*) - Values calculated with antenna gain

**Plots:**

**Plot 1: lowest channel**



**Plot 2: mid channel**

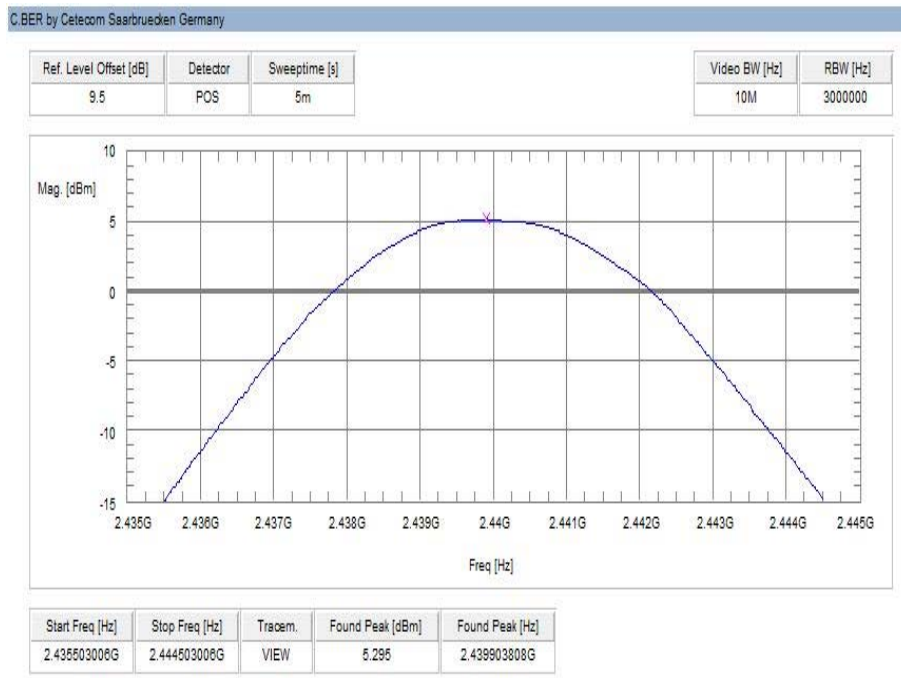

**Plot 3: highest channel**

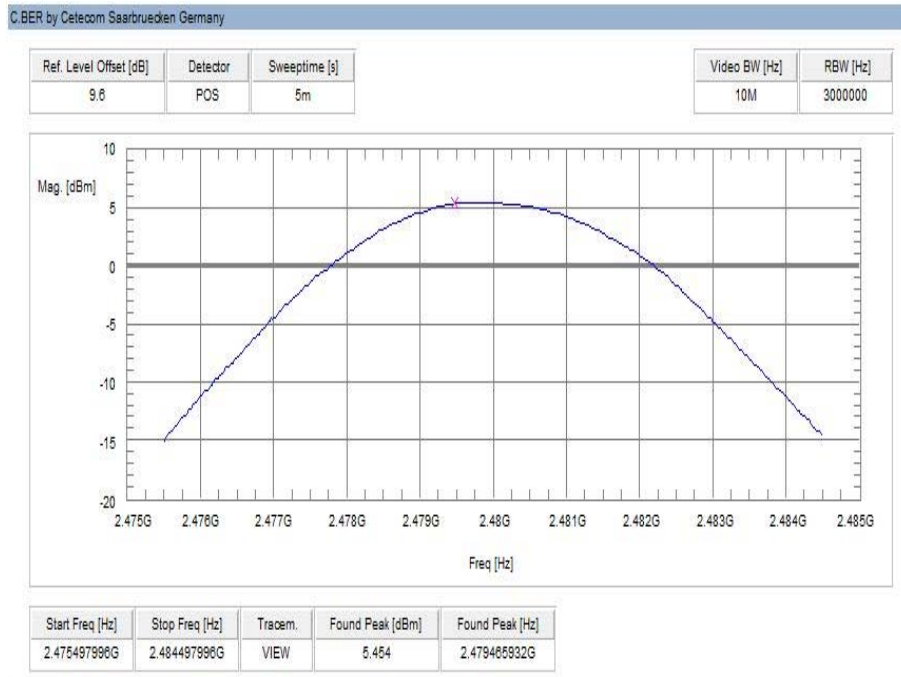

**12.6 Detailed spurious emissions @ the band edge - conducted**

**Description:**

Measurement of the conducted band edge compliance. EUT is measured at the lower and upper band edge in single channel.

Measurement parameters	
Detector	Peak
Sweep time	Auto
Resolution bandwidth	100 kHz
Video bandwidth	300 kHz / 500 kHz
Span	Lower Band Edge: 2395 – 2405 MHz higher Band Edge: 2478 – 2489 MHz
Trace mode	Max hold
Test setup	See sub clause 7.4 A
Measurement uncertainty	See sub clause 9

**Limits:**

FCC	IC
<p>In any 100 kHz bandwidth outside the frequency band in which the spread spectrum or digitally modulated intentional radiator is operating, the radio frequency power that is produced by the intentional radiator shall be at least 20 dB below that in the 100 kHz bandwidth within the band that contains the highest level of the desired power, based on either an RF conducted or a radiated measurement. Attenuation below the general limits specified in Section 15.209(a) is not required.</p>	

**Result:**

Scenario	Spurious band edge conducted [dB]
Modulation	GFSK
Lower band edge – hopping off	> 20 dB
Upper band edge – hopping off	> 20 dB

**Plots:**

**Plot 1: Lower band edge**

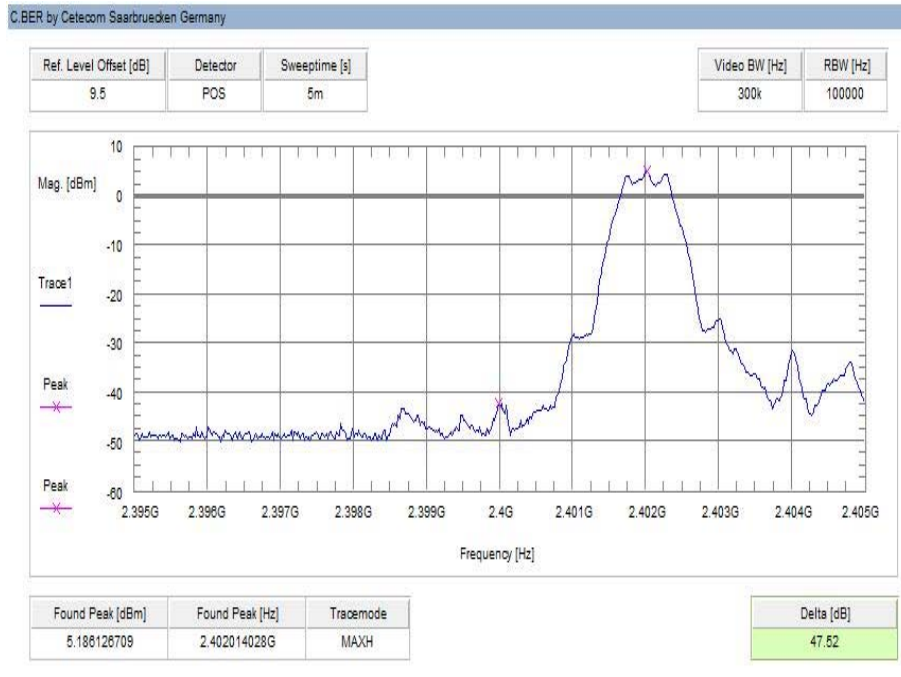

**Plot 2: Upper band edge**

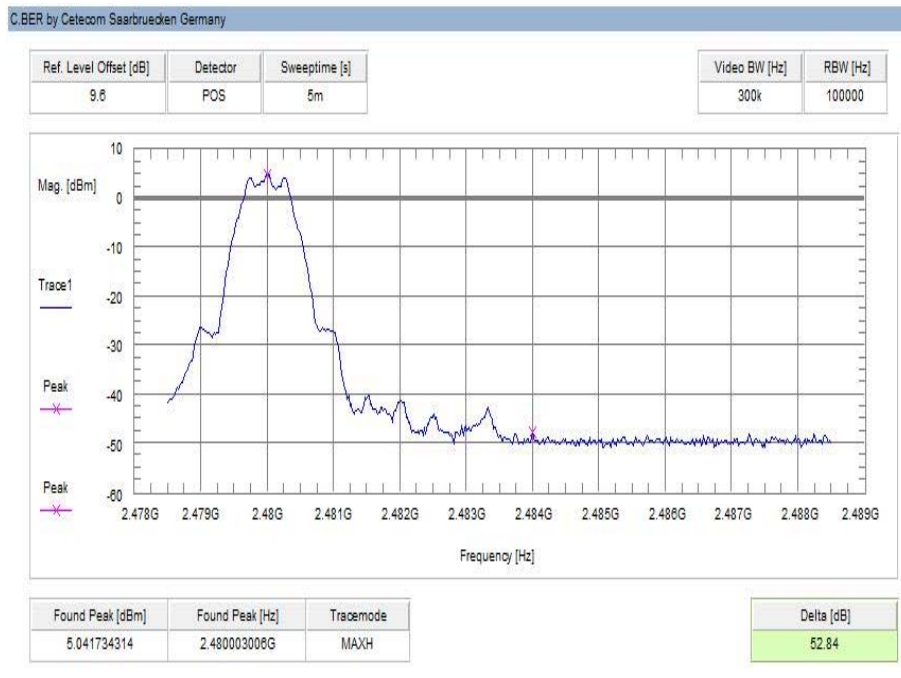



## 12.7 Band edge compliance radiated

### Description:

Measurement of the radiated band edge compliance. The EUT is turned in the position that results in the maximum level at the band edge. Then a sweep over the corresponding restricted band is performed. The EUT is set to single channel mode and the transmit channel is channel 00 for the lower restricted band and channel 39 for the upper restricted band. Measurement distance is 3m.

Measurement parameters	
Detector	Peak / RMS
Sweep time	Auto
Resolution bandwidth	1 MHz
Video bandwidth	3 MHz
Span	Lower Band: 2300 – 2400 MHz higher Band: 2480 – 2500 MHz
Trace mode	Max hold
Test setup	See sub clause 7.2 B
Measurement uncertainty	See sub clause 9

### Limits:

FCC	IC
Band edge compliance radiated	
<p>In any 100 kHz bandwidth outside the frequency band in which the spread spectrum or digitally modulated intentional radiator is operating, the radio frequency power that is produced by the intentional radiator shall be at least 20 dB below that in the 100 kHz bandwidth within the band that contains the highest level of the desired power, based on either an RF conducted or a radiated measurement. Attenuation below the general limits specified in Section 15.209(a) is not required. In addition, radiated emissions which fall in the restricted bands, as defined in Section 15.205(a), must also comply with the radiated emission limits specified in Section 15.209(a) (see Section 5.205(c)).</p>	
54 dBµV/m AVG 74 dBµV/m Peak	

### Result:

Scenario	Band edge compliance radiated [dBµV/m]
Modulation	GFSK
Lower restricted band	< 54 AVG / < 74 PP
Upper restricted band	< 54 AVG / < 74 PP

**Plots:**

**Plot 1: Lower restricted band**

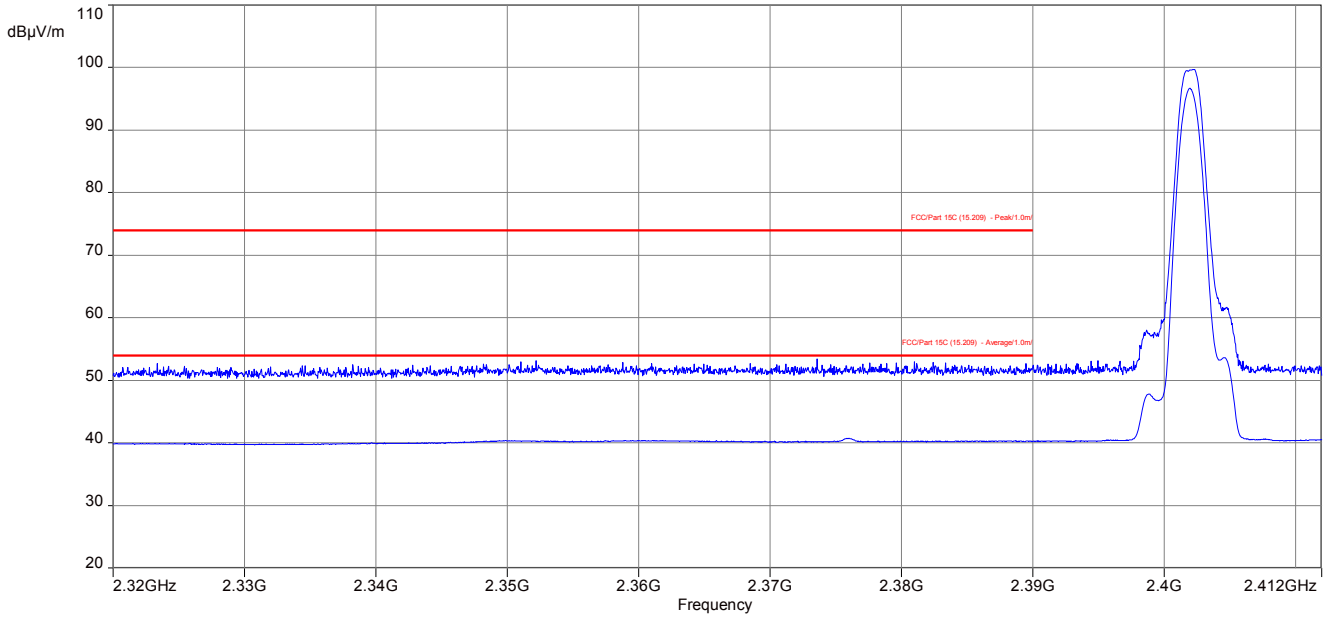

**Plot 2: Upper restricted band**

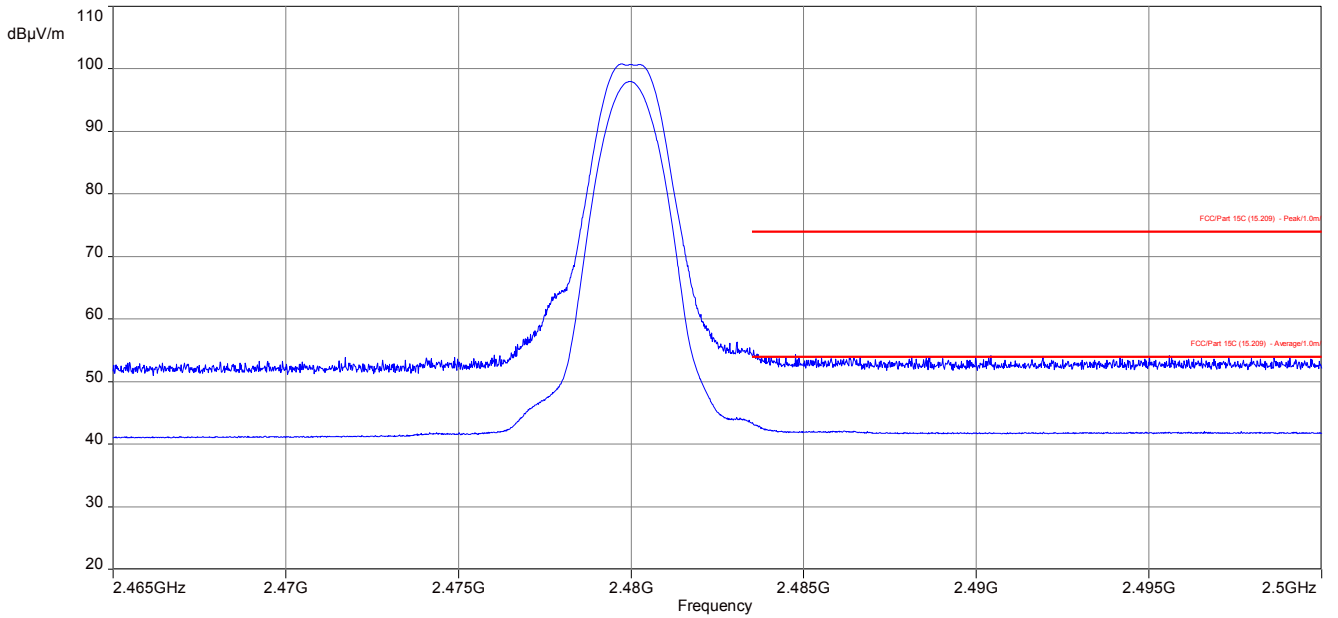

## 12.8 TX spurious emissions conducted

### Description:

Measurement of the conducted spurious emissions in transmit mode. The EUT is set to single channel mode and the transmit channel is channel 00, channel 19 and channel 39.

Measurement parameters	
Detector	Peak
Sweep time	Auto
Resolution bandwidth	100 kHz
Video bandwidth	300 kHz or 500 kHz
Span	9 kHz to 25 GHz
Trace mode	Max hold
Test setup	See sub clause 7.4 A
Measurement uncertainty	See sub clause 9

### Limits:

FCC	IC
TX spurious emissions conducted	
<p>In any 100 kHz bandwidth outside the frequency band in which the spread spectrum or digitally modulated intentional radiator is operating, the radio frequency power that is produced by the intentional radiator shall be at least 20 dB below that in the 100 kHz bandwidth within the band that contains the highest level of the desired power, based on either an RF conducted or a radiated measurement. Attenuation below the general limits specified in Section 15.209(a) is not required</p>	

### Results:

TX spurious emissions conducted					
f [MHz]		amplitude of emission [dBm]	limit max. allowed emission power	actual attenuation below frequency of operation [dB]	results
2402		5.2	30 dBm		Operating frequency
<i>All detected emissions are more than 6 dB below the limit!</i>			-20 dBc		compliant
2440		5.3	30 dBm		Operating frequency
<i>All detected emissions are more than 6 dB below the limit!</i>			-20 dBc		compliant
2480		4.5	30 dBm		Operating frequency
<i>All detected emissions are more than 6 dB below the limit!</i>			-20 dBc		compliant

**Plots:**

**Plot 1: lowest channel**

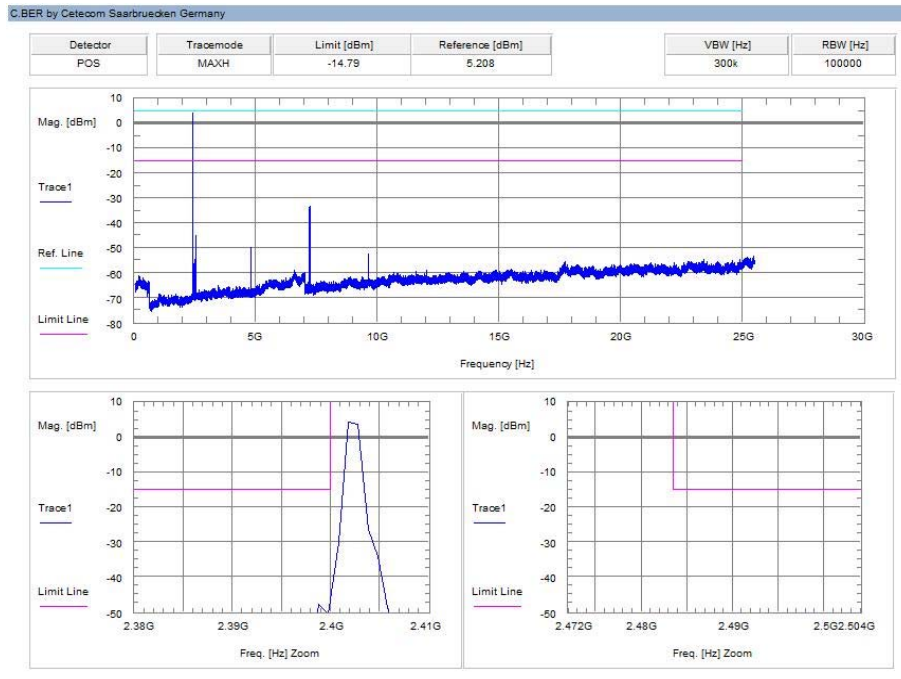

**Plot 2: mid channel**

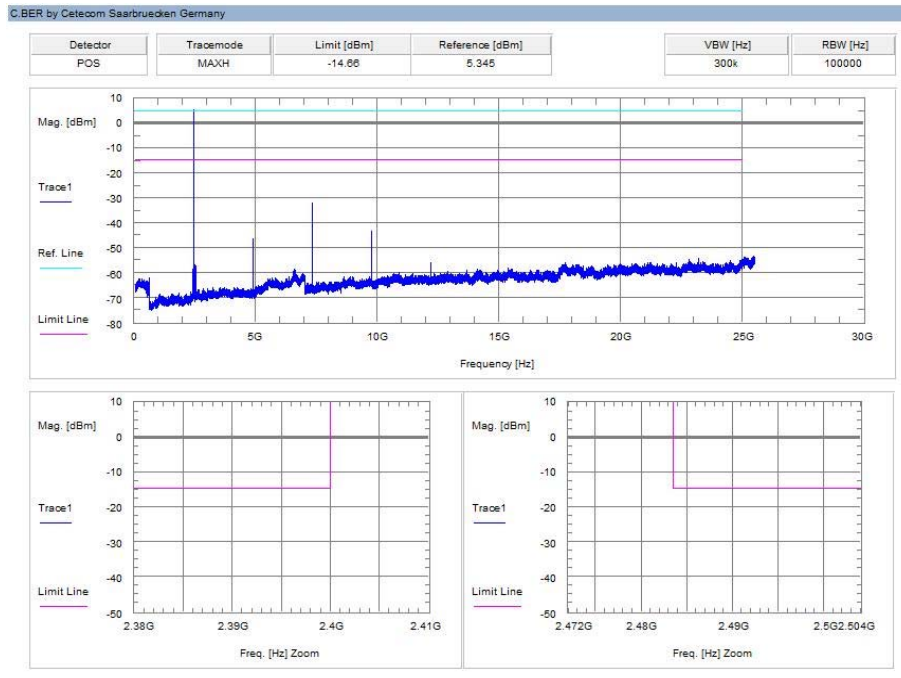

Plot 3: highest channel

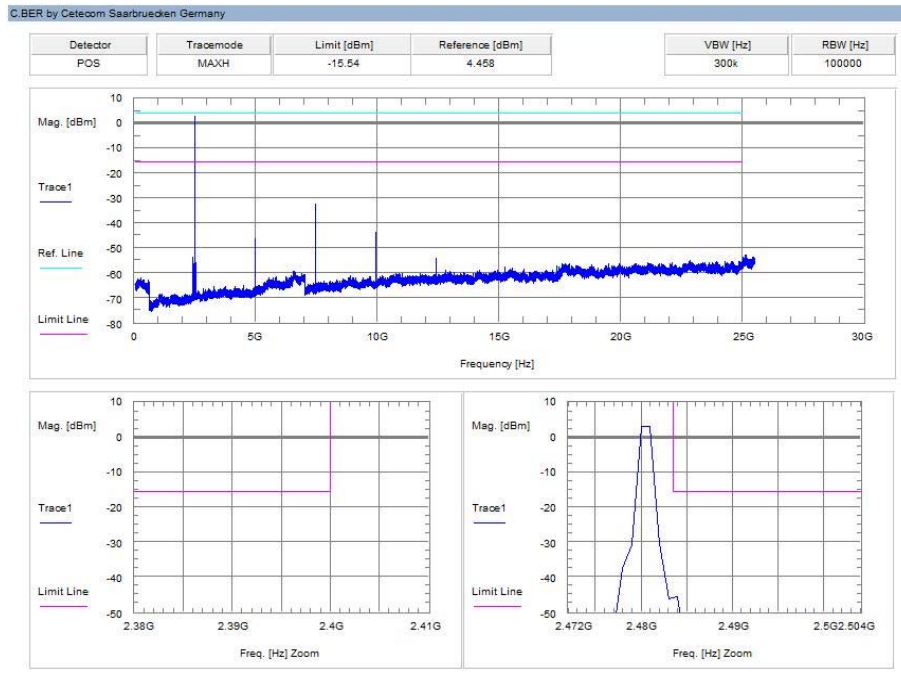

## 12.9 Spurious emissions radiated below 30 MHz

### Description:

Measurement of the radiated spurious emissions in transmit mode below 30 MHz. The EUT is set to single channel mode and the transmit channel is channel 19. This measurement is representative for all channels and modes. If critical peaks are found channel 00 and channel 39 will be measured too. The measurement is performed in the mode with the highest output power. The limits are recalculated to a measurement distance of 3 m according the ANSI C63.10.

Measurement parameters	
Detector	Peak / Quasi peak
Sweep time	Auto
Resolution bandwidth	F < 150 kHz: 1 kHz F > 150 kHz: 100 kHz
Video bandwidth	F < 150 kHz: 200 Hz F > 150 kHz: 9 kHz
Span	9 kHz to 30 MHz
Trace mode	Max hold
Test setup	See sub clause 7.2 C
Measurement uncertainty	See sub clause 9

### Limits:

FCC		IC
TX spurious emissions radiated below 30 MHz		
Frequency (MHz)	Field strength (dB $\mu$ V/m)	Measurement distance
0.009 – 0.490	2400/F(kHz)	300
0.490 – 1.705	24000/F(kHz)	30
1.705 – 30.0	30	30

### Results:

TX spurious emissions radiated below 30 MHz [dB $\mu$ V/m]		
F [MHz]	Detector	Level [dB $\mu$ V/m]
All detected emissions are more than 20 dB below the limit.		

**Plots:**

**Plot 1: 9 kHz to 30 MHz, channel 00, transmit mode**

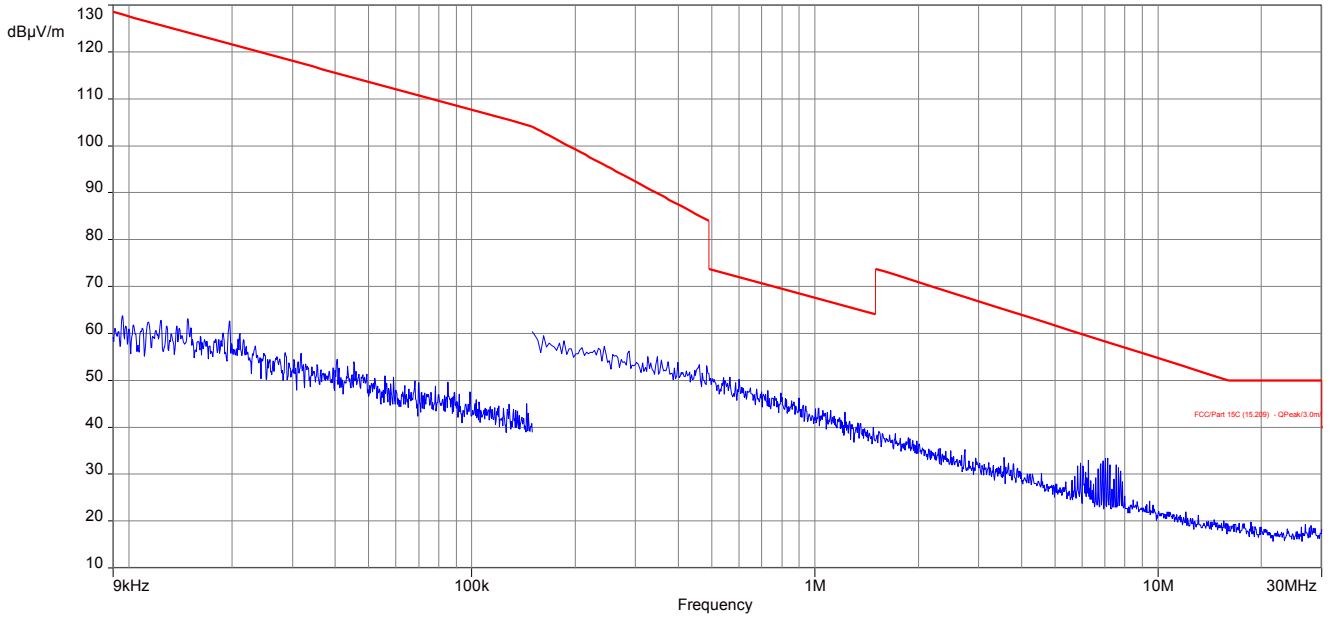

**Plot 2: 9 kHz to 30 MHz, channel 19, transmit mode**

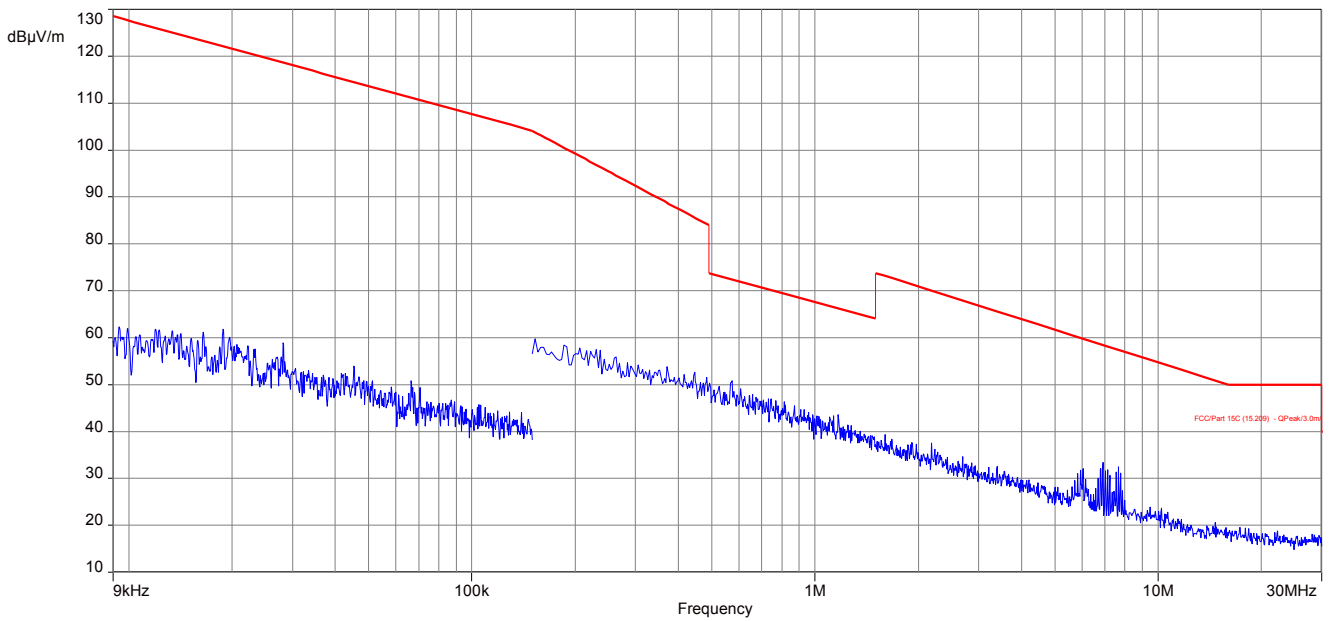

Plot 3: 9 kHz to 30 MHz, channel 39, transmit mode

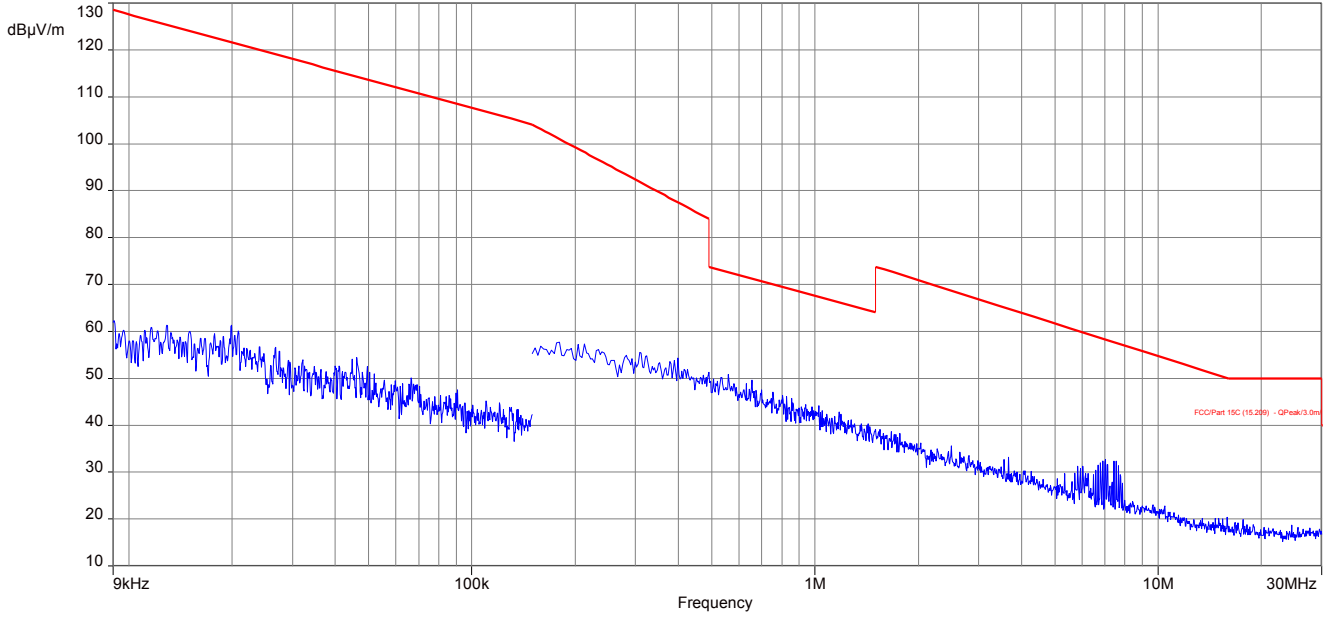



**12.10 Spurious emissions radiated 30 MHz to 1 GHz**

**Description:**

Measurement of the radiated spurious emissions in transmit mode. The EUT is set to single channel mode and the transmit channel is channel 00, channel 19 and channel 39. The measurement is performed in the mode with the highest output power.

Measurement parameters	
Detector	Peak / Quasi Peak
Sweep time	Auto
Resolution bandwidth	3 x VBW
Video bandwidth	120 kHz
Span	30 MHz to 1 GHz
Trace mode	Max hold
Measured modulation	GFSK
Test setup	See sub clause 7.1 A
Measurement uncertainty	See sub clause 9

The modulation with the highest output power was used to perform the transmitter spurious emissions. If spurious were detected a re-measurement was performed on the detected frequency with each modulation.

**Limits:**

FCC		IC	
TX spurious emissions radiated			
In any 100 kHz bandwidth outside the frequency band in which the spread spectrum or digitally modulated intentional radiator is operating, the radio frequency power that is produced by the intentional radiator shall be at least 20 dB below that in the 100 kHz bandwidth within the band that contains the highest level of the desired power, based on either an RF conducted or a radiated measurement. Attenuation below the general limits specified in Section 15.209(a) is not required. In addition, radiated emissions which fall in the restricted bands, as defined in §15.205(a), must also comply with the radiated emission limits specified in §15.209(a) (see §15.205(c)).			
§15.209			
Frequency (MHz)	Field strength (dBµV/m)	Measurement distance	
30 - 88	30.0	10	
88 – 216	33.5	10	
216 – 960	36.0	10	
Above 960	54.0	3	

**Plots:** Transmit mode

**Plot 1:** 30 MHz to 1 GHz, TX mode, channel 00, vertical & horizontal polarization

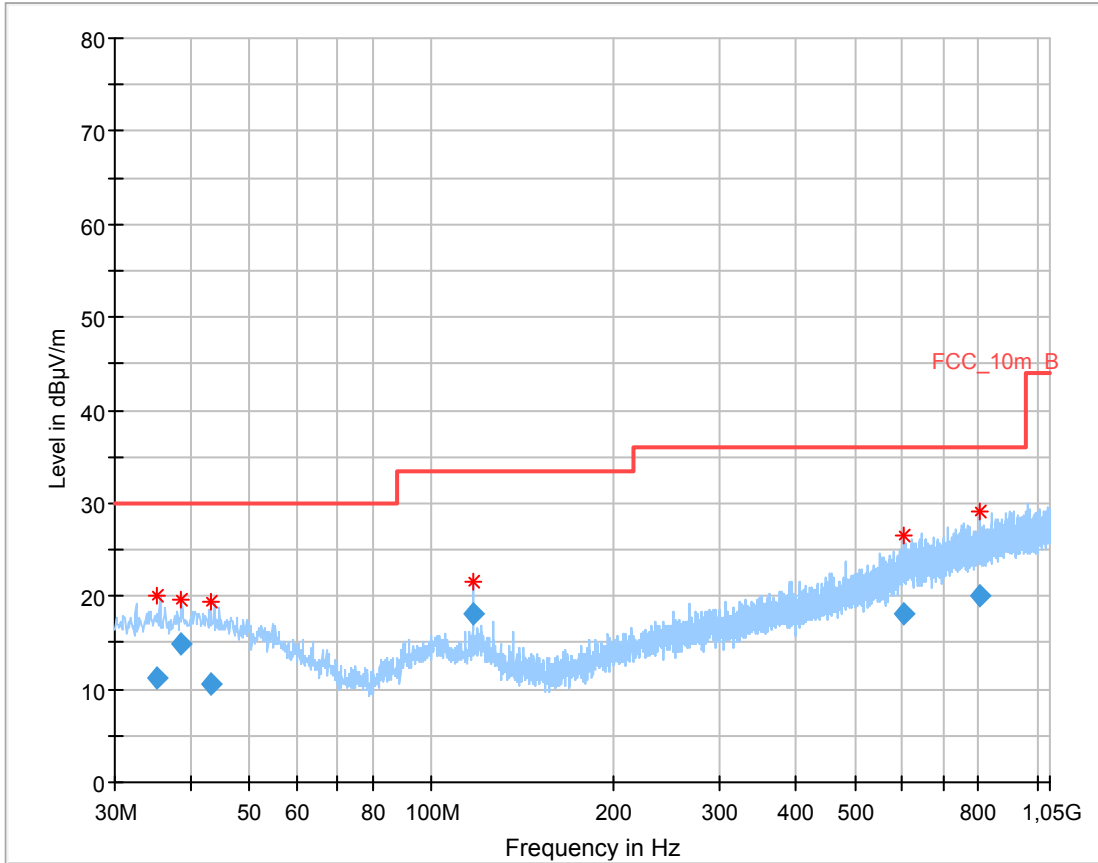

**Final results:**

Frequency (MHz)	QuasiPeak (dBµV/m)	Limit (dBµV/m)	Margin (dB)	Meas. Time (ms)	Bandwidth (kHz)	Height (cm)	Pol	Azimuth (deg)	Corr. (dB)
35.265150	11.26	30.00	18.74	1000.0	120.000	101.0	V	-9.0	13.8
38.683500	14.95	30.00	15.05	1000.0	120.000	170.0	V	190.0	14.0
43.257000	10.61	30.00	19.39	1000.0	120.000	170.0	V	280.0	13.9
116.991150	18.02	33.50	15.48	1000.0	120.000	170.0	V	-10.0	10.4
601.802550	18.21	36.00	17.79	1000.0	120.000	98.0	V	-9.0	20.7
804.611550	20.01	36.00	15.99	1000.0	120.000	170.0	H	260.0	22.8

**Plot 2:** 30 MHz to 1 GHz, TX mode, channel 19, vertical & horizontal polarization

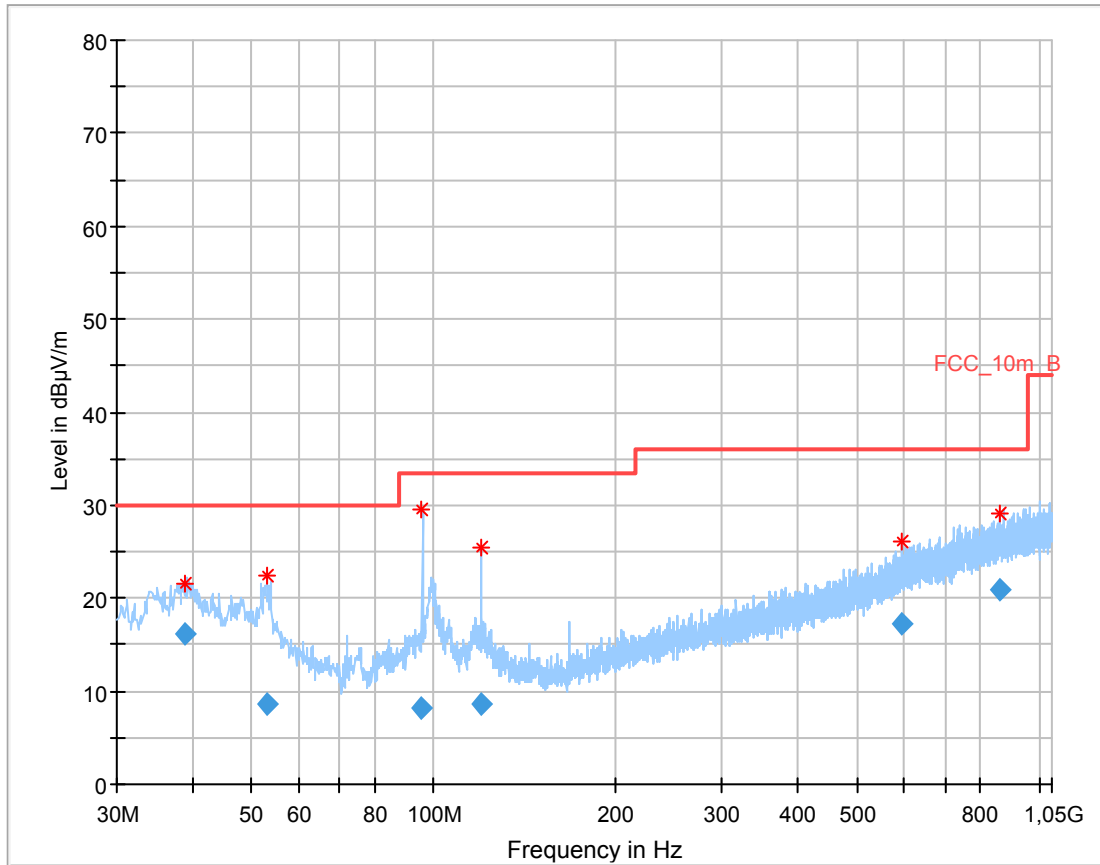

**Final results:**

Frequency (MHz)	QuasiPeak (dBµV/m)	Limit (dBµV/m)	Margin (dB)	Meas. Time (ms)	Bandwidth (kHz)	Height (cm)	Pol	Azimuth (deg)	Corr. (dB)
38.730000	16.16	30.00	13.84	1000.0	120.000	101.0	V	170.0	14.0
52.938300	8.71	30.00	21.29	1000.0	120.000	101.0	V	190.0	12.2
95.752800	8.16	33.50	25.34	1000.0	120.000	101.0	V	261.0	11.5
120.349350	8.62	33.50	24.88	1000.0	120.000	98.0	V	10.0	10.1
593.895600	17.28	36.00	18.72	1000.0	120.000	170.0	H	-9.0	20.5
858.270750	20.89	36.00	15.11	1000.0	120.000	101.0	V	81.0	23.6

Plot 3: 30 MHz to 1 GHz, TX mode, channel 39, vertical & horizontal polarization

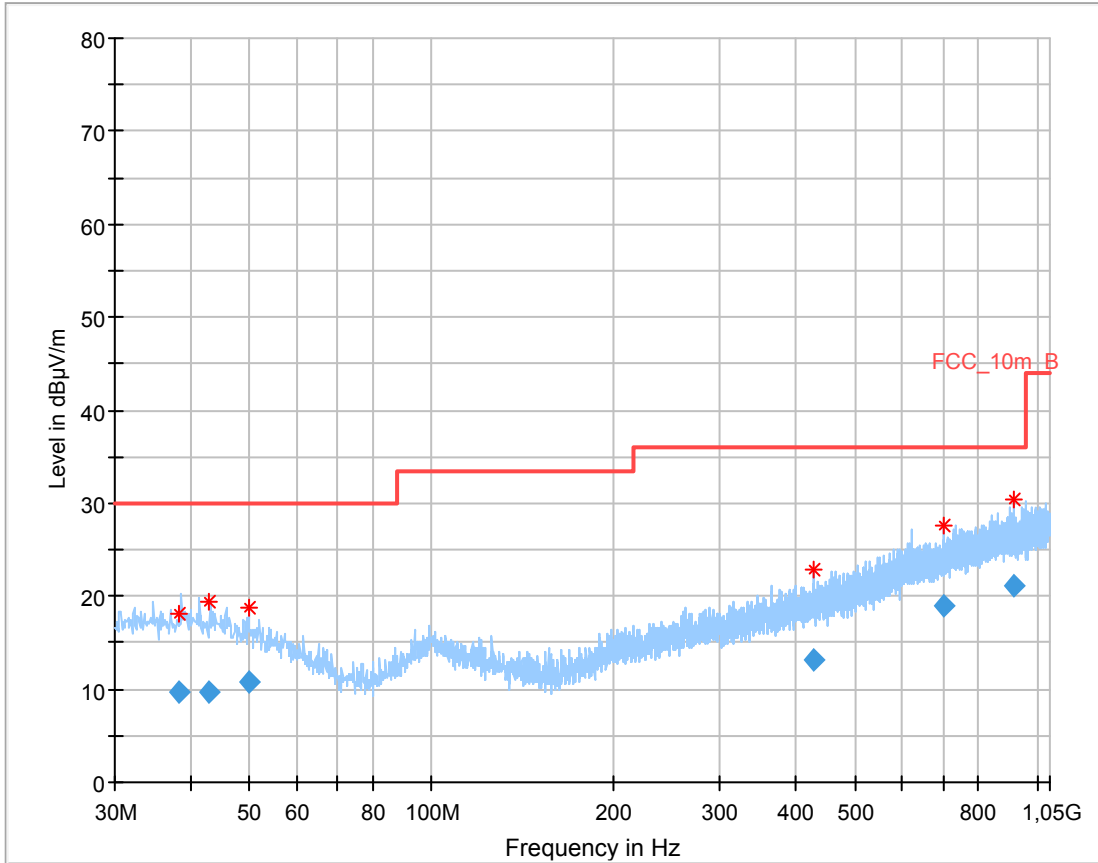

Final results:

\Frequency (MHz)	QuasiPeak (dBµV/m)	Limit (dBµV/m)	Margin (dB)	Meas. Time (ms)	Bandwidth (kHz)	Height (cm)	Pol	Azimuth (deg)	Corr. (dB)
38.223300	9.75	30.00	20.25	1000.0	120.000	101.0	H	190.0	14.0
42.761550	9.61	30.00	20.39	1000.0	120.000	101.0	H	190.0	13.9
50.005800	10.76	30.00	19.24	1000.0	120.000	170.0	V	190.0	12.6
426.974700	13.23	36.00	22.77	1000.0	120.000	170.0	H	280.0	17.3
703.190100	18.89	36.00	17.11	1000.0	120.000	170.0	V	260.0	21.6
914.941500	21.22	36.00	14.78	1000.0	120.000	170.0	H	171.0	24.2

**Plots:** Receiver mode

**Plot 1:** 30 MHz to 1 GHz, RX / idle – mode, vertical & horizontal polarization

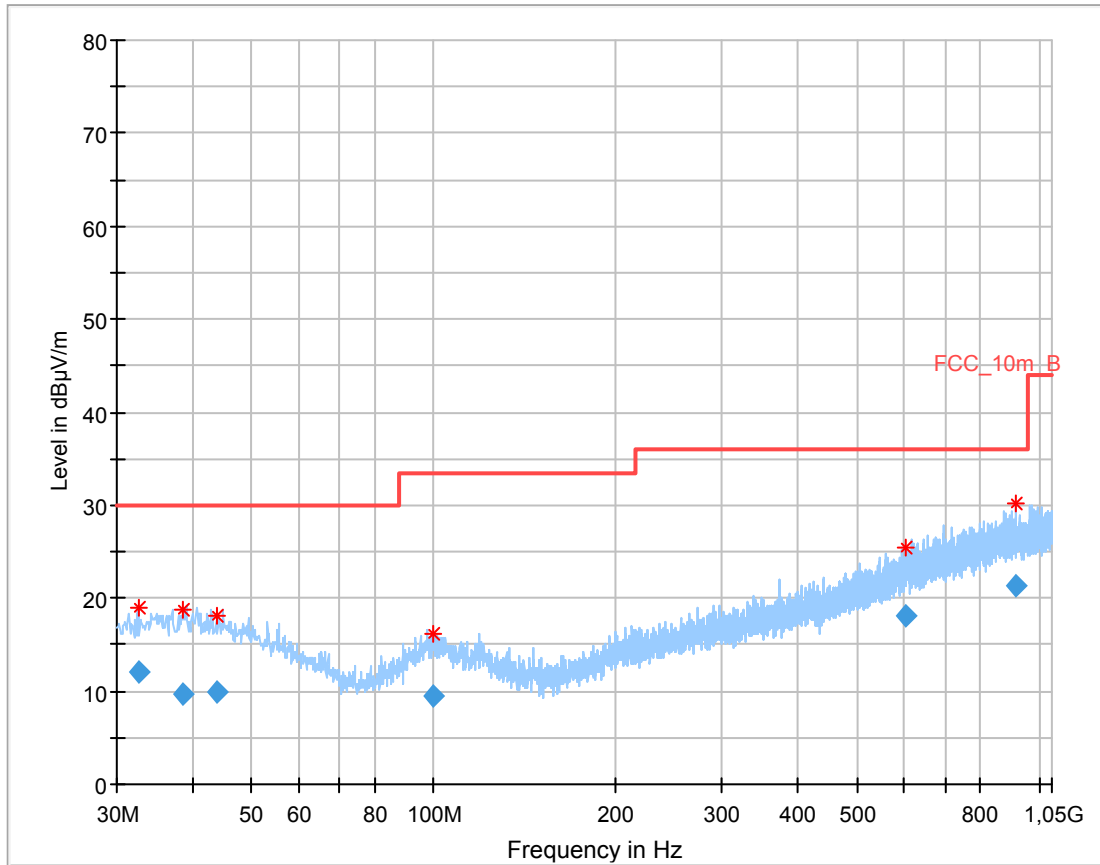

**Final results:**

Frequency (MHz)	QuasiPeak (dBµV/m)	Limit (dBµV/m)	Margin (dB)	Meas. Time (ms)	Bandwidth (kHz)	Height (cm)	Pol	Azimuth (deg)	Corr. (dB)
32.645400	12.17	30.00	17.83	1000.0	120.000	101.0	V	170.0	13.6
38.424900	9.75	30.00	20.25	1000.0	120.000	101.0	H	100.0	14.0
43.935750	9.88	30.00	20.12	1000.0	120.000	101.0	H	171.0	13.9
99.960450	9.45	33.50	24.05	1000.0	120.000	101.0	V	80.0	12.2
601.500300	18.02	36.00	17.98	1000.0	120.000	170.0	V	260.0	20.7
914.356350	21.26	36.00	14.74	1000.0	120.000	101.0	V	260.0	24.2

## 12.11 Spurious emissions radiated above 1 GHz

### Description:

Measurement of the radiated spurious emissions in transmit mode. The EUT is set to single channel mode and the transmit channel is channel 00, channel 19 and channel 39. The measurement is performed in the mode with the highest output power.

Measurement parameters	
Detector	Peak / RMS
Sweep time	Auto
Resolution bandwidth	1 MHz
Video bandwidth	3 x RBW
Span	1 GHz to 26 GHz
Trace mode	Max hold
Measured modulation	GFSK
Test setup	See sub clause 7.2 A (1 GHz - 18 GHz) See sub clause 7.3 A (18 GHz - 26 GHz)
Measurement uncertainty	See sub clause 9

The modulation with the highest output power was used to perform the transmitter spurious emissions. If spurious were detected a re-measurement was performed on the detected frequency with each modulation.

### Limits:

FCC	IC	
TX spurious emissions radiated		
In any 100 kHz bandwidth outside the frequency band in which the spread spectrum or digitally modulated intentional radiator is operating, the radio frequency power that is produced by the intentional radiator shall be at least 20 dB below that in the 100 kHz bandwidth within the band that contains the highest level of the desired power, based on either an RF conducted or a radiated measurement. Attenuation below the general limits specified in Section 15.209(a) is not required. In addition, radiated emissions which fall in the restricted bands, as defined in §15.205(a), must also comply with the radiated emission limits specified in §15.209(a) (see §15.205(c)).		
§15.209		
Frequency (MHz)	Field strength (dBµV/m)	Measurement distance
Above 960	54.0 (Average)	3
Above 960	74.0 (Peak)	3

**Results:** Transmitter mode

TX spurious emissions radiated [dBµV/m]								
2402 MHz			2440 MHz			2480 MHz		
F [MHz]	Detector	Level [dBµV/m]	F [MHz]	Detector	Level [dBµV/m]	F [MHz]	Detector	Level [dBµV/m]
2506	Peak	)*	2376	Peak	52.9		Peak	
	AVG			49.0	AVG			
	Peak			Peak			Peak	
	AVG			AVG			AVG	
	Peak			Peak			Peak	
	AVG			AVG			AVG	

**\*NOTE:** The emission was not rated because the frequency is not part of a restricted band.

**Results:** Receiver mode

RX spurious emissions radiated [dBµV/m]		
F [MHz]	Detector	Level [dBµV/m]
All detected emissions are more than 20 dB below the limit.		
	Peak	
	AVG	

**Note:** The limit was recalculated with 20 dB / decade (Part 15.31) for all radiated spurious emissions 30 MHz to 1 GHz from 3 meter limit to a 10 meter distance. (40dB/decade for emissions < 30MHz)

**Plots:** Transmitter mode

**Plot 1:** 1 GHz to 18 GHz, TX mode, channel 00, vertical & horizontal polarization

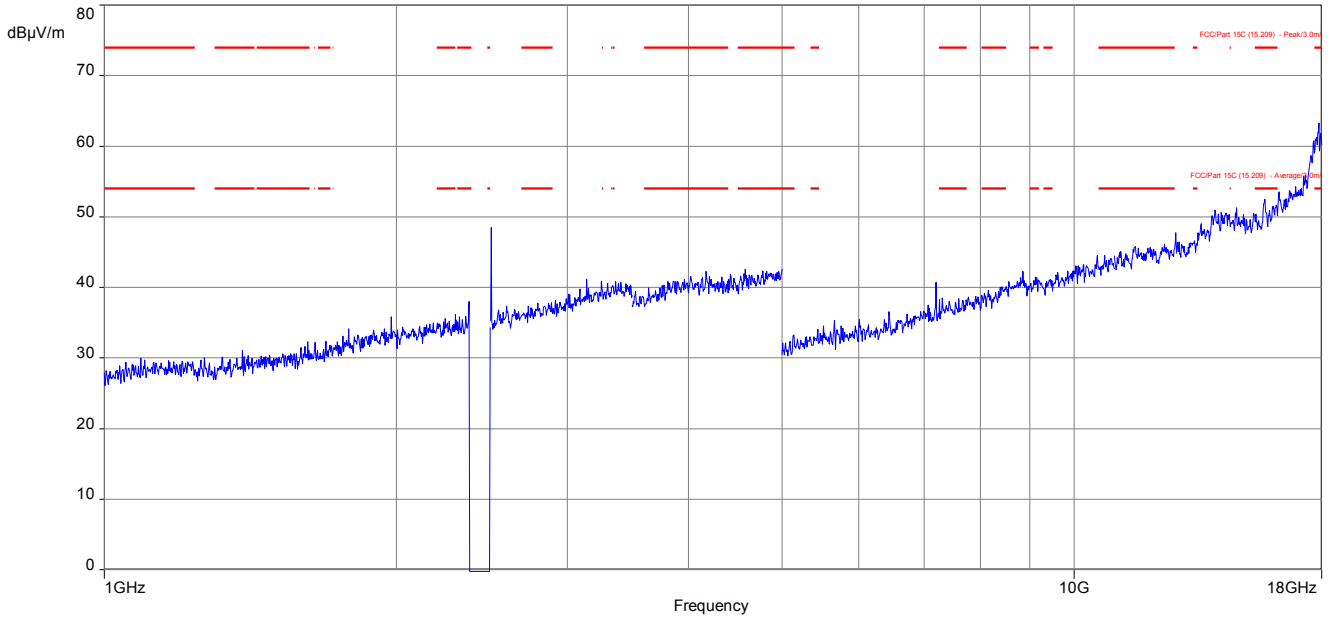

The carrier signal is notched with a 2.4 GHz band rejection filter.

**Plot 2:** 17.7 GHz to 18 GHz, TX mode, channel 00, vertical & horizontal polarization

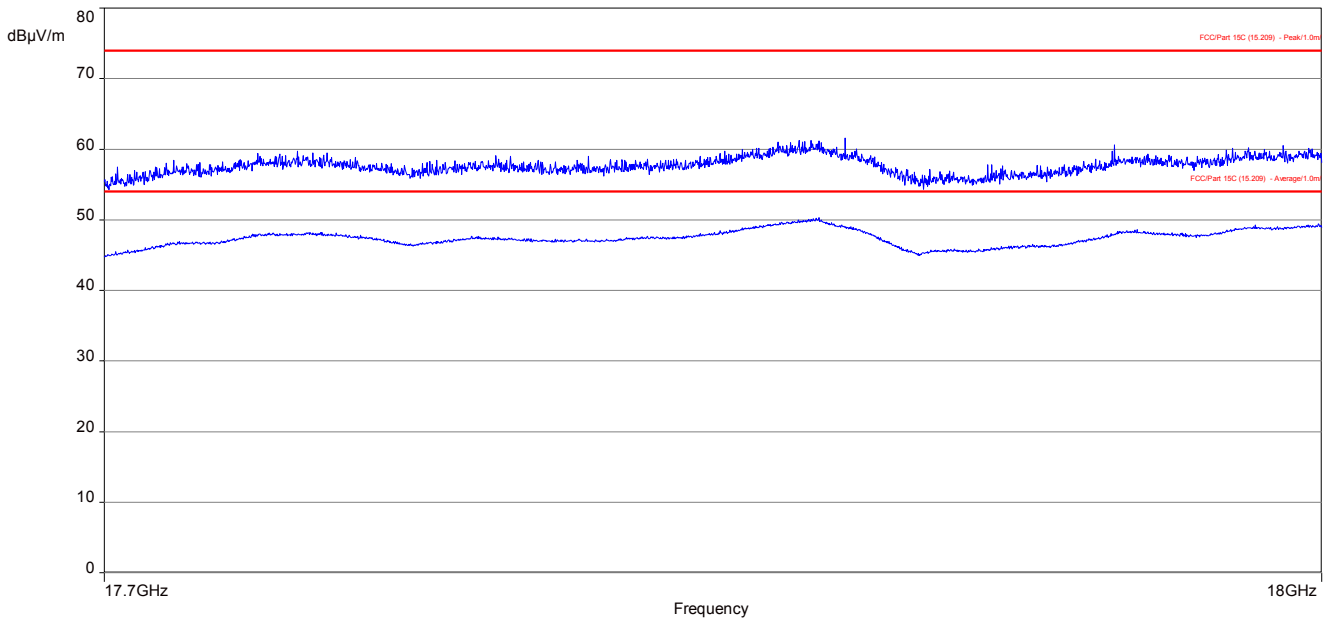



Plot 3: 18 GHz to 26 GHz, TX mode, channel 00, vertical & horizontal polarization

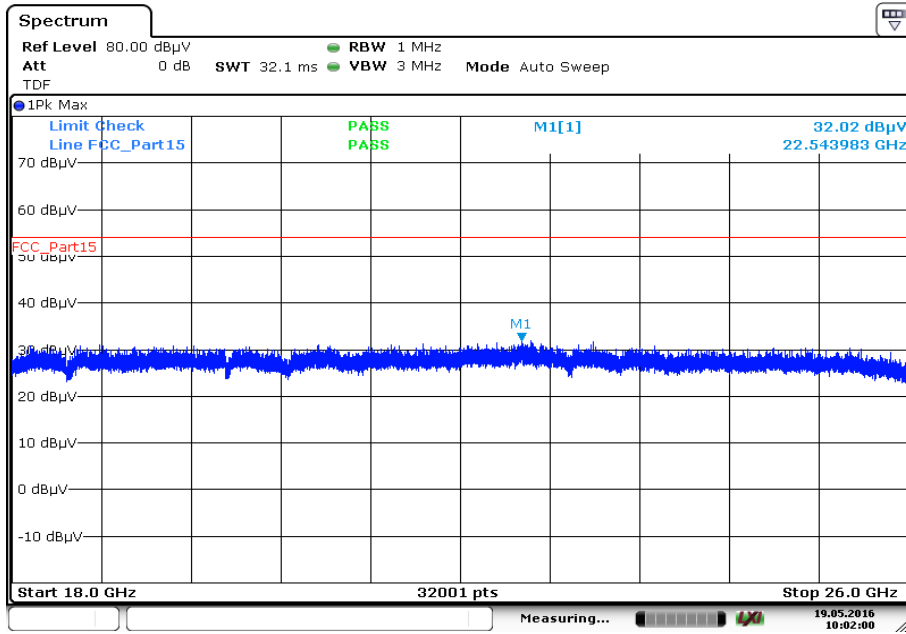

Date: 19.MAY.2016 10:02:00

**Plot 4:** 1 GHz to 18 GHz, TX mode, channel 19, vertical & horizontal polarization

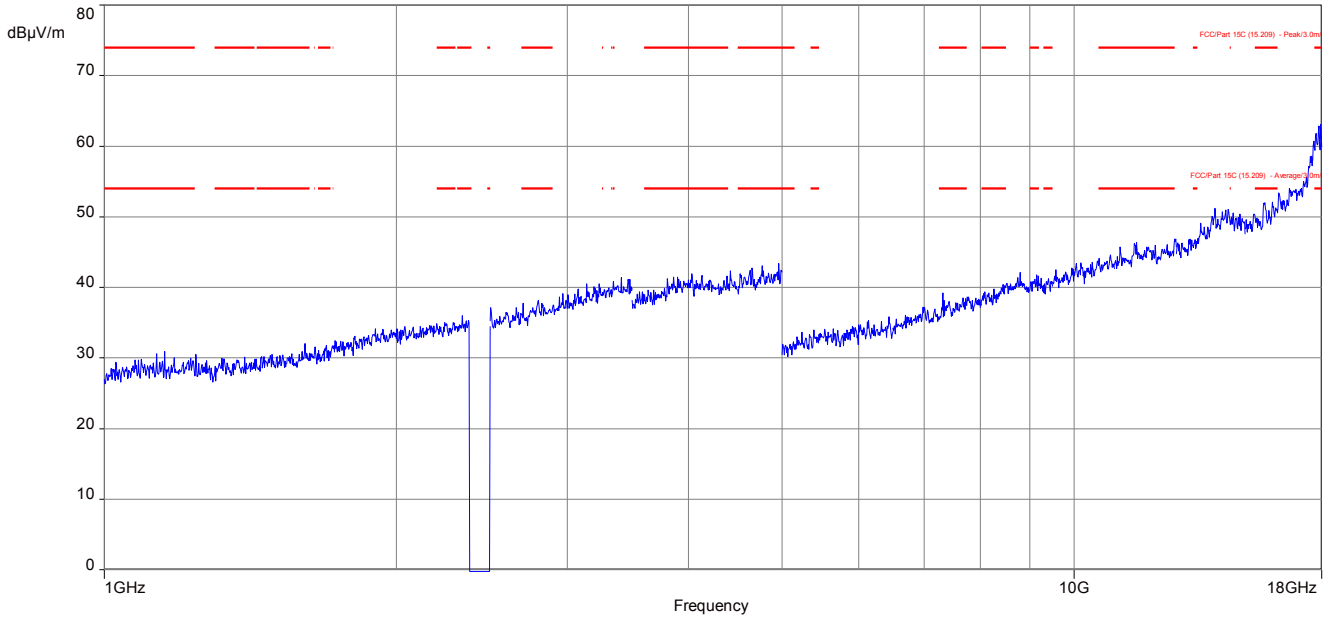

The carrier signal is notched with a 2.4 GHz band rejection filter.

**Plot 5:** 17.7 GHz to 18 GHz, TX mode, channel 19, vertical & horizontal polarization

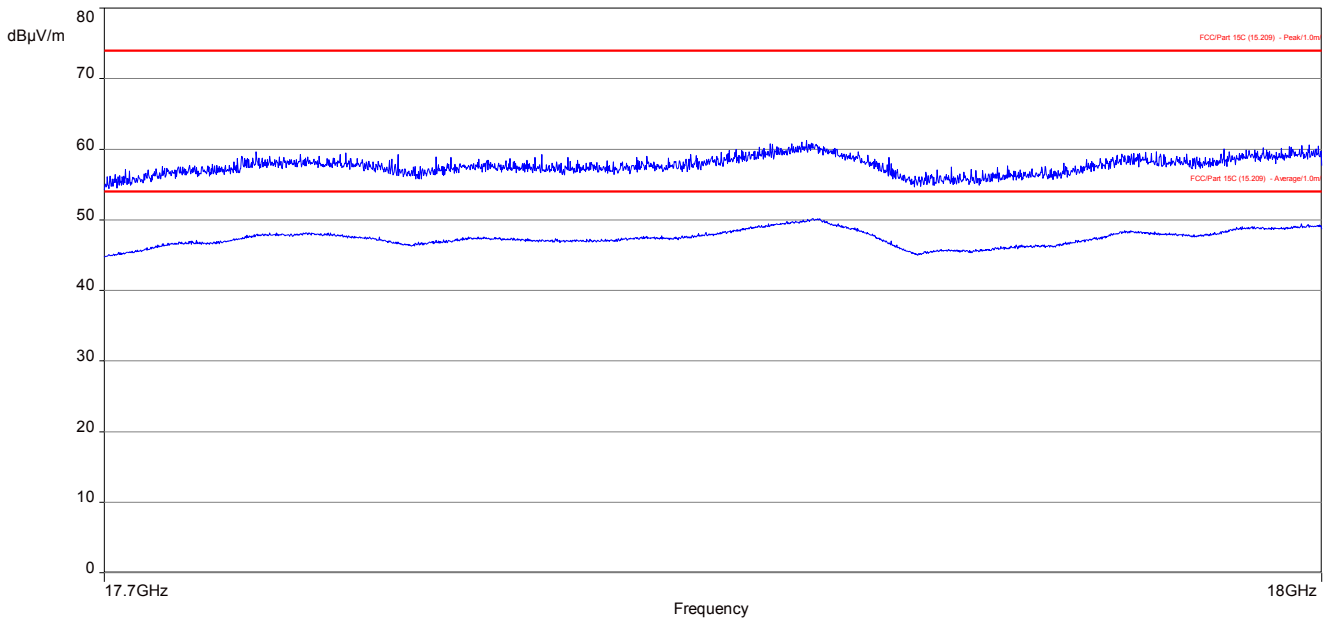

Plot 6: 18 GHz to 26 GHz, TX mode, channel 19, vertical & horizontal polarization

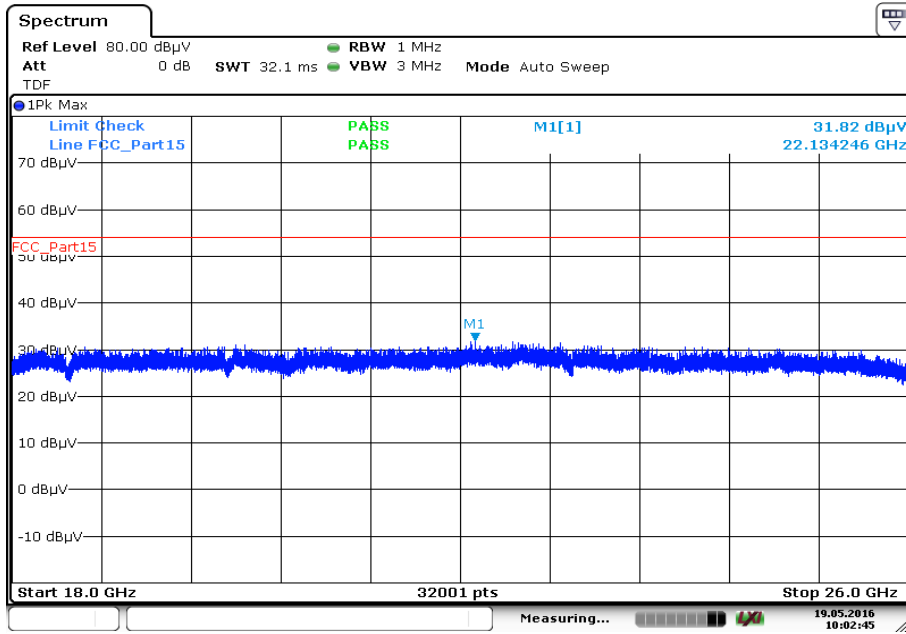

Date: 19.MAY.2016 10:02:45

**Plot 7:** 1 GHz to 18 GHz, TX mode, channel 39, vertical & horizontal polarization

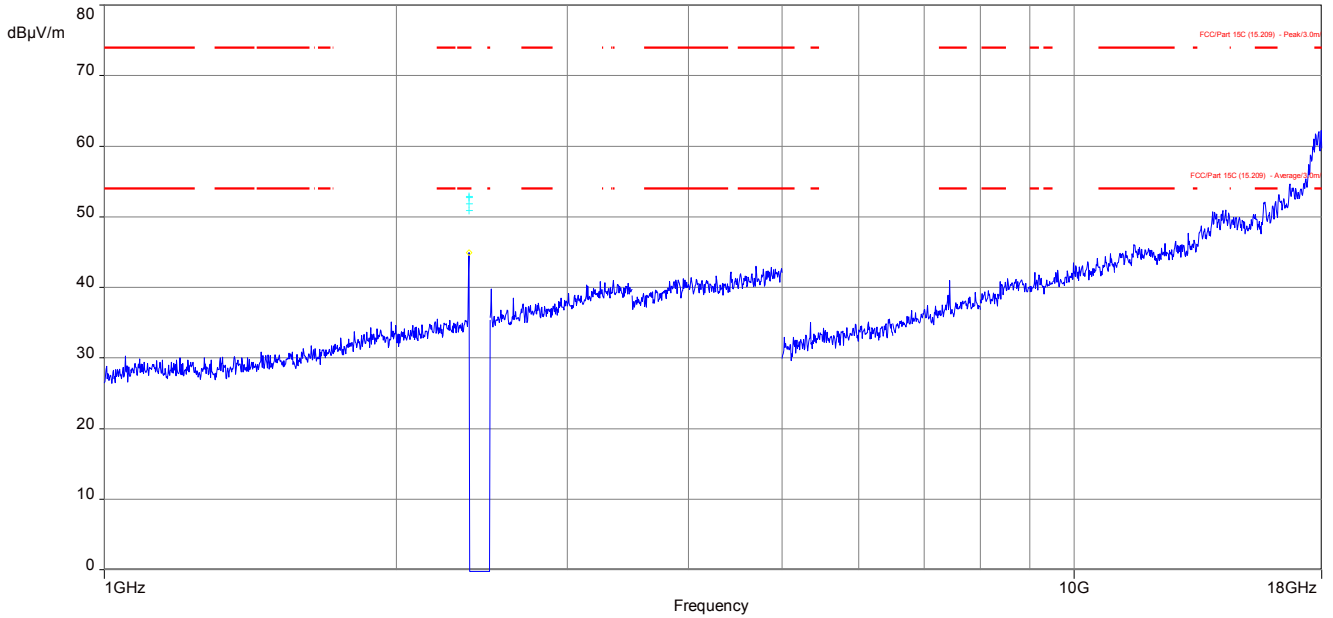

The carrier signal is notched with a 2.4 GHz band rejection filter.

**Plot 8:** 17.7 GHz to 18 GHz, TX mode, channel 39, vertical & horizontal polarization

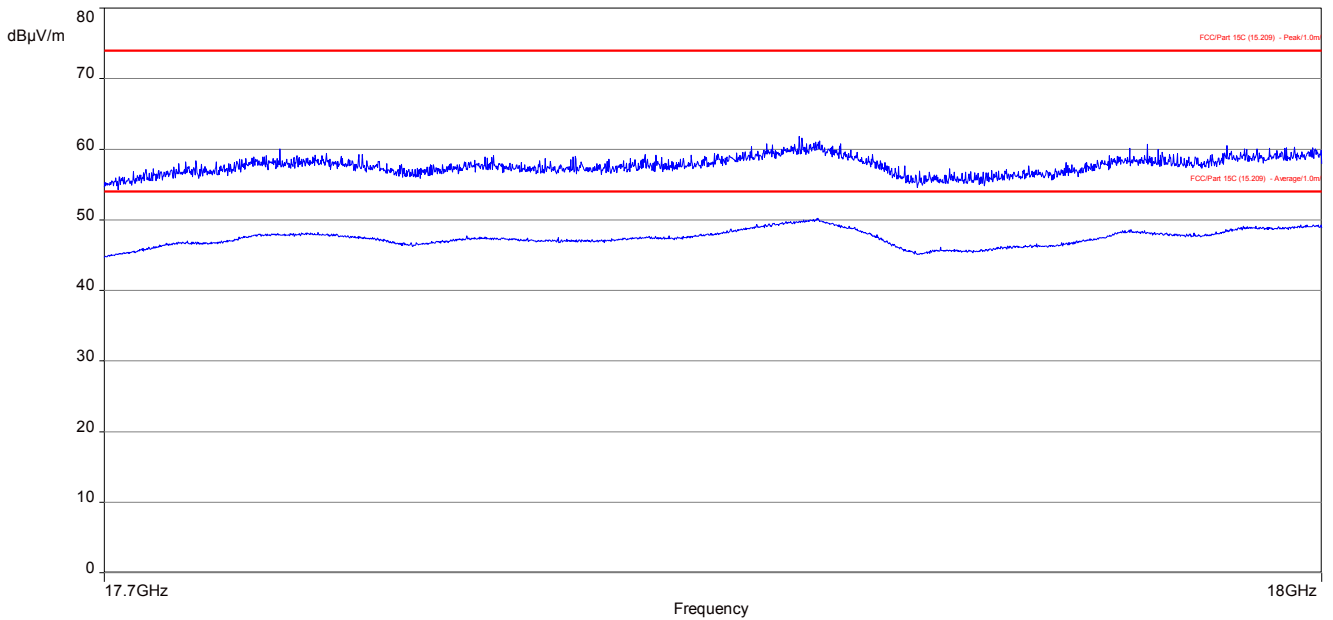

Plot 9: 18 GHz to 26 GHz, TX mode, channel 39, vertical & horizontal polarization

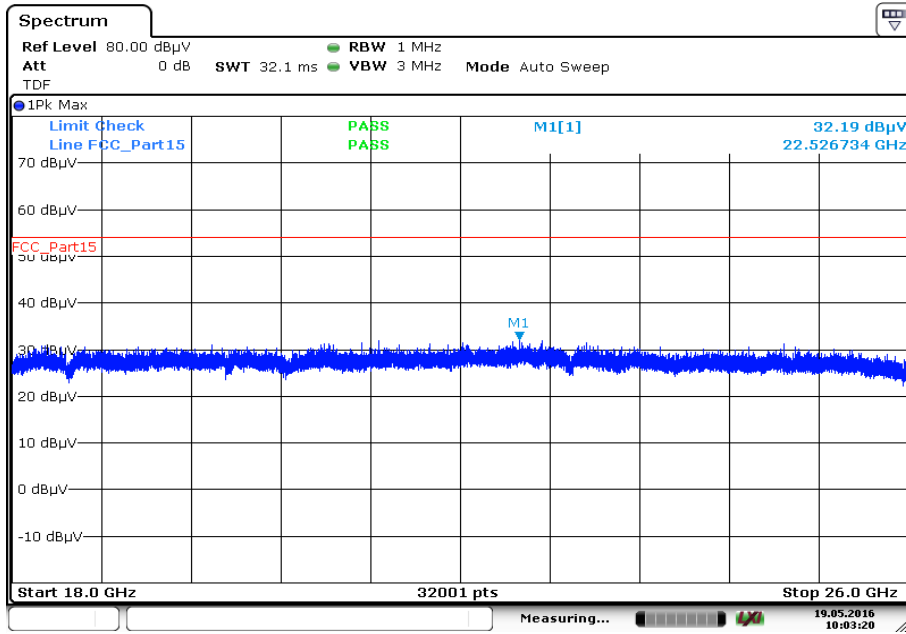

Date: 19.MAY.2016 10:03:19

**Plots:** Receiver mode

**Plot 1:** 1 GHz to 18 GHz, RX / idle – mode, vertical & horizontal polarization

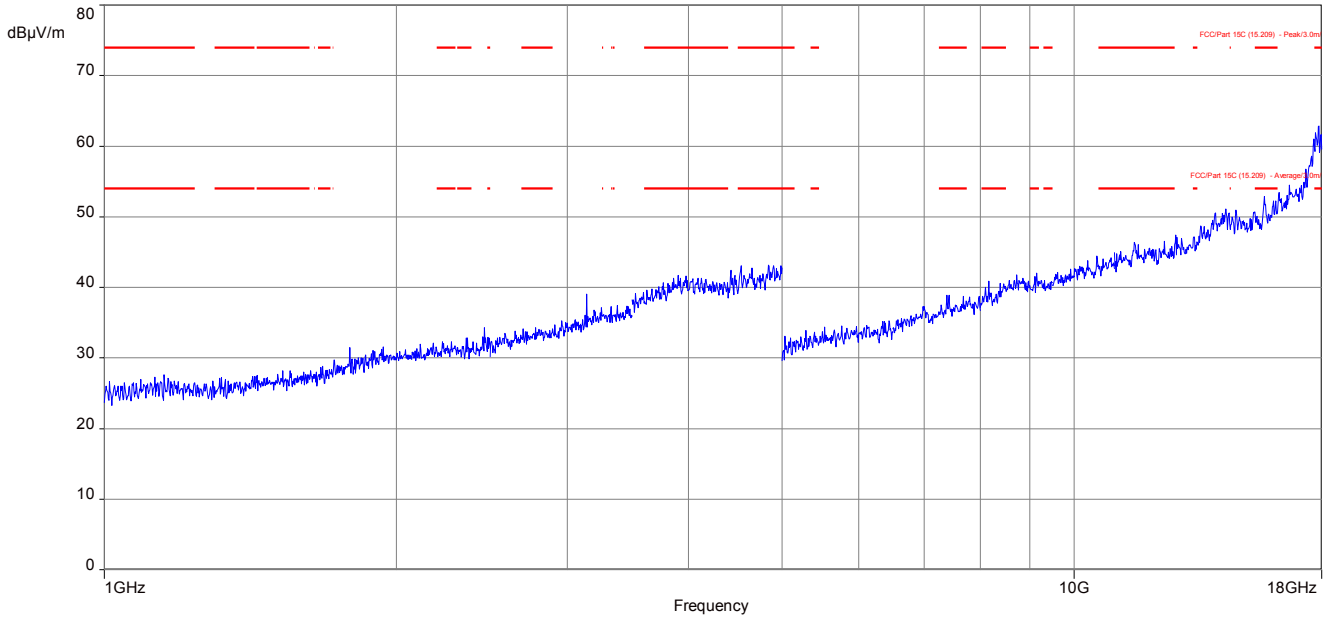

**Plot 2:** 17.7 GHz to 18 GHz, RX / idle – mode, vertical & horizontal polarization

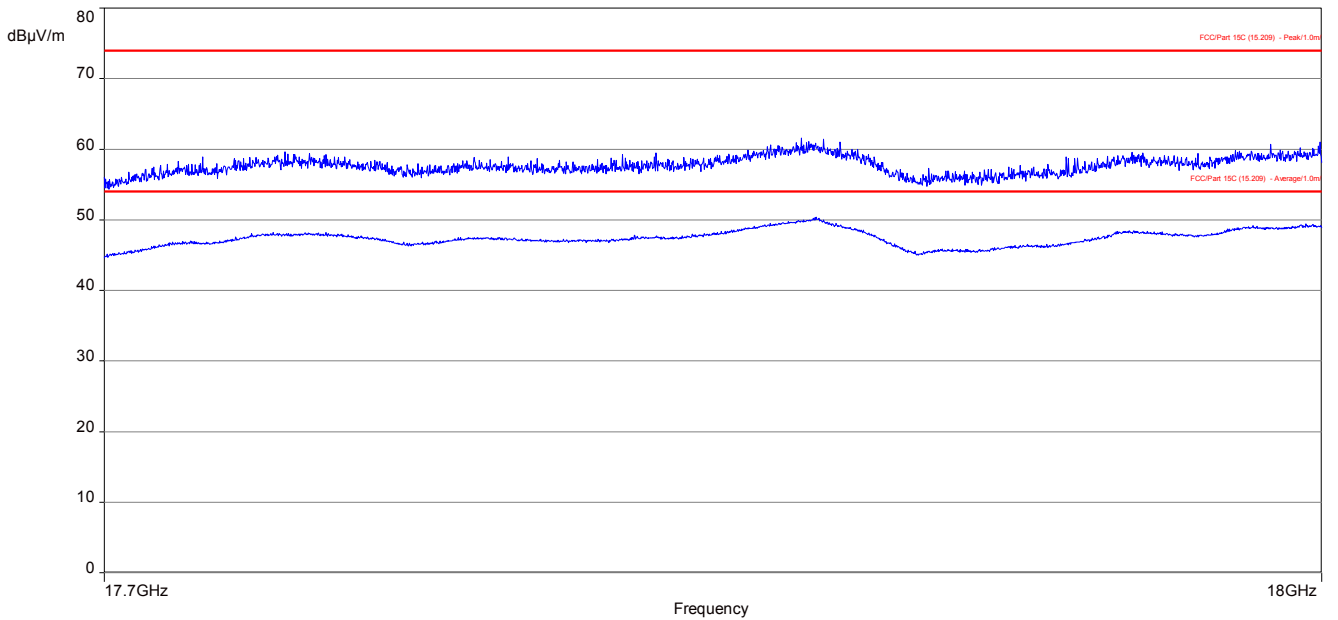

Plot 3: 18 GHz to 26 GHz, RX / idle – mode, vertical & horizontal polarization

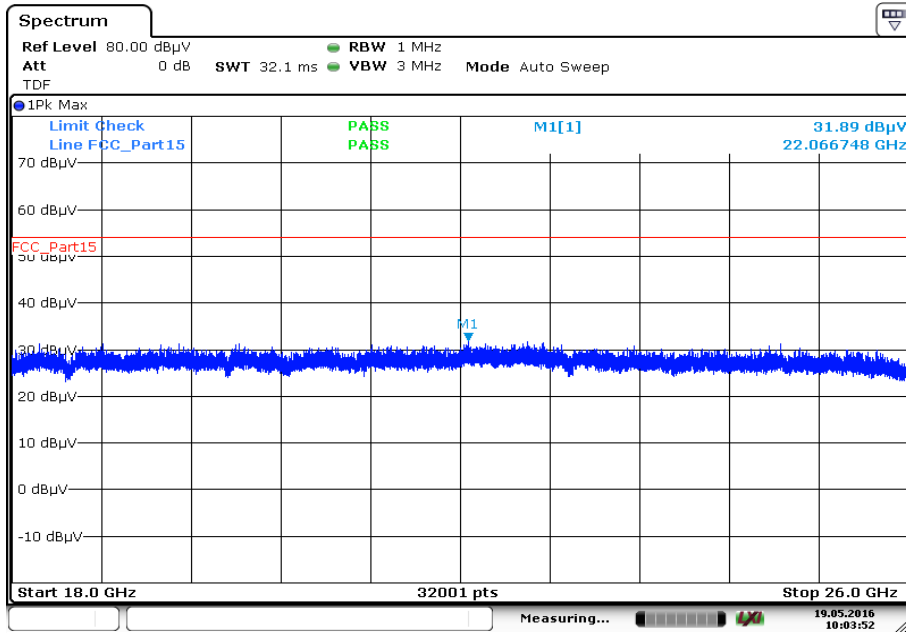

Date: 19.MAY.2016 10:03:52

### 13 Observations

No observations except those reported with the single test cases have been made.

### Annex A Document history

Version	Applied changes	Date of release
	Initial release	2016-05-25

### Annex B Further information

#### Glossary

AVG	-	Average
DUT	-	Device under test
EMC	-	Electromagnetic Compatibility
EN	-	European Standard
EUT	-	Equipment under test
ETSI	-	European Telecommunications Standard Institute
FCC	-	Federal Communication Commission
FCC ID	-	Company Identifier at FCC
HW	-	Hardware
IC	-	Industry Canada
Inv. No.	-	Inventory number
N/A	-	Not applicable
PP	-	Positive peak
QP	-	Quasi peak
S/N	-	Serial number
SW	-	Software
PMN	-	Product marketing name
HMN	-	Host marketing name
HVIN	-	Hardware version identification number
FVIN	-	Firmware version identification number



**Annex C Accreditation Certificate**

Front side of certificate

Back side of certificate



Deutsche Akkreditierungsstelle GmbH

Befehle gemäß § 8 Absatz 1 AkkStelleG i.V.m. § 1 Absatz 1 AkkStelleGBV  
 Unterzeichnerin der Multilateralen Abkommen  
 von EA, ILAC und IAF zur gegenseitigen Anerkennung

**Akkreditierung**

Die Deutsche Akkreditierungsstelle GmbH bestätigt hiermit, dass das Prüflaboratorium

**CETECOM ICT Services GmbH**  
 Untertürkheimer Straße 6-10, 66117 Saarbrücken

die Kompetenz nach DIN EN ISO/IEC 17025:2005 besitzt, Prüfungen in folgenden Bereichen durchzuführen:

- Funk
- Mobilfunk (GSM / DCS) + OTA
- Elektromagnetische Verträglichkeit (EMV)
- Produktsicherheit
- SAR / EMF
- Umwelt
- Smart Card Technology
- Bluetooth®
- Automotive
- Wi-Fi-Services
- Kanadische Anforderungen
- US-Anforderungen
- Akustik
- Near Field Communication (NFC)

Die Akkreditierungsurkunde gilt nur in Verbindung mit dem Bescheid vom 04.05.2016 mit der Akkreditierungsnummer D-PL-12076-01 und ist gültig bis 17.01.2018. Sie besteht aus diesem Deckblatt, der Rückseite des Deckblatts und der folgenden Anlage mit insgesamt 63 Seiten.

Registrierungsnummer der Urkunde: D-PL-12076-01-01

Frankfurt, 04.05.2016

Im Auftrag Dir. Ing. (FH) Ralf Eigner  
 Abteilungsleiter

Siehe Hinweise auf der Rückseite

Deutsche Akkreditierungsstelle GmbH

Standort Berlin  
 Spittelmarkt 10  
 10117 Berlin

Standort Frankfurt am Main  
 Europa-Allee 52  
 60327 Frankfurt am Main

Standort Braunschweig  
 Bundesallee 100  
 38116 Braunschweig

Die auszugsweise Veröffentlichung der Akkreditierungsurkunde bedarf der vorherigen schriftlichen Zustimmung der Deutsche Akkreditierungsstelle GmbH (DAkkS). Ausgenommen davon ist die separate Weiterverbreitung des Deckblattes durch die umseitig genannte Konformitätsbewertungsstelle in unveränderter Form.

Es darf nicht der Anschein erweckt werden, dass sich die Akkreditierung auch auf Bereiche erstreckt, die über den durch die DAkkS bestätigten Akkreditierungsbereich hinausgehen.

Die Akkreditierung erfolgte gemäß des Gesetzes über die Akkreditierungsstelle (AkkStelleG) vom 31. Juli 2009 (BGBl. I S. 2625) sowie der Verordnung (EG) Nr. 765/2008 des Europäischen Parlaments und des Rates vom 9. Juli 2008 über die Vorschriften für die Akkreditierung und Marktüberwachung im Zusammenhang mit der Vermarktung von Produkten (Abt. L 218 vom 9. Juli 2008, S. 30). Die DAkkS ist Unterzeichnerin der Multilateralen Abkommen zur gegenseitigen Anerkennung der European co-operation for Accreditation (EA), des International Accreditation Forum (IAF) und der International Laboratory Accreditation Cooperation (ILAC). Die Unterzeichner dieser Abkommen erkennen ihre Akkreditierungen gegenseitig an.

Der aktuelle Stand der Mitgliedschaft kann folgenden Webseiten entnommen werden:  
 EA: [www.european-accreditation.org](http://www.european-accreditation.org)  
 ILAC: [www.ilac.org](http://www.ilac.org)  
 IAF: [www.iaf.nu](http://www.iaf.nu)

**Note:**

The current certificate including annex may be received from CETECOM ICT Services GmbH on request.