



Test Report No.: RF2305WDG0021-2



# TEST REPORT



Applicant	Harman International Industries, Inc.
Address	30001 Cabot Drive Novi, Michigan 48377 USA

Manufacturer or Supplier	Harman International Industries, Inc.
Address	30001 Cabot Drive Novi, Michigan 48377 USA
Product	Portable Bluetooth Speaker
Brand Name	JBL
Model	TOYOTA JBL FLEX
Additional Model & Model Difference	N/A
Date of tests	Jun. 15, 2023 ~ Jul. 10, 2023

the tests have been carried out according to the requirements of the following standard:

**FCC Part 15, Subpart C, Section 15.247**

**CONCLUSION: The submitted sample was found to COMPLY with the test requirement**

Tested by Eric Fang Project Engineer / EMC Department	Approved by Glyn He Assistant Manager / EMC Department
	  Date: Aug. 04, 2023

This report is governed by, and incorporates by reference, the Conditions of Testing as posted at the date of issuance of this report at <http://www.bureauveritas.com/home/about-us/our-business/cps/about-us/terms-conditions/> and is intended for your exclusive use. Any copying or replication of this report to or for any other person or entity, or use of our name or trademark, is permitted only with our prior written permission. This report sets forth our findings solely with respect to the test samples identified herein. The results set forth in this report are not indicative or representative of the quality or characteristics of the lot from which a test sample was taken or any similar or identical product unless specifically and expressly noted. Our report includes all of the tests requested by you and the results thereof based upon the information that you provided to us. Measurement uncertainty is only provided upon request for accredited tests. Statements of conformity are based on simple acceptance criteria without taking measurement uncertainty into account, unless otherwise requested in writing. You have 60 days from date of issuance of this report to notify us of any material error or omission caused by our negligence or if you require measurement uncertainty; provided, however, that such notice shall be in writing and shall specifically address the issue you wish to raise. A failure to raise such issue within the prescribed time shall constitute your unqualified acceptance of the completeness of this report, the tests conducted and the correctness of the report contents.



## TABLE OF CONTENTS

<b>RELEASE CONTROL RECORD .....</b>	<b>4</b>
<b>1 SUMMARY OF TEST RESULTS.....</b>	<b>5</b>
<b>2 MEASUREMENT UNCERTAINTY .....</b>	<b>5</b>
<b>3 GENERAL INFORMATION .....</b>	<b>6</b>
3.1 GENERAL DESCRIPTION OF EUT.....	6
3.2 DESCRIPTION OF TEST MODES.....	7
3.2.1. CONFIGURATION OF SYSTEM UNDER TEST .....	7
3.2.2. TEST MODE APPLICABILITY AND TESTED CHANNEL DETAIL.....	7
3.3 GENERAL DESCRIPTION OF APPLIED STANDARDS.....	10
3.4 DESCRIPTION OF SUPPORT UNITS.....	10
3.5 CONFIGURATION OF SYSTEM UNDER TEST.....	10
3.6 DUTY CYCLE OF TESET SIGNAL .....	11
<b>4 TEST TYPES AND RESULTS.....</b>	<b>12</b>
4.1 CONDUCTED EMISSION MEASUREMENT .....	12
4.1.1 LIMITS OF CONDUCTED EMISSION MEASUREMENT .....	12
4.1.2 TEST INSTRUMENTS.....	12
4.1.3 TEST PROCEDURES .....	13
4.1.4 DEVIATION FROM TEST STANDARD .....	13
4.1.5 TEST SETUP .....	14
4.1.6 EUT OPERATING CONDITIONS .....	14
4.1.7 TEST RESULTS .....	15
4.2 RADIATED EMISSION MEASUREMENT .....	17
4.2.1 LIMITS OF RADIATED EMISSION MEASUREMENT .....	17
4.2.2 TEST INSTRUMENTS.....	18
4.2.3 TEST PROCEDURES .....	19
4.2.4 DEVIATION FROM TEST STANDARD .....	20
4.2.5 TEST SETUP .....	20
4.2.6 EUT OPERATING CONDITIONS .....	21
4.2.7 TEST RESULTS .....	22
4.3 6DB BANDWIDTH MEASUREMENT.....	30
4.3.1 LIMITS OF 6DB BANDWIDTH MEASUREMENT .....	30
4.3.2 TEST INSTRUMENTS.....	30
4.3.3 TEST PROCEDURE.....	31



4.3.4 DEVIATION FROM TEST STANDARD ..... 31

4.3.5 TEST SETUP ..... 32

4.3.6 EUT OPERATING CONDITIONS ..... 32

4.3.7 TEST RESULTS ..... 33

4.4 CONDUCTED OUTPUT POWER ..... 37

4.4.1 LIMITS OF CONDUCTED OUTPUT POWER MEASUREMENT ..... 37

4.4.2 TEST SETUP ..... 37

4.4.3 TEST INSTRUMENTS ..... 37

4.4.4 TEST PROCEDURES ..... 37

4.4.5 DEVIATION FROM TEST STANDARD ..... 37

4.4.6 EUT OPERATING CONDITIONS ..... 37

4.4.7 TEST RESULTS ..... 38

4.4.7.1 MAXIMUM PEAK OUTPUT POWER ..... 38

4.4.7.2 AVERAGE OUTPUT POWER (FOR REFERENCE) ..... 39

4.5 POWER SPECTRAL DENSITY MEASUREMENT ..... 40

4.5.1 LIMITS OF POWER SPECTRAL DENSITY MEASUREMENT ..... 40

4.5.2 TEST SETUP ..... 40

4.5.3 TEST INSTRUMENTS ..... 40

4.5.4 TEST PROCEDURE ..... 40

4.5.5 DEVIATION FROM TEST STANDARD ..... 40

4.5.6 EUT OPERATING CONDITION ..... 40

4.5.7 TEST RESULTS ..... 41

4.6 OUT OF BAND EMISSION MEASUREMENT ..... 45

4.6.1 LIMITS OF OUT OF BAND EMISSION MEASUREMENT ..... 45

4.6.2 TEST SETUP ..... 45

4.6.3 TEST INSTRUMENTS ..... 45

4.6.4 TEST PROCEDURE ..... 45

4.6.5 DEVIATION FROM TEST STANDARD ..... 46

4.6.6 EUT OPERATING CONDITION ..... 46

4.6.7 TEST RESULTS ..... 47

**5 PHOTOGRAPHS OF THE TEST CONFIGURATION ..... 50**

**6 APPENDIX A - MODIFICATIONS RECORDERS FOR ENGINEERING CHANGES TO THE EUT  
BY THE LAB ..... 51**



Test Report No.: RF2305WDG0021-2

## RELEASE CONTROL RECORD

ISSUE NO.	REASON FOR CHANGE	DATE ISSUED
RF2305WDG0021-2	Original release	Aug. 04, 2023

## 1 SUMMARY OF TEST RESULTS

The EUT has been tested according to the following specifications:

APPLIED STANDARD: FCC PART 15, SUBPART C (SECTION 15.247)			
STANDARD SECTION	TEST TYPE AND LIMIT	RESULT	REMARK
15.207	AC Power Conducted Emission	PASS	Meet the requirement of limit.
15.205 15.209	Radiated Emission	PASS	Meet the requirement of limit.
15.247(d)	Out of band Emission Measurement	PASS	Meet the requirement of limit.
15.247(a)(2)	6dB bandwidth	PASS	Meet the requirement of limit.
15.247(b)	Conducted Output power	PASS	Meet the requirement of limit.
15.247(e)	Power Spectral Density	PASS	Meet the requirement of limit.
15.203	Antenna Requirement	PASS	No antenna connector is used

## 2 MEASUREMENT UNCERTAINTY

Where relevant, the following measurement uncertainty levels have been estimated for tests performed on the EUT as specified in CISPR 16-4-2:

MEASUREMENT	FREQUENCY	UNCERTAINTY
Conducted emissions	0.15MHz ~ 30MHz	2.68dB
Radiated emissions	9KHz ~ 30MHz	2.80dB
	30MHz ~ 1GMHz	4.24dB
	1GHz ~ 18GHz	4.76dB
	18GHz ~ 40GHz	4.50dB

This uncertainty represents an expanded uncertainty expressed at approximately the 95% confidence level using a coverage factor of  $k = 2$ .

### 3 GENERAL INFORMATION

#### 3.1 GENERAL DESCRIPTION OF EUT

<b>PRODUCT</b>	Portable Bluetooth Speaker
<b>MODEL NO.</b>	TOYOTA JBL FLEX
<b>ADDITIONAL MODEL</b>	N/A
<b>FCC ID</b>	2AHPN-FLEX1G
<b>NOMINAL VOLTAGE</b>	DC 7.5V From Battery or DC 5V From USB Host Unit or Powered from Dock
<b>MODULATION TECHNOLOGY</b>	DTS
<b>MODULATION TYPE</b>	BT-LE GFSK(1, 2 Mbps)
<b>OPERATING FREQUENCY</b>	2402-2480MHz
<b>PEAK OUTPUT POWER</b>	6.310mW (Max. Measured)
<b>ANTENNA TYPE</b>	PCB Antenna, 2.46dBi Gain
<b>I/O PORTS</b>	Refer to user's manual
<b>CABLE SUPPLIED</b>	USB-A to USB-C Line: Shielded, Detachable 1m

**NOTE:**

1. For a more detailed features description, please refer to the manufacturer's specifications or the user's manual.
2. For the test results, the EUT had been tested with all conditions. But only the worst case was shown in test report.
3. Please refer to the EUT photo document (Reference No.: 2305WDG0021-3) for detailed product photo.

### 3.2 DESCRIPTION OF TEST MODES

40 channels are provided for BT-LE (GFSK):

CHANNEL	FREQ. (MHZ)	CHANNEL	FREQ. (MHZ)	CHANNEL	FREQ. (MHZ)	CHANNEL	FREQ. (MHZ)
0	2402	10	2422	20	2442	30	2462
1	2404	11	2424	21	2444	31	2464
2	2406	12	2426	22	2446	32	2466
3	2408	13	2428	23	2448	33	2468
4	2410	14	2430	24	2450	34	2470
5	2412	15	2432	25	2452	35	2472
6	2414	16	2434	26	2454	36	2474
7	2416	17	2436	27	2456	37	2476
8	2418	18	2438	28	2458	38	2478
9	2420	19	2440	29	2460	39	2480

#### 3.2.1. CONFIGURATION OF SYSTEM UNDER TEST

Please see section 5 photographs of the test configuration for reference.

#### 3.2.2. TEST MODE APPLICABILITY AND TESTED CHANNEL DETAIL

Pre-Scan has been conducted to determine the worst-case mode from all possible combinations between available modulations, data rates, XYZ axis, power supply voltage range and antenna ports. The worst case was found when positioned on X axis for radiated emission. Following test modes were selected for the final test, and the final worst case is marked in boldface and recorded in the report:

EUT CONFIGURE MODE	APPLICABLE TO				DESCRIPTION
	RE<1G	RE≥1G	PLC	APCM	
<b>A</b>	√	√	√	√	<b>AC 120V/60Hz with BT Function</b>

Where **RE<1G**: Radiated Emission below 1GHz      **RE≥1G**: Radiated Emission above 1GHz  
**PLC**: Power Line Conducted Emission      **APCM**: Antenna Port Conducted Measurement



**RADIATED EMISSION TEST (BELOW 1GHz):**

- Pre-Scan has been conducted to determine the worst-case mode from all possible combinations between available modulations, data rates, XYZ axis and antenna ports (if EUT with antenna diversity architecture).
- Following channel(s) was (were) selected for the final test as listed below.

EUT CONFIGURE MODE	AVAILABLE CHANNEL	TESTED CHANNEL	MODULATION TECHNOLOGY	MODULATION TYPE	DATA RATE (Mbps)
A	0 to 39	39	DTS	GFSK	1

For the test results, only the worst case was shown in test report.

**RADIATED EMISSION TEST (ABOVE 1GHz):**

- Pre-Scan has been conducted to determine the worst-case mode from all possible combinations between available modulations, data rates, XYZ axis and antenna ports (if EUT with antenna diversity architecture).
- Following channel(s) was (were) selected for the final test as listed below.

EUT CONFIGURE MODE	AVAILABLE CHANNEL	TESTED CHANNEL	MODULATION TECHNOLOGY	MODULATION TYPE	DATA RATE (Mbps)
A	0 to 39	0,19, 39	DTS	GFSK	1
A	0 to 39	0,19, 39	DTS	GFSK	2

**POWER LINE CONDUCTED EMISSION TEST:**

- Pre-Scan has been conducted to determine the worst-case mode from all possible combinations between available modulations, antenna ports (if EUT with antenna diversity architecture), and packet types.
- Following channel(s) was (were) selected for the final test as listed below.

EUT CONFIGURE MODE	TESTED CONDITION
A	BT Link

**ANTENNA PORT CONDUCTED MEASUREMENT:**

- This item includes all test value of each mode, but only includes spectrum plot of worst value of each mode.
- Pre-Scan has been conducted to determine the worst-case mode from all possible combinations between available modulations, antenna ports (if EUT with antenna diversity architecture), and packet types.
- Following channel(s) was (were) selected for the final test as listed below.

EUT CONFIGURE MODE	AVAILABLE CHANNEL	TESTED CHANNEL	MODULATION TECHNOLOGY	MODULATION TYPE	DATA RATE (Mbps)
A	0 to 39	0,19, 39	DTS	GFSK	1
A	0 to 39	0,19, 39	DTS	GFSK	2





Test Report No.: RF2305WDG0021-2

**TEST CONDITION:**

APPLICABLE TO	ENVIRONMENTAL CONDITIONS	INPUT POWER(POE)	TESTED BY
RE<1G	25deg. C, 53%RH	AC 120V/60Hz	Jelly
RE≥1G	25deg. C, 53%RH	AC 120V/60Hz	Jelly
PLC	20deg. C, 56%RH	AC 120V/60Hz	Vincent
APCM	25deg. C, 60%RH	AC 120V/60Hz	Vincent

**Bureau Veritas Shenzhen Co., Ltd.**  
**Dongguan Branch**

No. 96, Guantai Road (Houjie Section), Houjie  
Town, Dongguan City, Guangdong Province.  
523942. People's Republic of China.

Tel: +86 769 8998 2098  
Fax: +86 769 8593 1080  
Email: [customerservice.dg@bureauveritas.com](mailto:customerservice.dg@bureauveritas.com)

### 3.3 GENERAL DESCRIPTION OF APPLIED STANDARDS

The EUT is a RF Product. According to the specifications of the manufacturer, it must comply with the requirements of the following standards:

**FCC Part 15, Subpart C, Section 15.247**

**558074 D01 15.247 Meas Guidance v05r02**

**ANSI C63.10-2013**

Note: All test items have been performed and recorded as per the above standards.

### 3.4 DESCRIPTION OF SUPPORT UNITS

The EUT has been tested as an dependent unit together with other necessary accessories or support units. The following support units or accessories were used to form a representative test configuration during the tests.

NO.	PRODUCT	BRAND	MODEL NO.	SERIAL NO.	FCC ID	REMARK
1	iPhone 6s	Apple	ML7F2CH/A	C6KQKXLAGRY8	BCG-E2946A	BV Lab.
2	Adapter	Apple	A1299	090471-11	N/A	
3	Adapter	N/A	MDY-03-EC	N/A	N/A	

NO.	DESCRIPTION OF THE ABOVE SUPPORT UNITS
1-3	N/A

### 3.5 CONFIGURATION OF SYSTEM UNDER TEST

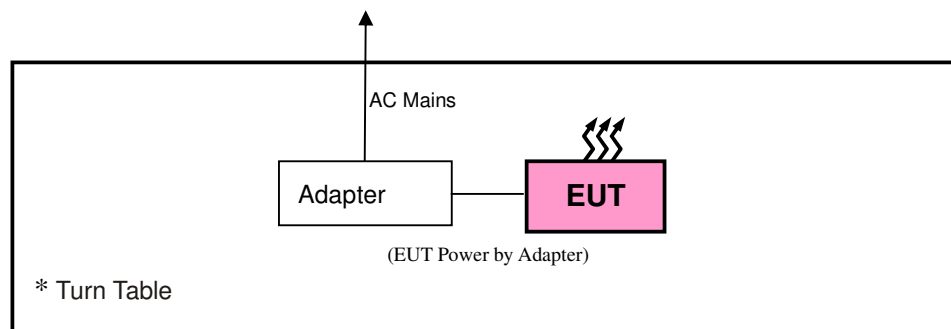

### 3.6 DUTY CYCLE OF TESET SIGNAL

Test Mode	On Time (ms)	Period (ms)	Duty Cycle (%)	1/T Min. VBW (KHz)	VBW Setting
BT-LE 1M	0.375	0.625	60.0	2.667	3KHz
BT-LE 2M	0.190	0.625	30.4	5.263	10KHz

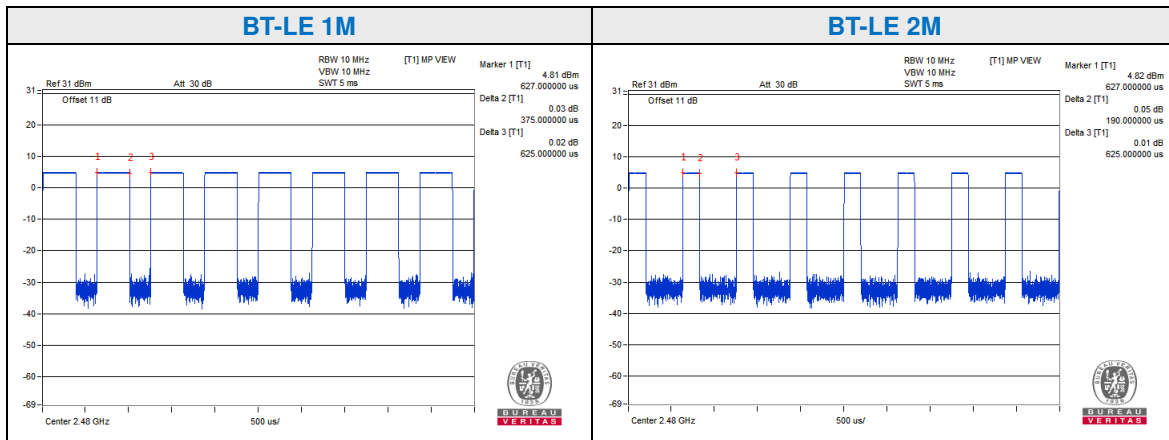

## 4 TEST TYPES AND RESULTS

### 4.1 CONDUCTED EMISSION MEASUREMENT

#### 4.1.1 LIMITS OF CONDUCTED EMISSION MEASUREMENT

FREQUENCY OF EMISSION (MHz)	CONDUCTED LIMIT (dB $\mu$ V)	
	Quasi-peak	Average
0.15 ~ 0.5	66 to 56	56 to 46
0.5 ~ 5	56	46
5 ~ 30	60	50

- NOTE:** 1. The lower limit shall apply at the transition frequencies.
2. The limit decreases in line with the logarithm of the frequency in the range of 0.15 to 0.50MHz.
3. All emanations from a class A/B digital device or system, including any network of conductors and apparatus connected thereto, shall not exceed the level of field strengths specified above.

#### 4.1.2 TEST INSTRUMENTS

Equipment	Manufacturer	Model No.	Serial No.	Next Cal.
EMI Test Receiver	Rohde&Schwarz	ESR7	101494	Jan. 10,24
Artificial Mains Network	Rohde&Schwarz	ENV216	101173	Jan. 11,24
Artificial Mains Network	Rohde&Schwarz	ESH3-Z5	100317	Jan. 10,24
V-LISN (CISPR 25)	SCHWARZBECK	NNBM 8124-200	8124-200 05857	Jun. 14, 24
V-LISN (CISPR 25)	SCHWARZBECK	NNBM 8124-200	8124-200 05858	Jun. 14, 24
Voltage probe	SCHWARZBECK	TK 9421	TK 9421-176	Jul. 27, 23
Coaxial RF Cable	SUHNER	RG 223/U-CE	C2310066DG	Jul. 24, 23
Test software	ADT	ADT_Cond_V7.3.7	N/A	N/A

**NOTES:**

- The test was performed in shielded room 553.
- The calibration interval of the above test instruments is 12 months. And the calibrations are traceable to CEPREI/CHINA, GRGT/CHINA and NIM/CHINA.



Test Report No.: RF2305WDG0021-2

#### 4.1.3 TEST PROCEDURES

- a. The EUT was placed 0.4 meters from the conducting wall of the shielded room with EUT being connected to the power mains through a line impedance stabilization network (LISN). Other support units were connected to the power mains through another LISN. The two LISNs provide 50 ohm/ 50uH of coupling impedance for the measuring instrument.
- b. Both lines of the power mains connected to the EUT were checked for maximum conducted interference.
- c. The frequency range from 150kHz to 30MHz was searched. Emission levels under (Limit - 20dB) was not recorded.

**NOTE:** All modes of operation were investigated and the worst-case emissions are reported.

#### 4.1.4 DEVIATION FROM TEST STANDARD

No deviation.

#### 4.1.5 TEST SETUP

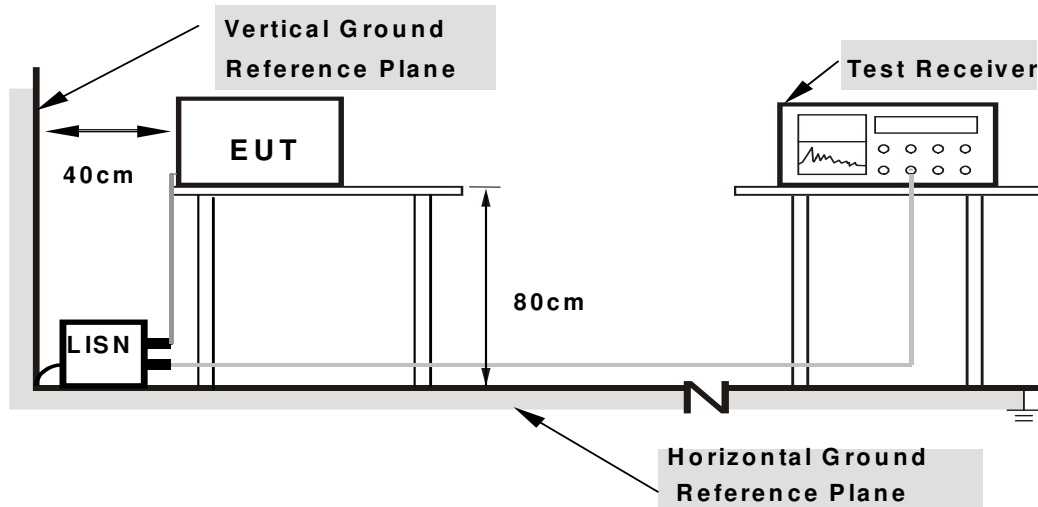

**Note: 1.Support units were connected to second LISN.**

**2.Both of LISNs (AMN) are 80 cm from EUT and at least 80 from other units and other metal planes**

For the actual test configuration, please refer to the attached file (Test Setup Photo).

#### 4.1.6 EUT OPERATING CONDITIONS

- a. Turned on the power and connected of all equipment.
- b. EUT was operated according to the type used was description in manufacturer's specifications or the User's Manual.

### 4.1.7 TEST RESULTS

#### CONDUCTED WORST-CASE DATA:

<b>PHASE</b>	Line	<b>6dB BANDWIDTH</b>	9kHz
--------------	------	----------------------	------

No.	Freq. [MHz]	Corr. Factor (dB)	Reading Value		Emission Level		Limit		Margin	
			[dB (uV)]		[dB (uV)]		[dB (uV)]		(dB)	
			Q.P.	AV.	Q.P.	AV.	Q.P.	AV.	Q.P.	AV.
1	0.31425	10.16	26.05	13.76	36.21	23.92	59.86	49.86	-23.65	-25.94
2	0.44710	10.20	28.71	20.27	38.91	30.47	56.93	46.93	-18.02	-16.46
3	0.50000	10.21	26.19	18.52	36.40	28.73	56.00	46.00	-19.60	-17.27
4	1.74975	10.25	23.59	15.84	33.84	26.09	56.00	46.00	-22.16	-19.91
5	2.91750	10.31	29.58	20.46	39.89	30.77	56.00	46.00	-16.11	-15.23
6	16.51875	10.82	31.69	21.33	42.51	32.15	60.00	50.00	-17.49	-17.85

**REMARKS:** The emission levels of other frequencies were very low against the limit.

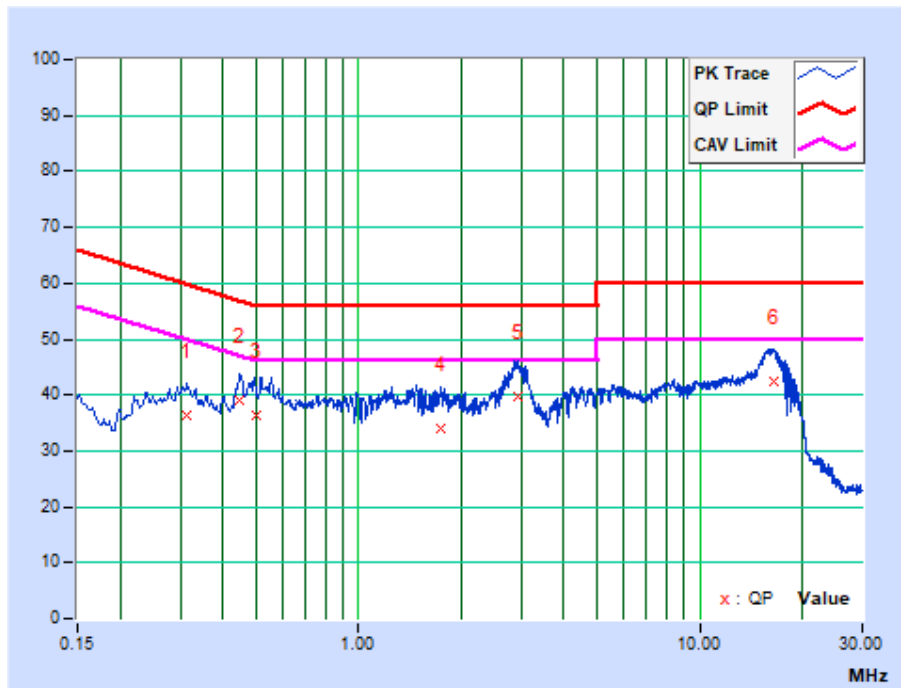

<b>PHASE</b>	Neutral	<b>6dB BANDWIDTH</b>	9kHz
--------------	---------	----------------------	------

No.	Freq. [MHz]	Corr. Factor (dB)	Reading Value		Emission Level		Limit		Margin	
			[dB (uV)]		[dB (uV)]		[dB (uV)]		(dB)	
			Q.P.	AV.	Q.P.	AV.	Q.P.	AV.	Q.P.	AV.
1	0.35816	10.16	27.72	16.49	37.88	26.65	58.77	48.77	-20.89	-22.12
2	0.40656	10.16	25.09	13.78	35.25	23.94	57.72	47.72	-22.47	-23.78
3	0.51425	10.17	27.50	15.09	37.67	25.26	56.00	46.00	-18.33	-20.74
4	0.91444	10.20	27.07	18.65	37.27	28.85	56.00	46.00	-18.73	-17.15
5	2.97600	10.29	27.31	20.72	37.60	31.01	56.00	46.00	-18.40	-14.99
6	15.94725	11.15	28.08	12.22	39.23	23.37	60.00	50.00	-20.77	-26.63

**REMARKS:** The emission levels of other frequencies were very low against the limit.

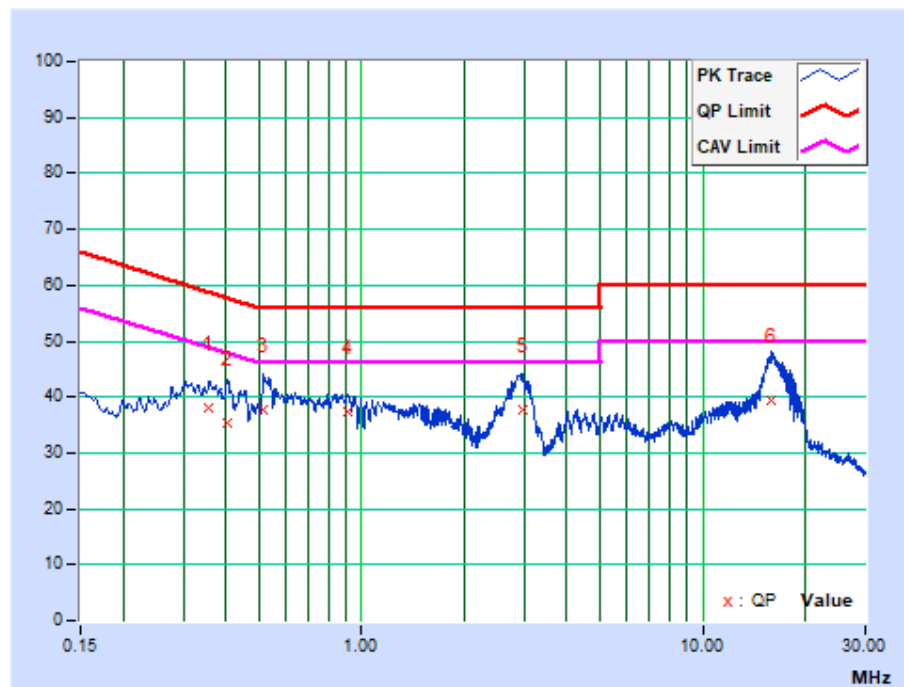





## 4.2 RADIATED EMISSION MEASUREMENT

### 4.2.1 LIMITS OF RADIATED EMISSION MEASUREMENT

Radiated emissions which fall in the restricted bands, as defined in Section 15.205(a), must also comply with the radiated emission limits specified in Section 15.209(a).

FREQUENCIES (MHz)	FIELD STRENGTH (microvolts/meter)	MEASUREMENT DISTANCE (meters)
0.009 ~ 0.490	2400/F(kHz)	300
0.490 ~ 1.705	24000/F(kHz)	30
1.705 ~ 30.0	30	30
30 ~ 88	100	3
88 ~ 216	150	3
216 ~ 960	200	3
Above 960	500	3

**NOTE:**

1. The lower limit shall apply at the transition frequencies.
2. Emission level (dBuV/m) = 20 log Emission level (uV/m).
3. As shown in 15.35(b), for frequencies above 1000MHz, the field strength limits are based on average detector, however, the peak field strength of any emission shall not exceed the maximum permitted average limits, specified above by more than 20dB under any condition of modulation.



#### 4.2.2 TEST INSTRUMENTS

Equipment	Manufacturer	Model No.	Serial No.	Next Cal.
EMI Test Receiver	Rohde&Schwarz	ESU40	100449	Jan. 10, 24
Signal and Spectrum Analyzer	Rohde&Schwarz	FSV7	102331	May. 09, 24
Active Loop Antenna (9KHz -30MHz)	SCHWARZBECK	FMZB 1519B	1519B-045	Apr. 27, 24
Amplifier (9KHz -1GHz)	Burgeon	BPA-530	100210	Mar. 06, 24
Trilog-Broadband Antenna(20M-2G)	SCHWARZBECK	VULB 9168	01282	Aug. 21, 23
Horn Antenna (1GHz -18GHz)	ETS -Lindgren	3117	00062558	Apr. 27, 24
Horn Antenna (18GHz -40GHz)	SCHWARZBECK	BBHA 9170	BBHA9170147	Apr. 28, 24
3m Semi-anechoic Chamber	ETS-LINDGREN	9m*6m*6m	NSEMC003	May 22, 24
Test Software	ADT	ADT_Radiated_V7.6.15.9.2	N/A	N/A
Broadband Pre-amplifier (1GHz~18GHz)	SCHWARZBECK	BBV9718	305	Apr. 26, 24
Pre-Amplifier (18GHz-40GHz)	EMCI	EMC 184045	980102	Jan. 16, 24
BLUETOOTH TESTER	Rohde&Schwarz	CBT32	100811	N/A

**NOTES:**

1. The test was performed in 966 Chamber.
2. The calibration interval of the above test instruments is 12 months and the calibrations are traceable to CEPREI/CHINA, GRGT/CHINA and NIM/CHINA.
3. The horn antenna is used only for the measurement of emission frequency above 1GHz if tested.
4. The FCC Site Registration No. is 749762.



#### 4.2.3 TEST PROCEDURES

- a. The EUT was placed on the top of a rotating table 1.5 meters (above 1GHz) and 0.8 meters (below 1GHz) above the ground at a 3 meters semi-anechoic chamber. The table was rotated 360 degrees to determine the position of the highest radiation.
- b. The EUT was set 3 meters away from the interference-receiving antenna, which was mounted on the top of a variable-height antenna tower.
- c. The antenna is a broadband antenna, and its height is varied from one meter to four meters above the ground to determine the maximum value of the field strength. Both horizontal and vertical polarizations of the antenna are set to make the measurement.
- d. For each suspected emission, the EUT was arranged to its worst case and then the antenna was tuned to heights from 1 meter to 4 meters and the rotatable table was turned from 0 degrees to 360 degrees to find the maximum reading.
- e. The test-receiver system was set to Peak Detect Function and Specified Bandwidth with Maximum Hold Mode.
- f. For below 30MHz, a loop antenna with its vertical plane is place 3m from the EUT and rotated about its vertical axis for maximum response at each azimuth about the EUT. And the centre of the loop shall be 1.3m above the ground.
- g. During the test, each emission was maximized by: having the EUT continuously working, investigated all operating modes, rotated about all 3 axis (X, Y & Z) and considered typical configuration to obtain worst position, manipulating interconnecting cables, For battery operated equipment, the equipment tests shall be perform using fresh batteries. The turntable was rotated to maximize the emission level.

#### NOTE:

1. The resolution bandwidth and video bandwidth of test receiver/spectrum analyzer is 120kHz for Quasi-peak detection at frequency below 1GHz.
2. The resolution bandwidth of test receiver/spectrum analyzer is 1 MHz and video bandwidth is 3MHz for Peak detection at frequency above 1GHz.
3. The resolution bandwidth of test receiver/spectrum analyzer is 1MHz and the video bandwidth is  $\geq 1/T$  (Duty cycle < 98%) for Average detection (AV) at frequency above 1GHz.
4. All modes of operation were investigated and the worst-case emissions are reported.
5. The testing of the EUT was performed on all 3 orthogonal axes; the worst-case test configuration was reported on the file test setup photo.

#### 4.2.4 DEVIATION FROM TEST STANDARD

No deviation.

#### 4.2.5 TEST SETUP

##### Below 30MHz test setup

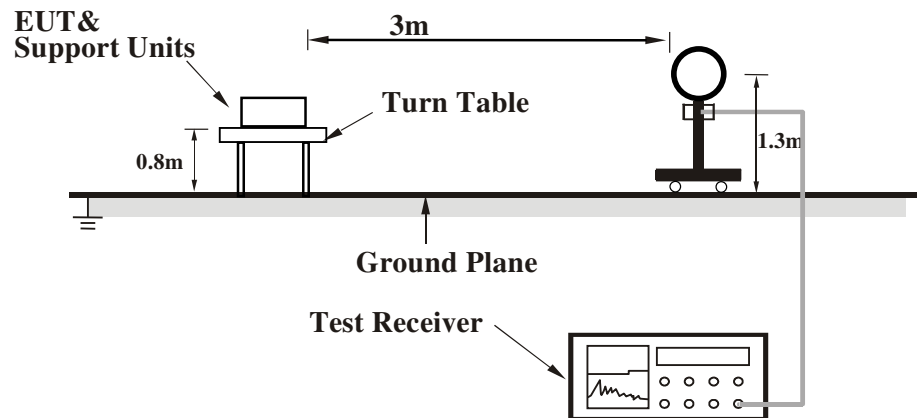

##### Below 1GHz test setup

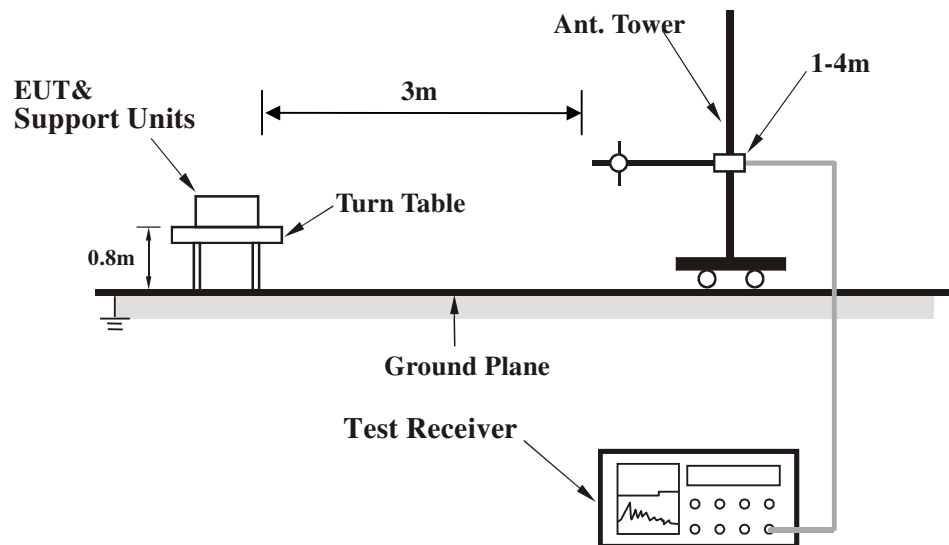

**Note:** For the actual test configuration, please refer to the attached file (Test Setup Photo).

## Above 1GHz test setup

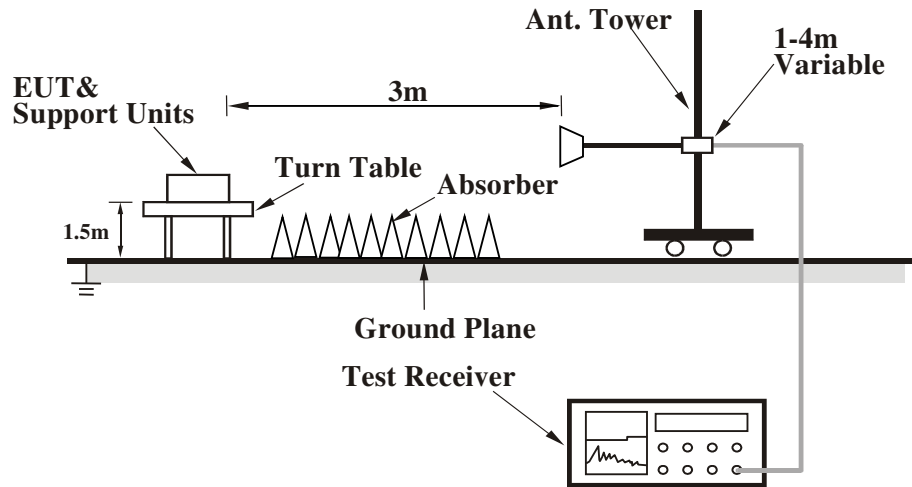

**Note:** For the actual test configuration, please refer to the attached file (Test Setup Photo).

### 4.2.6 EUT OPERATING CONDITIONS

- Set the EUT under full load condition and placed them on a testing table.
- Set the transmitter part of EUT under transmission condition continuously at specific channel frequency.
- The necessary accessories enable the EUT in full functions.

#### 4.2.7 TEST RESULTS

##### BELOW 1GHz WORST-CASE DATA:

##### BT-LE (GFSK)

<b>CHANNEL</b>	TX Channel 39	<b>DETECTOR FUNCTION</b>	Quasi-Peak (QP)
<b>FREQUENCY RANGE</b>	9KHz ~ 1GHz		

ANTENNA POLARITY & TEST DISTANCE: HORIZONTAL AT 3 M								
NO.	FREQ. (MHz)	EMISSION LEVEL (dBuV/m)	LIMIT (dBuV/m)	MARGIN (dB)	ANTENNA HEIGHT (m)	TABLE ANGLE (Degree)	RAW VALUE (dBuV)	CORRECTION FACTOR (dB/m)
1	39.33	16.18 QP	40.00	-23.82	2.00 H	280	32.70	-16.52
2	99.95	13.99 QP	43.50	-29.51	2.00 H	265	34.00	-20.01
3	277.16	13.91 QP	46.00	-32.09	2.00 H	235	29.01	-15.10
<b>4</b>	<b>432.61</b>	<b>24.05 QP</b>	<b>46.00</b>	<b>-21.95</b>	<b>2.00 H</b>	<b>248</b>	<b>34.62</b>	<b>-10.57</b>
5	581.84	21.44 QP	46.00	-24.56	2.00 H	206	28.52	-7.08
6	654.90	23.61 QP	46.00	-22.39	2.00 H	175	29.01	-5.40

##### REMARKS:

1. Emission level (dBuV/m) = Raw Value (dBuV) + Correction Factor (dB/m).
2. Correction Factor (dB/m) = Antenna Factor (dB/m) + Cable Factor (dB).
3. The emission levels of other frequencies were greater than 20dB margin.
4. 9KHz~30MHz have been test and test data more than 20dB margin.
5. Margin value = Emission level – Limit value

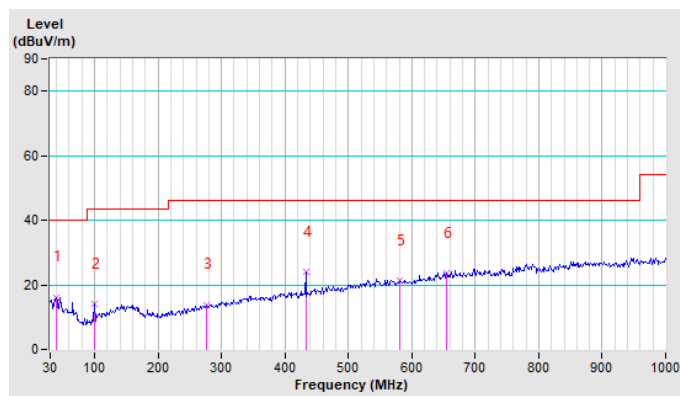



Test Report No.: RF2305WDG0021-2

<b>CHANNEL</b>	TX Channel 39	<b>DETECTOR FUNCTION</b>	Quasi-Peak (QP)
<b>FREQUENCY RANGE</b>	9KHz ~ 1GHz		

ANTENNA POLARITY & TEST DISTANCE: VERTICAL AT 3 M								
NO.	FREQ. (MHz)	EMISSION LEVEL (dBuV/m)	LIMIT (dBuV/m)	MARGIN (dB)	ANTENNA HEIGHT (m)	TABLE ANGLE (Degree)	RAW VALUE (dBuV)	CORRECTION FACTOR (dB/m)
1	39.33	16.38 QP	40.00	-23.62	1.50 V	69	32.90	-16.52
2	129.49	13.27 QP	43.50	-30.23	1.50 V	45	30.10	-16.83
3	241.41	11.34 QP	46.00	-34.66	1.50 V	128	27.94	-16.60
4	367.32	17.33 QP	46.00	-28.67	1.50 V	324	29.55	-12.22
5	501.01	19.67 QP	46.00	-26.33	1.50 V	88	28.51	-8.84
6	595.83	23.09 QP	46.00	-22.91	1.50 V	241	29.92	-6.83

**REMARKS:**

1. Emission level (dBuV/m) = Raw Value (dBuV) + Correction Factor (dB/m).
2. Correction Factor (dB/m) = Antenna Factor (dB/m) + Cable Factor (dB).
3. The emission levels of other frequencies were greater than 20dB margin.
4. 9KHz~30MHz have been test and test data more than 20dB margin.
5. Margin value = Emission level – Limit value

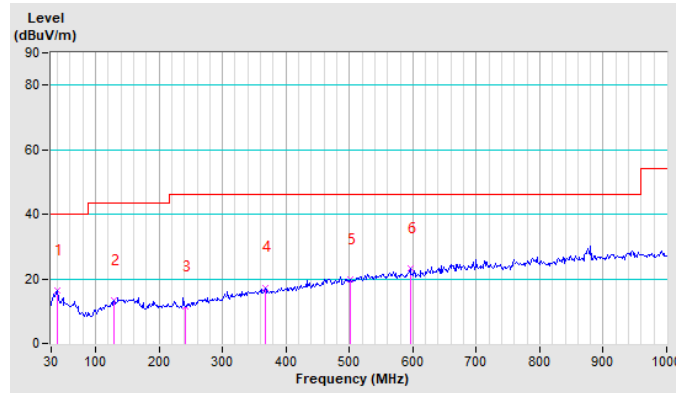

Bureau Veritas Shenzhen Co., Ltd.  
Dongguan Branch

No. 96, Guantai Road (Houjie Section), Houjie  
Town, Dongguan City, Guangdong Province.  
523942. People's Republic of China.

Tel: +86 769 8998 2098  
Fax: +86 769 8593 1080  
Email: [customerservice.dg@bureauveritas.com](mailto:customerservice.dg@bureauveritas.com)



**ABOVE 1GHz TEST DATA:**

**BT-LE (GFSK 1M)**

<b>CHANNEL</b>	TX Channel 0	<b>DETECTOR FUNCTION</b>	Peak (PK)
<b>FREQUENCY RANGE</b>	1GHz ~ 25GHz		Average (AV)

**ANTENNA POLARITY & TEST DISTANCE : HORIZONTAL AT 3 M**

NO.	FREQ. (MHz)	EMISSION LEVEL (dBuV/m)	LIMIT (dBuV/m)	MARGIN (dB)	ANTENNA HEIGHT (m)	TABLE ANGLE (Degree)	RAW VALUE (dBuV)	CORRECTION FACTOR (dB/m)
1	2390.00	47.30 PK	74.00	-26.70	1.42 H	204	44.61	2.69
2	2390.00	36.49 AV	54.00	-17.51	1.42 H	204	33.80	2.69
3	*2402.00	105.07 PK			1.42 H	204	102.34	2.73
4	*2402.00	104.66 AV			1.42 H	204	101.93	2.73
5	4804.00	50.29 PK	74.00	-23.71	1.80 H	90	42.08	8.21
6	4804.00	38.99 AV	54.00	-15.01	1.80 H	90	30.78	8.21
7	#7206.00	53.29 PK	74.00	-20.71	1.06 H	320	43.76	9.53
8	#7206.00	40.00 AV	54.00	-14.00	1.06 H	320	30.47	9.53

**ANTENNA POLARITY & TEST DISTANCE : VERTICAL AT 3 M**

NO.	FREQ. (MHz)	EMISSION LEVEL (dBuV/m)	LIMIT (dBuV/m)	MARGIN (dB)	ANTENNA HEIGHT (m)	TABLE ANGLE (Degree)	RAW VALUE (dBuV)	CORRECTION FACTOR (dB/m)
1	2390.00	51.29 PK	74.00	-22.71	1.70 V	358	48.60	2.69
2	2390.00	39.84 AV	54.00	-14.16	1.70 V	358	37.15	2.69
3	*2402.00	107.27 PK			1.70 V	358	104.54	2.73
4	*2402.00	106.25 AV			1.70 V	358	103.52	2.73
5	4804.00	51.34 PK	74.00	-22.66	1.50 V	90	43.13	8.21
6	4804.00	41.39 AV	54.00	-12.61	1.50 V	90	33.18	8.21
7	#7206.00	51.29 PK	74.00	-22.71	1.06 V	95	41.76	9.53
8	#7206.00	40.39 AV	54.00	-13.61	1.06 V	95	30.86	9.53

**REMARKS:**

1. Emission level (dBuV/m) = Raw Value (dBuV) + Correction Factor (dB/m).
2. Correction Factor (dB/m) = Antenna Factor (dB/m) + Cable Factor (dB).
3. The emission levels of other frequencies were greater than 20dB margin.
4. Margin value = Emission level – Limit value.
5. " \* ": Fundamental frequency.
6. " # ": The radiated frequency is out of the restricted band.



<b>CHANNEL</b>	TX Channel 19	<b>DETECTOR FUNCTION</b>	Peak (PK)
<b>FREQUENCY RANGE</b>	1GHz ~ 25GHz		Average (AV)

ANTENNA POLARITY & TEST DISTANCE : HORIZONTAL AT 3 M								
NO.	FREQ. (MHz)	EMISSION LEVEL (dBuV/m)	LIMIT (dBuV/m)	MARGIN (dB)	ANTENNA HEIGHT (m)	TABLE ANGLE (Degree)	RAW VALUE (dBuV)	CORRECTION FACTOR (dB/m)
1	*2440.00	106.26 PK			1.00 H	32	103.41	2.85
2	*2440.00	105.60 AV			1.00 H	32	102.75	2.85
3	4880.00	53.29 PK	74.00	-20.71	1.09 H	52	44.55	8.74
4	4880.00	42.90 AV	54.00	-11.10	1.09 H	52	34.16	8.74
5	7320.00	52.39 PK	74.00	-21.61	1.09 H	85	42.80	9.59
6	7320.00	42.90 AV	54.00	-11.10	1.09 H	85	33.31	9.59
ANTENNA POLARITY & TEST DISTANCE : VERTICAL AT 3 M								
NO.	FREQ. (MHz)	EMISSION LEVEL (dBuV/m)	LIMIT (dBuV/m)	MARGIN (dB)	ANTENNA HEIGHT (m)	TABLE ANGLE (Degree)	RAW VALUE (dBuV)	CORRECTION FACTOR (dB/m)
1	*2440.00	107.73 PK			1.70 V	360	104.88	2.85
2	*2440.00	106.61 AV			1.70 V	360	103.76	2.85
3	4880.00	51.69 PK	74.00	-22.31	1.06 V	22	42.95	8.74
4	4880.00	40.32 AV	54.00	-13.68	1.06 V	22	31.58	8.74
5	7320.00	52.39 PK	74.00	-21.61	1.06 V	304	42.80	9.59
6	7320.00	41.80 AV	54.00	-12.20	1.06 V	304	32.21	9.59

**REMARKS:**

1. Emission level (dBuV/m) = Raw Value (dBuV) + Correction Factor (dB/m).
2. Correction Factor (dB/m) = Antenna Factor (dB/m) + Cable Factor (dB).
3. The emission levels of other frequencies were greater than 20dB margin.
4. Margin value = Emission level – Limit value.
5. " \* " : Fundamental frequency.

<b>CHANNEL</b>	TX Channel 39	<b>DETECTOR FUNCTION</b>	Peak (PK)
<b>FREQUENCY RANGE</b>	1GHz ~ 25GHz		Average (AV)

ANTENNA POLARITY & TEST DISTANCE : HORIZONTAL AT 3 M								
NO.	FREQ. (MHz)	EMISSION LEVEL (dBuV/m)	LIMIT (dBuV/m)	MARGIN (dB)	ANTENNA HEIGHT (m)	TABLE ANGLE (Degree)	RAW VALUE (dBuV)	CORRECTION FACTOR (dB/m)
1	*2480.00	101.44 PK			1.76 H	107	98.47	2.97
2	*2480.00	100.83 AV			1.76 H	107	97.86	2.97
3	2483.50	52.39 PK	74.00	-21.61	1.06 H	95	49.41	2.98
4	2483.50	41.26 AV	54.00	-12.74	1.06 H	95	38.28	2.98
5	4960.00	51.29 PK	74.00	-22.71	1.09 H	63	41.99	9.30
6	4960.00	41.29 AV	54.00	-12.71	1.09 H	63	31.99	9.30
7	7440.00	52.39 PK	74.00	-21.61	1.09 H	252	42.73	9.66
8	7440.00	40.28 AV	54.00	-13.72	1.09 H	252	30.62	9.66
ANTENNA POLARITY & TEST DISTANCE : VERTICAL AT 3 M								
NO.	FREQ. (MHz)	EMISSION LEVEL (dBuV/m)	LIMIT (dBuV/m)	MARGIN (dB)	ANTENNA HEIGHT (m)	TABLE ANGLE (Degree)	RAW VALUE (dBuV)	CORRECTION FACTOR (dB/m)
1	*2480.00	107.17 PK			2.09 V	172	104.20	2.97
2	*2480.00	106.77 AV			2.09 V	172	103.80	2.97
3	2483.50	54.00 PK	74.00	-20.00	2.09 V	172	51.02	2.98
4	2483.50	38.50 AV	54.00	-15.50	2.09 V	172	35.52	2.98
5	4960.00	52.39 PK	74.00	-21.61	1.06 V	95	43.09	9.30
6	4960.00	40.26 AV	54.00	-13.74	1.06 V	95	30.96	9.30
7	7440.00	52.39 PK	74.00	-21.61	1.09 V	66	42.73	9.66
8	7440.00	40.32 AV	54.00	-13.68	1.09 V	66	30.66	9.66

**REMARKS:**

1. Emission level (dBuV/m) = Raw Value (dBuV) + Correction Factor (dB/m).
2. Correction Factor (dB/m) = Antenna Factor (dB/m) + Cable Factor (dB).
3. The emission levels of other frequencies were greater than 20dB margin.
4. Margin value = Emission level – Limit value.
5. " \* " : Fundamental frequency.

**BT-LE (GFSK 2M)**

<b>CHANNEL</b>	TX Channel 0	<b>DETECTOR FUNCTION</b>	Peak (PK)
<b>FREQUENCY RANGE</b>	1GHz ~ 25GHz		Average (AV)

ANTENNA POLARITY & TEST DISTANCE : HORIZONTAL AT 3 M								
NO.	FREQ. (MHz)	EMISSION LEVEL (dBuV/m)	LIMIT (dBuV/m)	MARGIN (dB)	ANTENNA HEIGHT (m)	TABLE ANGLE (Degree)	RAW VALUE (dBuV)	CORRECTION FACTOR (dB/m)
1	2390.00	49.90 PK	74.00	-24.10	1.10 H	208	47.21	2.69
2	2390.00	36.17 AV	54.00	-17.83	1.10 H	208	33.48	2.69
3	*2402.00	104.10 PK			1.00 H	208	101.37	2.73
4	*2402.00	101.31 AV			1.00 H	208	98.58	2.73
5	4804.00	52.39 PK	74.00	-21.61	1.62 H	90	44.18	8.21
6	4804.00	40.29 AV	54.00	-13.71	1.62 H	90	32.08	8.21
7	#7206.00	53.90 PK	74.00	-20.10	1.09 H	33	44.37	9.53
8	#7206.00	40.39 AV	54.00	-13.61	1.09 H	33	30.86	9.53
ANTENNA POLARITY & TEST DISTANCE : VERTICAL AT 3 M								
NO.	FREQ. (MHz)	EMISSION LEVEL (dBuV/m)	LIMIT (dBuV/m)	MARGIN (dB)	ANTENNA HEIGHT (m)	TABLE ANGLE (Degree)	RAW VALUE (dBuV)	CORRECTION FACTOR (dB/m)
1	2390.00	48.56 PK	74.00	-25.44	1.26 V	16	45.87	2.69
2	2390.00	39.00 AV	54.00	-15.00	1.26 V	16	36.31	2.69
3	*2402.00	107.90 PK			1.26 V	16	105.17	2.73
4	*2402.00	104.31 AV			1.26 V	16	101.58	2.73
5	4804.00	52.78 PK	74.00	-21.22	1.09 V	50	44.57	8.21
6	4804.00	38.00 AV	54.00	-16.00	1.09 V	50	29.79	8.21
7	#7206.00	52.39 PK	74.00	-21.61	1.08 V	96	42.86	9.53
8	#7206.00	41.80 AV	54.00	-12.20	1.08 V	96	32.27	9.53

**REMARKS:**

1. Emission level (dBuV/m) = Raw Value (dBuV) + Correction Factor (dB/m).
2. Correction Factor (dB/m) = Antenna Factor (dB/m) + Cable Factor (dB).
3. The emission levels of other frequencies were greater than 20dB margin.
4. Margin value = Emission level – Limit value.
5. " \* ": Fundamental frequency.
6. " # ": The radiated frequency is out of the restricted band.



Test Report No.: RF2305WDG0021-2

<b>CHANNEL</b>	TX Channel 19	<b>DETECTOR FUNCTION</b>	Peak (PK)
<b>FREQUENCY RANGE</b>	1GHz ~ 25GHz		Average (AV)

ANTENNA POLARITY & TEST DISTANCE : HORIZONTAL AT 3 M								
NO.	FREQ. (MHz)	EMISSION LEVEL (dBuV/m)	LIMIT (dBuV/m)	MARGIN (dB)	ANTENNA HEIGHT (m)	TABLE ANGLE (Degree)	RAW VALUE (dBuV)	CORRECTION FACTOR (dB/m)
1	*2440.00	104.39 PK			1.09 H	210	101.54	2.85
2	*2440.00	102.30 AV			1.09 H	210	99.45	2.85
3	4880.00	51.29 PK	74.00	-22.71	1.06 H	123	42.55	8.74
4	4880.00	40.32 AV	54.00	-13.68	1.06 H	123	31.58	8.74
5	7320.00	53.29 PK	74.00	-20.71	1.09 H	323	43.70	9.59
6	7320.00	40.30 AV	54.00	-13.70	1.09 H	323	30.71	9.59
ANTENNA POLARITY & TEST DISTANCE : VERTICAL AT 3 M								
NO.	FREQ. (MHz)	EMISSION LEVEL (dBuV/m)	LIMIT (dBuV/m)	MARGIN (dB)	ANTENNA HEIGHT (m)	TABLE ANGLE (Degree)	RAW VALUE (dBuV)	CORRECTION FACTOR (dB/m)
1	*2440.00	107.40 PK			1.69 V	52	104.55	2.85
2	*2440.00	103.00 AV			1.69 V	52	100.15	2.85
3	4880.00	52.39 PK	74.00	-21.61	2.30 V	96	43.65	8.74
4	4880.00	39.40 AV	54.00	-14.60	2.30 V	96	30.66	8.74
5	7320.00	51.60 PK	74.00	-22.40	1.09 V	322	42.01	9.59
6	7320.00	40.30 AV	54.00	-13.70	1.09 V	322	30.71	9.59

**REMARKS:**

1. Emission level (dBuV/m) = Raw Value (dBuV) + Correction Factor (dB/m).
2. Correction Factor (dB/m) = Antenna Factor (dB/m) + Cable Factor (dB).
3. The emission levels of other frequencies were greater than 20dB margin.
4. Margin value = Emission level – Limit value.
5. " \* " : Fundamental frequency.

Bureau Veritas Shenzhen Co., Ltd.  
Dongguan Branch

No. 96, Guantai Road (Houjie Section), Houjie  
Town, Dongguan City, Guangdong Province.  
523942. People's Republic of China.

Tel: +86 769 8998 2098  
Fax: +86 769 8593 1080  
Email: [customerservice.dg@bureauveritas.com](mailto:customerservice.dg@bureauveritas.com)



Test Report No.: RF2305WDG0021-2

<b>CHANNEL</b>	TX Channel 39	<b>DETECTOR FUNCTION</b>	Peak (PK)
<b>FREQUENCY RANGE</b>	1GHz ~ 25GHz		Average (AV)

ANTENNA POLARITY & TEST DISTANCE : HORIZONTAL AT 3 M								
NO.	FREQ. (MHz)	EMISSION LEVEL (dBuV/m)	LIMIT (dBuV/m)	MARGIN (dB)	ANTENNA HEIGHT (m)	TABLE ANGLE (Degree)	RAW VALUE (dBuV)	CORRECTION FACTOR (dB/m)
1	*2480.00	104.60 PK			1.10 H	70	101.63	2.97
2	*2480.00	102.60 AV			1.10 H	70	99.63	2.97
3	2483.50	54.50 PK	74.00	-19.50	1.10 H	70	51.52	2.98
4	2483.50	41.29 AV	54.00	-12.71	1.10 H	70	38.31	2.98
5	4960.00	49.96 PK	74.00	-24.04	1.06 H	92	40.66	9.30
6	4960.00	43.60 AV	54.00	-10.40	1.06 H	92	34.30	9.30
7	7440.00	52.39 PK	74.00	-21.61	1.00 H	38	42.73	9.66
8	7440.00	41.39 AV	54.00	-12.61	1.00 H	38	31.73	9.66
ANTENNA POLARITY & TEST DISTANCE : VERTICAL AT 3 M								
NO.	FREQ. (MHz)	EMISSION LEVEL (dBuV/m)	LIMIT (dBuV/m)	MARGIN (dB)	ANTENNA HEIGHT (m)	TABLE ANGLE (Degree)	RAW VALUE (dBuV)	CORRECTION FACTOR (dB/m)
1	*2480.00	107.31 PK			2.11 V	320	104.34	2.97
2	*2480.00	103.88 AV			2.11 V	320	100.91	2.97
3	2483.50	58.19 PK	74.00	-15.81	2.11 V	320	55.21	2.98
4	2483.50	43.61 AV	54.00	-10.39	2.11 V	320	40.63	2.98
5	4960.00	51.29 PK	74.00	-22.71	1.62 V	55	41.99	9.30
6	4960.00	42.32 AV	54.00	-11.68	1.62 V	55	33.02	9.30
7	7440.00	52.39 PK	74.00	-21.61	1.77 V	33	42.73	9.66
8	7440.00	41.30 AV	54.00	-12.70	1.77 V	33	31.64	9.66

**REMARKS:**

1. Emission level (dBuV/m) = Raw Value (dBuV) + Correction Factor (dB/m).
2. Correction Factor (dB/m) = Antenna Factor (dB/m) + Cable Factor (dB).
3. The emission levels of other frequencies were greater than 20dB margin.
4. Margin value = Emission level – Limit value.
5. " \* " : Fundamental frequency.

Bureau Veritas Shenzhen Co., Ltd.  
Dongguan Branch

No. 96, Guantai Road (Houjie Section), Houjie  
Town, Dongguan City, Guangdong Province.  
523942. People's Republic of China.

Tel: +86 769 8998 2098  
Fax: +86 769 8593 1080  
Email: [customerservice.dg@bureauveritas.com](mailto:customerservice.dg@bureauveritas.com)

### 4.3 6dB BANDWIDTH MEASUREMENT

#### 4.3.1 LIMITS OF 6dB BANDWIDTH MEASUREMENT

The minimum of 6dB Bandwidth Measurement is 0.5 MHz.

#### 4.3.2 TEST INSTRUMENTS

Equipment	Manufacturer	Model No.	Serial No.	Next Cal.
Power Sensor	Keysight	U2021XA	MY57320002	Jan. 11, 24
Power Meter	Anritsu	ML2495A	1139001	Aug. 22, 23
Power Sensor	Anritsu	MA2411B	1531155	Aug. 22, 23
Digital Multimeter	FLUKE	15B	A1220010DG	N/A
Humid & Temp Programmable Tester	Haida	HD-225T	110807201	Nov. 02, 23
Oscilloscope	Agilent	DSO9254A	MY51260160	Jul. 27, 23
Signal and Spectrum Analyzer	Rohde&Schwarz	FSV40	101094	Jan. 11, 24
Signal Generator	Agilent	N5183A	MY50140980	Jul. 20, 23
MXG-B RF Vector Signal Generator	Keysight	N5182B	MY56200288	Jul. 20, 23
BLUETOOTH TESTER	Rohde&Schwarz	CBT32	100811	N/A
Attenuator	MINI	BW-S10W2+	S130129FGE2	N/A
DC Source	Keysight	E3642A	MY56146098	N/A
Test software	ADT	ADT_RF Test Software V6.6.5.3	N/A	N/A

**NOTES:**

1. The test was performed in RF Oven room.
2. The calibration interval of the above test instruments is 12 months and the calibrations are traceable to CEPREI/CHINA, GRGT/CHINA and NIM/CHINA.



#### 4.3.3 TEST PROCEDURE

1. Set RBW = 100 kHz.
2. Set the video bandwidth (VBW)  $\geq 3$  RBW.
3. Detector = Peak.
4. Trace mode = max hold.
5. Sweep = auto couple.
6. Allow the trace to stabilize.
7. Measure the maximum width of the emission that is constrained by the frequencies associated with the two outermost amplitude points (upper and lower frequencies) that are attenuated by 6 dB relative to the maximum level measured in the fundamental emission.

#### 4.3.4 DEVIATION FROM TEST STANDARD

No deviation.

#### 4.3.5 TEST SETUP

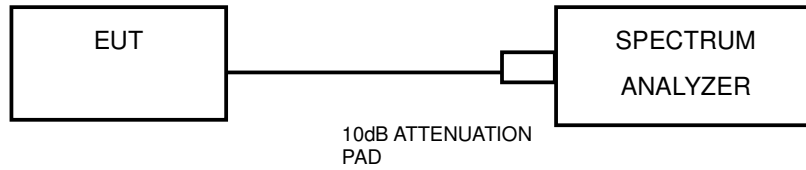

#### 4.3.6 EUT OPERATING CONDITIONS

The software provided by client to enable the EUT under transmission condition continuously at lowest, middle and highest channel frequencies individually.



### 4.3.7 TEST RESULTS

#### BT-LE (GFSK 1M)

CHANNEL	CHANNEL FREQUENCY (MHz)	6dB BANDWIDTH (MHz)	MINIMUM LIMIT (MHz)	PASS / FAIL
0	2402	0.72	0.5	PASS
19	2440	0.72	0.5	PASS
39	2480	0.72	0.5	PASS

#### CH0

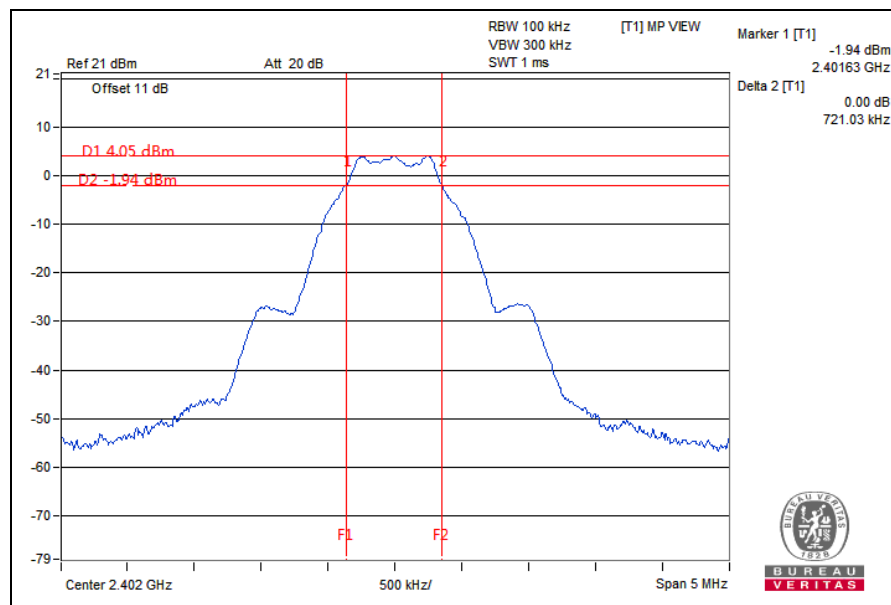

CH19

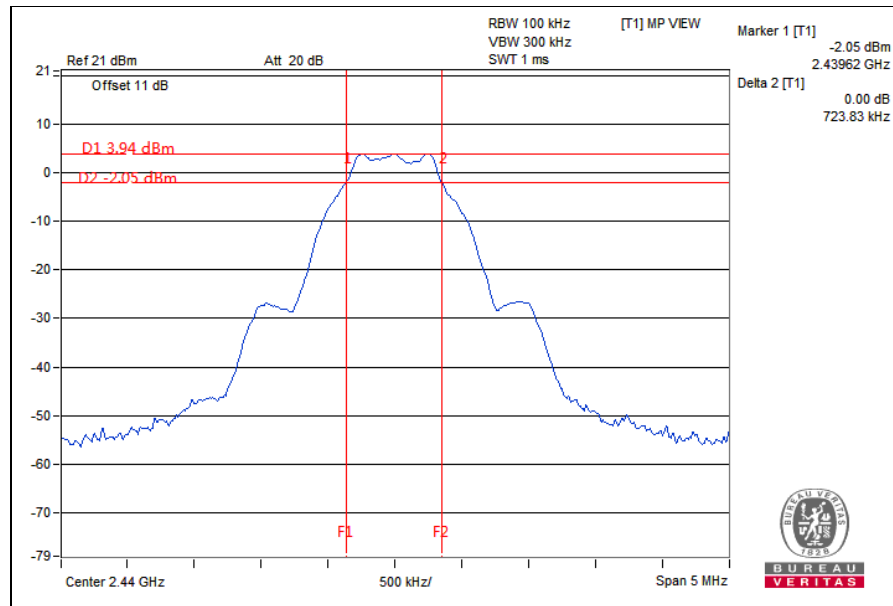

CH40

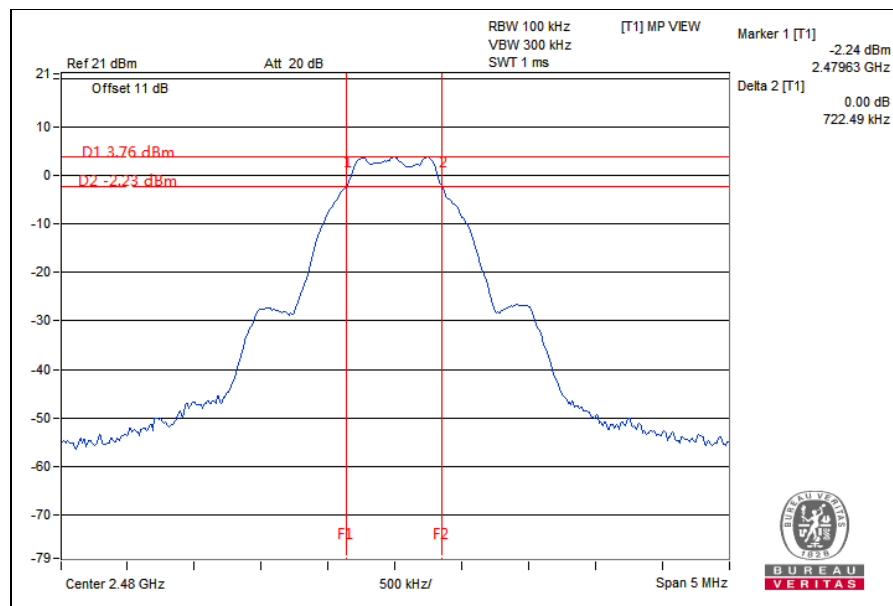

**BT-LE (GFSK 2M)**

CHANNEL	CHANNEL FREQUENCY (MHz)	6dB BANDWIDTH (MHz)	MINIMUM LIMIT (MHz)	PASS / FAIL
0	2402	1.27	0.5	PASS
19	2440	1.26	0.5	PASS
39	2480	1.26	0.5	PASS

**CH0**

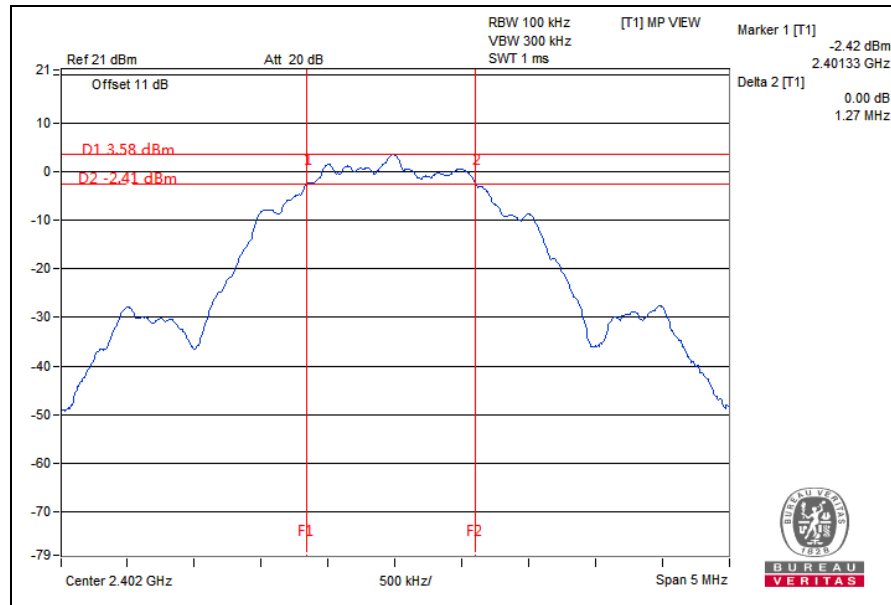

CH19

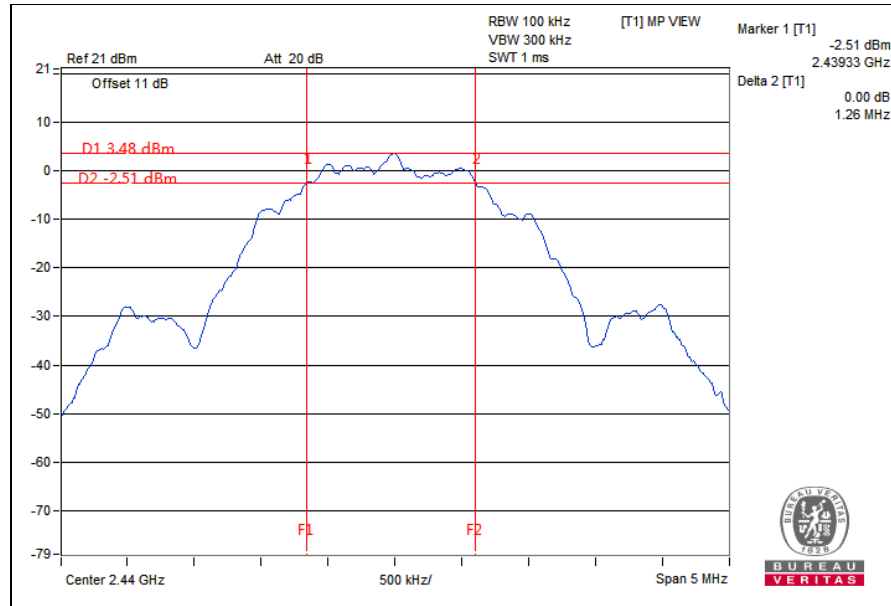

CH40

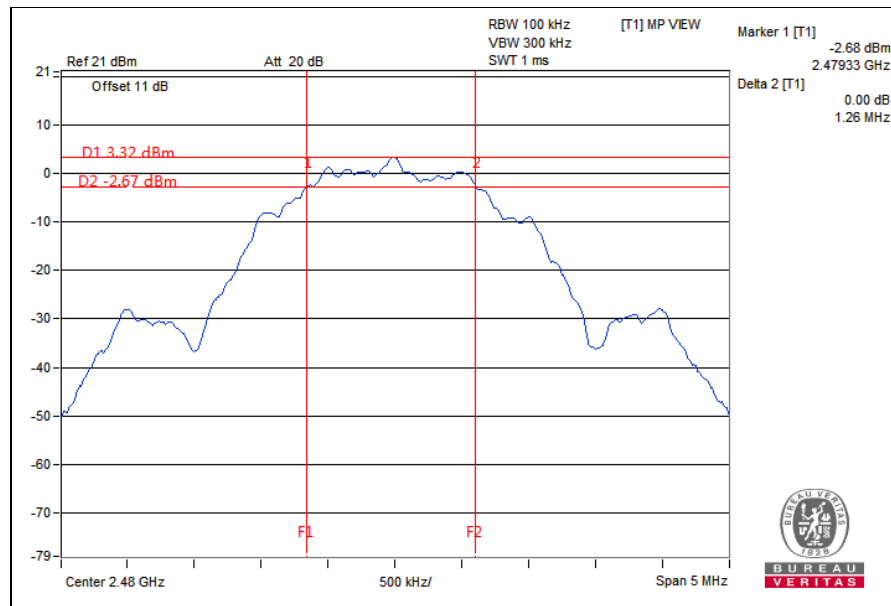

## 4.4 CONDUCTED OUTPUT POWER

### 4.4.1 LIMITS OF CONDUCTED OUTPUT POWER MEASUREMENT

For systems using digital modulation in the 2400–2483.5 MHz band: 1 Watt (30dBm)

### 4.4.2 TEST SETUP

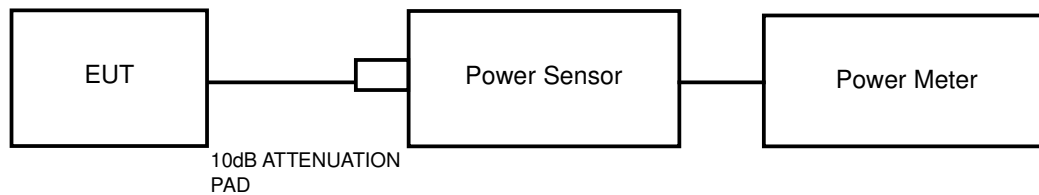

### 4.4.3 TEST INSTRUMENTS

Refer to section 4.3.2 to get information of above instrument.

### 4.4.4 TEST PROCEDURES

A peak power sensor was used on the output port of the EUT. A power meter was used to read the response of the peak power sensor and set the detector to PEAK. Record the power level.

An average power sensor was used on the output port of the EUT. A power meter was used to read the response of the average power sensor and set the detector to AVERAGE. Record the power level.

### 4.4.5 DEVIATION FROM TEST STANDARD

No deviation.

### 4.4.6 EUT OPERATING CONDITIONS

The software provided by client to enable the EUT under transmission condition continuously at lowest, middle and highest channel frequencies individually.

#### 4.4.7 TEST RESULTS

##### 4.4.7.1 MAXIMUM PEAK OUTPUT POWER

###### BT-LE (GFSK 1M)

CHANNEL	CHANNEL FREQUENCY (MHz)	PEAK POWER (dBm)	PEAK POWER (mW)	PEAK POWER LIMIT (W)	PASS/FAIL
0	2402	6.82	4.808	1	PASS
19	2440	6.60	4.571	1	PASS
39	2480	6.52	4.487	1	PASS

###### BT-LE (GFSK 2M)

CHANNEL	CHANNEL FREQUENCY (MHz)	PEAK POWER (dBm)	PEAK POWER (mW)	PEAK POWER LIMIT (W)	PASS/FAIL
0	2402	<b>8.00</b>	<b>6.310</b>	1	PASS
19	2440	7.72	5.916	1	PASS
39	2480	7.52	5.649	1	PASS

#### 4.4.7.2 AVERAGE OUTPUT POWER (FOR REFERENCE)

The average power sensor was used on the output port of the EUT. A power meter was used to read the response of the power sensor. Record the power level.

##### BT-LE (GFSK 1M)

CHANNEL	CHANNEL FREQUENCY (MHz)	AVERAGE POWER (dBm)
0	2402	5.22
19	2440	4.92
39	2480	4.51

##### BT-LE (GFSK 2M)

CHANNEL	CHANNEL FREQUENCY (MHz)	AVERAGE POWER (dBm)
0	2402	5.27
19	2440	5.01
39	2480	4.64

## 4.5 POWER SPECTRAL DENSITY MEASUREMENT

### 4.5.1 LIMITS OF POWER SPECTRAL DENSITY MEASUREMENT

The Maximum of Power Spectral Density Measurement is 8dBm/3KHz.

### 4.5.2 TEST SETUP

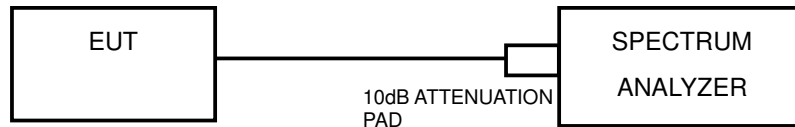

### 4.5.3 TEST INSTRUMENTS

Refer to section 4.3.2 to get information of above instrument.

### 4.5.4 TEST PROCEDURE

1. Set the span to 1.5 times the DTS bandwidth
2. Set the RBW = 3 kHz, VBW  $\geq 3 \times$  RBW, Detector = peak.
3. Sweep time = auto couple, Trace mode = max hold, allow trace to fully stabilize.
4. Use the peak marker function to determine the maximum amplitude level.

### 4.5.5 DEVIATION FROM TEST STANDARD

No deviation.

### 4.5.6 EUT OPERATING CONDITION

The software provided by client to enable the EUT under transmission condition continuously at lowest, middle and highest channel frequencies individually.



### 4.5.7 TEST RESULTS

#### BT-LE (GFSK 1M)

Channel	FREQ. (MHz)	PSD (dBm/3kHz)	Limit (dBm/3kHz)	PASS /FAIL
0	2402	-10.49	8	PASS
19	2440	-10.67	8	PASS
39	2480	-10.83	8	PASS

#### CHO

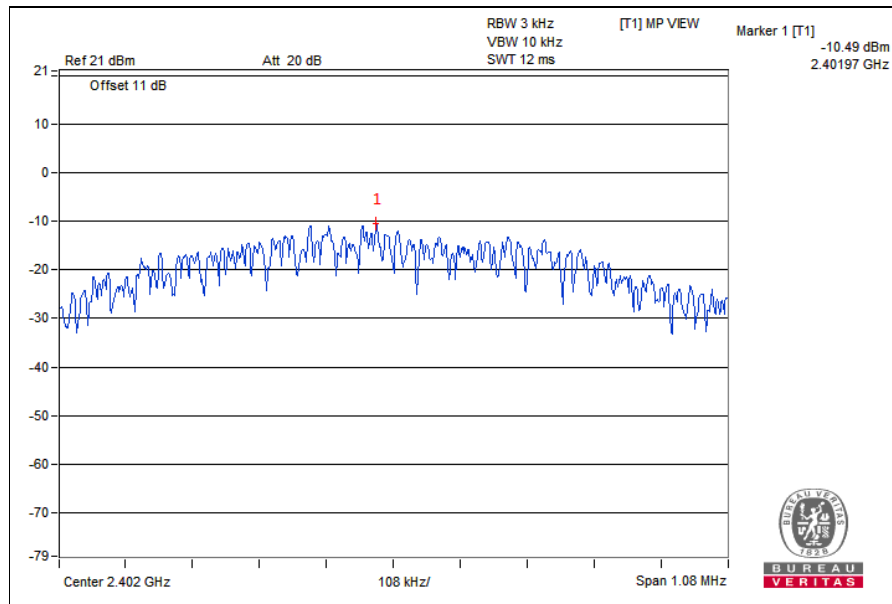



Test Report No.: RF2305WDG0021-2

CH19

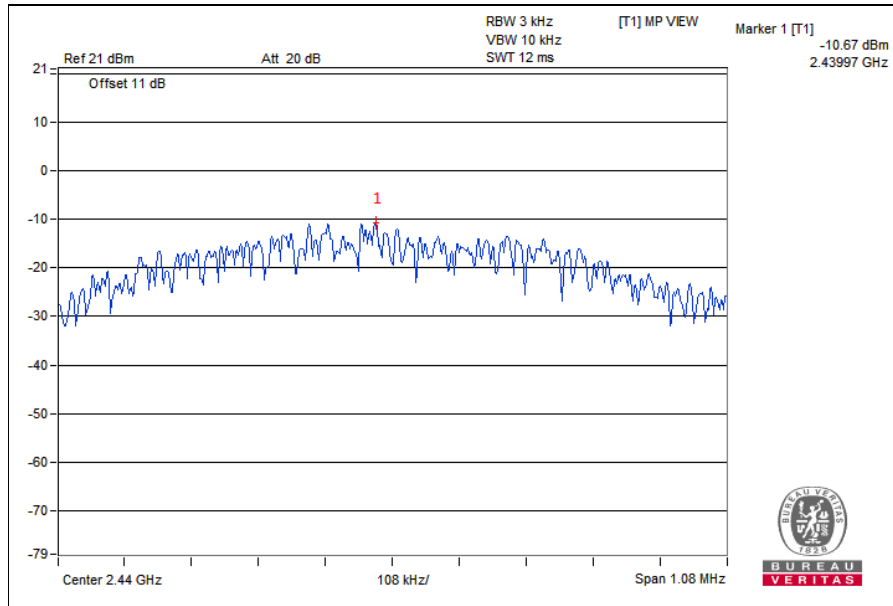

CH39

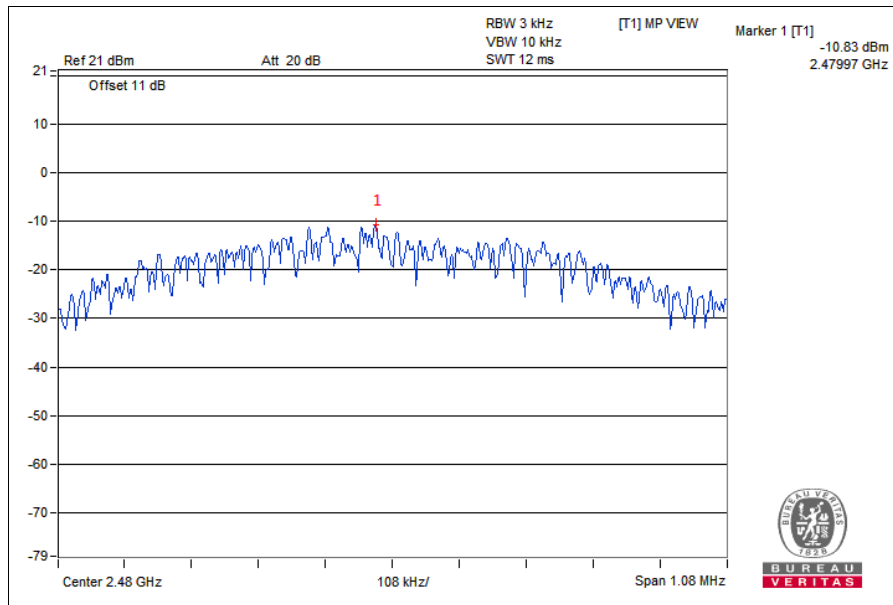

Bureau Veritas Shenzhen Co., Ltd.  
Dongguan Branch

No. 96, Guantai Road (Houjie Section), Houjie  
Town, Dongguan City, Guangdong Province.  
523942. People's Republic of China.

Tel: +86 769 8998 2098  
Fax: +86 769 8593 1080  
Email: [customerservice.dg@bureauveritas.com](mailto:customerservice.dg@bureauveritas.com)



Test Report No.: RF2305WDG0021-2

BT-LE (GFSK 2M)

Channel	FREQ. (MHz)	PSD (dBm/3kHz)	Limit (dBm/3kHz)	PASS /FAIL
0	2402	-12.73	8	PASS
19	2440	-12.93	8	PASS
39	2480	-13.04	8	PASS

CHO

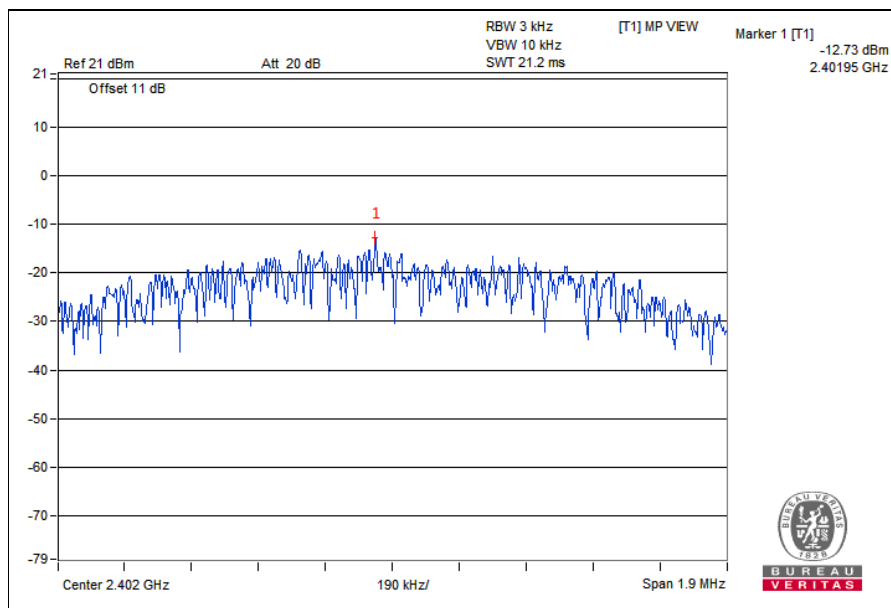

Bureau Veritas Shenzhen Co., Ltd.  
 Dongguan Branch

No. 96, Guantai Road (Houjie Section), Houjie  
 Town, Dongguan City, Guangdong Province.  
 523942. People's Republic of China.

Tel: +86 769 8998 2098  
 Fax: +86 769 8593 1080  
 Email: [customerservice.dg@bureauveritas.com](mailto:customerservice.dg@bureauveritas.com)

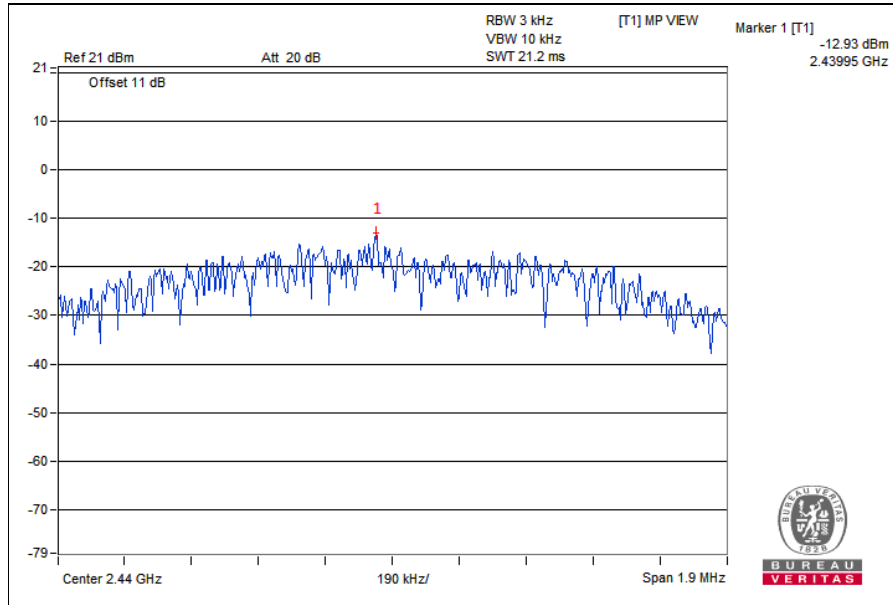

CH39

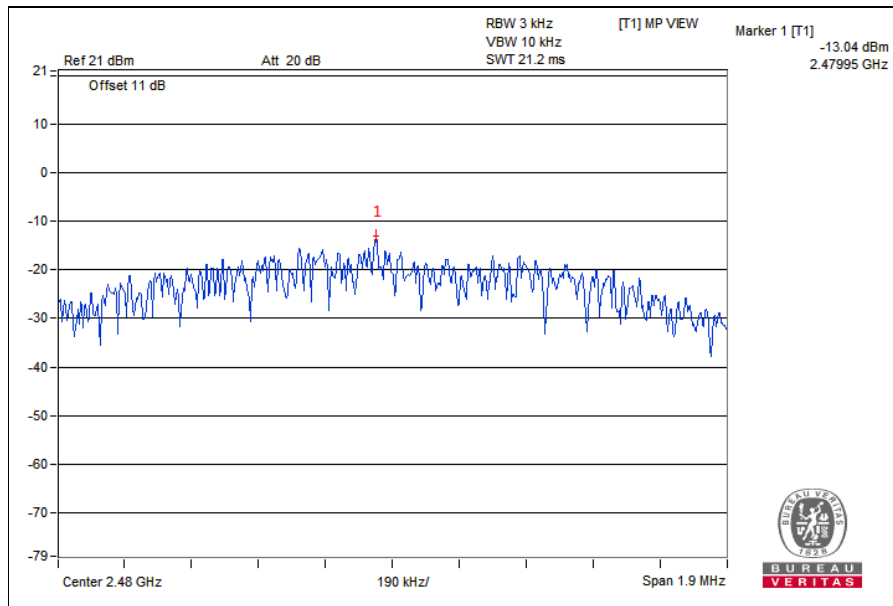

## 4.6 OUT OF BAND EMISSION MEASUREMENT

### 4.6.1 LIMITS OF OUT OF BAND EMISSION MEASUREMENT

Below  $-20\text{dB}$  of the highest emission level of operating band (in 100kHz Resolution Bandwidth).

### 4.6.2 TEST SETUP

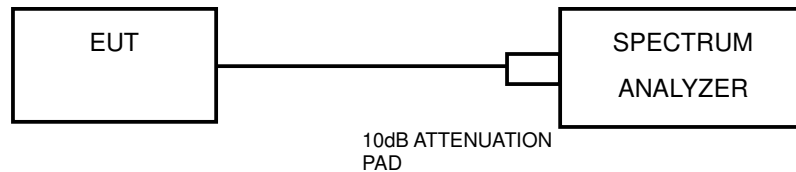

### 4.6.3 TEST INSTRUMENTS

Refer to section 4.3.2 to get information of above instrument.

### 4.6.4 TEST PROCEDURE

#### MEASUREMENT PROCEDURE REF

1. Set the RBW = 100 kHz.
2. Set the VBW  $\geq$  300 kHz.
3. Detector = peak.
4. Sweep time = auto couple.
5. Trace mode = max hold.
6. Allow trace to fully stabilize.
7. Use the peak marker function to determine the maximum power level in any 100 kHz band segment within the fundamental EBW.



Test Report No.: RF2305WDG0021-2

## MEASUREMENT PROCEDURE OOB

1. Set RBW = 100 kHz.
2. Set VBW  $\geq$  300 kHz.
3. Set span to encompass the spectrum to be examined
4. Detector = peak.
5. Trace Mode = max hold.
6. Sweep = auto couple.

### 4.6.5 DEVIATION FROM TEST STANDARD

No deviation.

### 4.6.6 EUT OPERATING CONDITION

The software provided by client to enable the EUT under transmission condition continuously at lowest, middle and highest channel frequencies individually.

### 4.6.7 TEST RESULTS

#### BT-LE (GFSK 1M)

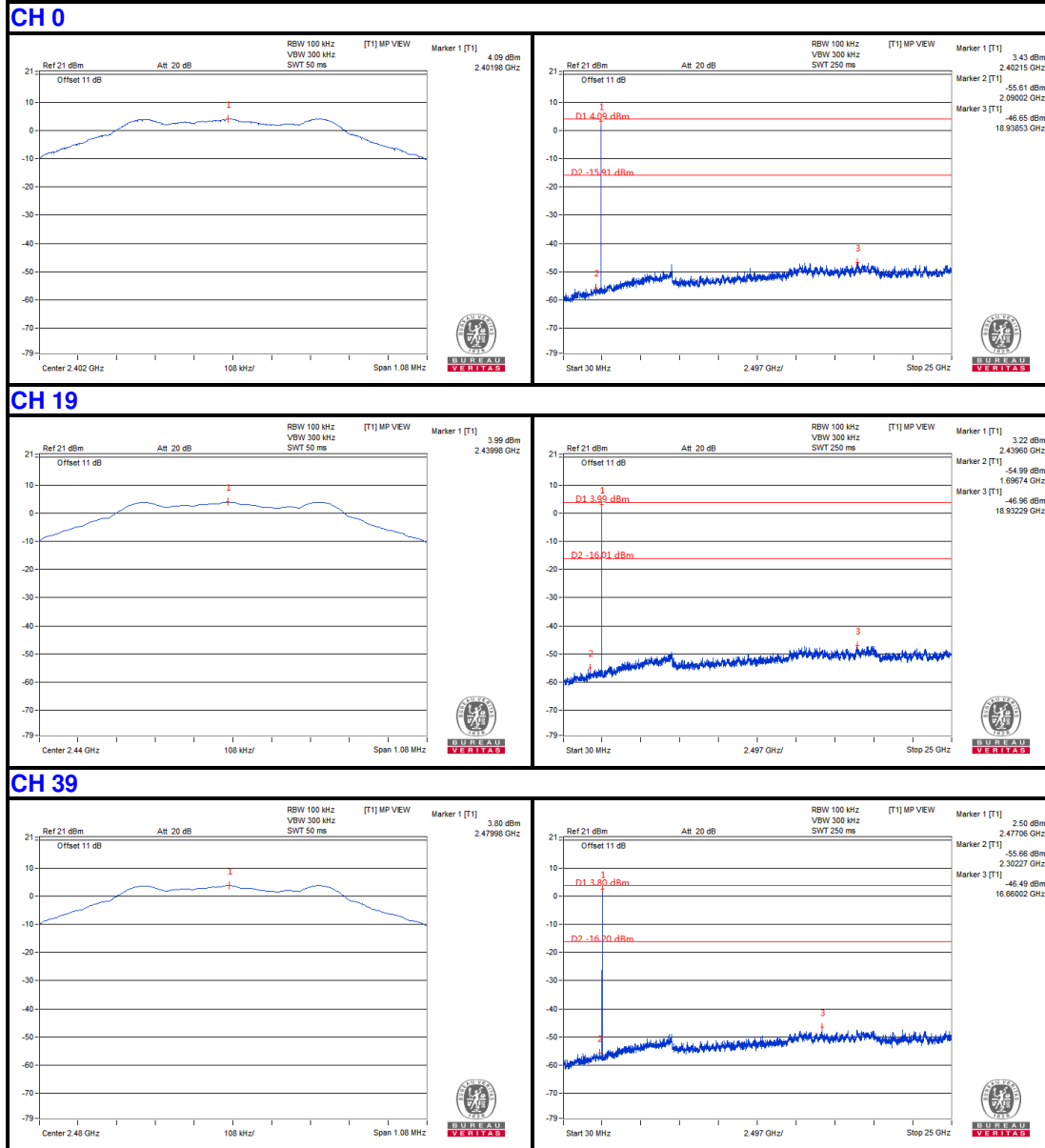

**BT-LE (GFSK 2M)**

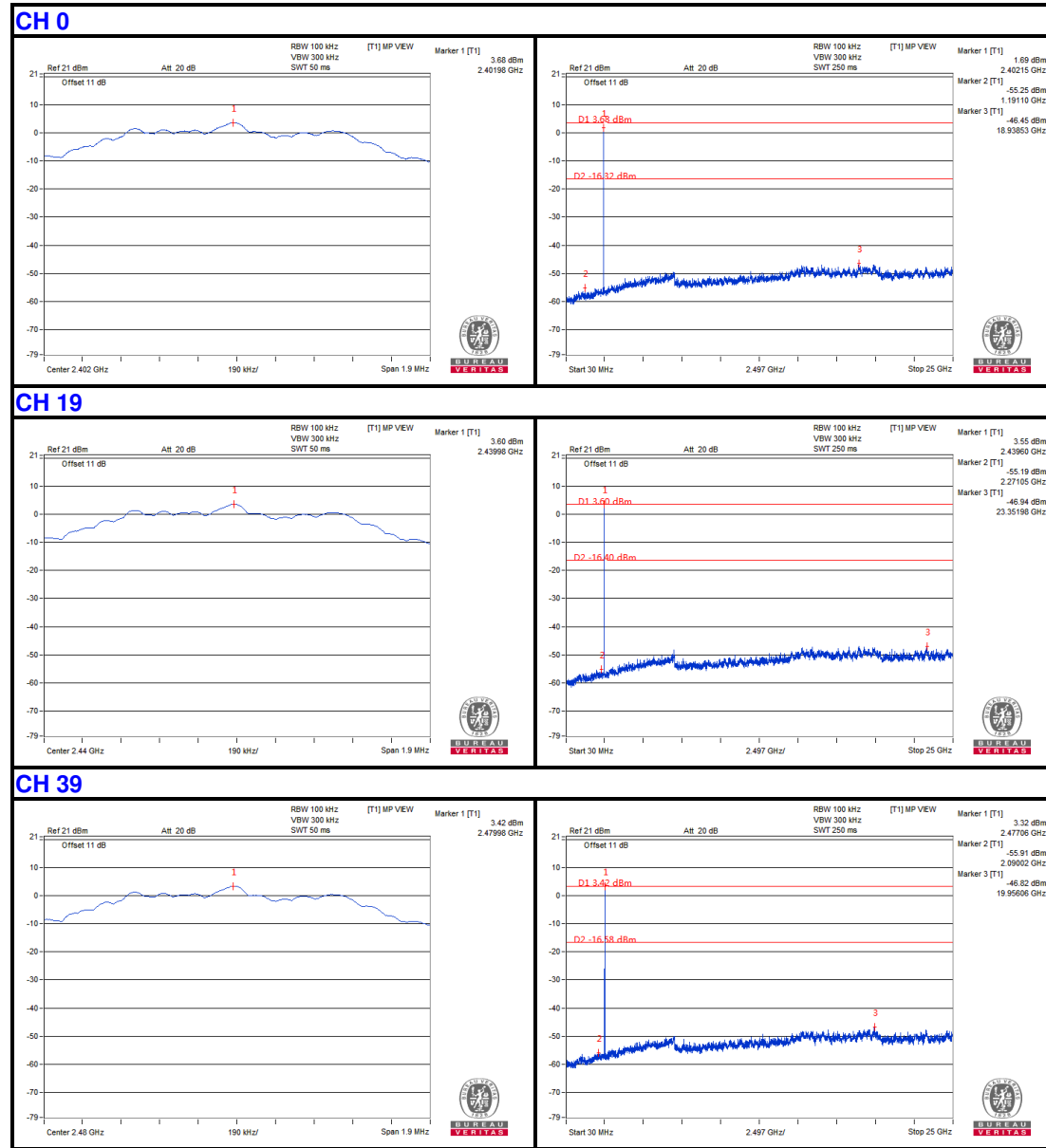



Band Edge: 1M

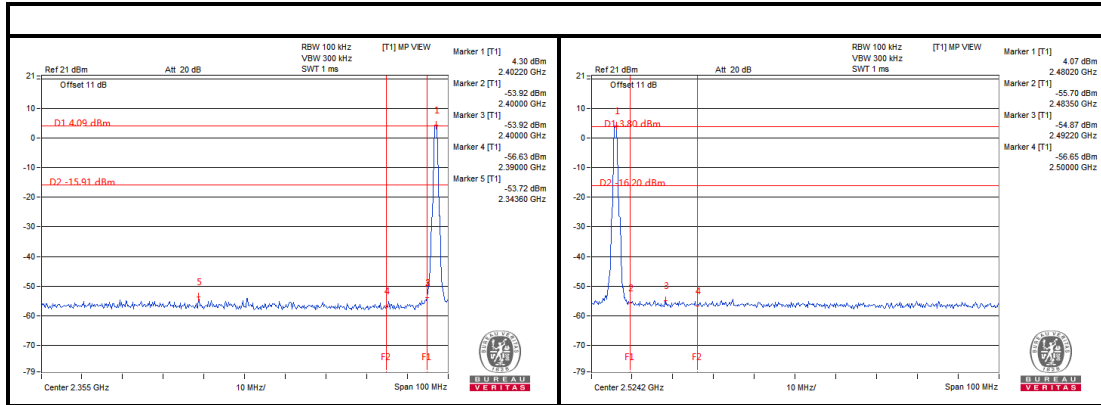

Band Edge: 2M

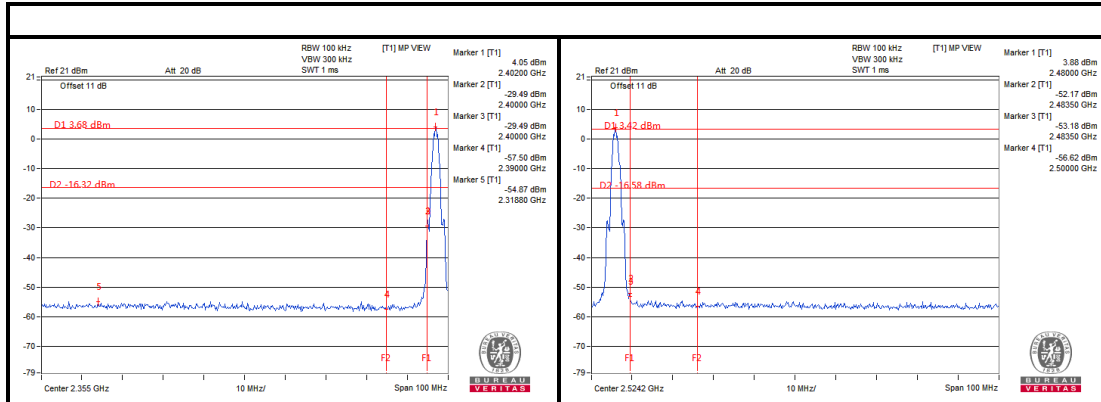



Test Report No.: RF2305WDG0021-2

## 5 PHOTOGRAPHS OF THE TEST CONFIGURATION

Please refer to the attached file (Test Setup Photo).



Test Report No.: RF2305WDG0021-2

## 6 APPENDIX A - MODIFICATIONS RECORDERS FOR ENGINEERING CHANGES TO THE EUT BY THE LAB

No any modifications are made to the EUT by the lab during the test.

---END---